

## SAFETY RELAYS Ter-A series

- ❖ The highest load is the PLe standard of EN-ISO13849-1 and the SiL3 standard of IEC 62061.
- ❖ Proven dual-channel safety monitoring circuit design.
- ❖ Multi-function configuration DIP switch, applicable to a variety of safety sensors
- ❖ Input and output LED instructions.
- ❖ Automatic/manual reset lever, quick configuration system.
- ❖ The width is 22.5mm, reducing installation space.
- ❖ Optional screw terminal or spring terminal, the application range is wider.
- ❖ PLC signal output.

### Suitable for monitoring.

- ◆ emergency button. ◆ Safety light curtain ◆ Safe touch
- ◆ Safety switch ◆ Security scanner ◆ Safety carpet
- ◆ Security door lock ◆ Safety sensor ◆ Two-hand switch

### Forced safety output

- ◆ 3NO / 1NC

### Applicable to industry

- ◆ Injection molding machine, CNC machine tool
- ◆ Press/hydraulic press, glass machinery, filling machinery, packaging machinery
- ◆ Sorting machinery, woodworking machinery, papermaking machinery
- ◆ Smart forklift, AGV, robot, elevator
- ◆ Wind power, SIS system, etc.

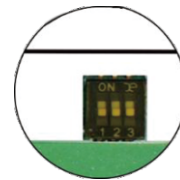

Multi-function dial switch



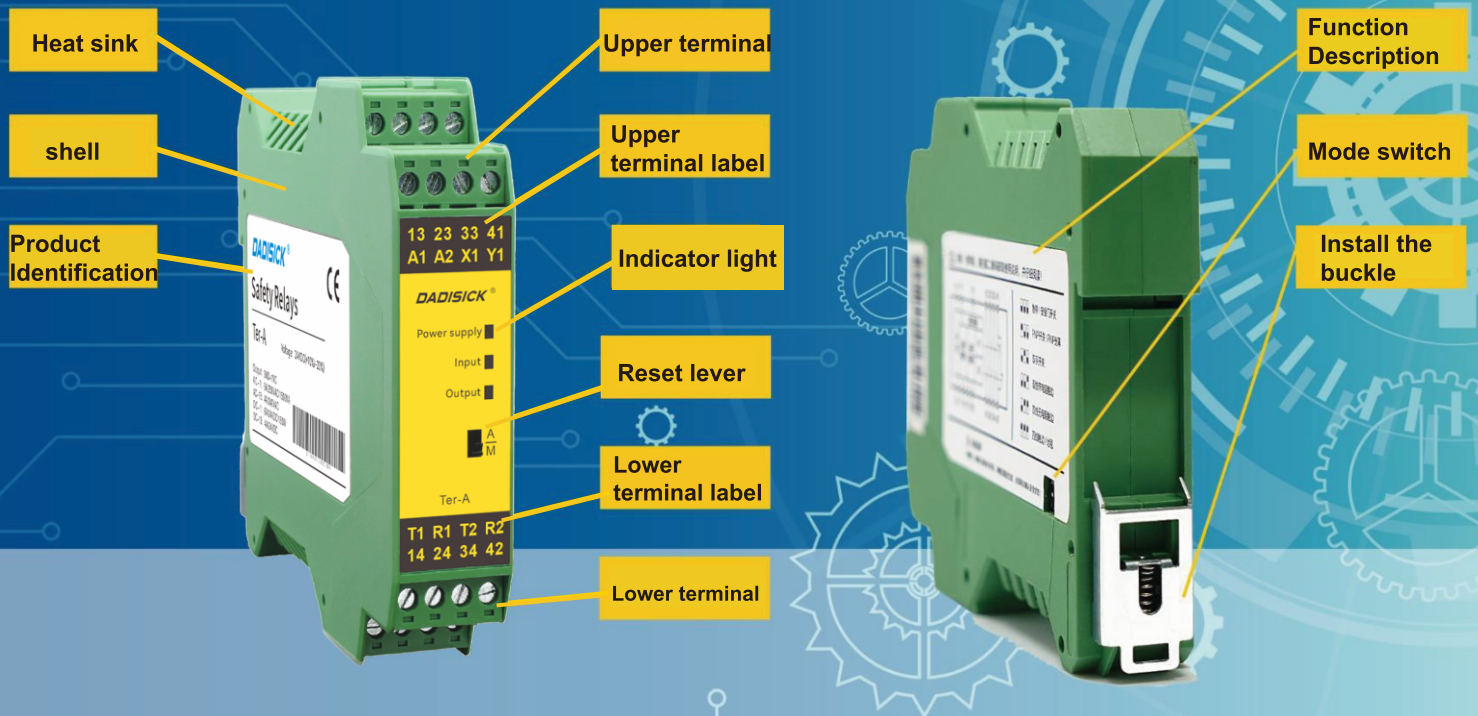

100%

Strictly select first-line brand components and 100% process testing.

3 party

The core compulsory relay adopts well-known products that have been certified by a third party to ensure reliability.

comprehensive

Full-featured DIP switches can be configured to easily control various applications.

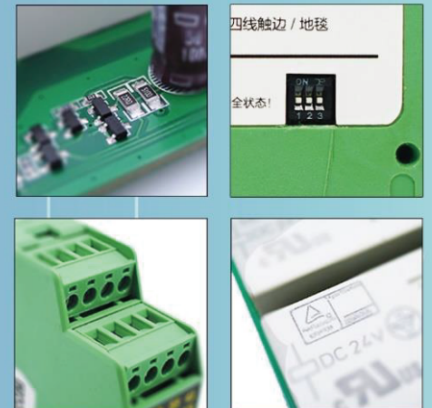

Speed

Using extremely fast mutual verification technology to ensure safe and efficient response time.

2 way

It adopts dual-channel electrostatic design, which fully meets the functional safety requirements of ISO 13849 and GB 16855.

40%

Save you 40% of the cost.



# Ter-A

- Safety forced-off relay output.
  - 3 normally open instantaneous safety contacts (3No)
  - 1 normally closed instantaneous safety contact (1Nc)
- LED indicator
  - Power indicator
  - Input status indication
  - Output status indication
- Automatic reset switch
  - Configurable automatic/manual reset switch
- Multi-function configuration dial switch
  - It can be configured for emergency stop, light curtain, door lock, edge contact, carpet, two-hand switch and other functions.
- Safety features
  - Redundant circuit with self-monitoring function
  - When the component fails, the safety function is still effective.
  - In each open-close cycle, it will automatically test whether the safety contacts are properly opened and closed.



- System module diagram

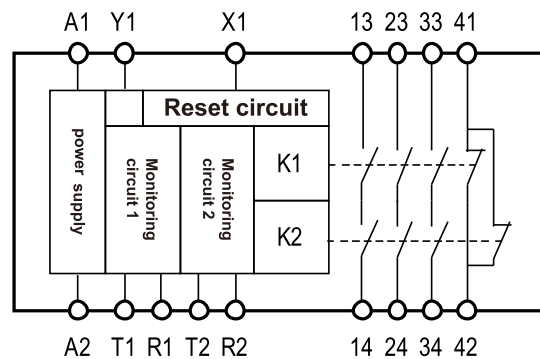

- Terminal function description

A1	Positive power supply (24VDC)	A1.A2 as power supply
A2	Power negative pole (0V)	
T1	Channel 1 signal output	With square wave type I signal source
R1	Channel 1 safety input	Receive type I signal input, with open circuit, short circuit detection and channel 1 mutual detection.
T2	Channel 2 signal output	With square wave type II signal source.
R2	Channel 2 safety input	Receive type II signal input, with open circuit, short circuit detection and channel 1 mutual detection.
X1	Reset input (manual reset or automatic reset can be configured)	Automatic reset: the input condition is met, the unit is activated immediately. Manual reset: the input conditions are met, and the reset circuit is then manually closed. After release, the unit is activated.
Y1	Transistor signal output.	Output status signal indication, PLC signal input or link to external indicator light last night.
13/14	Normally open momentary safety contacts	The unit can be connected to the external Tner-TS31 unit to increase the number of contacts.
23/24		
33/34		
41/42	Normally closed instantaneous safety contacts.	Can be used as an external signal lamp or control other devices.

## ➤ LED and reset lever operation instructions

### ◆ LED indicator status

■ Always on ★☆ Flashing □ Go out				
Features	status	Power LED	Input LED	Output LED
Emergency stop/door lock	Disconnection/abnormal connection	■	★☆	□
	Emergency stop press/door lock open	■	★☆	□
	Correct input/not reset	■	■	□
	Input is correct/reset	■	■	■
	system error	★☆	□	□
Light curtain/PNP switch	Disconnection/abnormal connection	■	★☆	□
	The light curtain is interrupted/switched	■	★☆	□
	Correct input/not reset	■	■	□
	Input is correct/reset	■	■	■
	system error	★☆	□	□
Two-hand switch (Only automatic reset is valid)	Disconnection/abnormal connection	■	★☆	□
	Two-hand switch press	■	■	■
	Two-hand switch release	■	★☆	□
	system error	★☆	□	□
2-wire edge/carpet with resistance	Disconnection/abnormal connection	■	★☆	□
	Edge/carpet is kept pressed	■	■	★☆
	Edge/carpet connection is correct/not reset	■	■	□
	Edge/carpet connection is correct/reset	■	■	■
	system error	★☆	□	□
Non-resistance 2-wire edge/carpet	Disconnect	Detection not supported		
	Abnormal connection	■	★☆	□
	Edge/carpet is kept pressed	■	■	★☆
	Edge/carpet connection is correct/not reset	■	★☆	□
	Edge/carpet connection is correct/reset	■	■	■
	system error	★☆	□	□
4-wire edge/carpet	Disconnection/abnormal connection	■	★☆	□
	Edge/carpet is kept pressed	■	★☆	□
	Edge/carpet connection is correct/not reset	■	■	□
	Edge/carpet connection is correct/reset	■	■	■
	system error	★☆	□	□

### ◆ Reset lever operation

Reset lever	status	Description
	A	Can be configured as an automatic reset function (X1 must be shorted to the positive pole of the power supply)
M	Can only be configured as a manual reset function (X1 is connected to the positive power supply through the reset button, refer to the connection diagram)	

➤ Mode switch operation instructions

Features	Dialing status	Features	Dialing status
Emergency stop/door lock		2-wire edge/carpet with resistance	
Light curtain/PNP switch		Non-resistance 2-wire edge/carpet	
Two-hand switch		4-wire edge/carpet	

➤ Connection example

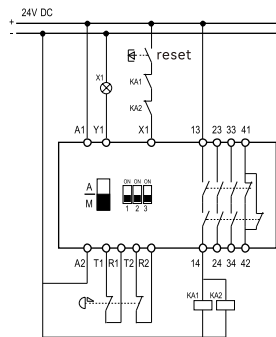

1. Dual-channel emergency stop safety input with manual reset

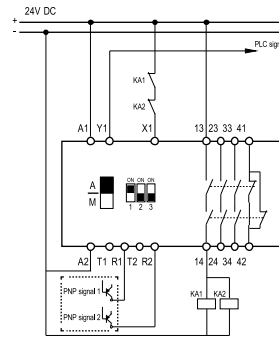

2. Dual-channel light curtain / PNP switch safety input with manual reset

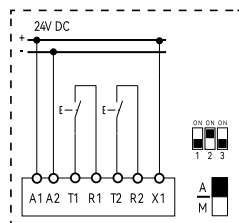

3. Two-hand switch safety input, automatic reset, dualchannel time difference 0.5s

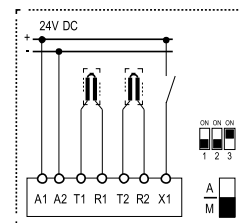

4. Dual-channel 2-wire edge/mat (with resistance) safety input, with manual reset

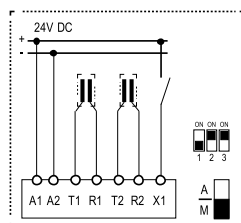

5. Dual-channel 2-wire edge/mat (no resistance) safety input, with manual reset

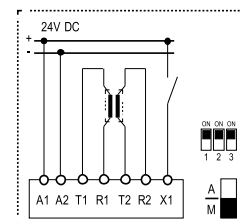

6. Dual-channel 4-wire edge/mat safety input with manual reset

➤ Technical parameter.

power supply	
Power supply	24V DC
Voltage tolerance	+10%/−20%
Power consumption	1.5W
Output	

Relay safety output	3NO+1NC
Transistor signal output	<500mA 24VDC
<b>Relay contact capacity</b>	
AC-1	6A/250VAC/1500VA
AC-15	4A/240VAC
DC-1	6A/24VDC/150W
DC-13	4A/24VDC
Maximum switching capacity	12A (distributed on all safety output contacts)
Contact resistance	<100mΩ
Minimum load	10mA/5V
Contact material	AgSnO <sub>2</sub> + 0.2μmAu
<b>General parameters</b>	
Output fuse (external)	5A gL/gG
Maximum input cable resistance	200Ω
Release response time	<30ms From input to output),
Electrical life	80000 Times
Pollution level	2
Operating temperature	-25°C-85°C
Working humidity	35%-85% No icing or condensation
Impulse withstand voltage	2.5kV
Protection level	Shell IP30, terminal IP20, it is recommended to install in the cabinet or subject IP54
Storage temperature	-40°C-105°C
shell material	Flame retardant PA66
Installation method	Standard 35mmDIN rail/spring buckle
size	114.5mm×100.5mm×22.5mm
weight	172g
<b>Connection parameters</b>	
Rigid conductor available cross section range	0.5~2.5mm <sup>2</sup>
Available cross-section range of flexible conductor	0.5~2.5mm <sup>2</sup>
Minimum conductor cross section	AWG 24
Maximum wire cross section	AWG 12
Wave line length	8mm
Minimum tightening torque	0.5 Nm
Tightening torque	0.6 Nm
<b>Standard application</b>	
meets the	EN 60947-1:2007/A2:2014
	EN 60947-5-1:2004/A1:2009
	EN ISO 13849-1:2015
	EN 62061:2005+A2:2015

➤ Dimensions

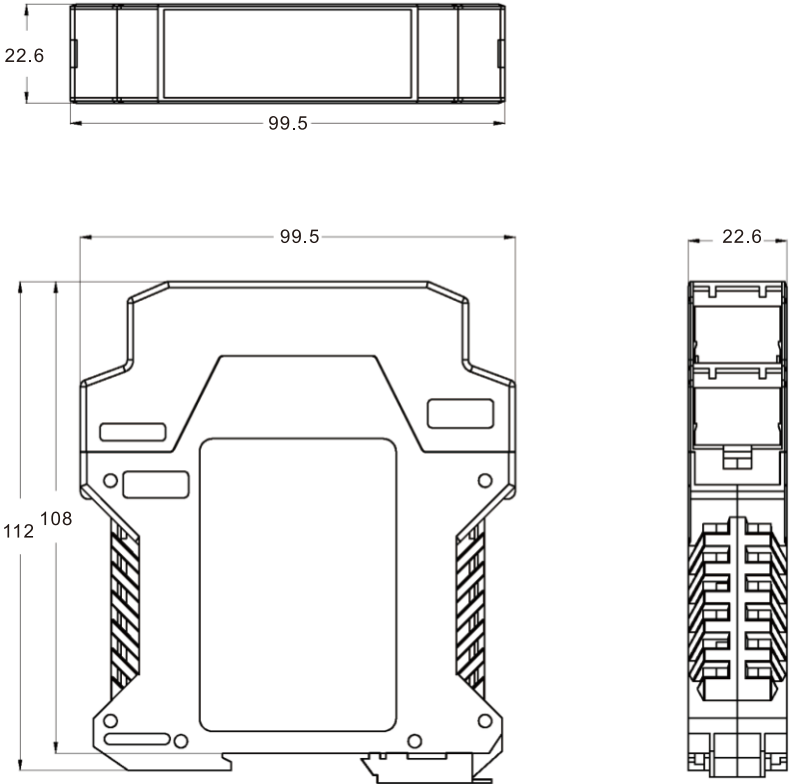

➤ Ordering Information

model	Item No.	Quantity	Voltage	Output
Tner-A31	01011759001	1	24V DC	3NO/1NC