

# TECHNICAL DATA SHEET

## SAFETY INTERLOCK SWITCHES DEVICE OX-W2 series



### Contents

- Product features
- Technical data
- Electrical wiring
- Accessories
- Installation diagram
- Back unlocking
- Safety door bolt



## Product Features

- The safety door switch with locking function can ensure that the safety protection device door and other protective covers remain in a safe state even if the dangerous state is not eliminated.

## OX-W2 series

Metal head

4 sets of gold plated contacts

14 contact combinations

Locking force 1300N

Indicator light+emergency unlocking

Optional back unlocking function

Adapted to 11 types of operation keys



### Suitable for monitoring safety doors and windows

High strength wear-resistant engineering plastic with built-in 304 stainless steel components

Forced mechanical interlocking self detection structure with extremely high reliability

### Product application

Used for monitoring places such as safety doors and windows, in accordance with EN ISO 14119 and GB/T 18831-2002.

- Automated production line
- Robot production line
- Hazard testing area
- Isolation places, etc



## Technical data

Electrical parameters		
Rated voltage	24VDC	
Rated current	1mA	
Light source color	green	
Rated working voltage	DC24V±10%	
Rated current	200mA (initial value)	
Rated power	4.8W	
Rated insulation voltage ( U <sub>i</sub> )	300V	
Rated impulse withstand voltage (U <sub>imp</sub> )	2.5kV	
Rated open thermal current (I <sub>th</sub> )	10A	
Rated limited short-circuit current	1000A	
Use category	AC-15	DC-13
Rated working voltage (U <sub>e</sub> )	240V	30V
Rated operating current (I <sub>e</sub> )	3A	2.3A

Mechanical parameters	
Dimensions (w*h*l)	39*39.4*183mm
Insulation class	Class B (130°C)
Shell material	PA66 flame retardant
Contact material	Gold Plated Silver Alloy
Protection level	IP67 (EN60947-5-1, except key operation hole)
Service life	Mechanical more than 1 million times
	Electric appliances more than 150,000 times
Tensile strength when locked	1300N
Forced disengagement force	≥80N
Forced breakaway distance	≥10mm
Allowable operating speed	0.05-0.5m/s
Allowable operating frequency	Up to 20 operations/min

Environmental data	
Ambient temperature	-20 °C~60 °C, without freezing
Environment humidity	Below 85% RH

## Electrical wiring

### 1.Function and purpose

The use of safety door locks to monitor the status of safety doors can ensure reliable shutdown of equipment.

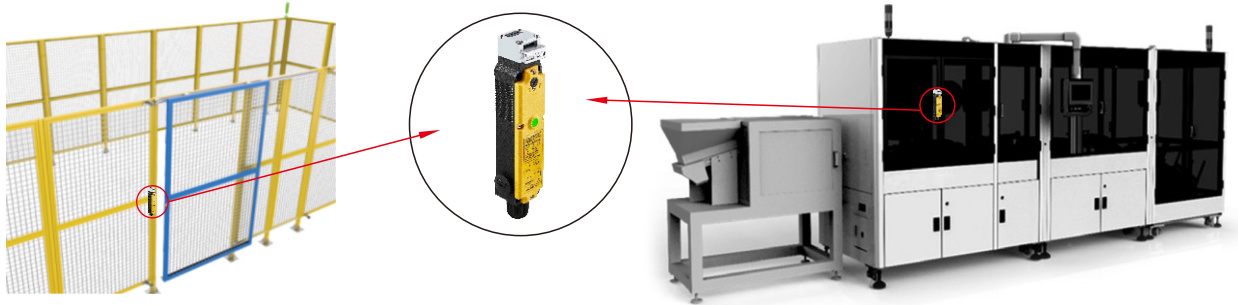

### 2.Connection example

The safety door lock can be connected to the safety relay to form a high-level safety circuit. Used to control reliable stopping and starting of equipment.



### Model Selection

OX-W2 CO / CO - G C J

J: Metal head; S: Plastic head

C: Mechanical locking and electromagnetic unlocking;  
D: Electromagnetic locking, power outage unlocking

G: M20











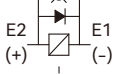
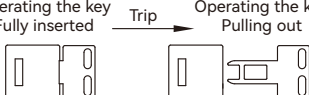
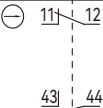
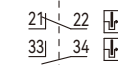
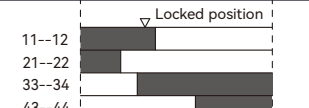
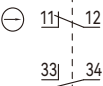
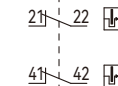
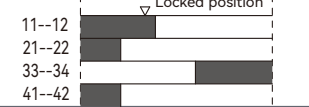
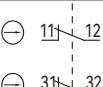
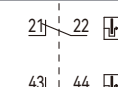

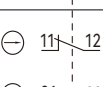
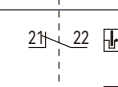
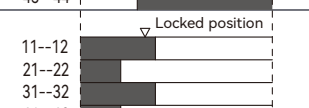
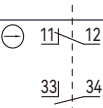

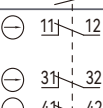
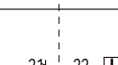
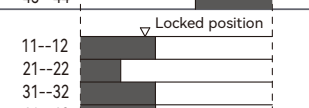
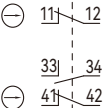

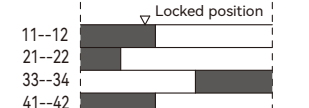
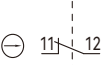
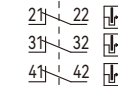
X: Comes with a connecting cable (default cable is 1.5m,  
other lengths can be customized by contacting customer service)

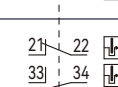
Lock status monitoring output: CO: (1NC+1NO); 2C: (2NC) (default 1 is empty)

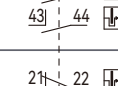

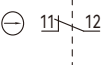
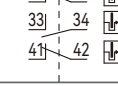
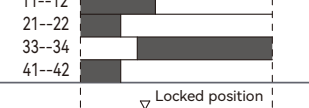
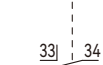
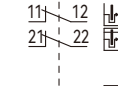
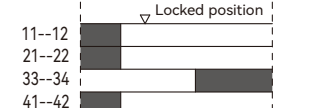
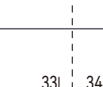
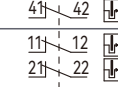
Insert key monitoring output: CO: (1NC+1NO); 2C: (2NC) (default 1 is empty)

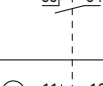
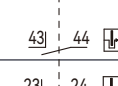
Product model: OX-W2

● The following wiring diagram shows inserting the operation key and being in the lock state

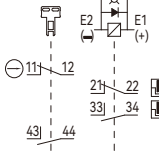
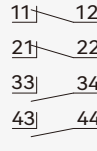
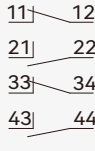
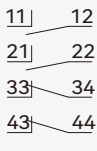
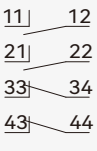

Model	Contact type		Wiring diagram		Contact action	
	Door monitoring+Lock monitoring		Door monitoring	Lock monitoring	■ : ON	□ : OFF
						
<b>OX-W2-CO/CO-GD-J</b> <b>OX-W2-CO/CO-GC-J</b>	1NC+1NO	1NC+1NO				
<b>OX-W2-CO/2C-GD-J</b> <b>OX-W2-CO/2C-GC-J</b>	1NC+1NO	2NC				
<b>OX-W2-2C/CO-GD-J</b> <b>OX-W2-2C/CO-GC-J</b>	2NC	1NC+1NO				
<b>OX-W2-2C/2C-GD-J</b> <b>OX-W2-2C/2C-GC-J</b>	2NC	2NC				
<b>OX-W2-C/2OC-GD-J</b> <b>OX-W2-C2O/C-GC-J</b>	1NC+2NO	1NC				
<b>OX-W2-3C/C-GD-J</b> <b>OX-W2-3C/C-GC-J</b>	3NC	1NC				
<b>OX-W2-2C/OC-GD-J</b> <b>OX-W2-2CO/C-GC-J</b>	2NC+1NO	1NC				
<b>OX-W2-C/3C-GD-J</b> <b>OX-W2-C/3C-GC-J</b>	1NC	3NC				
<b>OX-W2-C/C2O-GD-J</b> <b>OX-W2-C/C2O-GC-J</b>	1NC	1NC+2NO				
<b>OX-W2-C/2CO-GD-J</b> <b>OX-W2-C/2CO-GC-J</b>	1NC	2NC+1NO				
<b>OX-W2-O/3C-GD-J</b> <b>OX-W2-O/3C-GC-J</b>	1NO	3NC				
<b>OX-W2-O/2CO-GD-J</b> <b>OX-W2-O/2CO-GC-J</b>	1NO	2NC+1NO				
<b>OX-W2-2C/2O-GD-J</b> <b>OX-W2-2C/2O-GC-J</b>	2NC	2NO				
<b>OX-W2-2O/2C-GD-J</b> <b>OX-W2-2O/2C-GC-J</b>	2NO	2NC				

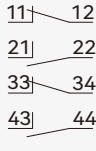
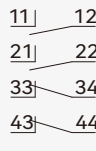
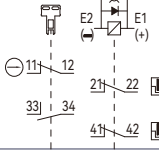
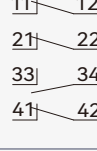
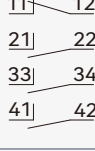
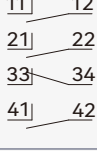
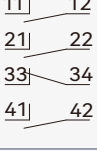
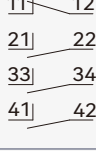
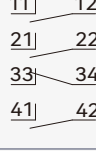
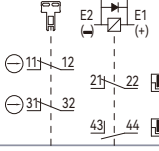
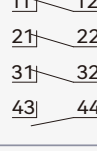
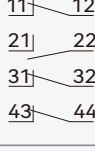
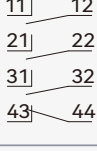
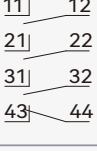
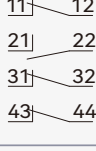
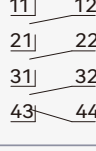
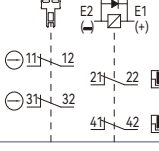
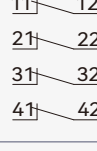
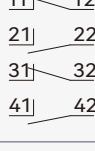
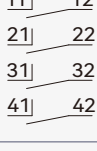
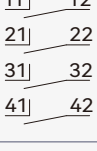
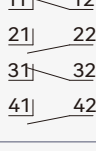
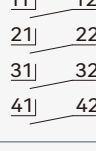
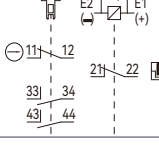
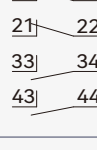
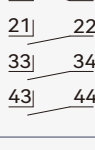
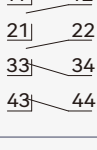
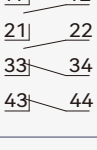
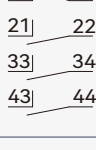
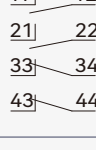
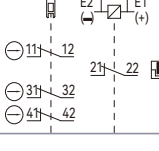
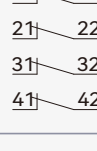
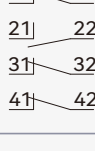
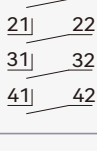
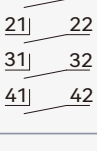
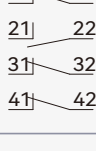
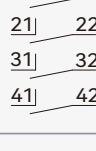
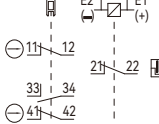
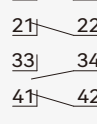
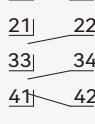
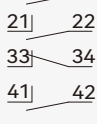
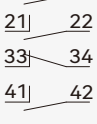
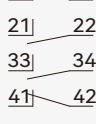
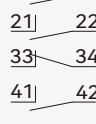
## ● Electromagnetic locking type

Safety door action status	State 1	State 2	State 3	State 4	When manually unlocking	
	OFF	OFF	ON	ON	OFF	ON
<b>OX-W2-CO/CO-GD-J</b> 	CIRCUIT DIAGRAM 	CIRCUIT DIAGRAM 	CIRCUIT DIAGRAM 	CIRCUIT DIAGRAM 	 or  CIRCUIT DIAGRAM 	CIRCUIT DIAGRAM 
<b>OX-W2-CO/2C-GD-J</b> 	CIRCUIT DIAGRAM 	CIRCUIT DIAGRAM 	CIRCUIT DIAGRAM 	CIRCUIT DIAGRAM 	CIRCUIT DIAGRAM 	CIRCUIT DIAGRAM 
<b>OX-W2-2C/CO-GD-J</b> 	CIRCUIT DIAGRAM 	CIRCUIT DIAGRAM 	CIRCUIT DIAGRAM 	CIRCUIT DIAGRAM 	CIRCUIT DIAGRAM 	CIRCUIT DIAGRAM 
<b>OX-W2-2C/2C-GD-J</b> 	CIRCUIT DIAGRAM 	CIRCUIT DIAGRAM 	CIRCUIT DIAGRAM 	CIRCUIT DIAGRAM 	CIRCUIT DIAGRAM 	CIRCUIT DIAGRAM 
<b>OX-W2-C/20C-GD-J</b> 	CIRCUIT DIAGRAM 	CIRCUIT DIAGRAM 	CIRCUIT DIAGRAM 	CIRCUIT DIAGRAM 	CIRCUIT DIAGRAM 	CIRCUIT DIAGRAM 
<b>OX-W2-3C/C-GD-J</b> 	CIRCUIT DIAGRAM 	CIRCUIT DIAGRAM 	CIRCUIT DIAGRAM 	CIRCUIT DIAGRAM 	CIRCUIT DIAGRAM 	CIRCUIT DIAGRAM 
<b>OX-W2-2C/OC-GD-J</b> 	CIRCUIT DIAGRAM 	CIRCUIT DIAGRAM 	CIRCUIT DIAGRAM 	CIRCUIT DIAGRAM 	CIRCUIT DIAGRAM 	CIRCUIT DIAGRAM 

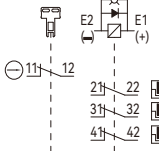
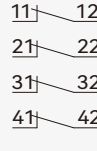
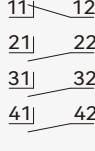
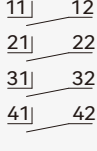
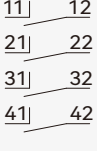

Note: After manual unlocking, the safety door is open, and do not apply voltage to the electromagnet for a long time.

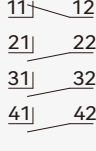
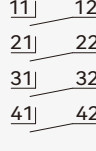
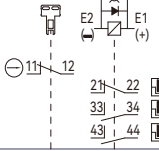
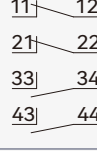
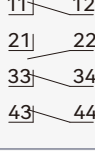
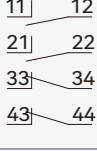
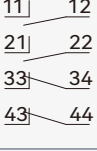
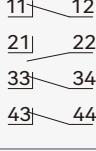
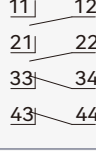
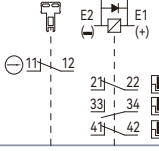
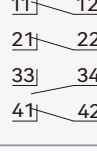
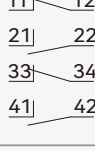
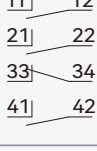
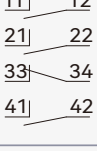
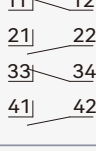
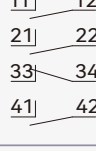
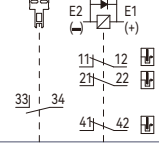
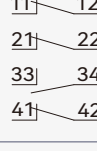
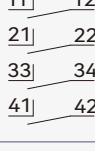
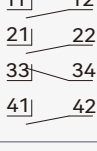
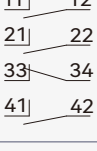
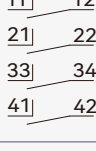
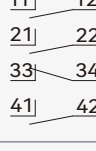
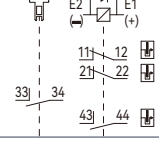
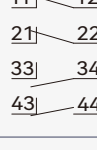
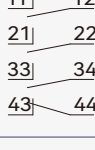
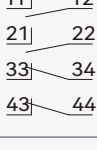
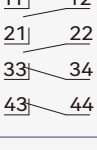
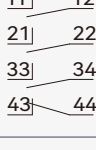
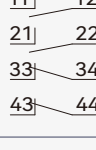
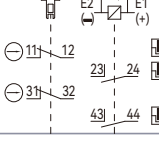
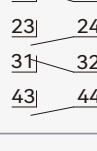
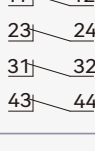
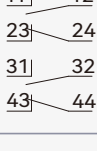
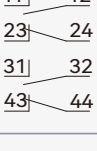
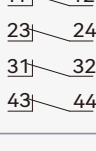
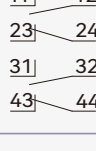
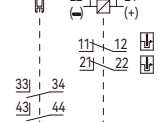
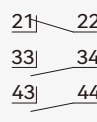
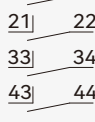
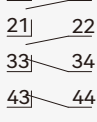
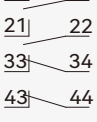
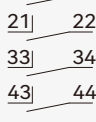
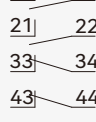
## ● Electromagnetic locking type

Safety door action status	State 1	State 2	State 3	State 4	When manually unlocking	
	OFF	OFF	ON	ON	OFF	ON
<b>OX-W2-C/3C-GD-J</b> 	CIRCUIT DIAGRAM 	CIRCUIT DIAGRAM 	CIRCUIT DIAGRAM 	CIRCUIT DIAGRAM 	 or  CIRCUIT DIAGRAM 	CIRCUIT DIAGRAM 
<b>OX-W2-C/C20-GD-J</b> 	CIRCUIT DIAGRAM 	CIRCUIT DIAGRAM 	CIRCUIT DIAGRAM 	CIRCUIT DIAGRAM 	CIRCUIT DIAGRAM 	CIRCUIT DIAGRAM 
<b>OX-W2-C/2CO-GD-J</b> 	CIRCUIT DIAGRAM 	CIRCUIT DIAGRAM 	CIRCUIT DIAGRAM 	CIRCUIT DIAGRAM 	CIRCUIT DIAGRAM 	CIRCUIT DIAGRAM 
<b>OX-W2-O/3C-GD-J</b> 	CIRCUIT DIAGRAM 	CIRCUIT DIAGRAM 	CIRCUIT DIAGRAM 	CIRCUIT DIAGRAM 	CIRCUIT DIAGRAM 	CIRCUIT DIAGRAM 
<b>OX-W2-O/2CO-GD-J</b> 	CIRCUIT DIAGRAM 	CIRCUIT DIAGRAM 	CIRCUIT DIAGRAM 	CIRCUIT DIAGRAM 	CIRCUIT DIAGRAM 	CIRCUIT DIAGRAM 
<b>OX-W2-2C/20-GD-J</b> 	CIRCUIT DIAGRAM 	CIRCUIT DIAGRAM 	CIRCUIT DIAGRAM 	CIRCUIT DIAGRAM 	CIRCUIT DIAGRAM 	CIRCUIT DIAGRAM 
<b>OX-W2-20/2C-GD-J</b> 	CIRCUIT DIAGRAM 	CIRCUIT DIAGRAM 	CIRCUIT DIAGRAM 	CIRCUIT DIAGRAM 	CIRCUIT DIAGRAM 	CIRCUIT DIAGRAM 

Note: After manual unlocking, the safety door is open, and do not apply voltage to the electromagnet for a long time.

## ● Mechanical locking type

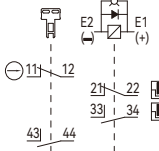
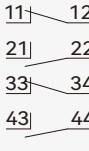
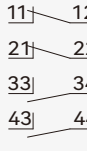
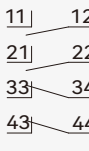
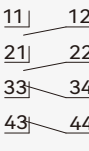
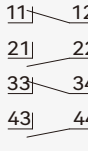
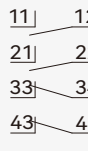
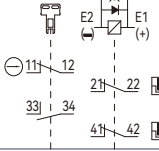
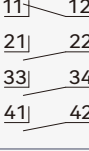
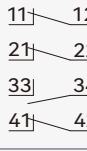
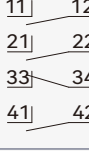
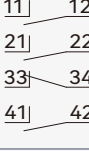
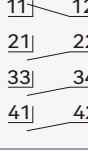
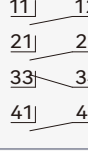
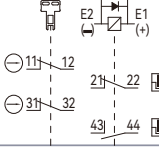
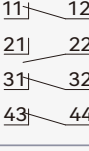
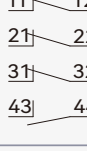
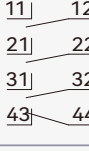
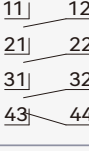
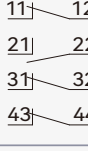
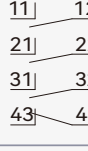
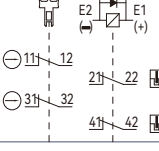
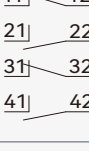
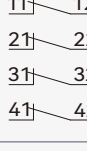
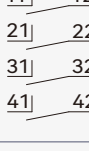
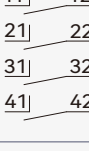
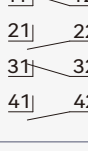
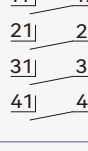
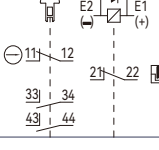
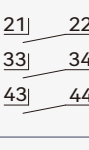
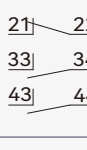
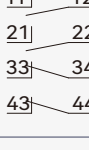
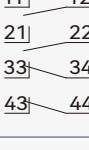
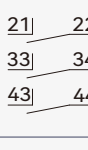
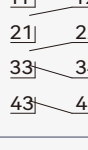
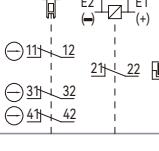
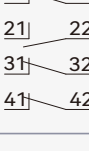
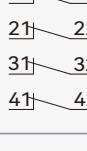
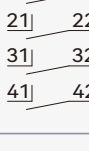
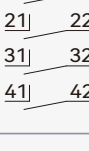
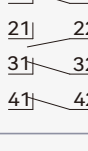
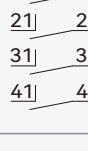
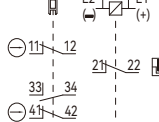
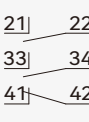
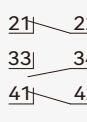
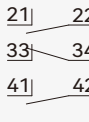
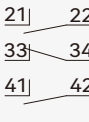
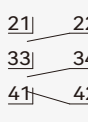
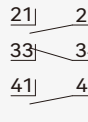
Safety door action status	State 1	State 2	State 3	State 4	When manually unlocking	
	OFF	OFF	ON	ON	OFF	ON
<b>Electromagnet power supply</b>	ON	OFF	ON	OFF	 or 	
<b>OX-W2-CO/CO-GC-J</b> 	CIRCUIT DIAGRAM 	CIRCUIT DIAGRAM 	CIRCUIT DIAGRAM 	CIRCUIT DIAGRAM 	CIRCUIT DIAGRAM 	CIRCUIT DIAGRAM 
<b>OX-W2-CO/2C-GC-J</b> 	CIRCUIT DIAGRAM 	CIRCUIT DIAGRAM 	CIRCUIT DIAGRAM 	CIRCUIT DIAGRAM 	CIRCUIT DIAGRAM 	CIRCUIT DIAGRAM 
<b>OX-W2-2C/CO-GC-J</b> 	CIRCUIT DIAGRAM 	CIRCUIT DIAGRAM 	CIRCUIT DIAGRAM 	CIRCUIT DIAGRAM 	CIRCUIT DIAGRAM 	CIRCUIT DIAGRAM 
<b>OX-W2-2C/2C-GC-J</b> 	CIRCUIT DIAGRAM 	CIRCUIT DIAGRAM 	CIRCUIT DIAGRAM 	CIRCUIT DIAGRAM 	CIRCUIT DIAGRAM 	CIRCUIT DIAGRAM 
<b>OX-W2-C2O/C-GC-J</b> 	CIRCUIT DIAGRAM 	CIRCUIT DIAGRAM 	CIRCUIT DIAGRAM 	CIRCUIT DIAGRAM 	CIRCUIT DIAGRAM 	CIRCUIT DIAGRAM 
<b>OX-W2-3C/C-GC-J</b> 	CIRCUIT DIAGRAM 	CIRCUIT DIAGRAM 	CIRCUIT DIAGRAM 	CIRCUIT DIAGRAM 	CIRCUIT DIAGRAM 	CIRCUIT DIAGRAM 
<b>OX-W2-2CO/C-GC-J</b> 	CIRCUIT DIAGRAM 	CIRCUIT DIAGRAM 	CIRCUIT DIAGRAM 	CIRCUIT DIAGRAM 	CIRCUIT DIAGRAM 	CIRCUIT DIAGRAM 

Note: In case of emergency situations such as power outage and door action status before wiring and power on, the lock of the operating key can be manually released.



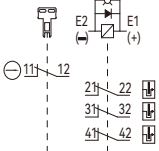
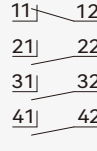
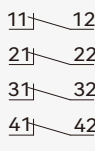
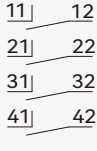
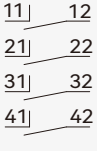
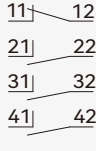
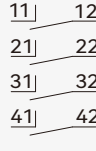
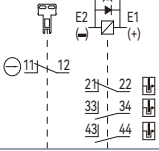
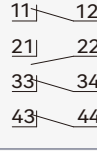
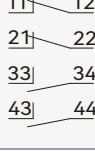
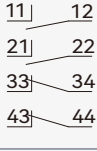
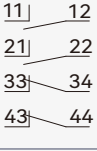
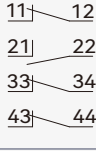
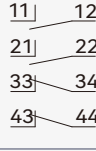
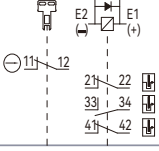
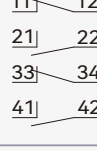
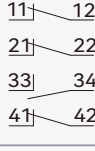
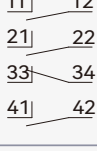
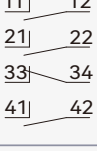
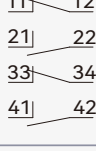
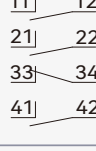
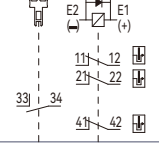
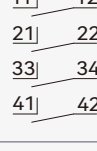
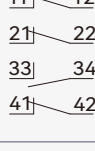
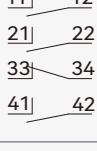
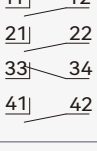
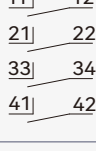
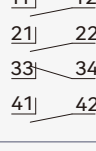
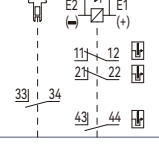
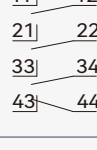
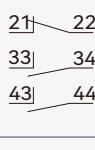
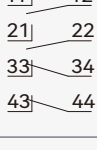
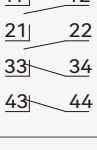
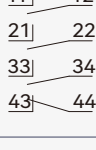
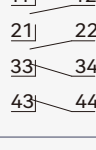
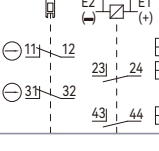
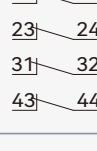
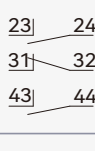
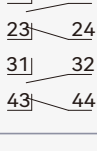
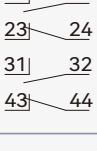
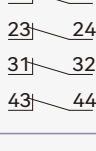
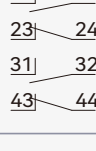
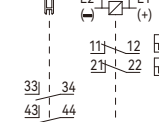
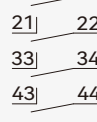
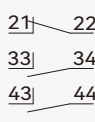
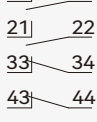
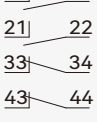
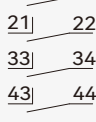
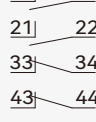

## ● Mechanical locking type

Safety door action status	State 1	State 2	State 3	State 4	When manually unlocking	
	OFF	OFF	ON	ON	OFF	ON
<b>OX-W2-C/3C-GC-J</b> 	CIRCUIT DIAGRAM 	CIRCUIT DIAGRAM 	CIRCUIT DIAGRAM 	CIRCUIT DIAGRAM 	CIRCUIT DIAGRAM 	CIRCUIT DIAGRAM 
<b>OX-W2-C/C20-GC-J</b> 	CIRCUIT DIAGRAM 	CIRCUIT DIAGRAM 	CIRCUIT DIAGRAM 	CIRCUIT DIAGRAM 	CIRCUIT DIAGRAM 	CIRCUIT DIAGRAM 
<b>OX-W2-C/2CO-GC-J</b> 	CIRCUIT DIAGRAM 	CIRCUIT DIAGRAM 	CIRCUIT DIAGRAM 	CIRCUIT DIAGRAM 	CIRCUIT DIAGRAM 	CIRCUIT DIAGRAM 
<b>OX-W2-O/3C-GC-J</b> 	CIRCUIT DIAGRAM 	CIRCUIT DIAGRAM 	CIRCUIT DIAGRAM 	CIRCUIT DIAGRAM 	CIRCUIT DIAGRAM 	CIRCUIT DIAGRAM 
<b>OX-W2-O/2CO-GC-J</b> 	CIRCUIT DIAGRAM 	CIRCUIT DIAGRAM 	CIRCUIT DIAGRAM 	CIRCUIT DIAGRAM 	CIRCUIT DIAGRAM 	CIRCUIT DIAGRAM 
<b>OX-W2-2C/2O-GC-J</b> 	CIRCUIT DIAGRAM 	CIRCUIT DIAGRAM 	CIRCUIT DIAGRAM 	CIRCUIT DIAGRAM 	CIRCUIT DIAGRAM 	CIRCUIT DIAGRAM 
<b>OX-W2-2O/2C-GC-J</b> 	CIRCUIT DIAGRAM 	CIRCUIT DIAGRAM 	CIRCUIT DIAGRAM 	CIRCUIT DIAGRAM 	CIRCUIT DIAGRAM 	CIRCUIT DIAGRAM 

Note: In case of emergency situations such as power outage and door action status before wiring and power on, the lock of the operating key can be manually released.

## ● Selection of safety locking device connected to safety relay

Name	Order separately	Model	Descriptions
Safety relay		LS-A	LS-A safety relays have three groups of NO and one group of NC, with strong control capabilities. They are suitable for various signal monitoring in industrial places with high safety requirements, including emergency stop signals, safety door opening and closing signals, safety light curtain signals, and two-handed button signals.
Safety relay	 Multifunctional switching switch	Ter-A	Equipped with a mode switch, it can be used for most safety components, such as light curtains, safety switches, carpet contacts, two handed switches, etc. Automatic/manual reset paddles for quick configuration. Dual channel monitoring circuit, safe and reliable.

### 1. An example of the wiring diagram between the safety interlock switch and LS-A is as follows:

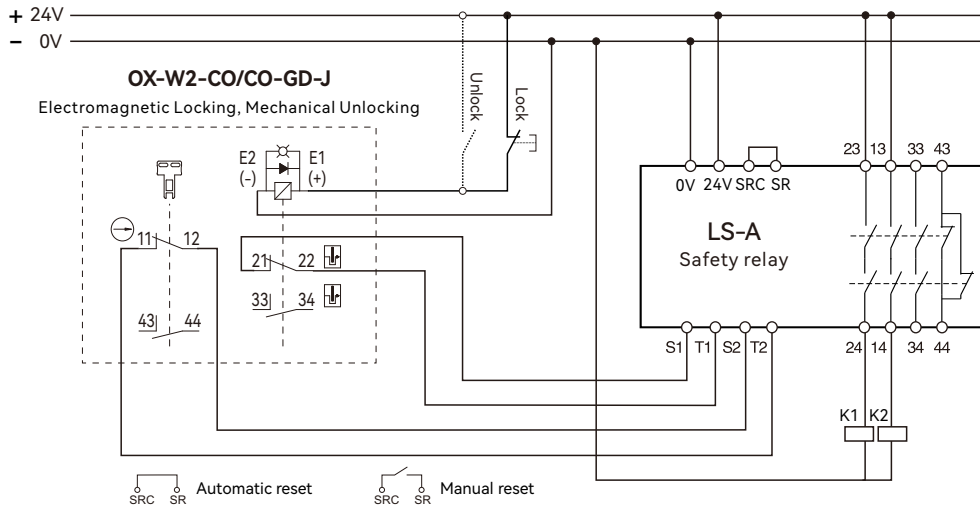

### 2. An example of the wiring diagram between the safety interlock switch and Ter-A is as follows:

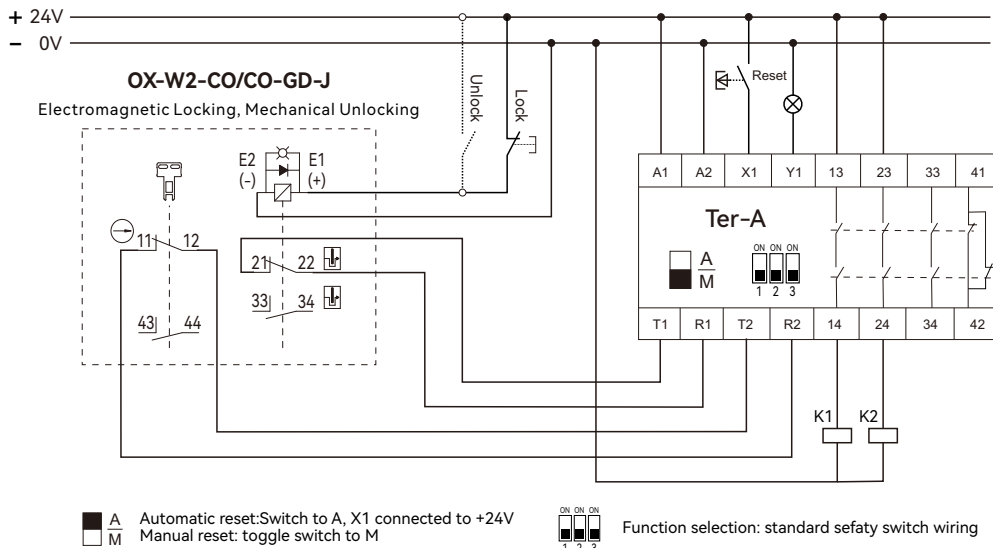



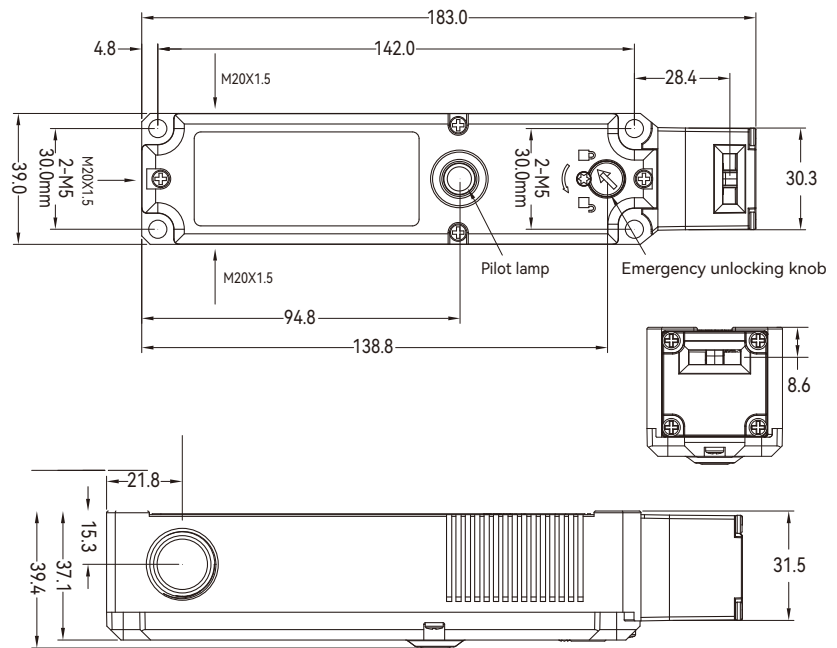

## ● Overall dimensions





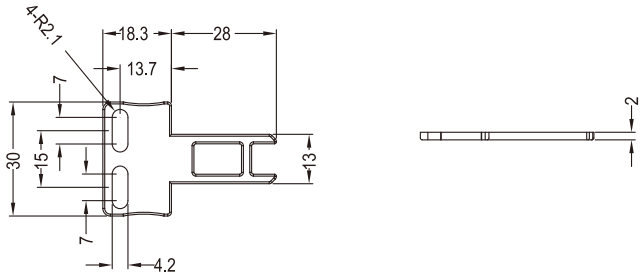
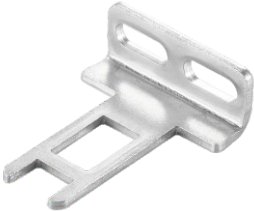
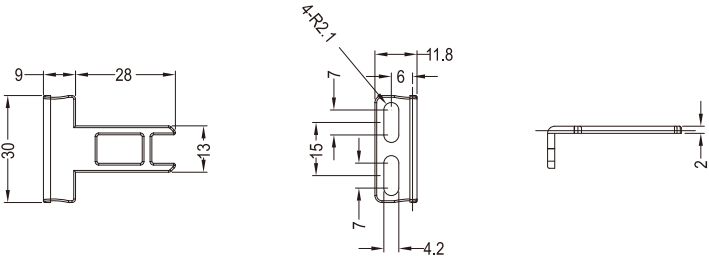

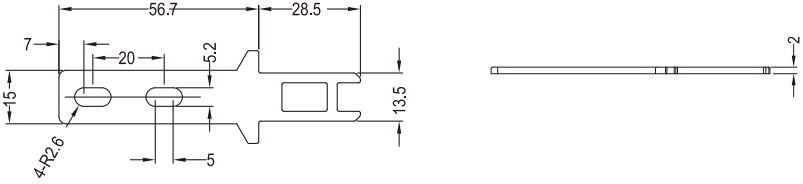
### OX-W2 Series Lock Body Dimensional Drawing

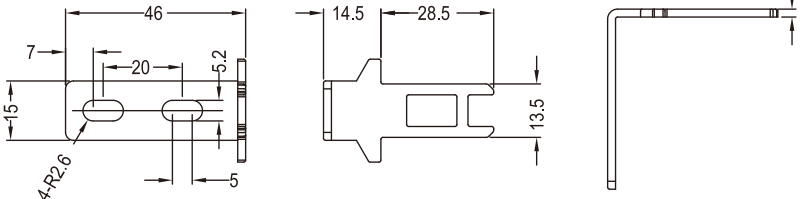

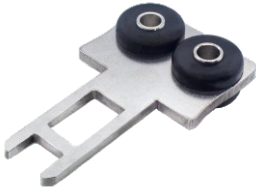
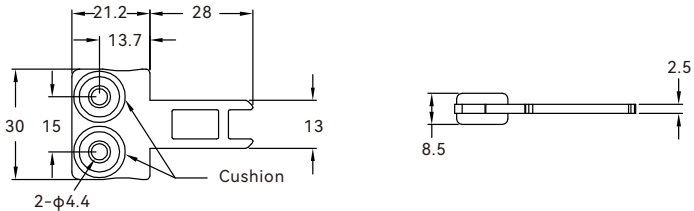

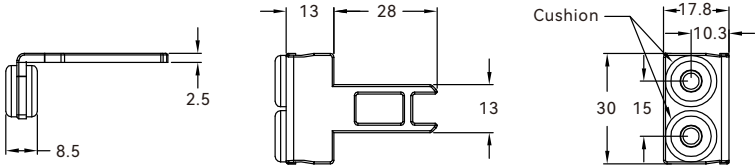
Unit: mm

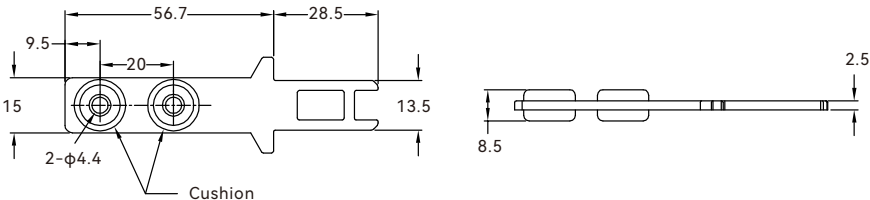
## Accessories

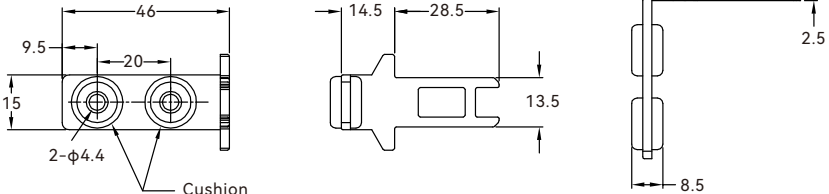
T-shaped operation key	OX-K1 operating key size diagram
 <p>(Optional accessories)</p>	 <p>Unit: mm</p>
L-shaped operation key	OX-K2 operating key size diagram
 <p>(Optional accessories)</p>	 <p>Unit: mm</p>
Long T-shaped operating key	OX-K3 operating key size diagram
 <p>(Optional accessories)</p>	 <p>Unit: mm</p>
Long L-shaped operating key	OX-K4 operating key size diagram
 <p>(Optional accessories)</p>	 <p>Unit: mm</p>

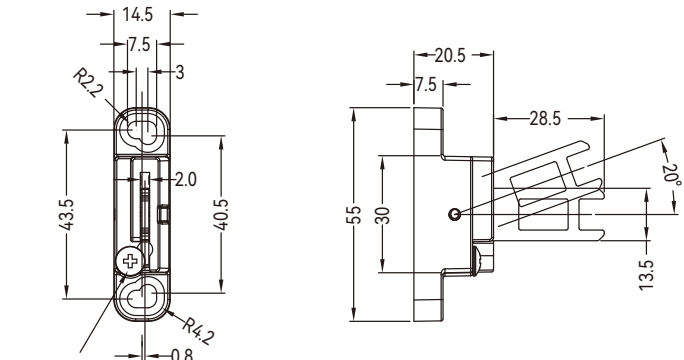
T-shaped operation key	OX-K1D operating key size diagram
 <p>(Optional accessories)</p>	 <p>Unit: mm</p>
L-shaped operation key	OX-K2D operating key size diagram
 <p>(Optional accessories)</p>	 <p>Unit: mm</p>
Long T-shaped operating key	OX-K3D operating key size diagram
 <p>(Optional accessories)</p>	 <p>Unit: mm</p>
Long L-shaped operating key	OX-K4D operating key size diagram
 <p>(Optional accessories)</p>	 <p>Unit: mm</p>

Horizontal adjustable operating key	OX-K5 operating key size diagram
 <p data-bbox="181 610 424 638">(Optional accessories)</p>	 <p data-bbox="662 599 906 627">Angle adjustment screw</p> <p data-bbox="1390 610 1477 638">Unit: mm</p>

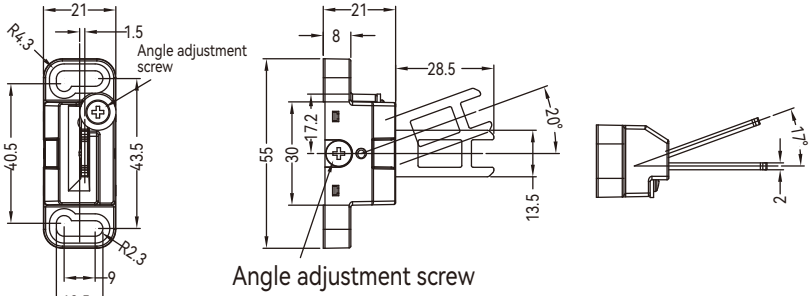
Horizontal/vertical adjustable operation key	OX-K6 operating key size diagram
 <p data-bbox="181 1144 424 1172">(Optional accessories)</p>	 <p data-bbox="826 1078 1070 1106">Angle adjustment screw</p> <p data-bbox="1390 1144 1477 1172">Unit: mm</p>

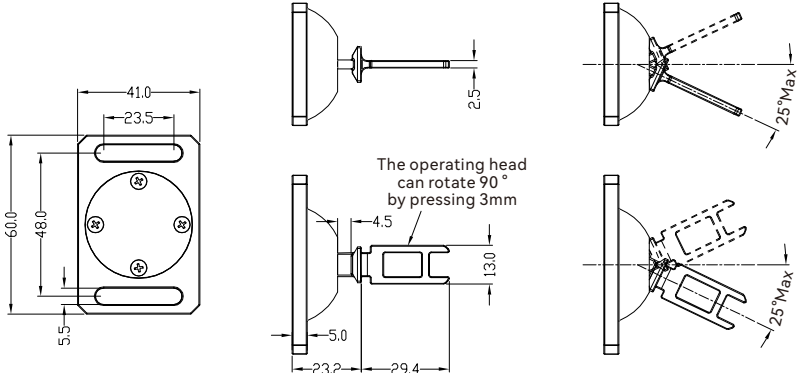
Horizontal/vertical adjustable operation key	OX-K8 operating key size diagram
 <p data-bbox="181 1683 424 1711">(Optional accessories)</p>	 <p data-bbox="976 1476 1134 1532">The operating head can rotate 90° by pressing 3mm</p> <p data-bbox="1390 1683 1477 1711">Unit: mm</p>

## Installation diagram of OX-W2 operation key

- Loosen the four screws at the top of the head, rotate the head direction to select the appropriate operating keyhole position, and then proceed with installation.

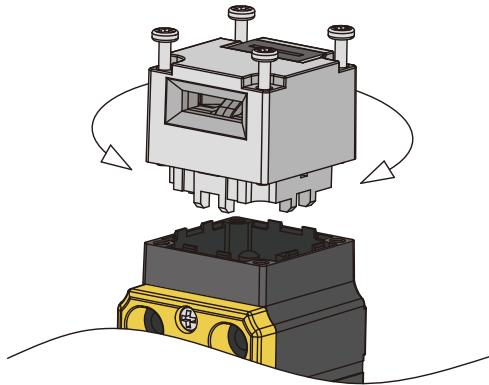

- When installed on a side hung door, it must be greater than the minimum radius.

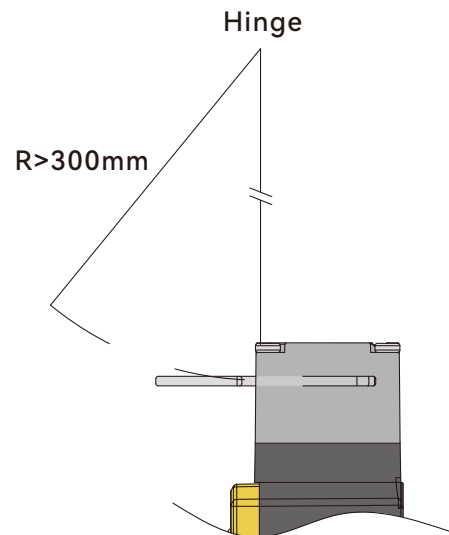
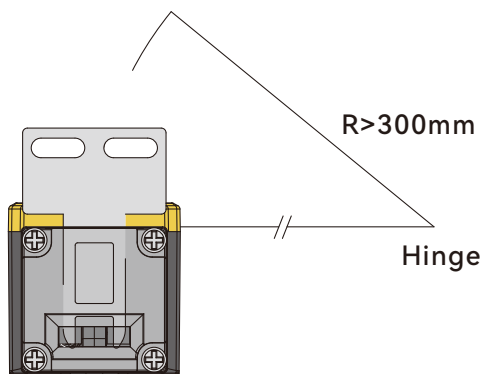

- Please install switches and operating keys within the prepared position range (1-3.5mm).

Ready position: 1.0~3.5mm

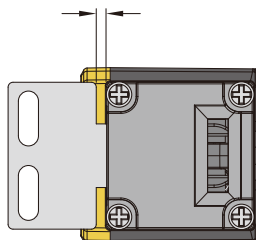

- The allowable error for the installation of the operating key is within  $\pm 1$ mm of the center of the operating key insertion hole.

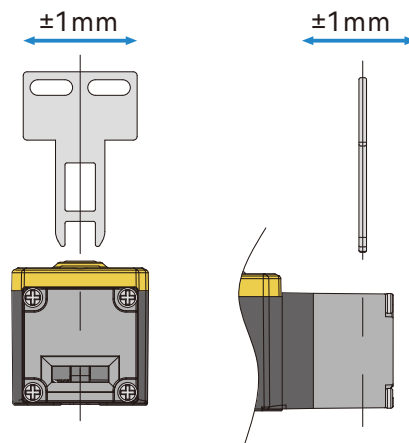

## OX-W2 Installation diagram of back unlocking components

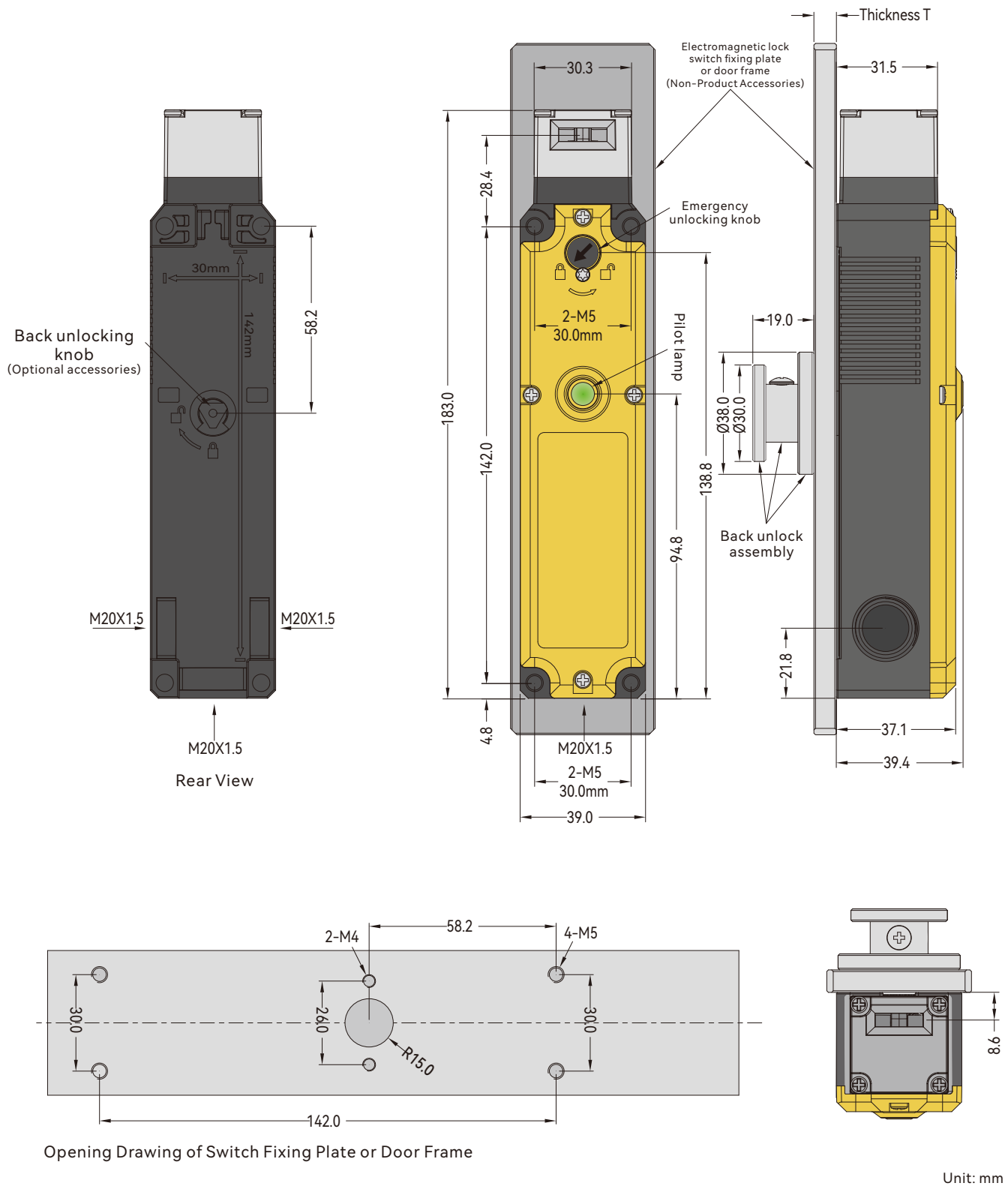

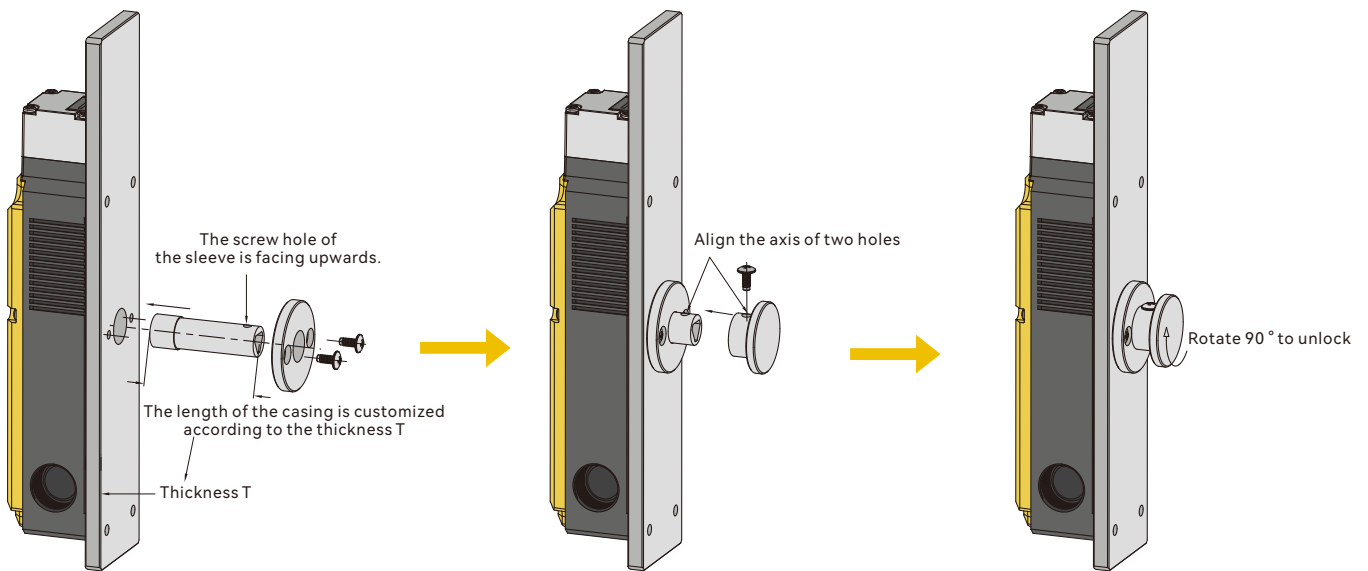

**Step 1:**

1. Install the electromagnetic lock switch onto the switch fixing plate or door frame first;
2. Thread the sleeve as shown in the figure through the switch fixing plate or door frame and insert it into the unlocking knob on the back of the electromagnetic lock switch;
3. Use M4 machine wire to install the sleeve limit plate onto the switch fixing plate or door frame.

**Step 2:**

1. Insert the metal knob into the sleeve and align it with the two hole axes;
2. Tighten with M4 screws.

**Step 3:**

1. The installation is completed as shown in the figure.
2. The metal knob can only be rotated clockwise by 90°.

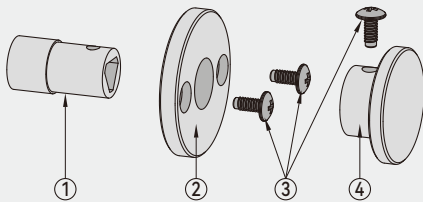
**Back unlocking accessories**

- ① Sleeve (length customized according to the thickness of the switch fixing plate or door frame)
- ② Sleeve limit plate
- ③ M4 machine thread (3 pieces)
- ④ Metal knob

**● Back unlocking knob**



- The back unlocking knob is a safety measure for emergency evacuation when operators are accidentally trapped in a safety barrier (dangerous area).
- Rotate the 90° metal knob clockwise to release the lock and the door can be opened.
- If you need to restore the locked state, please turn the metal knob counterclockwise by 90°. When the metal knob is in the unlocked position, even if the door is closed, the door cannot be locked.

**● Precautions for unlocking the knob on the back:**

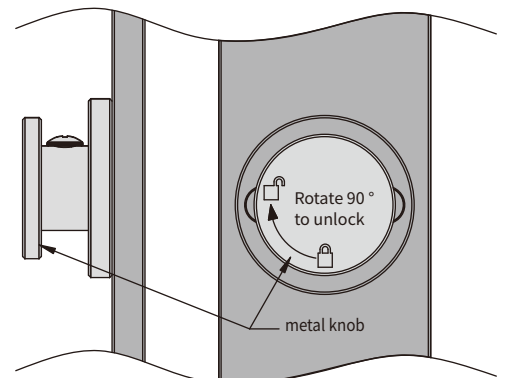
- Please make sure to install the back unlocking knob in a safe barrier (hazardous area) where it can be operated.
- Please do not use tools or other tools to operate the back unlocking knob, or apply excessive force or force in a direction other than the operating direction, as well as beyond the rotation angle range, to avoid damage to the knob components and inability to operate.

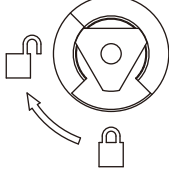
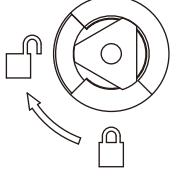

## ● Emergency unlocking

Unlock screw type	Normal	Manual unlocking
Front unlocking		
Straight+Hexagram or cross		
Back unlocking		
Special knob+conduit		

- When dealing with power outages or emergencies, the emergency unlocking button can be manually operated.
- Before operating the emergency unlocking key, first raise the inner Hexagram screw, otherwise the emergency unlocking key cannot be unlocked normally and will be damaged.
- When rotating the emergency unlocking button, it is necessary to rotate it to the bottom, otherwise there is a risk of damaging the switch or not being able to operate normally.
- Please control the torque of the emergency unlocking key to below 0.2N. m, otherwise there is a risk of damage.
- After each use of the emergency unlocking button to unlock and handle an emergency situation, reset the emergency unlocking button. Otherwise, it may affect the normal locking function of the switch and potentially cause personal injury or safety accidents.
- Only device administrators can operate the emergency unlock button.

## ● Usage environment

1. Do not immerse the switch in oil or water, or use the switch in a position where it is continuously splashed with oil or water.
2. Otherwise, it may cause oil or water to enter the interior of the switch.
3. The IP67 protection level of the switch specifies the water inflow after the switch is immersed in water for a certain period of time.

## Safety door handles

### Performance data

Model	OXSL-A-1	OXSL-A-2	OXSL-B-1	OXSL-B-2
Mechanical life	1 x 10 <sup>6</sup> times		1 x 10 <sup>6</sup> times	
Installation location	Doors or fences		Doors or fences	
Installation mode	Left or right		Left or right	
Base material	Zinc alloy		Aluminium alloy	
Slider material	Zinc alloy		Aluminium alloy	
Handle material	Stainless steel		Stainless steel	
Ball head material	Plastic		Plastic	
Weight	0.6kg		0.95kg	1.05kg

### • Appearance diagram

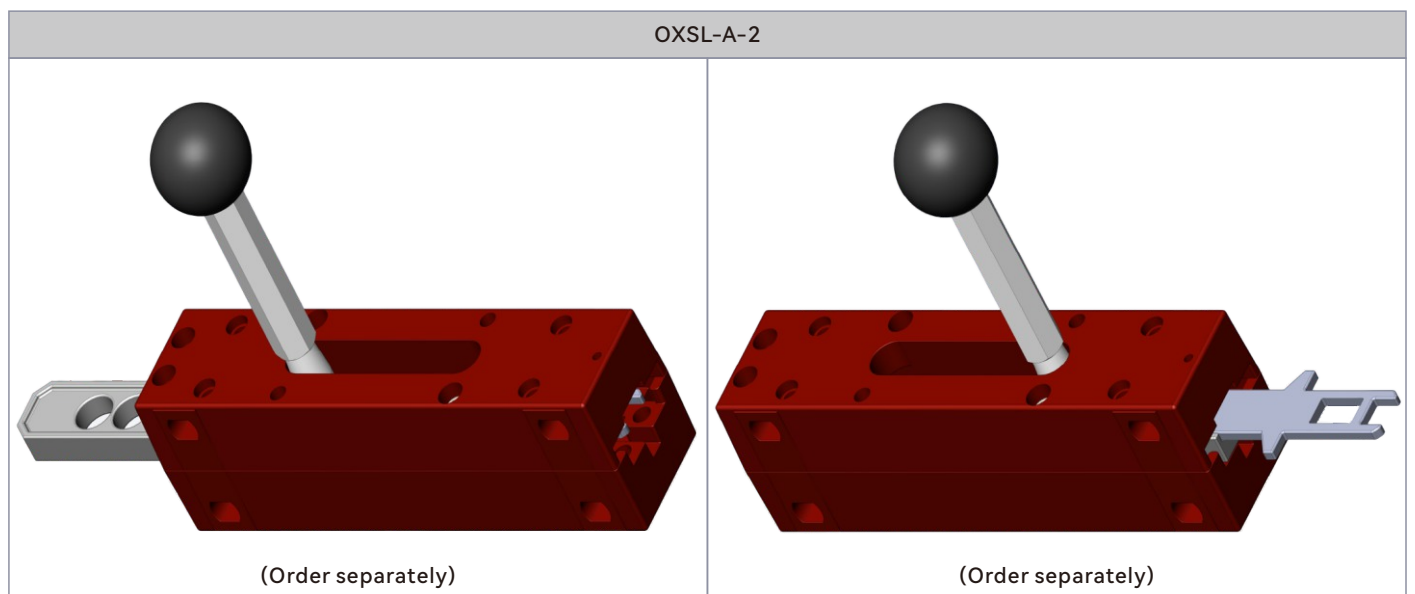
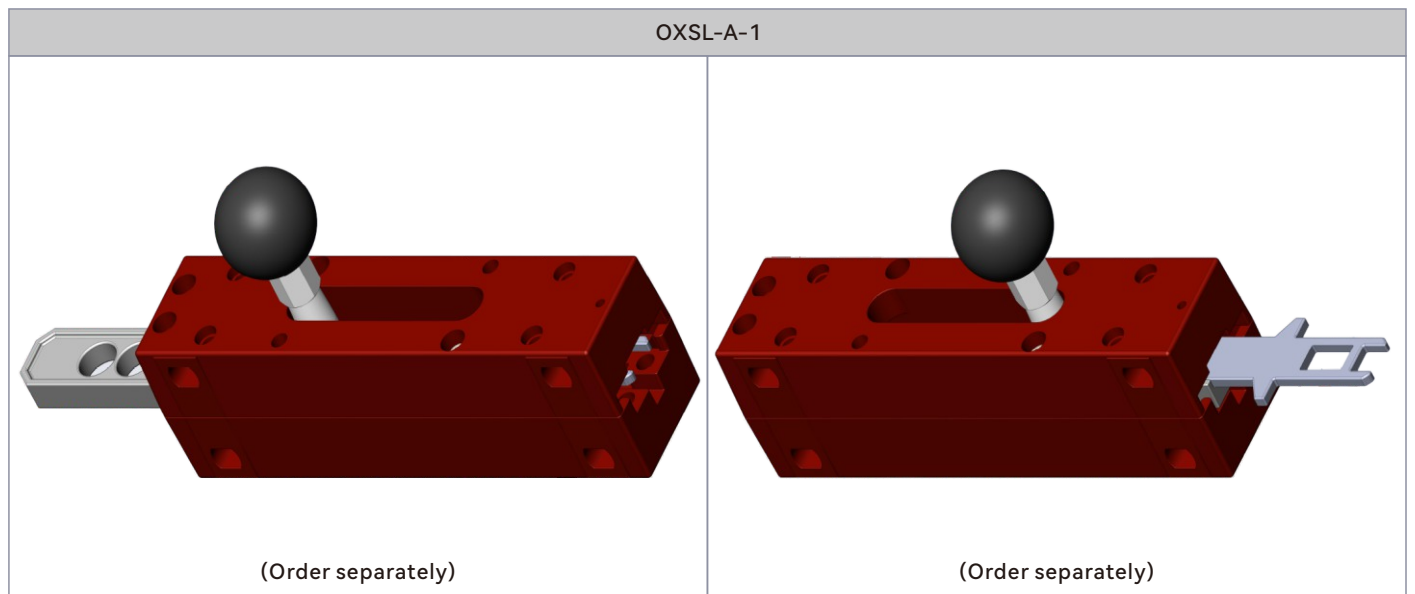

## • Appearance diagram

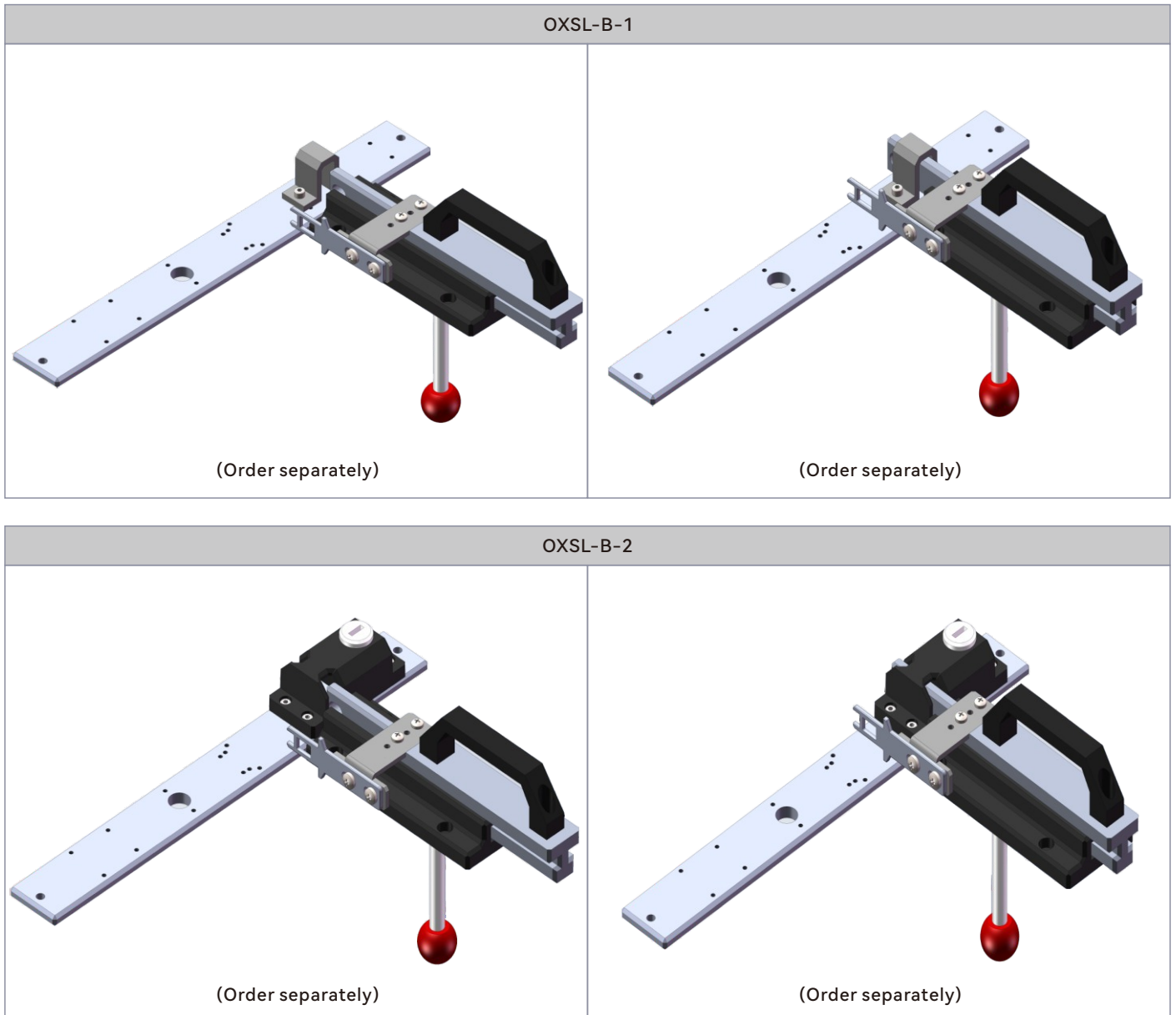

- Installation dimensions of safety door bolts

## OXSL-A-1 installation dimensions

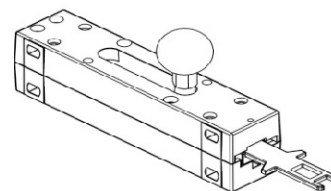
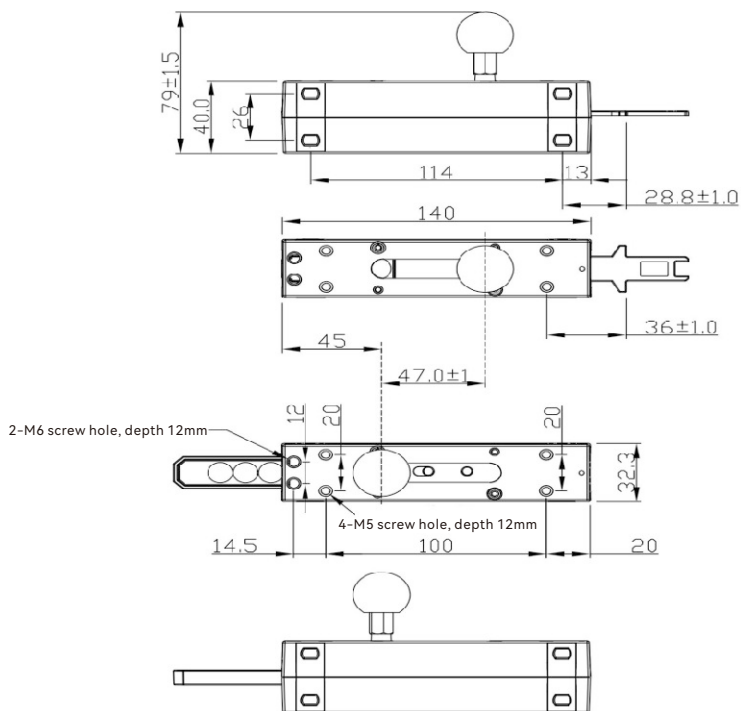

Pushing out the key

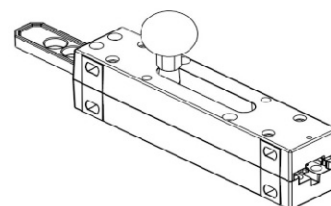

Retract key

Unit: mm

## OXSL-A-2 installation dimensions

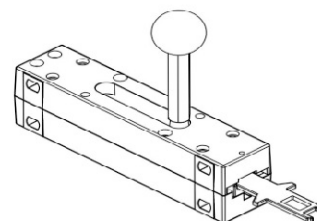
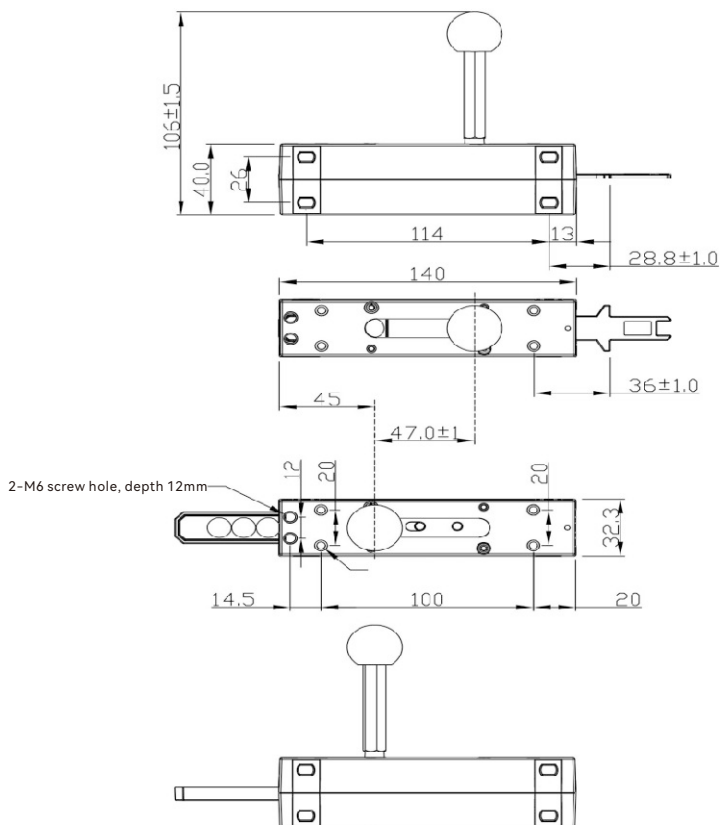

Pushing out the key

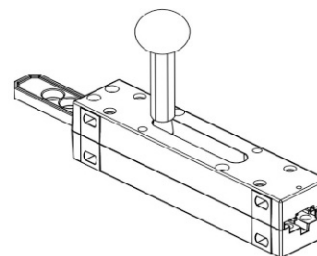

Retract key

Unit: mm

● Installation dimensions of safety door bolts

OXSL-B-1 installation dimensions

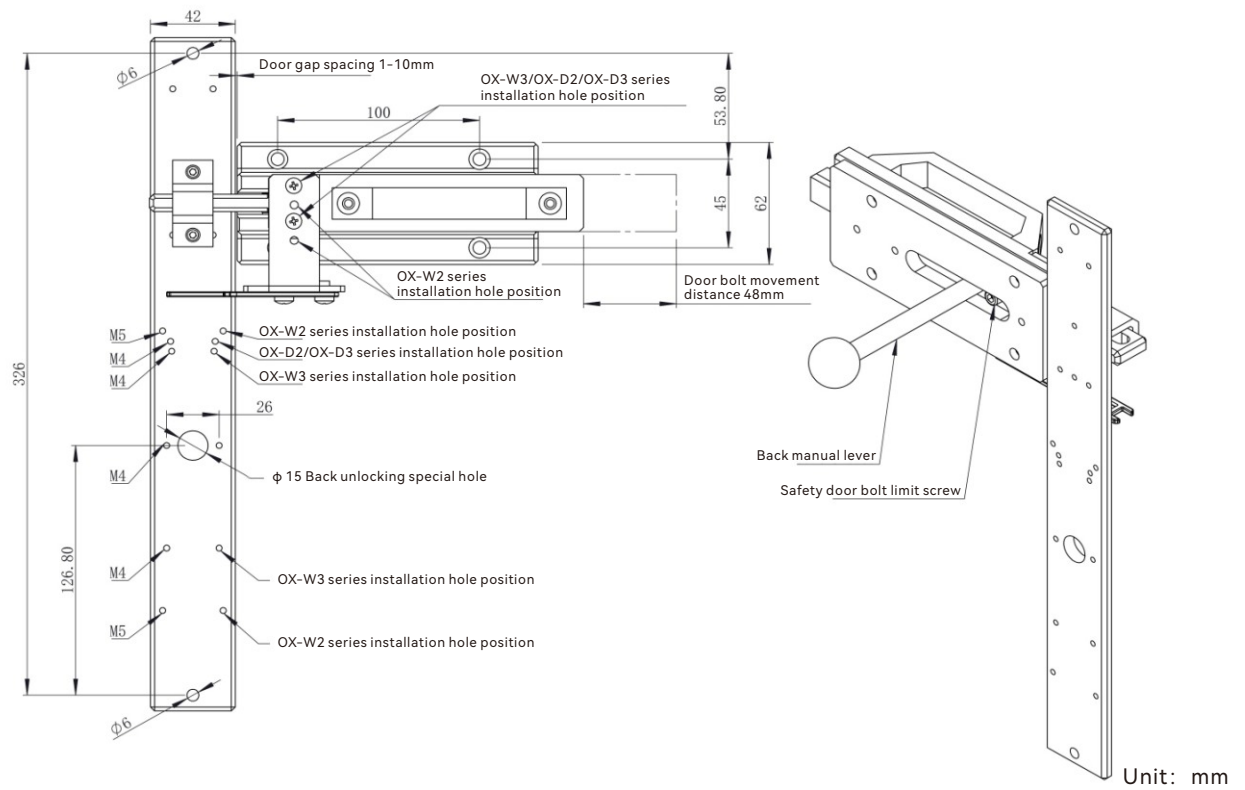

OXSL-B-2 installation dimensions

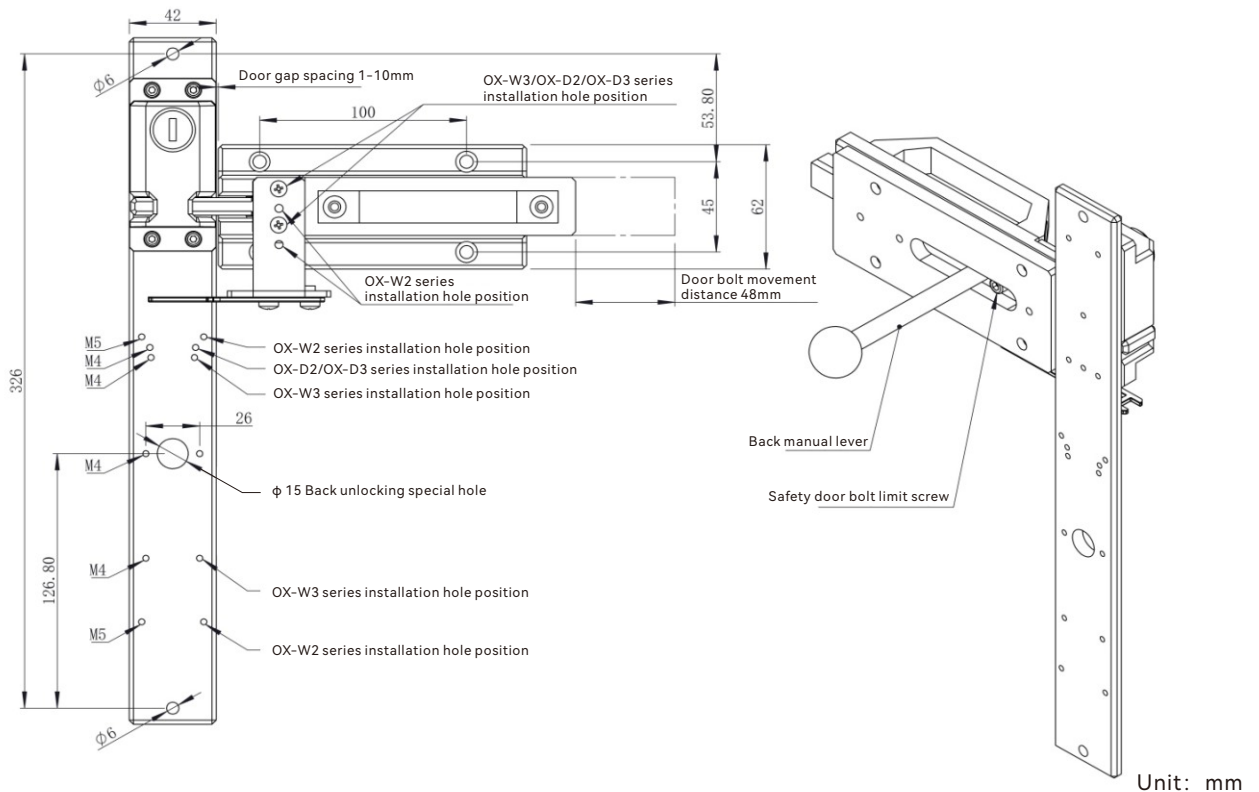

DADISICK is honored to provide you with safety protection.



Please be sure to thoroughly understand the content of the user manual before using our company's products.

For your safety, please be sure to follow the precautions in the user manual.

The specifications and accessories recorded in this manual may be changed when necessary, during improvements, or for other reasons. Please consult our sales personnel to confirm the actual specifications of our products.

## SAFETY PRECAUTIONS

### **Warning (Violation of this item may result in death or serious injury)**

01. In order to protect personal safety and prevent safety accidents, please install multiple safety protection devices when using this product. Otherwise, it may cause personal injury or safety accidents.
02. Please configure a device administrator during the use of this product. The administrator's requirements are as follows:
  - Operators familiar with the installation, setup, use, and maintenance of this product
  - Personnel who are familiar with and comply with the regulations/systems/regulations of the country or region corresponding to the type of equipment used in this product
 Except for equipment managers, personnel unfamiliar with this product who operate the equipment may pose a risk of personal injury or safety accidents.
03. After installing the product, please conduct debugging before the equipment is officially running and ensure that the product's functionality meets the expected protection requirements. When the product is not set according to the expected action, it may cause personal injury or safety hazards.
04. It is prohibited to operate in places containing explosive, flammable, corrosive gases, with intense temperature changes, high humidity, and the possibility of condensation  
Places, places with intense vibration, places with diluents, detergents, and other solvents for use.  
Otherwise, there is a risk of explosion or fire, which may lead to a decrease in product performance.
05. The product has multiple modular coding functions. Please confirm the usage requirements before leaving the factory and select the appropriate model according to the usage requirements. Please do not allow any Intentionally transforming products. Otherwise, there is a possibility of reducing product performance and causing damage to the switch.
06. Do not use the safety switch as a stop element for the door. Please be sure to set a mechanical stop element to limit the position of the door. Do not use the safety switch as a stop element  
As the full switch is used as the door lock device, please add mechanical door bolts or other methods to set the door lock.  
Otherwise, due to vibration or the door itself, the safety switch operation key may deviate and cannot be accurately inserted into the switch actuator, or even  
There is a possibility of damaging the switch.
07. The safety switch of the power-on locking type remains locked when powered on, and unlocked when powered off. In case of emergency power outage or other accidents  
In this case, the switch solenoid may be unlocked due to power outage, and the internal device may not be completely stopped due to inertia or other reasons. Please be sure to  
It is necessary to confirm that the machine has completely stopped.  
Otherwise, there may be a risk of personal injury.
08. When the safety switch is continuously energized by the solenoid, the maximum temperature of the switch panel is about 25 °C higher than the ambient temperature.
09. If the device is used while the emergency unlocking knob is in position , electromagnetic locking may not work, resulting in some devices stopping when they should be Still in operation at the end.  
Before using the device, make sure to place the emergency unlocking knob in position . In addition, please check the status of the locking and safety circuits.
10. Before changing the head direction,  please make sure to set the emergency unlocking knob to the position or install the operation key. Otherwise, it may cause damage to the switch, resulting in some devices still operating when they should be stopped.

### **Attention (Violation of this item may result in personal injury or product damage)**

01. Before installation, confirm the wiring diagram before proceeding with the wiring.
02. Please use within the rated specification range.
03. Please correctly distinguish the polarity of the solenoid before wiring. Do not reverse the connection and do not apply voltage outside the rated voltage range.
04. When replacing the head, please prevent foreign objects from entering the interior of the switch and lock the fastening screws tightly.
05. When opening the protective cover, it is necessary to prevent debris, liquid, cable residue, and other foreign objects from entering the interior of the switch.
06. Please use reliable fixation methods such as welding and screws to secure the operating keys in a reasonable position to prevent detachment or displacement.
07. Do not perform unlocking operations when applying external forces such as pushing or pulling on the operating key (safety door).
08. When the door is open, please do not insert the operation key. Otherwise, the machine may move and cause injury.
09. Please use the dedicated operation key configured by our company's safety switch, and be careful to keep the backup operation key.
10. Do not use metal cable waterproof joints or metal conduits.