

# Instructions for Use

## Portable Veterinary Endoscope

### RAE-105



To ensure safety, be sure to read these instructions before use !

Please read this instructions for use thoroughly before using the product and keep it properly for future reference. Information in the instructions may change at any time without prior notice. You may visit the website <https://www.jeetvet.com> for contact information.

When using the product, please strictly follow the instructions and properly carry out maintenance, which will greatly reduce the occurrence of faults and prolong the service life of the product.

Since the product is being improved continuously, the appearance or specifications of the product may be different from that stated in the instructions without prior notice.

Copyright © 2024 All rights reserved. No reproduction in any form of the instructions, in whole or in part, may be made without the written authorization from Jeet Medical (Shenzhen) Co., Ltd.

The version number of the user manual may be upgraded at any time without notice due to changes in software or technical specifications.



Jeet Medical (Shenzhen) Co., Ltd.

901, Block B, No.76 Baohe Avenue, Longgang District, Shenzhen,  
China

Tel: +86-755 2325 1842

Website: [www.jeetvet.com](http://www.jeetvet.com)

Version: A0

For veterinary use only.

## About the Instructions for Use

The Instructions for Use describes in details of the use, functionality, and operation method of the product.

Before using the product, please read the instruction manual carefully and understand the contents to ensure that the product can be used correctly and to ensure the safety of animals and users.

The instructions describe the product in its most complete configuration, so some of the contents may not apply to the product you have purchased. If you have any questions, please contact Jeet Medical.

Please keep this instruction manual near the product so that it can be easily and promptly accessed when needed.

The instruction manual is suitable for professional veterinary clinical staff with knowledge and working experience in the medical procedures, practices and terminology necessary for endoscope.

All illustrations provided in the instructions are for reference only and the settings or data in the illustrations may not exactly match the actual display you see on the product.

# Contents

## 1. Important information - Please read before use

- 1.1 Brief introduction
- 1.2 Intended use
- 1.3 Instruction manual
- 1.4 Ancillary instrument
- 1.5 User qualifications
- 1.6 Check the package contents
- 1.7 Repair and modification
- 1.8 Symbols description
- 1.9 Warnings and precautions

## 2. Product overview

- 2.1 Schematic diagram of components
- 2.2 Technical parameters
- 2.3 Environmental conditions

## 3. Preparation and inspection

- 3.1 Preparing the equipment
- 3.2 Software installation

## 4. Product operation

- 4.1 Installing the mobile phone
- 4.2 Turning on/off the endoscope
- 4.3 LED light adjustment
- 4.4 Photographing/video recording
- 4.5 File saving
- 4.6 Foreign body removal
- 4.7 Water and air supply

## 5. Maintenance, storage and disposal

- 5.1 Cleaning and disinfection
- 5.2 Storage
- 5.3 Disposal

## 6. Troubleshooting

## 7. Warranty

## 1. Important information - Please read before use

**! Note:** Before using the portable veterinary endoscope, please read and fully understand the instruction manual of this product to ensure proper use.

### 1.1 Brief introduction

The RAE series Portable Veterinary Endoscope is a handheld veterinary device. It can be connected to a series of smart devices such as Apple iPhones, Android phones, tablets. The product has a highly sensitive angulation controller. It can realize 360° universal steering and 180° bending. This endoscope is widely used in gastrointestinal surgeries. A large-size working channel of  $\geq 2\text{mm}$  is integrated within the ultra-fine outer diameter, which facilitates veterinarians to extend the forceps into the animal to realize precise examination and foreign body removal. Equipped with a mega HD camera, it can transmit vivid, clear and all-round real-time images to the smart device through data cable. This device is an ideal tool for animal examination. It is also very helpful for the teaching and clinical training for novice veterinarians.

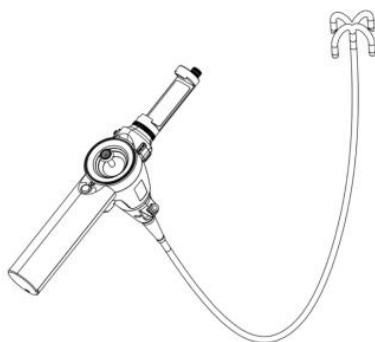

RAE-105 Veterinary Endoscope

## **1.2 Intended use**

The portable veterinary endoscope RAE-105 displays images by connecting mobile phone, tablet or monitor to achieve endoscopic diagnosis and treatment for veterinary use. Do not use this endoscope for any purpose other than its intended use. Select the endoscope to be used according to the objective of the intended procedure based on the full understanding of the endoscope's specifications and functionality as described in this instruction manual.

## **1.3 Instruction manual**

This manual should be kept in an accessible place. Before use, review this manual which contains the instructions regarding to the maintenance and operation of the endoscope. The malfunction rate could be significantly reduced by following the essentials in the manual during operation and maintenance, resulting in extended lifetime of the endoscope.

## **1.4 Ancillary instrument**

Refer to “Check the Package Contents” to confirm that this endoscope is compatible with the ancillary instrument you are using. Use of incompatible instrument may result in animal or operator injury or device damage. Please carefully check the items in the package. If any item is missing or damaged, contact Jeet Medical or distributor immediately.

## **1.5 User qualifications**

The manual introduces the ideal preparation and inspection





procedures. It is not the detailed instruction for clinical examination and does not intend to familiarize beginners with endoscopy techniques and medical knowledge. This endoscope must be operated by a medical practitioner capable of safely performing endoscopy after operation technique training.

### 1.6 Check the package contents

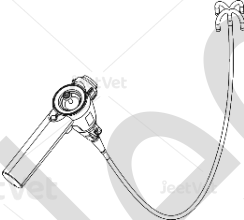
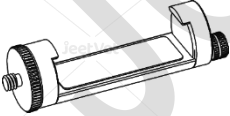
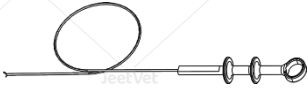
Check all items in the package. If any components is missing or damaged, do not use the item, contact Jeet Medical or authorized distributor immediately. Accessories below in the list are only for the reference. Please refer to the packing list included in each shipment.

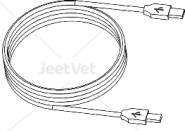
#### Description of the components

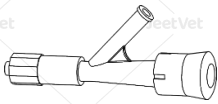
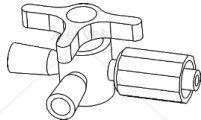
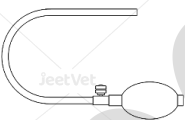
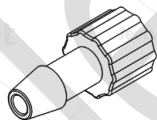
	Veterinary Endoscope
	Mobile phone holder
	Foreign body forceps

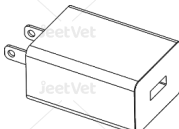
	<p>USB Data cable</p>
	<p>Type-C data cable</p>
	<p>Y-shape valve</p>
	<p>Luer three-way connector</p>
	<p>Inflatable balloon</p>
	<p>Connector of Inflatable balloon</p>
	<p>Syringe</p>
	<p>USB charger</p>





### 1.7 Repair and modification

This endoscope does not contain any user-serviceable parts. Do not disassemble, modify or attempt to repair it, operator injury, equipment damage or the failure to obtain the expected functionality may result.



Do not use this equipment when it may be contaminated, suspected or malfunctioned. If repairs are required, please contact Jeet Medical. If parts are required, they should be purchased from the manufacturer by an engineer. The use of substandard parts will cause safety problems.











**Warning:** This equipment should only be repaired by Jeet Medical technicians. Jeet medical will not be liable for any injury or damage caused by repairs made by any technicians other than our own.

### 1.8 Symbols description

The symbols that appear on the back cover of the package, the manual, or in the product are described as follows:

Symbol	Description	Symbol	Description
	<p>Reading instructions for use</p>		<p>Consult instructions for use</p>

	Keep away from sunlight		Keep dry
	Warning		This side up
	Serial number		Fragile, handle with care
	Manufacturer		Date of manufacture

**1.9 Warnings and precautions**

Please read the following precautions carefully to ensure proper use of this product. Failure to read the following items carefully may result in equipment damage or improper operation:

- a. After each use of the endoscope, please clean, disinfect and store it according to this manual.
- b. Do not bump, hit, drop, bend, twist or pull the distal end, insertion tube, bending part, directional rocker or endoscopy connector.
- c. Do not force or suddenly perform bending angle control.
- d. Do not operate the bending section, insert or pull out the endoscopy insertion tube, or use endoscope accessories without viewing the endoscope image or with the image frozen or magnified.

- e. Do not insert or withdraw the endoscope insertion section when the curved section is deflected, as this may result in injury, bleeding, or perforation of the animals.
- f. The curved portion can be bent in both up and down directions, and make sure that the curved portion is in a flat state when inserting or removing the endoscope. Do not use excessive force when inserting or removing the endoscope, otherwise it may cause injury, bleeding or perforation of the animals.

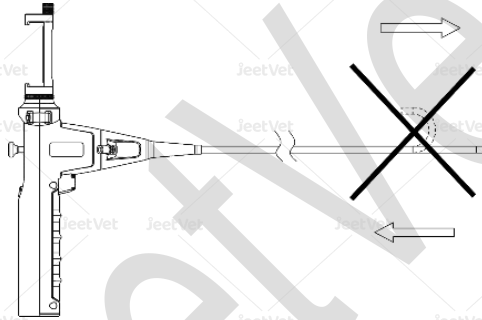

- g. Control the bending direction only by toggling the rocker, do not break the bending part by hand, this may cause the traction wire to break.

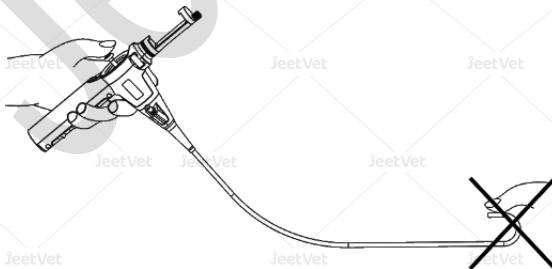

- h. It is not advisable to control the operating handle at the maximum bending angle for a long time, such operation will make the device in a high load state, affecting the service life of the device, in the

maximum bending angle as far as possible to control within 40 seconds.

- i. If resistance is encountered when inserting the endoscope, do not force the insertion, and stop the insertion immediately. Otherwise, it will lead to injury, bleeding or perforation of the animals.
- j. Do not operate the curved part of the endoscope, supply air, insert or remove the insertion part of the endoscope, or use accessories without obtaining a clear endoscopic image or when the endoscopic image is frozen, otherwise it will result in injury, bleeding, or perforation of the animals.
- k. Ensure that the endoscope is not in close proximity or stacked with other equipment (components of the instrument or system) to avoid electromagnetic interference.
- l. Keep the insertion and bending sections as straight as possible, and do not attempt to forcibly bend the insertion section of the endoscope, otherwise the endoscope may be damaged.

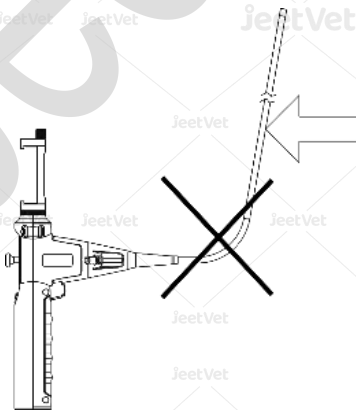

- m. Do not collide with the end, especially the surface of the lens at the distal end, or it may lead to abnormal images.
- n. Prohibit the use or storage in explosive, strong electromagnetic field, and places with flammable gas, or it may cause fire or explosion.
- o. Do not look directly at the strong light source emitted from the endoscope probe end at a close distance to avoid the strong light from affecting your vision.
- p. At the end of the operation, try to let the insertion tube return to a straight state, do not pull it out of the animal in a bent state, in order to prevent the probe from being stuck with too much force, which may lead to damage of the steering function.

## 2. Product overview

### 2.1 Schematic diagram of components

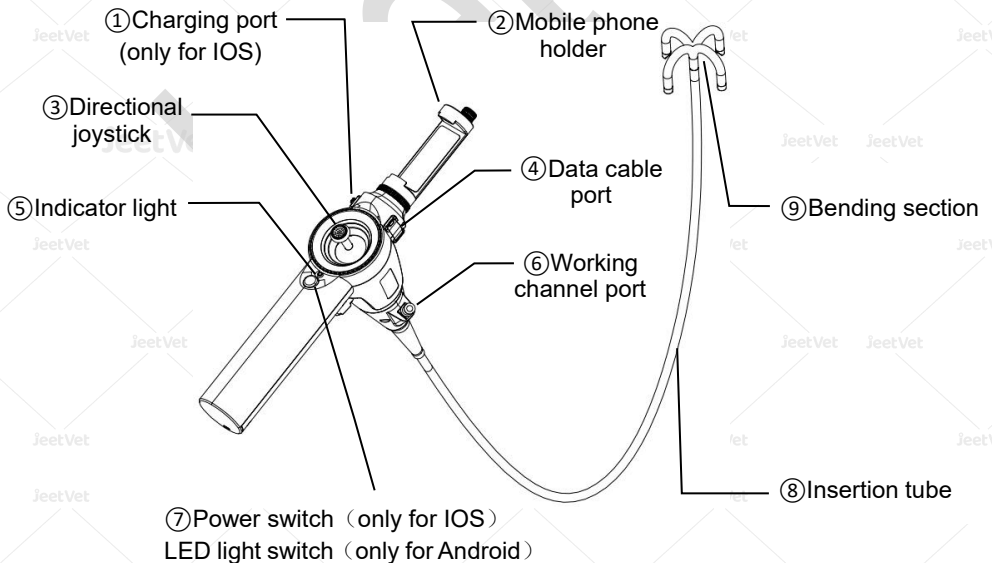

## 2.2 Technical parameters

Outer diameter	5.8mm	Depth of field	7-100mm
Working channel	2.0mm	Steering	360°
Working length	750mm	Angle of field	120°
Pixels	1,000,000	Illumination	LED light
Angle of bend	Up & down 180° Left & right 180°	Memory	Internal memory of Mobile phone
Connection	USB	Weight	< 1kg
Material of tube	Double layer medical flexible tube	Independent water & air supply channel	None
Compatible system	Android, Windows IOS		
Accessories	Foreign body forceps, Mobile phone holder, cleaning brush, Inflatable balloon, Connector of balloon, Luer three-way connector, Syringe, Y-shape valve, Type-C data cable, USB data cable, USB charger (for IOS).		

## 2.3 Environmental conditions

Operating environment	Temperature: 5°C~40°C Relative humidity: 10~80%
Storage and transportation	Temperature: -20°C~+55°C Relative humidity: 10~93%
Atmospheric pressure	70kPa~106kPa
Waterproof level	Tube: IP67 Handle: Not waterproof

## 3. Preparation and inspection

Before each use of this endoscope, it must be prepared and inspected as described below. Other equipment used in conjunction with this device must also be inspected in accordance with the operating instructions.

This device has not been sterilized before shipment. Before initial use, clean and sterilize the product according to the instructions in "Chapter 6 Cleaning and Sterilization".

### 3.1 Preparing the equipment

Prepare relevant equipment and PPE (personal protective equipment) (e.g. goggles, face mask, waterproof clothing and protective gloves) before each use. PPE should be of appropriate size and length to prevent skin exposure. Refer to section 1.5 of the instruction manual for details on the use of assistive devices.

The operator of this device must be a veterinarian or a member of the medical staff under the supervision of a veterinarian who has adequate training in clinical endoscopic techniques. Therefore, this instruction manual does not explain or discuss any endoscopic clinical techniques, but only describes the basic procedures and precautions associated with the operation of this device.

Do not insert or remove the endoscope under the following conditions, as this will result in injury, bleeding or perforation of the animals.

- When the accessories extend out of the distal end of the endoscope
- When the bending section is locked
- When it is difficult to insert or remove the endoscope

Stop using the endoscope immediately and withdraw it slowly.

- if you suspect that the endoscope functions abnormally
- if the endoscopy image on the monitor disappears or freezes unexpectedly
- if the directional joystick functions abnormally

Continued use of the endoscope under these conditions may result in injury, bleeding or perforation of the animals.

If you notice an abnormal endoscopy image or function, but it returns to normal quickly, the endoscope may also be malfunctioning, in which case you should stop the inspection immediately. Observe the endoscope image while slowly withdrawing the endoscope from the animal to avoid recurrence of the abnormality, which may result in injury, bleeding, or perforation of the animals.

### **3.2 Software installation**

Please use your mobile phone to scan the following QR code to download and install the APP.





Android phones



Apple iPhones

## 4. Product operation

### 4.1 Installing the mobile phone

Adjust the knob of the mobile phone holder, mount the mobile phone on the holder (supports mobile phones with 3.5" ~ 6.3" screen), and connect the mobile phone and the endoscope ④ with the data cable.

### 4.2 Turning on/off the endoscope

#### (1) Android version

Install the corresponding APP in the mobile phone.

- Connect the endoscope ④ with the data cable, and then connect the other end of the data cable to the mobile phone.
- Check the working indicator ⑤ lights up blue, select the app in the mobile phone. Unplug the data cable from the mobile phone, the endoscope indicator light goes out, then it is turned off.
- Open the app, the interface pops up, select allow/OK, when the user can see the image, use the directional joystick ③ to control the direction for observation.

#### (2) IOS version

Install the corresponding APP in the mobile phone.

- Connect the endoscope ④ with the data cable, and then connect the other end of the data cable to the mobile phone.
- Press and hold the power switch ⑦ to turn on the device, the working indicator ⑤ lights up blue, select the app in the mobile phone. Press and hold the power switch ⑦ again, the endoscope indicator light turns off, then it is turned off.
- Open the APP, the interface pops up, select allow/OK, when the user can see the image, use the directional joystick ③ to control the direction for observation.

### 4.3 LED light adjustment

- Android version: After powering on, the LED light is turned on by default, and the LED light is controlled by touching the power switch ⑦.
- IOS version: After powering on, the LED light is brightest by default, and the brightness level is adjusted by touching the power switch ⑦, and the adjustment range is 0-3 levels.

### 4.4 Photographing/video recording

By pressing the photo button of the handle or touching the APP photo icon you can perform photo-taking, and by touching the APP video icon you can perform video recording.

### 4.5 File saving

The photo/video files are saved in the album of computer or mobile phone in JPG/MP4 format.

#### 4.6 Foreign body removal

The operator selects the appropriate foreign body forceps according to the type of foreign body to be removed.

Adjust the directional joystick to keep the endoscope bending section

⑨ straight, and then connect the Y-shape valve to working channel port ⑥ on the right side of the handle.

Make sure that the distal end of the foreign body forceps is closed, and then slowly insert the forceps vertically into the Y-shape valve. While observing the endoscopic image, slowly and gently insert the foreign body forceps into the working channel.

When the foreign body forceps enter the visual area, open the forceps by operating its handle to gently clamp the foreign body, close the distal end of the foreign body forceps, and lock the forceps by the Y-shape valve. Then slowly remove the endoscope with the forceps from the animal. During this process, ensure that the forceps are fastened securely so that the foreign body does not fall out.

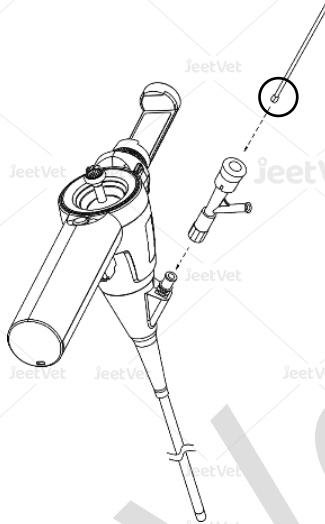

**⚠ Warning:**

Do not open the foreign body forceps when the distal end of the forceps is not visible in the visual area, as this will cause injury of the animals or damage the forceps.

When inserting and removing the foreign body forceps, it is important to ensure that the distal end of the foreign body forceps is closed. Failure to do so may result in damage to the inside of the forceps and dislodgement of the foreign body.

The foreign body forceps are disposable, do not reuse them.

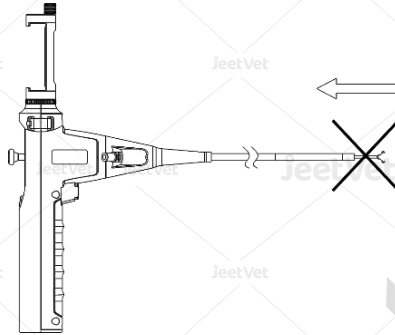

#### 4.7 Water and air supply

- First, connect the Y-shape valve to the working channel port ⑥ on the right side of the endoscope handle.
- Connect the luer three-way connector to the Y-shape valve.
- Connect the inflatable balloon to one end of the luer three-way connector for air supply, rotate the valve on the three-way connector to control the volume of air supply.
- If water supply or waste liquid pumping is required, then connect the syringe to the other connector of the luer three-way connector and rotate the valve on the three-way connector to control the volume of water supply.

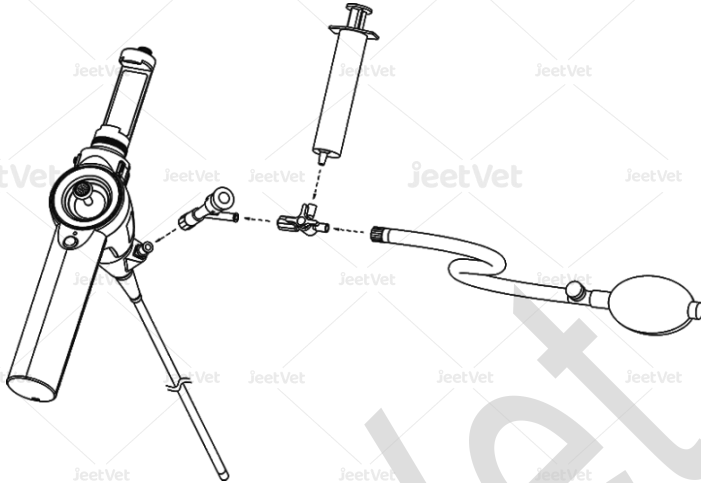

**⚠ Warning: Clean and disinfect after each use in accordance with Chapter 5.1!**

## 5. Maintenance, storage and disposal

### 5.1 Cleaning and disinfection

The endoscope must be cleaned and disinfected after each examination, especially the mucus and dirt adhering to the distal end, inside the working channel and on the tube, which may block the working channel and the endoscope may perform abnormally if not cleaned for a long time. If the endoscope is not cleaned and disinfected correctly it may pose a risk of infection to the next animal or operator using the endoscope.

**⚠ Warning:**

- The endoscope handle is non-waterproof, immersion disinfection is strictly prohibited, the insertion tube can be immersed.
- Please do not immerse the tube for a long time, because repeated or long-term immersion in disinfectant will increase the internal humidity of the endoscope, leading to blurring or even damage to the lens.

Endoscopes are cleaned and disinfected manually as follows:

**(1) Cleaning**

- a. Wipe the insertion tube with gauze or a soft sponge in clean water to remove dirt.
- b. Immerse the insertion tube in cleaning agent and gently scrub the insertion tube with gauze or soft sponge repeatedly.
- c. Insert the cleaning brush into the working channel and scrub the inside of the tube.

Note: The cleaning brush should not be reversed halfway, and the brush tip must be completely exposed from the distal end of the endoscope tube before it can be pulled out in the reverse direction to avoid damage to the inner wall of the tube.

- d. Manually inject clean water into the tube with a syringe for flushing.

**(2) Disinfection**

- a. Immerse the insertion tube in the disinfectant solution and gently and repeatedly scrub the insertion tube with gauze or soft sponge.
- b. Disinfect the working channel according to the method of cleaning the endoscope working channel.

- c. After endoscope disinfection, rinse with water to remove residual disinfectant. At the same time, any residual disinfectant on the inner wall should be removed in the same way as cleaning the endoscopic working channel. If non-sterile water is used for rinsing after disinfection, wipe the endoscope and rinse the working channel with 75% to 95% ethanol, rinse water should not be reused.
- d. Wipe the outer surface of the endoscope with dry gauze.
- e. Blow out the moisture on the inner wall of the working channel with balloon air supply, and then dry the endoscope naturally to prevent bacterial reproduction.

### (3) Precautions for disinfection

- a. General detergent methods cannot achieve the purpose of disinfection, and if endoscopes need to be disinfected, various disinfection methods and materials should be researched and selected from the perspective of the medical profession and in conjunction with the special clinical situation.
- b. Certain materials used in the veterinary endoscopes (e.g., synthetic resins and rubbers, etc.) may be damaged when some disinfectants are used. Due attention should be paid to the safety of the endoscope before using any disinfection method.
- c. The following disinfectants are safe for veterinary endoscopes when used correctly, as confirmed by long-term testing and clinical use:
  - A. Enzyme wash.
  - B. 2% glutaraldehyde solution with a soaking time of not less than 10 minutes.



**⚠ Warning: The following disinfection methods can cause major malfunctions in electronic endoscopes and should be absolutely prohibited!**

- A. Heated, pressurized, EGO sterilized at a pressure of 1.5 atmospheres or more and a temperature of 40°C or more.
- B. Ultrasonic cleaning disinfection
- C. Boiling sterilization
- D. Dry sterilization disinfection
- E. Steam sterilization
- F. Disinfection with cresol or formaldehyde solution
- G. Cleaning and disinfection with undiluted chlorinated benzene cleaning solution

## **5.2 Storage**

- a. Make sure that all the reusable components and cleaning, disinfection equipment are completely dry.
- b. Store all reusable components in a storage cabinet. Make sure that the components are not in contact with each other during storage.
- c. Place all cleaning, disinfection equipment in one container, and then place the container in the storage cabinet.

## **5.3 Disposal**

When the device reaches the end of its effective service life, it is disposed of as electrical and electronic waste, in accordance with all applicable national and local laws and regulations, and arbitrary disposal may cause pollution to the environment.

## 6. Troubleshooting

The information in this chapter is meant to assist the user in diagnosing and solving problems that may arise during use. The following scenarios contain problems that may occur during operation, possible causes of the problems, and suggested solutions.

Is not described in this chapter, discontinue use and contact Jeet Medical for advice and repair.

No.	Malfunctions	Troubleshooting
1.	Endoscope indicator light does not light up	<ol style="list-style-type: none"> <li>1. Check the data cable plug</li> <li>2. Unplug the data cable and reconnect it.</li> </ol>
2.	No real-time image on the display	<ol style="list-style-type: none"> <li>1. Check the data cable plug</li> <li>2. Unplug the data cable and reconnect it</li> <li>3. Replace another display device</li> <li>4. Connect the computer to see if the image comes out.</li> </ol>

- Do not use the endoscope if it is found to be damaged, performance degraded or otherwise abnormal application. Please contact the manufacturer.
- Some non-functional faults can be resolved through the Troubleshooting Guide. If the fault still cannot be removed, please stop using it and contact the manufacturer.
- The manufacturer does not repair accessories. If the accessory is damaged, please contact manufacturer or distributor to buy a new

one.

- d. Do not use the endoscope on animals if an abnormality is suspected.
- e. Damage to equipment or other abnormal conditions may endanger the life safety of animals and operators, and may cause more serious damage to equipment.
- f. If the endoscope parts fall into the animal due to equipment damage or malfunction, stop using them immediately and remove the parts properly.
- g. If any abnormality in the function or image of the endoscope is detected during use, it should be immediately discontinued and carefully withdrawn from the animal in accordance with the contents Withdraw abnormal endoscope.
- h. Generally, the following troubles may happen to the veterinary endoscope. If the problems cannot be resolved by described inspection method, stop using the endoscope and contact the manufacturer.

## 7. Warranty

- Warranty period: 12 months from the date of purchase.
- Warranty coverage: non-human caused failure, due to the failure of the material devices or production process and equipment failure, the faulty parts can be repaired and replaced free of charge during the warranty period.

- If the endoscope is found to be artificially damaged, such as the endoscope insertion tube is compressed and deflated, violently pulled off, broken, with animal teeth marks, bites, etc., as well as the malfunction caused by improper use and maintenance of the user or all kinds of damages caused by disassembling by oneself, the repair cost shall be borne by the user.
- Disposable accessories: refers to the disposable accessories that need to be replaced after each use, and there is no warranty for the disposable accessories.



**Note:** To prevent infection and protect the safety of maintenance personnel, please thoroughly clean and disinfect the endoscope or accessories before returning them to the factory for maintenance, and specify in advance if the endoscope or accessories are to be used by animals with infectious diseases.

**jeetVet**

Seeing Animal Health Clearly

---

Jeet Medical (Shenzhen) Co., Ltd.

901, Block B, No.76 Baohe Avenue, Longgang District, Shenzhen, China

Tel: +86-755-23251842

Email: [export@jeetmed.com](mailto:export@jeetmed.com)

Website: [www.jeetvet.com](http://www.jeetvet.com)