

Vertical oxygen chamber  
instruction manual

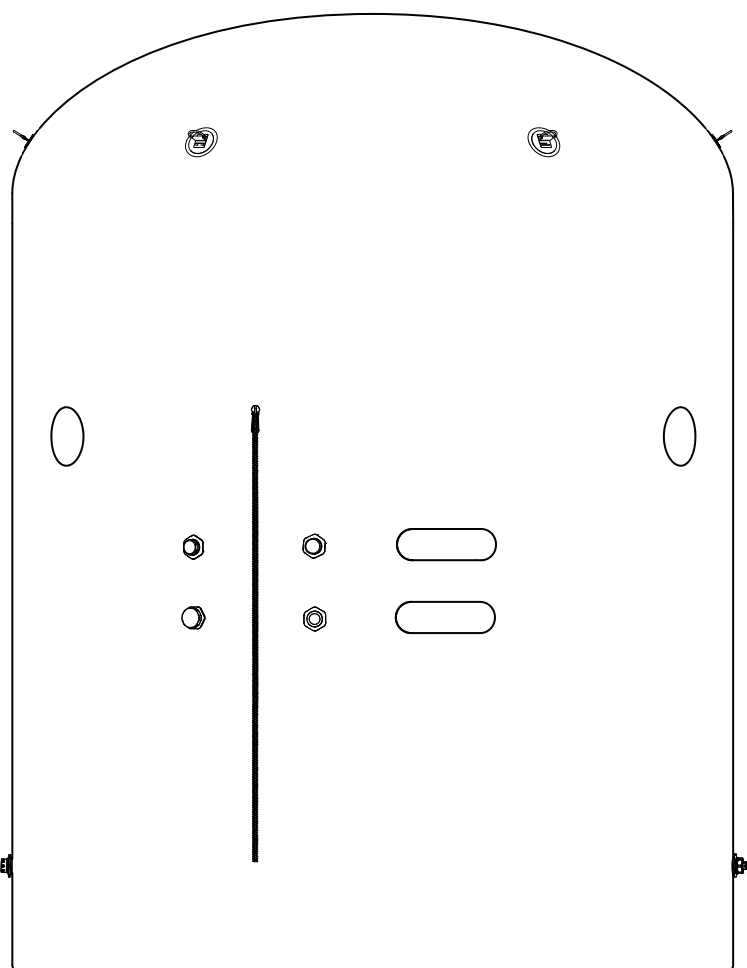

1	Preface.....	2
2	Safety Instructions.....	3
3	Symbol.....	4
4	Product specifications and structure.....	5
5	Product assembly and operation.....	6
6	Frequently asked questions.....	11
7	Troubleshooting.....	12
8	Maintenance.....	13

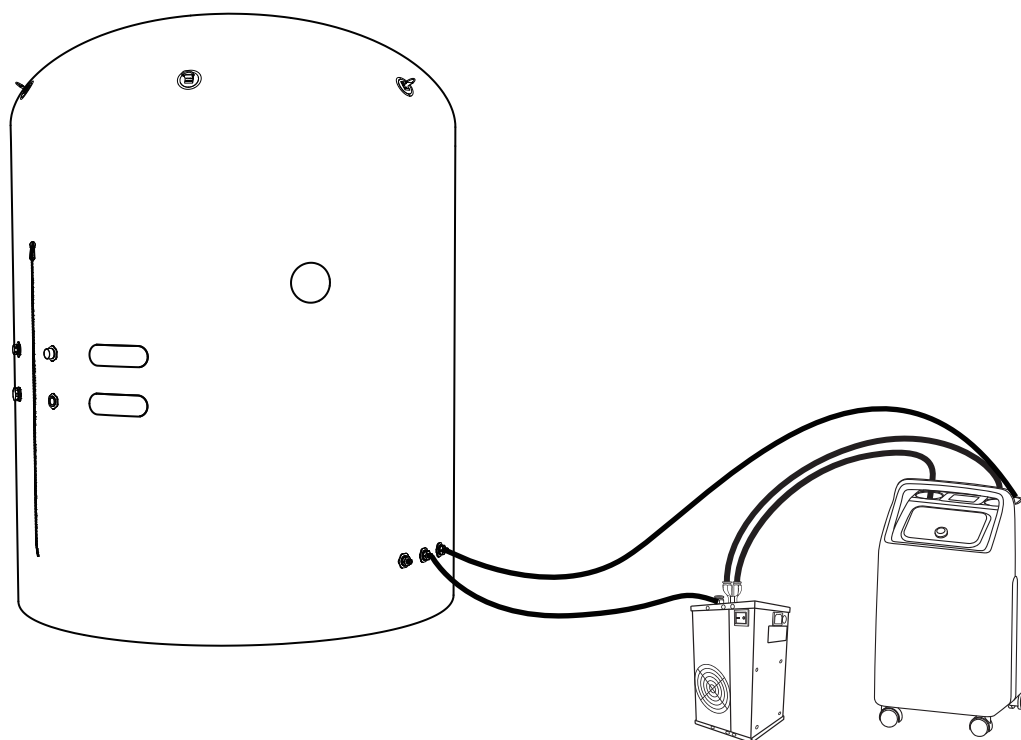

Oxygen is an element that is essential for every cell in our body. However, as we age. With the increase of environmental pollution, our bodies are becoming deficient in this essential nutrient. with other elements. Different, we cannot replenish oxygen in the body by taking medicine or even changing our diet. The oxygen component of our body. It is bound oxygen and dissolved oxygen.

Under normal air pressure, our oxygen-carrying cells (red blood cells, which carry bound oxygen) are saturated and therefore can no longer be carried. Bring any oxygen that may enter our body.

During hyperbaric oxygen therapy, the body is subjected to a gentle increase in pressure slightly above one atmosphere, TRAUMA Creating an environment where oxygen can be dissolved directly into blood (dissolved oxygen), tissues, and other body fluids, making it large. Large increases the amount of oxygen in the cells, prompting the body to produce more energy.

This increase in energy helps the body fight aging, fight stress and relieve other things that we normally don't notice of sub-health symptoms due to deterioration of bodily functions.

To ensure safety, read the following precautions before use

### Warning

1. If there is an abnormal smell during use, please turn off the power and pull out the plug; Verify that the plug and socket are fully inserted.
2. Please do not disassemble the machine without the permission of the supplier; This product needs to be kept away from water, fire and sharp objects.
3. Children must be supervised by an adult.
4. During use, please do not touch any valve on the cavity; Please do not place heavy objects on the machine.
5. Do not use if the wire is loose or damaged; Do not pull or twist the power cord.
6. Do not touch the power plug and switch with wet hands; Do not use in bathrooms or other humid environments.

It is forbidden to use the treatment in the following cases











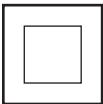

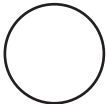

1. Pregnant women and people with serious infectious diseases.
2. People with cold virus or pneumothorax patients
3. Patients with severe emphysema
4. High blood pressure over 160/100 ml
5. Serious heart problems

### Special cases

1. Indoors, the ears may feel uncomfortable when the pressure rises, just like during takeoff and landing in an airplane. This situation is normal. This pressure can be released by: a. Deglutition; b. Chewing gum; c. Yawn; d. Pinch your nose and blow. Stay indoors, and when the pressure stabilizes at 30kPa, this discomfort will gradually disappear. Lose.
2. The zipper can only be opened when the cabin is depressurized to 0kPa.

### 3 Symbol

The following is a detailed description of the oxygen chamber symbol

	Class II equipment		Keep dry from rain
	Disconnection (Use only on a portion of the device)		Smoking is strictly prohibited
	Note! Review random files		No Smoking
	Disconnect (total power)		Avoid sharp objects
	Fragile items		Limit of the number of stacking layers
	Up		Air bleed valve indicator Internal /External
	Alternating current		put through (Only for a part of the device)
	On (Total Power)		

## 4、产品规格和结构



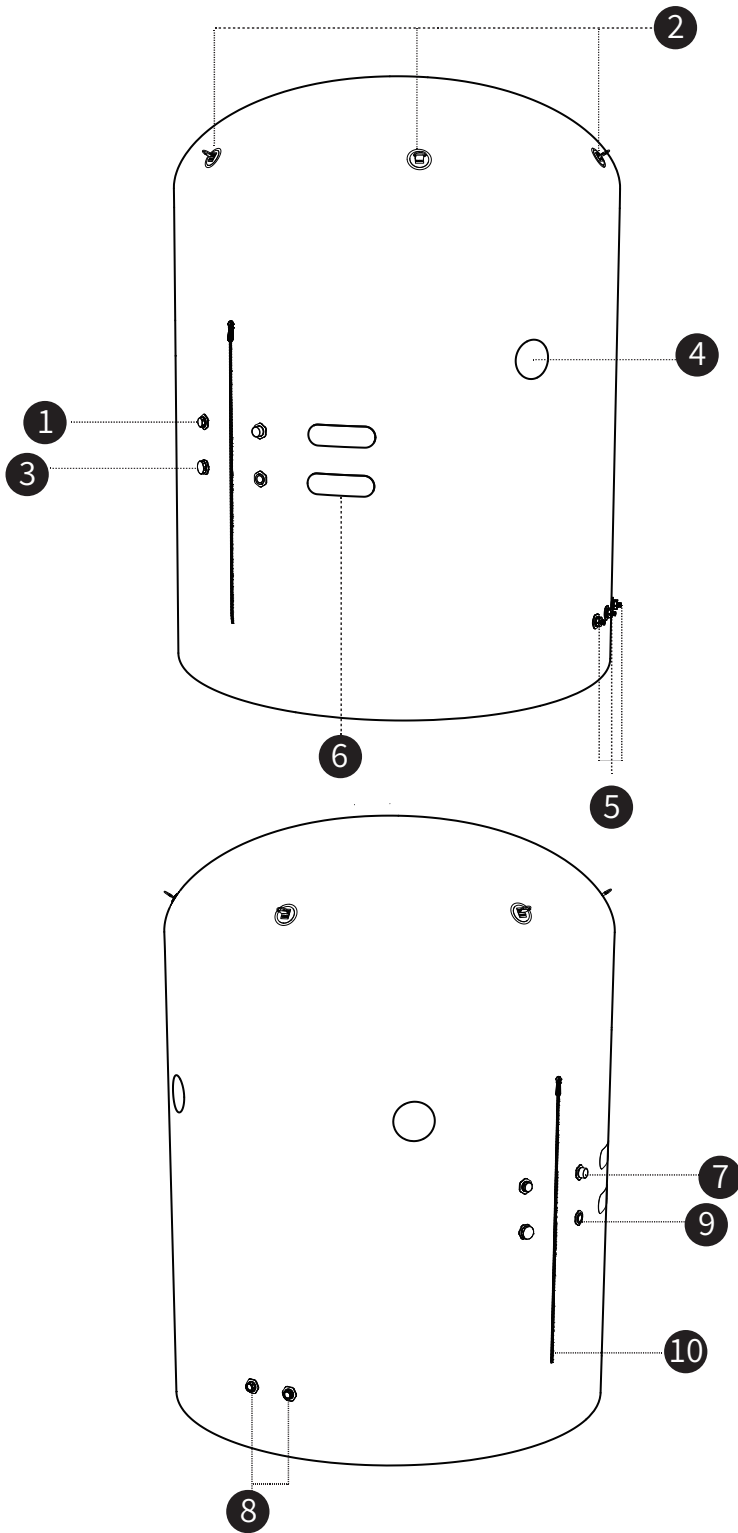

### 氧舱配件标识

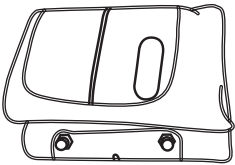

1	Plugs
2	Pull ring
3	Manual pressure relief valve
4	Round transparent window
5	Air intakes
6	Label
7	External pressure gauge
8	Automatic pressure relief valve
9	Internal pressure gauge
10	Zipper

## Installation process

1. Assembly list: Please check if you have the above accessories before assembly

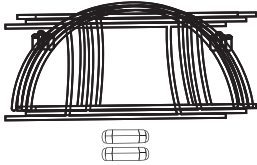
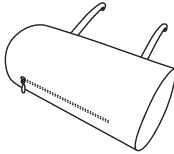
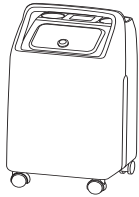
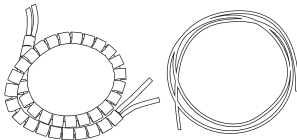
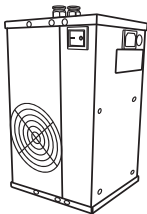
	Cabin		External pressure gauge
	Hex wrench		Internal pressure gauge
	Internal bracket		Sound-absorbing cotton
	Oxygen		Trachea
	Air condenser		

### 3. Assemble the external bracket

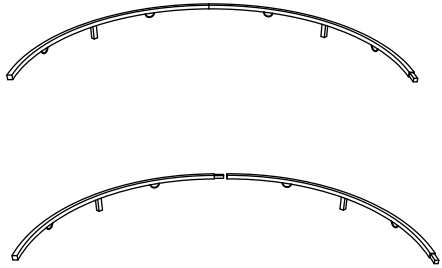

(Connection method)

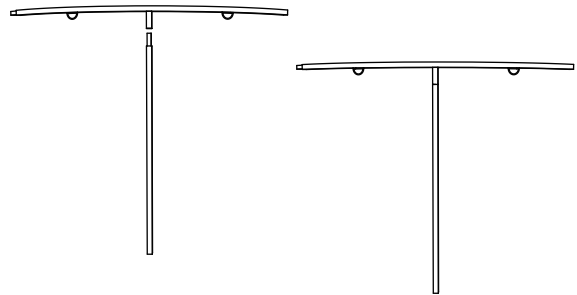

(Connection method)

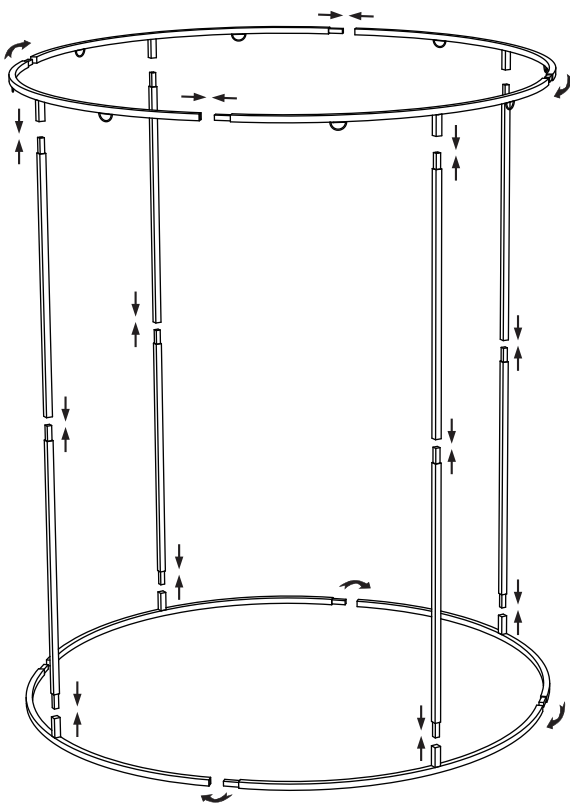

(Connection direction and order)

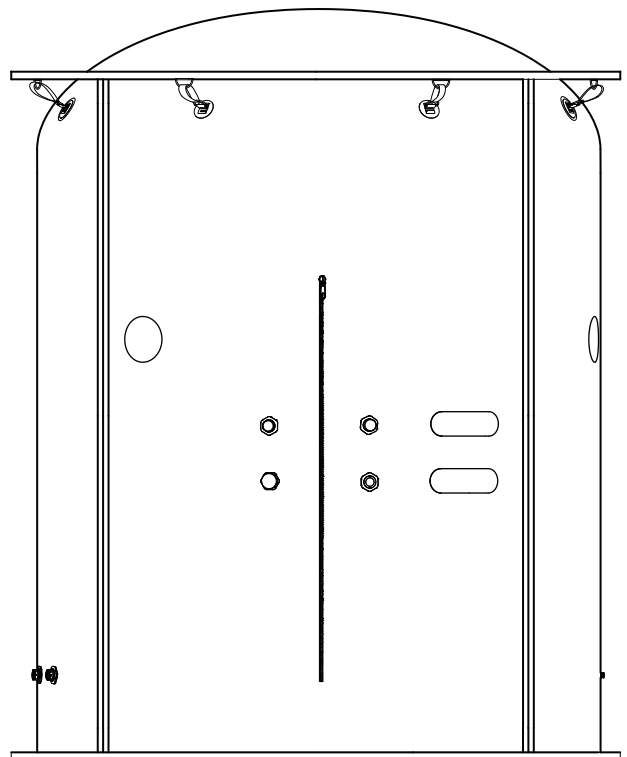

(Assembly complete)



4. External equipment connection: connect the dry air outlet on the air condenser with the air inlet of the cabin. Connect the oxygen outlet on the oxygen concentrator to the oxygen outlet of the cabin

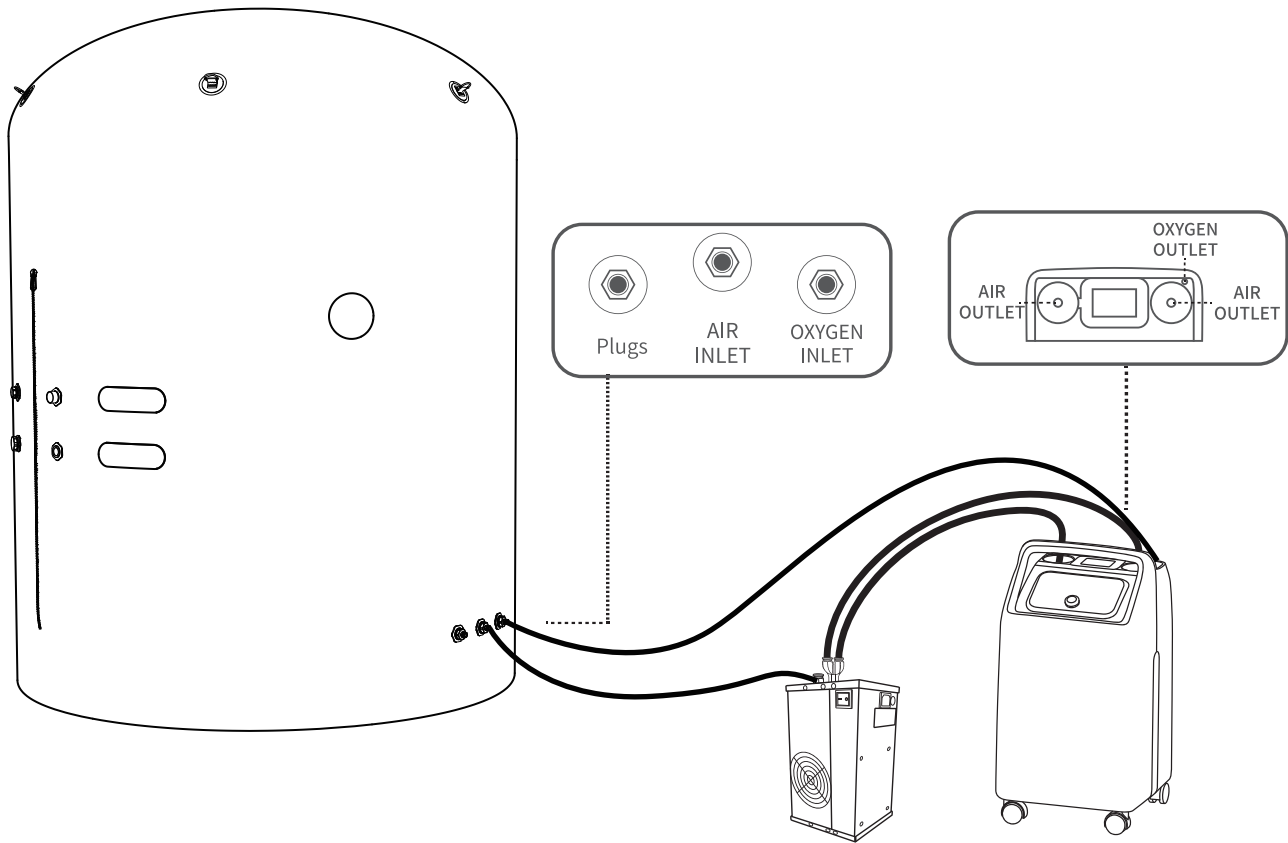

Oxygen	
Voltage	110V
Air flow	130L/minute
Oxygen flow	10L/minute
Power	750W

Air condenser	
Voltage	110V
Air flow	280L/minute
Oxygen flow	0.8mPa
Power	250W

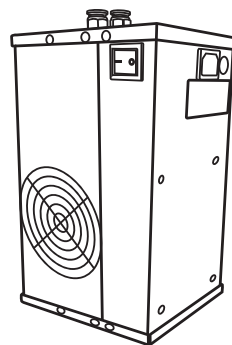
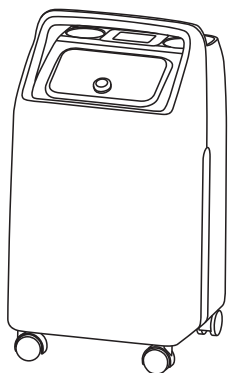

# Use processes

## Step-by-step instructions

1. Enter the cabin: tighten the inner and outer zippers and close the pressure relief valve (make sure to flatten the silicone strip between the zippers).
2. Turn on the machine: turn on the oxygen generator and air condenser.
3. After turning on the machine, put on the oxygen headphones or mask and lie down, after about 8 minutes, the chamber pressure gauge will slowly rise to 30kPa, at which time the automatic pressure relief valve will automatically exhaust.
4. After completing oxygen therapy, open the manual pressure relief valve to reduce the pressure, note: when the pressure is exhausted, you can only open the zipper.
5. When the pressure gauge shows 0kPa, open the zipper and exit the oxygen chamber.
6. After leaving the cabin, turn off the oxygen generator and air cooler

## Notes



1. When using it for the first time, please test the oxygen chamber in an empty situation and observe whether the equipment is operating normally. If the device is not running properly Often, please do not use the oxygen chamber and contact the merchant as soon as possible.
2. If you need to leave the oxygen chamber, you need to wait until the pressure gauge shows 0kPa before opening the inner and outer zippers. During use or When the pressure relief is not completed, the zipper cannot be forcibly opened.
3. In an emergency or when the oxygen generator cannot work normally, open the emergency pressure relief valve from the inside of the cabin to release the pressure. When stressed When it is 0, unzip and leave the oxygen chamber.
4. When using the oxygen chamber for the first time, there will be slight discomfort or pain in the ear. This is a normal phenomenon caused by increased pressure. OK The discomfort is improved by chewing or swallowing, and after a few uses, this phenomenon gradually disappears.

# Use flowcharts

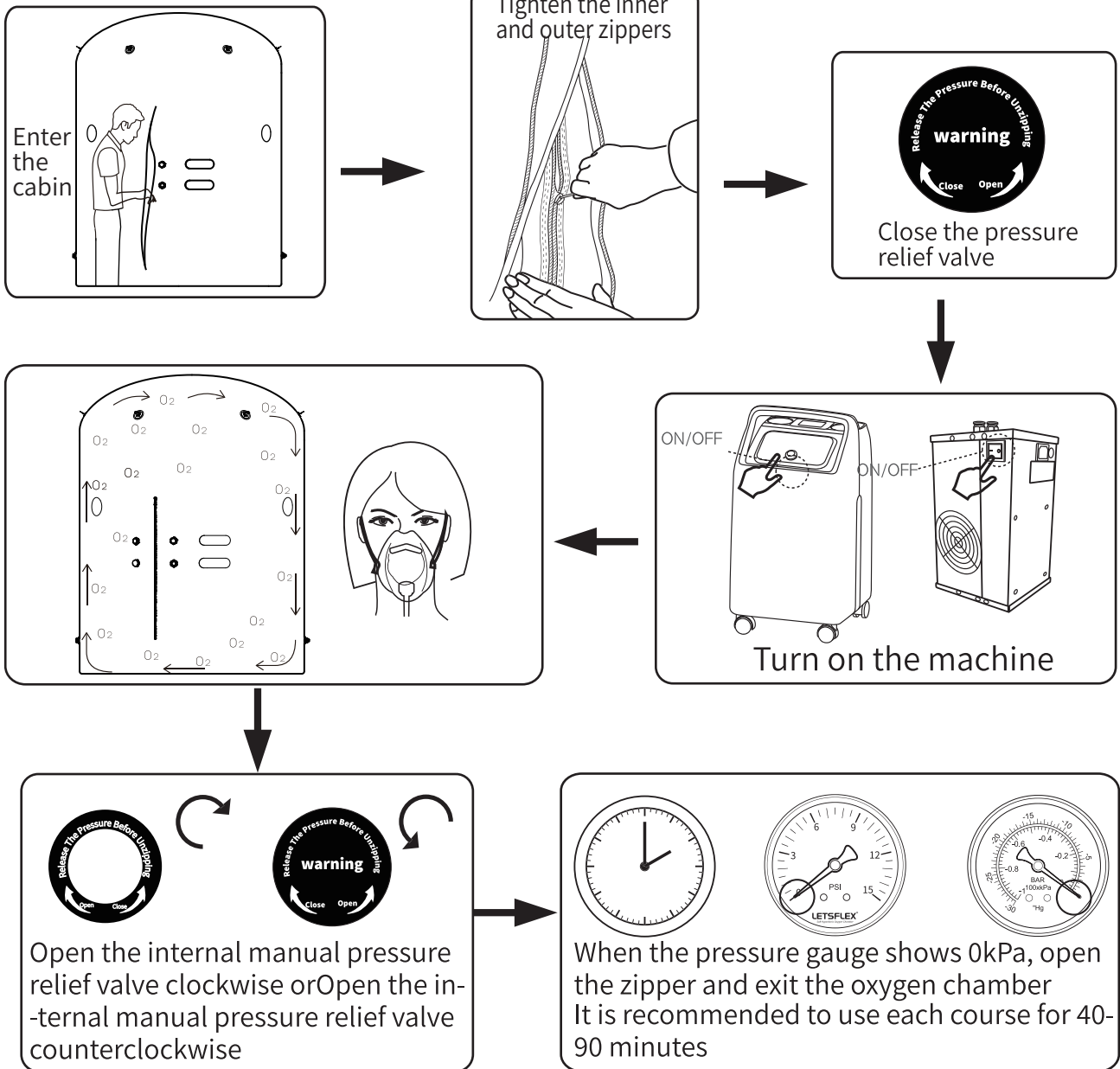

## 6 Frequently asked questions

It is recommended to wear loose and comfortable clothing when entering the oxygen chamber, shoes, jewelry or any other sharp objects Remove before entering the oxygen chamber to avoid scratching the chamber

How should I prepare before entering the oxygen chamber? How long is the right time for each treatment?

Hyperbaric oxygen therapy has positive implications for older adults and children. In fact, new research suggests that hyperbaric oxygen can slow down Cell, apoptosis (cell death), can counteract the signs of aging. Studies on children with brain injuries and genetic disorders show positive results and great promise. We recommend Children under the age of 16 are accompanied by an adult.

Is hyperbaric oxygen therapy good for the elderly, children?

When the cabin is pressurized, your ears will feel the change in pressure in the cabin. To balance the pressure, avoid your ears. There is a feeling of fullness that you need to adapt to by chewing (gum or food), swallowing, or yawning. The process of pressurizing the cabin, your mouth may become dry. When the cabin pressurization is complete, your saliva production will return to normal. The most common side effect is ear discomfort caused by pressure changes. To minimize the risk, patients learn to be pressurized. Promotes adequate emptying of the ears during the process.

How does hyperbaric chamber treatment feel ? Are there any side effects ?

If you use a hyperbaric chamber to improve your health, it is recommended to ask your healthcare practitioner. Portable hyperbaric chambers are great. Easy to use and does not require any supervision or specialized training. The pressure gauge and pressure relief valve in the cabin are standard, pull. The chain is double-sided for quick exit when needed. Our oxygen chambers use indoor pressurized air with an oxygen concentrator (it is safe and non-flammable). But oxygen chambers do not. Should be exposed to any open flame.

Is a doctor's prescription or supervision required to use the oxygen chamber?  
How safe is the oxygen chamber?

# 7 Troubleshooting

If your oxygen chamber is not working properly, please refer to the troubleshooting table on the following pages for possible causes and Workaround. If the issue still doesn't resolve it, contact the merchant.

Trouble	Causes	Solution
Chamber pressurisation very slow	<ol style="list-style-type: none"> <li>1.Air compressor joint or air inlet joint loose or cracked</li> <li>2.Air filters full of dust</li> <li>3.Air inlet on the air compressor is clogged, no smooth intake</li> <li>4.Air compressor screws loose</li> <li>5.Air deflate valve did not tighten up</li> </ol>	<ol style="list-style-type: none"> <li>1.Make sure there are no cracks or loose parts, reinstall the joints</li> <li>2.Replace new filters or clean the dust on the filters</li> <li>3.Clean the air inlet part of the air compressor</li> <li>4.Tighten up the screws on air compressor</li> <li>5.Tighten up the air deflate valve</li> </ol>
Pressure does not go to or hold at proper kPa	<ol style="list-style-type: none"> <li>1.Didn't close the zippers</li> <li>2.Didn't close the air deflate valve or didn't tighten it up</li> <li>3.Air tube does not stick in the connector</li> <li>4.The blue silicon sealing strip between inside and outside zippers is not flat</li> </ol>	<ol style="list-style-type: none"> <li>1.Depressurise the chamber first, then close the zippers and restart</li> <li>2.Make sure no obstructions in the valve holes, then close the valve and tighten it up.</li> <li>3.Ensure the air tube is in the connector</li> <li>4.Make sure the blue sealing strip is flat</li> </ol>
Noisy sound or intense vibration of air compressor	<ol style="list-style-type: none"> <li>1.Air filter is clogged</li> <li>2.Air inlet on the air compressor is clogged, no smooth intake</li> <li>3.Air compressor screws loose</li> </ol>	<ol style="list-style-type: none"> <li>1.Replace the filters</li> <li>2.Clean the air inlet part of the air compressor</li> <li>3.Tighten up the screws on air compressor</li> </ol>
Chamber does not swell at all	<ol style="list-style-type: none"> <li>1.Air tube might have fallen off, air leakage</li> <li>2.Didn't close the air deflate valve or didn't tighten it up</li> <li>3.There is air leakage on air compressor</li> </ol>	<ol style="list-style-type: none"> <li>1.Find out the leakage source, ensure the air tube is in the connector</li> <li>2.Close the valve and tighten it up.</li> <li>3.Reconnect the air tube to the connector of air compressor</li> </ol>
Machine does not run and the display does not light up	<ol style="list-style-type: none"> <li>1.The power cord is not properly plugged into the wall outlet</li> <li>2.No power from the wall outlet</li> <li>3.The circuit breaker of the Air Booster is disconnected</li> </ol>	<ol style="list-style-type: none"> <li>1.Check the connection between the power cord and the wall outlet is firm and in good contact</li> <li>2.Check the circuit breaker at home and restart if necessary. If the same problem occurs again, please use another outlet</li> <li>3.Press the button of the circuit breaker of the Air Booster. If the same problem occurs again, please use another outlet</li> </ol>

1. Chamber maintenance and cleaning: Clean the chamber: After using a deodorizing and antibacterial spray, or after diluting it twice with alcohol, wipe it and let it dry. Set the machine to run for 20 minutes.

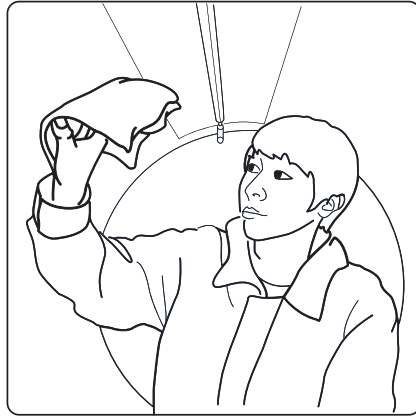

Zipper and pressure reducing valve can be operated inside and outside the cabin

2. The replacement of the intake filter is very important to protect the compressor and molecular sieve and prolong the life of the oxygen rich machine.

Please replace it in time. After 600 hours of normal operation, the indicator on the display interface will light up to remind the user to replace the intake filter, Filters can be purchased at dealers. Note: After replacing the intake filter, long press the "Timing" button for 5 seconds in the standby or startup state to eliminate the indication.

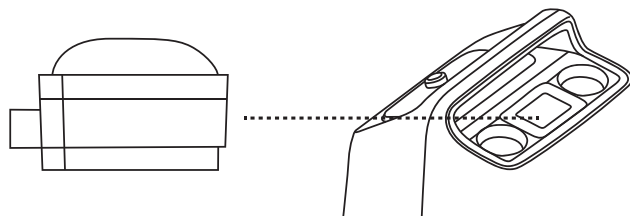

Warning: Do not operate the Air Booster when the intake filter is not installed or wet, which will damage the machine.