

# Hardware 五金

---

Door Hardware-JR System 门五金-JR系统

Door Hardware-LL Series 门五金-LL系列

Hinge 合页

Flat Hinge 平开合页

Joint Hinge 子母合页

Invisible Hinge 隐形合页

Flag Hinge And Hydraulic Hinge 旗型合页和液压合页

Lock 锁

Wooden door lock 木门锁

Metal door lock 金属门锁

Lock body, lock cylinder, lock panel, lock accessories (not a complete set) 锁体、锁芯、锁面板、锁配...

Smart lock, video machine 智能锁、视讯机

Anti-theft lock 防盗锁

Push rod lock, escape lock, sky and earth lock 推杆锁、逃生锁、天地锁

In spring 地弹簧

Pin, door bolt 插销、门栓

Guide rail/pulley 导轨/滑轮

Shake hands 拉手

Long handle长拉手

Hidden handle/other door handles 暗拉手/其他门拉手

## Door Hardware-JR System 门五金-JR系统



BC1741

Lock set FF02-A25 锁



BC1740

Lock set FF02-A23锁



BC2003

Secondary management split stainless steel lock FF811 二级管理分体不锈钢锁



BC1744

1200KG concealed electromagnetic lock 1200KG暗装埋入式剪力锁电磁锁



BC2002

Secondary management split stainless steel lock FF801 二级管理分体不锈钢锁



BC2001

Secondary management split stainless steel lock FF813 二级管理分体不锈钢锁



BC1743

Lock set FF02-A27 锁



BC1742

Lock set FF02-A26锁



FM0885 AR

Lock set FM0885 锁



BCDH-JR16G

Lock set FF02-A16 锁



FM1012 AR

Lock set FM1012 锁

## Door Hardware-LL Series 门五金-LL系列



BCDH-LL0302

Lock set RTH-03+RML-30+RCR-02 分体锁



BCDH-LL680BK

Bath lock 680BK 不锈钢  
卫浴锁



BCDH-LL0107H

Closet handle RPL-01-07 壁橱拉手



BC0036

Lock 锁: 908-129



BC2056

Magnetic lock body  
RTH-03+5572 磁吸锁体

			
<p><b>BC2005</b></p> <p>Handle + magnetic lock RTH-03把手+磁吸锁</p>	<p><b>BCDH-LL48S</b></p> <p>Solid core lock RLH-48 实心锁</p>	<p><b>BCDH-LL48H</b></p> <p>Lock set RLH-48 空心 锁</p>	<p><b>BCDH-LL0355</b></p> <p>Magnetic lock body RTH-03+5572+RCR-01 磁吸锁体</p>
			
<p><b>BCDH-LL50-1</b></p> <p>Sliding door Hook Lock 50SD 移门钩锁</p>	<p><b>BC1470</b></p> <p>Folding door wooden door hardware suit RDA- 117折叠门木门五金套装</p>	<p><b>BCDH-LL106G</b></p> <p>Lock set 909-106 锁</p>	

## Hinge 合页

### Flat Hinge 平开合页



BCDH-LL02-2 Hinge with 4\*3\*3.0-4BB RDH-02, 201 平开合页4\*3\*3.0-4BB



BC1423  
Long row hinge 长排铰链  
长排合页



BC1369  
Hinge with 4\*3\*3.0-4BB  
RDH-01 平开合页  
4\*3\*3.0-4BB



BCDH-LL001  
hinge with locator  
4\*3\*3闭门器定位合页

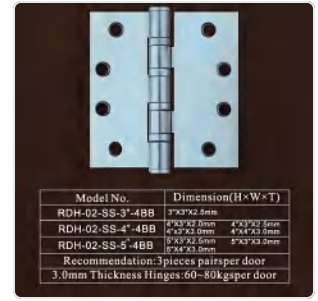

BCDH-LL02-1  
Hinge with 4\*3\*3.0-4BB  
RDH-02, 304 平开合页  
4\*3\*3.0-4BB



BC2164  
Hinge with 4\*3\*2.55 201  
平开合页4\*3\*2.55



BC2145  
Hinge with 4.5\*4\*3.0  
美标304平开合页  
4.5\*4\*3.0

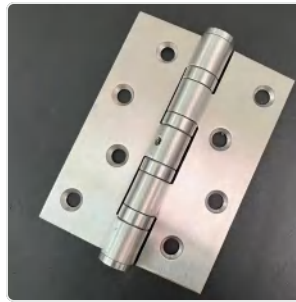

BC2122  
Four-axis casement  
hinge 四转轴平开合页



BC2138  
Hinge with 4\*3\*3.0-4BB  
RDH-01, 304平开合页  
4\*3\*3.0-4BB



BC2085

Hinge 欧式庭院篱笆合页



BC2086

Hinge 欧式庭院篱笆合页



BCDH-LL01-2

Hinge with 4\*3\*3.0-4BB  
RDH-01, 304平开合页  
4\*3\*3.0-4BB

## Joint Hinge 子母合页



BC2089

Joint Hinge 子母合页



BC1671

Joint Hinge 子母合页



BC1464

Hinges 合页



RDH-15-1

Hinge with 4\*3\*2.5mm  
RDH-15 子母合页  
4\*3\*2.5mm



RDH-15-2

Hinge with 4\*3\*3  
(102x74.5x2.5mm)  
RDH-15 子母合页4\*3\*3  
(102x74.5x2.5mm)



BC0133

Joint Hinge 子母合页



BC1840

Hinge RDH-15子母合页



BC1599

Thickened stainless steel  
joint hinge 4寸加厚不锈  
钢子母合页、平开合页



RDH-15-3

Hinge with 4\*3\*3mm

RDH-15 子母合页

4\*3\*3mm

## Invisible Hinge 隐形合页



BCDH-LL003

Narrow invisible (hidden) hinge 窄门框暗绞 三维可调节



BCDH-LL004

Narrow invisible (hidden) hinge 窄门框暗绞 三维可调节



BC0191

Invisible (hidden) hinge RCH-09 三维可调节隐形合页



BCDH-LL08

Invisible (hidden) hinge RCH-08 三维可调节隐形合页



RCH-01

Invisible hinge 暗铰



RCH-04

Invisible hinge 暗铰



RCH-10

3D adjustable invisible hinge 三维可调隐形合页



BC0035

Special big invisible hinge 超大隐形合页



RCH-40

Invisible (hidden) hinge 三维可调节隐形合页



BC1980

Invisible (hidden) hinge RCH-200R 三维可调节隐形合页



BC0034

Invisible hinges RCH-08 合页



G40

Invisible (hidden) hinge 三维可调节隐形合页



RCH-60

Invisible (hidden) adjustable hinge 三维可调节隐形合页



BC-T001

Invisible hinge T001 合页



BC2075

Invisible spring hinge 隐形弹簧合页



BC2028

3D adjustable hidden self-closing page YY80- 三维可调暗藏式自闭合页



 <p>RCH-101</p> <p>Narrow 3D Adjust Invisible Hinges 窄门框暗 门铰合页</p>	 <p>BCDH-LL80G</p> <p>Invisible (hidden) hinge G80 三维可调节隐形合页</p>	 <p>BC1964</p> <p>Invisible (hidden) hinge G120 三维可调节隐形合页</p>	
---	---	---	--

## Flag Hinge And Hydraulic Hinge 旗型合页和液压合页

 <p>BCDH-LL07-1</p> <p>Flag hinge 4*3*2.5 RDH-07 4*3*2.5-12, 轴 承旗形铰</p>	 <p>BCDH-LL07-2</p> <p>Flag hinge 5*4*3 RDH- 07 5*4*3.0mm旗形铰, 轴承直径18mm</p>	 <p>BC1685</p> <p>Stainless steel door hinges 不锈钢旗形合页</p>	 <p>BCDH-LL002</p> <p>Hinge with spring 4*3*3 弹簧合页 自动闭门合页</p>
---	--	--	---

## Lock 锁

### Wooden door lock 木门锁



QS-ET

Room lock QS-ET 室内钥匙款



BCDH-JR9925S

Lock set FT9925 锁



BC2124

Spherical lock 球型锁



BC2076

Magnetic lock body + BK lock 磁吸锁体+BK锁



BC2055

Magnetic lock body RST-07+5572 磁吸锁体



BC2013

Single side lock RDA-32F 单面锁



BC1979

Single tongue stainless steel lock 5572ZR+R  
CR-01 70单开圆形匙孔盖锁



BC1888

Lock set 锁



BC1882

Single tongue stainless steel lock 单舌不锈钢锁



BC1829

Bathroom door lock (without key) 卫浴锁 (无钥匙)



BC1731

Bathroom indicator lock RTH-03+RML-16+RDA-46+50 卫生间指示锁



BC1722

304 stainless steel push down buffer rebound right angle panel handle lock RPM-01-07 304不锈钢下压缓冲回弹直角面板执手锁

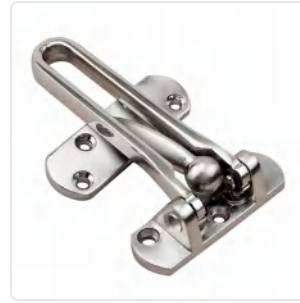

BC1715

Hotel anti-theft buckle thickened door bolt RDA-16防盗扣酒店宾馆保险栓防盗链加厚安全扣锌合金门扣门栓



BC1720

280 kg single door surface mounted magnetic lock 280公斤单门明装磁力锁



BC1572

Lock set 锁



BC1570

Privacy lock 隐私锁 (卫  
浴门锁)



BC1569

Aisle lock (passage lock)  
通道锁



BC1596

Aluminum Oxide  
Aluminum Oxide Black  
Split Lock BC30-12 氧  
化铝黑色分体锁



BCDH-JR11S

Lock set FF02-A11 锁



BC1465

Spherical lock 球型锁



BC1463

Lock set 锁



BCDH-LL5572L

Aisle lock RPL-01-  
07+5572ZL 走廊通道锁



BCDH-LL557202

Bath lock RPL-01-07+5572+RCR-02 卫浴锁



BC1467

Heavy duty three-pole lock (without key) 重型三杆锁(不带钥匙)



BCDH-LL0301

Lock set RTH-03+RML-30+RCR-01 分体锁



BCDH-LL0755

Magnetic lock body RST-07+5572+RCR-01 磁吸锁体



BCDH-LL0728

Lock set RST-07+RML-28 锁



BCDH-LL0107

Lock set RPL-01-07+RML-07+RCR-01



BCDH-LL0713

Lock set RST-07+RML-13-5572+RCR-01 锁



BCDH-LL1713

Lock set RST-17+RML-13-5572+RCR-01 锁



BC0170

Lock set (Fire prevention) 锁 (防火)



BCDH-JR21S

Lock set FF02-A21 锁

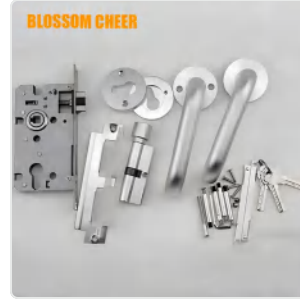

BCDH-JR01S

Lock set FF02-A01 锁



BC0139

Lock set FF02-A11 锁



BCDH-JR32S

Lock set FF02-A32 锁



BCDH-JR1101S

Lock set FT1101 锁



BC1924

Unlabeled neutral hotel only sensor lock K3002-5 SS /SB 无标中性酒店用只能感应锁

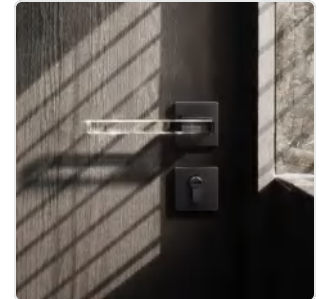

BC1724

Simple light luxury crystal door lock 7286-225W 简约轻奢水晶门锁



BCDH-JR11G

Lock set FF02-A11 锁



BCDH-JR99G

Lock set FF02-A99 锁



BC2177

Zinc alloy retro door lock  
锌合金复古门锁



BC1721

Stainless steel indicator  
lock RDA-46+50+RML-  
29 不锈钢商场酒店厕所门  
锁红绿指示锁



BC1546

Double door heavy duty  
three-pole lock (with  
key) 双开门重型三杆锁(带  
钥匙)

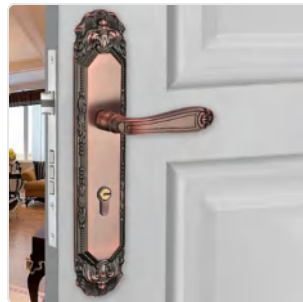

BC1881

Lock set 611-68门锁

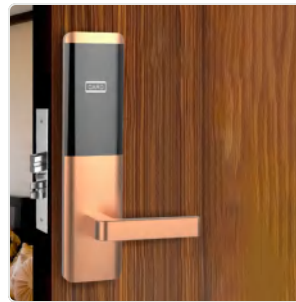

BC1930

Lock 酒店锁



BC1983

Zinc alloy Italian simple  
ecological door lock 93-  
918 锌合金意式简约生态  
门锁



BC1466

Heavy duty three-pole lock (with key) 重型三杆锁(带钥匙)



BC1736

Lock set FF02-A22 锁



BC1967

Aluminum alloy magnetic silent door lock 72-33# 铝合金磁吸静音门锁



BC2078

Tubular lockset 3503BK 铝合金三杆锁



BC1713

Modern Style Lock BK Type 现代锁体BK无钥匙版



909-150

Modern high end lock 现代高端锁

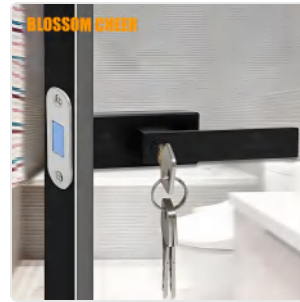

BC2029

Lock set 41# 59# 极窄平开玻璃门锁



BC2012

Lock set RST-17+RML-13+RCR-01 锁





BC1998

RHL-02 zinc alloy  
handle single-sided  
indoor invisible door lock  
RHL-02 锌合金拉手单面  
室内隐形门锁



BC1929

Lock 酒店锁

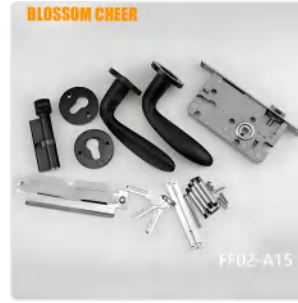

BC1823

Lock set FF02-A15 锁



BC1735

Lock set FF02-A99 锁  
双重氧化处理

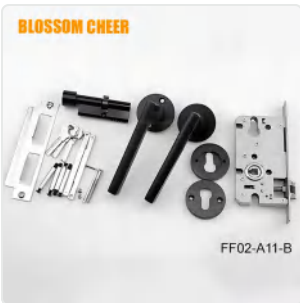

BC1734

Lock set FF02-A11-B 锁  
双重氧化处理



BC1600

Aluminum Oxide  
Aluminum Oxide Black  
Split Lock BC30-12 氧  
化铝黑色分体锁

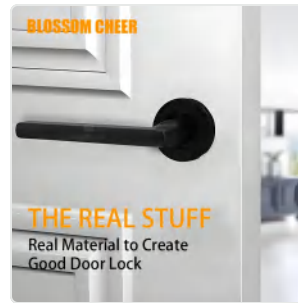

BC1568

Single Dummy function  
(only lock handle) 假锁  
把手



BC1544

Heavy duty three-pole  
lock (with key) 重型三杆  
锁(带钥匙)



BC1543

Double door heavy duty three-pole lock (with key) 双开门重型三杆锁(带钥匙)

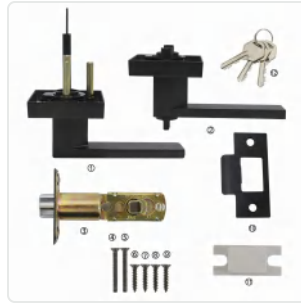

BC1536

Heavy duty three-pole lock (without key) 重型三杆锁(不带钥匙)



BC1505

Magnetic lock body RST-07+5572+RCR-01 磁吸锁体



BCDH-LL3503BK-2

Tubular lockset 3503BK 三杆锁



BCDH-LL3503ET-2

Tubular lockset 3503BK 三杆锁

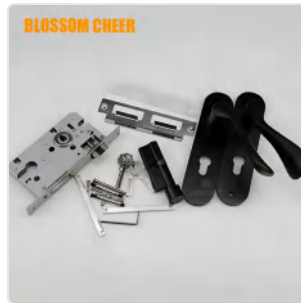

BCDH-JR9925B

Lock set FT9925 锁



BCDH-JR1101B

Lock set FT1101 锁

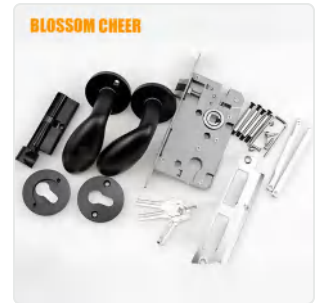

BCDH-JR21B

Lock set FF02-A21 锁



BCDH-LL106B

Lock set 909-106 锁

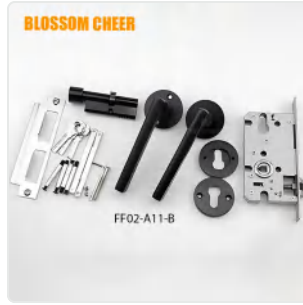

BC0137

Lock set FF02-A11-B 锁

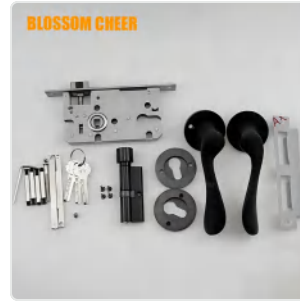

BCDH-JR99B

Lock set FF02-A99 锁



BCDH-JR15B

Lock set FF02-A15 锁

## Metal door lock 金属门锁



BC1824

Stainless steel lock handle with panel  
HW008A/12S不锈钢装甲锁面板与把手 (304不锈钢标配锁)



BC2208

Entrance door anti-theft lock 入户门防盗锁

# Lock body, lock cylinder, lock panel, lock accessories (not a complete set) 锁体、锁芯、锁面板、锁配件 (非整套)



BC2097

Anti-theft lock panel handle 防盗锁面板把手

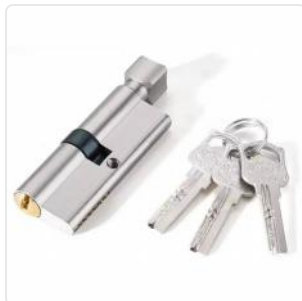

BC2004

Lock core + key FF02-A01 锁芯+钥匙



BC1997

Door holder 门碰珠



BC1966

Handl 把手



BC1827

6068 Great Overlord  
anti-theft lock body  
6068大霸王防盗锁体

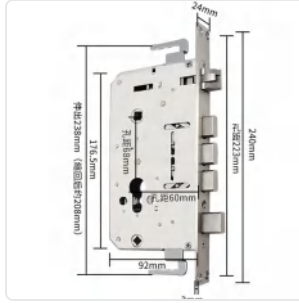

BC1826

6068 Ordinary national  
standard anti-theft lock  
body 6068普通国标防盗  
锁体+锁芯+钥匙



BC1712

Modern Style Lock 现  
代款锁体



BCDH-LL03-3

BK lock cylinder RCR-03  
BK单开锁芯无钥匙

## Smart lock, video machine 智能锁、视讯机



BC1955

Intelligent video system  
智能视频系统

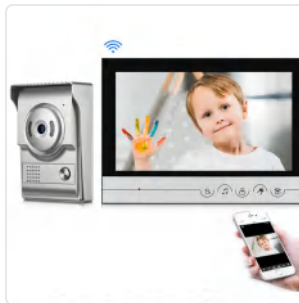

BC1952

Intelligent APP video  
intercom system 智能  
APP视频对讲系统



BC1950

Intelligent APP video  
intercom system 智能  
APP视频对讲系统



BC1948

VDP Intelligent video  
system VDP智能视频系  
统



BC1947

VDP Smart Lock VDP智能视频系统



BCDH-LL305

Smart lock SFL-305 智能锁



BC1737

Small lock with single tongue lock body T8 小单舌锁体智能锁

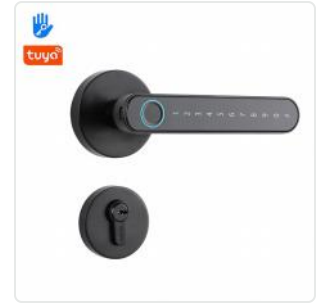

BC1738

T6 Small lock with single tongue lock body T6 小单舌锁体智能锁



BC2069

B3 Electronic locks B3 全自动电子锁



BC1956

Smart door lock for use with VDP system 配合VDP系统使用的智能门锁



BC1934

Short handle broken bridge aluminum slender smart lock 小拉手断桥铝细长智能锁



BC1798

Short handle broken bridge aluminum slender smart lock E-H103-SN 小拉手断桥铝细长智能锁



BC1739

E513 Small lock E513智能锁



BC1534

Short handle fingerprint lock E-H103 矮把手指纹锁



BC1527

4.5 inch Large Screen Smart 3D Face Recognition Lock ER20 工程款4.5寸大屏智能锁智能3D人脸识别锁



330





Smart lock 330智能锁

 <p>黑色 BLACK 红古铜 RED BRONZE</p>		 <p><b>E5 MAX</b> 3D FACE RECOGNITION 9 IN 1 FUNCTION</p> <ul style="list-style-type: none"> <li>• Fingerprint</li> <li>• Password</li> <li>• M1 Card</li> <li>• Mechanical keys</li> <li>• App</li> <li>• 3D FACE</li> <li>• Cat eye</li> <li>• smart door bell</li> </ul> <p>Support with</p>	
<p>BC-E29</p> <p>Smart Fingerprint Password Lock</p> <p>Operating Lock E29智能 指纹密码锁操作锁</p>	<p>BC1933</p> <p>Short handle broken bridge aluminum slender smart lock E-H105 -SN 银色小拉手断桥铝细长智 能锁</p>	<p>BC1526</p> <p>E5 3D face recognition smart lock E5 智能3D 人脸识别锁</p>	<p>BCDH-LL317</p> <p>Smart lock SFL-317 智 能锁</p>





## Anti-theft lock 防盗锁

			
<p>BCDH-LL0101 Security lock</p>	<p>RXL-01-01 防盗门锁</p>	<p>RXL-01-01 Anti-theft safety door lock</p>	<p>防盗门锁</p>

## Push rod lock, escape lock, sky and earth lock 推杆锁、逃生锁、天地锁

			
<p>BC2107</p> <p>Press-down fire escape channel push rod lock</p> <p>RDA-32F 下压式消防逃生通道推杆锁+防火锁</p>	<p>RDA-32N-3</p> <p>Two-point locking open-fitting heaven and earth bolt type push bar type escape lock</p> <p>RDA-32N 两点锁定 明装 天地插销型推杠式逃生锁</p>	<p>BCDH-LL32SS</p> <p>Escape lock RDA-32CN 天地锁</p>	<p>RDA-32CN-1</p> <p>Single-point locking open-mounted push bar escape lock</p> <p>RDA-32CN单点锁定 明装 推杠逃生锁</p>

## In spring 地弹簧

			
<p>BC2150</p> <p>Pivot door floor hinges</p> <p>250-300KG缓冲液压地弹簧</p>	<p>BC1540</p> <p>Pivot door floor hinges</p> <p>120-150kgGCA-33 地弹簧</p>	<p>S-2400</p> <p>Crown brand pivot door heavy duty ground spring hinges</p> <p>180KG皇冠牌旋转门重型地弹簧</p>	<p>G-322</p> <p>Crown brand pivot door ground spring hinges</p> <p>130KG皇冠牌旋转门地弹簧</p>

## Pin, door bolt 插销、门栓





BC2087

304 Stainless steel bolt  
304不锈钢螺栓



BC2088

304 Stainless steel Ground plug  
304不锈钢接地插头



BC1716

304 stainless steel square solid thickened anti-theft anti-rust bolt  
surface mounted door bolt  
304不锈钢方形实心加厚防盗防锈插销明装门栓



BC-681012

Door bolt 钢芯暗插销  
天地插销防火门加厚门栓  
不锈钢插销防盗插销



RDA-23

12 Inch Door bolt  
12寸暗插销



RDA-22

Door bolt  
10寸暗插销



RDA-21

Door bolt  
8寸暗插销

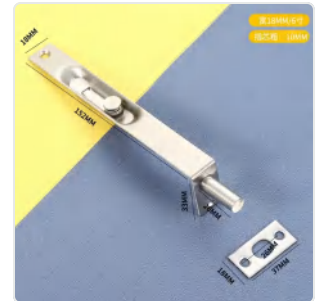

RDA-20

Door bolt  
6寸暗插销

## Guide rail/pulley 导轨/滑轮

BLOSSOM CHEER



BC1814

HL-041 Invisible Wheel Rail HL-041 幽灵门导轨 标配1.2米



HL-041

HL-041 Invisible Wheel Rail HL-041 幽灵门导轨 标配1.2米



BC1554

Hanging wheel 吊轮滑轮



BC1552

Hanging rail QH-1289 适合联动门的吊导轨



BC1903

Synchronized soft close sliding system for 3 doors HL-074 三门同步同向联动阻尼滑轮



HL-089A-02

Synchronized soft close sliding system for 2 doors 两门同步同向联动阻尼滑轮



BC1555

Hanging rail G09-1 吊导轨







BC0000









Barn Door Hardware sliding barn door roller HL-066-2M套装 谷仓门五金整套

## Shake hands 拉手

## Long handle长拉手

			
<p><b>BC1914</b></p> <p>2m length square long handle 2米长方拉手</p>	<p><b>BC1877</b></p> <p>2.2m stainless steel long handle 2.2米长的中砂门拉手</p>	<p><b>BCDG-TG011-10</b></p> <p>1.0m length square long handle 1.0米长方拉手</p>	<p><b>BCDG-TG011-T18</b></p> <p>1.8m stainless steel long handle 1.8米长的中砂门拉手</p>

## Hidden handle/other door handles 暗拉手/其他门拉手

			
<p><b>BC1906</b></p> <p>Sliding door round handle 推拉门圆拉手</p>	<p><b>BCDH-LL22</b></p> <p>Round handle RTH-22 不锈钢空心圆形拉手</p>	<p><b>BCDH-LL606N</b></p> <p>Invisible (hidden) handle RSL-606DM 暗拉手</p>	<p><b>BCDH-LL607ND</b></p> <p>Invisible (hidden) handle RSL-607DM 暗拉手</p>
			
<p><b>BCDH-LL607N</b></p> <p>Sliding door lock RSL-607ET 移门锁</p>	<p><b>BCDH-LL5057</b></p> <p>Sliding door lock 50SD+RDA-57B+RCR-01 移门锁 钩锁</p>	<p><b>BCDH-LL604BK</b></p> <p>Sliding door lock RSL-604BK 移门锁</p>	<p><b>BC1588</b></p> <p>Sliding door lock 160*45 移门拉手</p>