



# Universal Square Photoelectric Sensor EGF43 Series

## Product Features

- Unaffected by target color and background color, objects can be detected accurately;
- High precision, small differential distance, can detect small step difference;
- Anti-interference, can also resist variable frequency fluorescent lamps based on unique external interference light avoidance algorithm;
- The beam is not visible on the object, but the light spot is visible.



## Product Specifications

Appearance				
Type		Diffuse reflection	Specular reflection	Through-beam
Model	NPN output	EGF43-15N-ZAA	EGF43-02N-ZCA	EGFL42-10N-ZBA
	PNP output	EGF43-15P-ZAA	EGF43-02P-ZCA	EGFL42-10P-ZBA
Output action		ON OFF switchable	ON OFF switchable	ON OFF switchable
Detection object		100*100mm white drawing paper	Objects with a diameter of ≥5mm	Opaque objects with a diameter of ≥12mm
Detection distance		<b>30-150mm (adjustable)</b>	<b>2M</b>	<b>10M</b>
Dysfunction		20% or less of the detection distance	-	-
Current consumption		≤25mA or less	≤45mA or less	≤45mA
No-load current		9mA	9mA	Reflection 11mA, reception 9mA
Leakage current			Less than 0.01mA	
Dimensions			32*23*12(mm)	
Light source			Visible LED red light	Laser
Power supply voltage			DC12-24V	
Voltage drop			1V	
Control output		Load power supply current 100mA or less (residual voltage 1V or less)		
Protection circuit		Surge protection circuit, short circuit protection, reverse polarity protection		
Response time		Action/recovery 1.0ms or less each		
Display light		Green power indicator, red signal indicator		
Ambient temperature		Action: -25~+55°C (no icing, no condensation) Storage: -40°C~70°C (no icing, no condensation)		
Ambient illumination		Daylight: 10,000LX or less Incandescent lamp: 3,000LX or less		
Ambient humidity		Action: -45%~85% (no icing, no condensation); Hold: -35%~95% (no icing, no condensation)		
Voltage influence		When the rated power supply voltage fluctuates within ±15%, the detection distance remains within ±1%		
Insulation barrier		More than 20Mu (DC500 megohmmeter) between the charging part and the shell		
Dielectric strength		More than AC1000V at 50/60Hz 1min between charging part and shell		
Vibration (durability)		10~55Hz, 1.5mm double amplitude, 2 hours in X,Y,Z direction		
Impact (durability)		500m/S <sup>2</sup> , 10 times in X, Y, Z axis direction		
Protective structure		IP65		
Connection method		Wire lead type (standard wire length 2m)		
Casing material		PC		

## Input/Output Circuit

### ● Diffuse

#### ■ NPN output

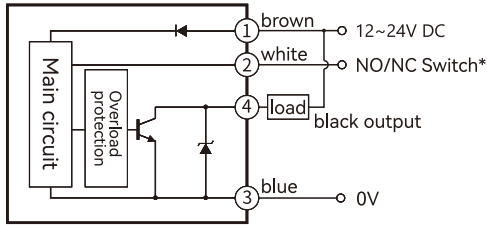

\*NO white --- suspended, NC white --- 0V

#### ■ PNP output

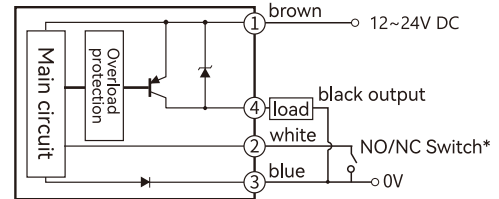

\*NO white --- suspended, NC white --- 0V

### ● Through-beam

#### Transmitter

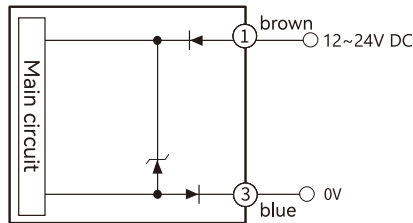

#### Receiver

##### NPN type

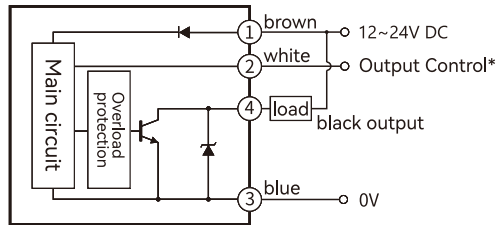

\*NO white --- 0V, NC white --- suspended

##### PNP type

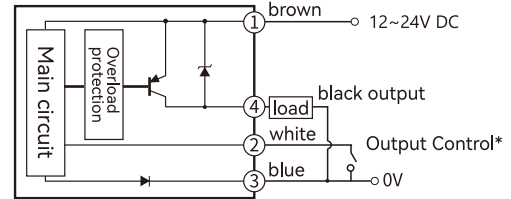

\*NO white --- 0V, NC white --- suspended

## Product Specifications

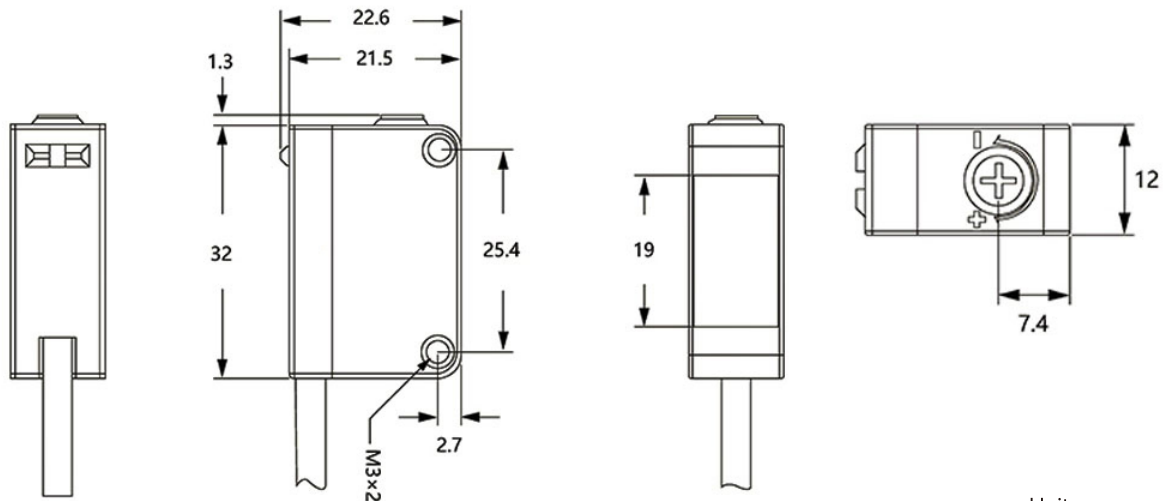

Unit: mm