



ELS-A Series Safety Relay

Maximum compliance with ISO13849-1 PLe standard and IEC 62061 SiL3 standard

Proven two-channel security monitoring circuit design

I/O LED indication

Width 22.5mm to reduce installation space

Screw or spring terminals are available for a wider range of applications

PLC signal output

Suitable for monitoring

Scram button	Safety light curtain	Two-handed switch
Safety switch	Security scanner	Safety sensor
Safety lock		

Forced safety output

3NO / 1NC

Applicable to the industry

Injection molding machine	CNC machine press/
Hydraulic press	Glass machinery
Filling machinery	Woodworking machinery
Packaging machinery	sorting machinery
Paper machinery	intelligent
Forklift	AGV
Robot	Elevator wind power
SIS system	



Board description

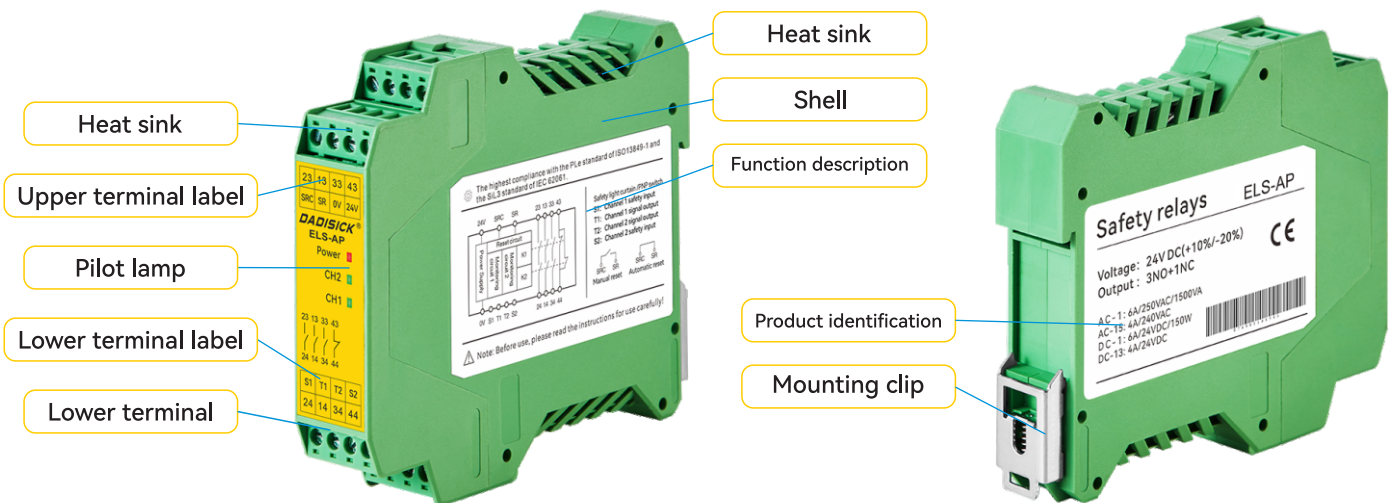

100%

Strictly select first tier brand components and conduct 100% process testing

3 aspects

The core mandatory relay adopts well-known products certified by third-party authoritative organizations to ensure high reliability

comprehensive

Fully functional for easy control of various applications

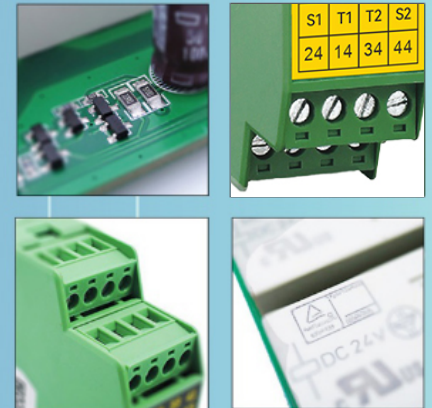

Extreme speed

Adopting high-speed mutual verification technology to ensure safe and efficient response time

Dual path

Using a dual channel classic design, it fully meets the functional safety requirements of ISO 13849 and GB 16855

40%

Save you 40% of costs



Technical Parameters

Safety Relay Product model		
Safety relay series	ELS-A	
Model	ELS-AN	ELS-AP
Category	NPN	PNP
Power source		
Power supply	24V DC	
Voltage tolerance	+10%/-20%	
Power dissipation	2.9W	
Output		
Relay safety output	3NO+1NC	
Transistor signal output	<500mA 24VDC	
Relay contact capacity		
AC-1	6A/250VAC/1500VA	
AC-15	4A/240VAC	
DC-1	6A/24VDC /150W	
DC-13	4A/24VDC	
Maximum switching capacity	12A (Distributed on all safety output contacts)	
Contact resistance	<100mΩ	
Minimum load	10mA/5V	
Contact material	AgSnO ₂ + 0.2μmAu	
Conventional parameter		
Output fuse (external connection)	5A gL/gG	
Release response time	<30ms (From input to output)	
Input component tail detection resistance (Edge/Carpet)	1kΩ ~ 10kΩ	
Electrical life	80000 times	
Pollution degree	2	
operation temperature	-25°C ~ 85°C	
Working humidity	35%-85% (No ice or condensation)	
Impulse withstand voltage	2.5kV	
Protection grade	Housing IP30, terminal IP20, recommended for installation in cabinet or housing Ip54	
Storage temperature	-40°C ~ 105°C	
Shell material	Flame retardant PA66	
Installation method	Standard 35mm DIN rail/spring clip	
Size	112mm×99.5mm×22.6mm	
Weight	172g	
Connection parameters		
Available cross-sectional range of rigid wires	0.5~2.5mm ²	
Available cross-sectional range of flexible wires	0.5~2.5mm ²	
Minimum conductor cross-section	AWG 24	
Maximum conductor cross-section	AWG 12	
Strip length	8mm	
Minimum tightening torque	0.5 Nm	
Maximum tightening torque	0.6 Nm	

ELS-A Series Safety Relay

Safety force disconnect type relay output

3 normally open transient safety contacts (3NO)

1 normally closed transient safety contact (1NC)

LED indicator

Power supply indication

Input status indication

Output status indication

Automatic reset switch

Automatic/manual reset switch can be configured

Can be configured for emergency stops, light curtains, door locks, two-hand switches and many other functional safety features

In the event of component failure, the safety function remains in effect

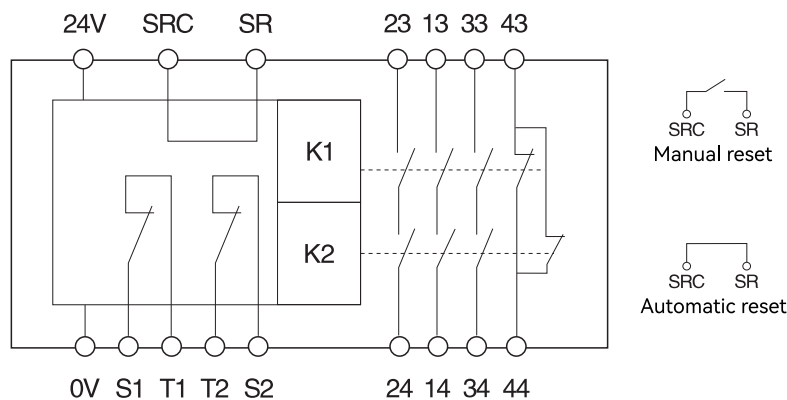

Description of terminal functions

Power supply	Power supply positive (24VDC)	
	Power supply negative (0V)	
S1	Channel 1 safety input	Accept type I signal input, open circuit detection and channel 2 mutual detection
T1	Channel 1 signal output	Type I signal source
T2	Channel 2 signal output	Type II signal source
S2	Channel 2 safety input	Type II signal input is accepted, open circuit detection and channel 1 mutual detection
SR SRC	Reset input (configurable manual reset or automatic reset)	Short-circuited SRS and SRC reset automatically, and disconnected SRS and SRC reset manually
13/14	Normally open transient safety contact	To increase the number of contacts
23/24		
33/34		
43/44	Normally closed transient safety contact	Can be used as external signal light or control other devices

LED and reset lever operation instructions

LED indicator status

■ Steady on ★ ☆ Flicker □ Extinguish				
Feature	Status	Power LED	Input LED	Output LED
Emergency stop/door lock	The input connection is disconnected or abnormal	■	★ ☆	□
	The input single channel is abnormal	■	■	★ ☆
	Emergency stop press/Door lock opens	■	★ ☆	□
	Input is correct/not reset	■	■	□
	Input is correct/reset	■	■	■
	System failure	★ ☆	□	□
Light curtain /PNP switch	The input connection is disconnected or abnormal	■	★ ☆	□
	The input single channel is abnormal	■	■	★ ☆
	Light curtain interrupted/switch action	■	★ ☆	□
	Input is correct/not reset	■	■	□
	Input is correct/reset	■	■	■
	System failure	★ ☆	□	□
Two-handed switch (Valid for automatic reset only)	The input connection is disconnected or abnormal	■	★ ☆	□
	Press the two-handed switch	■	■	■
	Two-handed switch release	■	★ ☆	□
	System failure	★ ☆	□	□

Connection sample

1. Emergency Stop

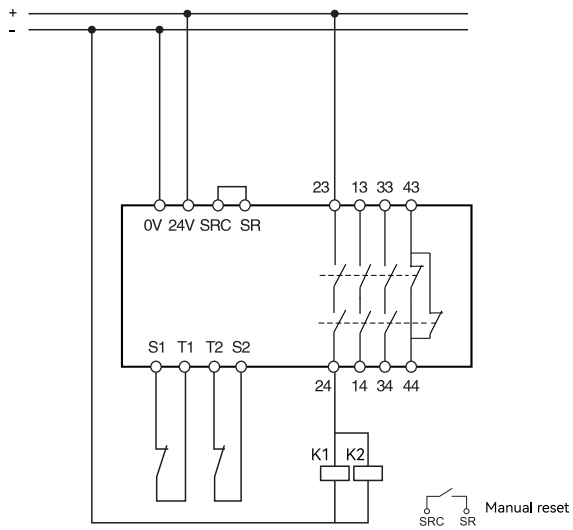

Dual-channel scram safety input with manual reset

2. Safety Interlock Switch

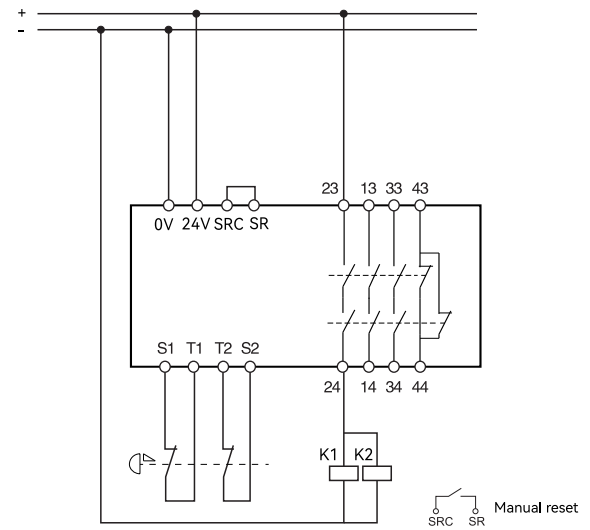

3. Connect the safety light curtain

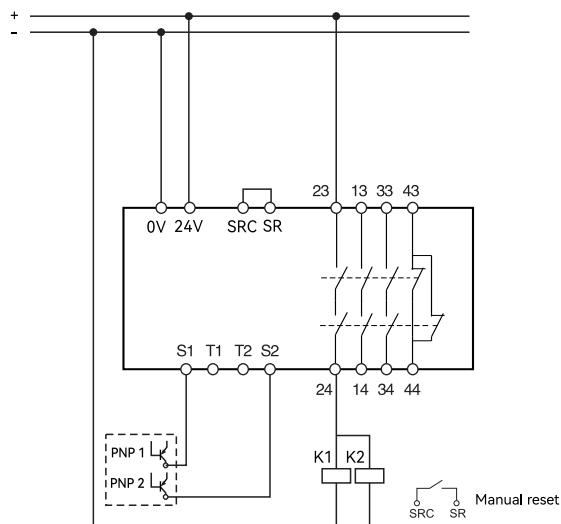

Dual channel light curtain /PNP switch safety input, with automatic reset, PLC signal output

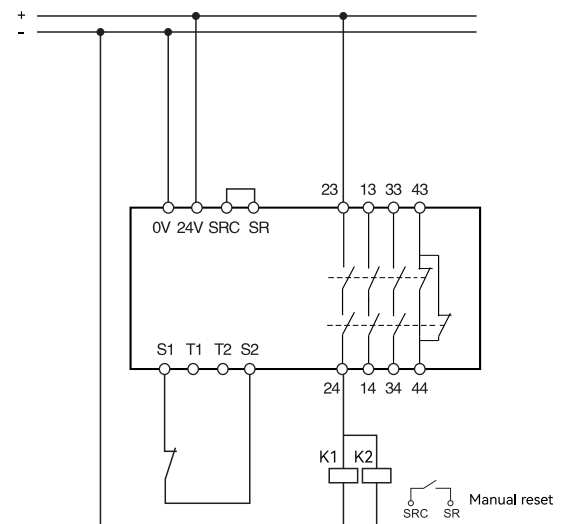

Single channel light curtain/PNP switch safety input, With automatic reset and PLC signal output

Overall dimensions

