

Quick User Manual

TOF LiDAR

2D 270 ° 5 meter and 20 meter mini LiDAR



Inductive sensor

TOF LiDAR monitors the range specified by the user, and when an object enters the range, the radar alerts the main control equipment

- EU Directives
 - machinery directive2006/42/EC
 - EMC Directive 2014/108/EC
- International standard
 - IEC 61496-1:2020 (Type 3 ESPE)
 - IEC 61496-3:2018 (Type 3 AOPDDR)
 - IEC 61508-1-7:2010 (SIL 2)
 - EN ISO 13849-1:2015 (Cat. 3:PL d)
 - EN ISO 13849-2:2012 (Cat. 3:PL d)
 - EN 61326-1:2013
 - EN 60825-1:2014 (Class 1 laser products)
 - EN 61000-4-2:2009
 - EN 61000-4-3:2006+A1:2009+A2:2010
 - EN 61000-4-4:2004+A1:2010
 - EN 61000-4-6:2009
 - EN 61000-4-8:2010
 - EN 61000-4-11:2004
- GB standard
 - GB/T 4208



Copyright(C)202408-10

6. Region selection

The TOF radar region selection supports 16 region groups, and users can select the current working region group through a combination of input signals to switch between region groups. The relationship between regional groups and input signals is shown in the table below:

Regional group	Input4	Input3	Input2	Input1
Regional group1	0	0	0	0
Regional group2	0	0	0	1
Regional group3	0	0	0	0
Regional group4	0	0	0	1
Regional group5	0	1	1	0
Regional group6	0	1	1	1
Regional group7	0	1	1	0
Regional group8	0	1	1	1
Regional group9	1	0	0	0
Regional group10	1	0	0	1
Regional group11	1	0	0	0
Regional group12	1	0	0	1
Regional group13	1	1	1	0
Regional group14	1	1	1	1
Regional group15	1	1	1	0
Regional group16	1	1	1	1

Note: 1. The input signal is suspended and enabled, with a value of "1". 2. If the input ground is not enabled, the value is "0"

7. Intrusion alarm

When TOF radar detects an object invading the working area, it sends an alarm through an output signal and LED [1-3] light. Refer to the table for its relationship

Intrusion detection			OUTPUT			Pilot lamp		
Zone 1	Zone 2	Zone 3	Output1	Output2	Output3	LED1	LED2	LED3
0	0	0	0	0	0	OFF	OFF	OFF
1	0	0	1	0	0	ON	OFF	OFF
0	1	0	0	1	0	OFF	ON	OFF
1	1	0	1	1	0	ON	ON	OFF
0	0	1	0	0	1	OFF	OFF	ON
1	0	1	1	0	1	ON	OFF	ON
0	1	1	0	1	1	OFF	ON	On
1	1	1	1	1	1	ON	ON	ON

- Note:
- The area is '1', indicating that there is an intrusion of objects in this area; It is "0", indicating no intrusion phenomenon.
 - Output value of "1" indicates that the output signal indicates an object intrusion; 0 indicates no intrusion.
 - "ON" indicates that the LED light is on, and "OFF" indicates that the LED light is off.

1. Safety instructions

- General safety summary:
- Please carefully read the following safety precautions to avoid damaging this product or other products connected to it.
 - Use specified power cords: Only power cords recognized by the country in which they are located are allowed;
 - Check the rated value of the product: To avoid the impact of excessive current, please refer to the rated value and marking instructions marked on the product. Before connecting the product, please refer to the product manual for detailed information on the rated value;
 - Be sure to use appropriate overvoltage protection: ensure that there is no excessive voltage connected to the product.
 - Grounding this product: Ground the power cable grounding wire of this product. To avoid electric shock, before connecting any input or output terminals of this product, please ensure that the grounding terminal of the power cable of this product is reliably connected to the protective grounding terminal;
 - It is strictly prohibited to open the instrument and perform cover opening operations without permission from the manufacturer: Users are not allowed to open the equipment without permission from the manufacturer, and it is strictly prohibited to open this product while the equipment is running;
 - It is strictly prohibited to use hard objects to scratch the optical cover: scratching with foreign objects may cause scratches on the optical cover, surface scratches may affect the measurement distance, or cause an increase in noise data; Anti static protection;
 - Static electricity may cause damage to the instrument, and testing should be carried out in an anti-static area or with good grounding as much as possible.
 - When suspecting a product malfunction, it is strictly prohibited to operate: If you suspect that this product is malfunctioning, please contact the manufacturer for testing. Any maintenance, adjustment, or component replacement must be carried out by the manufacturer.
 - Prohibit use in corrosive environments: To avoid equipment damage caused by corrosion, it is strictly prohibited to use or place equipment in corrosive environments;
 - Strictly prohibit operation in flammable and explosive environments: To avoid equipment damage and personal safety, it is strictly prohibited to operate or place instruments in flammable and explosive environments. Keep the optical surface of the product clean: To avoid dust affecting ranging performance, please keep the optical surface of the product clean;
 - Maintain good heat dissipation: Please install the equipment on a metal heat sink surface to maintain good heat dissipation.
 - Prohibit prolonged horizontal direct viewing: The device has continuous infrared laser emission during operation, meeting the Class I laser safety standard. To ensure safety, do not look directly at the illuminated surface for a long time.

2. Equipment appearance

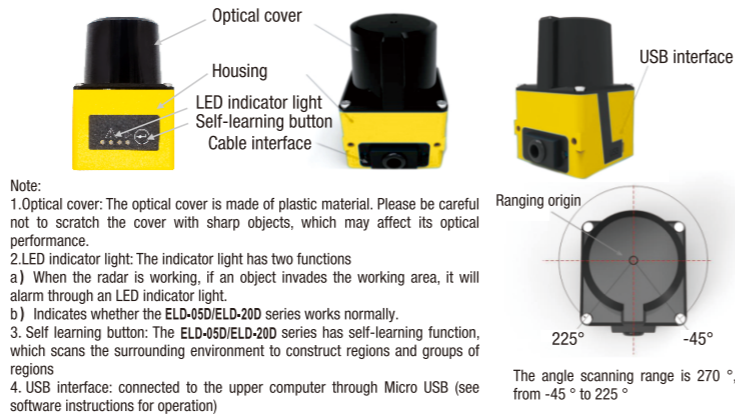

8. Power supply, 10 multi-core wires

The power supply requirement for TOF radar is DC9~28V, with/0 acting as the input and output of the switching value. Input is used for inputting external switch signals, while Output is used for outputting switch signals to external actuators. Using a 15 core wire, the pins are defined as follows. The cable has a diameter of 6mm and a length of 2m.

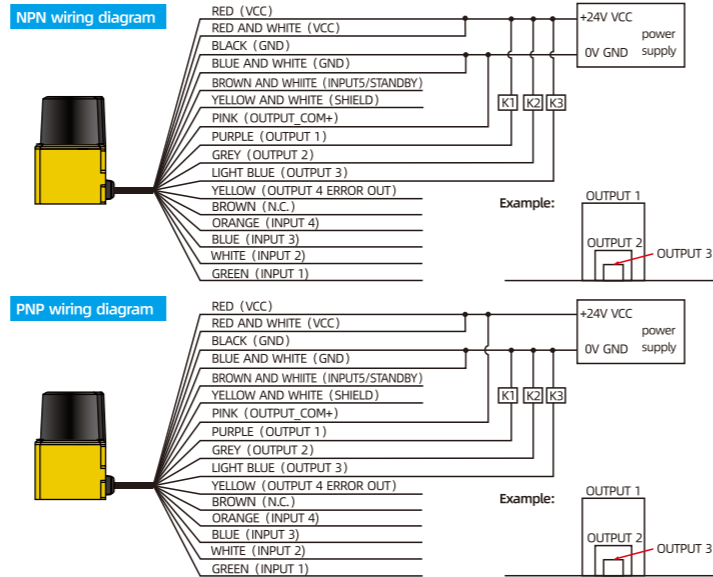

9. Indicator light status

When TOF radar is in different operating modes, the four LED indicator lights have different meanings, as shown in the table below:

Led	monitor model	Edit mode	Self-learning mode	Standby
Led4	Abnormal indicator light: Normally on, flashing once every 1 second when abnormal	Abnormal indicator light: Normally on, flashing once every 1 second when abnormal	Abnormal indicator light: Normally on during normal operation, once every 1 second during abnormal operation	Flash once every 1 second
Led3	Zone 3 intrusion sign, same as Out3 (yellow area)	Light	normal close	Light
Led2	Led2 Zone 2 Intrusion Flag, Same as Out2 (Orange Zone)	Light	normal close	Light
Led1	Zone 1 intrusion sign, same as Out1 (red area)	Light	Enter self-learning state: Press the button to flash the LED once every 1 second; Flash: Enter the flash (once every 0.25s, if the button is not released by the hand, the hand can be released) to indicate that it can enter a self-learning state (release the hand to enter self-learning); Self learning stage: 60 seconds (60 * 15 images) constantly lit; Self learning end stage: flashing (once every 0.25s) indicates the completion of self learning and stores self learning data stage;	Light

3. Working principle

Distance measurement principle: TOF radar, whose core components include optical, mechanical, electrical, and software components, emits a beam of laser from the laser when it shines on an object, causing reflection. The receiver detects the reflected light signal, and then measures the time difference between the reflected light and the emitted light through a time analysis module. The distance traveled by the light is obtained by multiplying the time by the speed of light, and the position of the measured object is calculated, As shown in the figure:

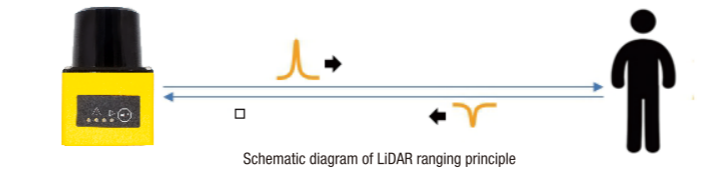

The calculation of object size is shown in the following figure

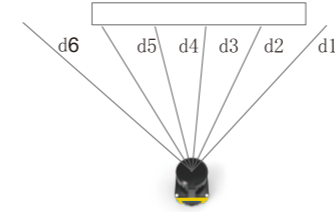

Method for calculating object size

$d1, d2, \dots, d6$: It indicates the distance between the object and the laser radar. The angle difference between them is the Angular resolution of the radar.

The formula for calculating the size of an object is:

$W=(d2+d3+d4+d5)*$
Among them, =2 yuan/3600 yuan
Due to the presence of the parameter 'shielding size', the obstacle avoidance radar will only operate when W is greater than the shielding size

4. Working mode

The TOF radar series has a total of 4 operating modes:

- Monitoring mode
This mode is the normal working mode of the TOF radar series. When an object invades, the radar sends an alarm through LED lights and corresponding output signals. When the TOF radar series is powered on, it automatically enters monitoring mode.
- Editing mode
This mode is the working mode for users to edit the TOF radar series working area group. Users use the TOF radar series Designer software to edit regions and region groups, allowing the radar to enter editing mode.

10. Mechanical dimensions and installation

The 05D series has mounting screw holes at the bottom and sides, and users can use standard screws to secure the radar. As shown in the figure

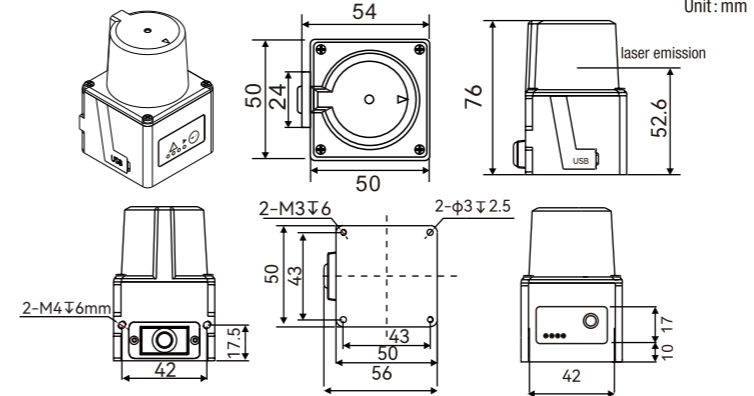

11. Equipment inspection and maintenance

Equipment inspection and maintenance are crucial for the safe use of equipment. Users must inspect and maintain the equipment as required. Before use, after the equipment is installed and configured, at least the inspections listed in the following table must be carried out before the equipment can be used.

number	Inspection items	Passed or not	notes
1	The equipment is correctly installed in the designated position without any looseness		
2	All signal wires are connected correctly		
3	When the test obstacle enters the defined area, the corresponding signal line is triggered and the corresponding LED light is on		
4	When the test obstacle leaves the designated area, the corresponding signal line fails and the corresponding LED light goes out		
5	When the input signal changes, the corresponding working area also changes		

② Daily inspection

number	Inspection items	Passed or not	notes
1	The equipment is correctly installed in the designated position without any looseness		
2	All signal wires are connected correctly		
3	When the test obstacle enters the defined area, the corresponding signal line is triggered and the corresponding LED light is on		
4	When the test obstacle leaves the designated area, the corresponding signal line fails and the corresponding LED light goes out		
5	When the input signal changes, the corresponding working area also changes		
6	The system where the device is located is working normally and is shut down once a week		

3. Self learning mode:

The mode in which users scan the surrounding environment through the ToF radar series to generate work area groups. Long press and hold the "self-learning button" on the shell of the ToF radar series for 5 seconds to put the TOF radar into self-learning mode. It will automatically scan the surrounding environment, and the scanned environment contour is the boundary of the area. As shown in the figure



The standby mode TOF radar series is in standby mode and temporarily stops working. The main features are:

- The motor stops rotating.
- The point cloud stops uploading.
- The regional group uploads and downloads normally. The user inputs a signal to put the radar into standby mode

5. Area type

According to the geometric shape of the region and its relationship with other regions, the region is divided into the following types:

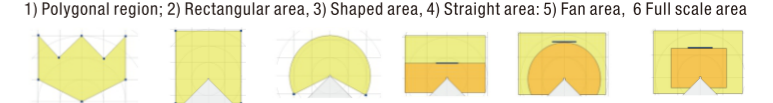

The points defining polygons, rectangles, and arcs must be within -5 to 5 meters/-20 to 20 meters (radar ranging range).

- All areas are undefined between -90 ° and -45 °.
- The proportion area is located within the upper level area.
- A regional group consists of three regions, namely Region 1 (red), Region 2 (orange), and Region 3 (yellow). The regions within the group can be independent or interrelated, and users can set them according to their needs. As shown in the figure:

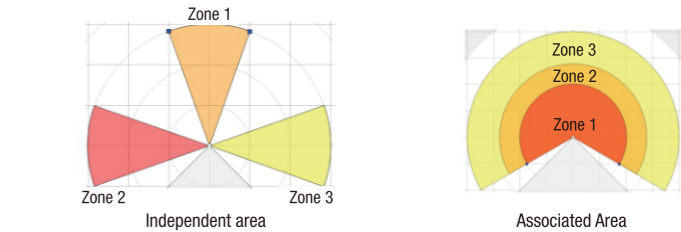

When an object invades a certain area, its corresponding LED light will be turned on, and its corresponding output signal will also become high level

③ Irregular inspection

number	Inspection items	Passed or not	notes
1	The equipment is correctly installed in the designated position without any looseness		
2	The device is still in its initial installation position and has not moved		
3	The optical cover of the equipment is free of dust and scratches		
4	Correct connection of equipment cables		
5	When the input signal changes, the corresponding working area also changes		
6	The system where the device is located is working normally		
7	When the test obstacle enters the defined area, the corresponding signal line is triggered and the corresponding LED light is on		
8	When the test obstacle leaves the designated area, the corresponding signal line fails and the corresponding LED light goes out		
9	When the input signal changes, the corresponding working area also changes		
10	The system where the device is located is working normally		

When the optical cover is covered with dust or oil, the detection ability of the radar series will be affected. Users should clean it using the correct method, wipe it with a clean cotton cloth, and use a soft brush to clean it

Use a hair dryer to blow off the dust
Use neutral detergent to remove oil stains on the surface

12. Product performance parameters

Product Features	Performance
Laser light source	905 nm (Class I)
Scanning angle range	Recognizable object shape
Scan frequency	Measurement error
Angular resolution	Number of regional groups
Work area	Interface
Self-learning function	Signal output hold time
Mechanical and electronic parameters	Response time
Electrical connections	Status
Supply Voltage	Environmental parameters
Consumption	Anti vibration
Switch drive	Shell color
Protection grade	Protection grade
Weight	Ambient Temperature
R-inch (L x W x H)	Storage temperature range
	Resistance to ambient light

Software Instructions

1. Component interface

Using software for radar control and area design

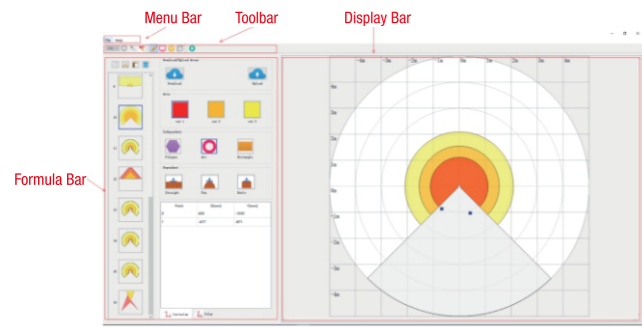

Editing interface

System requirement CPU: Intel i5 dual core 2.7G and above
OS: Windows 7 and Windows 10
Program type: GUI application, supporting Windows message cycle
Data transmission: USB 3.0
Installation: Install the driver first, then install the software

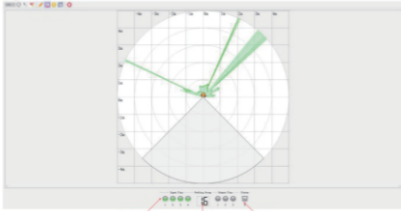

Monitoring Interface

- The software has two working modes: editing mode and monitoring mode. The editing mode is used to edit the radar working area (group), and the monitoring mode allows users to monitor the working status of the radar.
- Edit bar: used to edit regions and regional groups to meet user needs.
- Display bar: used to display the effects of area editing and point cloud data.
- Input selection signal: displays the status of the input selection signal on the device.
- Work Area Group: The current work area group of the device.
- Output signal: The current input signal of the device.

② Rectangular area: Due to the limitation of the radar scanning angle range, the defined rectangular area is actually a geometric pattern formed by the intersection of the rectangular area defined by four points and the radar scanning area, as shown in the figure:

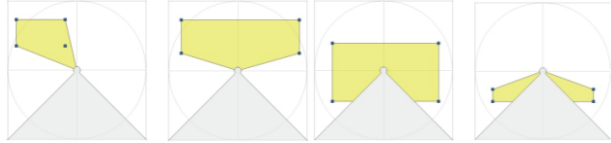

Rectangle Region Shape

Drag any vertex of the rectangle to change its shape.



Change in rectangular area

The rectangular area cannot be deleted. You need to change its type to polygon before deleting it. Like polygonal regions, rectangular regions can also be changed by editing their "TopLeft" and "BottomDown" points.

③ Shaped region

Fan shaped areas are defined by the user as the starting and ending points of the arc, as well as the fan shaped area centered on Rada

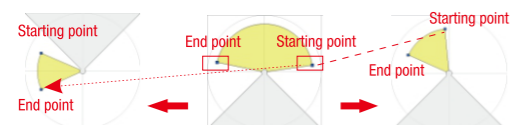

Arc region editing

The starting point of the curved area is always the point with the smaller angle between the two points. When changing the sector region, if the angle of the starting point is still smaller than the endpoint, the sector topology remains unchanged; if the starting point exceeds the endpoint, the endpoint becomes the starting point and the starting point becomes the endpoint.

Like polygonal and rectangular regions, curved regions can also be changed by editing the coordinates of their arc endpoints.

④ Linear scale area

The linear scale area is measured by a straight line, and the area on the previous layer that is smaller than this scale constitutes the linear scale area. By changing the position of this line, the shape of the area can be changed.

Zone 1 is the lowest level, Zone 2 is the middle level, and Zone 3 is the top level.

Region 2 does not have a corresponding upper level region, so it cannot be transformed into a linear proportional region.

The shape of the linear scale area can also be changed by editing the coordinates of the "ChangeBar", as shown in the figure:



Editing the Linear Scale Area

2. Coordinate system

Angle range: The angle scanning range of the radar is 270°, from -45° to 225°

Distance range: The scanning distance range defined by radar is 5cm~5m
Display area: Due to the limitations of the radar angle scanning range and distance range, both the radar and the defined boundary range of the area are meaningful only within a specific range, which is defined as the "display area"

Shielded area: All areas outside the display area are 'shielded areas'.

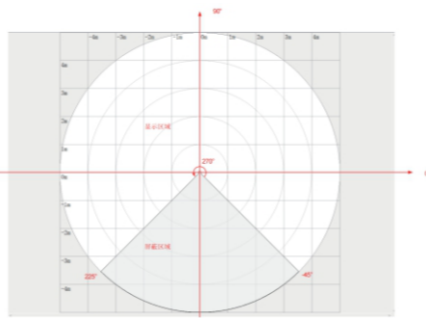

Coordinate system

3. Menu bar

The software can edit the area groups used by the radar, including:

- Save the region group to a file to form an engineering file. Its suffix name is: *.apf
- Load the region group from the project file and edit it.
- Load area groups from the radar.
- Download the regional group data to the radar.
- Create a new project to edit the region group.

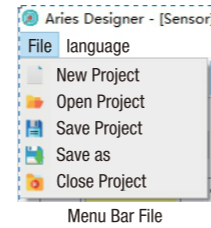

Menu Bar File

4. Toolbar

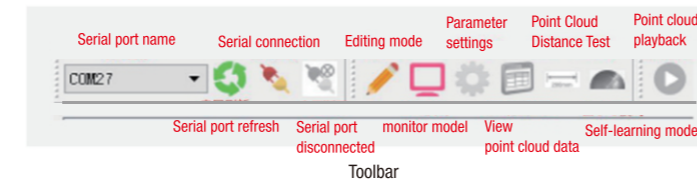

Toolbar

The software connects data to the radar through a serial port.

Serial Port Name: The name of the serial port to be connected.

Serial port refresh: When a radar is just connected to a device, the device is discovered by refreshing.

Editing mode: Make the software work in editing mode.

Monitoring mode: Enable the software to operate in monitoring mode.

Parameter setting: Users can set the working parameters of the radar through the parameter setting interface. Point cloud data viewing: Users can view point cloud data through a table.

Point cloud distance test: tests the distance of the currently selected point cloud.

Self learning mode: The software starts the radar and enters automatic learning of the surrounding environment mode. Point cloud playback: Start or stop playing the point cloud.

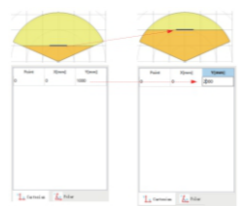

Editing the Linear Scale Area

⑤ Fan scale area

The fan-shaped proportional area is formed by intersecting the previous layer of area with a circle, and the radius of the circle is specified by the user by dragging the corresponding control. As mentioned in the previous section, Region 2 cannot be transformed into a sector proportional region.

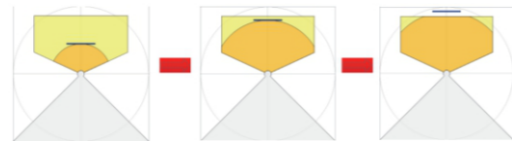

Editing of Fan Scale Regions

⑥ Full scale area

The area above the full scale area serves as a reference and is a similar shape to the area above the previous level. Users can change the similarity ratio by dragging the corresponding control.



Full scale area editing

7. Parameter settings

When the radar is connected to the software through a serial port, its operating parameters can be viewed and edited.

Parameter "button": Download all parameters to the radar.

Download Parameters button: Read radar parameters.

Total working time: How long has the radar connected to the software been working in total.

How long has the radar connected to the software been working this time.

Power on times: The radar connected to the software is powered on several times in total.

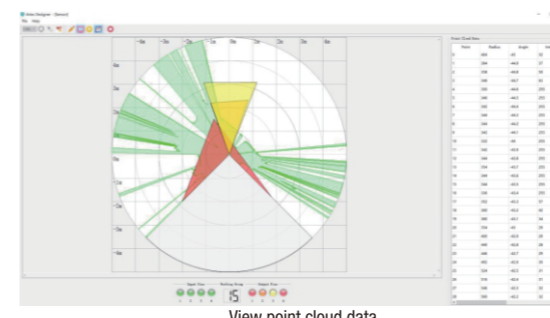

View point cloud data

5. Regional group editing

The editing function includes four operation buttons, whose functions are:

a) Copy: Copies the currently being edited region group.

b) Cut: Cut the currently being edited region group.

c) Paste: Pastes a "copied" or "cut" region group into this region group, and the original region group will be replaced.

d) Delete: Delete the current regional group

② Regional group preview

The software can manage 16 regional groups, and the graphical preview of each regional group is presented here. Users can switch to the corresponding workgroup for editing by clicking on the corresponding preview pattern.

③ Regional group upload/download

a) Upload: Upload the area groups in the radar to the software.

b) Download the managed area group to the radar. These regional groups may come from files, or they may be loaded from this radar or other radars.

④ Regional switching

Each region group contains three regions, namely red, orange, and yellow, with region numbers 1, 2, and 3. Through these three buttons, users can switch between different areas.

⑤ area type transformation (refer to point 5 of the user manual).

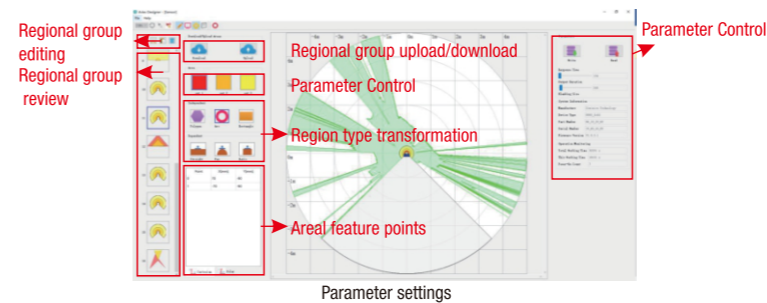

Parameter settings

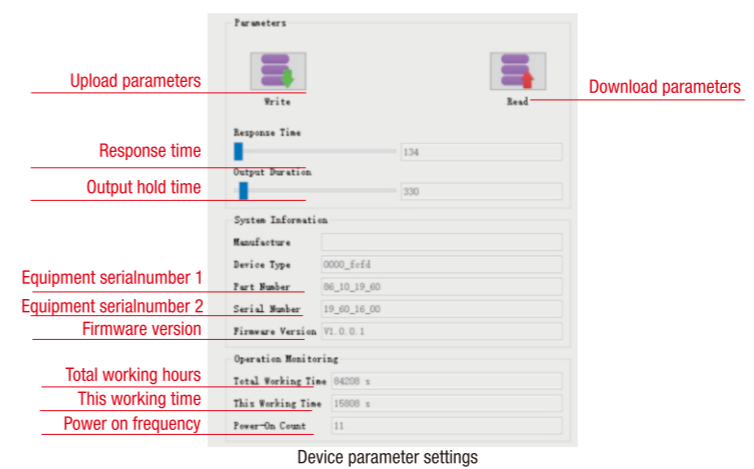

Device parameter settings

8. Point cloud image

Point cloud image

Whether in edit mode or monitoring mode, users can view the radar point cloud through the software. There are two differences here:

In edit mode, the software will display all point clouds.

In monitoring mode, the software will only display point cloud data within the angle range defined by the working area group.

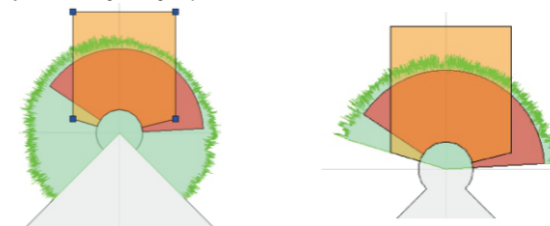

Point cloud display in edit mode

Point cloud display in monitoring mode

Viewing point clouds refers to viewing specific values of point cloud data. In monitoring mode, click the following button to view point cloud data

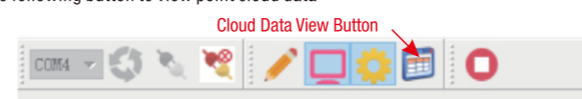

Cloud Data View Button

⑥ Areal feature points

From a geometric perspective, each region can be represented by points and their connecting lines. For example, a polygonal area can be represented as a series of points; The rectangular area is defined by two points, the upper left and the lower right; The arc area is composed of the starting and ending points of the arc plus arc segments. These points are characteristic points of the region.

The coordinates of Areal feature points can be displayed in two ways: Cartesian coordinates and polar coordinates, as shown in the figure:

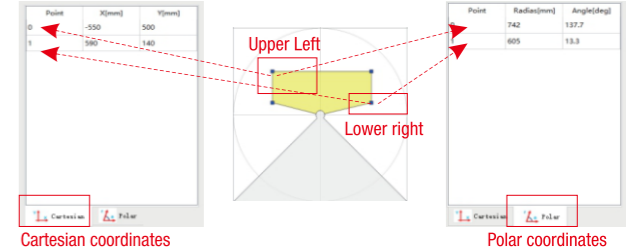

Cartesian coordinates

Polar coordinates

6. Region Editing and Display

① Polygonal area

Move the coordinate origin out to add a vertex to the polygon.

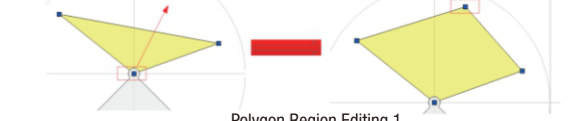

Polygon Region Editing 1

Moving polygon vertices can change the shape of the polygon

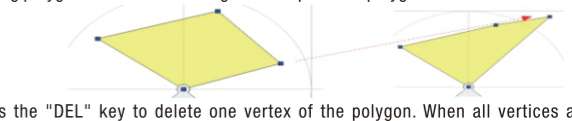

Press the "DEL" key to delete one vertex of the polygon. When all vertices are deleted, the polygon is deleted. Users can also edit the shape of the region by directly modifying the coordinates of vertices, as shown in the figure:

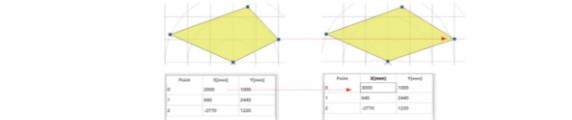

Polygon Region Editing 3

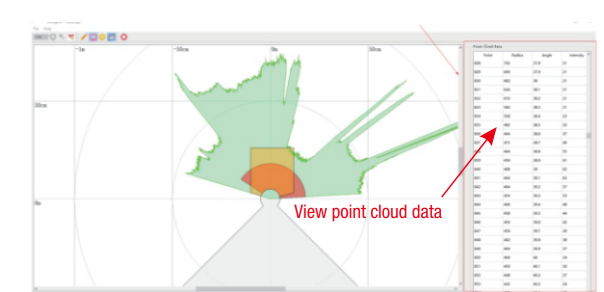

Device parameter settings

9. Point cloud measurement

The software provides distance and angle measurement tools, which can measure point clouds, as shown in Figure 3-29: Point Cloud Measurement Tool



Measurement

Users only need to turn on and move the ruler to measure the point cloud

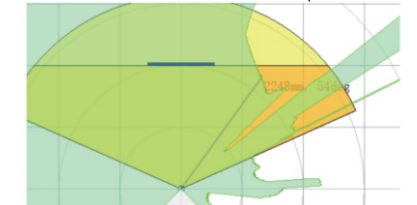

Point cloud measurement

10. Input/output signal

The input signal of the radar is determined by the user's wiring, which is the selection of the radar working area group. The output signal represents the alarm status (Output1~Output3) and operating status (Output4) of the radar.

Through the software, users can know the input signal status, output signal status, and working status of the radar.



Input signal Region selection output signal Status signal