

Laser Ranging Sensor User Manual

- Please confirm whether this product meets your needs.
- Please read this manual thoroughly before use and strictly follow the instructions below.
- Please read the precautions in the manual carefully and understand the relevant contents before use.

USER INSTRUCTIONS



Indicates that use of this product without following the specified operating instructions may result in a certain degree of personal injury or property damage.

- Please read all operating instructions and safety regulations in this manual carefully before using the instrument. Failure to use the instrument in accordance with the operating methods guided by this manual may cause damage to the instrument, affect measurement accuracy, or cause personal injury to the user or a third party. harm.
- Do not open or repair the instrument by yourself in any way, and illegal modification or change of the performance of the instrument's laser transmitter is strictly prohibited. Please keep the instrument properly, keep it out of reach of children, and avoid use by unrelated persons.
- It is strictly forbidden to irradiate your own or other people's eyes and other parts of the body with the instrument's laser. It is strictly forbidden to irradiate the laser on highly reflective surfaces.
- The electromagnetic radiation of the instrument may cause interference to other equipment and devices. Please do not use this instrument near aircraft or medical equipment, and do not use the instrument in flammable or explosive environments.
- Scrapped instruments cannot be disposed of with domestic waste. Please dispose of them in accordance with relevant national or local laws and regulations.
- If you have any quality problems with the instrument or have any questions about using the instrument, please contact the DADISICK manufacturer in time and we will solve it for you as soon as possible.

1. Confirmation of packaging items

- | | | | |
|---|-------|---|-------|
| <input type="checkbox"/> Equipment | 1 set | <input type="checkbox"/> Packaging Box | 1 set |
| <input type="checkbox"/> M12 8pin connector cable (2 m) | 1 set | <input type="checkbox"/> Metal Film Resistors | 1 set |
| <input type="checkbox"/> User's Guide | 1 set | <input type="checkbox"/> Mounting Screws | 2 set |

2. Product application/operation panel description

Provides accurate and stable distance measurement and can be integrated into various industrial applications. The red laser beam hits the reflective surface and non-contact measurement is performed based on the return signal.

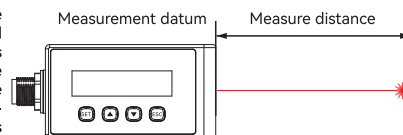

● Application

- ◇ Industrial measurement of position, displacement, thickness, distance, etc.
- ◇ Industrial automation and production intelligent management
- ◇ High-altitude cable erection measurement, railway catenary measurement
- ◇ Material level/liquid level detection
- ◇ Slope and dam deformation monitoring
- ◇ Building security monitoring

● Display

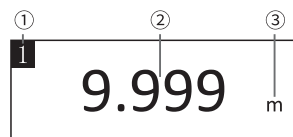

- ① Station number
- ② Measuring distance
- ③ Unit of measurement distance

● Button

Button	Short press	Long press
	Confirm in setup mode	Enter parameter setting mode
	Set mode return	Backlight switch settings
	Adjust option content	Adjust position forward
	Adjust option content	Adjust position and move back

3. Selection parameters

Item	Type A				
	EDA-Y10	EDA-Y20	EDA-Y30	EDA-Y50	EDA-Y100
Measuring distance	0.2-10m	0.2-20m	0.2-30m	0.2-50m	0.2-100m
Voltage/current output	/				
Voltage output error	/				
Current output error	/				
Output mode	Digital quantity+switch quantity				

Item	Type B (With voltage and current output)				
	EDB-Y10	EDB-Y20	EDB-Y30	EDB-Y50	EDB-Y100
Measuring distance	0.2-10m	0.2-20m	0.2-30m	0.2-50m	0.2-100m
Voltage/current output	Can be set to 0~5V / 0~10V / 4~20mA / 0~20mA / 0~24mA output *Note				
Voltage output error	0.2%+0.5mV				
Current output error	0.2%+0.005mA				
Output mode	Digital quantity+switch quantity+analog quantity				

*Note: Current and voltage can't be output at the same time.

4. Installation dimensions

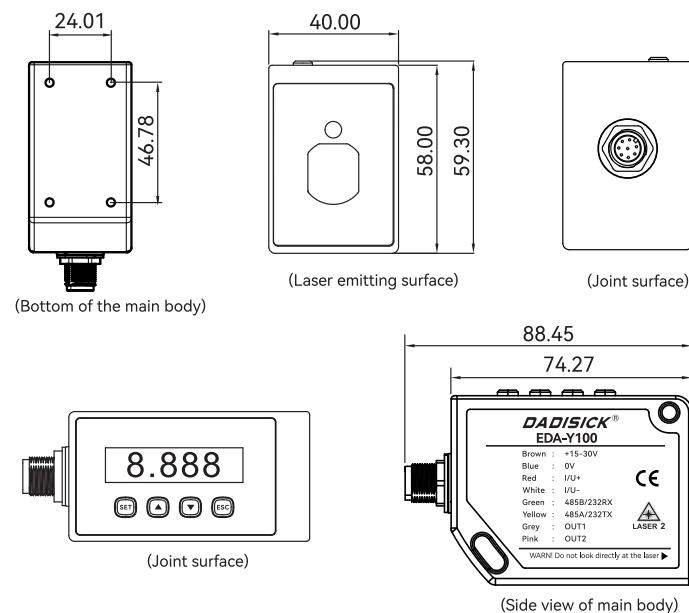

(Bottom of the main body)

(Laser emitting surface)

(Joint surface)

(Joint surface)

(Side view of main body)

5. Setup mode

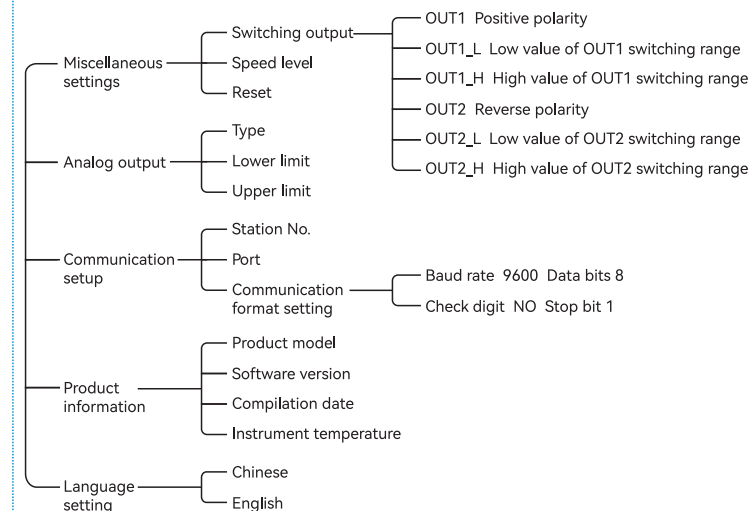

5.1 Setting Menu

The setting menu includes: Miscellaneous settings, analog output, communication setup, product information and language setting.

Menu	Miscellaneous Settings
	Analog Output
	Communication Setup
	Product Information
	Language Setting

- 1) Press **▲** to adjust the previous option;
- 2) Press **▼** to adjust the next option;
- 3) Press **ENT** to enter the selected menu item;
- 4) Press **ESC** to return to the previous interface;

Note: "Analog output" function is only available for type B

5.2 Miscellaneous Settings

Enter the "Miscellaneous Settings" option in the settings menu, refer to [5.1 Settings Menu].

Miscellaneous Settings	Switching output
	Speed level 5

- 1) Press **▲** to adjust the option upward;
- 2) Press **▼** to adjust the option downward;
- 3) Press **ENT** to enter the selected menu item;
- 4) Press **ESC** to return to the previous interface;

5.2.1 Switching Output

Enter the "Switching Output" option in the miscellaneous settings, refer to [5.4 Miscellaneous Settings].

Switching Output	OUT1	Positive polarity
	OUT1_L	01000
	OUT1_H	02000
	OUT2	Reverse polarity
	OUT2_L	01000
	OUT2_H	02000

- 1) Press **▲** to adjust the option upward/adjust the value of the selected option;
- 2) Press **▼** to adjust the option downward/adjust the value of the selected option;
- 3) Press **ENT** to select/uncheck the menu item;
- 4) Press **ESC** to cancel the selected menu item;
- 5) Hold **▲** to switch to the previous bit of the selected value;

6) Hold **▼** to switch to the next bit of the selected value;
Trigger level options: Off/positive polarity/reverse polarity

5.2.2 Speed Level

Enter the "Speed Level" option in the miscellaneous settings, refer to [5.4 Miscellaneous Settings].
Speed level: The instrument provides a total of 5 levels of speed from 1 to 5 for users, Level 1 is the slowest with an output rate of about 10Hz, Level 5 is the fastest with an output rate of about 40Hz. The ranging accuracy is inversely proportional to the speed. Users can flexibly choose according to actual conditions.

Miscellaneous Settings	Switching output
	Speed level 5

- 1) Press **▲** **▼** to adjust;
- 2) Press **ENT** **ESC** to return to the previous interface;

5.2.3 Reset

Enter the "Reset" option in miscellaneous settings, refer to [5.4 Miscellaneous Settings], and restore to factory settings.

Reset
Confirm to reset?

- 1) Press **ENT** to confirm reset;
- 2) Press **ESC** to cancel and return to the previous interface;

5.3 Analog Output

Enter the "Analog Output" option in the setting menu, type B only, refer to [5.1 Settings Menu].

Analog Output	Type	No-Out
	Lower limit	00000
	Upper limit	10000

Output mode options: No-Out/0~5V / 0~10V / 4~20mA / 0~20mA / 0~24mA

- 1) Press **▲** to adjust the option upward/adjust the value of the selected option;
- 2) Press **▼** to adjust the option downward/adjust the value of the selected option;
- 3) Press **ENT** to select/uncheck the menu item;
- 4) Press **ESC** to cancel the selected menu item;
- 5) Hold **▲** to switch to the previous bit of the selected value;
- 6) Hold **▼** to switch to the next bit of the selected value;

5.4 Communication Setup

Select the "Communication Setup" option in the menu, refer to [5.1 Settings Menu].

Communication Setup	Station No.	01
	Port	RS485
	Communication format setting	

- 1) Press **▲** to adjust the previous option;
- 2) Press **▼** to adjust the next option;
- 3) Press **ENT** to enter/select the selected menu item;
- 4) Press **ESC** to return to the previous interface/cancel the selection;

5.4.1 Station No.

Select the "Station No." option in the communication setup, refer to [5.4 Communication Setup].

Communication Setup	Station No.	01
	Port	RS485
	Communication format setting	

- 1) Press **▲** to adjust the station number value upward;
- 2) Press **▼** to adjust the station number value downward;
- 3) Press **ENT** to confirm the selected menu item;
- 4) Press **ESC** to cancel the selected menu item;

5.4.2 Port

Enter the "Port" option in the communication setup, refer to [5.4 Communication Setup].

Communication Setup	Station No.	01
	Port	RS485
	Communication format setting	

- 1) Press **▲** to adjust the port upward;
- 2) Press **▼** to adjust the port downward;
- 3) Press **ENT** to confirm the selected menu item;
- 4) Press **ESC** to cancel the selected menu item;

The port provides two options: RS485 and RS232

5.4.3 Communication Format Setting

Enter the "Communication Format Settings" option in the communication setup, refer to [5.4 Communication Setup]; there are four options: B (baud rate), D (data bit), P (parity check), and S (stop bit).

Communication Setup	B	9600	D	8
	P	Even	S	1

- 1) Press **▲** to adjust the option upward/adjust the value of the selected option;
- 2) Press **▼** to adjust the option downward/adjust the value of the selected option;
- 3) Press **ENT** to select/uncheck the menu item;
- 4) Press **ESC** to cancel the selected menu item;

- B (Baud rate) option: 1200/2400/4800/9600/19200/38400/57600/115200
- D (data bit) option: 8/9
- P (parity) option: Even/Odd/None
- S (stop bit) option: 1/1.5/2

5.5 Product Information

Enter the "Product Information" option in the Settings menu, refer to [5.1 Settings Menu].

Product Information	
Product Model	EDA-Y20
Software Version	V.1.20
Compilation Date	2024.01.31
Instrument Temperature	38°C

- 1) Press **ESC** to return to the previous interface;

5.6 Language Setting

Enter the "Language Settings" option in the settings menu, refer to [5.1 Settings Menu].

LNG	Chinese
	English

- 1) Press **▲** to adjust the option upward;
- 2) Press **▼** to adjust the option downward;
- 3) Press **ENT** to confirm the selected menu item;
- 4) Press **ESC** to return to the previous interface;

5.7 Backlight Status Setting

The backlight has two states: ① Automatically extinguishes after 30 minutes, Press any button and the backlight will automatically turn on; ② The backlight is always on;

In the instrument measurement state, press and hold the **ESC** for about 3 seconds to switch between the two states;



The display backlight will automatically turn off after 30 minutes.



The display backlight is always on.

6. Main Unit Wiring and Networking Instructions

No.	Wire color	Interface definition	Description
2	Brown	+15-30V	Positive pole of external power supply DC 15-30V (input)
7	Blue	0V	Power- (input)
8	Red	I/U+ (type B only)	Analog output + 4~20mA / 0~20mA / 0~24mA 0~5V / 0~10V
1	White	I/U- (type B only)	Voltage/current output dedicated ground terminal
3	Green	RS232RX/RS485-B	232 or 485 communication line
4	Yellow	RS232TX/RS485-A	232 or 485 communication line
5	Gray	OUT1	Switching output 1
6	Pink	OUT2	Switching output 2
	Shielded wire	EARTH	Connected to the ground

6.1 Current Output (type B only)

Note: Current and voltage can't be output at the same time.

Wiring method:

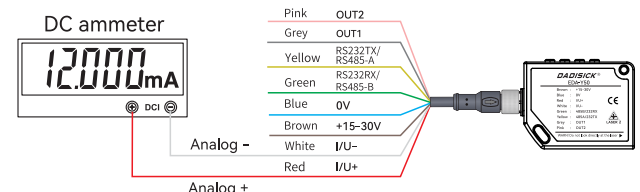

Output value calculation:

$$I_{out} = \frac{(I_{max} - I_{min}) * (D - D_{min})}{D_{max} - D_{min}} + I_{min}$$

In the formula, I_{out} is the output current;

I_{max} is the maximum value of the output current range, I_{min} is the minimum value of the output current range;

D is the present measurement distance;

D_{min} is the minimum distance value of analog output, Set in 5.3 [Lower limit];

D_{max} is the maximum distance value of analog output, Set in 5.3 [Upper limit].

For example:

The working mode is 4~20mA output ($I_{max} = 20$, $I_{min} = 4$),

The maximum distance value [upper limit] $0x1B=5000$ (mm), the minimum distance value [lower limit] $0x1A=0$ (mm), the present measurement distance = 3000 (mm), the calculation method is as follows:

$$I_{out} = \frac{(20-4) * (3000-0)}{5000-0} + 4 = 13.600mA$$

6.2 Voltage Output (type B only)

Note: Current and voltage can't be output at the same time.

Wiring method:



Output value calculation:

$$U_{out} = \frac{(U_{max} - U_{min}) * (D - D_{min})}{D_{max} - D_{min}}$$

In the formula, U_{out} is the output voltage;

U_{max} is the maximum value of the output voltage range, U_{min} is the minimum value of the output voltage range;

D is the present measurement distance;

D_{min} is the minimum distance value of analog output, Set in 5.3 [Lower limit];

D_{max} is the maximum distance value of analog output, Set in 5.3 [Upper limit].

For example:

The working mode is 0~10V output, the maximum distance value [upper limit] $0x1B=6000$ (mm), the minimum distance value [lower limit] $0x1A=0$ (mm), the present measurement distance = 4000 (mm), the calculation method is as follows:

$$U_{out} = \frac{(10-0) * (4000-0)}{6000-0} = 6.666V$$

6.3 Transistor Switching Output

This function has an open-drain (collector) output inside the instrument, It can only input DC current and cannot directly output voltage and current, Please note that the current sink cannot exceed DC36V 0.5A.

The schematic diagram of the external relay and alarm light of the instrument is as follows:

Example 1:
Example of alarm light

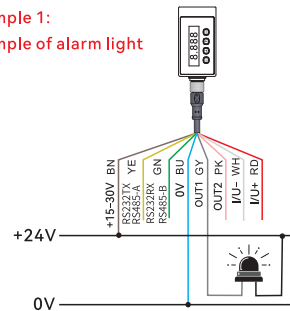

Example 2:
K1 and K2 are load relays

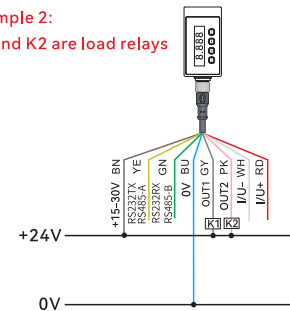

Note: The output current is less than 500mA

The level output mode is NPN and can be set to NO and NC.

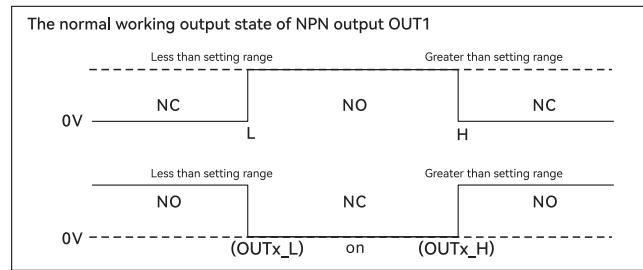

Note * When working normally, OUT1 or OUT2 is set to NC, The L-H interval maintains NPN output continuously, while other areas are disconnectedState; When OUT1 or OUT2 is set to normally open, The L-H interval remains disconnected, while other areas maintain NPN output.

Give an example:

The output mode of OUT1 is now set to NPN normally closed, The value of QUT1L is 2000 (mm), The value of QUT1H is 3000 (mm). When the measured distance value is less than 2000mm, OUT1NPN does not output; When the measurement distance is between 2000mm~3000mm, output NPN. When the measurement distance value is greater than 3000mm, OUT1 does not output.

6.4 RS232 Wiring Method

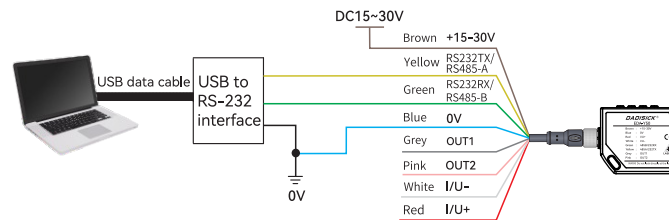

Note: RXD and TXD on the computer side and instrument side need to be cross-connected. RS232 has three connections: RX (green) TX (yellow) GND (blue).

6.5 RS485 Wiring Method

Note: The power supply for the instrument in the figure is provided by 24V.

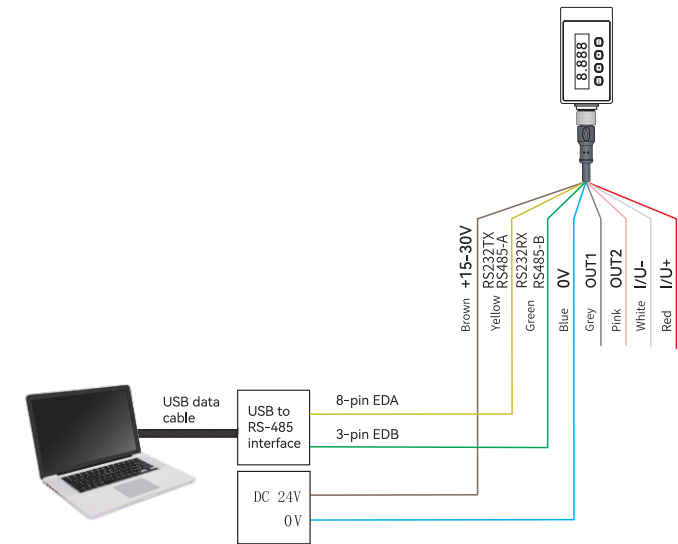

6.6 RS485 Networking Wiring Method

For example, the figure below is a connection diagram for networking a computer and multiple instruments through RS485 half-duplex communication, All instruments are connected to the bus, Due to address restrictions, the maximum number is 64.

Note: In practical applications, if communication is unstable, a 120 Ω /8W resistor needs to be connected in parallel at the RS485 terminal.

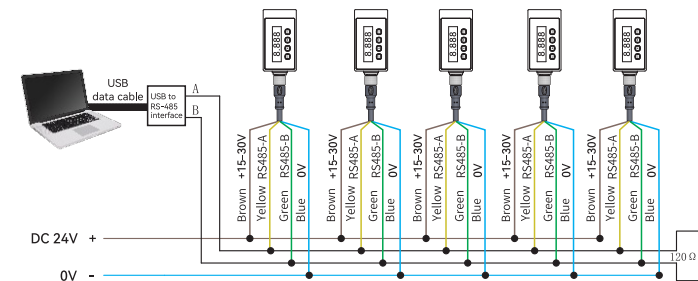

7. Data Transmission

7.1 Data Transmission Format

Default format Baud rate: 9600 Data bit: 8 Stop bit: 1 Parity bit: N
Baud rate, data bits, stop bits, parity bits and other parameters can be set in 5.2.3 [Communication Format Settings].

7.2 RS485 Interface

When the instrument is connected to 485 network, each instrument (slave) must be set with a unique address.

Because it is a slave device, when the instrument measures data, it will not actively send the data, and the host computer needs to issue instructions to obtain the data.

Instruct	Illustrate
01 06 00 11 00 00 D9 CF	Instrument is off
01 06 00 11 00 02 58 0E	continuous measurement
01 03 00 15 00 02 D5 CF	Get distance data

01 03 00 15 00 02 D5 CF
 ① ② ③ ④ ⑤

- ① Slave machine address, station number ② Read function code ③ Read address
 ④ Number of reads (2 16 bits) ⑤ Check code

7.3 RS232 Interface

When the instrument measures data, the interface will actively upload the data in the following format:

01 03 04 00 01 0D 7E 2F 43
 ① ② ③ ④ ⑤

- ① 01 indicates that the slave address is 1, only 1~64 are used in the system, and other addresses are reserved.
 ② 03 is the read function code, which means reading the data register.
 ③ 04 means returning 4 bytes of data.
 ④ The distance is 0x00010d7e (hexadecimal) = 68990 (decimal), which means the measured distance is 6.8990m.
 ⑤ Error parity bit, which allows the host and terminal to check errors during the transmission process and occupies two bytes.

7.4 Function Register List (16-bit)

Hexadecimal address	Decimal address	Attribute	Value range	Function description
0x10	16	R/W (reserved)		
0x11	17	R/W	0~2	0: Turn off measurement 2: Continuous measurement
0x12	18	R/W	1~5	Ranging speed level: 1: slowest, 5: fastest
0x13	19	R/W (reserved)		
0x14	20	R/W	1~64	Slave station number
0x15	21	R		High byte of distance register
0x16	22	R		Low byte of distance register
0x17	23	R		Ranging status register *
0x18	24	R/W	0~7	Communication baud rate
0x19	25	R/W	0~4	Voltage output 0: 0~5V 1: 0~10V Current output 2: 4~20mA 3: 0~20mA 4: 0~24mA
0x1A	26	R/W	0~50000	Minimum value register of analog output
0x1B	27	R/W	0~50000	Maximum value register of analog output
0x1C	28	R/W	0~50000	Minimum distance of Q1 switch output
0x1D	29	R/W	0~50000	Maximum distance of Q1 switch output
0x1E	30	R/W	0~2	Q1 0: Off 1: Positive polarity 2: Reverse polarity
0x1F	31	R/W	0~50000	Minimum distance of Q2 switch output
0x20	32	R/W	0~50000	Maximum distance of Q2 switch output
0x21	33	R/W	0~2	Q2 0: Off 1: Positive polarity 2: Reverse polarity

Note: When this register is 0, the distance measurement is successful; when it is not 0, the distance measurement is wrong, and the value of the distance register (21, 22) is 9999999.

For more information please visit: www.dadisick.com