

TECHNICAL DATA SHEET

ULTRASONIC SENSOR DK-CSB18 series



Figure can vary

Contents

- Basic principle
- Application
- Usage mode
- Instructions for installation
- Naming and meaning
- Performance parameters

RoHS CE

The basic principle of ultrasonic sensors

Ultrasonic sensors utilize the characteristics of sound waves to provide a non-contact and accurate detection scheme for detecting the state and distance of objects.

Sensors emit high-frequency mechanical sound waves and receive reflected sound waves when encountering objects. By calculating the time or energy between emitting and receiving sound waves, they obtain the precise distance or state of the target object as an ultrasonic sensor.

Ultrasonic sensors are suitable for detecting objects in different states, such as liquids, transparent materials, reflective materials, and particles. It can be applied in harsh environments without being affected by the color of the target object, as well as dust, water mist, and other factors in the air.



Ultrasonic sensors can detect almost all liquids, such as pure water, oil, and various solvents; Detect various transparent and reflective materials such as glass bottles, glass panels, transparent PP/PE/PET films, etc; Ultrasonic sensors can perform excellently in detecting reflective materials such as gold foil and silver foil.

Almost all fiber fabrics of different colors can be easily detected by ultrasonic sensors; Used to detect grains and automatically control material levels; The automatic control of powder material levels such as coal, sawdust, and cement is also very suitable.

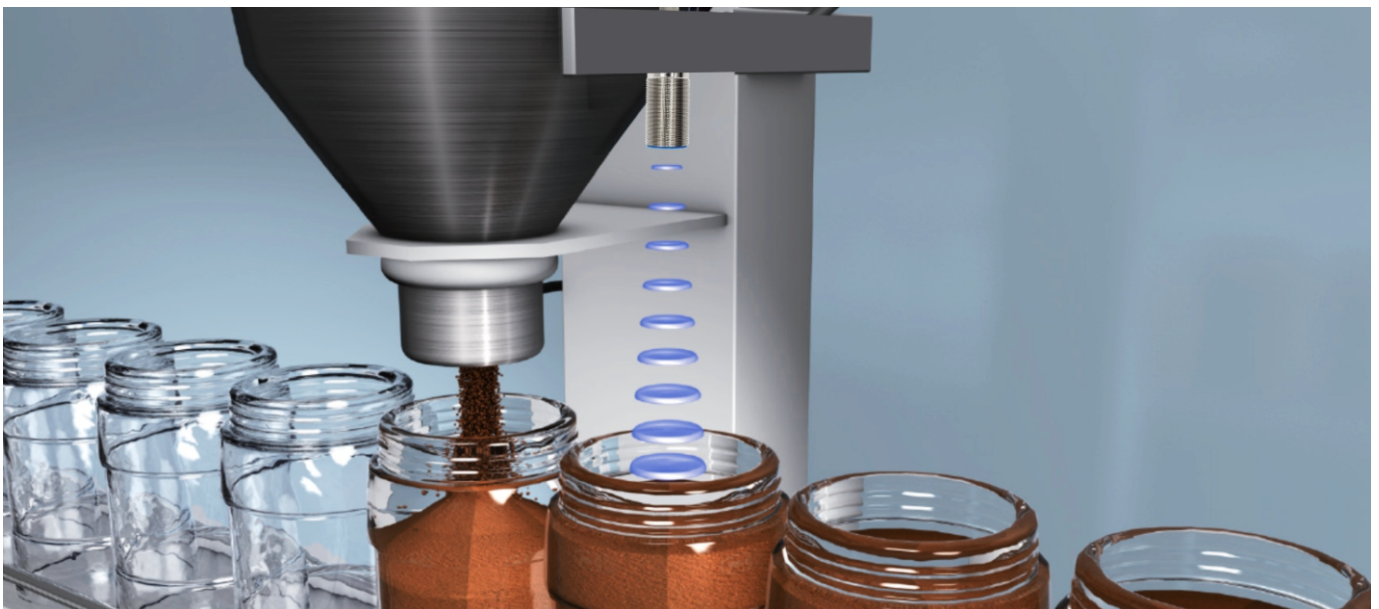

Application of ultrasonic sensors

Ultrasonic sensors have shown excellent performance in non-contact positioning and distance measurement applications.

Not affected by color and shape, and not limited by the material of the tested target, it has been widely used in industrial automation scenarios.

Below are some typical applications in the industry.

- Environmental detection and control
- Mechanical manufacturing and engineering
- New energy manufacturing equipment
- Water level and material level monitoring and control
- The automotive industry
- Mobile devices
- Material handling
- Printing, paper and post-press processing
- Packaging machinery
- Process equipment
- Gating
- Textile machinery

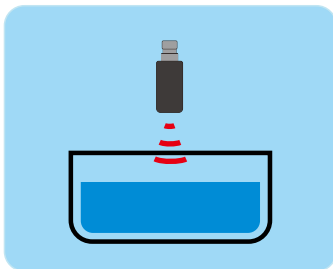

Liquid level detection

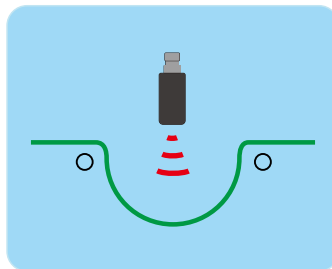

Tension control

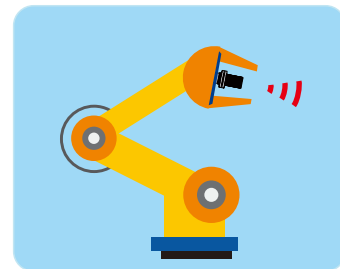

Robot arm positioning

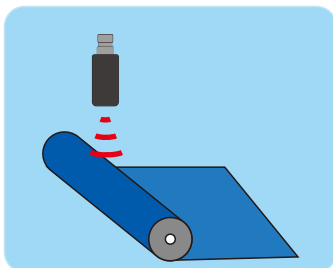

Roll diameter detection

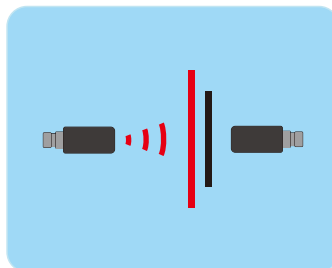

Double sheet detection

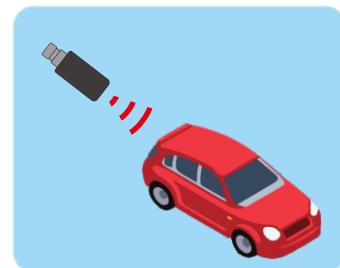

Positioning

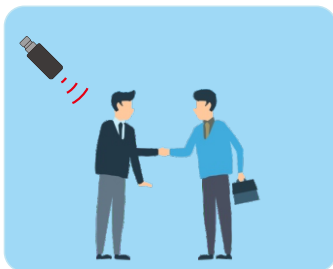

Human detection

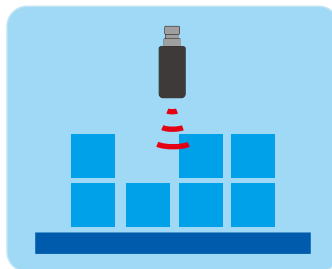

Stacking height control

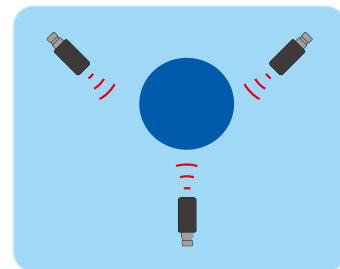

Blowing film machine control

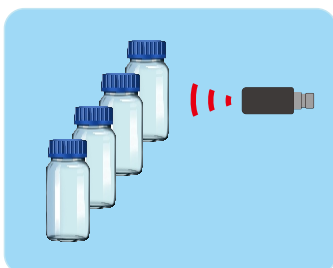

Transparent object detection

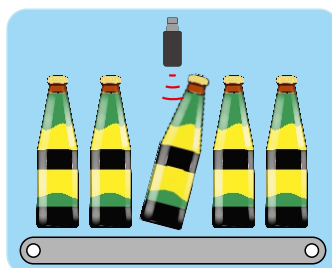

Quality control

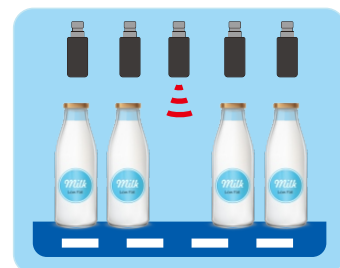

Packing control

The usage mode of ultrasonic sensors

1. Switch output, NO/NC set

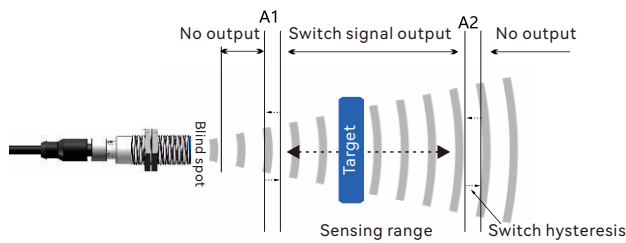

The sensor is set to NO by default. It can be switched to NC by setting A2 point to nearby, A1 point settings to the distance to NC

3. Digital output: RS485

The sensor is set to the Modbus protocol by default. Customized protocols can be customized according to customer needs.

4. Proximity switch mode

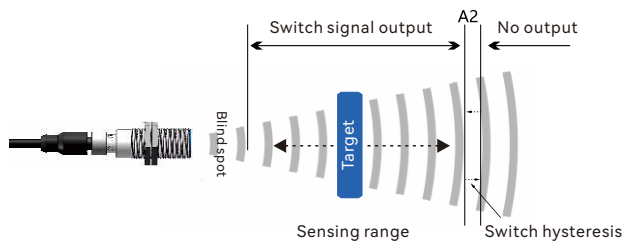

2. Analog output, up/down mode set

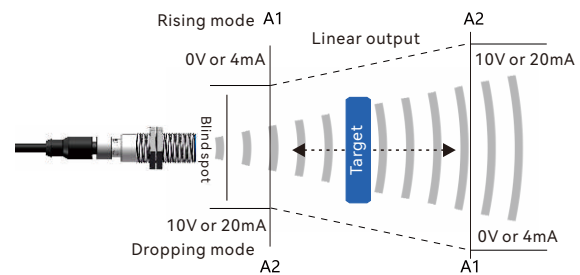

The sensor analog voltage output type is set to the minimum detection distance value and the maximum detection distance value of the factory, respectively, respectively.

The sensor analog current output type, the factory is set to the minimum detection distance value and the maximum detection distance value, respectively, which corresponds to 4mA and 20mA, respectively, respectively, respectively.

The analog voltage output type and analog current output type can be set to switch to a decline mode by setting A2 points to nearby.

The sensor sets an A2 independent switch point, and different outputs are activated within the corresponding switch point A2 through the corresponding switching point. The switching point can be set arbitrarily within the detection range. This working mode is suitable for counting on the conveyor belt or whether there is detection.

5. Window mode (interval mode)

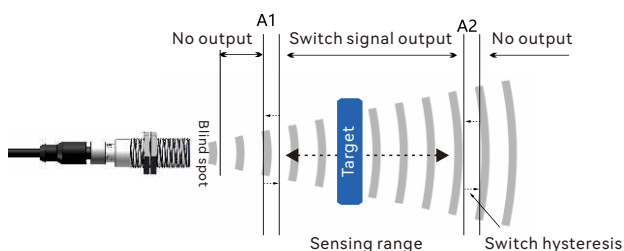

In window mode, the sensor can set two switch points A1 and A2.

Each output will only be activated within the A1 and A2 ranges.

Two switch points can be set arbitrarily within the detection range.

This working mode is suitable for detecting the defect rate of products.

For example, checking whether the bottles inside the wooden box meet the height standards and detecting products that are too high or too low.

6. Reflector mode

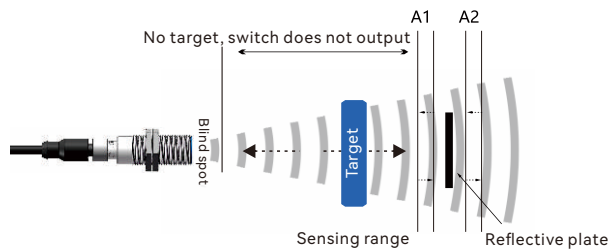

The reflector mode is actually a special window mode that places a fixed reflector in a set window. As long as the target detection object completely blocks the reflector, the sensor will send a signal.

The working method is similar to the photoelectric reflector. The ultrasonic sensor does not require a special reflective board, and any reflex can be. Whether the target is absorbed or transferred. This working mode can be used to detect foam or other sound-absorbing materials.

7. Dual switch mode (hysteresis mode)

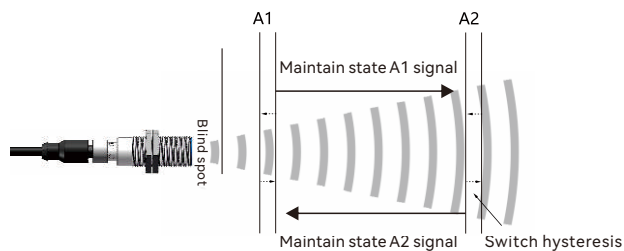

The sensor is set at points A1 and A2 within the detection range.

When the target object reaches point A1 or A2, the output switches

When moving from point A1 (A2) to point A2 (A1), the sensor remains in the current on/off state. Until passing through point A2 (A1), the output switches to its original state.

This working mode is used for automatic control of liquid level and material level.

8. Analog output mode

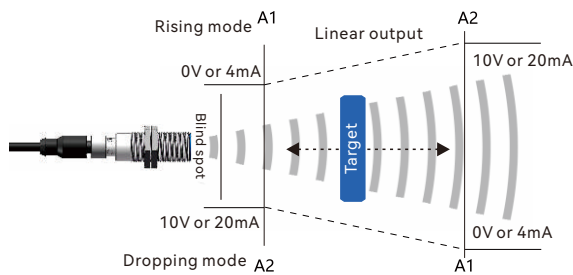

Within the effective detection range, the sensor can set A1 and A2 points at will. The distance between A1 and A2 will be evenly distributed evenly at a ratio (0-10V) or current (4-20mA) signals in proportion.

The target object is linear and real-time output from the analog signal signal.

Follow the position of A1, A2 to switch the rising mode and the decline mode.

This working mode is suitable for real-time control of various PLCs and inverters.

9. Digital output modes (IO LINK, RS232, RS485, TTL, CAN, etc.)

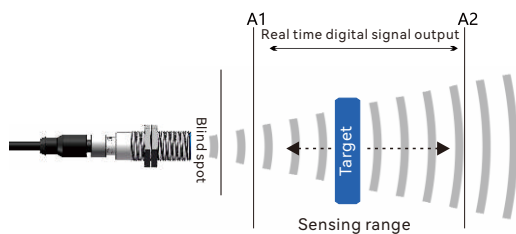

The sensor signal can communicate in real time at the level of the system architecture.

The measured distance value is transmitted to the controller in real time in the form of serial data bit.

This working mode is suitable for various development systems.

10. Ultrasonic single and double sheet detection sensors

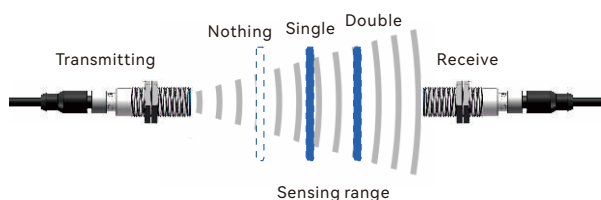

Ultrasonic single and double sheet inspection is a working mode of contrast imaging,

Determine the number of sheets of a material by detecting the energy of sound waves passing through different sheets.

A single or double sheet used for detecting paper, film, plastic sheets, and metal sheets.

Instructions for installation and use of ultrasonic sensors

1. Installation and operation description

Ultrasonic sensors can be used in harsh environments, but water drops and excessive dust accumulation will affect the normal loss of ultrasonic waves. Small dust and non-accumulated stains do not affect normal working output.

The detection surface is smooth and highly rectified. The sensor needs to be installed with the front of the detected object at an angle of $90^\circ \pm 3^\circ$. To prevent the installation angle from being too large, the sensor cannot receive the sound wave of reflection.

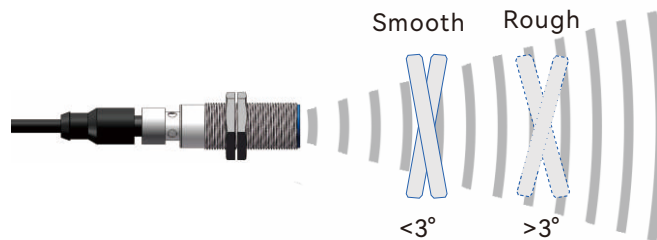









The surface of the target object is relatively rough, and the installation angle of the sensor can be greater than 3° . Due to the inherent characteristics of sound waves, the effective detection distance of sensors will be shortened when detecting materials with strong sound absorption, such as cotton, sponge, and special fabrics. The specific installation situation needs to be based on on-site debugging.

When selecting, it is necessary to test according to different materials.

2. Installation spacing

When two or more sensors of the same model are used respectively, if they are installed too close, the same frequency interference of sensors will occur, resulting in abnormal output of different sensors. To avoid this situation, sufficient distance should be reserved between multiple sensors of the same model during installation.

Suggested reference installation distance is as follows:

Detection distance	Parallel distance	Shooting distance
 150 mm	 ≥ 300 mm	 ≥ 1.5 m
 300 mm	≥ 400 mm	≥ 1.8 m
 500 mm	≥ 500 mm	≥ 2.5 m
 1000 mm	≥ 700 mm	≥ 4.0 m
 2000 mm	≥ 1500 mm	≥ 10.0 m
 4000 mm	≥ 3000 mm	≥ 20.0 m
 6000 mm	≥ 4000 mm	≥ 30.0 m

3. Synchronous function

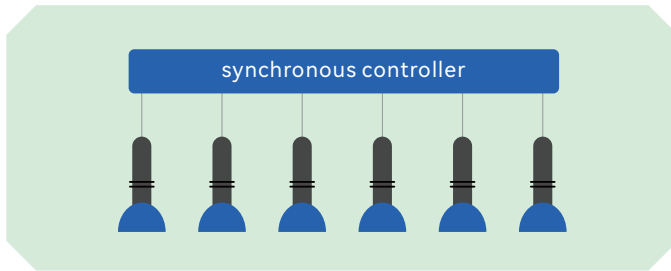

If multiple sensors are installed, the installation spacing is less than a distance that will generate mutual interference, and synchronization or asynchronous functions need to be used.

Synchronous or asynchronous functions control multiple sensors for measurement simultaneously.

DADISICK has a synchronous function of ultrasonic sensor. When installing the same model or different models, synchronous functions or asynchronous functions are implemented by synchronization controller.

4. Application of sound wave reflex characteristics

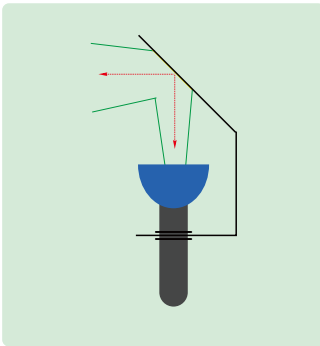

After the beam of the sound waves is reflected and changing by the smooth reflex surface, the attenuation is very small. Adjusting the appropriate accessories or installation angle can make the direction of sound waves defle. This can be installed and used in some narrow environments.

5. The effect of temperature on ultrasonic sensor

Temperature is the biggest factor that affects the accuracy of ultrasonic sensors. Ultrasonic spreads in different temperatures. Generally speaking, every temperature changes by 1 °, which will have a 0.17% impact on the measurement accuracy.

All ultrasonic sensors in DADISICK have temperature compensation circuits. Repeat accuracy errors control around 0.15%.

6. The effect of air pressure airflow, humidity on ultrasonic sensor

Below air pressure below 3 kilometers has a small impact on the ultrasonic sensor. The test distance of more than 3 kilometers will be shortened, please test and use it.

Wind speed below 60km/h has little effect on ultrasonic sensors. It is recommended to use wind speed below 60km/h.

The effect of air humidity on ultrasonic sensors can be ignored.

Ultrasonic sensor naming and meaning

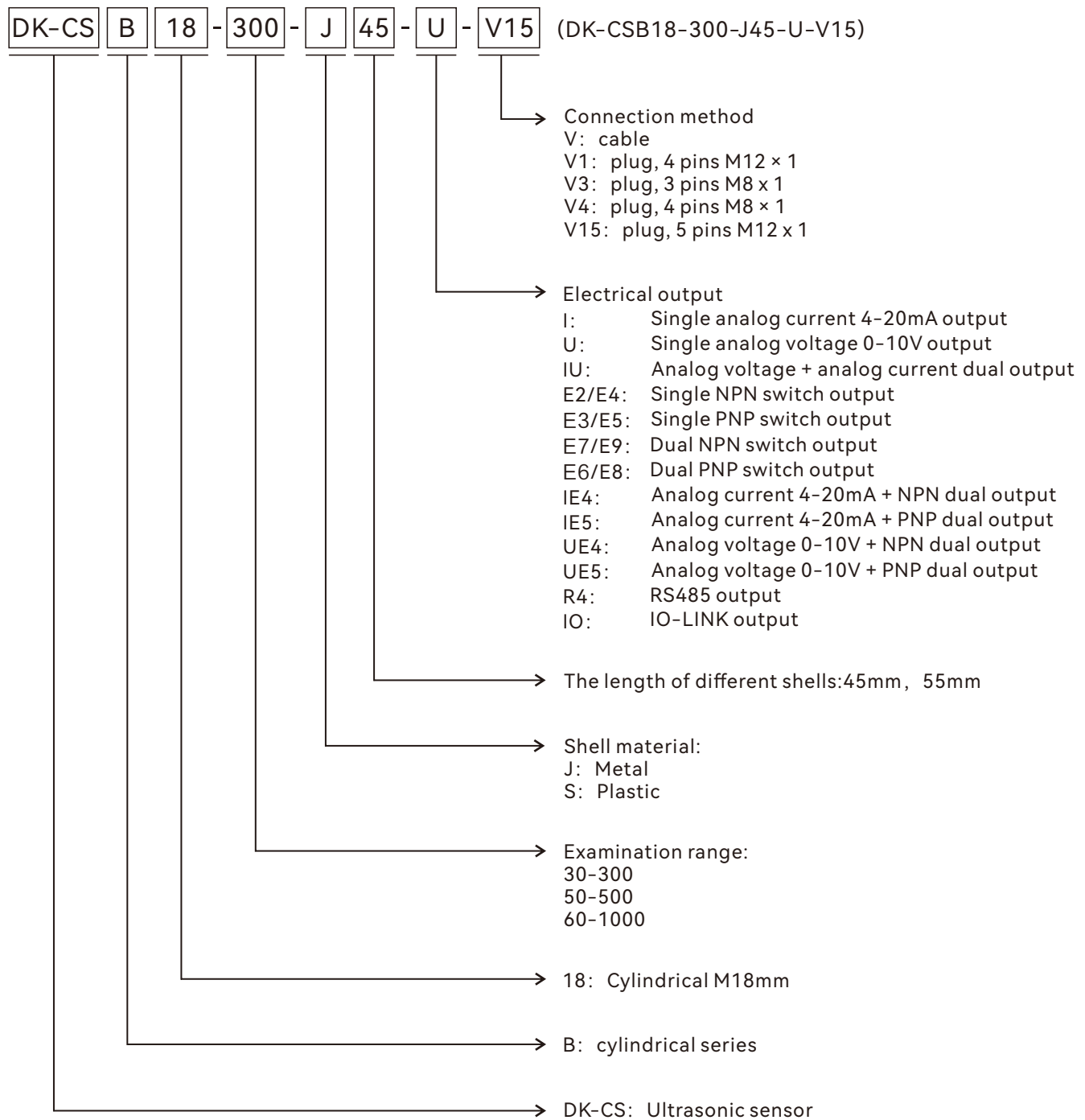

Performance parameters

DK-CSB18 series switch output E2/E3/E4/E5, E6/E7/E8/E9

		DK-CSB18-300-J45-E2-V15	DK-CSB18-500-J45-E2-V15	DK-CSB18-1000-J55-E2-V15
Model		DK-CSB18-300-J45-E3-V15	DK-CSB18-500-J45-E3-V15	DK-CSB18-1000-J55-E3-V15
		DK-CSB18-300-J45-E4-V15	DK-CSB18-500-J45-E4-V15	DK-CSB18-1000-J55-E4-V15
		DK-CSB18-300-J45-E5-V15	DK-CSB18-500-J45-E5-V15	DK-CSB18-1000-J55-E5-V15
		DK-CSB18-300-J45-E6-V15	DK-CSB18-500-J45-E6-V15	DK-CSB18-1000-J55-E6-V15
		DK-CSB18-300-J45-E7-V15	DK-CSB18-500-J45-E7-V15	DK-CSB18-1000-J55-E7-V15
		DK-CSB18-300-J45-E8-V15	DK-CSB18-500-J45-E8-V15	DK-CSB18-1000-J55-E8-V15
		DK-CSB18-300-J45-E9-V15	DK-CSB18-500-J45-E9-V15	DK-CSB18-1000-J55-E9-V15
Detection range		30-300mm	50-500mm	60-1000mm
Blind zone		0-30mm	0-50mm	0-60mm
Resolution		0.1mm	0.15mm	0.17mm
Repeatability		±0.15% of full-scale value	±0.15% of full-scale value	±0.15% of full-scale value
Absolute accuracy		±1% (built-in temperature drift compensation)	±1% (built-in temperature drift compensation)	±1% (built-in temperature drift compensation)
Response time		22ms	32ms	52ms
Switching hysteresis		2mm	2mm	2mm
Switching frequency		45Hz	31Hz	19Hz
Input type		With synchronization and learning function	With synchronization and learning function	With synchronization and learning function
Output type	E2/E4	1 NPN switch output, NO/NC		
	E3/E5	1 PNP switch output, NO/NC		
	E6/E8	2 PNP switch output, NO/NC		
	E7/E9	2 NPN switch output, NO/NC		
Weight		35g	35g	38g

DK-CSB18 series IO-Link output 2EP-IO,IUEP-IO

		DK-CSB18-300-J55-2EP-IO-V15	DK-CSB18-500-J55-2EP-IO-V15	DK-CSB18-1000-J55-2EP-IO-V15
Model		DK-CSB18-300-J55-IUEP-IO-V15	DK-CSB18-500-J55-IUEP-IO-V15	DK-CSB18-1000-J55-IUEP-IO-V15
Detection range		30-300mm	50-500mm	60-1000mm
Blind zone		0-30mm	0-50mm	0-60mm
Resolution		0.1mm	0.15mm	0.17mm
Repeatability		±0.15% of full-scale value	±0.15% of full-scale value	±0.15% of full-scale value
Absolute accuracy		±1% (built-in temperature drift compensation)	±1% (built-in temperature drift compensation)	±1% (built-in temperature drift compensation)
Response time		22ms	32ms	52ms
Switching hysteresis		2mm	2mm	2mm
Switching frequency		45Hz	31Hz	19Hz
Input type		With synchronization and learning function	With synchronization and learning function	With synchronization and learning function
Output type	2EP-IO	2 push pulls, support IO-Link output		
	IUEP-IO	1 analog output, analog current 4-20mA or analog voltage 0-10V+1 push pull output, supports IO-Link output		
Weight		35g	35g	38g

DK-CSB18 series analog output/digital output I/U/IU/IE4/UE4, Rs485

		DK-CSB18-300-J45-I-V15	DK-CSB18-500-J45-I-V15	DK-CSB18-1000-J55-I-V15
Model		DK-CSB18-300-J45-U-V15	DK-CSB18-500-J45-U-V15	DK-CSB18-1000-J55-U-V15
		DK-CSB18-300-J45-IU-V15	DK-CSB18-500-J45-IU-V15	DK-CSB18-1000-J55-IU-V15
		DK-CSB18-300-J45-IE4-V15	DK-CSB18-500-J45-IE4-V15	DK-CSB18-1000-J55-IE4-V15
		DK-CSB18-300-J45-UE4-V15	DK-CSB18-500-J45-UE4-V15	DK-CSB18-1000-J55-UE4-V15
		DK-CSB18-300-J45-R4-V15	DK-CSB18-500-J45-R4-V15	DK-CSB18-1000-J55-R4-V15
		Detection range	30-300mm	50-500mm
Blind zone	0-30mm	0-50mm	0-60mm	
Resolution	0.1mm	0.15mm	0.17mm	
Repeatability	±0.15% of full-scale value	±0.15% of full-scale value	±0.15% of full-scale value	
Absolute accuracy	±1% (built-in temperature drift compensation)	±1% (built-in temperature drift compensation)	±1% (built-in temperature drift compensation)	
Response time	22ms	32ms	52ms	
Input type	With synchronization and learning function	With synchronization and learning function	With synchronization and learning function	
Output type	I	1 analog current output 4-20mA, rise/fall		
	U	1 analog voltage output 0-10V, rise/fall		
	IU	1 analog current output 4-20mA + 1 analog voltage output 0-10V, rise/fall		
	IE4	1 analog current output 4-20mA + 1 switching output npn, rise/fall, NO/NC		
	UE4	1 analog voltage output 0-10V + 1 switching output npn, rise/fall, NO/NC		
	R4	1 digital output RS485 modbus-rtu		
Weight	35g	35g	38g	

Electrical data	
Power-up Timer	<500ms
Operating voltage	10-30V DC, reverse polarity protection
LED red light	No target is always bright , and no target flashes when studying.
LED green light	Detected that the target is always bright , and the target flashes when studying.
Overpower protection	200mA , red light and green light flashing at the same time.
Load impedance	I/ 0-300 Ohm , U/> 1k Ohm
No-load current	≤30mA
Structure	Cylindrical
Material	Copper nickel plating , plastic fittings , glass filled epoxy resin.
Connection type	5-pin M12 connector
Protection Class	IP67

Environmental parameters	
Ambient temperature	-25°C~+70°C (248~343K)
Storage temperature	-40°C~+85°C(233~358K)

Electrical connection

Standard symbols/connections:
(E2/E4,NPN)

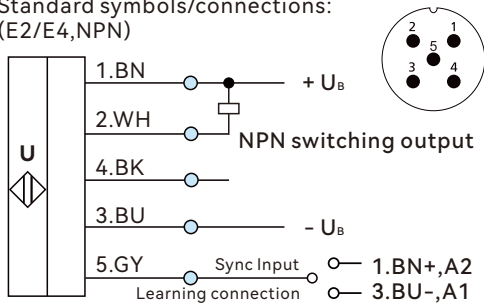

Wire core color coincidence : EN 60947-5-2

Standard symbols/connections:
(E3/E5,PNP)

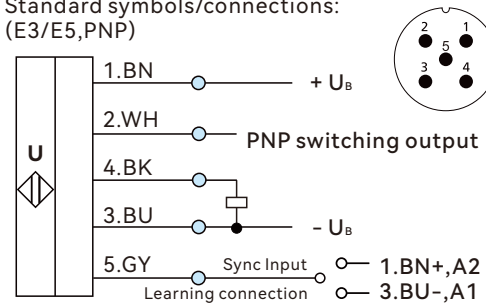

Wire core color coincidence : EN 60947-5-2

Standard symbols/connections:
(E7/E9,Double NPN)

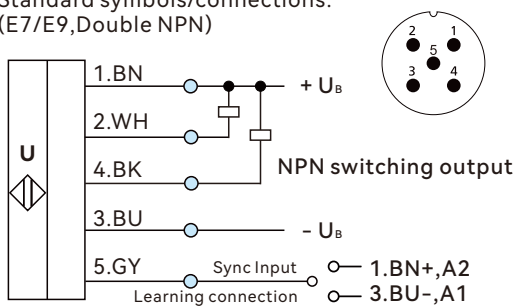

Wire core color coincidence : EN 60947-5-2

Standard symbols/connections:
(E6/E8,Double PNP)

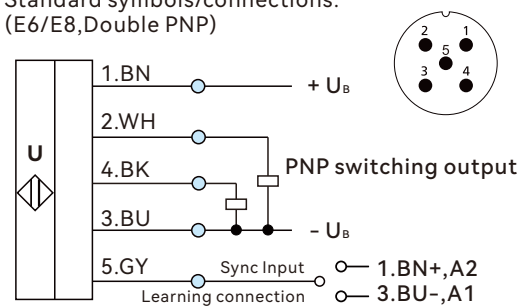

Wire core color coincidence : EN 60947-5-2

Standard symbols/connections:
(I/U,Analog current/Analog voltage)

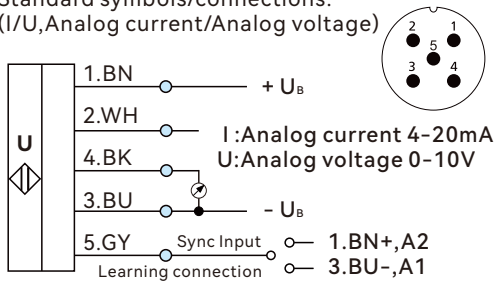

Wire core color coincidence : EN 60947-5-2

Standard symbols/connections:
(IU,Analog current + Analog voltage)

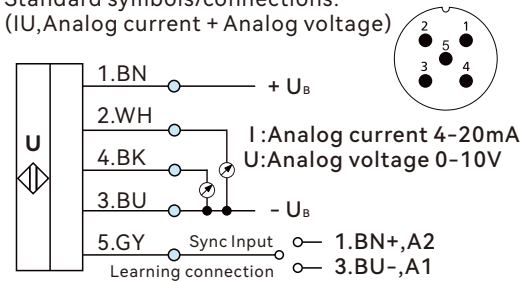

Wire core color coincidence : EN 60947-5-2

Standard symbols/connections:
(IE4/UE4,Analog quantity + switch quantity NPN)

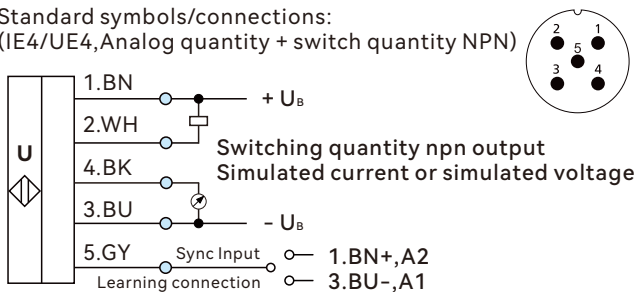

Wire core color coincidence : EN 60947-5-2

Standard symbols/connections:
(Rs485 output)

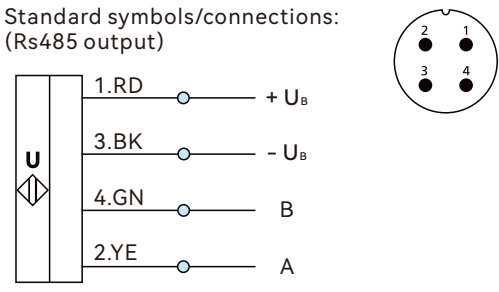

Modbus-rtu dedicated 485 signal line

Standard symbols/connections:
(2EP-IO, switch + IO-Link output)

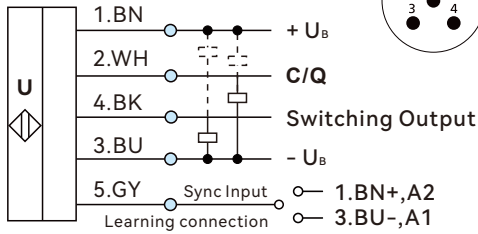

Wire core color coincidence : EN 60947-5-2

Standard symbols/connections:
(IUEP-IO, switch + IO-Link output)

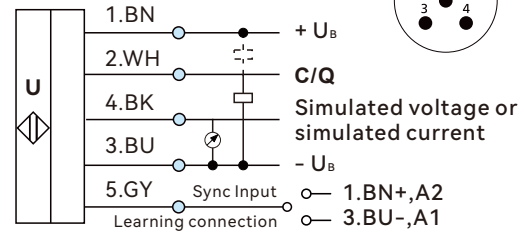

Wire core color coincidence : EN 60947-5-2

Dimensions (unit:mm)

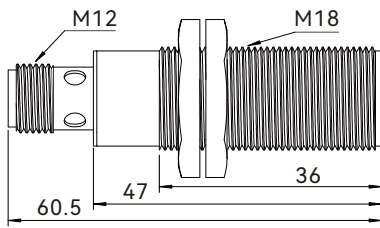

DK-CSB18 series J45

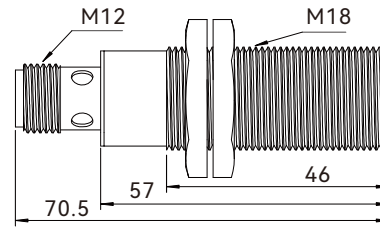

DK-CSB18 series J55

Reference curve

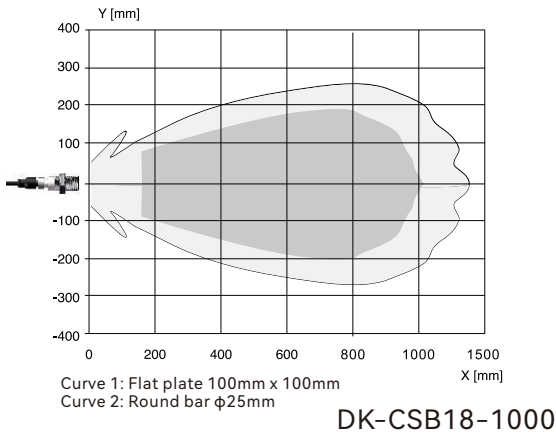
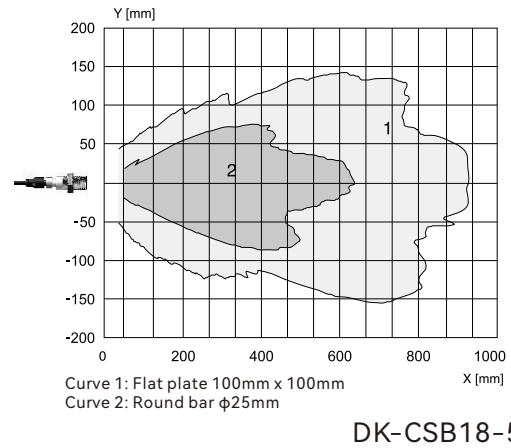
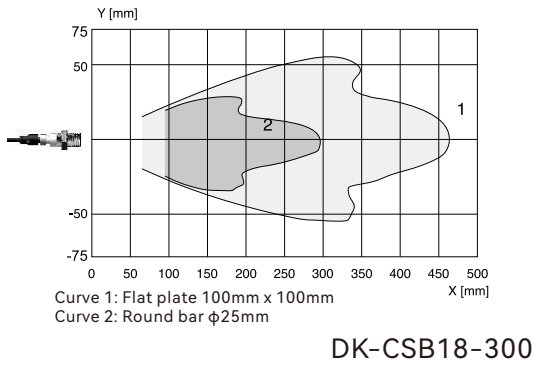

Output mode

1. Two output modes of E2/E3 switch

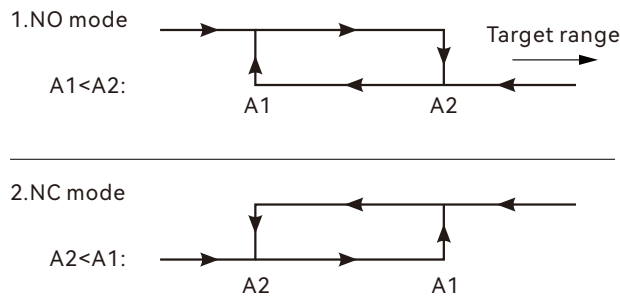

2. Five output modes of E4 / E5 switching value

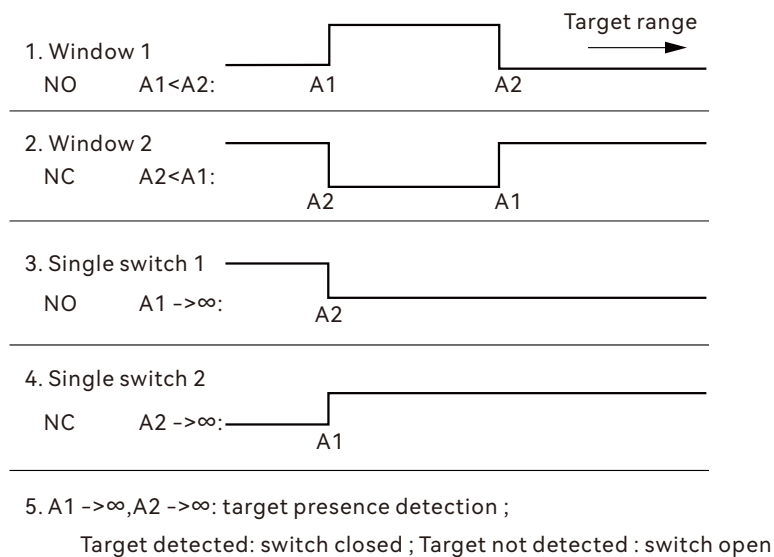

3. E6/E7 dual switch 3 output modes

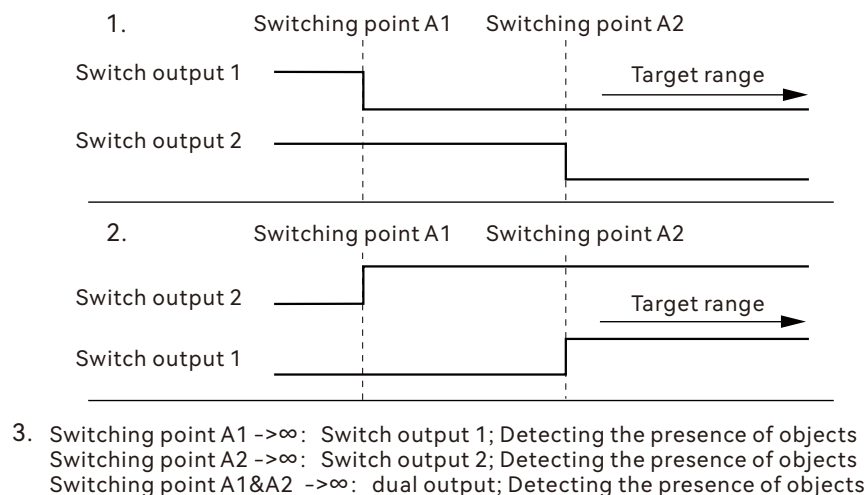

4. E8/E9 dual switch quantity with four output modes

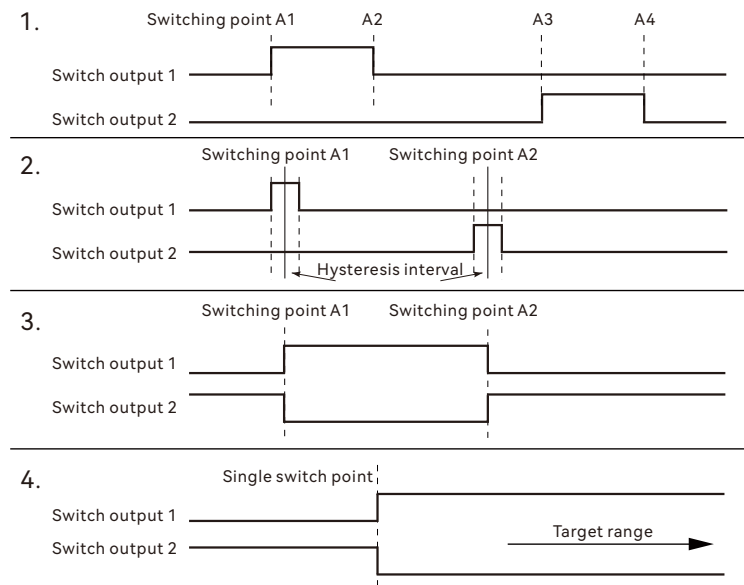

5. 2EP-IO switching output mole

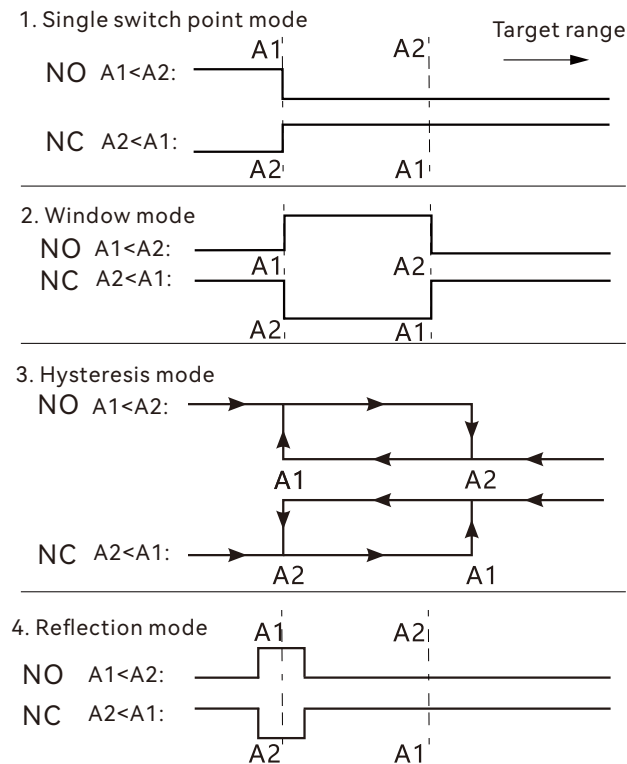

6. Analog output mole

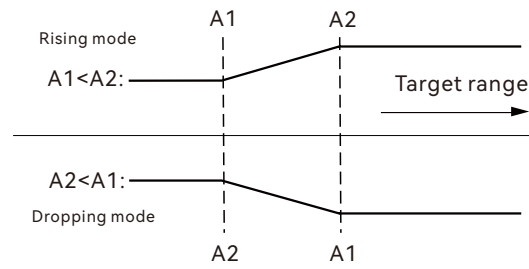

7. Analog + switch output mode

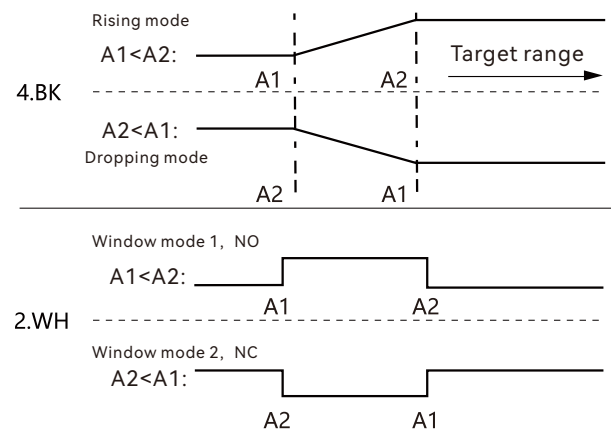

Learn and teach function

Mode	State	Condition
Window mode	NO	Place the target object near the switching point. Connect the TEACH-IN learning line -UB to point A1 until it turns green, the indicator light flashes more than 3 times, and disconnect.
		Place the target object at the remote switch point. Connect the TEACH-IN learning line +UB to point A2 until it turns green, the indicator light flashes more than 3 times, and disconnect.
	NC	Place the target object near the switching point. Connect the TEACH-IN learning line +UB to point A2 until it turns green, the indicator light flashes more than 3 times, and disconnect.
		Place the target object at the remote switch point. Connect the TEACH-IN learning line -UB to point A1 until it turns green, the indicator light flashes more than 3 times, and disconnect.
Switching point mode	NO	Place the target object near the switching point. Connect the TEACH-IN learning line +UB to point A2 until it turns green, the indicator light flashes more than 3 times, and disconnect.
		Cover the sensor with your hand or remove all objects within the sensor's detection range until the red indicator light flashes more than 3 times, then disconnect. Connect the TEACH-IN learning line to -UB and set point A1.
	NC	Place the target object near the switching point. Connect the TEACH-IN learning cable to point -UB and set point A1 until the green indicator light flashes more than 3 times, then disconnect.
		Cover the sensor with your hand or remove all objects within the sensor's detection range until the red indicator light flashes more than 3 times, then disconnect. Connect the TEACH-IN learning line to +UB and set point A2.
Object presence detection mode	/	Cover the sensor with your hand or remove all objects within the sensor's detection range. Connect the TEACH-IN learning cable to -UB and set the A1 point until the red indicator light flashes more than 3 times and disconnect. Connect the TEACH-IN learning line to +UB and set the A2 point until the red indicator light flashes more than 3 times and disconnect.

Factory settings

A1: Blind spot (minimum operating range)

A2: Maximum range