

TECHNICAL DATA SHEET

Capacitive Proximity Switches Proximity Sensors **Square Series**

Contents

- Functional Description
- Application Scenarios
- Technical Parameters
- Size Parameters
- Wiring Diagram



Figure can vary

Proximity sensors: solutions for multiple scenarios

Proximity sensors are widely used in many fields due to their non-contact detection, high accuracy and fast response.

Inductive series for oil-resistant and corrosion-resistant machine tool industry

Many times we are faced with harsh operating environments, compact installation spaces, and conditions with both movement and corrosion during use, such as the machine tool manufacturing industry, which has such diverse needs - the number of materials, processes and molds involved is huge and varied. During the production process, cutting fluids and abrasives are required to process workpieces, so various sensor solutions that are not affected by harsh environmental conditions are required. dadisick's product series, which uses different manufacturing processes, can even provide fully suitable sensor solutions for high-speed applications or applications involving corrosive coolants and lubricants.



All-metal integrated housing anti-washing series



Due to the stainless steel integrated housing, this series of sensors not only has good impact resistance, but also can withstand the corrosion of detergents and solvents. It can be used in environments that require frequent high-pressure washing, and can achieve long-term sealing that meets the IP69K protection level. At the same time, it is compatible with the installation method of conventional sensors, which can be replaced and replaced conveniently and practically. It includes a variety of models with a diameter of 8mm...30mm, all with direct cable output and M12 standard connector. Operating distance 2...8mm.

Low-temperature -40°C inductive series for wind power generation

Wind power generation has become one of the world's recognized main clean energy generation methods because it does not require the use of fuel and does not produce radiation or air pollution. Different sensors are used in the operation of the variable pitch yaw generator reducer of the wind turbine to detect the correction of the control movement and rotation process. Most of the installation locations of wind turbines are in places with severe temperature changes such as mountains, oceans and plateaus, which require higher temperature environments for sensors. Our low-temperature -40°C product series launched for this use environment is perfectly adapted to the application here.



Solutions for high-temperature series long-distance products in steelmaking and rolling



Steelmaking and rolling equipment produces complex oil, gas and water erosion and flushing sensors for various raw materials under high temperature of oil and gas in a high-temperature 2000° radiation environment, which puts higher requirements on the stability of sensors. In the position control detection of multiple processes of steel billets, coils and wires, DADISICK has a variety of series of products with high temperature resistance of 250°C, DC two-wire, AC 250V, etc., which are widely used in this complex environment to ensure normal production.

Anti-welding slag adhesion, high temperature resistance and anti-interference series

Whether it is stamping, welding, painting, or assembly processes in automobile manufacturing, long distance, anti-welding slag adhesion, strong current magnetic field interference, or high temperature environment, DADISICK sensors can be used for fixtures, molds and other equipment. Reliable performance and perfect solutions bring a smooth production process to automobile manufacturing. In the welding of various high-current welding machines, the strong magnetic field interference generated by the current and the high-temperature heat conduction generated by the arc will affect the sensors in the fixture molds. Reliable performance products must be selected to ensure normal operation.



All-metal integrated housing anti-washing series

A large number of intelligent warehousing and logistics facilities, such as AGV trolleys and rail-to-rail stackers, are equipped with our sensors to realize the control of rotating positioning and lifting devices, etc., providing very stable and durable high-reliability products. Under the high requirements of small installation space and long detection distance, this series of products is the best choice for customers with strict cost control. Choosing this series of products is the best choice for customers with strict cost control.

High-pressure 1000Bar hydraulic cylinder series

The stable and reliable hydraulic cylinder telescopic more often uses DADISICK's inductive proximity sensors with a high pressure resistance of up to 1000Bar to achieve the control of the origin. Ceramic chips are used as high-voltage products at the induction level and stainless steel integrated housings are used to achieve high-pressure resistant applications. DC10-30V two-wire and three-wire products are also provided.



Analog output series for position correction and control devices



In detecting the offset position of the controlled parts of the fixture, analog output proximity sensors are often used in wire reel correction, and the size of the offset is controlled by the size of the detection distance. This use can be installed and tested in a very small position space. We have successfully provided stable and accurate products for many parts manufacturers and wire rope winding equipment, including 0-10V voltage output and 4-20mA current output and current + voltage output products. The detectable distance can be adjusted between 0-50mm.

Shoemaking, textile and papermaking machinery series products

Whichever manufacturer of shoemaking machines, textile machines and papermaking machines has long equipped the mechanical equipment they produce with more automated operation technologies, these control technologies are also equipped with high-quality sensors to achieve their control conditions. They require products with higher switching frequency accuracy and better stability, and they need a variety of products with unconventional dimensions. We tailor new outer shell dimensions for them one by one to meet their needs.



Proximity Sensor Model Specifications

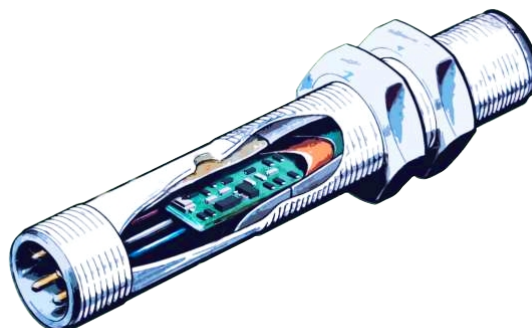
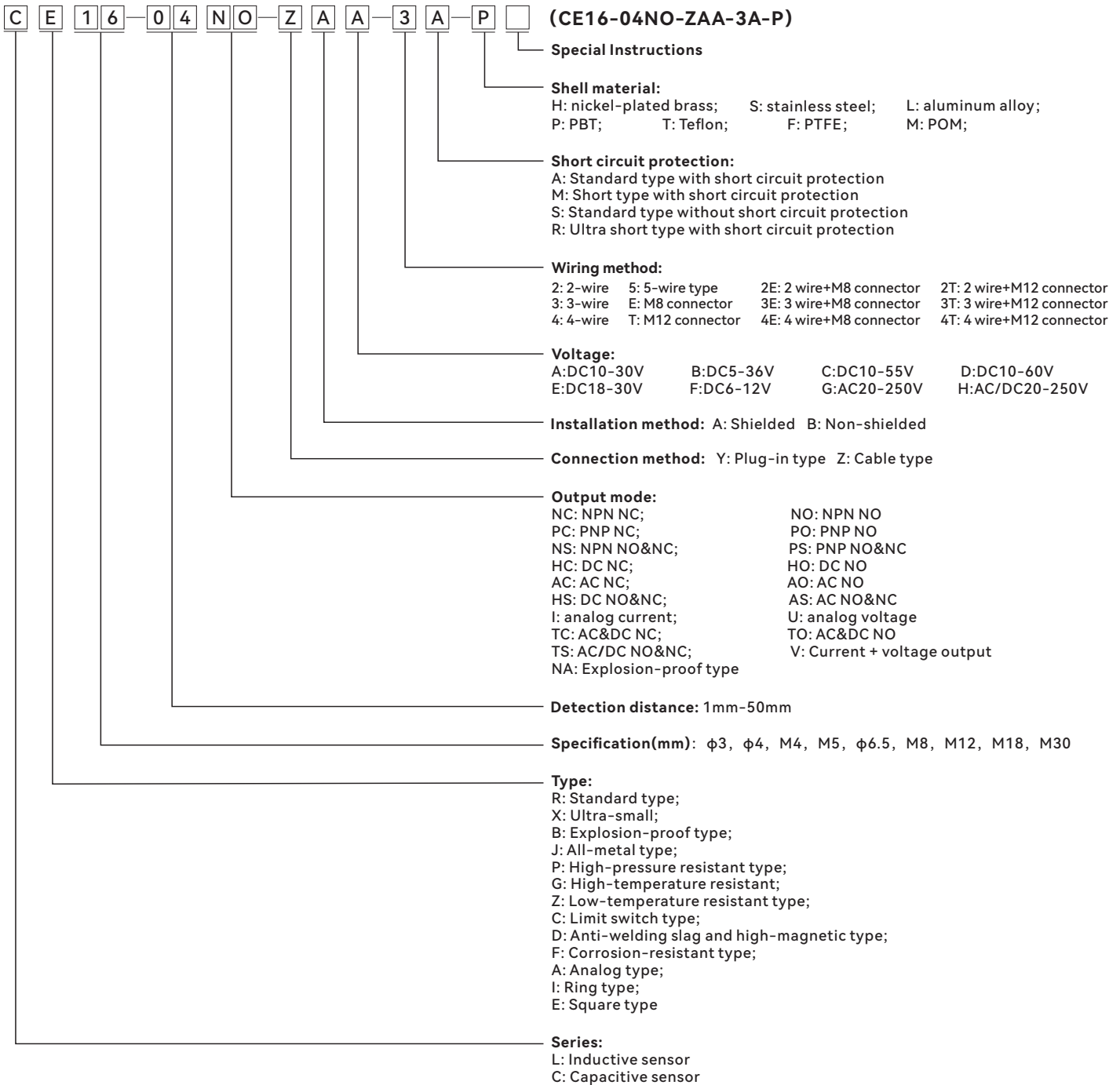

Square Series

Capacitive Proximity Switches

This series features: Wide range of detected objects, can detect metal and non-metal materials (such as liquid, wood, plastic, paper, etc.)

Features:

- Sensing distance: 2-40mm;
- Frequency: 20-300 HZ;
- Certificates: CE, ROHS.



Application Industry

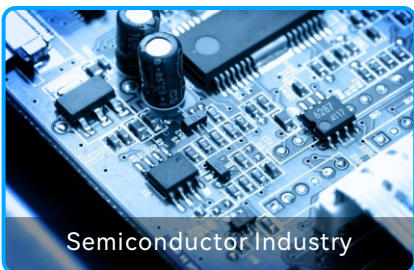

Product Parameters

Square Series

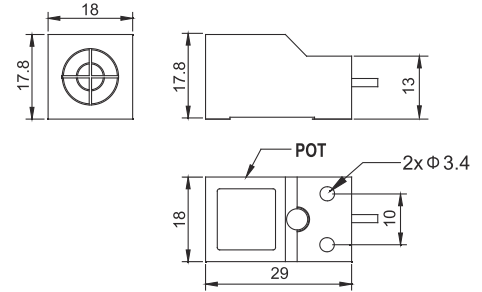
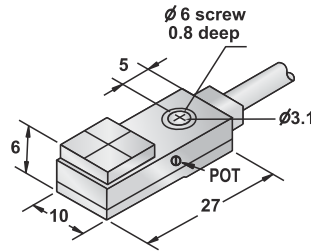

Size category	10*6*27		18*17.8*29	
● Shielded ○ Non-shielded	●	○	●	○
Sn: mm	2mm	4mm	4mm	8mm
Shell material	PBT		PBT	
● LED display ○ No LED display	●		●	
Operating voltage	10-30VDC		10-30VDC	
Allowable pulsating voltage	<10%		<10%	
No-load current	<10mA		<10mA	
Maximum load current	200mA		200mA	
Leakage current	<0.01mA		<0.01mA	
Voltage drop	<2V		<2V	
Switching frequency	100HZ		100HZ	
Response time	0.5ms		0.5ms	
Switching hysteresis	<15%(Sr)		<15%(Sr)	
Repeat accuracy	<5%(Sr)		<5%(Sr)	
Protection level	IP67		IP67	
Operating temperature	-25°C—+70°C		-25°C—+70°C	
Temperature drift	<10%(Sr)		<10%(Sr)	
Short circuit protection/reverse polarity protection	Yes		Yes	
Overload protection current	220mA		220mA	
Sensing surface material	PBT		PBT	
Connection method	2m oil-proof PVC cable 4 φ 3x0.15		2m oil-proof PVC cable 4 φ 3x0.15	
Product Model				
DC 3 wire 10-30V NPN NO	CE10-02NO-ZAA-3A-P	CE10-04NO-ZBA-3A-P	CE16-04NO-ZAA-3A-P	CE16-08NO-ZBA-3A-P
DC 3 wire 10-30V NPN NC	CE10-02NC-ZAA-3A-P	CE10-04NC-ZBA-3A-P	CE16-04NC-ZAA-3A-P	CE16-08NC-ZBA-3A-P
DC 3 wire 10-30V PNP NO	CE10-02PO-ZAA-3A-P	CE10-04PO-ZBA-3A-P	CE16-04PO-ZAA-3A-P	CE16-08PO-ZBA-3A-P
DC 3 wire 10-30V PNP NC	CE10-02PC-ZAA-3A-P	CE10-04PC-ZBA-3A-P	CE16-04PC-ZAA-3A-P	CE16-08PC-ZBA-3A-P
DC 4 wire 10-30V Convertible PNP (NO&NC)			CE16-04PS-ZAA-4A-P	CE16-08PS-ZBA-4A-P
DC 4 wire 10-30V Convertible NPN (NO&NC)			CE16-04NS-ZAA-4A-P	CE16-08NS-ZBA-4A-P
DC 2 wire 10-60V NO				
DC 2 wire 10-60V NC				
DC 3 wire 10-55V NPN NO				
DC 3 wire 10-55V NPN NC				
DC 3 wire 10-55V PNP NO				
DC 3 wire 10-55V PNP NC				
DC 3 wire 5-36V NPN NO				
DC 3 wire 5-36V NPN NC				
DC 3 wire 5-36V PNP NO				
DC 3 wire 5-36V PNP NC				
DC 4 wire 5-36V Convertible PNP (NO&NC)				
DC 4 wire 5-36V Convertible NPN (NO&NC)				

Product Parameters

Square Series

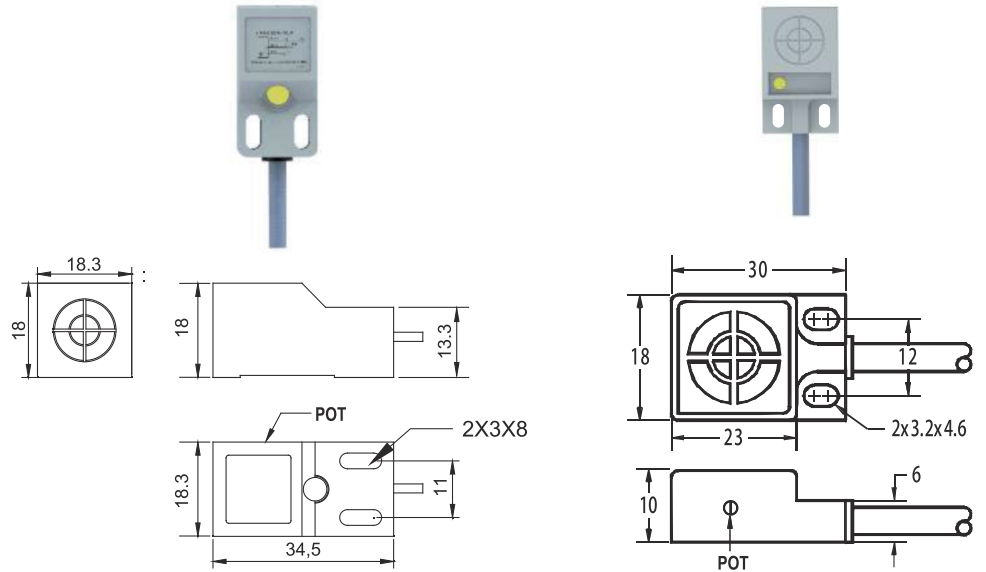

Size category	18*18*34.5		18*10*30	
● Shielded ○ Non-shielded ◐ Semi-shielded	●	◐	●	◐
Sn: mm	1-4mm Adjustable	1-8mm Adjustable	1-4mm Adjustable	1-8mm Adjustable
Shell material	PBT		PBT	
● LED display ○ No LED display	●		●	
Operating voltage	10-30VDC		10-30VDC	
Allowable pulsating voltage	<10%		<10%	
No-load current	<10mA		<10mA	
Maximum load current	200mA		200mA	
Leakage current	<0.01mA		<0.01mA	
Voltage drop	<2V		<2V	
Switching frequency	100HZ		100HZ	
Response time	1.5ms		1ms	
Switching hysteresis	<15%(Sr)		<15%(Sr)	
Repeat accuracy	<5%(Sr)		<5%(Sr)	
Protection level	IP67		IP67	
Operating temperature	-25°C—+70°C		-25°C—+70°C	
Temperature drift	<10%(Sr)		<10%(Sr)	
Short circuit protection/reverse polarity protection	Yes		Yes	
Overload protection current	220mA		220mA	
Sensing surface material	PBT		PBT	
Connection method	2m oil-proof PVC cable 4 φ 3x0.15		2m oil-proof PVC cable 4 φ 3x0.15	
Product Model				
DC 3 wire 10-30V NPN NO	CE18-04NO-ZAA-3A-P	CE18-08NO-ZBA-3A-P	CE18-04NO-ZAA-3A-PL	CE18-08NO-ZBA-3A-PL
DC 3 wire 10-30V NPN NC	CE18-04NC-ZAA-3A-P	CE18-08NC-ZBA-3A-P	CE18-04NC-ZAA-3A-PL	CE18-08NC-ZBA-3A-PL
DC 3 wire 10-30V PNP NO	CE18-04PO-ZAA-3A-P	CE18-08PO-ZBA-3A-P	CE18-04PO-ZAA-3A-PL	CE18-08PO-ZBA-3A-PL
DC 3 wire 10-30V PNP NC	CE18-04PC-ZAA-3A-P	CE18-08PC-ZBA-3A-P	CE18-04PC-ZAA-3A-PL	CE18-08PC-ZBA-3A-PL
DC 4 wire 10-30V Convertible PNP (NO&NC)	CE18-04PS-ZAA-4A-P	CE18-08PS-ZBA-4A-P	CE18-04PS-ZAA-4A-PL	CE18-08PS-ZBA-4A-PL
DC 4 wire 10-30V Convertible NPN (NO&NC)	CE18-04NS-ZAA-4A-P	CE18-08NS-ZBA-4A-P	CE18-04NS-ZAA-4A-PL	CE18-08NS-ZBA-4A-PL
DC 2 wire 10-60V NO				
DC 2 wire 10-60V NC				
DC 3 wire 10-55V NPN NO				
DC 3 wire 10-55V NPN NC				
DC 3 wire 10-55V PNP NO				
DC 3 wire 10-55V PNP NC				
DC 3 wire 5-36V NPN NO				
DC 3 wire 5-36V NPN NC				
DC 3 wire 5-36V PNP NO				
DC 3 wire 5-36V PNP NC				
DC 4 wire 5-36V Convertible PNP (NO&NC)				
DC 4 wire 5-36V Convertible NPN (NO&NC)				

Product Parameters

Square Series

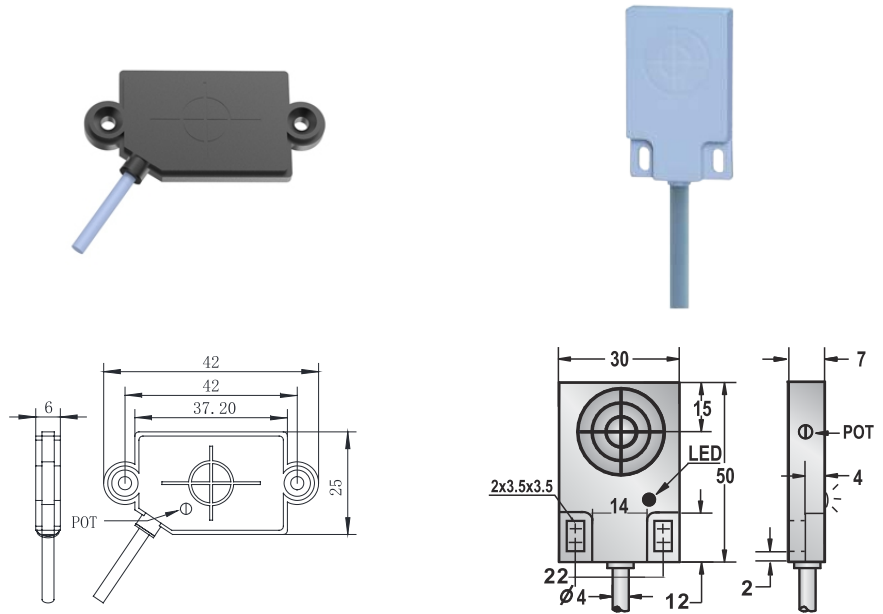

Size category	42*25*6		50*30*7	
● Shielded ○ Non-shielded ◐ Semi-shielded	●	◐	●	○
Sn: mm	1-4mm Adjustable	1-8mm Adjustable	1-6mm Adjustable	1-10mm Adjustable
Shell material	PBT		PBT	
● LED display ○ No LED display	●		●	
Operating voltage	10-30VDC		10-30VDC	
Allowable pulsating voltage	<10%		<10%	
No-load current	<10mA		<10mA	
Maximum load current	200mA		200mA	
Leakage current	<0.01mA		<0.01mA	
Voltage drop	<2V		<2V	
Switching frequency	100HZ		100HZ	
Response time	1ms		1.5ms	
Switching hysteresis	<15%(Sr)		<15%(Sr)	
Repeat accuracy	<1.0%(Sr)		<5%(Sr)	
Protection level	IP67		IP67	
Operating temperature	-25°C—+70°C		-25°C—+70°C	
Temperature drift	<10%(Sr)		<10%(Sr)	
Short circuit protection/reverse polarity protection	Yes		Yes	
Overload protection current	220mA		220mA	
Sensing surface material	PBT		PBT	
Connection method	2m oil-proof PVC cable 4 φ 3x0.15		2m oil-proof PVC cable 4 φ 3x0.15	
Product Model				
DC 3 wire 10-30V NPN NO	CE25-04NO-ZAA-3A-P	CE25-08NO-ZBA-3A-P	CE30-06NO-ZAA-3A-P	CE30-10NO-ZBA-3A-P
DC 3 wire 10-30V NPN NC	CE25-04NC-ZAA-3A-P	CE25-08NC-ZBA-3A-P	CE30-06NC-ZAA-3A-P	CE30-10NC-ZBA-3A-P
DC 3 wire 10-30V PNP NO	CE25-04PO-ZAA-3A-P	CE25-08PO-ZBA-3A-P	CE30-06PO-ZAA-3A-P	CE30-10PO-ZBA-3A-P
DC 3 wire 10-30V PNP NC	CE25-04PC-ZAA-3A-P	CE25-08PC-ZBA-3A-P	CE30-06PC-ZAA-3A-P	CE30-10PC-ZBA-3A-P
DC 4 wire 10-30V Convertible PNP (NO&NC)				
DC 4 wire 10-30V Convertible NPN (NO&NC)				
DC 2 wire 10-60V NO				
DC 2 wire 10-60V NC				
DC 3 wire 10-55V NPN NO				
DC 3 wire 10-55V NPN NC				
DC 3 wire 10-55V PNP NO				
DC 3 wire 10-55V PNP NC				
DC 3 wire 5-36V NPN NO				
DC 3 wire 5-36V NPN NC				
DC 3 wire 5-36V PNP NO				
DC 3 wire 5-36V PNP NC				
DC 4 wire 5-36V Convertible PNP (NO&NC)				
DC 4 wire 5-36V Convertible NPN (NO&NC)				

Product Parameters

Square Series

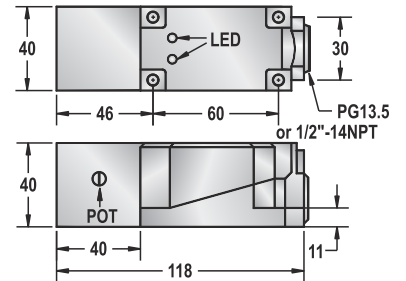
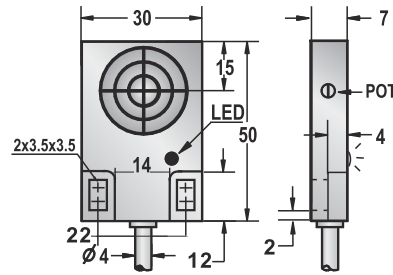

Size category	50*30*7		40*40
● Shielded ○ Non-shielded ● Semi-shielded	●	○	●
Sn: mm	1-10mm Adjustable	2-20mm Adjustable	15 mm
Shell material	PBT		PBT
● LED display ○ No LED display	●		●
Operating voltage	10-30VDC		10-30VDC
Allowable pulsating voltage	<10%		<10%
No-load current	<10mA		<10mA
Maximum load current	200mA		200mA
Leakage current	<0.01mA		<0.01mA
Voltage drop	<2V		<2V
Switching frequency	100HZ		100HZ
Response time	1.5ms		1.5ms
Switching hysteresis	<15%(Sr)		<15%(Sr)
Repeat accuracy	<5%(Sr)		<5%(Sr)
Protection level	IP67		IP67
Operating temperature	-25°C—+70°C		-25°C—+70°C
Temperature drift	<10%(Sr)		<10%(Sr)
Short circuit protection/reverse polarity protection	Yes		Yes
Overload protection current	220mA		220mA
Sensing surface material	PBT		PBT
Connection method	2m oil-proof PVC cable 4 φ 3x0.15		Quick Connectors
Product Model			
DC 3 wire 10-30V NPN NO	CE30-10NO-ZAA-3A-P	CE30-20NO-ZBA-3A-P	CE40-15NO-ZAA-3A-P
DC 3 wire 10-30V NPN NC	CE30-10NC-ZAA-3A-P	CE30-20NC-ZBA-3A-P	CE40-15NC-ZAA-3A-P
DC 3 wire 10-30V PNP NO	CE30-10PO-ZAA-3A-P	CE30-20PO-ZBA-3A-P	CE40-15PO-ZAA-3A-P
DC 3 wire 10-30V PNP NC	CE30-10PC-ZAA-3A-P	CE30-20PC-ZBA-3A-P	CE40-15PC-ZAA-3A-P
DC 4 wire 10-30V Convertible PNP (NO&NC)			CE40-15PS-ZAA-4A-P
DC 4 wire 10-30V Convertible NPN (NO&NC)			CE40-15NS-ZAA-4A-P
DC 2 wire 10-60V NO			
DC 2 wire 10-60V NC			
DC 3 wire 10-55V NPN NO			
DC 3 wire 10-55V NPN NC			
DC 3 wire 10-55V PNP NO			
DC 3 wire 10-55V PNP NC			
DC 3 wire 5-36V NPN NO			
DC 3 wire 5-36V NPN NC			
DC 3 wire 5-36V PNP NO			
DC 3 wire 5-36V PNP NC			
DC 4 wire 5-36V Convertible PNP (NO&NC)			
DC 4 wire 5-36V Convertible NPN (NO&NC)			

Product Parameters

Square Series

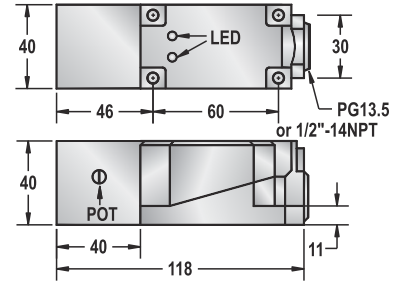
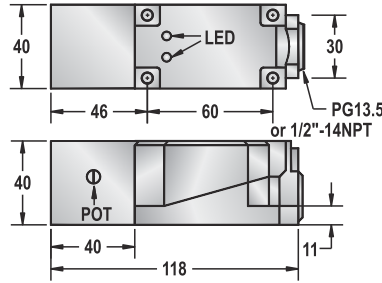

Size category	40*40	40*40
● Shielded ○ Non-shielded ● Semi-shielded	●	○
Sn: mm	20 mm	30 mm
Shell material	PBT	PBT
● LED display ○ No LED display	●	●
Operating voltage	10-30VDC	10-30VDC
Allowable pulsating voltage	<10%	<10%
No-load current	<10mA	<10mA
Maximum load current	200mA	200mA
Leakage current	<0.01mA	<0.01mA
Voltage drop	<2V	<2V
Switching frequency	100HZ	100HZ
Response time	1.5ms	1.5ms
Switching hysteresis	<15%(Sr)	<15%(Sr)
Repeat accuracy	<1.0%(Sr)	<1.0%(Sr)
Protection level	IP67	IP67
Operating temperature	-25°C— +70°C	-25°C— +70°C
Temperature drift	<10%(Sr)	<10%(Sr)
Short circuit protection/reverse polarity protection	Yes	Yes
Overload protection current	220mA	220mA
Sensing surface material	PBT	PBT
Connection method	Quick Connectors	Quick Connectors
Product Model		
DC 3 wire 10-30V NPN NO	CE40-20NO-ZBA-3A-P	CE40-30NO-ZBA-3A-P
DC 3 wire 10-30V NPN NC	CE40-20NC-ZBA-3A-P	CE40-30NC-ZBA-3A-P
DC 3 wire 10-30V PNP NO	CE40-20PO-ZBA-3A-P	CE40-30PO-ZBA-3A-P
DC 3 wire 10-30V PNP NC	CE40-20PC-ZBA-3A-P	CE40-30PC-ZBA-3A-P
DC 4 wire 10-30V Convertible PNP (NO&NC)	CE40-20PS-ZBA-4A-P	CE40-30PS-ZBA-4A-P
DC 4 wire 10-30V Convertible NPN (NO&NC)	CE40-20NS-ZBA-4A-P	CE40-30NS-ZBA-4A-P
DC 2 wire 10-60V NO		
DC 2 wire 10-60V NC		
DC 3 wire 10-55V NPN NO		
DC 3 wire 10-55V NPN NC		
DC 3 wire 10-55V PNP NO		
DC 3 wire 10-55V PNP NC		
DC 3 wire 5-36V NPN NO		
DC 3 wire 5-36V NPN NC		
DC 3 wire 5-36V PNP NO		
DC 3 wire 5-36V PNP NC		
DC 4 wire 5-36V Convertible PNP (NO&NC)		
DC 4 wire 5-36V Convertible NPN (NO&NC)		

Product Parameters

Square Series

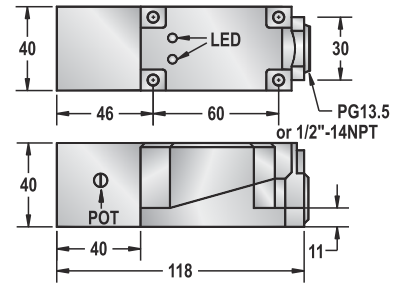
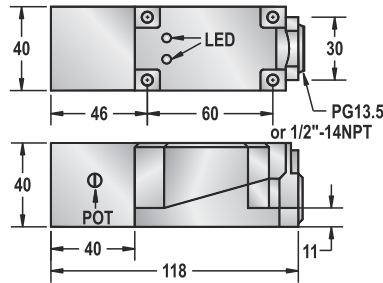

Size category	40*40	40*40
● Shielded ○ Non-shielded ● Semi-shielded	○	○
Sn: mm	2-40mm Adjustable	2-15mm Adjustable
Shell material	PBT	PBT
● LED display ○ No LED display	●	●
Operating voltage	10-30VDC	10-30VDC
Allowable pulsating voltage	<10%	<10%
No-load current	<10mA	<10mA
Maximum load current	200mA	200mA
Leakage current	<0.01mA	<0.01mA
Voltage drop	<2V	<2V
Switching frequency	100HZ	100HZ
Response time	1.5ms	1.5ms
Switching hysteresis	<15%(Sr)	<15%(Sr)
Repeat accuracy	<1.0%(Sr)	<1.0%(Sr)
Protection level	IP67	IP67
Operating temperature	-25°C— +70°C	-25°C— +70°C
Temperature drift	<10%(Sr)	<10%(Sr)
Short circuit protection/reverse polarity protection	Yes	Yes
Overload protection current	220mA	220mA
Sensing surface material	PBT	PBT
Connection method	Quick Connectors	Quick Connectors
Product Model		
DC 3 wire 10-30V NPN NO	CE40-40NO-ZBA-3A-P	CE40-15NO-ZBA-TA-P
DC 3 wire 10-30V NPN NC	CE40-40NC-ZBA-3A-P	CE40-15NC-ZBA-TA-P
DC 3 wire 10-30V PNP NO	CE40-40PO-ZBA-3A-P	CE40-15PO-ZBA-TA-P
DC 3 wire 10-30V PNP NC	CE40-40PC-ZBA-3A-P	CE40-15PC-ZBA-TA-P
DC 4 wire 10-30V Convertible PNP (NO&NC)	CE40-40PS-ZBA-4A-P	CE40-15PS-ZBA-TA-P
DC 4 wire 10-30V Convertible NPN (NO&NC)	CE40-40NS-ZBA-4A-P	CE40-15NS-ZBA-TA-P
DC 2 wire 10-60V NO		
DC 2 wire 10-60V NC		
DC 3 wire 10-55V NPN NO		
DC 3 wire 10-55V NPN NC		
DC 3 wire 10-55V PNP NO		
DC 3 wire 10-55V PNP NC		
DC 3 wire 5-36V NPN NO		
DC 3 wire 5-36V NPN NC		
DC 3 wire 5-36V PNP NO		
DC 3 wire 5-36V PNP NC		
DC 4 wire 5-36V Convertible PNP (NO&NC)		
DC 4 wire 5-36V Convertible NPN (NO&NC)		

Product Parameters

Square Series

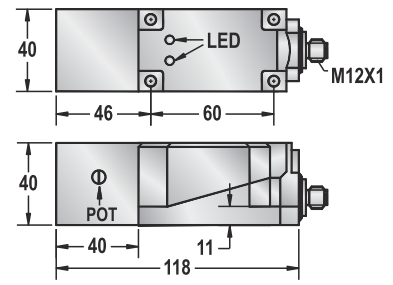
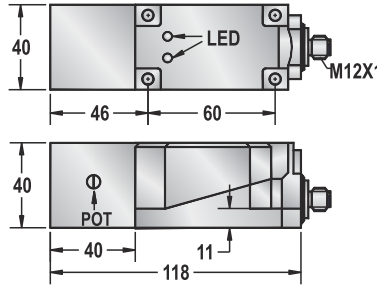

Size category

40*40

40*40

● Shielded ○ Non-shielded ◐ Semi-shielded

Sn: mm

2-20mm Adjustable

2-30 mm Adjustable

Shell material

PBT

PBT

● LED display ○ No LED display

Operating voltage

10-30VDC

10-30VDC

Allowable pulsating voltage

<10%

<10%

No-load current

<10mA

<10mA

Maximum load current

200mA

200mA

Leakage current

<0.01mA

<0.01mA

Voltage drop

<2V

<2V

Switching frequency

100HZ

100HZ

Response time

1.5ms

1.5ms

Switching hysteresis

<15%(Sr)

<15%(Sr)

Repeat accuracy

<1.0%(Sr)

<1.0%(Sr)

Protection level

IP67

IP67

Operating temperature

-25°C— +70°C

-25°C— +70°C

Temperature drift

<10%(Sr)

<10%(Sr)

Short circuit protection/reverse polarity protection

Yes

Yes

Overload protection current

220mA

220mA

Sensing surface material

PBT

PBT

Connection method

M12 Connectors

M12 Connectors

Product Model

DC 3 wire 10-30V NPN NO

CE40-20NO-YAA-TA-P

CE40-30NO-YBA-TA-P

DC 3 wire 10-30V NPN NC

CE40-20NC-YAA-TA-P

CE40-30NC-YBA-TA-P

DC 3 wire 10-30V PNP NO

CE40-20PO-YAA-TA-P

CE40-30PO-YBA-TA-P

DC 3 wire 10-30V PNP NC

CE40-20PC-YAA-TA-P

CE40-30PC-YBA-TA-P

DC 4 wire 10-30V Convertible PNP (NO&NC)

CE40-20PS-YAA-TA-P

CE40-30PS-YBA-TA-P

DC 4 wire 10-30V Convertible NPN (NO&NC)

CE40-20NS-YAA-TA-P

CE40-30NS-YBA-TA-P

DC 2 wire 10-60V NO

DC 2 wire 10-60V NC

DC 3 wire 10-55V NPN NO

DC 3 wire 10-55V NPN NC

DC 3 wire 10-55V PNP NO

DC 3 wire 10-55V PNP NC

DC 3 wire 5-36V NPN NO

DC 3 wire 5-36V NPN NC

DC 3 wire 5-36V PNP NO

DC 3 wire 5-36V PNP NC

DC 4 wire 5-36V Convertible PNP (NO&NC)

DC 4 wire 5-36V Convertible NPN (NO&NC)

Product Parameters

Square Series

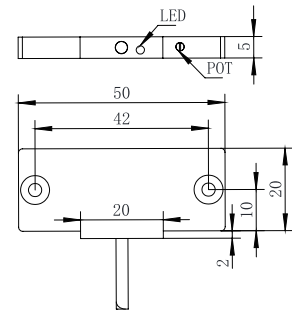
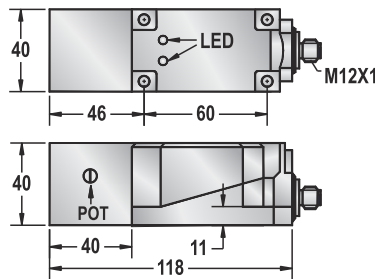
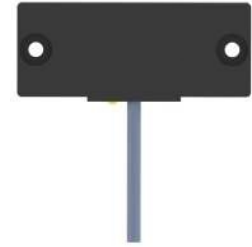

Size category

40*40

50*20*5

● Shielded ○ Non-shielded ● Semi-shielded	○	○
Sn: mm	2-40mm Adjustable	5mm Adjustable
Shell material	PBT	PBT
● LED display ○ No LED display	●	●
Operating voltage	10-30VDC	10-30VDC
Allowable pulsating voltage	<10%	<10%
No-load current	<10mA	<10mA
Maximum load current	200mA	200mA
Leakage current	<0.01mA	<0.01mA
Voltage drop	<2V	<1.5V
Switching frequency	100HZ	300HZ
Response time	1.5ms	1ms
Switching hysteresis	<15%(Sr)	<15%(Sr)
Repeat accuracy	<1.0%(Sr)	<1.0%(Sr)
Protection level	IP67	IP67
Operating temperature	-25°C— +70°C	-25°C— +70°C
Temperature drift	<10%(Sr)	<10%(Sr)
Short circuit protection/reverse polarity protection	Yes	Yes
Overload protection current	220mA	220mA
Sensing surface material	PBT	PBT
Connection method	M12 Connectors	2m oil-proof PUR cable 3.0 φ 3x0.15
Product Model		
DC 3 wire 10-30V NPN NO	CE40-40NO-YBA-TA-P	CE50-05NO-ZBA-3A-P
DC 3 wire 10-30V NPN NC	CE40-40NC-YBA-TA-P	CE50-05NC-ZBA-3A-P
DC 3 wire 10-30V PNP NO	CE40-40PO-YBA-TA-P	CE50-05PO-ZBA-3A-P
DC 3 wire 10-30V PNP NC	CE40-40PC-YBA-TA-P	CE50-05PC-ZBA-3A-P
DC 4 wire 10-30V Convertible PNP (NO&NC)	CE40-40PS-YBA-TA-P	CE50-05PS-ZBA-4A-P
DC 4 wire 10-30V Convertible NPN (NO&NC)	CE40-40NS-YBA-TA-P	CE50-05NS-ZBA-4A-P
DC 2 wire 10-60V NO		
DC 2 wire 10-60V NC		
DC 3 wire 10-55V NPN NO		
DC 3 wire 10-55V NPN NC		
DC 3 wire 10-55V PNP NO		
DC 3 wire 10-55V PNP NC		
DC 3 wire 5-36V NPN NO		
DC 3 wire 5-36V NPN NC		
DC 3 wire 5-36V PNP NO		
DC 3 wire 5-36V PNP NC		
DC 4 wire 5-36V Convertible PNP (NO&NC)		
DC 4 wire 5-36V Convertible NPN (NO&NC)		

Product Parameters

Square Series

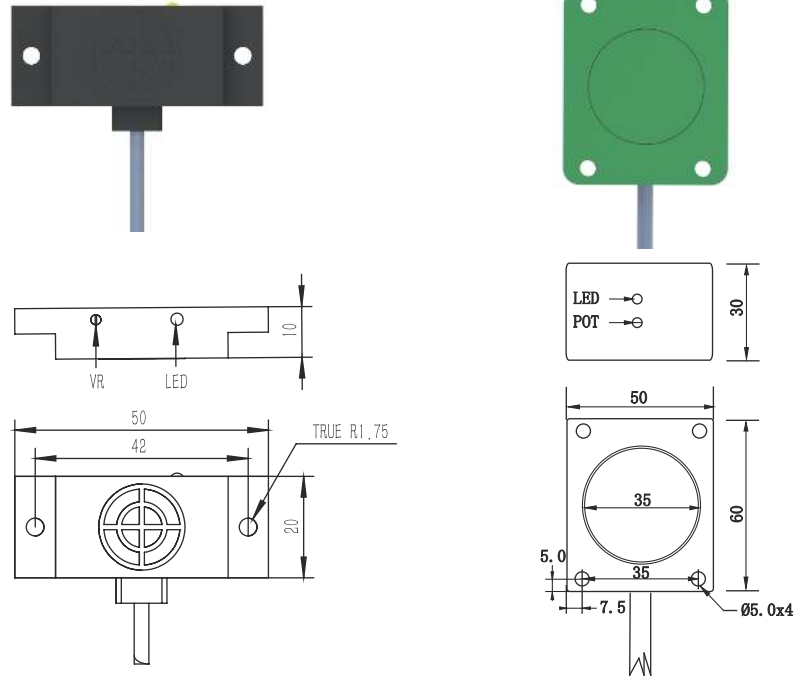

Size category	50*20*10		50*60*30
● Shielded ○ Non-shielded	○		○
Sn: mm	2-10 mm Adjustable	2-20 mm Adjustable	2-60mm Adjustable
Shell material	PBT		PTFE
● LED display ○ No LED display	●		●
Operating voltage	10-30VDC		10-30VDC
Allowable pulsating voltage	<10%		<10%
No-load current	<10mA		<10mA
Maximum load current	200mA		200mA
Leakage current	<0.01mA		<0.01mA
Voltage drop	<1.5V		<1.5V
Switching frequency	300HZ		100HZ
Response time	1ms		1ms
Switching hysteresis	<15%(Sr)		<15%(Sr)
Repeat accuracy	<1.0%(Sr)		<1.0%(Sr)
Protection level	IP67		IP67
Operating temperature	-25°C— +70°C		-25°C— +70°C
Temperature drift	<10%(Sr)		<10%(Sr)
Short circuit protection/reverse polarity protection	Yes		Yes
Overload protection current	220mA		220mA
Sensing surface material	PBT		PBT
Connection method	2m oil-proof PUR cable 3.0 φ 3x0.15		2m oil-proof PUR cable 3.0 φ 3x0.15
Product Model			
DC 3 wire 10-30V NPN NO	CE50-10NO-ZBA-3A-P	CE50-20NO-ZBA-3A-P	CE50-60NO-ZBA-3A-F
DC 3 wire 10-30V NPN NC	CE50-10NC-ZBA-3A-P	CE50-20NC-ZBA-3A-P	CE50-60NC-ZBA-3A-F
DC 3 wire 10-30V PNP NO	CE50-10PO-ZBA-3A-P	CE50-20PO-ZBA-3A-P	CE50-60PO-ZBA-3A-F
DC 3 wire 10-30V PNP NC	CE50-10PC-ZBA-3A-P	CE50-20PC-ZBA-3A-P	CE50-60PC-ZBA-3A-F
DC 4 wire 10-30V Convertible PNP (NO&NC)	CE50-10PS-ZBA-4A-P	CE50-20PS-ZBA-4A-P	
DC 4 wire 10-30V Convertible NPN (NO&NC)	CE50-10NS-ZBA-4A-P	CE50-20NS-ZBA-4A-P	
DC 2 wire 10-60V NO			
DC 2 wire 10-60V NC			
DC 3 wire 10-55V NPN NO			
DC 3 wire 10-55V NPN NC			
DC 3 wire 10-55V PNP NO			
DC 3 wire 10-55V PNP NC			
DC 3 wire 5-36V NPN NO			
DC 3 wire 5-36V NPN NC			
DC 3 wire 5-36V PNP NO			
DC 3 wire 5-36V PNP NC			
DC 4 wire 5-36V Convertible PNP (NO&NC)			
DC 4 wire 5-36V Convertible NPN (NO&NC)			

Product Parameters

Square Series

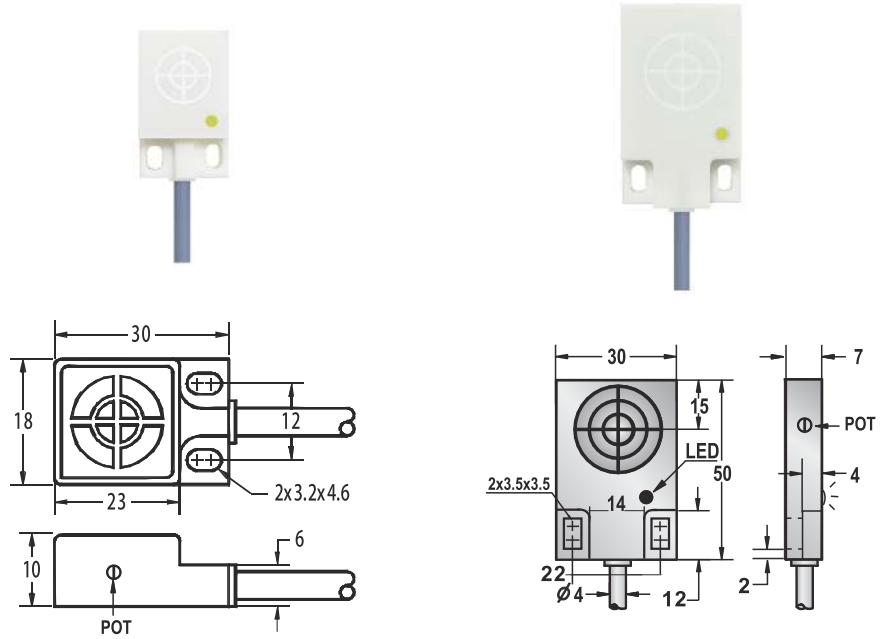

Size category	30*18*10		30*50*7	
● Shielded ○ Non-shielded	●	○	●	○
Sn: mm	1-6mm Adjustable	1-8mm Adjustable	1-10mm Adjustable	2-20mm Adjustable
Shell material	PTFE		PTFE	
● LED display ○ No LED display	●		●	
Operating voltage	10-30VDC		10-30VDC	
Allowable pulsating voltage	<10%		<10%	
No-load current	<10mA		<10mA	
Maximum load current	200mA		200mA	
Leakage current	<0.01mA		<0.01mA	
Voltage drop	<1.5V		<1.5V	
Switching frequency	100HZ		100HZ	
Response time	1.5ms		1.5ms	
Switching hysteresis	<15%(Sr)		<15%(Sr)	
Repeat accuracy	<5%(Sr)		<5%(Sr)	
Protection level	IP67		IP67	
Operating temperature	-25°C— +70°C		-25°C— +70°C	
Temperature drift	<10%(Sr)		<10%(Sr)	
Short circuit protection/reverse polarity protection	Yes		Yes	
Overload protection current	220mA		220mA	
Sensing surface material	PTFE		PTFE	
Connection method	2m oil-proof PUR/PTFE cable 4 φ 3x0.15		2m oil-proof PUR/PTFE cable 4 φ 3x0.15	
Product Model				
DC 3 wire 10-30V NPN NO	CE18-06NO-ZAA-3A-F	CE18-08NO-ZBA-3A-F	CE30-10NO-ZAA-3A-F	CE30-20NO-ZBA-3A-F
DC 3 wire 10-30V NPN NC	CE18-06NC-ZAA-3A-F	CE18-08NC-ZBA-3A-F	CE30-10NC-ZAA-3A-F	CE30-20NC-ZBA-3A-F
DC 3 wire 10-30V PNP NO	CE18-06PO-ZAA-3A-F	CE18-08PO-ZBA-3A-F	CE30-10PO-ZAA-3A-F	CE30-20PO-ZBA-3A-F
DC 3 wire 10-30V PNP NC	CE18-06PC-ZAA-3A-F	CE18-08PC-ZBA-3A-F	CE30-10PC-ZAA-3A-F	CE30-20PC-ZBA-3A-F
DC 4 wire 10-30V Convertible PNP (NO&NC)				
DC 4 wire 10-30V Convertible NPN (NO&NC)				
DC 2 wire 10-60V NO				
DC 2 wire 10-60V NC				
DC 3 wire 10-55V NPN NO				
DC 3 wire 10-55V NPN NC				
DC 3 wire 10-55V PNP NO				
DC 3 wire 10-55V PNP NC				
DC 3 wire 5-36V NPN NO				
DC 3 wire 5-36V NPN NC				
DC 3 wire 5-36V PNP NO				
DC 3 wire 5-36V PNP NC				
DC 4 wire 5-36V Convertible PNP (NO&NC)				
DC 4 wire 5-36V Convertible NPN (NO&NC)				

Product Parameters

Square Series

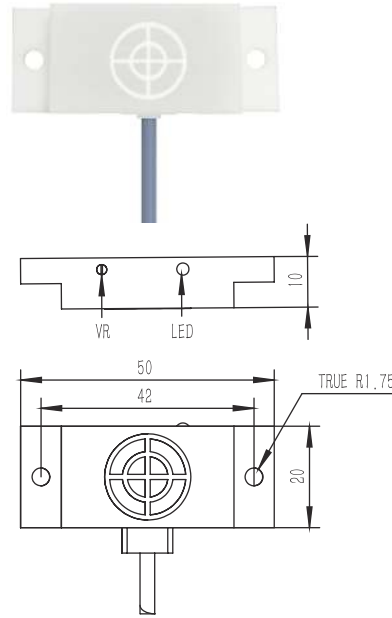

Size category

50*20*10

● Shielded ○ Non-shielded	●	○
Sn: mm	2-10 mm Adjustable	2-20 mm Adjustable
Shell material	PTFE	
● LED display ○ No LED display	●	
Operating voltage	10-30VDC	
Allowable pulsating voltage	<10%	
No-load current	<10mA	
Maximum load current	200mA	
Leakage current	<0.01mA	
Voltage drop	<1.5V	
Switching frequency	100HZ	
Response time	1ms	
Switching hysteresis	<15%(Sr)	
Repeat accuracy	<1.0%(Sr)	
Protection level	IP67	
Operating temperature	-25°C— +70°C	
Temperature drift	<10%(Sr)	
Short circuit protection/reverse polarity protection	Yes	
Overload protection current	220mA	
Sensing surface material	PTFE	
Connection method	2m oil-proof PUR/PTFE cable 3 φ 3x0.15	
Product Model		
DC 3 wire 10-30V NPN NO	CE50-10NO-ZAA-3A-F	CE50-20NO-ZBA-3A-F
DC 3 wire 10-30V NPN NC	CE50-10NC-ZAA-3A-F	CE50-20NC-ZBA-3A-F
DC 3 wire 10-30V PNP NO	CE50-10PO-ZAA-3A-F	CE50-20PO-ZBA-3A-F
DC 3 wire 10-30V PNP NC	CE50-10PC-ZAA-3A-F	CE50-20PC-ZBA-3A-F
DC 4 wire 10-30V Convertible PNP (NO&NC)	CE50-10PS-ZAA-4A-F	CE50-20PS-ZBA-4A-F
DC 4 wire 10-30V Convertible NPN (NO&NC)	CE50-10NS-ZAA-4A-F	CE50-20NS-ZBA-4A-F
DC 2 wire 10-60V NO		
DC 2 wire 10-60V NC		
DC 3 wire 10-55V NPN NO		
DC 3 wire 10-55V NPN NC		
DC 3 wire 10-55V PNP NO		
DC 3 wire 10-55V PNP NC		
DC 3 wire 5-36V NPN NO		
DC 3 wire 5-36V NPN NC		
DC 3 wire 5-36V PNP NO		
DC 3 wire 5-36V PNP NC		
DC 4 wire 5-36V Convertible PNP (NO&NC)		
DC 4 wire 5-36V Convertible NPN (NO&NC)		

Wiring Diagram

DC NPN NO

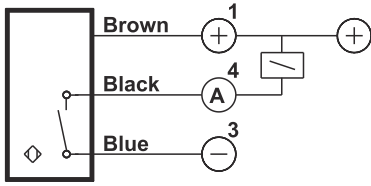

DC NPN NC

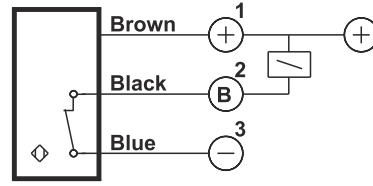

DC PNP NO

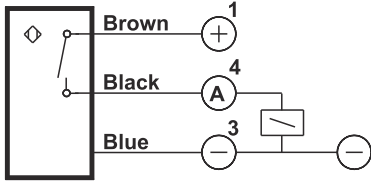

DC PNP NC

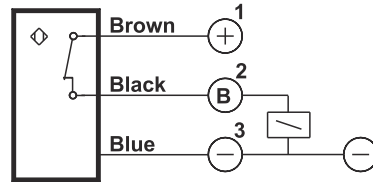

DC NPN NO&NC

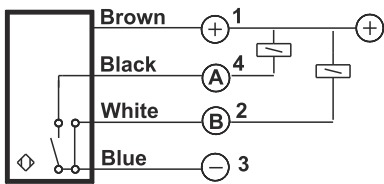

DC PNP NO&NC

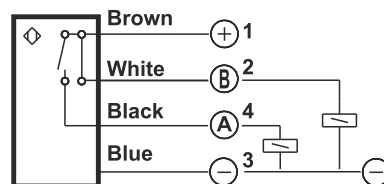

DC 2 wire NO

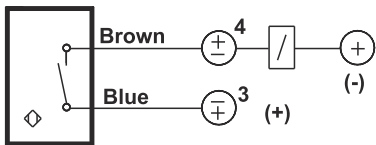

DC 2 wire NC

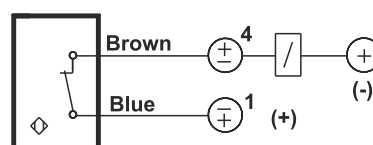

Plastic housing AC/DC 20-250V or AC 20-250V TWO WIRE-NO

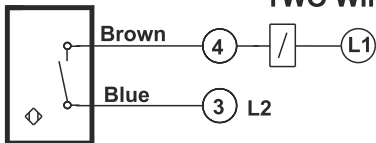

Plastic housing AC/DC 20-250V or AC 20-250V TWO WIRE-NC

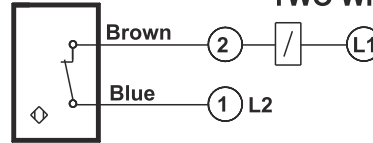

Metal housing AC/DC 20-250V or AC 20-250V TWO WIRE-NO

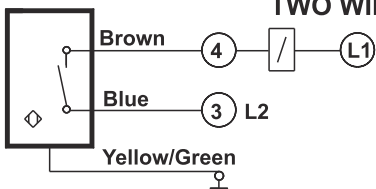

Metal housing AC/DC 20-250V or AC 20-250V TWO WIRE-NC

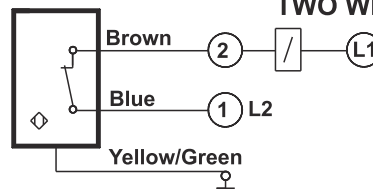

Wiring Diagram

Plastic housing AC 20-250V
NO,NC Changeable

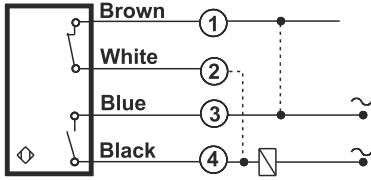

Metal housing AC 20-250V
NO,NC Changeable

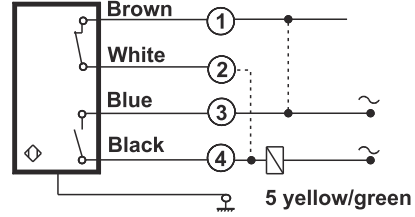

Plastic housing AC 20-250V
NO,NC Changeable

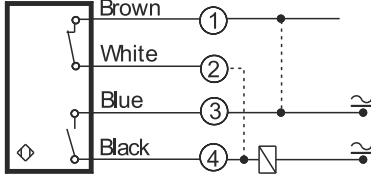

Metal housing AC 20-250V
NO,NC Changeable

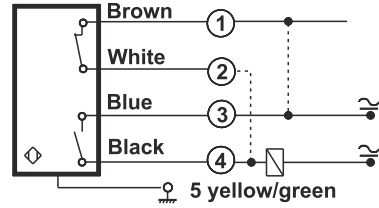

Analog (current + voltage output type)

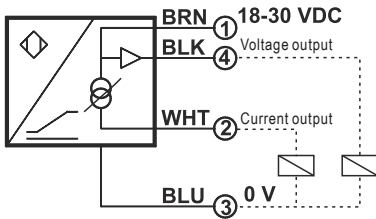

Analog (current output type)

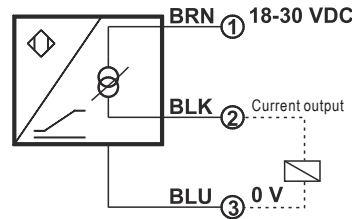

Riot-proof DC 6-12V

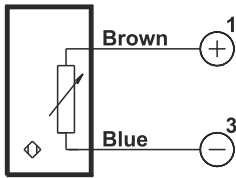

Analog (voltage output type)

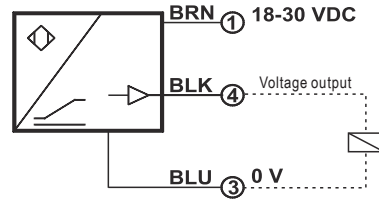

Connector Diagram

Used for M8 DC
M8

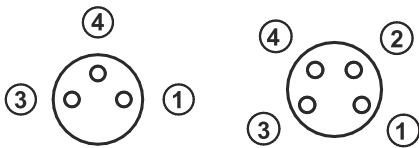

Used for M12 DC
M12

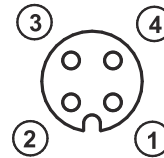

Used for M12 AC
M12

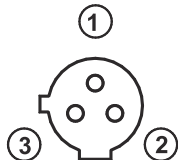

Used for M18 M30 DC or AC

