

TECHNICAL DATA SHEET

LASER RANGING SENSOR GFL-Y series



Figure can vary

Contents

- Product Features
- Application Scenario
- Model Selection
- Size parameter
- Circuit wiring diagram



Long distance laser ranging sensor GFL-F series

The detection distance is not affected by the color of the tested object

- ⊙ Self developed phase measurement method;
- ⊙ Quick and accurate measurement options in both Chinese and English;
- ⊙ No need to connect to a computer to set up;
- ⊙ Built in baud rate and station number selection, with a maximum of 255 units for networking;
- ⊙ Can be used in conjunction with PLC or software;
- ⊙ IP67 protection, dustproof and waterproof, with a metal body.

No need to connect to PC to set up

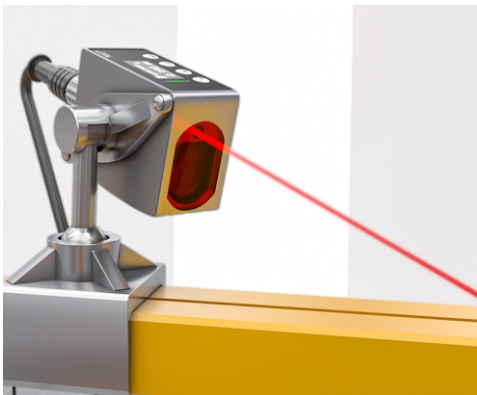

Press SET once when there is no product, and press SET again when there is a product, you can easily set the switch output, and also support upper and lower limit settings.

Multiple ranges and models available

- ◇ Switching quantity + RS485 + analog quantity (current, voltage) optional
- ◇ Multiple output types to meet different equipment needs

Application Cases

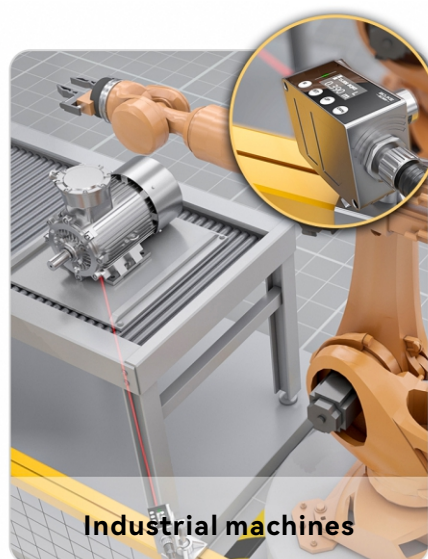
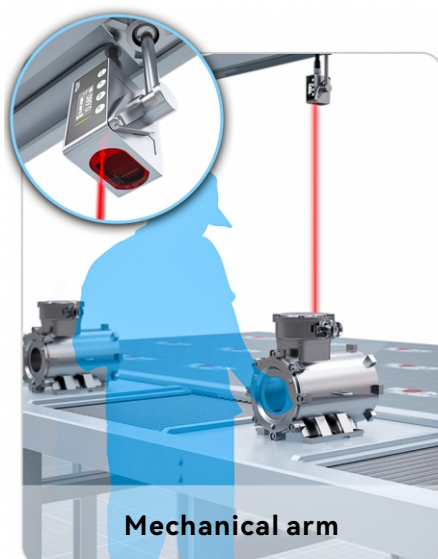

Technical Parameters

Item	Model		
NPN+analog+485	GFL-Y01IU-485-N	GFL-Y02IU-485-N	GFL-Y05IU-485-N
PNP+analog+485	GFL-Y01IU-485-P	GFL-Y02IU-485-P	GFL-Y05IU-485-P
Measure distance	0.1-1m	0.1-2m	0.1-5m

Item	Model		
NPN+analog+485	GFL-Y10IU-485-N	GFL-Y20IU-485-N	GFL-Y50IU-485-N
PNP+analog+485	GFL-Y10IU-485-P	GFL-Y20IU-485-P	GFL-Y50IU-485-P
Measure distance	0.1-10m	0.1-20m	0.1-50m

Resolution	1mm
Measurement error	$+(2\text{mm}+d*1/10,000)$ ★
Laser type	Red semiconductor laser Class II laser 655+10nm<1mW
Voltage	12V-24VDC+10% pulsation P-P10%
Current consumption	≤50mA @24V
Control output	NPN or PNP open drain output Open drain collector transistor output Maximum current:50mA Applied voltage: less than 30V DC Residual voltage: less than 1.5V Leakage current: less than 0.1mA
Output action	Normally open/normally closed can be switched
Short circuit protection	Automatic recovery type
Analog voltage output	Output range: 0-5V (alarm: 5.2V) Output impedance: 100Ω
Analog current output	Output range: 4-20mA (alarm: 0mA) Output impedance: 300Ω max
Reaction time	50-200ms
External input	NPN contactless input
Protective structure	IP67
Operating temperature	-10C~+45°C (be careful not to condense or freeze)
Storage temperature	-20°C~+60°C
Working humidity	35%~85%RH
Use ambient illumination	Incandescent lamp: light receiving surface illumination below 3000lux
Use elevation	Below 2000m
Cable	With 8-core composite cable 2m
Material	Aluminum parts
Quality	About 150g

★: Indicates the measurement distance. In harsh environments, such as when the sunlight is too strong, the ambient temperature fluctuates too much, and the reflective surface is dark, the measurement results will have larger errors. In this case, the use of a target reflective plate will be better.

Display and Buttons

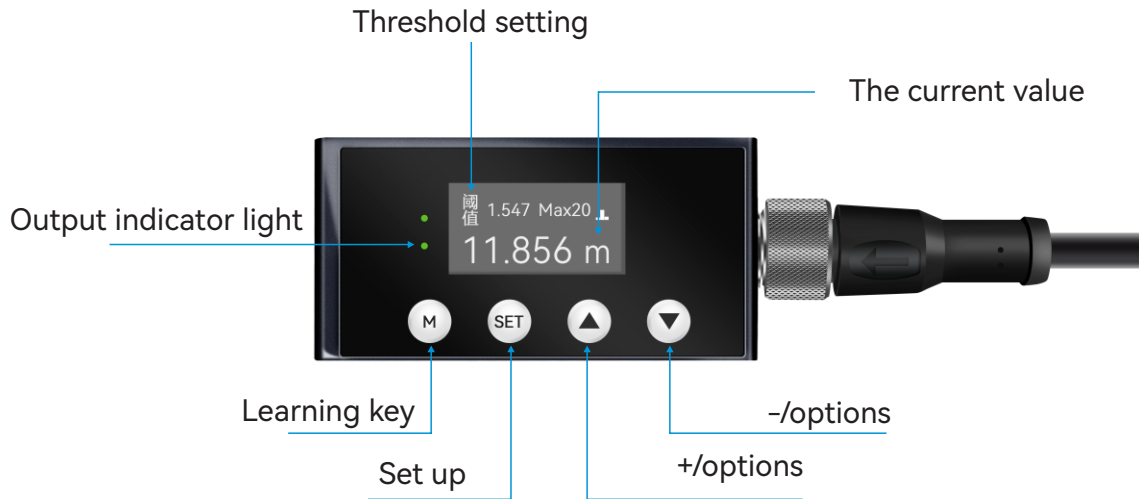

Installation Dimensions

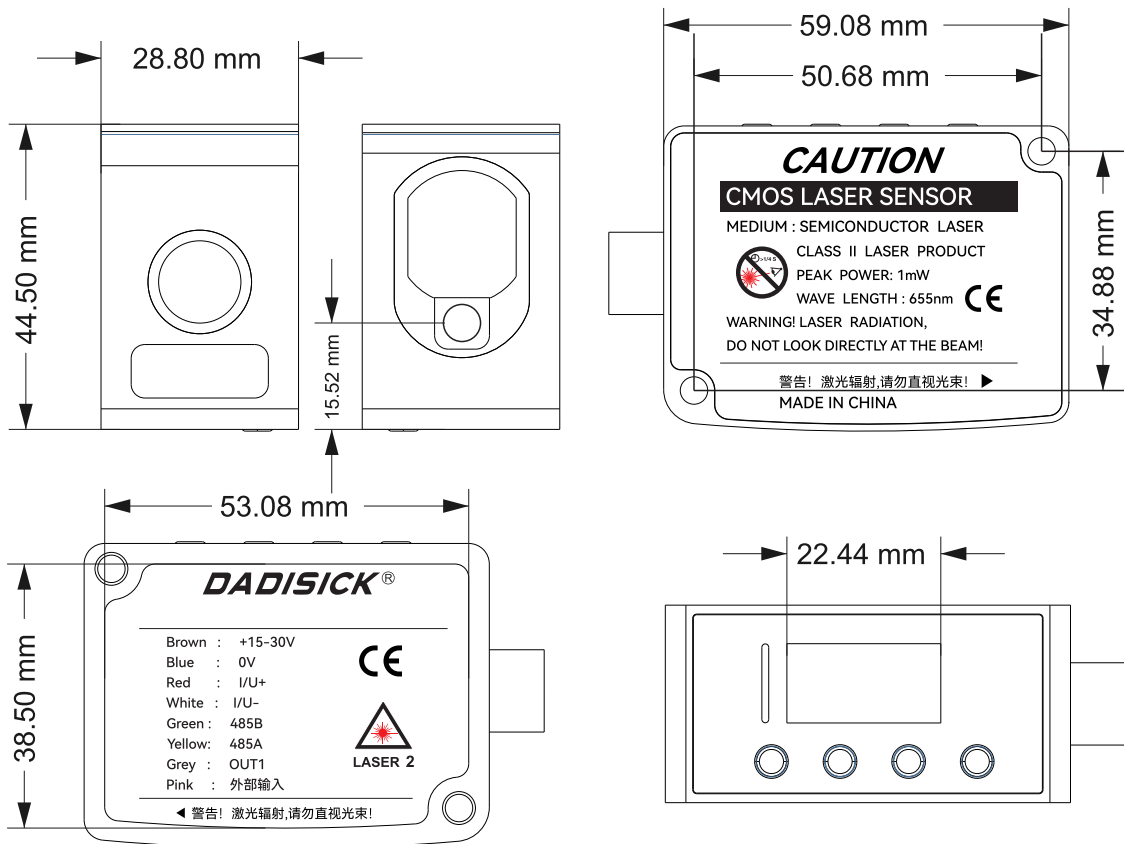

Wiring method

● Switching output

NPN output

Example 1: Example of alarm light

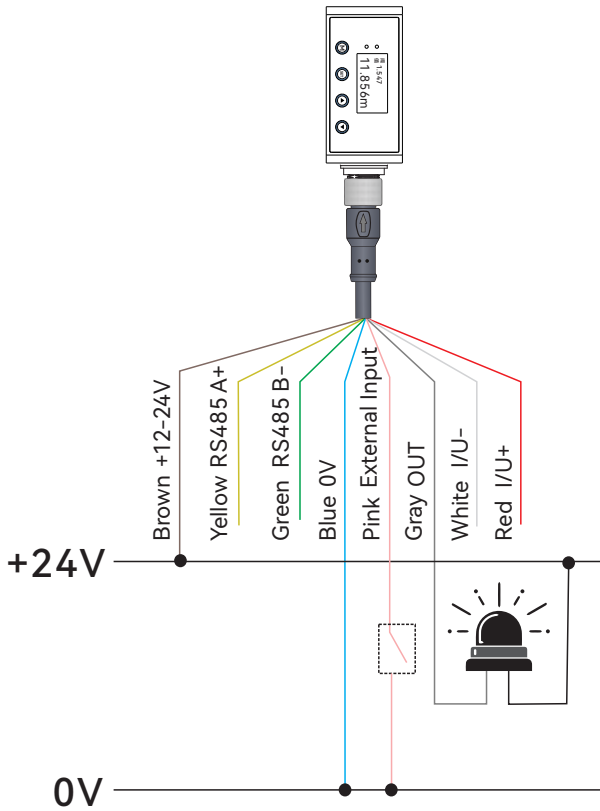

Note: When the external function is not used, it is not necessary to connect

PNP output

Example 2: K1 is a load relay

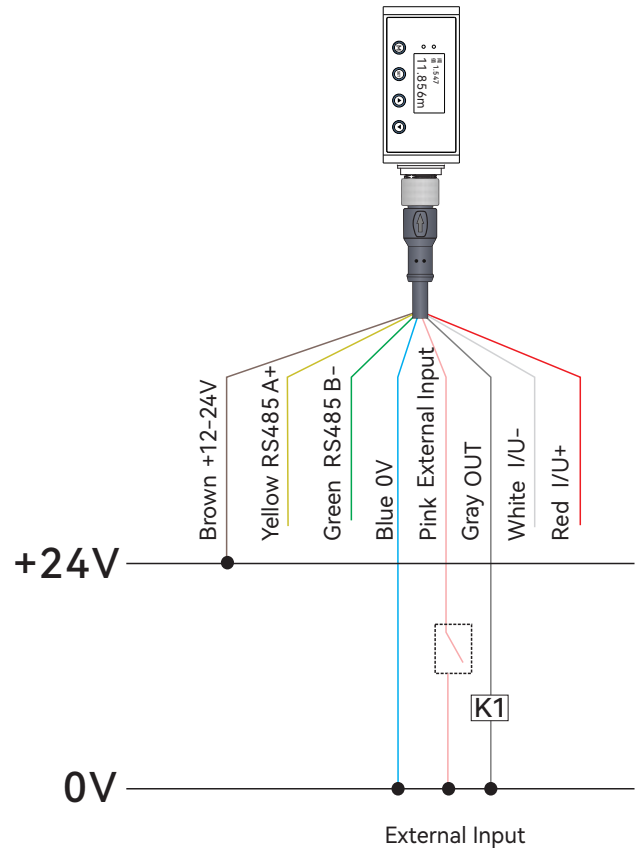

● RS485 output, analog output

Note:

1. The power supply of the instrument in the figure is provided by 24V
2. I/U interpretation, 1: 4-20mA U: 0-5V

