

# TECHNICAL DATA SHEET

## SAFETY LIGHT CURTAIN SENSOR

Emitter: QM200/2.5-497.5-2BA-E

Receiver: QM200/2.5-497.5-2BA-R



Figure can vary

### Contents

- Product application
- Technical data
- Operation and display
- Dimensioned drawings
- Electrical connection
- Wiring diagram
- Accessories



GB/T 19001-2016

## Product application

- A. Light curtain can achieve full protection for the slider can be stopped at any position on the press machine.
- B. The light curtain can only achieve upper dead point protection if the slider can not be stopped at any position on the press machine.
- C. Realize the regional protection for the industry manipulator, injection molding machines, packaging equipment, automation equipment, assembly wires and other dangerous work area.
- D. Used to detect and alarm object.

## Technical data

### Basic data of Receiver and Emitter

<b>Standard packaging</b>	
Product model	<b>QM200/2.5-497.5-2BA-E</b> and <b>QM200/2.5-477.5-2BA-R</b>
Standard configuration	One receiver, one transmitter, two data lines, one right-angle rack, and one t-shaped screw
Light curtain form	Infrared radiation type
Application	Standard industrial environment - finger protection
<b>Features</b>	
Resolution ratio	2.5mm
Check the accuracy	3.75mm
Number of beams	200
Protection height	497.5mm
Total height	554.5mm
Detection distance	30-3000mm
Response time	≤15ms
<b>Synchronization</b>	
Synchronization	Line synchronization
Consumption current	≤200mA
Output mode	2-circuit of PNP, with current of 500mA and voltage below 1.5V, polarity, short circuit and over-cutting protection
Output status	ON (receiving indicator green light)
Indicator light	Transmitter: power indicator light (red); receiver: output indicator light on (green), blackout (red)
Wavelength	850nm
Type of light	Infrared light (NIR), invisible
Function	Automatic reset
<b>Mechanical data</b>	
Overall dimension	36*36*554.5mm
Housing material	Metal
Metal shell	Aluminium
Lens front screen material	Acrylic
Upper and lower cover materials	ABS reinforced nylon PA66+30% GF
<b>Environmental data</b>	
Protection grade	IP65
Resistance to ambient light	Incandescent light: illumination of light-receiving surface 3000Lx; Sunlight: illumination of light-receiving surface 10000Lx
Ambient temperature	Working temperature: - 10~+40 °C (but not frozen), storage temperature: - 25 ~+55 °C
Ambient humidity	Working time: 35~85% RH, saving time: 35~95% RH

Performance data	
Protection circuit	Short circuit protection Overvoltage protection
Supply voltage	24VDC, -20...20%
Maximum current consumption	150mA
Fuse	2A half time interval
Output	
Number of safe output circuits (OSSD)	2-circuit
Type	Safety circuit output circuit OSSD
Minimum switch voltage high	18V
Minimum switch voltage low	2.5V
Typical switching voltage	22.5V
Voltage type	DC
Maximum current load	380mA
Load inductance	two thousand
Load capacity	zero point three
Maximum residual current	0.2mA
Typical residual current	0.002MA
Voltage drop	1.5V
Safety switch output 1	Connection pin 4, WHITE OSSD1
Switching element	Transistor PNP
Safety switch output 2	Connection pin 5, GREEN OSSD2
Switching element	Transistor PNP
Certificate	
CETÜV	No.E8A 104143 0001 Rev.00
ROHS certification	No.BSTDG180811032001CC
CE TYPE 4	No.ICR Polska/VC/HS221214
UL	No. 4790783741.1-S
GB/T	No. HIC180327 GB/T 19001-2016 idt ISO 9001:2015

## Operation and display



Status indicator	LED status Indicator	Explain
Emitter	 Red and Yellow, always on	Turns on the power
Receiver	 Red, always on	Turns on the power
	 Green and Red	All light paths are connected
	 Red and Yellow	The light is blocked or misaligned
	 Lights flashing	Interference or overstep detection range

## Dimensioned drawings

## QM 2.5mm series

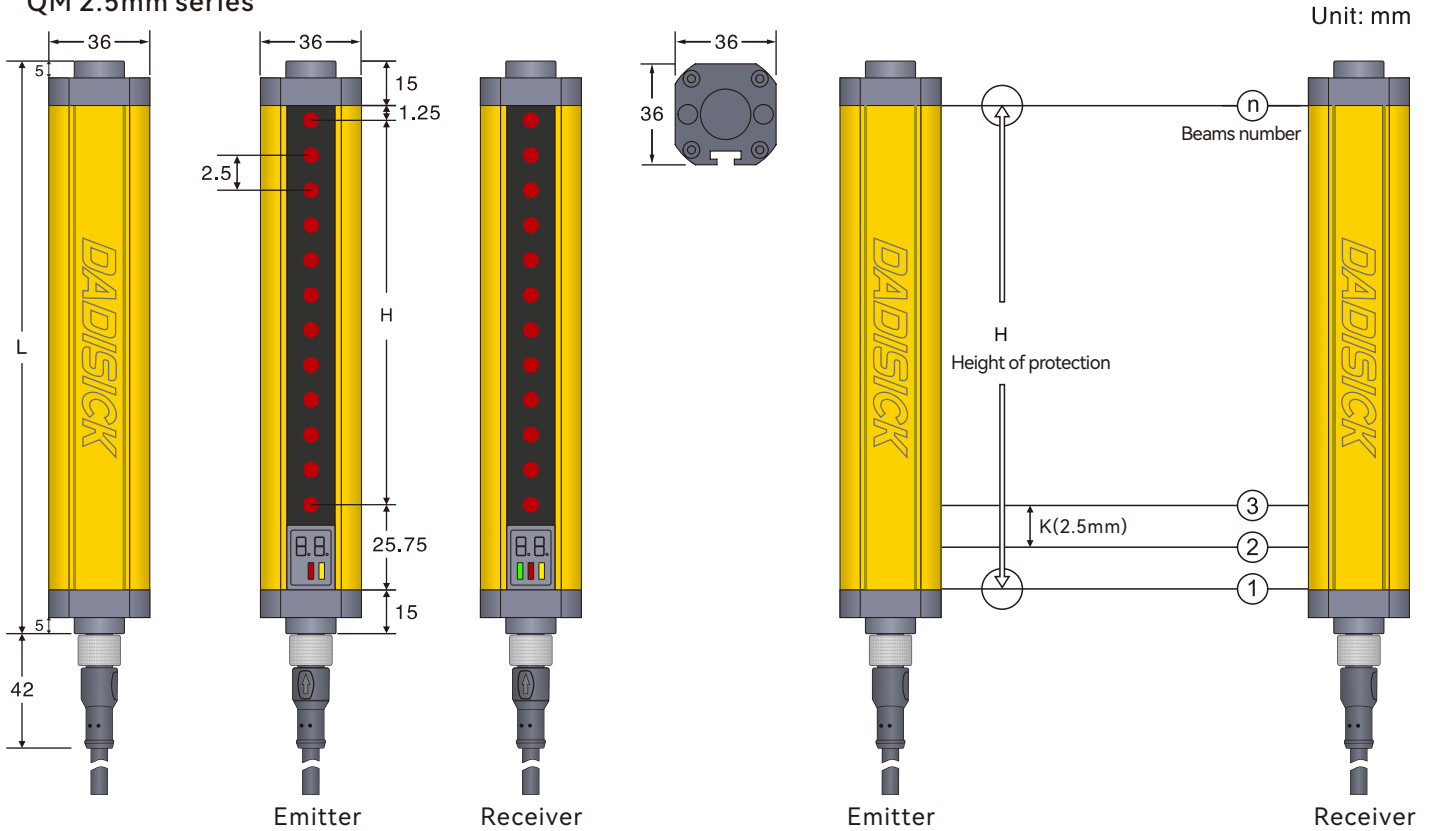

## Remarks

L: Total length of light screen  
 $L = 15 + 1.25 + H + 25.75 + 15$

H: Height of protected area  
 $H = (n - 1) * 2.5$

K: Resolution ratio

n: Beams number

## QM 2.5mm specification list

Resolution	Light beam	Protection height (H)	Total height (L)	Product model	Signal output mode		Detection range
					Two outputs	PNP output	
2.5mm (K)	32	77.5	134.5	QM32/2.5-77.5	2	PNP	0.3-3m
	40	97.5	154.5	QM40/2.5-97.5	2	PNP	0.3-3m
	48	117.5	174.5	QM48/2.5-117.5	2	PNP	0.3-3m
	56	137.5	194.5	QM56/2.5-137.5	2	PNP	0.3-3m
	64	157.5	214.5	QM64/2.5-157.5	2	PNP	0.3-3m
	72	177.5	234.5	QM72/2.5-177.5	2	PNP	0.3-3m
	80	197.5	254.5	QM80/2.5-197.5	2	PNP	0.3-3m
	88	217.5	274.5	QM88/2.5-217.5	2	PNP	0.3-3m
	96	237.5	294.5	QM96/2.5-237.5	2	PNP	0.3-3m
	104	257.5	314.5	QM104/2.5-257.5	2	PNP	0.3-3m
	112	277.5	334.5	QM112/2.5-277.5	2	PNP	0.3-3m
	120	297.5	354.5	QM120/2.5-297.5	2	PNP	0.3-3m
	128	317.5	374.5	QM128/2.5-317.5	2	PNP	0.3-3m
	136	337.5	394.5	QM136/2.5-337.5	2	PNP	0.3-3m
	144	357.5	414.5	QM144/2.5-357.5	2	PNP	0.3-3m
	152	377.5	434.5	QM152/2.5-377.5	2	PNP	0.3-3m
	160	397.5	454.5	QM160/2.5-397.5	2	PNP	0.3-3m
	168	417.5	474.5	QM168/2.5-417.5	2	PNP	0.3-3m
	176	437.5	494.5	QM176/2.5-437.5	2	PNP	0.3-3m
	184	457.5	514.5	QM184/2.5-457.5	2	PNP	0.3-3m
	192	477.5	534.5	QM192/2.5-477.5	2	PNP	0.3-3m
	200	497.5	554.5	QM200/2.5-497.5	2	PNP	0.3-3m
	208	517.5	574.5	QM208/2.5-517.5	2	PNP	0.3-3m
	216	537.5	594.5	QM216/2.5-537.5	2	PNP	0.3-3m
224	557.5	614.5	QM224/2.5-557.5	2	PNP	0.3-3m	
232	577.5	634.5	QM232/2.5-577.5	2	PNP	0.3-3m	
240	597.5	654.5	QM240/2.5-597.5	2	PNP	0.3-3m	
248	617.5	674.5	QM248/2.5-617.5	2	PNP	0.3-3m	
...	...	...	...	...	2	PNP	0.3-3m
304	757.5	814.5	QM304/2.5-757.5	2	PNP	0.3-3m	
312	777.5	834.5	QM312/2.5-777.5	2	PNP	0.3-3m	
320	797.5	854.5	QM320/2.5-797.5	2	PNP	0.3-3m	

## Electrical connection

Electrical interface	
Number of interfaces	2 (receiver and transmitter)
Type	M12 connector, 7-pin
Interface metal	Copper nickel plating
Plug material	GY384 gray 30P
Allowable typical conductor section	0.25mm <sup>2</sup>
Maximum link cable	100m
Maximum allowable cable load	4.9A
Cable material	PVC

### Cable description:

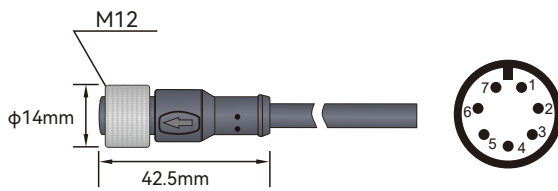

7-pin M12 cable connector straight  
3m waterproof cable

Emitter Wiring diagram		
Pin number	Line color	Name
1	BROWN	24V DC
2	BLUE	0V
3	BLACK	CP
4	WHITE	NC
5	GREEN	NC
6	RED	CE
7	YELLOW	Ground wire

Receiver Wiring diagram		
Pin number	Line color	Name
1	BROWN	24V DC
2	BLUE	0V
3	BLACK	CP
4	WHITE	OSSD1
5	GREEN	OSSD2
6	RED	CE
7	YELLOW	Ground wire

### 1. QM signal output selection (actual output of transistor working normally)

#### NPN NC



A

#### PNP NC



B

#### NPN NO



C

#### PNP NO



D

## 2. NPN output wiring diagram





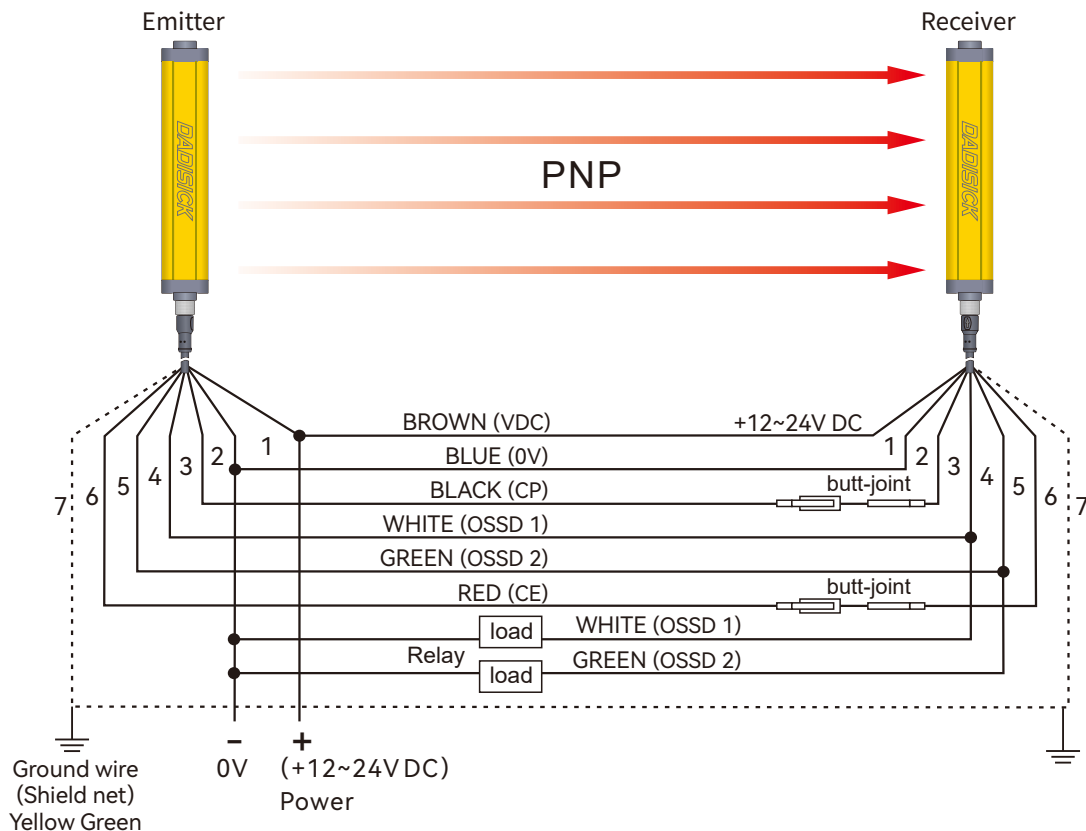

This figure is an example of NPN double output 7-pin wiring.

## 3. PNP output wiring diagram



This figure is an example of PNP double output 7-pin wiring.

#### 4. Selection of safety light curtain controller

Name	Order separately	Model	Descriptions
Built-in controller		QET	Used to monitor the signal processing of QM series light curtain, and output one group of NO and one group of NC.
Safety relay		QSRN	QSRN safety relays have three groups of NO and one group of NC, with strong control capabilities. They are suitable for various signal monitoring in industrial places with high safety requirements, including emergency stop signals, safety door opening and closing signals, safety light curtain signals, and two-handed button signals.
Safety relay	 Multifunctional switching switch	Ter-A	Equipped with a mode switch, it can be used for most safety components, such as light curtains, safety switches, carpet contacts, two handed switches, etc. Automatic/manual reset paddles for quick configuration. Dual channel monitoring circuit, safe and reliable.
Light curtain relay		QET-1	Output conversion between NC and NO for QM series light curtain.

#### 4.1 Wiring diagram of QET built-in controller

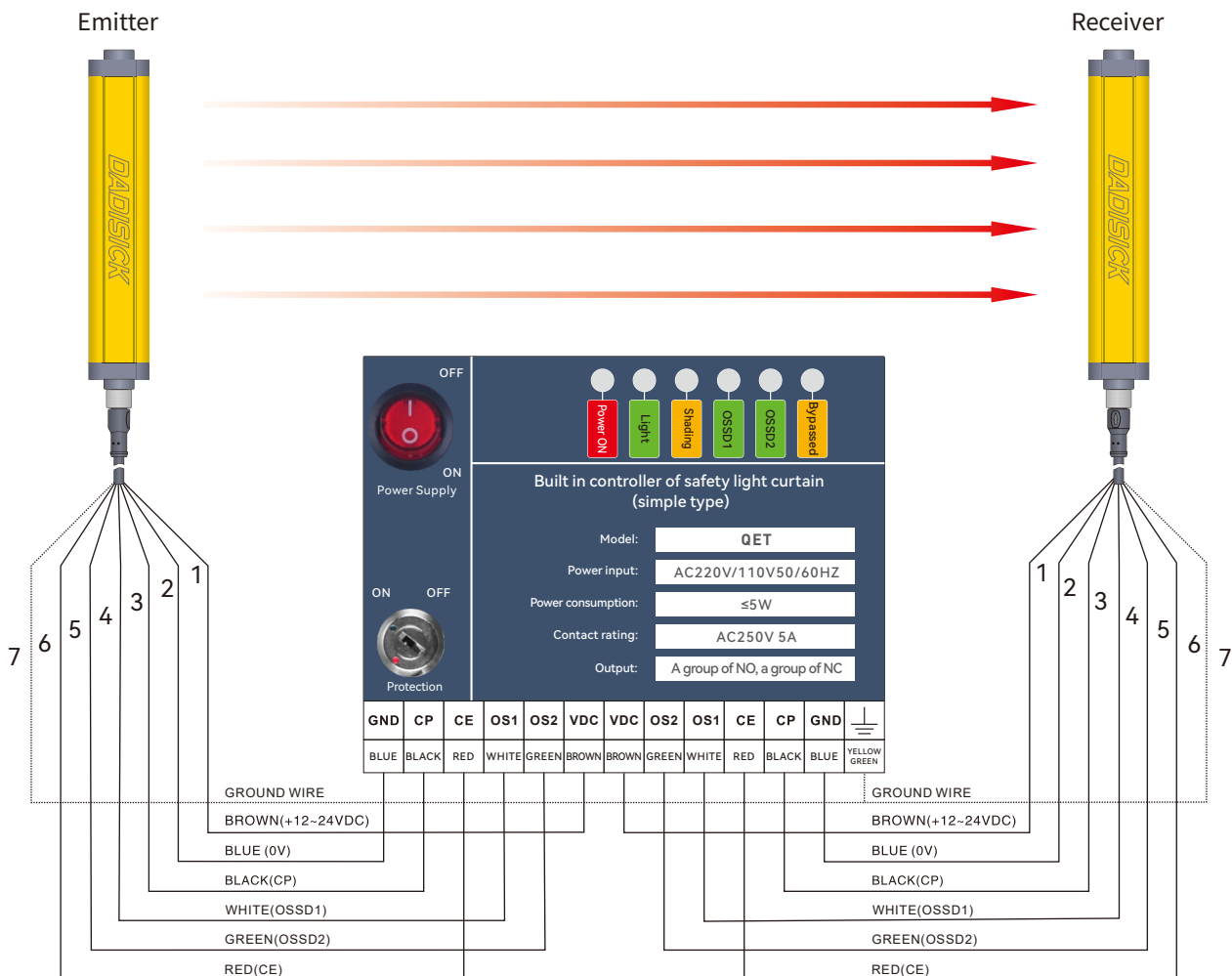



## 4.2 Wiring diagram of QSRN safety relay



## 4.3 Wiring diagram of Ter-A safety relay

Dual channel light curtain PNP switch safety input, with automatic reset and PLC signal output.



#### 4.4 Wiring diagram of QET-1 light curtain relay



#### 4.5 Wiring between light curtain and PLC and one-chip computer system

NPN wiring:



PNP wiring:



## Accessories



1. Installation of right angle brackets at both ends  
(Original accessories)



2. Installation method of T-shaped screws on the back  
(Original accessories)





3. Installation method of convex nut  
(Optional accessories)

Raised nut	Model: QCA-03-1
Unit:mm	
M5 screw	Model: QCA-03-2
Unit:mm	



4. Installation method of side right angle bracket  
(Optional accessories)

Side mounting bracket	Model: QCA-05
Unit:mm	



5. Stainless steel bracket installation  
(Order separately)

