

TECHNICAL DATA SHEET

SAFETY LIGHT CURTAIN SENSOR

Emitter: QCE62/30-1830-2BB-E

Receiver: QCE62/30-1830-2BB-R

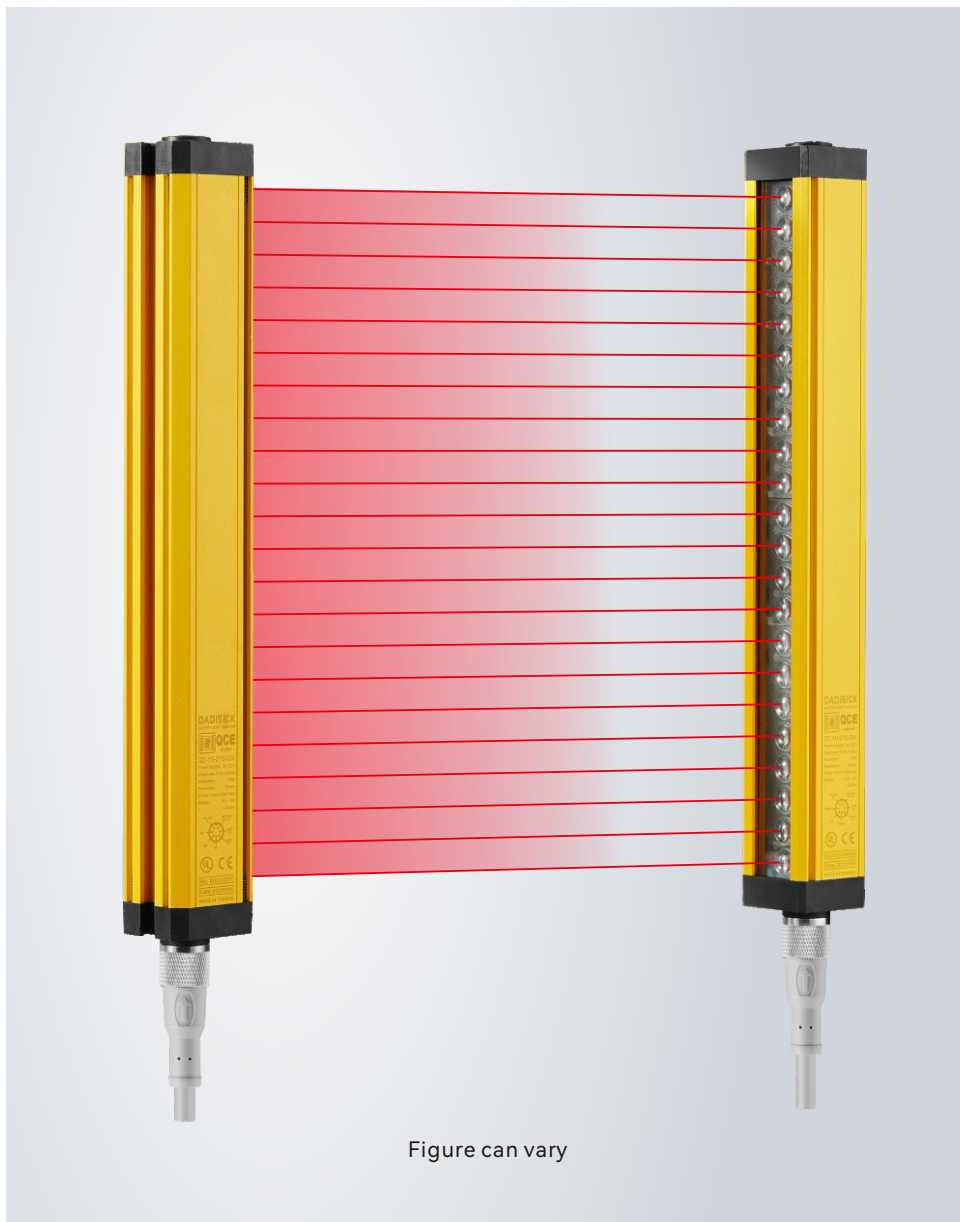

Contents

- Product application
- Technical data
- Operation and display
- Dimensioned drawings
- Electrical connection
- Wiring diagram
- Accessories



GB/T 19001-2016

Product application

- A. Light curtain can achieve full protection for the slider can be stopped at any position on the press machine.
- B. The light curtain can only achieve upper dead point protection if the slider can not be stopped at any position on the press machine.
- C. Realize the regional protection for the industry manipulator, injection molding machines, packaging equipment, automation equipment, assembly wires and other dangerous work area.
- D. Used to detect and alarm object.

Technical data

Basic data of Receiver and Emitter

Standard packaging	
Product model	QCE62/30-1830-2BB-E and QCE62/30-1830-2BB-R
Standard configuration	One receiver, one transmitter, two data lines, one right-angle rack, and one t-shaped screw
Light curtain form	Infrared radiation type
Application	Standard industrial environment - finger protection
Features	
Resolution ratio	30mm
Check the accuracy	38mm
Number of beams	62
Protection height	1830mm
Total height	1868mm
Detection distance	30-6000mm
Response time	≤15ms
Synchronization	
Synchronization	Line synchronization
Consumption current	≤200mA
Output mode	2 sets of PNP, with current of 500mA and voltage below 1.5V, polarity, short circuit and over-cutting protection
Output status	ON (receiving indicator green light)
Indicator light	Transmitter: power indicator light (red); receiver: output indicator light on (green), blackout (red)
Wavelength	850nm
Type of light	Infrared light (NIR), invisible
Function	Automatic reset
Mechanical data	
Overall dimension	30*30*1868mm
Housing material	Metal
Metal shell	Aluminium
Lens front screen material	Acrylic
Upper and lower cover materials	ABS reinforced nylon PA66+30% GF
Environmental data	
Protection grade	IP65
Resistance to ambient light	Incandescent light: illumination of light-receiving surface 3000Lx; Sunlight: illumination of light-receiving surface 10000Lx
Ambient temperature	Working temperature: - 10~+40 °C (but not frozen), storage temperature: - 25 ~+55 °C
Ambient humidity	Working time: 35~85% RH, saving time: 35~95% RH

Performance data	
Protection circuit	Short circuit protection Overvoltage protection
Supply voltage	24VDC, -20...20%
Maximum current consumption	150mA
Fuse	2A half time interval
Output	
Number of safe output circuits (OSSD)	2-circuit
Type	Safety circuit output circuit OSSD
Minimum switch voltage high	18V
Minimum switch voltage low	2.5V
Typical switching voltage	22.5V
Voltage type	DC
Maximum current load	380mA
Load inductance	two thousand
Load capacity	zero point three
Maximum residual current	0.2mA
Typical residual current	0.002MA
Voltage drop	1.5V
Safety switch output 1	Connection pin 4, WHITE OSSD1
Switching element	Transistor PNP
Safety switch output 2	Connection pin 5, GREEN OSSD2
Switching element	Transistor PNP
Certificate	
CETÜV	No.E8A 104143 0001 Rev.00
ROHS certification	No.BSTDG180811032001CC
CE TYPE 4	No.ICR Polska/VC/HS221214
UL	No. 4790783741.1-S
GB/T	No. HIC180327 GB/T 19001-2016 idt ISO 9001:2015

Operation and display

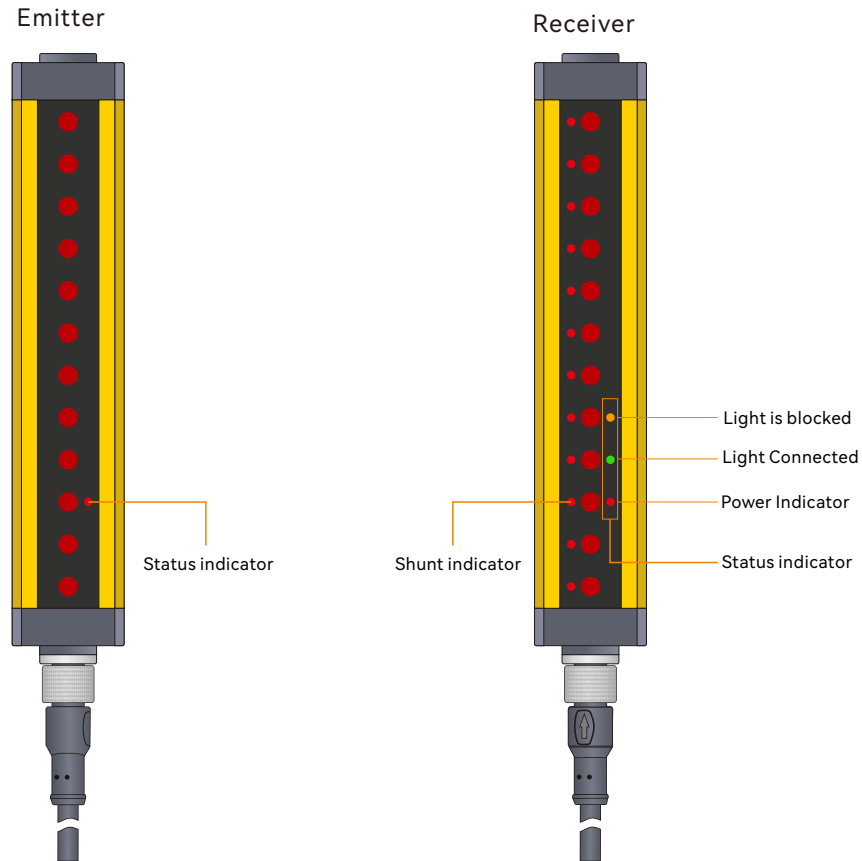

Status indicator	LED status Indicator	Explain
Emitter	Red, always on	Turns on the power
Receiver	Red, always on	Turns on the power
	Green	All light paths are connected
	Yellow	The light is blocked or misaligned
	Lights flashing	Interference or overstep detection range

Shunt indicator	LED shunt Indicator	Explain
Receiver	Red light up	The light is blocked or misaligned
	Red light out	The light paths are connected

Dimensioned drawings

QCE 30mm series

Unit: mm

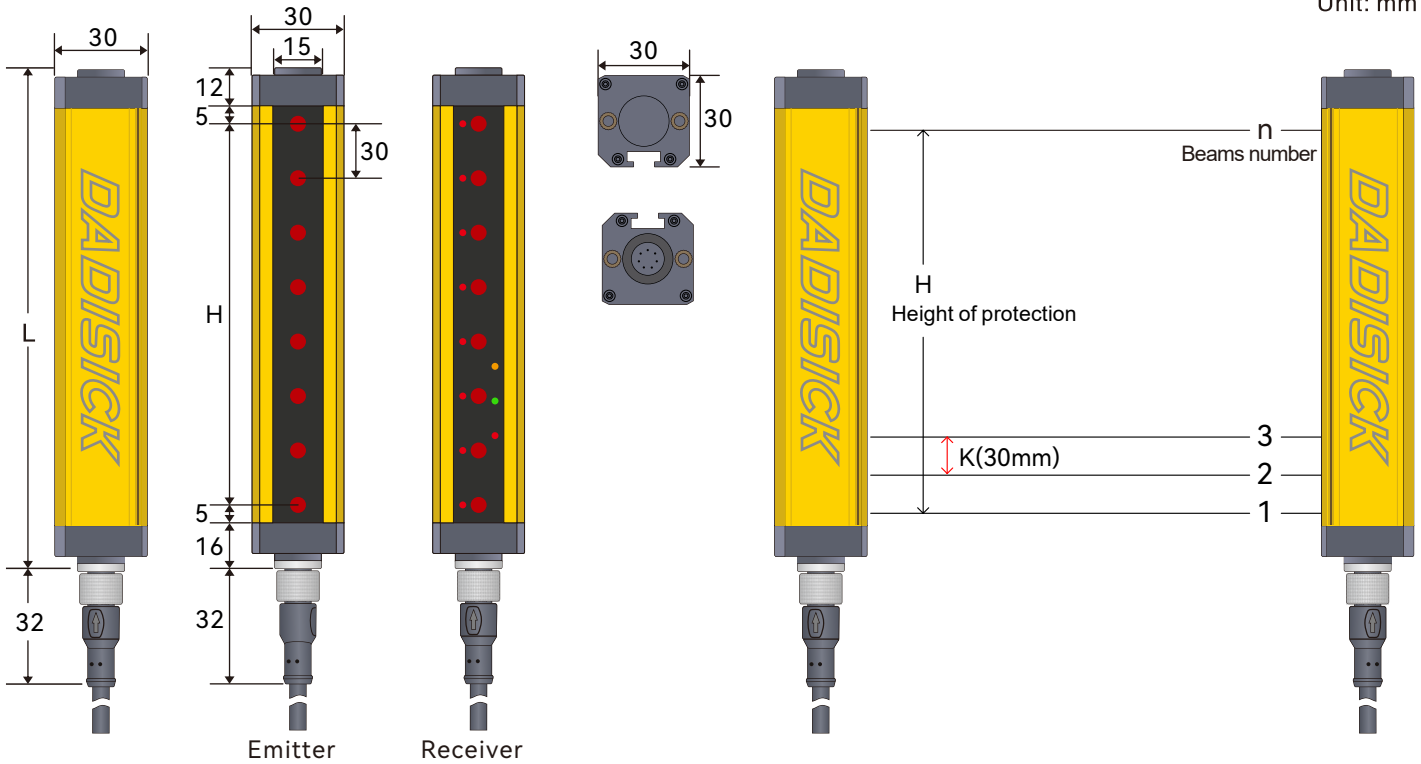

Remarks

L: Total length of light screen

H: Height of protected area

K: Resolution ratio

n: Beams number

 $L = 12 + 5 + H + 5 + 16$ $H = (n - 1) * 30$

QCE 30mm specification list

Resolution	Light beam	Protection height (H)	Total height (L)	Product model	Signal output mode		Detection distance
					Two outputs	PNP output	
30mm (K)	4	90	128	QCE04/30-90	2	PNP	0.3-6m
	6	150	188	QCE06/30-150	2	PNP	0.3-6m
	8	210	248	QCE8/30-210	2	PNP	0.3-6m
	10	270	308	QCE10/30-270	2	PNP	0.3-6m
	12	330	368	QCE12/30-330	2	PNP	0.3-6m
	14	390	428	QCE14/30-390	2	PNP	0.3-6m
	16	450	488	QCE16/30-450	2	PNP	0.3-6m
	18	510	548	QCE18/30-510	2	PNP	0.3-6m
	20	570	608	QCE20/30-570	2	PNP	0.3-6m
	22	630	668	QCE22/30-630	2	PNP	0.3-6m
	24	690	728	QCE24/30-690	2	PNP	0.3-6m
	26	750	788	QCE26/30-750	2	PNP	0.3-6m
	28	810	848	QCE28/30-810	2	PNP	0.3-6m
	30	870	908	QCE30/30-870	2	PNP	0.3-6m
	32	930	968	QCE32/30-930	2	PNP	0.3-6m
	34	990	1028	QCE34/30-990	2	PNP	0.3-6m
	36	1050	1088	QCE36/30-1050	2	PNP	0.3-6m
	38	1110	1148	QCE38/30-1110	2	PNP	0.3-6m
	40	1170	1208	QCE40/30-1170	2	PNP	0.3-6m
	42	1230	1268	QCE42/30-1230	2	PNP	0.3-6m
	44	1290	1328	QCE44/30-1290	2	PNP	0.3-6m
	46	1350	1388	QCE46/30-1350	2	PNP	0.3-6m
	48	1410	1448	QCE48/30-1410	2	PNP	0.3-6m
	50	1470	1508	QCE50/30-1470	2	PNP	0.3-6m
52	1530	1568	QCE52/30-1530	2	PNP	0.3-6m	
54	1590	1628	QCE54/30-1590	2	PNP	0.3-6m	
56	1650	1688	QCE56/30-1650	2	PNP	0.3-6m	
58	1710	1748	QCE58/30-1710	2	PNP	0.3-6m	
60	1770	1808	QCE60/30-1770	2	PNP	0.3-6m	
62	1830	1868	QCE62/30-1830	2	PNP	0.3-6m	
64	1890	1928	QCE64/30-1890	2	PNP	0.3-6m	
66	1950	1988	QCE66/30-1950	2	PNP	0.3-6m	
68	2010	2048	QCE68/30-2010	2	PNP	0.3-6m	
70	2070	2108	QCE70/30-2070	2	PNP	0.3-6m	
72	2130	2168	QCE72/30-2130	2	PNP	0.3-6m	

Electrical connection

Electrical interface	
Number of interfaces	2 (receiver and transmitter)
Type	M12 connector, 7-pin
Interface metal	Copper nickel plating
Plug material	GY384 gray 30P
Allowable typical conductor section	0.25mm ²
Maximum link cable	100m
Maximum allowable cable load	4.9A
Cable material	PVC
Shielding	shielded

Cable description:

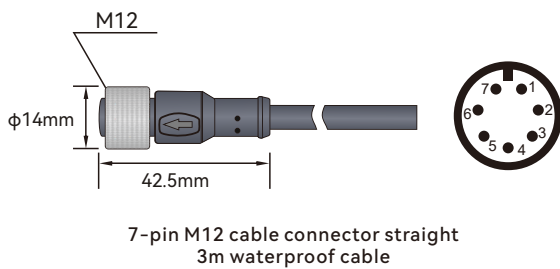

Emitter Wiring diagram		
Pin number	Line color	Name
1	BROWN	24V DC
2	BLUE	0V
3	BLACK	CP
4	WHITE	NC
5	GREEN	NC
6	RED	CE
7	YELLOW	Ground wire

Receiver Wiring diagram		
Pin number	Line color	Name
1	BROWN	24V DC
2	BLUE	0V
3	BLACK	CP
4	WHITE	OSSD1
5	GREEN	OSSD2
6	RED	CE
7	YELLOW	Ground wire

QCE signal output selection (actual output of transistor working normally)

NPN NC

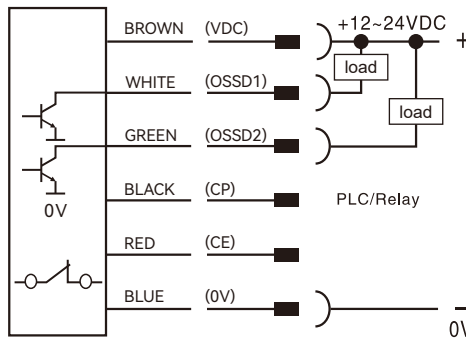

A

PNP NC

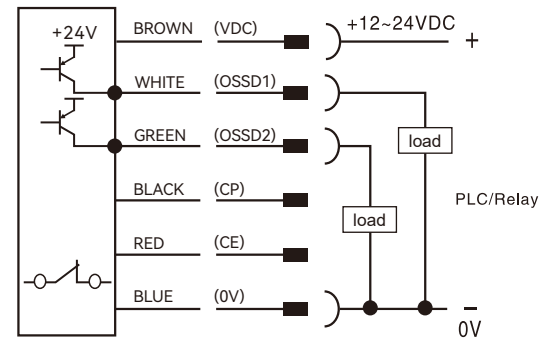

B

NPN NO

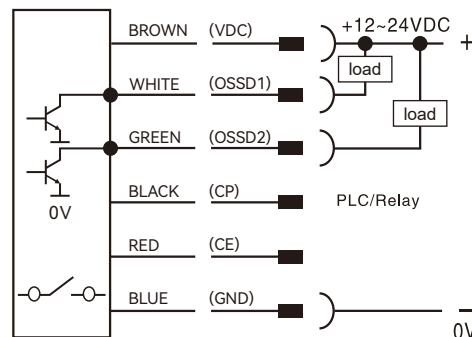

C

PNP NO

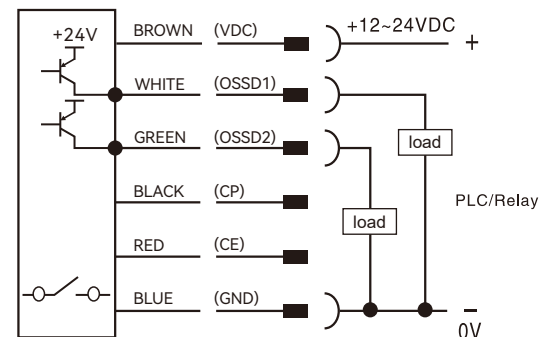

D

NPN output wiring diagram







This figure is an example of NPN double output 7-pin wiring.

PNP output wiring diagram



This figure is an example of PNP double output 7-pin wiring.

Selection of safety light curtain controller

Name	Order separately	Model	Descriptions
Built-in controller		QET	Used to monitor the signal processing of QCE series light curtain, and output one group of NO and one group of NC.
Safety relay		QSRN	QSRN safety relays have three groups of NO and one group of NC, with strong control capabilities. They are suitable for various signal monitoring in industrial places with high safety requirements, including emergency stop signals, safety door opening and closing signals, safety light curtain signals, and two-handed button signals.
Safety relay	  Multifunctional switching switch	Ter-A	Equipped with a mode switch, it can be used for most safety components, such as light curtains, safety switches, carpet contacts, two handed switches, etc. Automatic/manual reset paddles for quick configuration. Dual channel monitoring circuit, safe and reliable.
Light curtain relay		QET-1	Output conversion between NC and NO for QCE series light curtain.

Wiring diagram of QET built-in controller

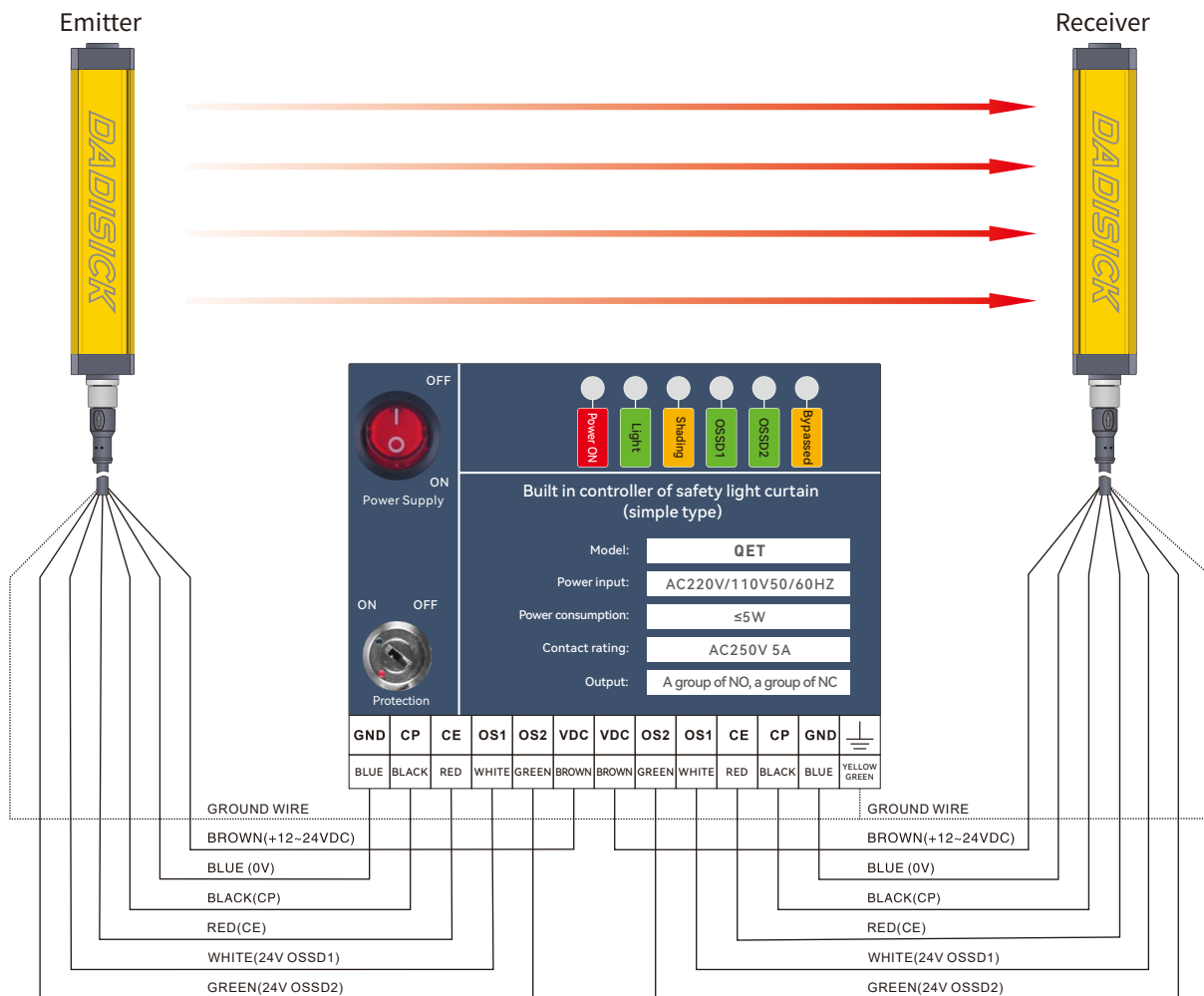

Wiring diagram of QSRN safety relay



Wiring diagram of Ter-A safety relay

Dual channel light curtain PNP switch safety input, with automatic reset and PLC signal output.



Wiring diagram of QET-1 light curtain relay



Circuit diagram

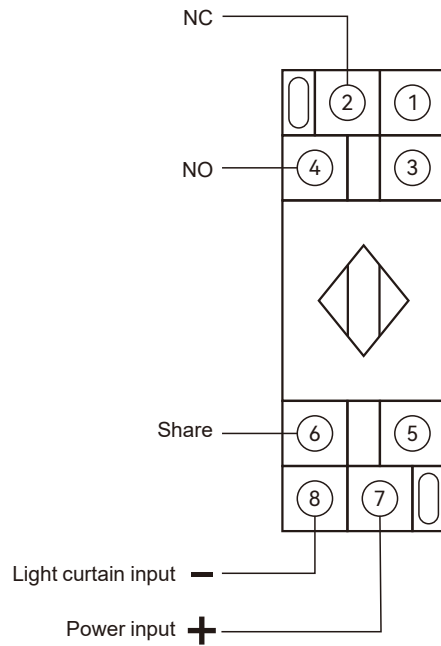

When not powered on

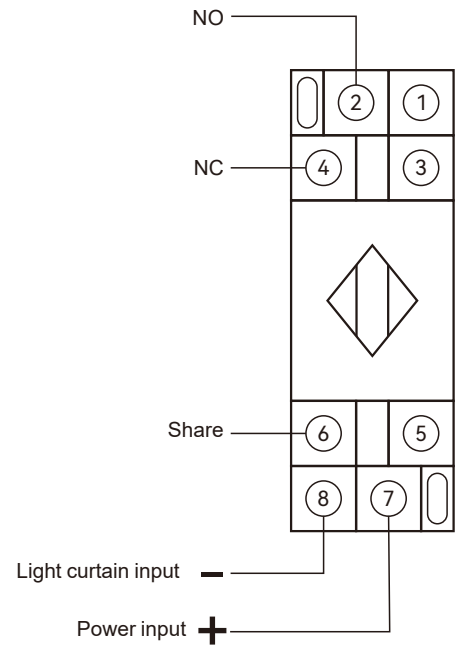

When powered on

Wiring between light curtain and PLC and one-chip computer system

NPN wiring:

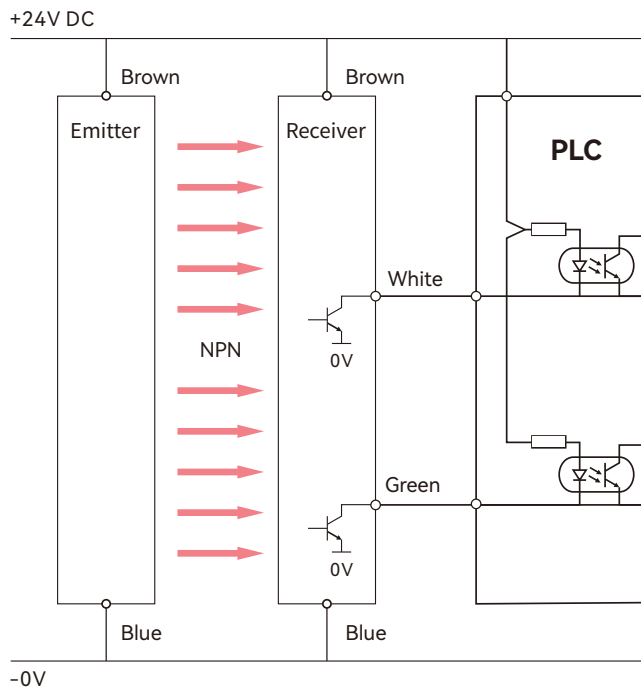

PNP wiring:

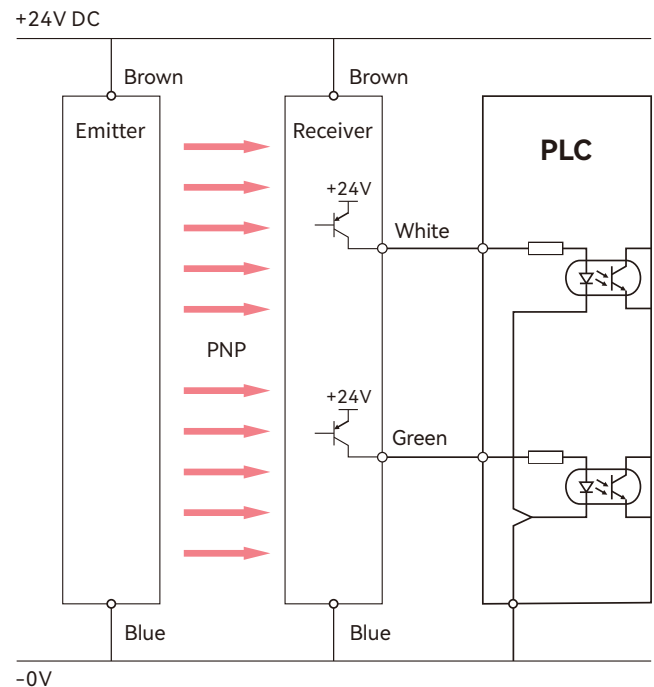

Accessories

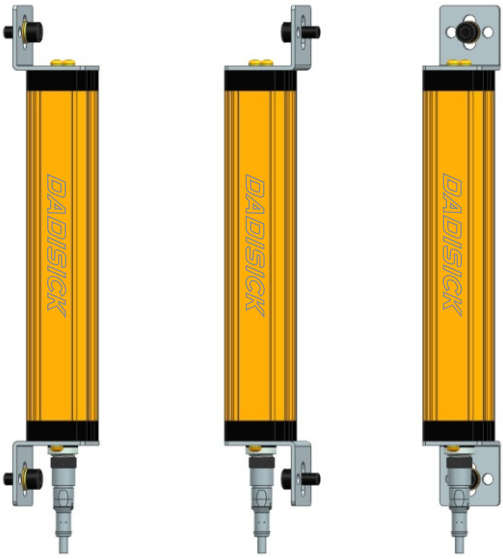

1. Installation method of lower right angle bracket
(Original accessories)

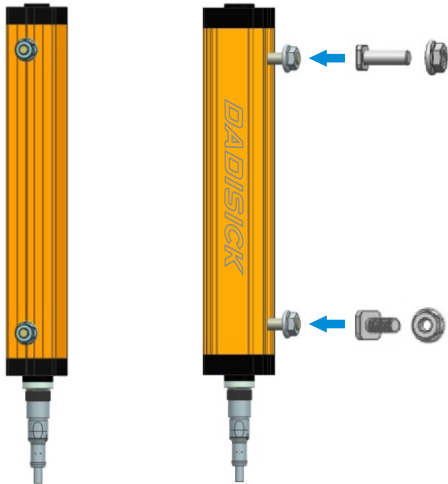

2. T-screw installation method
(Original accessories)

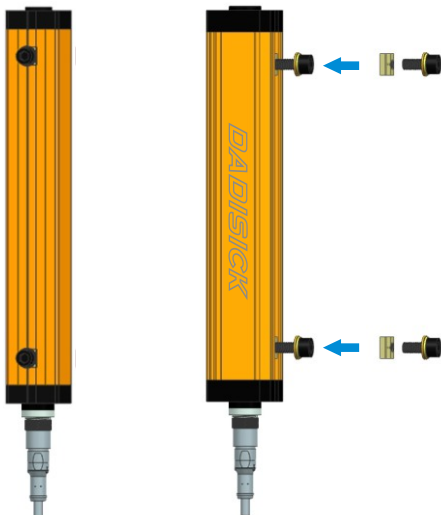

3. Installation method of convex nut
(Optional accessories)

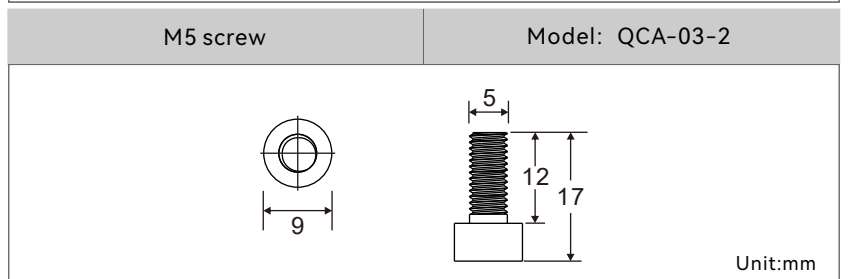
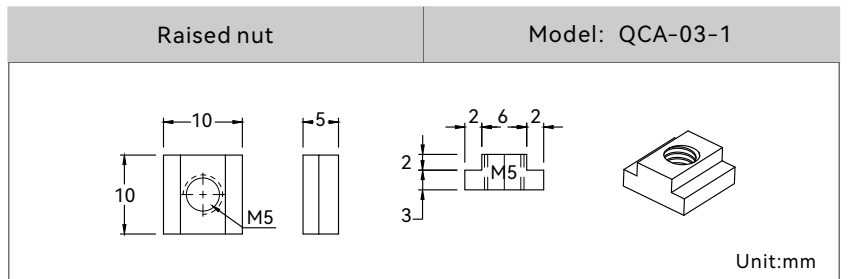
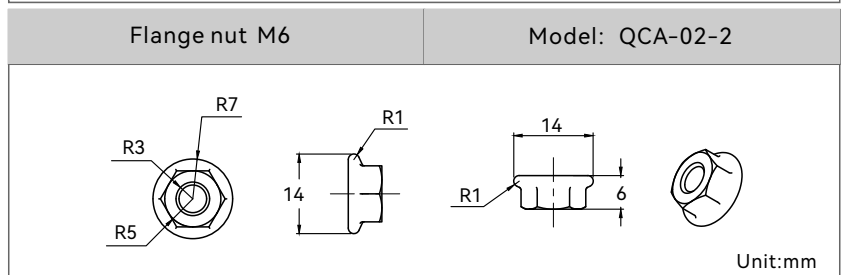
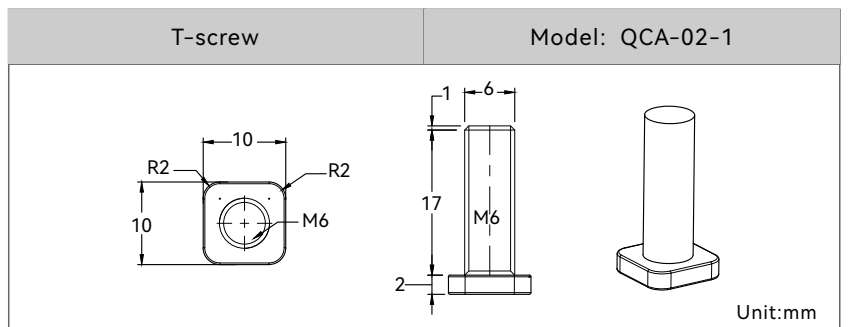
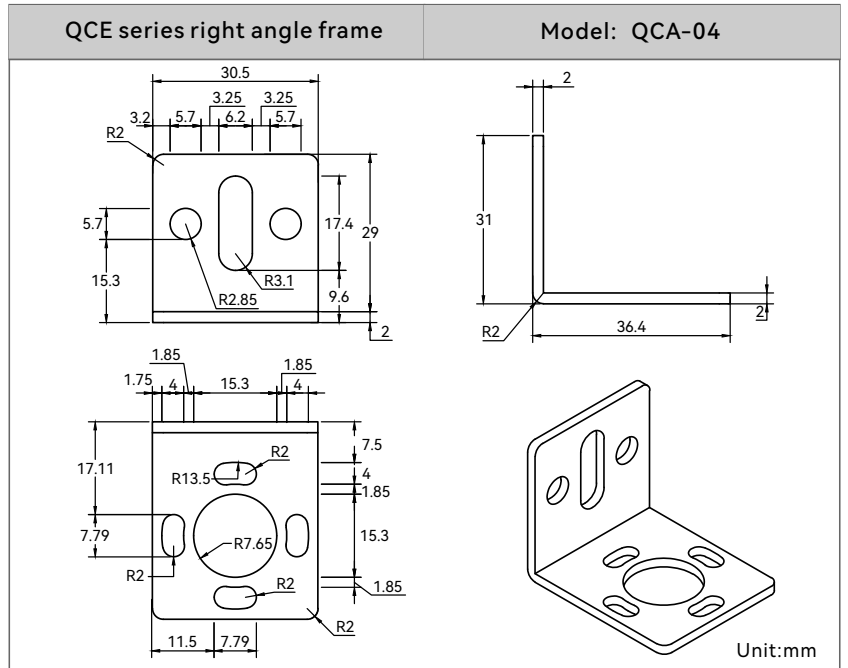

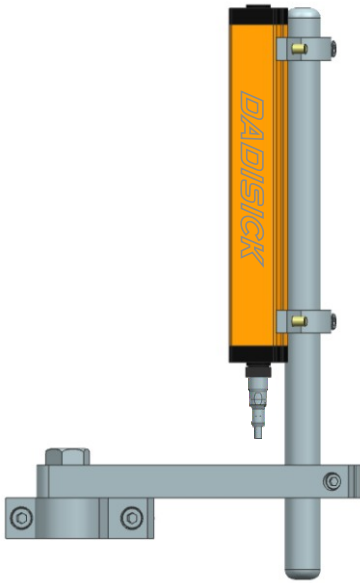

4. Stainless steel bracket installation
(Order separately)

