

TECHNICAL DATA SHEET

SAFETY LIGHT CURTAIN SENSOR

Emitter: KT10/38-370-2BB-E

Receiver: KT10/38-370-2BB-R

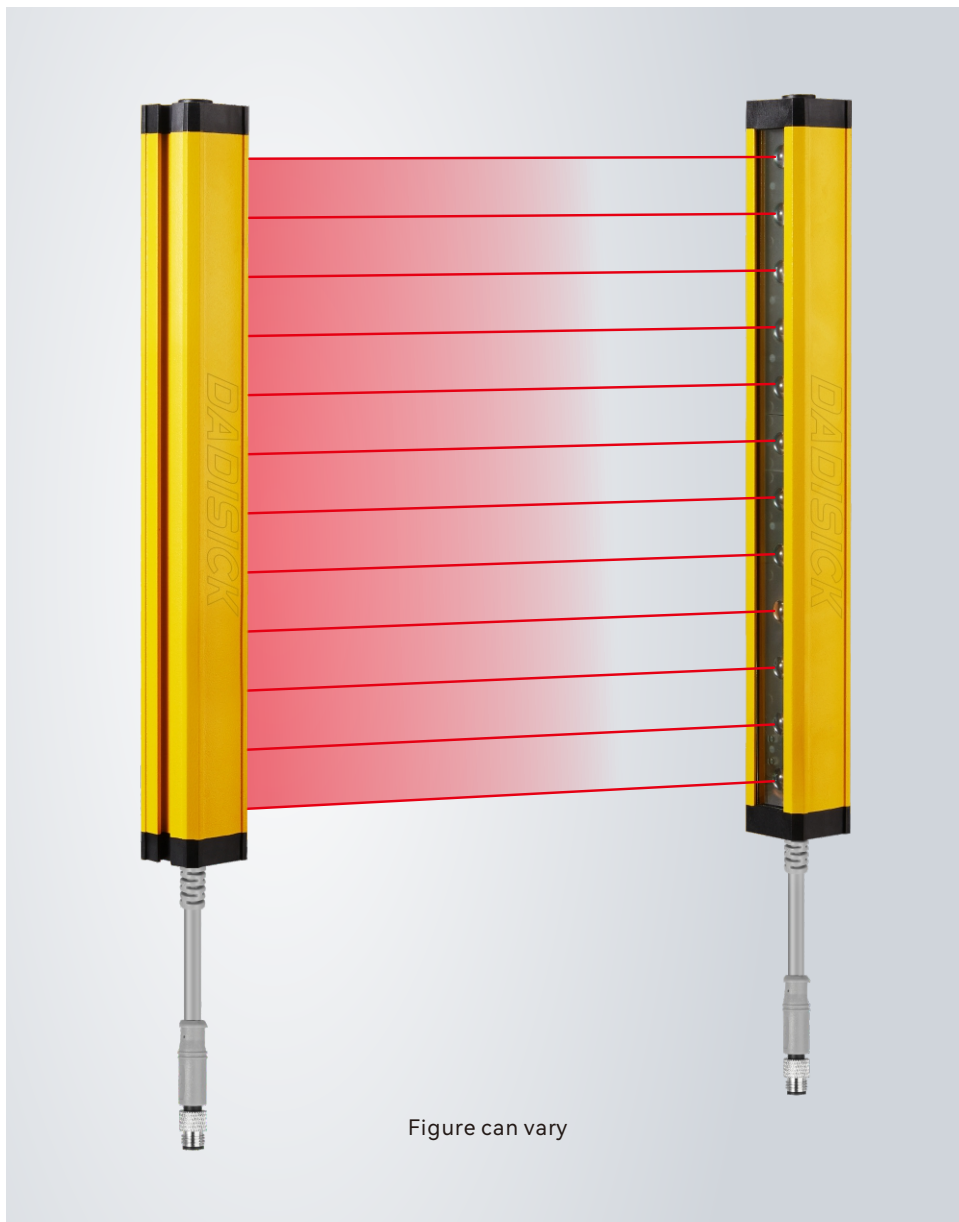

Contents

- Product application
- Technical data
- Operation and display
- Dimensioned drawings
- Electrical connection
- Wiring diagram
- Accessories



GB/T 19001-2016

Product application

- A. Light curtain can achieve full protection for the slider can be stopped at any position on the press machine.
- B. The light curtain can only achieve upper dead point protection if the slider can not be stopped at any position on the press machine.
- C. Realize the regional protection for the industry manipulator, injection molding machines, packaging equipment, automation equipment, assembly wires and other dangerous work area.
- D. Used to detect and alarm object.

Technical data

Basic data of Receiver and Emitter

Standard packaging	
Product model	KT10/38-370-2BB-E and KT10/38-370-2BB-R
Standard configuration	One receiver, one transmitter, two data lines, one right-angle rack, and one t-shaped screw
Light curtain form	Infrared radiation type
Application	Standard industrial environment - finger protection
Features	
Resolution ratio	10mm
Check the accuracy	18mm
Number of beams	38
Protection height	370mm
Total height	409mm
Detection distance	30-6000mm
Response time	≤15ms
Synchronization	
Synchronization	Line synchronization
Consumption current	≤200mA
Output mode	2-circuit of PNP, with current of 500mA and voltage below 1.5V, polarity, short circuit and over-cutting protection
Output status	ON (receiving indicator green light)
Indicator light	Transmitter: power indicator light (red); receiver: output indicator light on (green), blackout (red)
Wavelength	850nm
Type of light	Infrared light (NIR), invisible
Function	Automatic reset
Mechanical data	
Overall dimension	29*29*409mm
Housing material	Metal
Metal shell	Aluminium
Lens front screen material	Acrylic
Upper and lower cover materials	ABS reinforced nylon PA66+30% GF
Environmental data	
Protection grade	IP65
Resistance to ambient light	Incandescent light: illumination of light-receiving surface 3000Lx; Sunlight: illumination of light-receiving surface 10000Lx
Ambient temperature	Working temperature: - 10~+40 °C (but not frozen), storage temperature: - 25 ~+55 °C
Ambient humidity	Working time: 35~85% RH, saving time: 35~95% RH

Performance data	
Protection circuit	Short circuit protection Overvoltage protection
Supply voltage	24VDC, -20...20%
Maximum current consumption	150mA
Fuse	2A half time interval
Output	
Number of safe output circuits (OSSD)	2-circuit
Type	Safety circuit output circuit OSSD
Minimum switch voltage high	18V
Minimum switch voltage low	2.5V
Typical switching voltage	22.5V
Voltage type	DC
Maximum current load	380mA
Load inductance	two thousand
Load capacity	zero point three
Maximum residual current	0.2mA
Typical residual current	0.002MA
Voltage drop	1.5V
Safety switch output 1	Connection pin 3, WHITE OSSD 1
Switching element	Transistor PNP
Safety switch output 2	Connection pin 4, BLACK OSSD 2
Switching element	Transistor PNP
Certificate	
CETÜV	No.E8A 104143 0001 Rev.00
ROHS certification	No.BSTDG180811032001CC
CE TYPE 4	No.ICR Polska/VC/HS221214
UL	No. 4790783741.1-S
GB/T	No. HIC180327 GB/T 19001-2016 idt ISO 9001:2015

Operation and display



Normal operation of light curtain	LED Indicator status	Explain
Emitter	 Red, always on	Turns on the power
	 Receiver and emitter are red	Receiver and Emitter are not aligned
Receiver	 Green	All light paths are connected
	 Red	Light path shading
	 Lights flashing	Interference or overstep detection range

Dimensioned drawings

KT 10mm series

Unit: mm

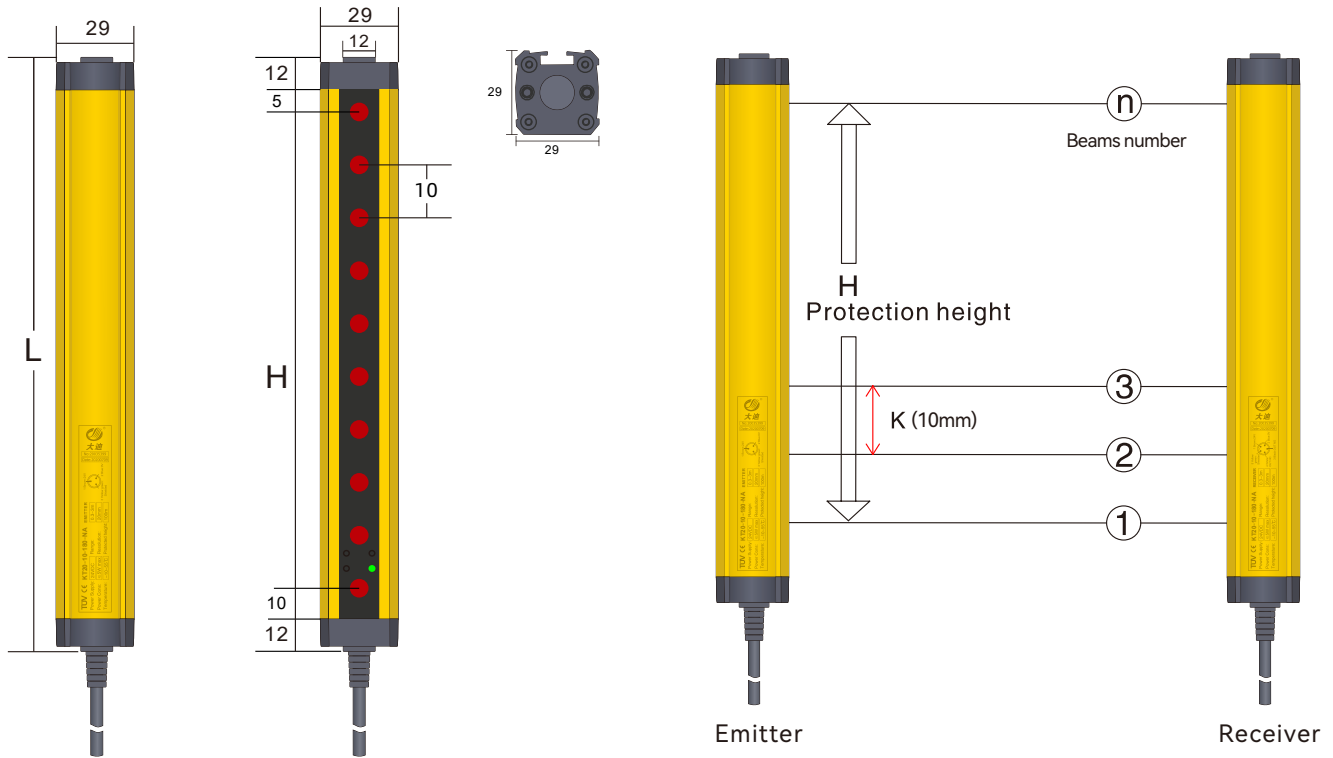

Remarks: L: Total length of light screen
 $L = 12 + 5 + H + 10 + 12$

H: Height of protected area
 $H = (n - 1) * 10$

K: Resolution ratio
 n: Beams number

KT 10mm specification list

Resolution	Light beam	Protection height (H)	Total height (L)	Product model	Signal output mode		Detection range
					Outputs	PNP output	
10mm (K)	8	70	109	KT10/08-70	2	PNP	0.3-6m
	10	90	129	KT10/10-90	2	PNP	0.3-6m
	12	110	149	KT10/12-110	2	PNP	0.3-6m
	14	130	169	KT10/14-130	2	PNP	0.3-6m
	16	150	189	KT10/16-150	2	PNP	0.3-6m
	18	170	209	KT10/18-170	2	PNP	0.3-6m
	20	190	229	KT10/20-190	2	PNP	0.3-6m
	22	210	249	KT10/22-210	2	PNP	0.3-6m
	24	230	269	KT10/24-230	2	PNP	0.3-6m
	26	250	289	KT10/26-250	2	PNP	0.3-6m
	28	270	309	KT10/28-270	2	PNP	0.3-6m
	30	290	329	KT10/30-290	2	PNP	0.3-6m
	32	310	349	KT10/32-310	2	PNP	0.3-6m
	34	330	369	KT10/34-330	2	PNP	0.3-6m
	36	350	389	KT10/36-350	2	PNP	0.3-6m
	38	370	409	KT10/38-370	2	PNP	0.3-6m
	40	390	429	KT10/40-390	2	PNP	0.3-6m
	42	410	449	KT10/42-410	2	PNP	0.3-6m
	44	430	469	KT10/44-430	2	PNP	0.3-6m
	46	450	489	KT10/46-450	2	PNP	0.3-6m
48	470	509	KT10/48-470	2	PNP	0.3-6m	
50	490	529	KT10/50-490	2	PNP	0.3-6m	
52	510	549	KT10/52-510	2	PNP	0.3-6m	
54	530	569	KT10/54-530	2	PNP	0.3-6m	
...	2	PNP	0.3-6m
196	1950	1989	1989	KT10/196-1950	2	PNP	0.3-6m
198	1970	2009	2009	KT10/198-1970	2	PNP	0.3-6m
200	1990	2029	2029	KT10/200-1990	2	PNP	0.3-6m

Electrical connection

Electrical interface	
Number of interfaces	2 (receiver and emitter)
Type	Emitter with M8 connector 3-pin, Receiver with M8 connector 5-pin
Interface metal	Copper nickel plating
Plug material	GY384 gray 30P
Allowable typical conductor section	0.25mm ²
Maximum link cable	100m
Maximum allowable cable load	4.9A
Cable material	PVC

Cable description:



3-pin and 5-pin M8 cable connector straight
3m waterproof cable



Emitter Wiring diagram

Pin number	Line color	Name
1	BROWN	24V DC
2	BLUE	0V
-	-	-
3	YELLOW	Ground wire

Receiver Wiring diagram

Pin number	Line color	Name
1	BROWN	24V DC
2	BLUE	0V
3	WHITE	OSSD 1
4	BLACK	OSSD 2
5	YELLOW	Ground wire

1. KT signal output selection (actual output of transistor working normally)

NPN NC

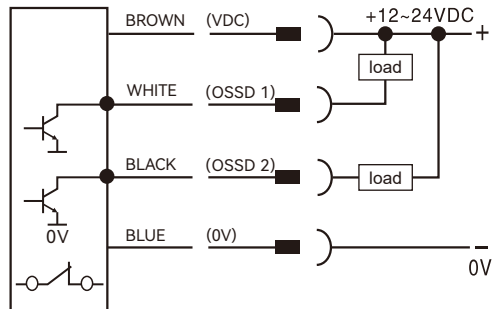

A

PNP NC



B

NPN NO

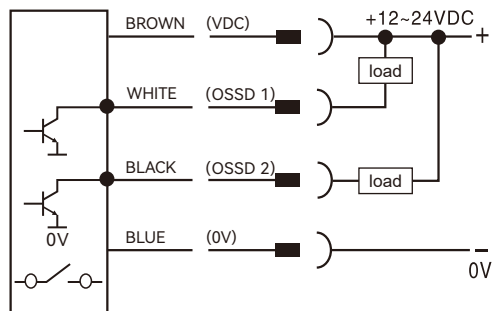

C

PNP NO

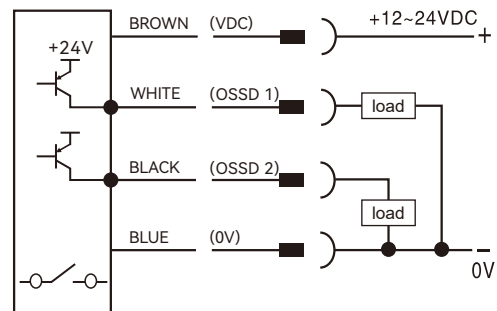

D

2. NPN output wiring diagram







This picture is an example of NPN output wiring

3. PNP output wiring diagram



This picture is an example of PNP output wiring

4. Selection of safety light curtain controller

Name	Order separately	Model	Descriptions
Built-in controller		QET	Used to monitor the signal processing of KT series light curtain, and output one group of NO and one group of NC.
Safety relay		QSRN	QSRN safety relays have three groups of NO and one group of NC, with strong control capabilities. They are suitable for various signal monitoring in industrial places with high safety requirements, including emergency stop signals, safety door opening and closing signals, safety light curtain signals, and two-handed button signals.
Safety relay	  Multifunctional switching switch	Ter-A	Equipped with a mode switch, it can be used for most safety components, such as light curtains, safety switches, carpet contacts, two handed switches, etc. Automatic/manual reset paddles for quick configuration. Dual channel monitoring circuit, safe and reliable.
Light curtain relay		QET-1	Output conversion between NC and NO for KT series light curtain.

4.1 Wiring diagram of QET built-in controller

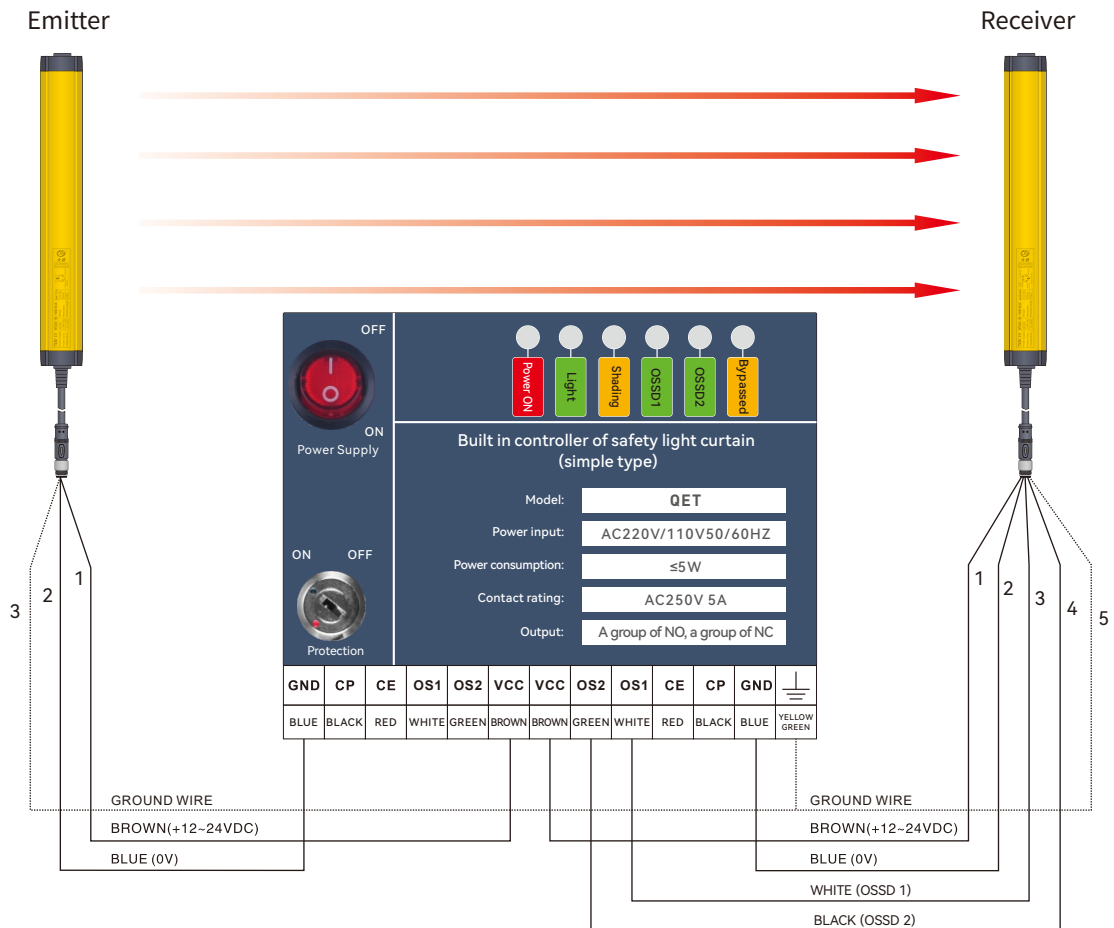

4.2 Wiring diagram of QSRN safety relay



4.3 Wiring diagram of Ter-A safety relay

Dual channel light curtain PNP switch safety input, with automatic reset and PLC signal output.



4.4 Wiring diagram of QET-1 light curtain relay



4.5 Wiring between light curtain and PLC and one-chip computer system

NPN wiring:



PNP wiring:



Accessories



1. Installation method of right angle brackets
(Original accessories)



2. Installation method of T-shaped screws on the back
(Original accessories)



3. Installation method of convex nut
(Optional accessories)





4. Stainless steel bracket installation
(Order separately)

