

TECHNICAL DATA SHEET

SAFETY LIGHT CURTAIN SENSOR
Emitter: QO40/30-1170-2BB-E
Receiver: QO40/30-1170-2BB-R

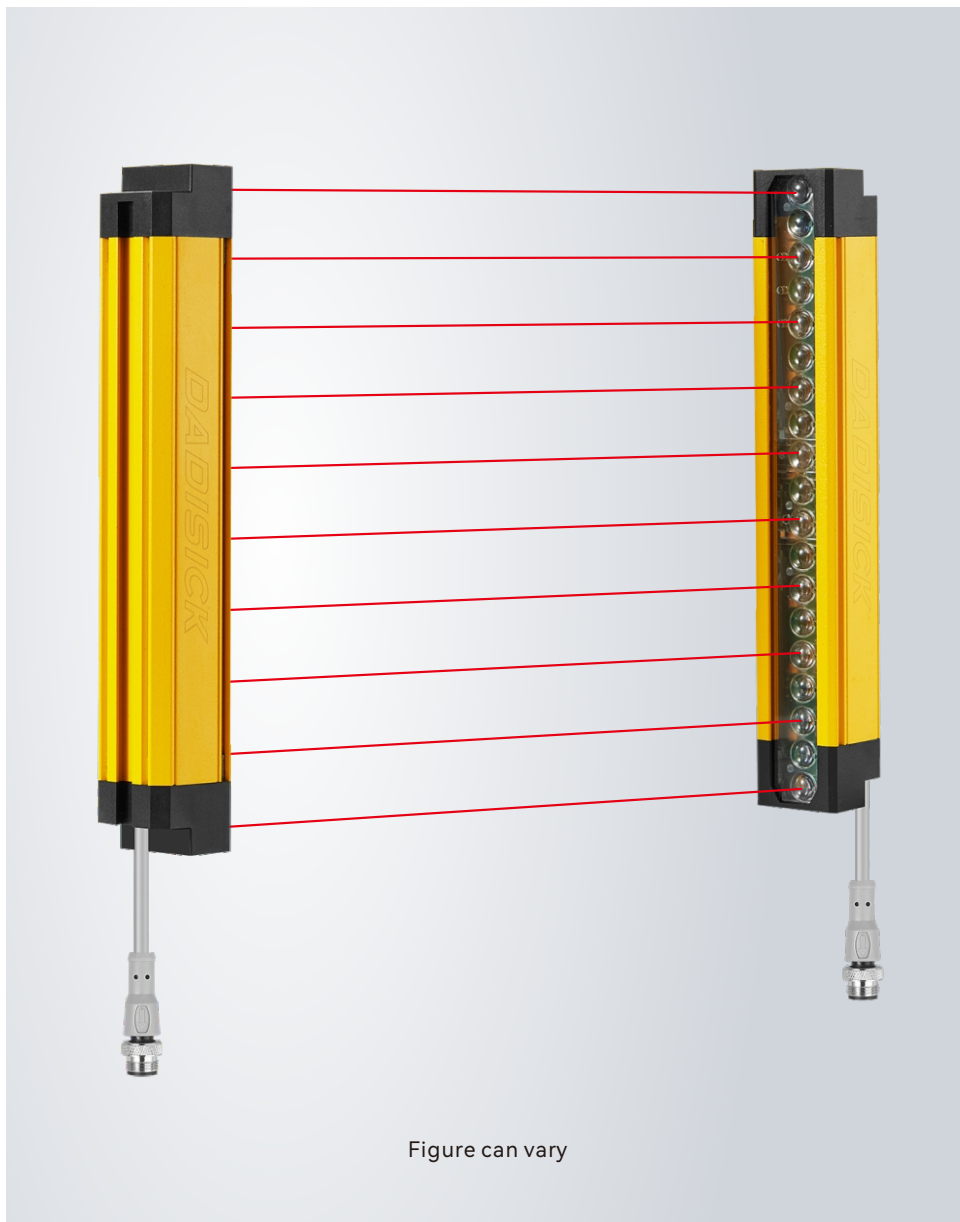

Contents

- Product application
- Technical data
- Operation and display
- Dimensioned drawings
- Electrical connection
- Wiring diagram
- Accessories



GB/T 19001-2016

Product application

- A. Light curtain can achieve full protection for the slider can be stopped at any position on the press machine.
- B. The light curtain can only achieve upper dead point protection if the slider can not be stopped at any position on the press machine.
- C. Realize the regional protection for the industry manipulator, injection molding machines, packaging equipment, automation equipment, assembly wires and other dangerous work area.
- D. Used to detect and alarm object.

Technical data

Basic data of Receiver and Emitter

| | |
|---------------------------------|---|
| Standard packaging | |
| Product model | QO40/30-1170-2BB-E and QO40/30-1170-2BB-R |
| Standard configuration | One receiver, one transmitter, two data lines, one right-angle rack, and one t-shaped screw |
| Light curtain form | Infrared radiation type |
| Application | Standard industrial environment - finger protection |
| Features | |
| Resolution ratio | 30mm |
| Check the accuracy | 38mm |
| Number of beams | 40 |
| Protection height | 1170mm |
| Total height | 1183.5mm |
| Detection distance | 30-6000mm (Default 30-6000mm, customer service can be contacted to customize 30-45000mm.) |
| Response time | ≤15ms |
| Synchronization | |
| Synchronization | Line synchronization |
| Consumption current | ≤200mA |
| Output mode | 2-circuit of PNP, with current of 500mA and voltage below 1.5V, polarity, short circuit and over-cutting protection |
| Output status | ON (receiving indicator green light) |
| Indicator light | Transmitter: power indicator light (red); receiver: output indicator light on (green), blackout (red) |
| Wavelength | 850nm |
| Type of light | Infrared light (NIR), invisible |
| Function | Automatic reset |
| Mechanical data | |
| Overall dimension | 28*30*1183.5mm |
| Housing material | Metal |
| Metal shell | Aluminium |
| Lens front screen material | Acrylic |
| Upper and lower cover materials | ABS reinforced nylon PA66+30% GF |
| Environmental data | |
| Protection grade | IP65 |
| Resistance to ambient light | Incandescent light: illumination of light-receiving surface 3000Lx; Sunlight: illumination of light-receiving surface 10000Lx |
| Ambient temperature | Working temperature: - 10~+40 °C (but not frozen), storage temperature: - 25 ~+55 °C |
| Ambient humidity | Working time: 35~85% RH, saving time: 35~95% RH |

| Performance data | |
|---------------------------------------|--|
| Protection circuit | Short circuit protection Overvoltage protection |
| Supply voltage | 24VDC, -20...20% |
| Maximum current consumption | 150mA |
| Fuse | 2A half time interval |
| Output | |
| Number of safe output circuits (OSSD) | 2-circuit |
| Type | Safety circuit output circuit OSSD |
| Minimum switch voltage high | 18V |
| Minimum switch voltage low | 2.5V |
| Typical switching voltage | 22.5V |
| Voltage type | DC |
| Maximum current load | 380mA |
| Load inductance | two thousand |
| Load capacity | zero point three |
| Maximum residual current | 0.2mA |
| Typical residual current | 0.002MA |
| Voltage drop | 1.5V |
| Safety switch output 1 | Connection pin 4, WHITE OSSD1 |
| Switching element | Transistor PNP |
| Safety switch output 2 | Connection pin 5, GREEN OSSD2 |
| Switching element | Transistor PNP |
| Certificate | |
| CETÜV | No.E8A 104143 0001 Rev.00 |
| ROHS certification | No.BSTDG180811032001CC |
| CE TYPE 4 | No.ICR Polska/VC/HS221214 |
| UL | No. 4790783741.1-S |
| GB/T | No. HIC180327 GB/T 19001-2016 idt ISO 9001:2015 |

Operation and display



| Status indicator | LED status Indicator | Explain |
|------------------|----------------------|--|
| Emitter | Red, always on | Turns on the power |
| Receiver | Red, always on | Turns on the power |
| | Green | All light paths are connected |
| | Yellow | The light is blocked or misaligned |
| | Lights flashing | Interference or overstep detection range |

| Shunt indicator | LED shunt Indicator | Explain |
|-----------------|---------------------|------------------------------------|
| Receiver | Red light up | The light is blocked or misaligned |
| | Red light out | The light paths are connected |

Dimensioned drawings

QO 30mm series

Unit: mm

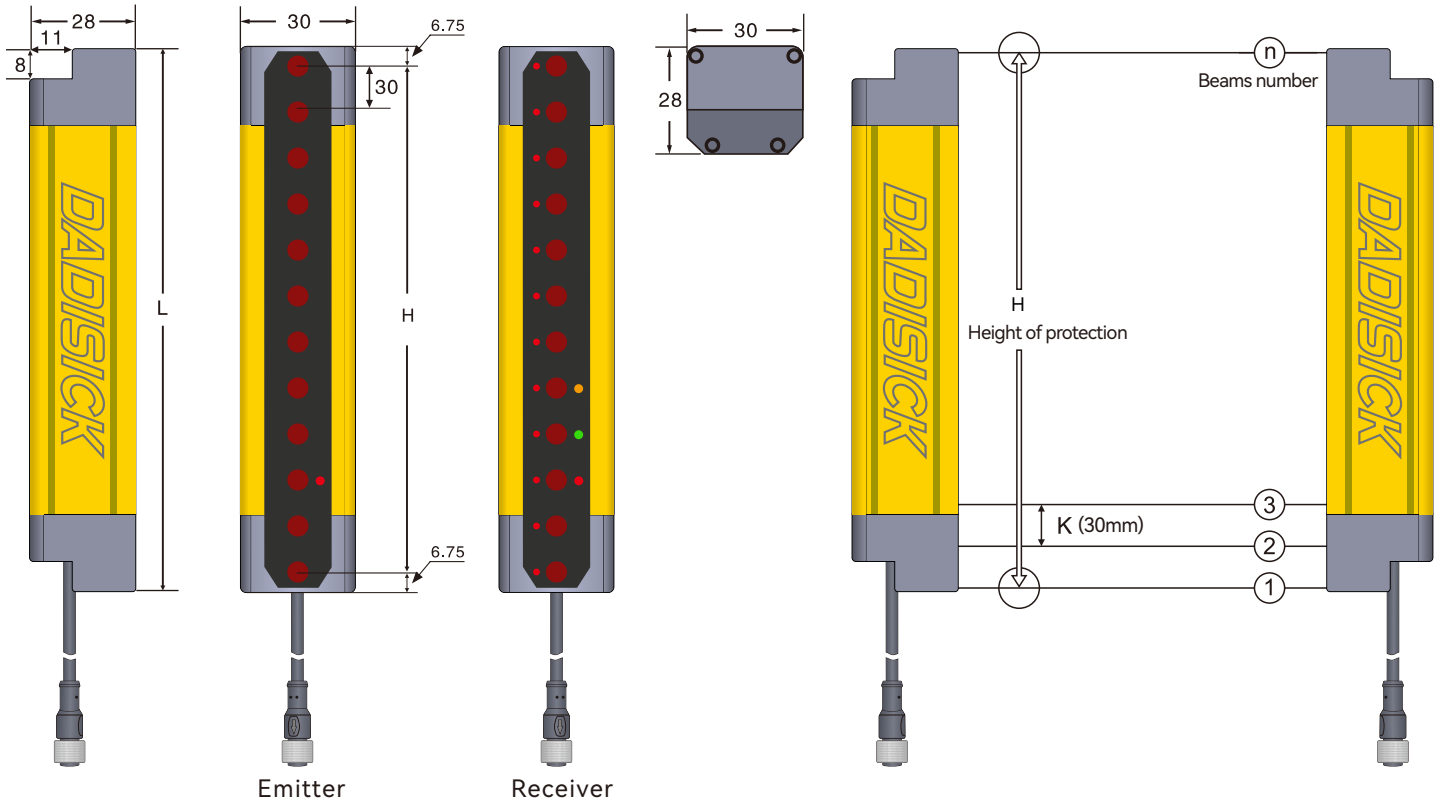

Remarks

L: Total length of light screen

H: Height of protected area

K: Resolution ratio

n: Beams number

 $L = 6.75 + H + 6.75$ $H = (n - 1) * 30$

QO 30mm specification list

| Resolution | Light beam | Protection height (H) | Total height (L) | Product model | Signal output mode | | Detection range |
|-------------|------------|-----------------------|------------------|---------------|--------------------|------------|-----------------|
| | | | | | Two outputs | PNP output | |
| 30mm (K) | 4 | 90 | 103.5 | QO04/30-90 | 2 | PNP | 0.3-6m |
| | 6 | 150 | 163.5 | QO06/30-150 | 2 | PNP | 0.3-6m |
| | 8 | 210 | 223.5 | QO08/30-210 | 2 | PNP | 0.3-6m |
| | 10 | 270 | 283.5 | QO10/30-270 | 2 | PNP | 0.3-6m |
| | 12 | 330 | 343.5 | QO12/30-330 | 2 | PNP | 0.3-6m |
| | 14 | 390 | 403.5 | QO14/30-390 | 2 | PNP | 0.3-6m |
| | 16 | 450 | 463.5 | QO16/30-450 | 2 | PNP | 0.3-6m |
| | 18 | 510 | 523.5 | QO18/30-510 | 2 | PNP | 0.3-6m |
| | 20 | 570 | 583.5 | QO20/30-570 | 2 | PNP | 0.3-6m |
| | 22 | 630 | 643.5 | QO22/30-630 | 2 | PNP | 0.3-6m |
| | 24 | 690 | 703.5 | QO24/30-690 | 2 | PNP | 0.3-6m |
| | 26 | 750 | 763.5 | QO26/30-750 | 2 | PNP | 0.3-6m |
| | 28 | 810 | 823.5 | QO28/30-810 | 2 | PNP | 0.3-6m |
| | 30 | 870 | 883.5 | QO30/30-870 | 2 | PNP | 0.3-6m |
| | 32 | 930 | 943.5 | QO32/30-930 | 2 | PNP | 0.3-6m |
| | 34 | 990 | 1003.5 | QO34/30-990 | 2 | PNP | 0.3-6m |
| | 36 | 1050 | 1063.5 | QO36/30-1050 | 2 | PNP | 0.3-6m |
| | 38 | 1110 | 1123.5 | QO38/30-1110 | 2 | PNP | 0.3-6m |
| | 40 | 1170 | 1183.5 | QO40/30-1170 | 2 | PNP | 0.3-6m |
| | 42 | 1230 | 1243.5 | QO42/30-1230 | 2 | PNP | 0.3-6m |
| | 44 | 1290 | 1303.5 | QO44/30-1290 | 2 | PNP | 0.3-6m |
| | 46 | 1350 | 1363.5 | QO46/30-1350 | 2 | PNP | 0.3-6m |
| | 48 | 1410 | 1423.5 | QO48/30-1410 | 2 | PNP | 0.3-6m |
| | 50 | 1470 | 1483.5 | QO50/30-1470 | 2 | PNP | 0.3-6m |
| | 52 | 1530 | 1543.5 | QO52/30-1530 | 2 | PNP | 0.3-6m |
| | 54 | 1590 | 1603.5 | QO54/30-1590 | 2 | PNP | 0.3-6m |
| | 56 | 1650 | 1663.5 | QO56/30-1650 | 2 | PNP | 0.3-6m |
| | 58 | 1710 | 1723.5 | QO58/30-1710 | 2 | PNP | 0.3-6m |
| 60 | 1770 | 1783.5 | QO60/30-1770 | 2 | PNP | 0.3-6m | |
| 62 | 1830 | 1843.5 | QO62/30-1830 | 2 | PNP | 0.3-6m | |
| 64 | 1890 | 1903.5 | QO64/30-1890 | 2 | PNP | 0.3-6m | |
| 66 | 1950 | 1963.5 | QO66/30-1950 | 2 | PNP | 0.3-6m | |
| 68 | 2010 | 2023.5 | QO68/30-2010 | 2 | PNP | 0.3-6m | |
| 70 | 2070 | 2083.5 | QO70/30-2070 | 2 | PNP | 0.3-6m | |
| 72 | 2130 | 2143.5 | QO72/30-2130 | 2 | PNP | 0.3-6m | |

Electrical connection

| Electrical interface | |
|-------------------------------------|------------------------------|
| Number of interfaces | 2 (receiver and transmitter) |
| Type | M12 connector, 7-pin |
| Interface metal | Copper nickel plating |
| Plug material | GY384 gray 30P |
| Allowable typical conductor section | 0.25m ² |
| Maximum link cable | 100m |
| Maximum allowable cable load | 4.9A |
| Cable material | PVC |

Cable description:

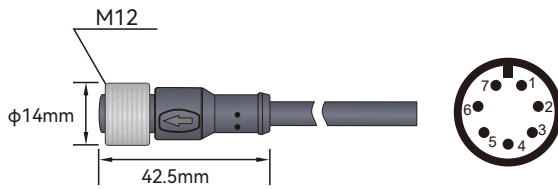

7-pin M12 cable connector straight
3m waterproof cable

| Emitter Wiring diagram | | |
|------------------------|------------|-------------|
| Pin number | Line color | Name |
| 1 | BROWN | 24V DC |
| 2 | BLUE | 0V |
| 3 | BLACK | CP |
| 4 | WHITE | NC |
| 5 | GREEN | NC |
| 6 | RED | CE |
| 7 | YELLOW | Ground wire |

| Receiver Wiring diagram | | |
|-------------------------|------------|-------------|
| Pin number | Line color | Name |
| 1 | BROWN | 24V DC |
| 2 | BLUE | 0V |
| 3 | BLACK | CP |
| 4 | WHITE | OSSD1 |
| 5 | GREEN | OSSD2 |
| 6 | RED | CE |
| 7 | YELLOW | Ground wire |

1. QO signal output selection (actual output of transistor working normally)

NPN NC

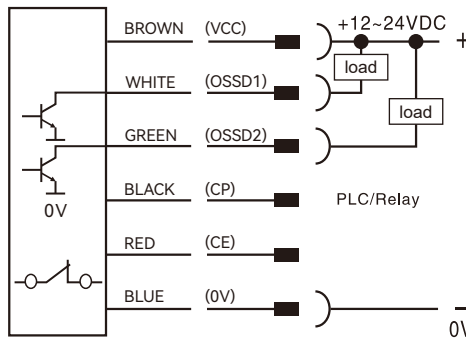

A

PNP NC

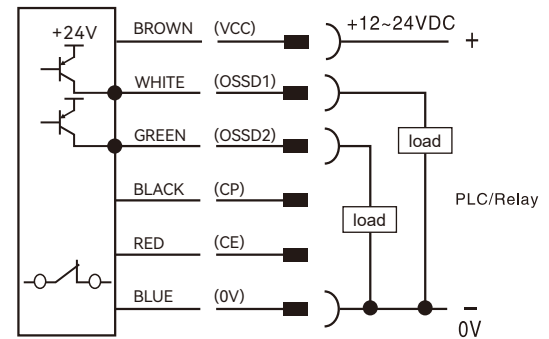

B

NPN NO

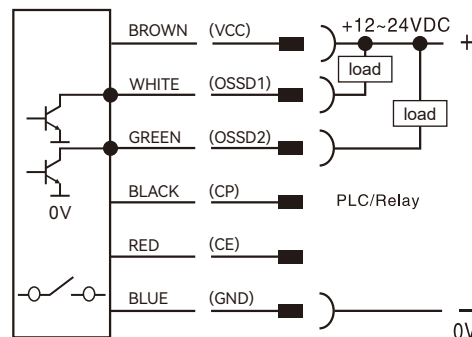

C

PNP NO

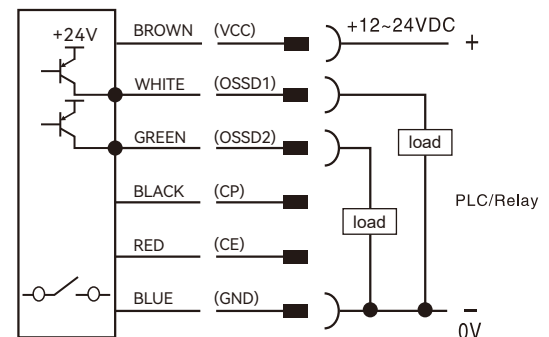

D

2. NPN output wiring diagram

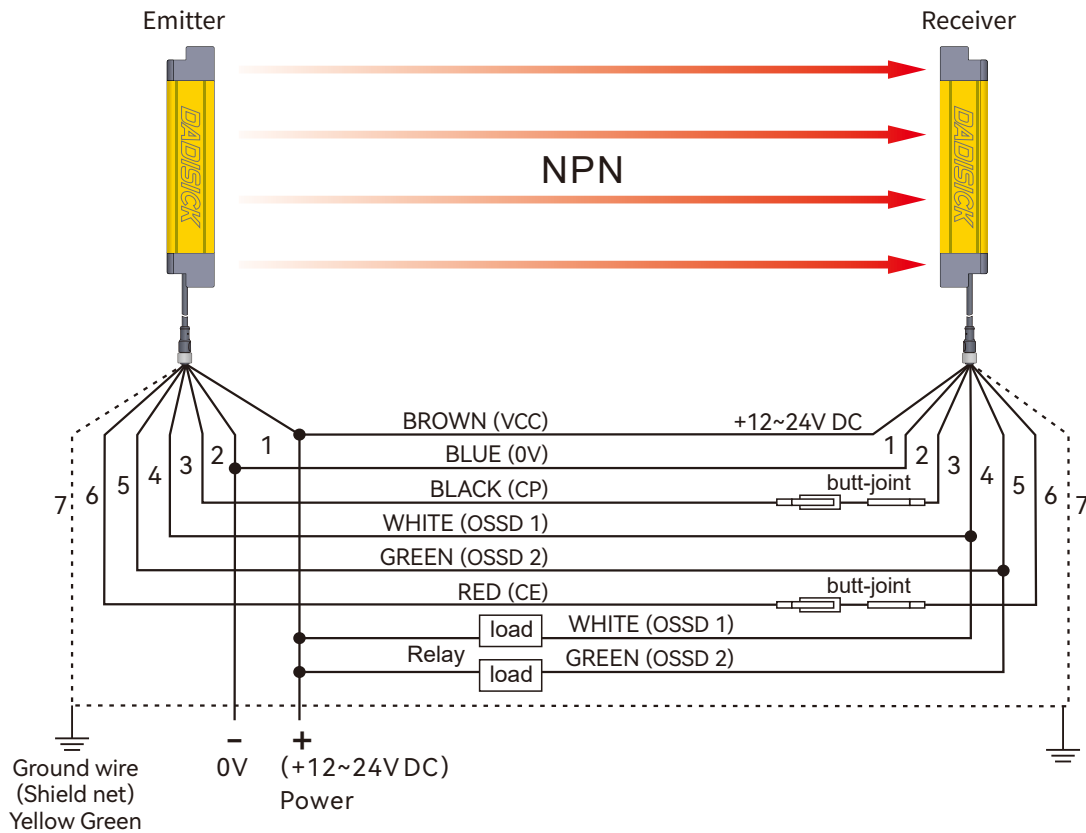



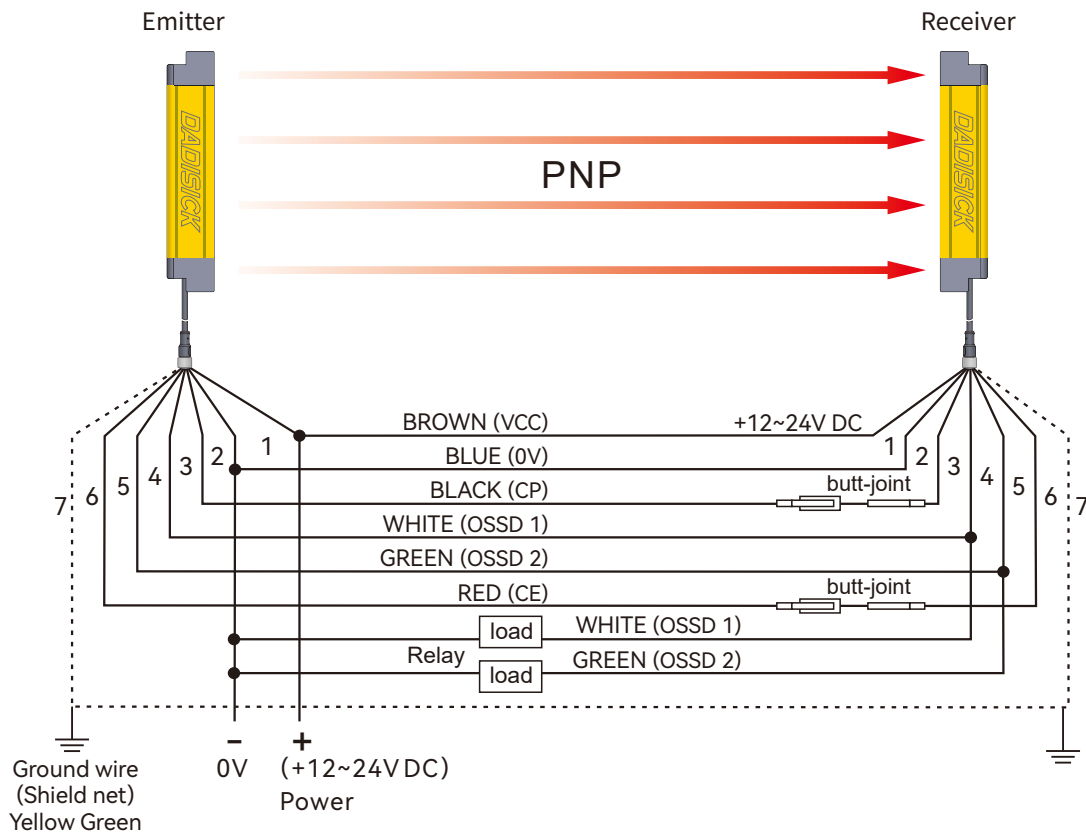

This figure is an example of NPN double output 7-pin wiring.

3. PNP output wiring diagram



This figure is an example of PNP double output 7-pin wiring.

4. Selection of safety light curtain controller

| Name | Order separately | Model | Descriptions |
|---------------------|---|-------|---|
| Built-in controller |  | QET | Used to monitor the signal processing of QO series light curtain, and output one group of NO and one group of NC. |
| Safety relay |  | QSRN | QSRN safety relays have three groups of NO and one group of NC, with strong control capabilities. They are suitable for various signal monitoring in industrial places with high safety requirements, including emergency stop signals, safety door opening and closing signals, safety light curtain signals, and two-handed button signals. |
| Safety relay |   Multifunctional switching switch | Ter-A | Equipped with a mode switch, it can be used for most safety components, such as light curtains, safety switches, carpet contacts, two handed switches, etc. Automatic/manual reset paddles for quick configuration. Dual channel monitoring circuit, safe and reliable. |
| Light curtain relay |  | QET-1 | Output conversion between NC and NO for QO series light curtain. |

4.1 Wiring diagram of QET built-in controller

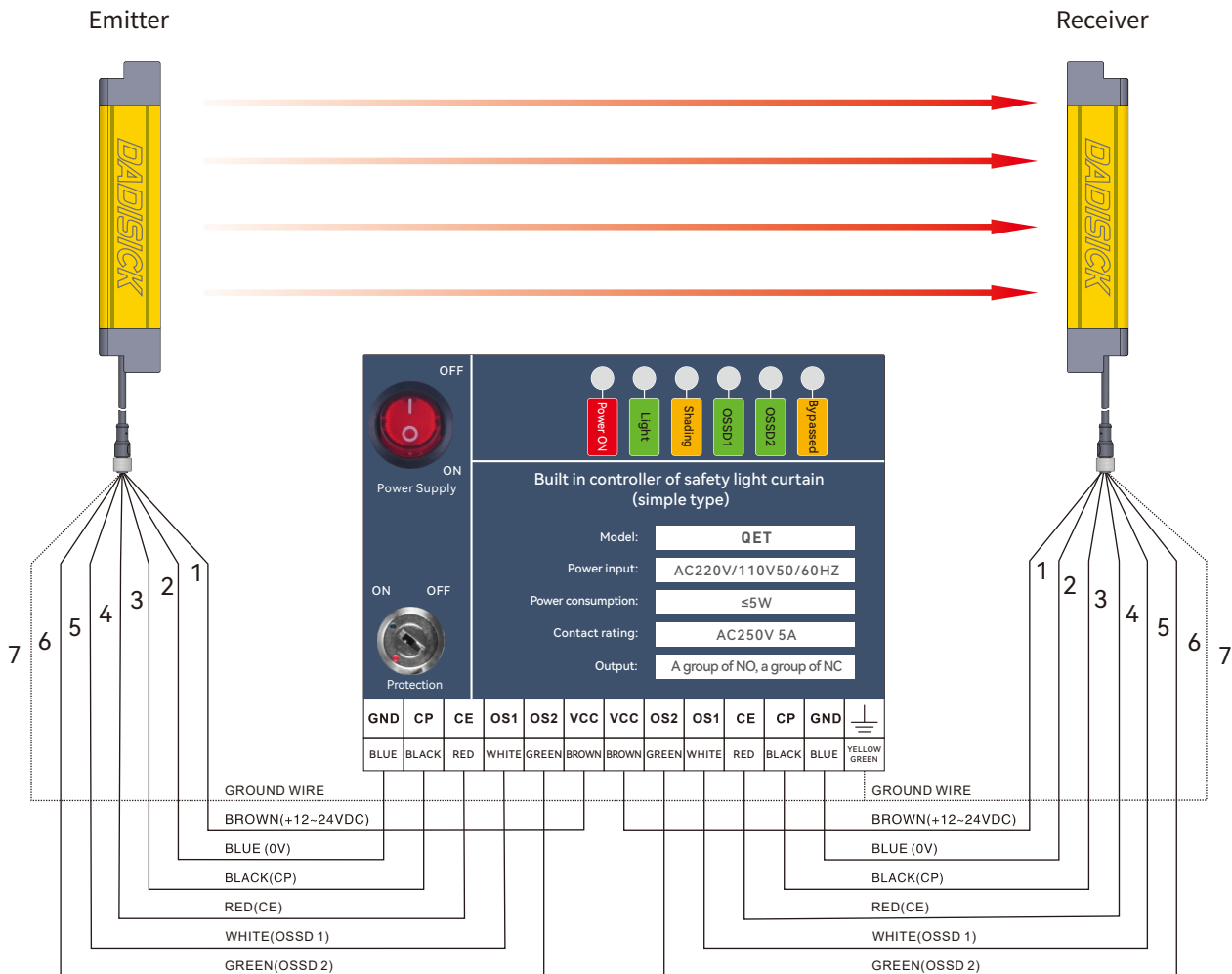

4.2 Wiring diagram of QSRN safety relay

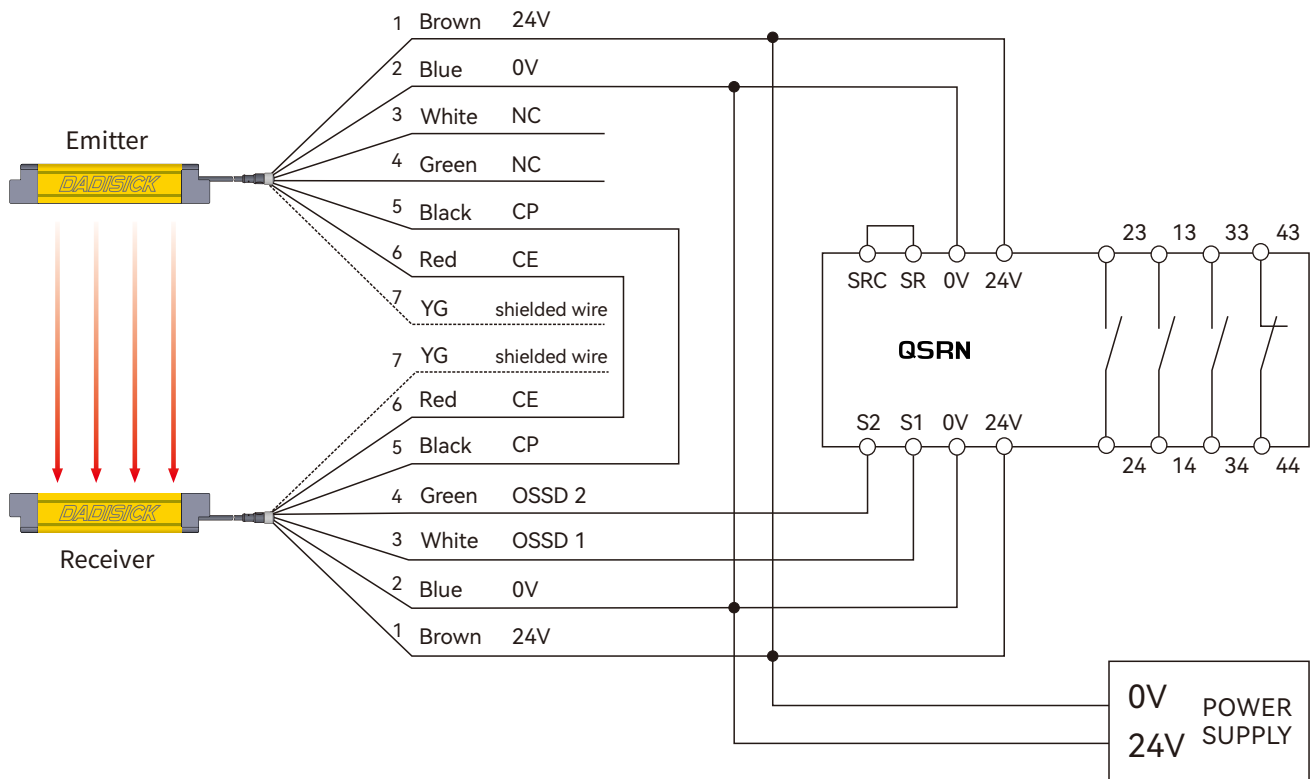

4.3 Wiring diagram of Ter-A safety relay

Dual channel light curtain PNP switch safety input, with automatic reset and PLC signal output.

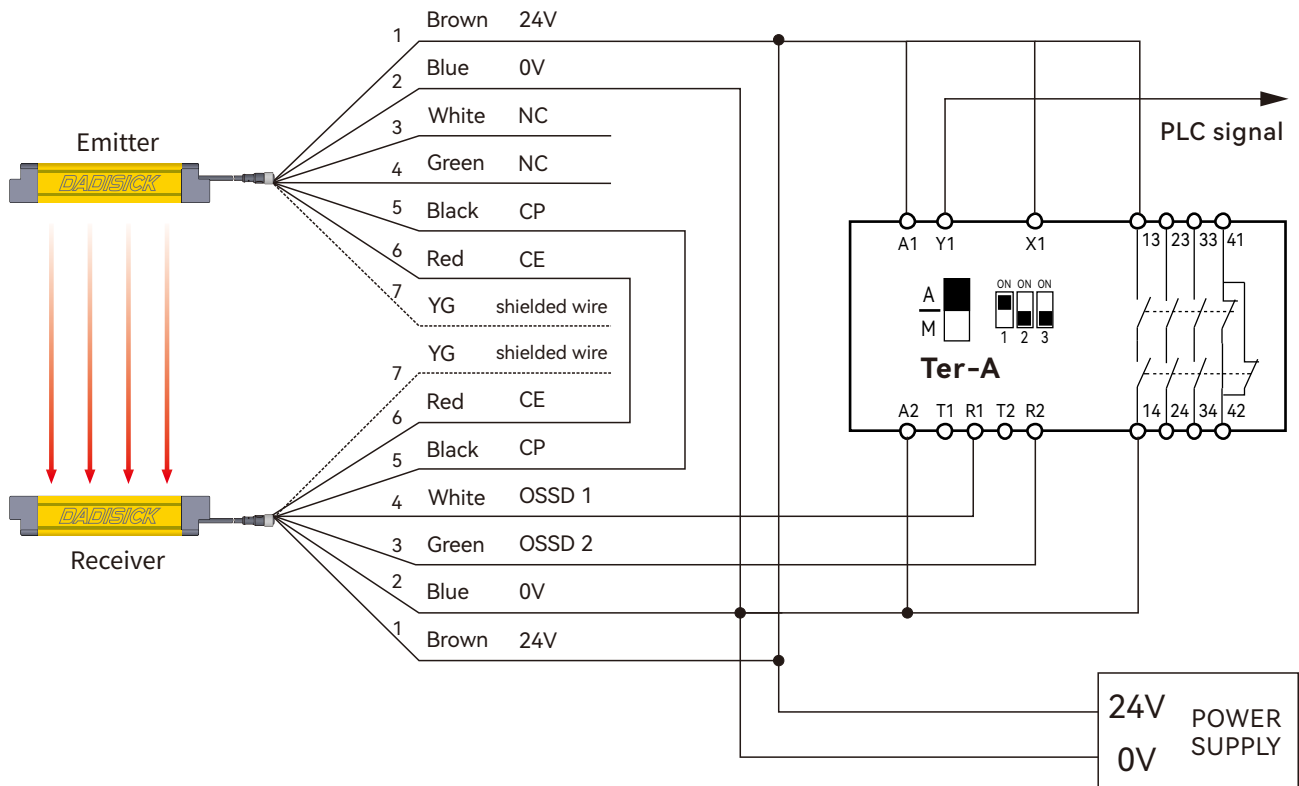

4.4 Wiring diagram of QET-1 light curtain relay



4.5 Wiring between light curtain and PLC and one-chip computer system

NPN wiring:



PNP wiring:



Accessories

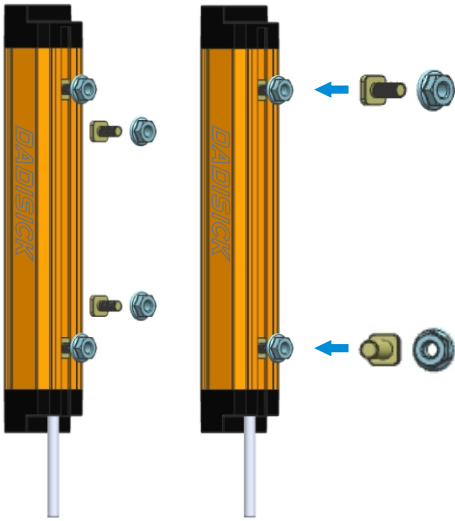

1. Installation method of T-shaped screws on the back
(Original accessories)

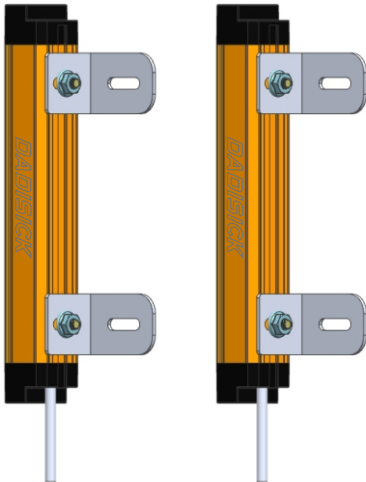

2. Installation method of side right angle bracket
(Original accessories)

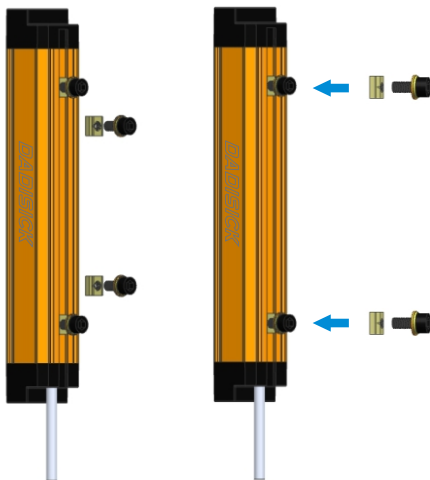

3. Installation method of convex nut
(Optional accessories)

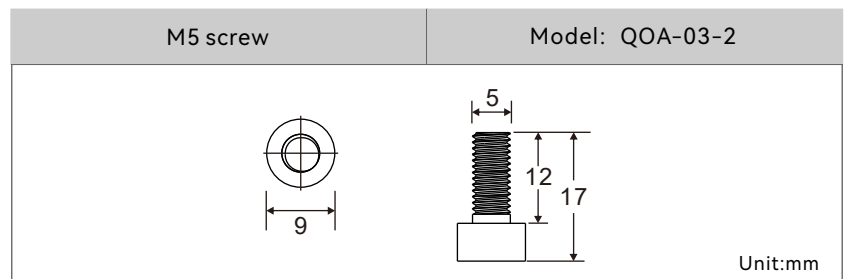
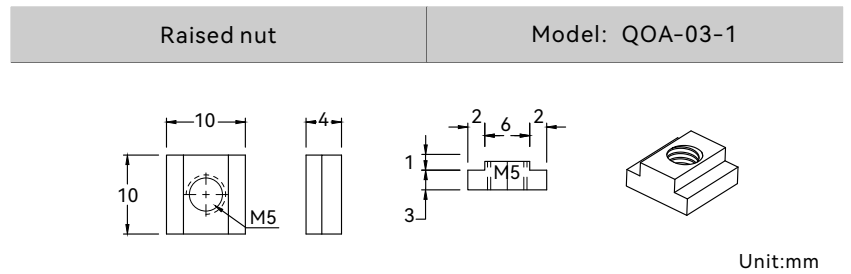

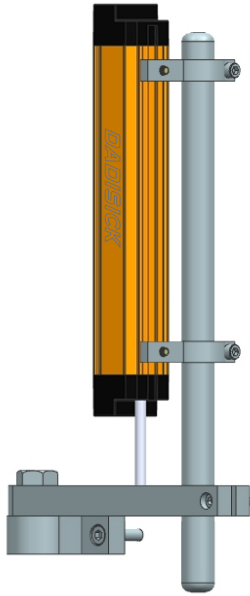

4. Stainless steel bracket installation
(Order separately)

