

TECHNICAL DATA SHEET

SAFETY LIGHT CURTAIN SENSOR

Emitter: QT38/20-740-2BB-E

Receiver: QT38/20-740-2BB-R

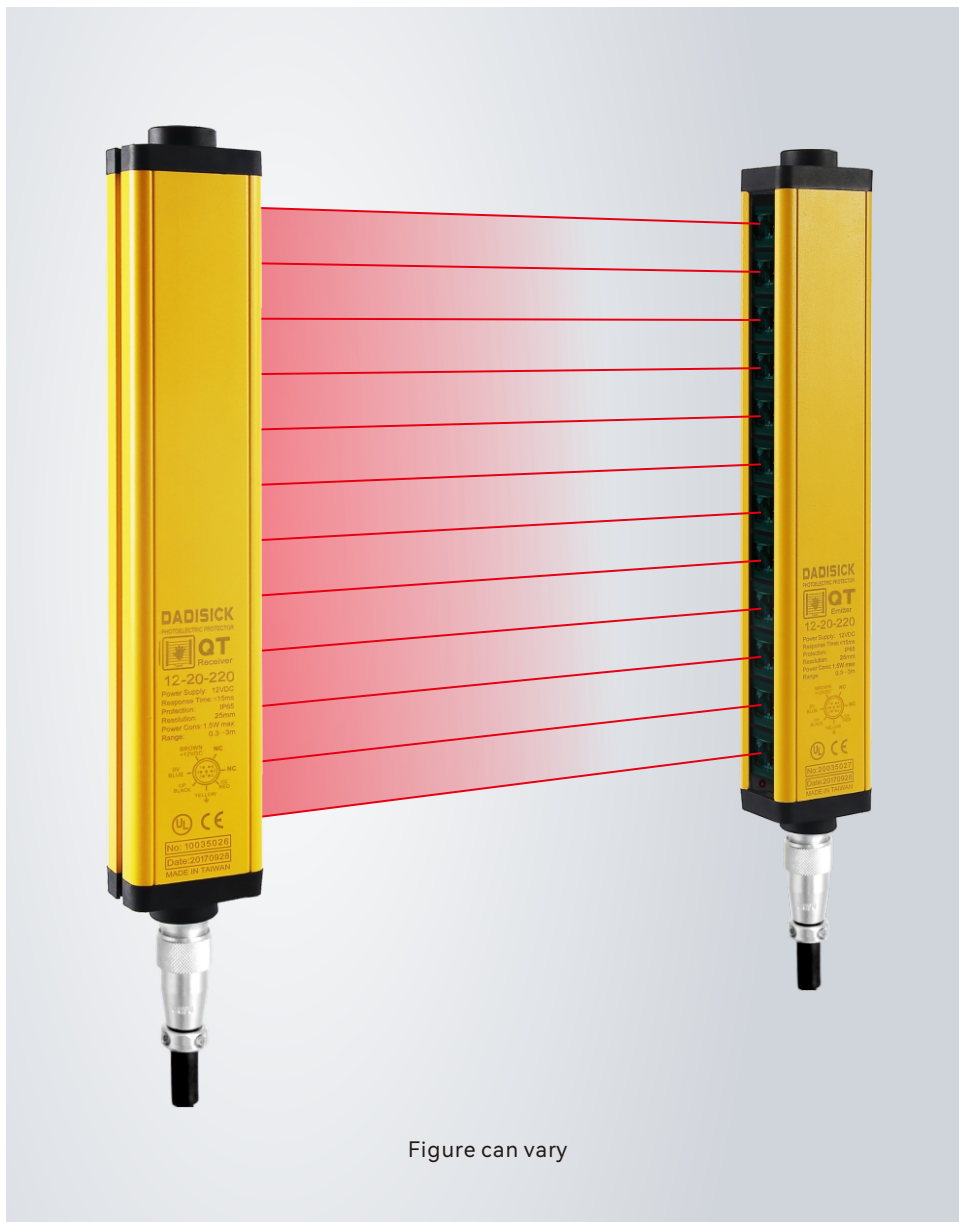

Figure can vary

Contents

- Product application
- Technical data
- Operation and display
- Dimensioned drawings
- Electrical connection
- Wiring diagram
- Accessories



GB/T 19001-2016

Product application

- A. Light curtain can achieve full protection for the slider can be stopped at any position on the press machine.
- B. The light curtain can only achieve upper dead point protection if the slider can not be stopped at any position on the press machine.
- C. Realize the regional protection for the industry manipulator, injection molding machines, packaging equipment, automation equipment, assembly wires and other dangerous work area.
- D. Used to detect and alarm object.

Technical data





Basic data of Receiver and Emitter

Standard packaging	
Product model	QT38/20-740-2BB-E and QT38/20-740-2BB-R
Standard configuration	One receiver, one transmitter, two data lines, one right-angle rack, and one t-shaped screw
Light curtain form	Infrared radiation type
Application	Standard industrial environment - finger protection
Features	
Resolution ratio	20mm
Check the accuracy	28mm
Number of beams	38
Protection height	740mm
Total height	811mm
Detection distance	30-6000mm (Default 30-6000mm, customer service can be contacted to customize 30-45000mm.)
Response time	≤15ms
Synchronization	
Synchronization	Line synchronization
Consumption current	≤200mA
Output mode	2-circuit of PNP, with current of 500mA and voltage below 1.5V, polarity, short circuit and over-cutting protection
Output status	ON (receiving indicator green light)
Indicator light	Transmitter: power indicator light (red); receiver: output indicator light on (green), blackout (red)
Wavelength	850nm
Type of light	Infrared light (NIR), invisible
Function	Automatic reset
Mechanical data	
Overall dimension	51*35*811mm
Housing material	Metal
Metal shell	Aluminium
Lens front screen material	Acrylic
Upper and lower cover materials	ABS reinforced nylon PA66+30% GF
Environmental data	
Protection grade	IP65
Resistance to ambient light	Incandescent light: illumination of light-receiving surface 3000Lx; Sunlight: illumination of light-receiving surface 10000Lx
Ambient temperature	Working temperature: - 10~+40 °C (but not frozen), storage temperature: - 25 ~+55 °C
Ambient humidity	Working time: 35~85% RH, saving time: 35~95% RH

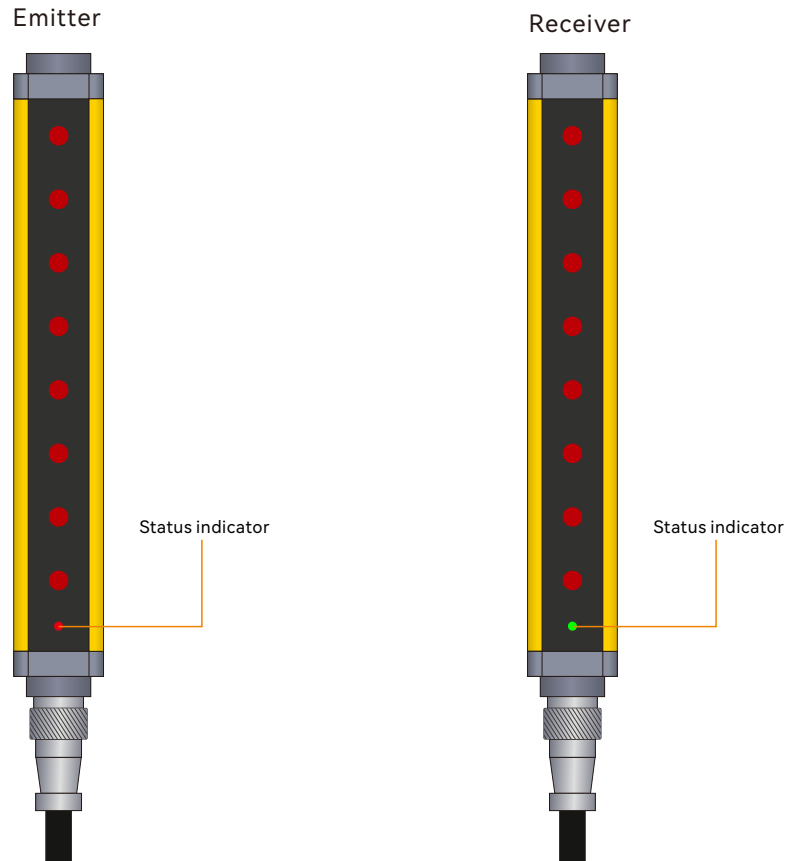
Performance data	
Protection circuit	Short circuit protection Overvoltage protection
Supply voltage	24VDC, -20...20%
Maximum current consumption	150mA
Fuse	2A half time interval
Output	
Number of safe output circuits (OSSD)	2-circuit
Type	Safety circuit output circuit OSSD
Minimum switch voltage high	18V
Minimum switch voltage low	2.5V
Typical switching voltage	22.5V
Voltage type	DC
Maximum current load	380mA
Load inductance	two thousand
Load capacity	zero point three
Maximum residual current	0.2mA
Typical residual current	0.002MA
Voltage drop	1.5V
Safety switch output 1	Connection pin 4, WHITE OSSD1
Switching element	Transistor PNP
Safety switch output 2	Connection pin 5, GREEN OSSD2
Switching element	Transistor PNP
Certificate	
CETÜV	No.E8A 104143 0001 Rev.00
ROHS certification	No.BSTDG180811032001CC
CE TYPE 4	No.ICR Polska/VC/HS221214
UL	No. 4790783741.1-S
GB/T	No. HIC180327 GB/T 19001-2016 idt ISO 9001:2015

Operation and display



Normal operation of light curtain	LED Indicator status	Explain
Emitter	 Red, always on	Turns on the power
	 Receiver and emitter are red	Receiver and Emitter are not aligned
Receiver	 Green	All light paths are connected
	 Red	Light path shading
	 Lights flashing	Interference or overstep detection range

Dimensioned drawings

QT 20mm series

Unit: mm

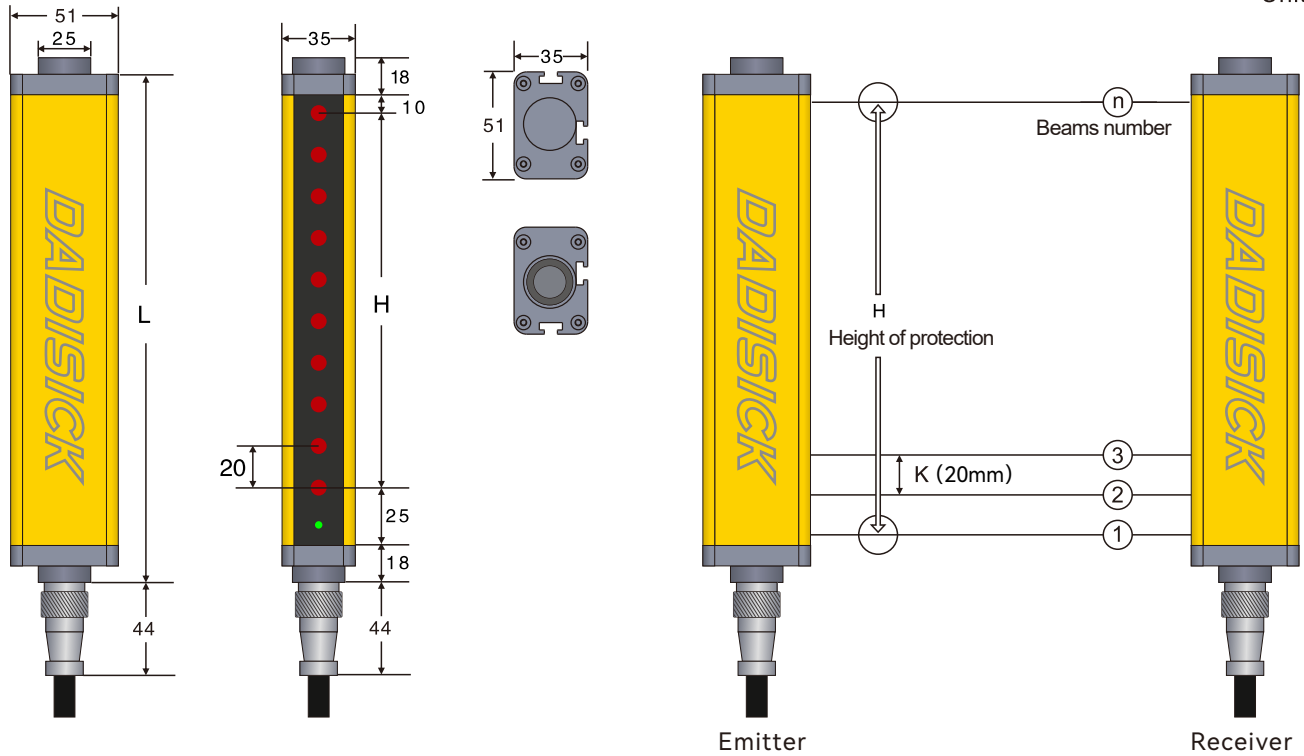

Remarks

L: Total length of light screen

H: Height of protected area

K: Resolution ratio

n: Beams number

 $L = 18 + 10 + H + 25 + 18$ $H = (n - 1) * 20$

QT 20mm specification list

Resolution	Light beam	Protection height (H)	Total height (L)	Product model	Signal output mode		Detection range
					Two outputs	PNP output	
20mm (K)	6	100	171	QT06/20-100	2	PNP	0.3-6m
	8	140	211	QT08/20-140	2	PNP	0.3-6m
	10	180	251	QT10/20-180	2	PNP	0.3-6m
	12	220	291	QT12/20-220	2	PNP	0.3-6m
	14	260	331	QT14/20-260	2	PNP	0.3-6m
	16	300	371	QT16/20-300	2	PNP	0.3-6m
	18	340	411	QT18/20-340	2	PNP	0.3-6m
	20	380	451	QT20/20-380	2	PNP	0.3-6m
	22	420	491	QT22/20-420	2	PNP	0.3-6m
	24	460	531	QT24/20-460	2	PNP	0.3-6m
	26	500	571	QT26/20-500	2	PNP	0.3-6m
	28	540	611	QT28/20-540	2	PNP	0.3-6m
	30	580	651	QT30/20-580	2	PNP	0.3-6m
	32	620	691	QT32/20-620	2	PNP	0.3-6m
	34	660	731	QT34/20-660	2	PNP	0.3-6m
	36	700	771	QT36/20-700	2	PNP	0.3-6m
	38	740	811	QT38/20-740	2	PNP	0.3-6m
	40	780	851	QT40/20-780	2	PNP	0.3-6m
	42	820	891	QT42/20-820	2	PNP	0.3-6m
	44	860	931	QT44/20-860	2	PNP	0.3-6m
	46	900	971	QT46/20-900	2	PNP	0.3-6m
	48	940	1011	QT48/20-940	2	PNP	0.3-6m
	50	980	1051	QT50/20-980	2	PNP	0.3-6m
	52	1020	1091	QT52/20-1020	2	PNP	0.3-6m
	54	1060	1131	QT54/20-1060	2	PNP	0.3-6m
	56	1100	1171	QT56/20-1100	2	PNP	0.3-6m
	58	1140	1211	QT58/20-1140	2	PNP	0.3-6m
	60	1180	1251	QT60/20-1180	2	PNP	0.3-6m
62	1220	1291	QT62/20-1220	2	PNP	0.3-6m	
64	1260	1331	QT64/20-1260	2	PNP	0.3-6m	
66	1300	1371	QT66/20-1300	2	PNP	0.3-6m	
68	1340	1411	QT68/20-1340	2	PNP	0.3-6m	
70	1380	1451	QT70/20-1380	2	PNP	0.3-6m	
72	1420	1491	QT72/20-1420	2	PNP	0.3-6m	

Electrical connection

Electrical interface	
Number of interfaces	2 (receiver and transmitter)
Type	M16 connector, 7-pin
Interface metal	Copper nickel plating
Plug material	kirsite
Rated current (A)	5A
Contact DC (AC V)	Φ1*5
working voltage (AC V)	500V
pressurization (AC V)	1500V
contact resistance	5MΩ
insulation resistance	2000MΩ
Allowable typical conductor section	0.25mm ²
Maximum link cable	100M
Maximum allowable carrying current	4.9A
Cable material	PVC
Shielding	shielded

Cable description:

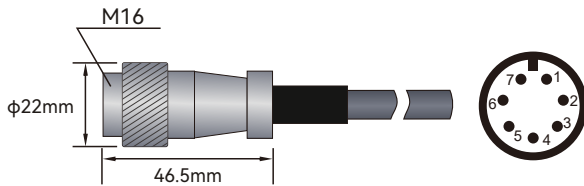

7-pin M16 cable connector straight
3m waterproof cable

Emitter Wiring diagram		
Pin number	Line color	Name
1	BROWN	24V DC
2	BLUE	0V
3	BLACK	CP
4	WHITE	NC
5	GREEN	NC
6	RED	CE
7	YELLOW	Ground wire

Receiver Wiring diagram		
Pin number	Line color	Name
1	BROWN	24V DC
2	BLUE	0V
3	BLACK	CP
4	WHITE	OSSD1
5	GREEN	OSSD2
6	RED	CE
7	YELLOW	Ground wire

1. QT signal output selection (actual output of transistor working normally)

NPN NC

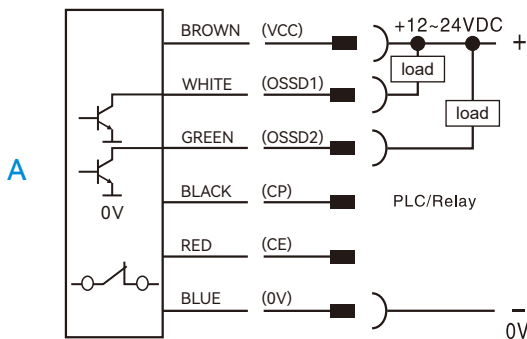

PNP NC

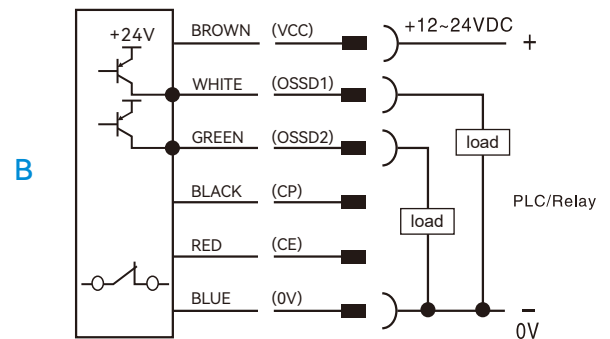

NPN NO

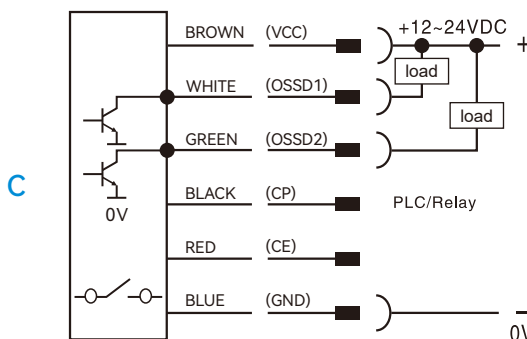

PNP NO

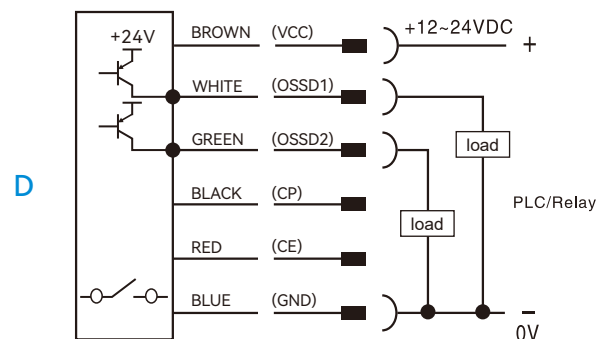

2. NPN output wiring diagram

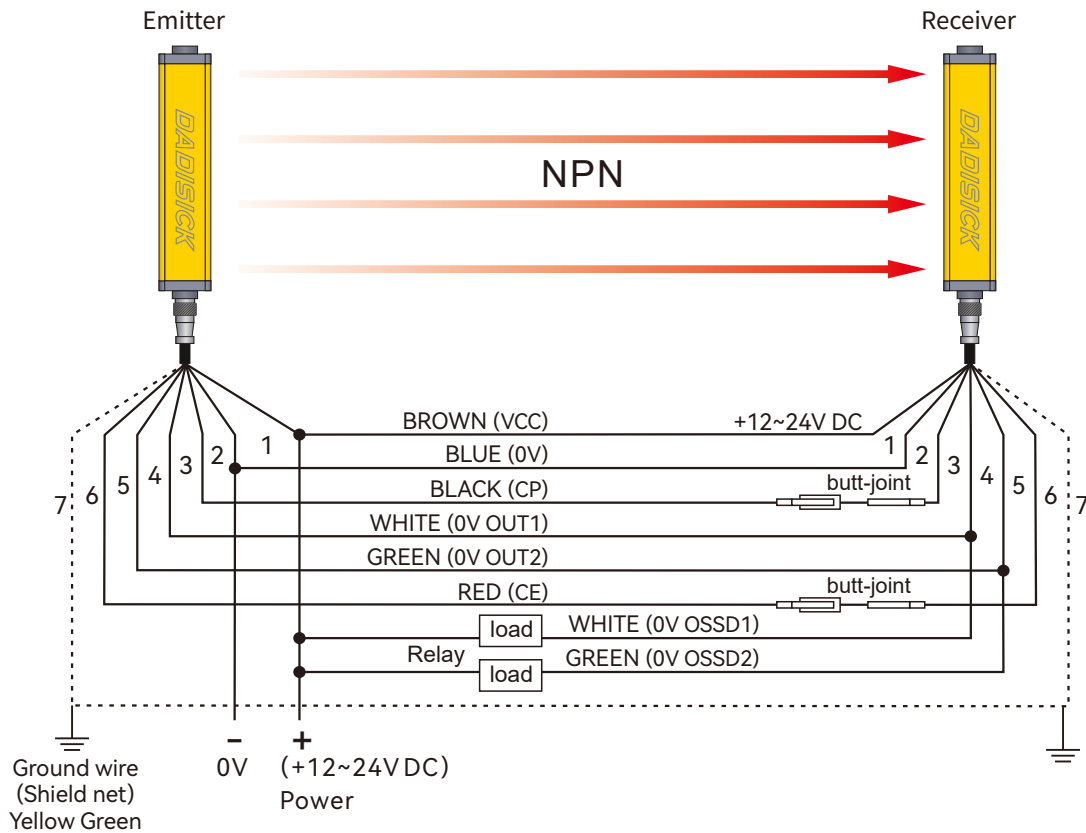



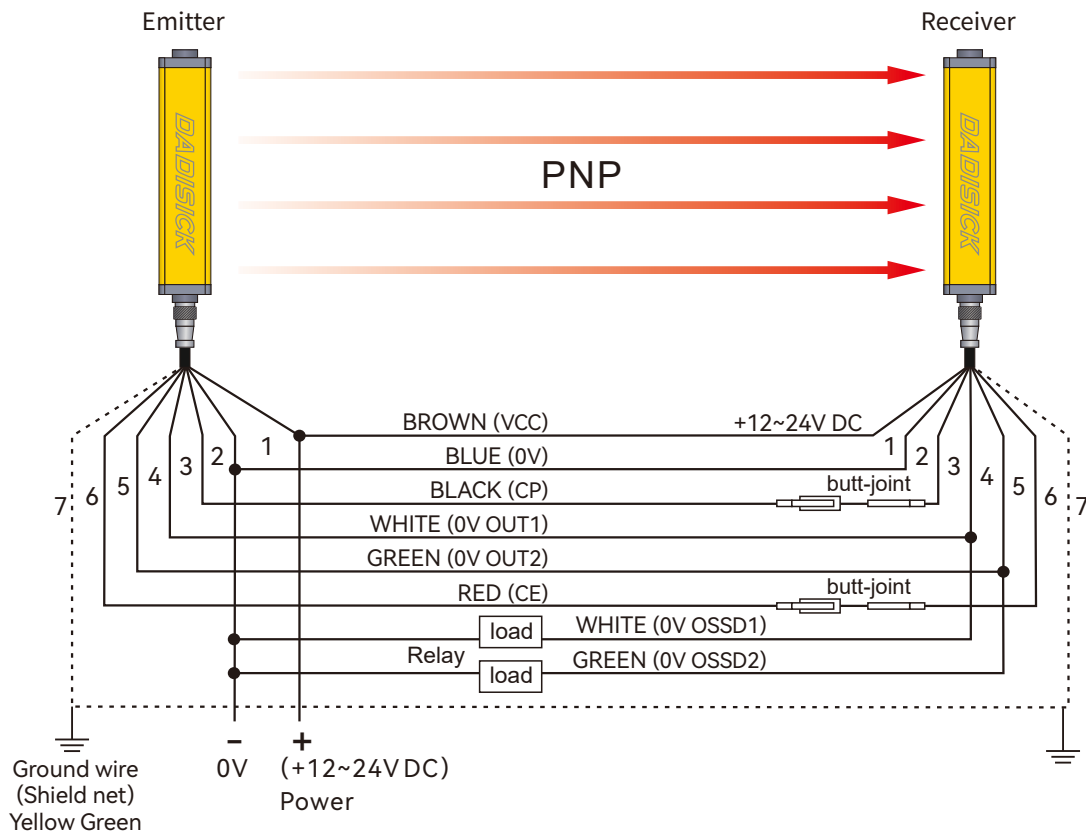

This figure is an example of NPN double output 7-pin wiring.

3. PNP output wiring diagram



This figure is an example of PNP double output 7-pin wiring.

4. Selection of safety light curtain controller

Name	Order separately	Model	Descriptions
Built-in controller		QET	Used to monitor the signal processing of QT series light curtain, and output one group of NO and one group of NC.
Safety relay		QSRN	QSRN safety relays have three groups of NO and one group of NC, with strong control capabilities. They are suitable for various signal monitoring in industrial places with high safety requirements, including emergency stop signals, safety door opening and closing signals, safety light curtain signals, and two-handed button signals.
Safety relay	  Multifunctional switching switch	Ter-A	Equipped with a mode switch, it can be used for most safety components, such as light curtains, safety switches, carpet contacts, two handed switches, etc. Automatic/manual reset paddles for quick configuration. Dual channel monitoring circuit, safe and reliable.
Light curtain relay		QET-1	Output conversion between NC and NO for QT series light curtain.

4.1 Wiring diagram of QET built-in controller

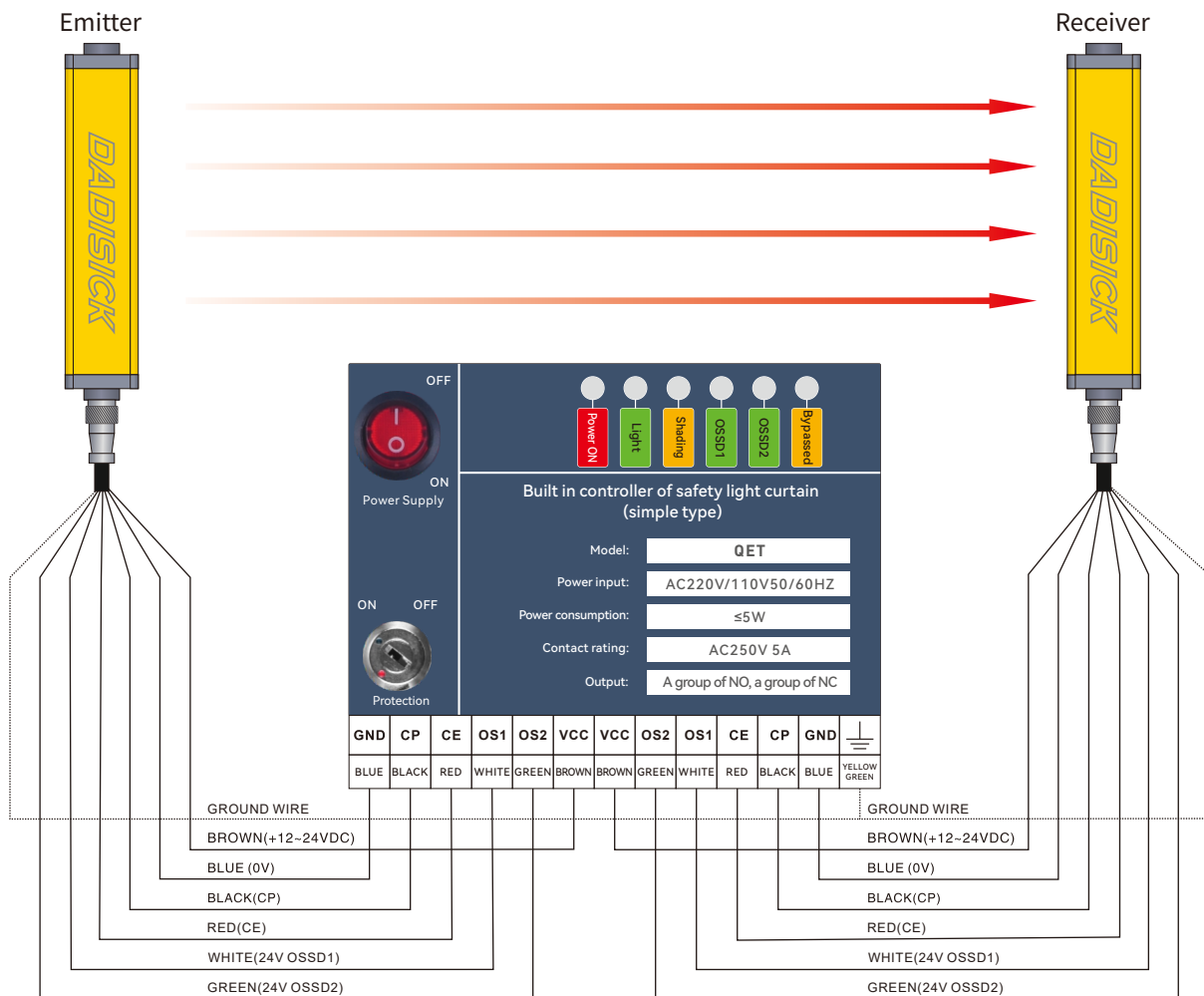

4.2 Wiring diagram of QSRN safety relay

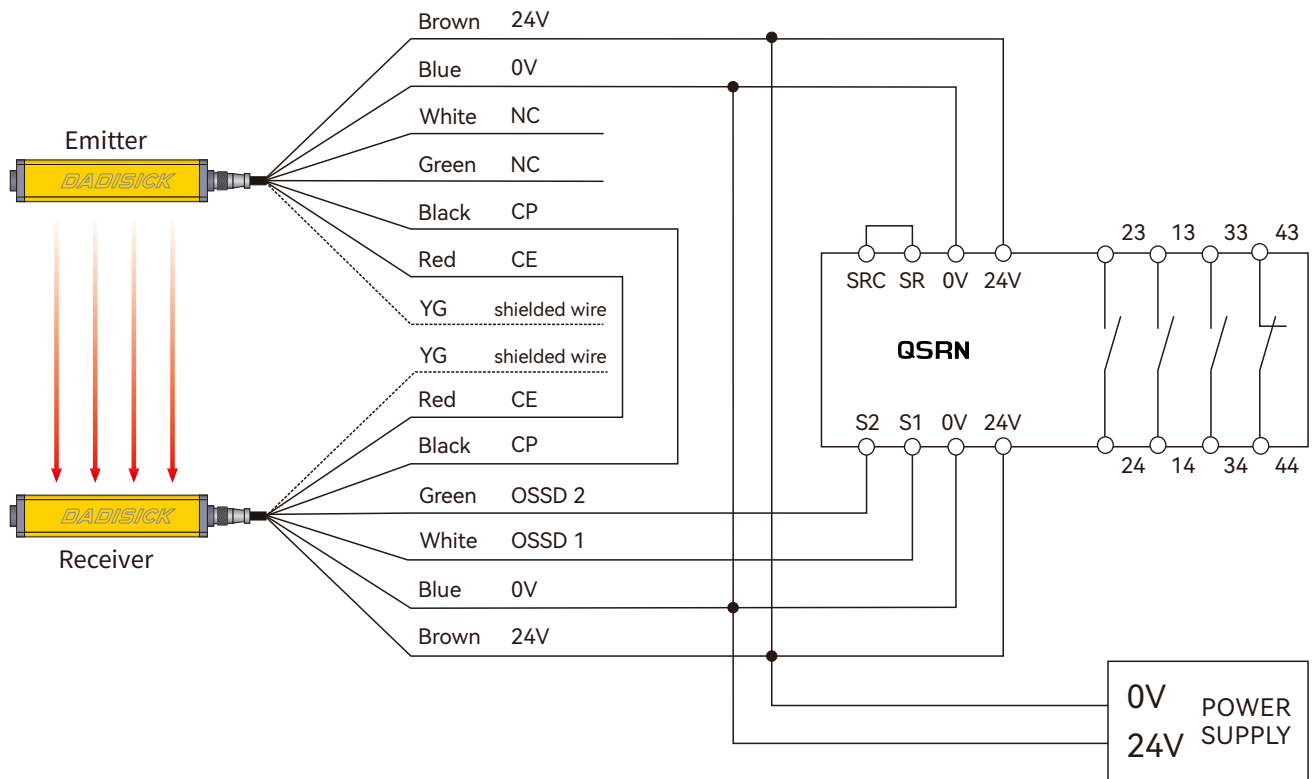

4.3 Wiring diagram of Ter-A safety relay

Dual channel light curtain PNP switch safety input, with automatic reset and PLC signal output.

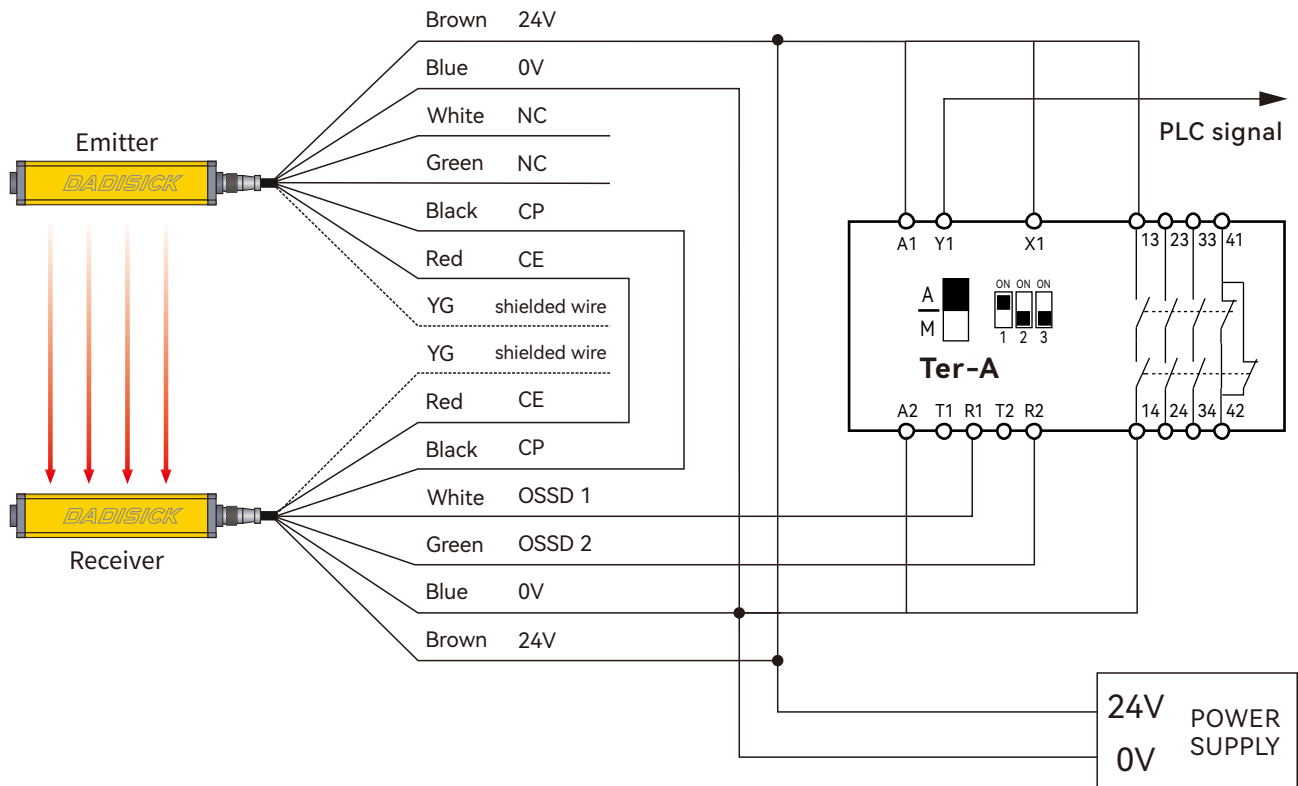

4.4 Wiring diagram of QET-1 light curtain relay



4.5 Wiring between light curtain and PLC and one-chip computer system

NPN wiring:

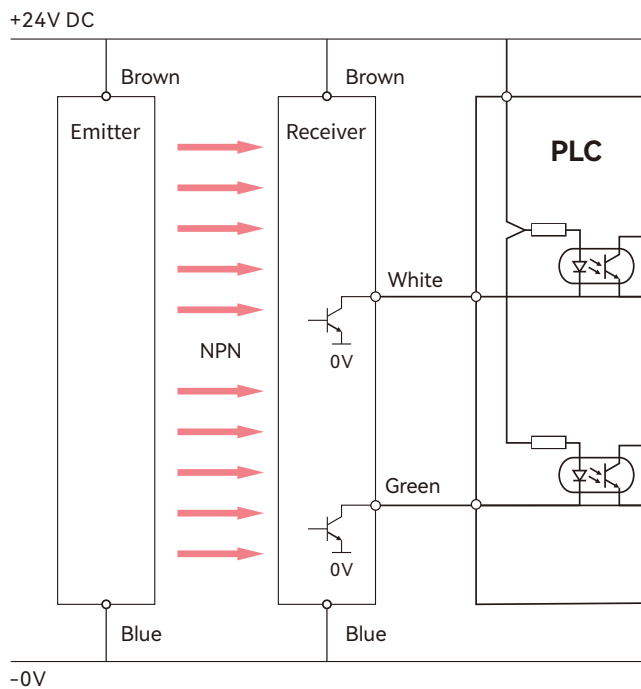

PNP wiring:

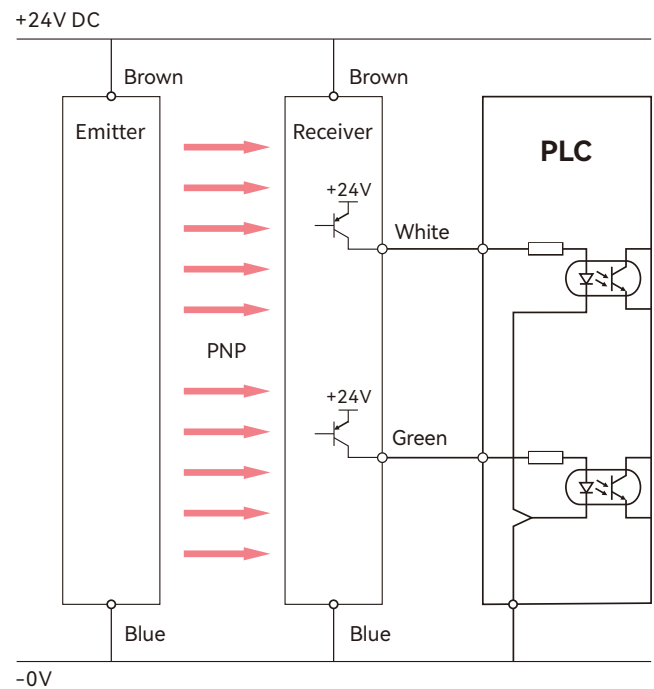

Accessories

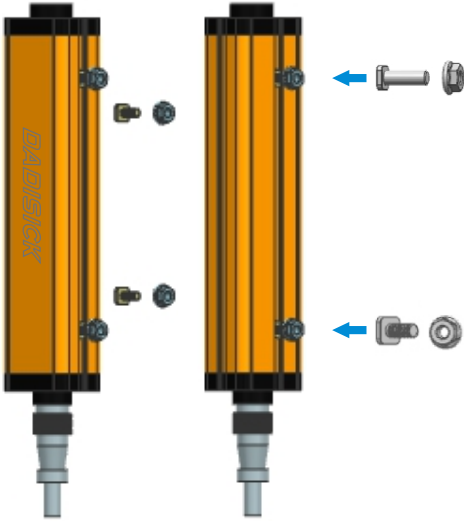

1. Installation method of T-shaped screws on the back
(Original accessories)

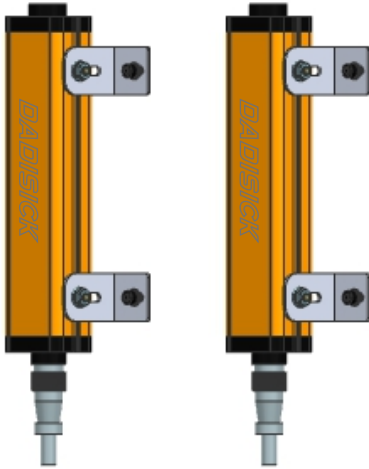

2. Installation method of side right angle bracket
(Original accessories)

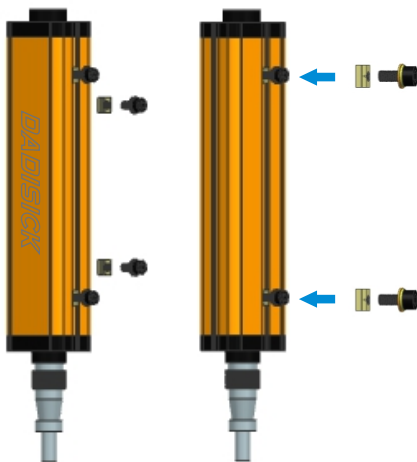

3. Installation method of convex nut
(Optional accessories)

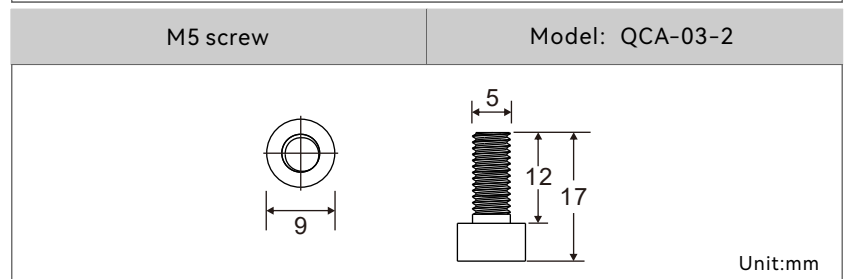
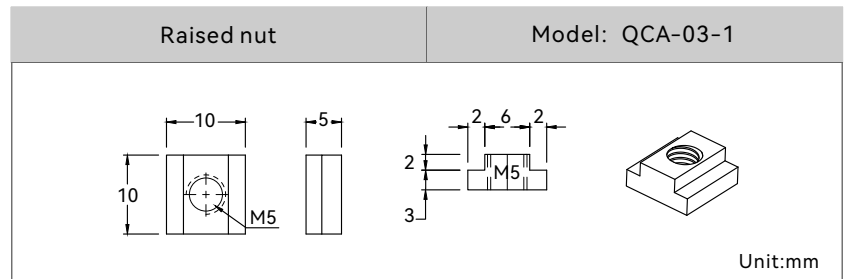
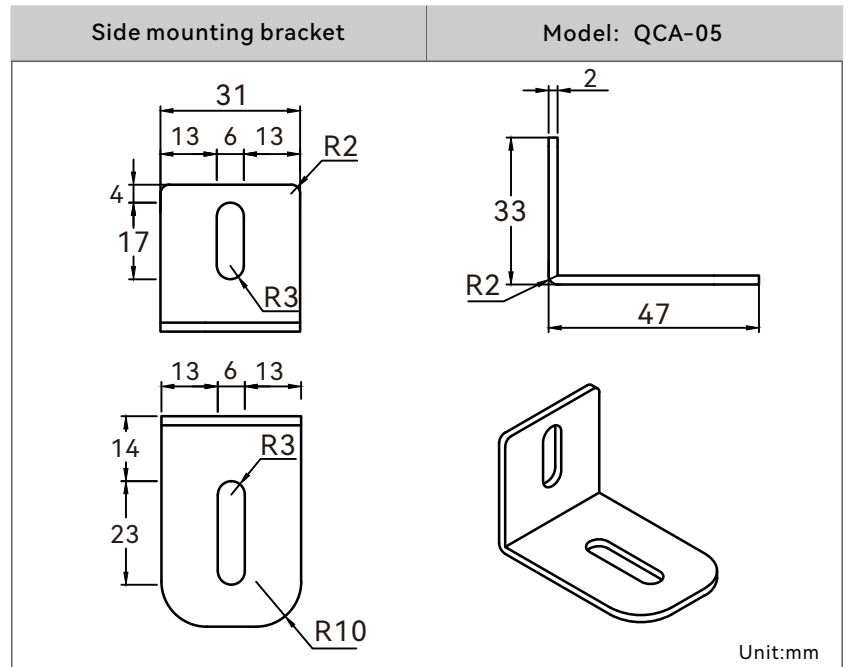
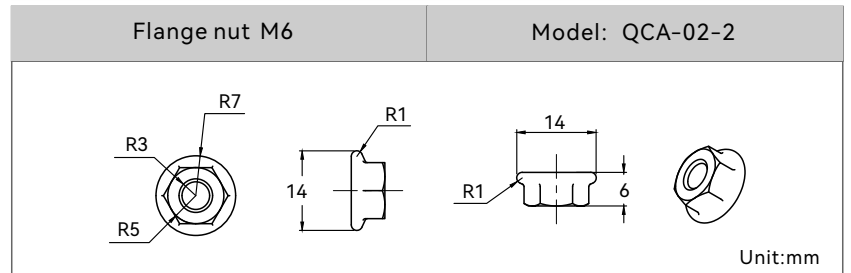
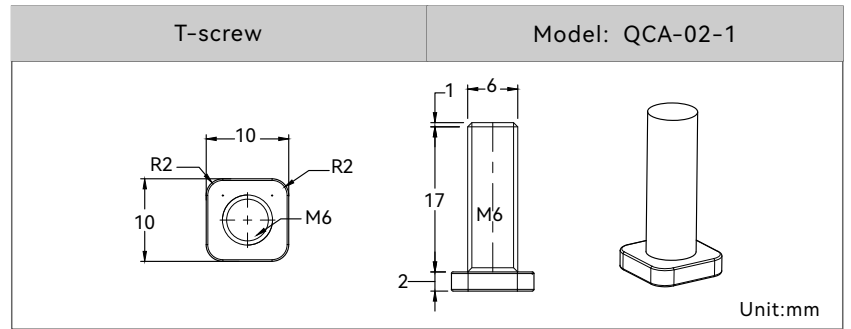

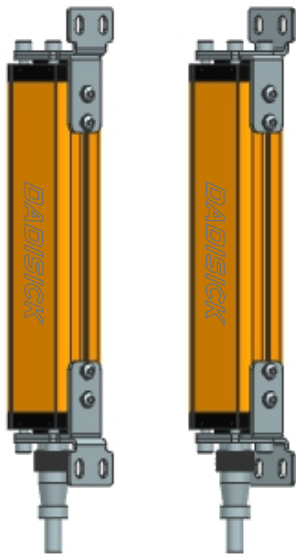

4. Installation method of right angle brackets at both ends
(Order separately)

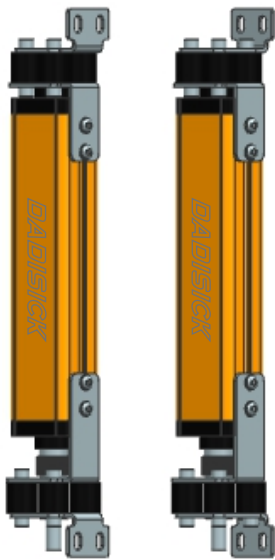

5. Shockproof installation method of right angle brackets at both ends
(Order separately)

Right angle brackets at both ends

Model: QA-02

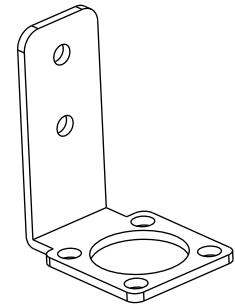
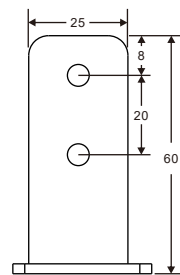
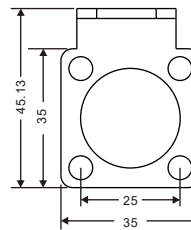
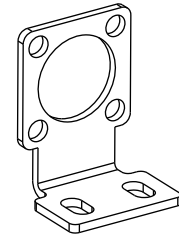
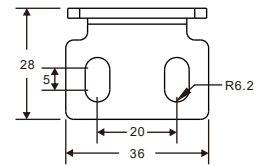
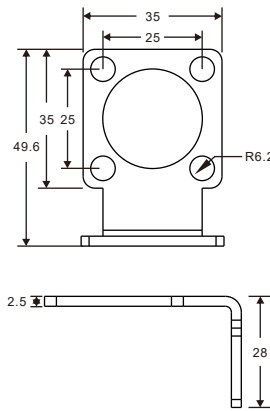

Unit:mm

Shockproof right angle brackets

Model: QA-01

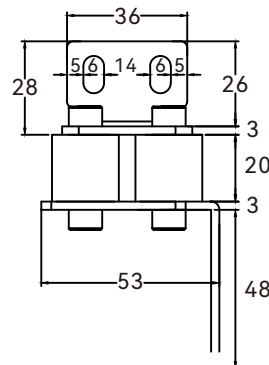
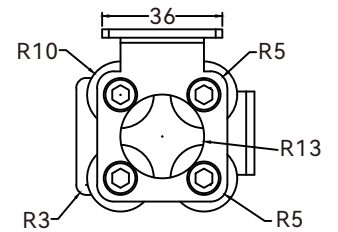
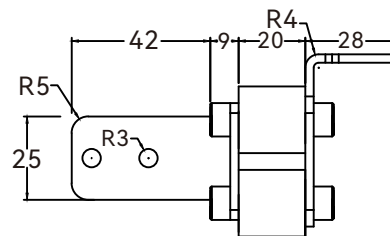

Unit:mm

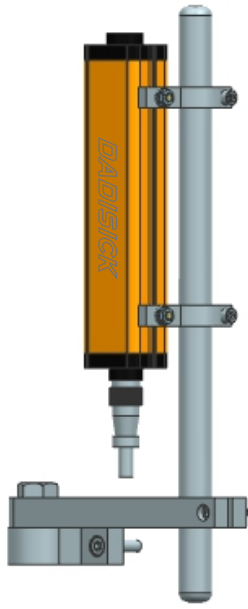

6. Stainless steel bracket installation
(Order separately)

