

Cigar Humidor Instruction Manual

Catalog

Important Safety Information	2
Humidor Cabinet Structure Diagram	3
Installation Instructions	4
Operation and Temperature Settings	5-6
Maintain And Care.....	7
Troubleshooting.....	8-9
Technical Parameter.....	10
Warranty.....	10

Important Safety Information

⚠ Use the following safety principles to avoid damage to the humidifier due to the working environment.

⚠ Please read carefully before using the product and retain all operating instructions for future reference.

⊘ Do not allow children to climb, stand or hang on the shelves in the cooler. They could damage the cooler and seriously injure themselves.

⊘ Do not use damaged wires, if damaged, it must be replaced by the manufacturer or professionals to avoid danger

⊘ It is strictly forbidden to use inferior wires and power strips to switch. Make sure to plug it directly into a power outlet.

⊘ Do not clean the product with flammable, corrosive liquids. Please wash with mild detergent

⊘ Do not place the product near any flammable materials, keep away from heat sources, and avoid direct exposure to the sun.

⊘ Do not pull the cord to remove the plug, remove the plug from the outlet, and do not plug into the power outlet until installed.

Humidor Cabinet Structure Diagram

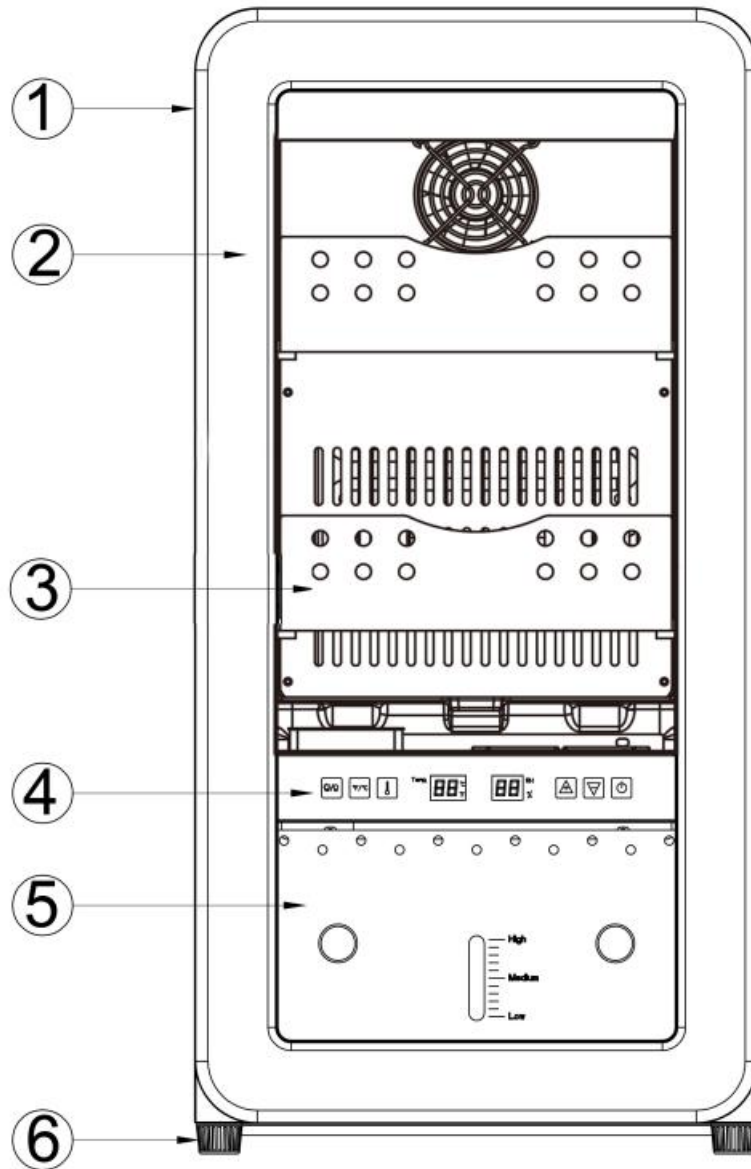

- (1) Box body
- (2) Door
- (3) Cedar shelf
- (4) Control panel
- (5) Water tank
- (6) Adjustable leg

Installation instructions

Note: Put the humidor in the location you want to install, this location should be:

- ① Away from heat source, good air mobility;
- ② Not damp;
- ③ On a stable surface;

1. The humidor that has been transported needs to be left for 2 to 3 hours before it is connected to the power supply for normal operation.。
2. When carrying/moving the humidor, do not use the door or door handle as the focal point, lift the humidor upright from the bottom, and do not allow it to be lifted horizontally or upside down to consolidate all movable parts (the items in the thermostatic humidor should be emptied).
3. Please remove the outer and inner packaging first and clean with a soft cloth moistened with warm water.。
4. When installing a non-recessed humidor, make sure that there is at least 50mm clearance on each side and at least 100mm clearance at the back, as this is the main outlet for hot air, and an adequate ventilation system must be left

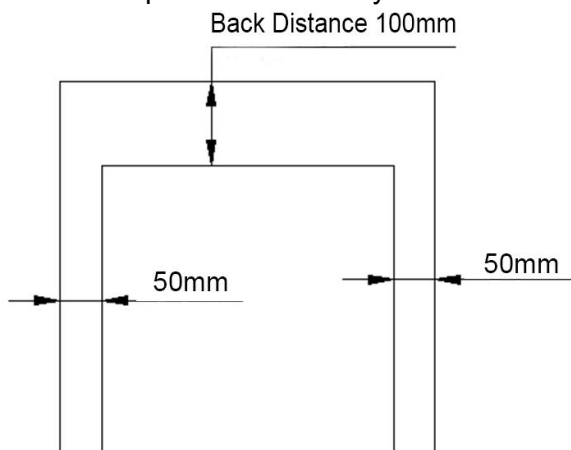

5. After a power failure or shutdown, the automatic protection of the compressor needs to wait for 5 minutes before restarting the cooling.
6. When the humidor is loaded, make sure the floor is level.。
7. Avoid placing the humidor near heat sources, direct light and humidity, and make sure the humidor is vertical and level (to prevent vibration and noise).
8. Do not place items on the top of the humidor, avoid storing food or drinks, and ensure that there is sufficient space between the humidors for ventilation.

Moving the humidor

Take out all cigars or other items and fix the shelf, tie the closed door, to prevent damage to the adjustable feet, Please tighten them all to ensure that the humidor stays upright at all times during transport.

Operation and Temperature Settings

1. Plug in the power cord and turn on the power. The rated power supply used by the cigar cabinet is 220-240V/50HZ, the power socket used is a standard 12A-16A.220V socket with a ground wire, and the socket should also be equipped with a fuse and a leakage protection switch.
2. Power on for the first time, the machine will run automatically
3. When the machine is turned on for the first time, the temperature inside the cigar cabinet is displayed according to the ambient temperature (room temperature) outside the cigar cabinet.
4. When the machine is turned on for the first time, the humidity inside the humidor is displayed according to the ambient humidity outside the humidor.
5. When the humidor is in normal operation, the measured temperature/humidity in the cabinet is displayed, and the fan in the humidor starts to run.

The temperature/humidity inside the machine can be adjusted by the control buttons.

Note: Temperature/humidity control operation as shown (single temperature)

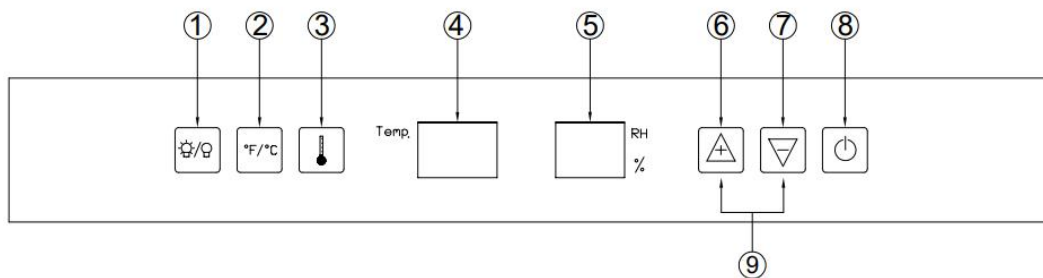



1. The temperature of the single-temperature humidor can be set between 16-22°C, and the humidity is between 60%-80%. According to different types, different temperature and humidity can be set.

2. Introduction to the functions of the control panel:

① Light ON/OFF key press this key to control the LED light ON and OFF.

② °C/°F Switch key Touch this button to to switch °C/°F.

③ Temperature/humidity setting key Temperature/humidity setting must first press this key to set. Press , the temperature display digital tube flashes, indicating that the temperature can be changed by pressing or press it again, the humidity display digital tube flashes (the temperature display digital tube stops flashing), indicating that the



humidity can be changed by pressing  or  ; press this key again, the temperature/humidity display digital tube stops flashing and resumes displaying the temperature and humidity respectively which is the temperature and humidity inside the box. When the temperature and humidity inside the box is set, without pressing any key, it will automatically return to the state of displaying the temperature and humidity inside the box respectively after 5 seconds;

④ Temperature setting/display window 

⑤ Humidity setting/humidity display window 

⑥ Set temperature/humidity up key  . When the temperature setting/temperature display in the box or the humidity setting/humidity display in the box is flashing, press this key to change the set temperature/humidity in the box. Press it once, the temperature/humidity will rise by 1 degree, until the highest value of the temperature/humidity setting in the box;

⑦ Set temperature/humidity down key  , When the temperature setting/temperature display in the box or the humidity setting/humidity display in the box is flashing, press this key to change the set temperature/humidity in the box. Press it once, the temperature/humidity will drop by 1 degree, until the minimum value set by the temperature/humidity in the box;

⑧ Power switch key.  In the off state, the display does not show. Press  for 3 seconds, the screen will display all parameters normally, and the humidifier will start to work. When you need to stop working, press the button for 3 seconds to turn it off.

⑨ Child lock (⑥+⑦) , press  and  for 3 seconds to lock the panel, press it for 3 seconds again, unlock.

3. Power-off setting temperature/humidity memory function: that is, the set temperature/humidity is still automatically saved in the case of power-off, and the next time the humidifier is powered on, its temperature/humidity set value will still be the same as the set temperature when the last shutdown humidity;

4. Automatic defrost function: The humidifier has been designed with an automatic defrost function. The purpose of the defrosting function is to regularly remove the frost that remains on the surface of the evaporator of the refrigeration system (built-in, invisible when it is not disassembled), so as to ensure that the refrigeration system has been operating efficiently and in a good cooling state. When the machine runs for a period of time, the machine automatically enters the defrosting state, at this time the compressor of the humidifier stops

running, and the cooling fan in the box runs continuously. When defrosting, the temperature in the box will rise, which is not a malfunction.

Maintain and care

Hint:

1. After the power failure, the self-protection function of the compressor needs to wait for 5 minutes before restarting the refrigeration; otherwise, the humidor cannot operate。
2. If you use the humidor for the first time or use it again after a long shutdown, it may be that the temperature/humidity you set is inconsistent with the temperature/humidity displayed in the humidor. After the humidor has been running for a period of time, the temperature/humidity display will return to normal. .

Door lock

Some cigar cabinets are equipped with safety locks. The cigar cabinets are equipped with protective locks. The keys are placed in the packaging bag of the instruction manual. Take out the key and insert it into the lock hole and turn it to the left to open the cabinet door immediately. in a safe place.

Cleaning the humidor(Keep it clean to prevent odors, and follow the steps below.)

1. Switch off the power supply, clean the surface of the shelf with a clean soft cloth and dry it immediately.
2. Do not use coarse brushes and rough abrasive cleaners to clean the interior of the humidor, as this will easily damage the surface of the interior。
3. Wipe the outside of the humidor with a soft cloth dampened with neutral detergent or warm water, and then dry with a clean soft cloth.
4. When cleaning the humidor accessories, the power cord must be unplugged. Wipe off moisture with a sponge or soft cloth to prevent water or other liquids from seeping into the humidor accessories and causing electric shock.

power failure

Most power outages are repaired within 1 to 2 hours, with little impact on the humidor. However, opening the door of the cigar cabinet should be minimized during a power outage. If the power is cut off for a long time, the cigar should be taken out of the humidor to prevent deterioration, or other corresponding measures should be taken.

Decommissioning of the humidor

If you decide to take the humidor out of service for a period of time, please follow these steps:

- 1.First turn off the power and unplug the power plug;
- 2.Remove all items in the humidor and clean;
- 3.Open the door slightly to avoid unpleasant odors.

Troubleshooting

1. Humidor does not operate: no power supply or power switch turned on; circuit fault or blown fuse.

2. Poor cigar cabinet cooling: Check temperature control settings; ambient temperature is too high or ventilation is poor; doors are opened too many times; doors are not closed properly.

3. The LED light does not light up: the light switch is not turned on; the circuit is faulty or the fuse is blown.

4. Humidor Vibration: Make sure that the humidor is positioned smoothly.

5. Too much noise: whether there is an item behind the humidor that resonates with the cabinet; whether it is placed in an unstable or uneven place.

Note: If the humidor cannot operate normally, in any case, in order to ensure safety, first pull out the power plug, and then contact the supplier.

6.Trouble shooting:

Fault Code	Reason	Solution
E0	Sensor failure	Change Sensor
E5	Communication failure	Please contact customer service before returning to our service center for inspection/repair

Several non-fault phenomena

1.Condensation on the surface of the humidor

Condensation is a natural phenomenon. The humidor works in a high temperature and high humidity environment in summer. Because of the low temperature of the cabinet shell and glass door surface, the moisture in the air will condense on the surface of the cabinet shell and glass door, and it is moist to the touch. a feeling of. Condensation mainly occurs in the door seal, door surface and other parts. 。 When the relative air temperature exceeds 80%, bead condensation will appear on the surface of the glass door of the humidor. This is a

normal phenomenon. When condensation occurs, you can wipe the condensation off with a soft cloth. Condensation will disappear naturally when it is reduced, and will not affect the performance of the humidor. In addition, in order to reduce the occurrence of condensation, please pay attention to the following points when using:

1. Humidor in the summer rainy season, often use a soft cloth to clean the surface of the glass door and other condensation parts, which can reduce the condensation phenomenon.
2. Place the humidor in a well-ventilated location, which can also reduce condensation.

2.Box heats up

The condensing pipes are close to the inner sides of the left and right side panels of the outer box. When the cigar cabinet is working, the heat is dissipated through the condensing pipes. In order to obtain the best cooling effect for the humidor you choose, please pay attention to the following points when using it:

1. Keep the side panels of the box clean, and leave a cooling space of no less than 50MM for the cigar cabinet.
2. The humidor should be placed in a well-ventilated position so that the heat emitted from the surface of the box can be fully exchanged with the surrounding air.
3. Since the surface temperature of the cigar cabinet rises when it is refrigerated in summer, it will cause the surrounding temperature to rise during operation. Items that are sensitive to temperature should not be placed on both sides of the cigar cabinet.
4. Although the temperature of the cigar cabinet will not be very high, children should be careful not to touch the cooling surface of the cabinet in summer.

Humidor has a "humming" vibration or sound like running water:

1. When the humidor is working, the compressor will make a slight "humming" sound. Vibration and noise can also be generated if the humidor is not positioned evenly.

2. The refrigerant in the refrigeration system flows in the pipeline like the sound of running water. If the above sound is normal

Technical parameter

Model	ZS-A48X	ZS-A58X
Temperature Range	16-22℃	16-22℃
Humidity	60%-80%	60%-80%
Net Volume	36L	50L
Dimensions (W*D*H)	366 x 476 x 743 mm	366 x 476 x 928 mm
Rated voltage	220-240V~/50HZ	220-240V~/50HZ
Net Weight	27KG	31KG

Warranty

This product manufactured by Zhongshan Josoo Electric Appliance Co., Ltd

The warranty does not apply to damage resulting from abuse, accident, natural disaster, loss of electrical power to the product for any reason, alteration, outdoor use, improper installation, and improper operation, repair or service of the product by anyone other than an authorized by us, service agency or representative.