

# Free standing wine cooler

**Model: ZS-A58**

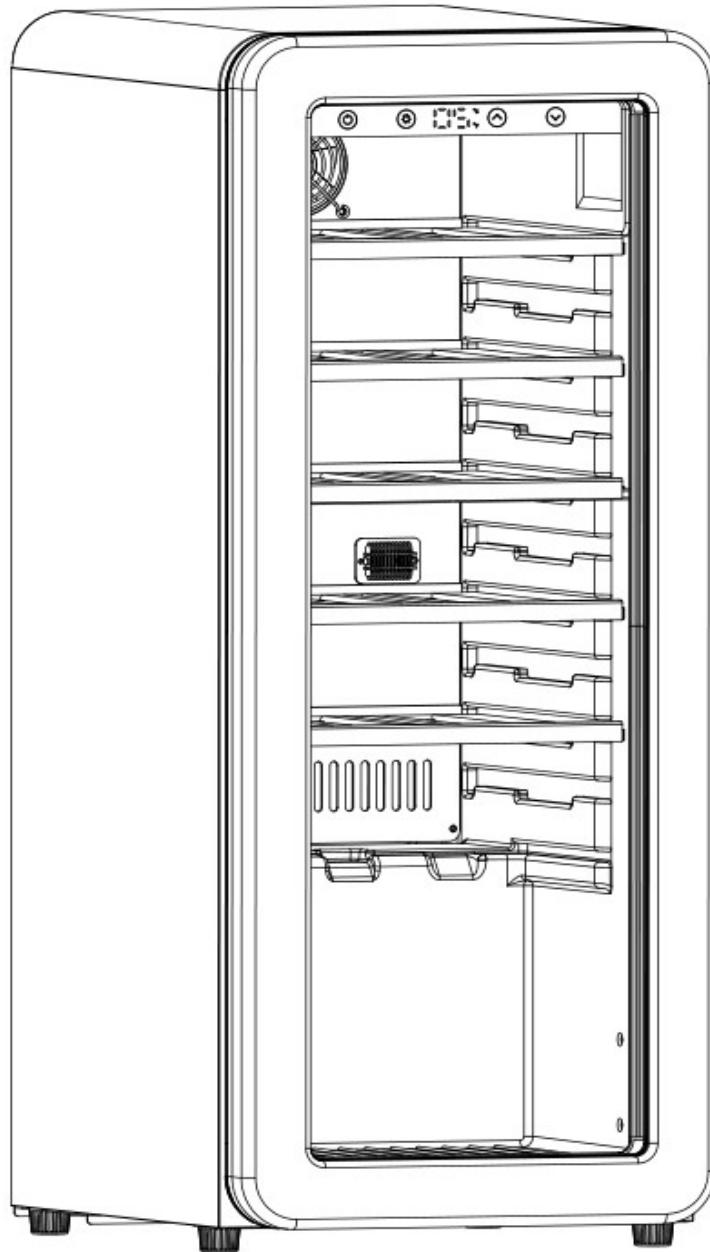

## ● Wine Cooler Package Contents

- 1pc Instruction Manual
- 5pcs Standard Shelves

## ● Important Safety Instructions

**WARNING:** To reduce the risk of fire, electric shock or personal injury, unplug or disconnect the appliance from the power supply before servicing.

- Read all instructions before using the wine cooler.
- **DANGER:** Risk of child becoming trapped in new wine cooler, old wine cooler/refrigeration unit, or large boxes. Junked or abandoned appliances, boxes and other containers are still dangerous, even if they will just in the garage for a few days.
- Never allow children to operate, play with, crawl inside the appliance.
- Never clean appliance parts with flammable fluids. The fumes can create a fire hazard or explosion.
- Do not store in the vicinity of any other appliance. Do not store near gasoline or any other flammable vapors. The fumes can create a fire hazard or explosion.

## ● Proper Disposal

An empty cooler is an extremely dangerous attraction to children. If you are getting rid of your old cooler, pls follow the instructions in the Child Entrapment Warning.

## ● Child Entrapment Warning

Risk of child entrapment. Before you throw away your old cooler or freezer:

1. Take of the doors.
2. Leave the shelves in place so that children may not easily climb inside.

## ● Before Using Your Wine Cooler

- Remove the exterior and interior packaging.
- Before connecting the wine cooler to power source, let it stand upright for approximately 2 hours. This will reduce the possibility of a malfunction in the cooling system from handling during transportation.
- Clean the interior surface with lukewarm water using a soft cloth.

## ● Product structure

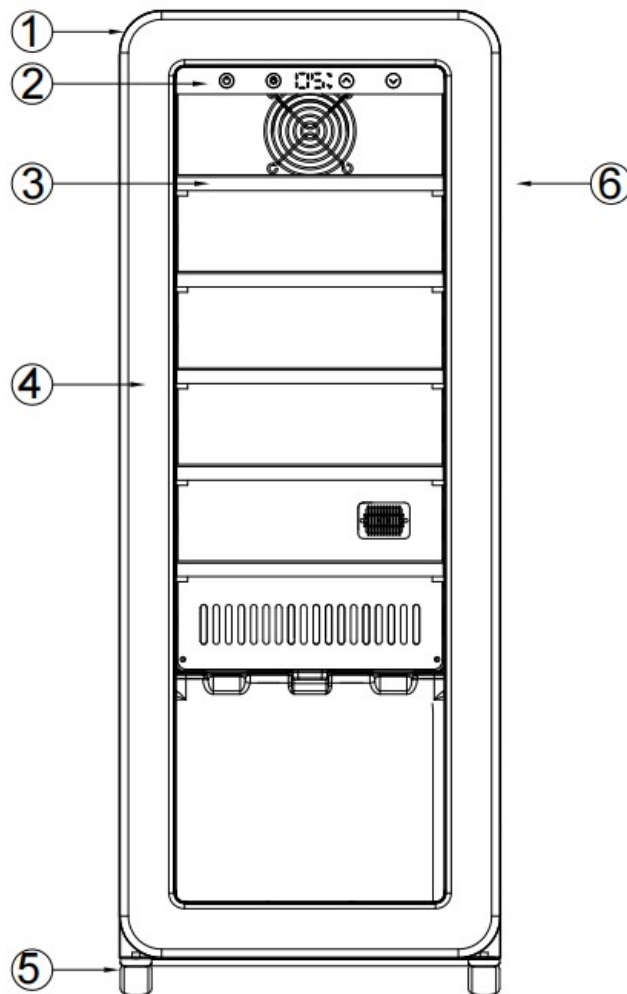

- ① Cabinet
- ② Control panel
- ③ Shelf
- ④ Glass door
- ⑤ Caster wheel.
- ⑥ Door hinge

## ● Operation For Temperature

Temperature Range: 5-20°C,

41-68°F

## ● Operation Panel







1.  Power on/off: As soon as the product is powered on, it will automatically enter the running state, and the display will light up. In the power-on state, press and hold this key for 3 seconds, then cut off the power and enter the standby state, and the display screen will turn off; in the standby state, press and hold this key for 3 seconds to turn on the power and turn on the power, and the display screen will light up again.

2.  LED light on/off: touch this key to control the on/off of the LED light;

3.  Temperature incremental setting key: touch this key to set the temperature incrementally

4.  Temperature decrement setting key: touch this key to set the temperature decrement

5. Celsius/Fahrenheit switching function: Press  and  at the same time for about 3 seconds to switch between the two temperature displays of Fahrenheit and Celsius;

5. Child lock function: Press  and  at the same time for 3 seconds to lock the buttons, and all buttons are locked after locking. After locking, press the power on/of button and led light on/of again for 3 seconds to unlock.

## ● Automatic Defrost

Wine coolers have been designed with an automated defrost function. The purpose of the defrosting function is to regularly remove the frost that remains on the surface of the evaporator of the refrigeration system (built-in, not visible when it is not disassembled), so as to ensure that the refrigeration system has been operating efficiently and in a good cooling state. When the machine runs for a period of time, the machine will automatically enter the defrosting state. At this time, the compressor of the wine cooler will stop running, and the cooling fan in the wine cabinet will continue to run to defrost. When defrosting, the temperature in the box will rise, which is not a fault. After defrosting, the cooling will be automatically resumed, and the box temperature will gradually drop to the set temperature.

## ● Points Of Intentions

1. Please prevent blocking cooling fan, or it will make the temperature too high or uneven in the cabinet.
2. Please close the door tightly, it will cause the refrigerating inefficiency, overflow in the cabinet, or unnormal temperature once the door is not closed tightly for a long time.
3. Please shut off the power, and open the door to let the cabinet dry enough if you don't use the wine cooler for a long time.
4. After the power is cut off, the self-protection function of the compressor needs to wait for 5 minutes before restarting the refrigeration; otherwise, the wine cooler cannot operate.
5. If you use the wine cabinet for the first time or use it again after a long shutdown, it may be that the temperature you set is inconsistent with the temperature displayed in the wine cabinet. After the wine cabinet has been running for a period of time, the temperature display will return to normal.
6. There is automatic storage memory when power off in this wine cooler, that means the setting temperature is memorized automatically even in power off, so the setting temperature is the same as last setting when the wine cooler is running again.
7. The product is not suitable for use at altitudes higher than 2000 meters, and the insulating glass is prone to burst due to pressure changes.
8. Caster wheel with stopper, pls turn it on while moving. Do not move when fully loaded.

## ●Product Parameters

1. Voltage: 220-240V~/ 50Hz
2. Lighting power:1W
3. Climate type: SN/N/ST
4. Net capacity:60L
5. Rated current: 0.7A
6. Foaming: cyclopentane
7. Refrigerant: R600a/18g
8. Product size ( WxDxH) : 366mm x476mm x 928mm

## ●Layout And Storage

Your cabinet was designed to store a maximum number of bottles securely. We recommend that you observe the below tips to optimize loading.

- Remove tape from shelves once unit is stable and ready for storage.
- Disperse the bottles evenly to avoid concentrating weight in one place. Bottles must not touch either the back of the cabinet.
- Make sure that the bottles are not all grouped together either at the top or bottom of the cabinet.
- Only pull out one shelf at a time. Never attempt to pull more than one.
- Maximum weight capacity per shelf is 55lbs
- You can crease your wine cooler storage capacity by removing shelves and stacking bottles on top of one another. Do not stack more than 3 rows of bottles per shelf.

## ●Care Maintenance

### **Cleaning your wine cooler**

- Turn off the power, unplug the appliance, and remove all items including shelves and rack.
- Wash the inside surfaces with a warm water and baking soda solution. The solution should be about 2 tablespoons of baking soda to a pint of water.
- Wash the shelves with a mild detergent solution.
- Wring excess water out of the sponge or cloth when cleaning any area of the controls.
- Wash the outside cabinet with warm water and mild liquid detergent. Rinse well and wipe dry with a clean soft cloth.

## ● Power Failure

- Most power failures are corrected within a few hours should not affect the temperature of your appliance if you minimize the number of times the door is opened. If the power is going to be off for a longer period of time, you need to take other measures to protect your contents.
- If the unit is unplugged, loses power, or is turned off you must wait 3 to 5 minutes before restarting. Attempting to restart the wine cooler before this time has elapsed may prevent the wine cooler from starting..

## ● Vacation Time

- Short holidays: You may leave the Wine Cooler powered on and unattended for absences of less than three weeks.
- Long absences: If the appliance will not be used for several months, remove all items, turn off the appliance and unplug. Clean and dry the interior thoroughly. To prevent odour and mold growth, leave the door open slightly : blocking it open if necessary.

## ● Moving Your Wine Cooler

- Remove all items.
- Securely tape down all loose items ( shelves) inside your appliance.
- Turn the adjustable leg up to the base to avoid damage.
- Tape the door shut.
- Be sure the appliance stays secure in the upright position during transportation. Also protect outside of appliance with a blanket, or similar item.

## ● Energy Saving Tips

- The Wine Cooler should be located in the coolest area of the room, away from heat producing appliances, and out of the direct sunlight.
- Ensure that the unit is adequately ventilated. Never cover air vents.
- Only open the door for as long as necessary.

# ● Troubleshooting Guide

## Problems with Your Wine Cooler

Many common issues with your wine cooler can be solved very easily. Try the troubleshooting tips below should you experience any problems.

PROBLEM	POSSIBLE CAUSE
Wine Cooler does not operate.	Not plugged in. The appliance is turned off. The circuit breaker tripped or a blown fuse.
Wine Cooler is not cold enough.	Check the temperature control setting. External environment may require a higher setting. The door is opened too often. The door is not closed completely. The door gasket does not seal properly
Turns on and off frequently	The room temperature is hotter than normal. A large amount of contents has been added to the Wine Cooler. The door is open too often The door is not closed completely. The temperature control is not set correctly. The door gasket does not seal properly.
The light does not work.	Not plugged in. The circuit breaker tripped or a blown fuse. The light switch is "OFF".
Vibrations	Check to assure that the Wine Cooler is level.
The door will not close properly.	The Wine Cooler is not level. The door was reversed and not properly installed. The gasket is dirty. The shelves are out of position.
The Wine Cooler seems to make too much noise	The rattling noise may come from the flow of the refrigerant, which is normal. As each cycle ends, you may hear gurgling sounds caused by the flow of refrigerant in your Wine Cooler. Contraction and expansion of the inside walls may cause popping and crackling noises. The Wine Cooler is not level.



## ●Sensor Trouble shooting

<b>Fault situation</b>	<b>Reason</b>	<b>Solution</b>
Fault code E1	Upper room/lower room temperature sensing head short circuit display	Please contact customer service before returning to our service center for inspection/repair.
Fault code E0	Upper room/lower room temperature sensing head open circuit display	Please contact customer service before returning to our service center for inspection/repair
Fault code E5	Communication failure display	Please contact customer service before returning to our service center for inspection/repair

## ●Warranty

This product has been manufactured by Zhongshan Josoo Electric Appliance Co.,Ltd.

The warranty does not apply to damage resulting from abuse, accident, natural disaster, loss of electrical power to the product for any reason, alteration, outdoor use, improper installation, and improper operation, repair or service of the product by anyone other than an authorized by us, service agency or representative.