

EAST E210

GROW ROOM DEHUMIDIFIER

INSTRUCTION MANUAL



READ CAREFULLY AND SAVE THIS MANUAL IN SAFETY!

WARNING! Before using, read this instruction manual of this dehumidifier to ensure correct usage through understanding. After reading, store them in a safe place for future reference. Incorrect handling of this product could possibly result in personal injury or physical damage.



Exclusively grow room designed dehumidifiers

- All metal plate framed structure shell.
- Separated electrical box for easily maintaining.
- Low voltage control.
- Opposite air inlet and outlet to reduce efficiency interference.
- Duct kits as optional accessories can be easily connected.
- Long-life brushless direct drive fan.Noise 50% lower.
- Memory function of operating mode after power outages.
- High efficiency rotary compressor.

SAFTY INSTRUCTIONS

WARNING

- 208-230 volts may cause serious injury from electric shock. Disconnect electrical power before starting installation or servicing. Leave power disconnected until installation/service is completed.
- Don't roll or damage the power cord when install or move the machine
- Don't put finger or any other rod like object into the machine

CAUTION

- Do not tilt the machine more than 45 ° in moving or installation to avoid damage to the compressor.
- Working temperature scope of the machine is 5 °C ~ 38 °C.
- The room temperature will go up around 3°C from compressor heat dissipation when dehumidifier running, it's normal phenomenon, please feel free to use.
- It's not necessary to use dehumidifier when the room temperature is below 10°C, the absolute humidity is quite low at this condition.
- Please try to seal environment better to increase the effect of dehumidifier.
- Do not place the machine in the area which may come into contact with water or chemical.
- Do not use any relay, extension line or adapter to connect the power of machine.
- Do not place the machine next to the stove, heater and other equipment will dissipate heat, and area with direct sunlight or wind and rain.
- Do place the plug stably and clean the dust on power line.
- Do not damage or modify the power line, do not repair by yourself and disassemble or modify the machine.
- Do place the drainage tube smoothly for continuously drain.
- Shutdown the equipment and cut power when in malfunction.

SPECIFICATIONS

WORKING CONDITIONS

Operating Temperature Range	41° F - 100° F
Operating Humidity Range	RH40% - RH95%

PARAMETERS

Net Weight	134 lbs (without packaging)
Drain Size	5/8"
Capacity	210 Pints @ 80° F, 60% RH
Airflow @ 0.0"	562 CFM (free flow)

ELECTRICS

Voltage	208~230 VAC ~, 1ø, 50/60 HZ
Operating Current	5.5 A @ 80°F , 60% RH
Efficiency (@ 80°F , 60% RH)	4.1 L/kW-hr (7.3 pints/kW-hr)

DIMENSIONS

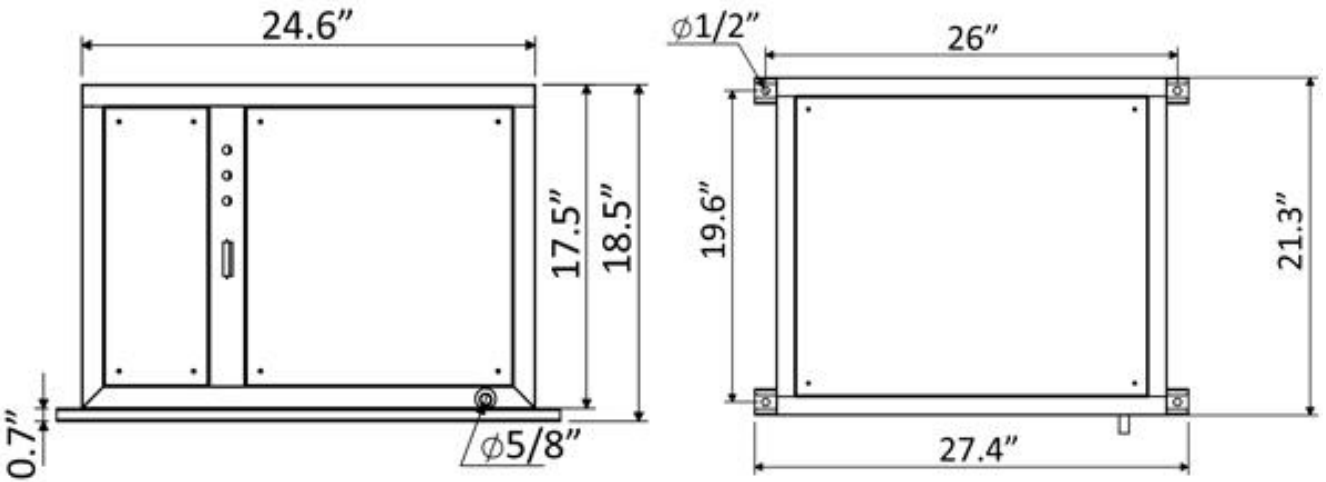

Net Dimensions: L27.4" * W21.3" * H18.5"
 Packed Dimensions: L30" * W24.5" * H24.5"
 Net Weight: 134 Lbs
 Gross Weight: 149 Lbs

OPERATION GUIDE

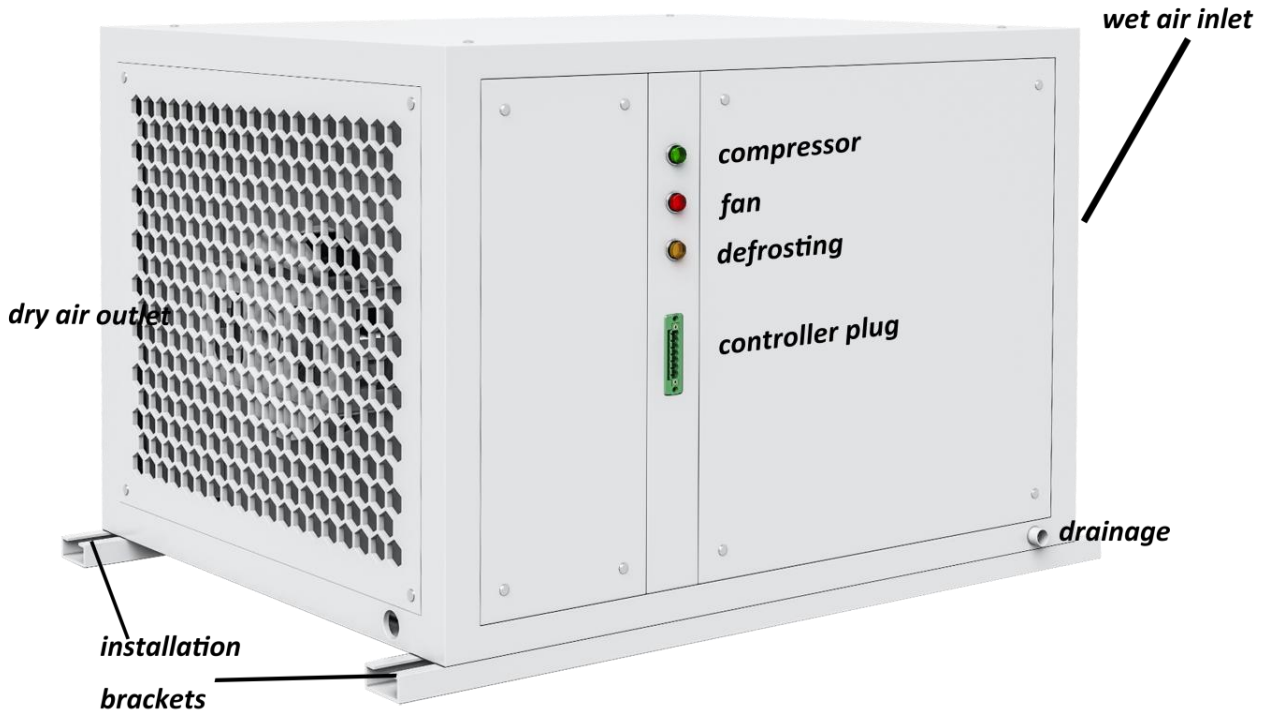

Indicator Lights

There are 3 LED lights stands for different operating mode.



The green light stands for compressor operating mode.



The red light stands for fan operating mode.



The yellow light stands for defrosting mode

DHD100 CONTROLLER

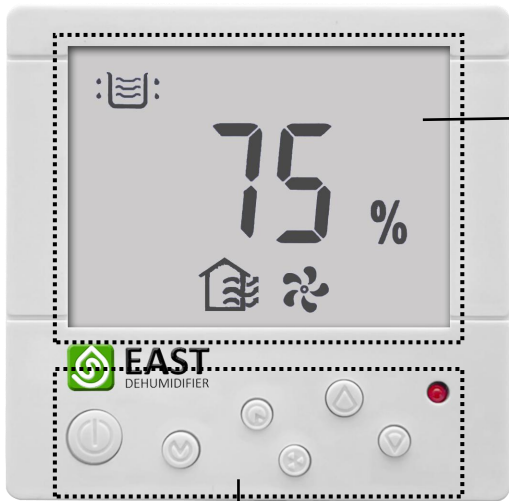

Dehumidifying Icon

- Light on when the unit is dehumidifying
- Blinking when the unit is compressor protecting



Ventilation Icon

- Light on when the unit is in ventilation mode



Fan Icon

- Light on when the fan is working



Humidity Icon

- Light on showing the humidity of room
- Blinking when setting the target humidity



Power: press once to start the unit, press again to stop the unit



Mode: press to switch dehumidifying & ventilation mode



Value up: press once in setting mode to add 1% of target humidity



Value down: press once in setting mode to minus 1% of target humidity



Setting: press once to set the target humidity



Fan speed: not available on constant speed fan unit



Power light: light on when the unit is working

WIRING SCHEME

Connecting the DHD100 digital controller to the plug using a 4-core cable as the wiring scheme

Each unit comes equipped with a pre-assembled cable connecting the digital control to the plug. Simply insert the plug into the dehumidifier to operate the device.

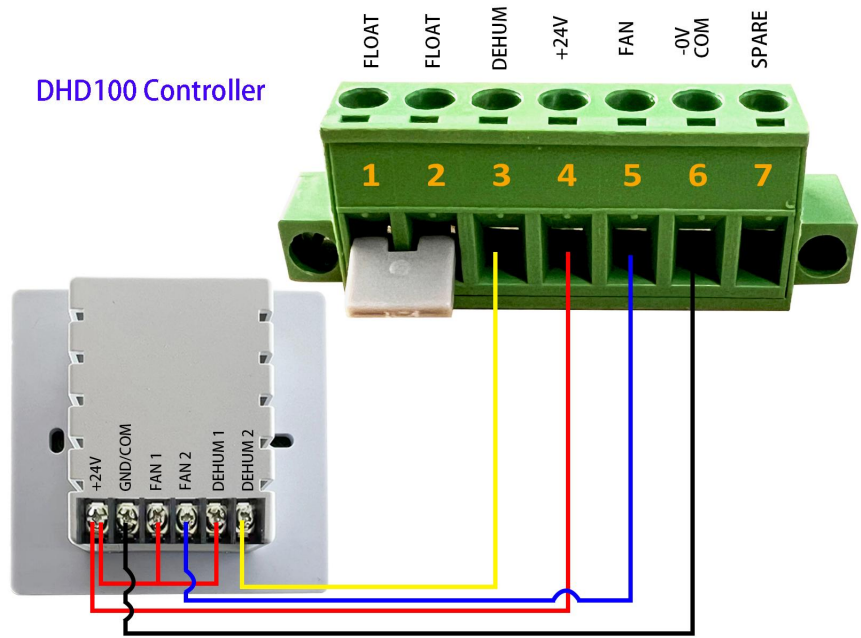

Third Party Controller
Trolmaster

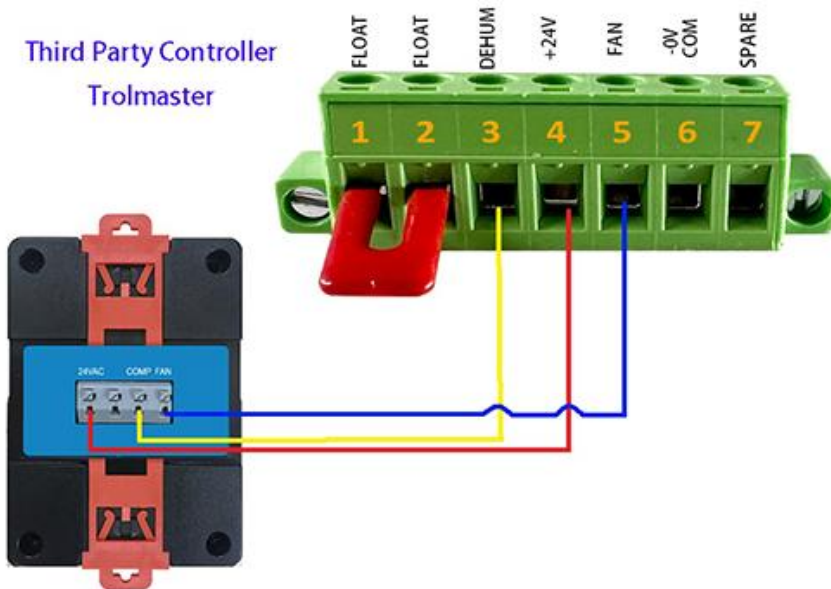

Connecting the 3rd-party controller to the plug using a 3-core cable as the wiring scheme.

Each unit comes equipped with a pre-assembled cable connecting the 3rd-party controller to the plug. Simply insert the plug into the dehumidifier to operate the device.

INSTALLATION GUIDE

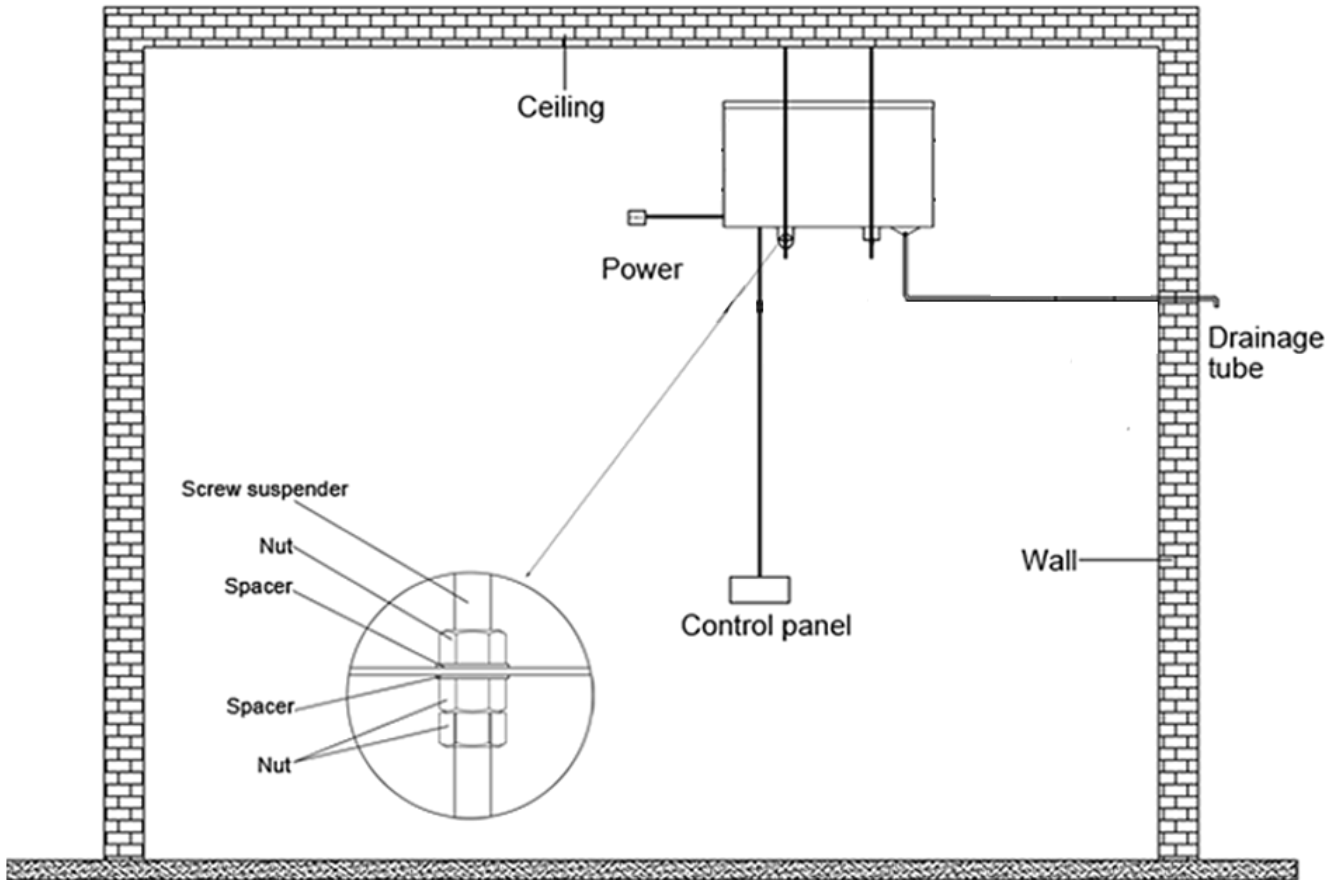

Standard Installation

- Cut off all the electrical to ensure the safety
- Make sure the power and drain tunnel
- Prepare necessary tools like screwdriver, thread rod, spanner etc.
- Drill four fixing holes on the ceiling according to the position of install hole on the machine, then install the expansion screw to fix the thread rod.
- Install the machine through the four thread rods, and adjust the height according the space to ensure the machine on horizontal level.
- Connect the drain tube to make sure no leakage, no block for the drainage.
- Connect the power, please make sure the power supply is 208~240v/60hz and have overload protection.

Top View

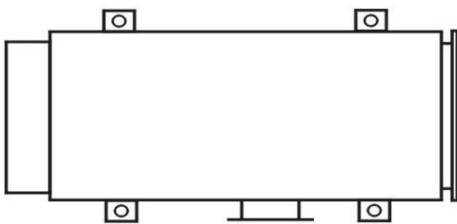

Side View

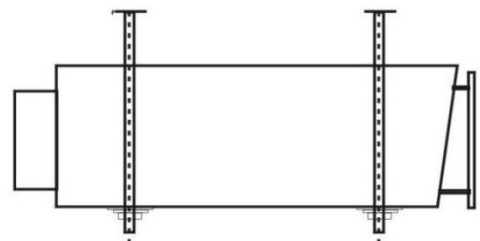

Automatic Defrosting

The dehumidifier will defrost automatically when freezing occurs. While defrosting, the compressor will not work but the brushless fan will continue to run in order to melt the ice on coil inside. Defrosting light will be on. Dehumidifier will start automatically once defrost process is complete. Default defrost setting may occurs when ambient temperature is under 15°C.

Delay Start

Manual restart of system within 3 minutes of shutdown, the compressor will start up within 3 minutes of delay protection.

Low Pressure

When the low pressure sensor detect the pressure of refrigerant is under standard level, the unit will aotumatically shut down.

Overheat

When the unit temperature is over the standard level, the unit will aotumatically shut down.

NORMA MALFUNCTION REMOVAL

MALFUNCTIONS	ANALYZE	REMOVAL
DEHUMIDIFIER IS NOT WORKING	<ul style="list-style-type: none"> • POWER FAILURE • POWER OFF • POWER IS NOT PLUG IN • BLOWN FUSE 	<ul style="list-style-type: none"> • RESUME POWER • POWER ON • PLUG IN • REPLACE FUSE
BAD DEHUMIDIFICATION EFFECT	<ul style="list-style-type: none"> • FILTER BLOCKED WITH DUST • AIR INLET IS BLOCKED • USED IN BAD SEALED ROOM • LESS REFRIGERANT 	<ul style="list-style-type: none"> • WASH FILTER • REMOVE BLOCK • CLOSE DOOR AND WINDOW • FILL REFRIGERANT OR CONTACT WITH MANUFACTURER
LEAKAGE	<ul style="list-style-type: none"> • MACHINE IS NOT HORIZONTAL • DRAIN TUBE IS BLOCKED 	<ul style="list-style-type: none"> • PLACE THE MACHINE HORIZONTAL • WASH OR CHANGE THE TUBE
NOISE	<ul style="list-style-type: none"> • MACHINE IS NOT INSTALLED STABLE • FILTER BLOCKED 	<ul style="list-style-type: none"> • PLACE THE MACHINE STABLE • WASH THE FILTER

REMARKS







- Please contact manufacturer or agent to maintain the malfunction that cannot be confirmed and removed, don't disassemble the machine by yourself
- It will produce noise when the dehumidifier power on or power off, it's normal.
- It will produce heat wind at the air outlet, it's normal

UNPACKING THE DEHUMIDIFIER

Unpack the outer ply-wooden case, and remove the protection film to take out the dehumidifier for installation.



WHAT'S IN THE CASE

Components		QTY
	E210 Dehumidifier	1 pc
	DHD100 Controller	1 pc
	Flexible Drianage Pipe	1 pc
	Filter	1 pc
	Power Cord	1 pc
	3rd-party Controller Kits	1 pc
	Instruction Manual	1 pc