

GCZ56-30014KD 56-300mm f/1.0-1.4 Continuous Zoom Infrared Lens

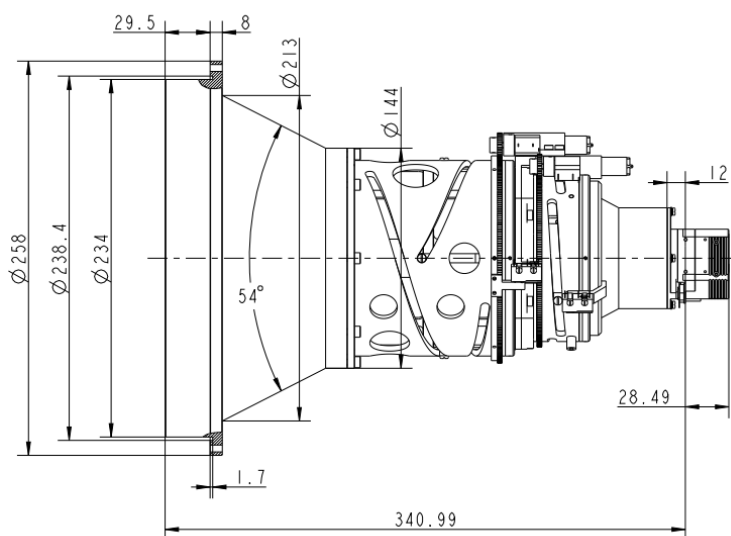

HFOV	160x120	320x240	336x256	384x288	640x480	640x512	1024x768	1280x1024
12μm	0.4°-2°	0.7°-3.9°	0.8°-4.1°	0.9°-4.7°	1.5°-7.8°	1.5°-7.8°	2.3°-12.5°	
17μm	0.5°-2.8°	1°-5.6°	1.1°-5.8°	1.2°-6.7°	2.1°-11.1°	2.1°-11.1°		

Optical

Focal Length(mm)	56-300
F/#	1.0-1.4
Wavelength	8-12μm

Mechanical

Interface	Flange
Focus Mechanism	Motorized
Dimensions (mm)	Ø234 x 340.99 (to UFPA)(Front flange Ø258)
Weight	<6.1kg

Electrical & Communications

Power Input	DC12V
Communications	Optional

Environmental

Operating Temperature	-40°C to +60°C
Storage Temperature	-45°C to 65°C
Front Element Sealing	IP67
External Coating	DLC