

Trek 50ml

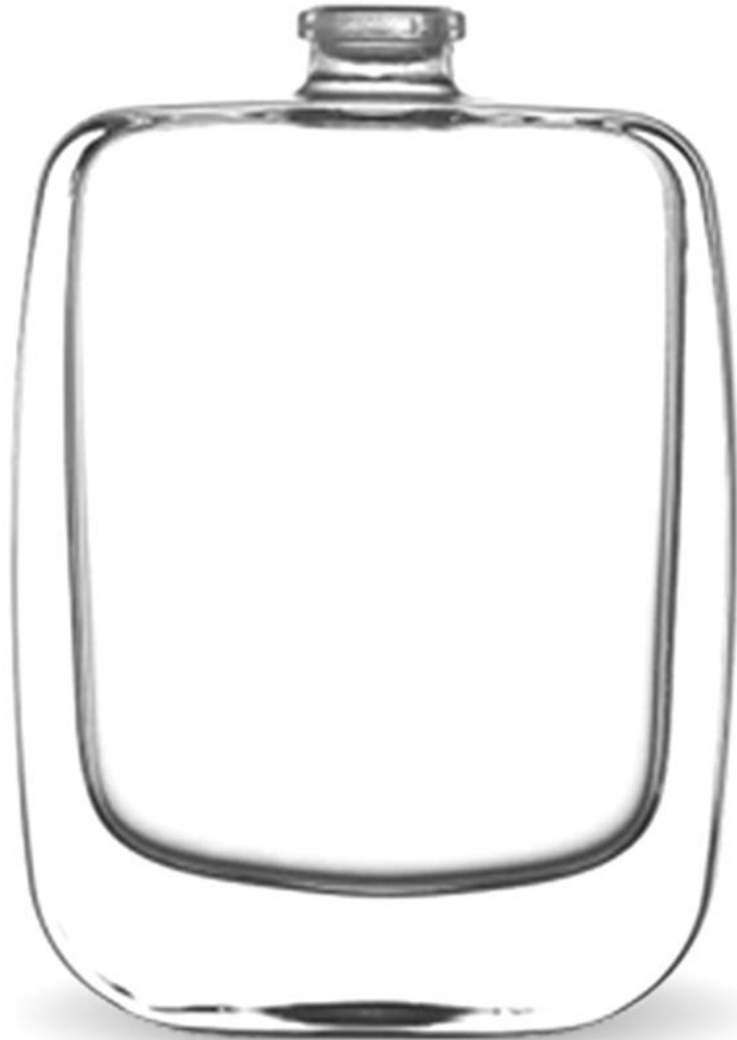

Brimful Capacity **58 ± 2 ml**

Net Weight **149 ± 5 g**

Dimensions **L64.71 x W26.05 x H90.8 mm**

Neck Finish **FEA15**

Trek 50ml

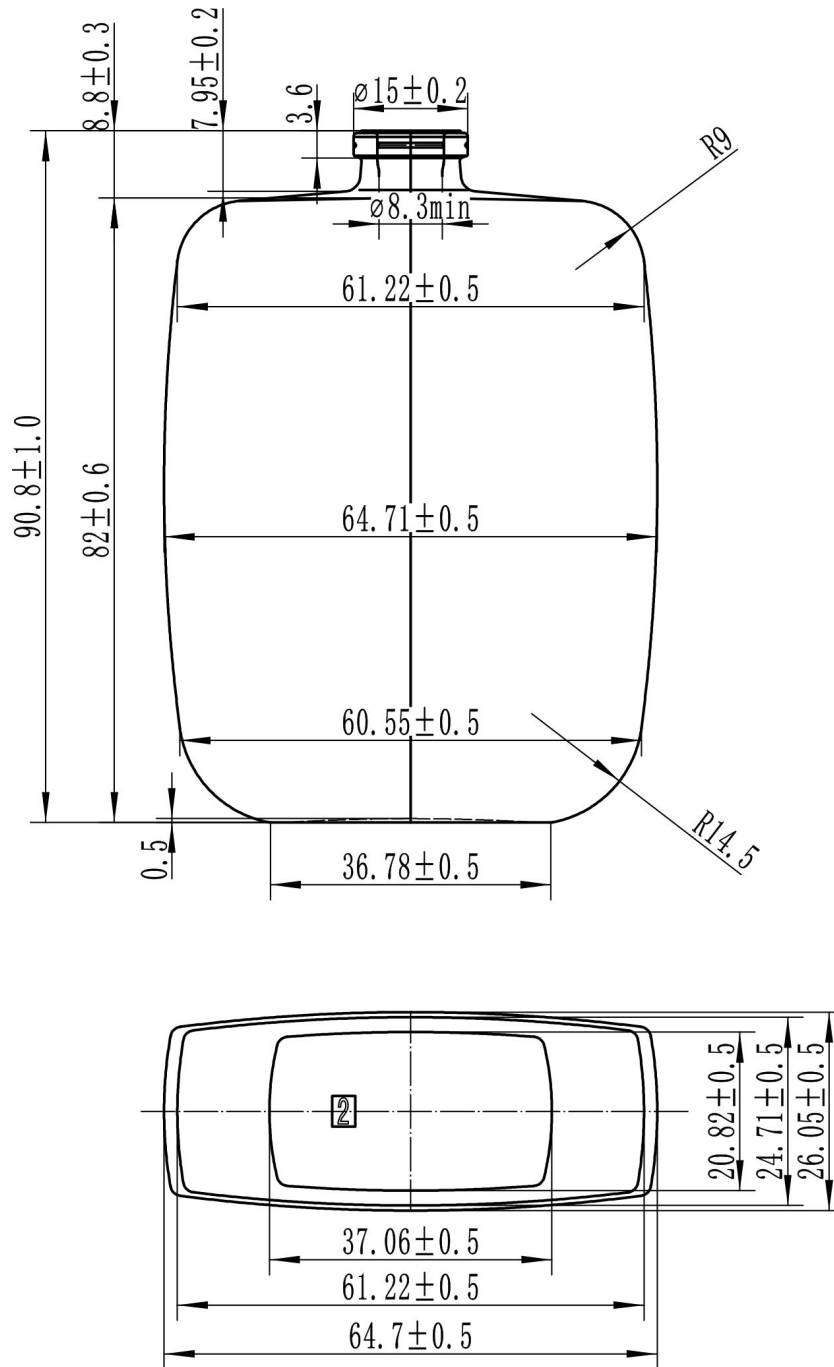

With integrated service of design, customization, wholesale, contract manufacturing, decoration, GP Bottles is providing bespoke perfume bottle packaging solutions for niche perfume brand.