

J-SERIES



RoHS
Compliant

IP66



5 YEAR
WARRANTY

LED PROJECTOR LIGHTS





Overview

The KULON® J-Series LED projector lights are using LUMILEDS® LUXEON TX luminous source, providing excellent lumen output, long-lasting stability and splendid sight.

The KULON® J-Series LED projector lights are using high-end LED driver with long lifespan. Provide 5 years warranty on luminaire.

Color Options

➤ Black

LED LUMINOUS SOURCE



LUXEON
NEVER BEFORE POSSIBLE
Greater than 135 lm/W high efficacy, illumination grade LED light source.



LED DRIVER

INVENTRONICS EUC Series LED driver, integrate 0-10V dimming function and 4KV /6KV surge protection. Provide excellent performance and lifespan.



OPTIMAL HEAT RADIATION

Excellent thermal management system and heat radiation enable the LEDs consistently work cooler, providing significant boosts to lifetime and efficacy.

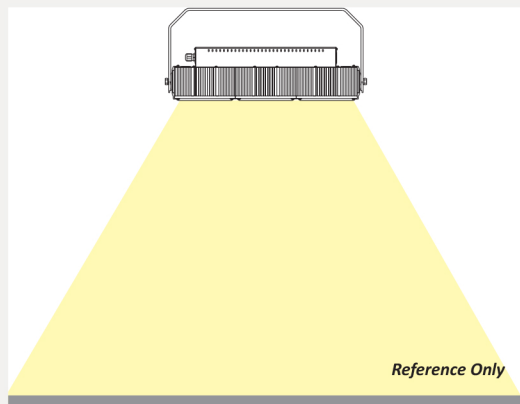

Beam Angle: 45°

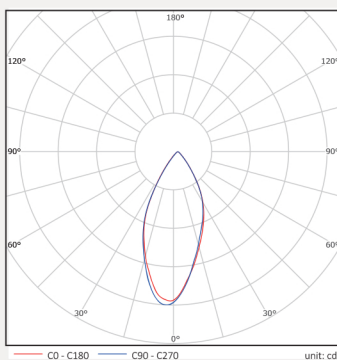

Beam Angle: 60°

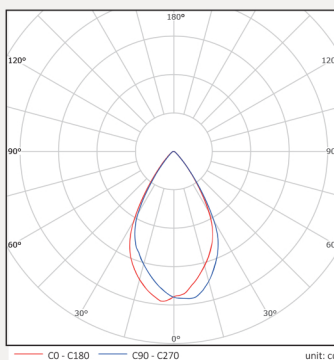

Application:
1. Court, Training Ground
2. School, Community
3. Square, Stadium
4. Area Lighting



Detailed Features



Unique embossing lens and reflector design, better performance for industrial lighting.



360° adjustable bracket, can be adjusted to any projection angle.



Utilize M12 waterproof connector to ensure the safety of internal luminous source.

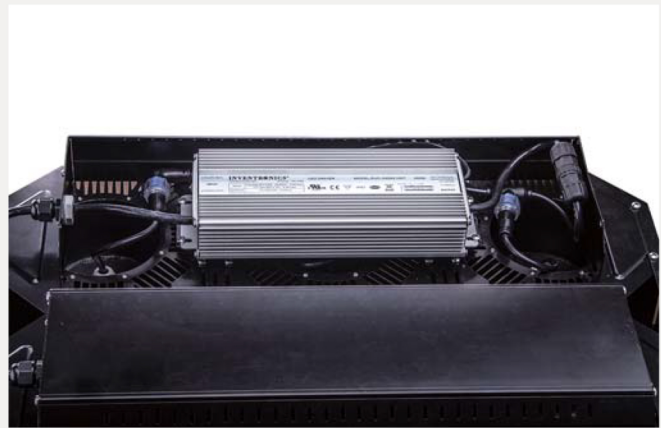

Neat inner cavity structure, ensure the thermal convection of LED driver.



Use waterproof connector to fix the input cables, ensure product safety.



Entirely made in aluminium, not only exquisite appearance, but also no corrosion concerns.

DETAILED FEATURES





Product	K-FL280WJ	K-FL560WJ	K-FL840WJ												
Nominal Wattage	280W	560W	840W												
LED Working Current	700 mA	700 mA	700 mA												
Input Voltage	100-240V /277V AC, 50/60Hz	100-240V /277V AC, 50/60Hz	100-240V /277V AC, 50/60Hz												
Dimming	0(1)-10V	0(1)-10V	0(1)-10V												
Max. Current @ 208V	2.88 A	5.76 A	8.64 A												
Max. Current @ 240V	1.44 A	2.88 A	4.32 A												
Max. Current @ 277V	1.25 A	2.5 A	3.75 A												
Operating Temperature	-40 °C to +50 °C	-40 °C to +50 °C	-40 °C to +50 °C												
Power Factor (PF)	> 0.95	> 0.95	> 0.95												
Total Harmonic Distortion (THD)	< 20%	< 20%	< 20%												
Lumen Output (+/- 5%)	31360 lm	62720 lm	94080 lm												
Beam Angle	45°, 60°	45°, 60°	45°, 60°												
CRI	Minimum 70 CRI	Minimum 70 CRI	Minimum 70 CRI												
CCT	<table border="1"> <tr> <td>3000K</td> <td>4000K</td> </tr> <tr> <td>5000K</td> <td>5700K</td> </tr> </table>	3000K	4000K	5000K	5700K	<table border="1"> <tr> <td>3000K</td> <td>4000K</td> </tr> <tr> <td>5000K</td> <td>5700K</td> </tr> </table>	3000K	4000K	5000K	5700K	<table border="1"> <tr> <td>3000K</td> <td>4000K</td> </tr> <tr> <td>5000K</td> <td>5700K</td> </tr> </table>	3000K	4000K	5000K	5700K
3000K	4000K														
5000K	5700K														
3000K	4000K														
5000K	5700K														
3000K	4000K														
5000K	5700K														
Rating	IP66	IP66	IP66												
Heat Radiator	Stretched Aluminium Alloy	Stretched Aluminium Alloy	Stretched Aluminium Alloy												
Lens	PC	PC	PC												
Packaging Type	1 unit /ctn.	1 unit /ctn.	1 unit /ctn.												

PRODUCT DATA

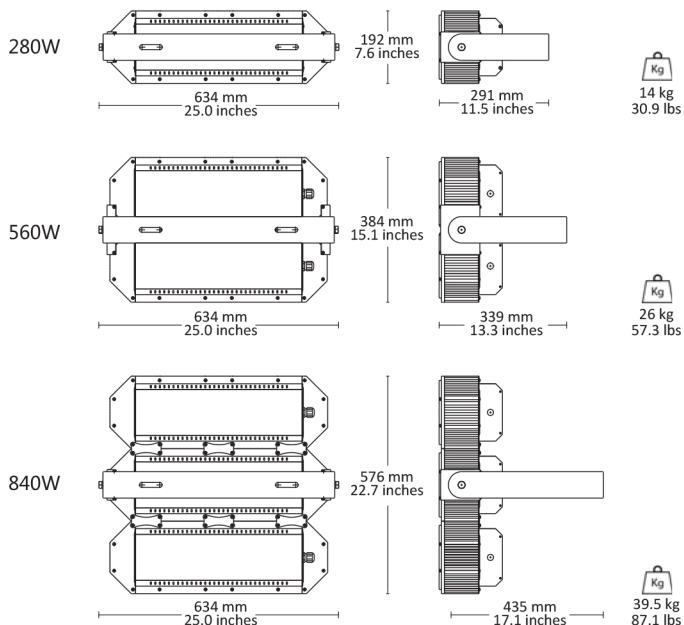

PACKAGING DATA

Nominal Wattage	280W	560W	840W
"L" Length	380 mm (15.0")	520 mm (20.5")	710 mm (28.0")
Weight	15.5 kg (34.2 lbs.)	28.5 kg (62.8 lbs.)	43 kg (94.8 lbs.)

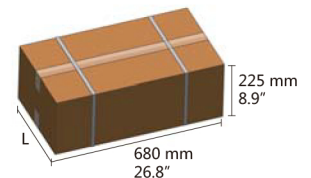

LUMEN MAINTENANCE

Ambient Temperature	TM-21 Lumen Maintenance (60,000 Hours)	Theoretical L70 (Hours)
25 °C	94.01%	244,000



Dimming

† 0(1)-10V Dimming

The recommended implementation of the dimming control is provided below.

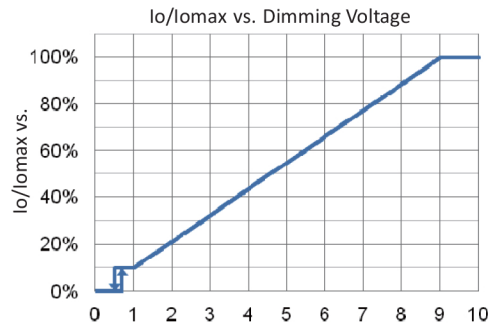
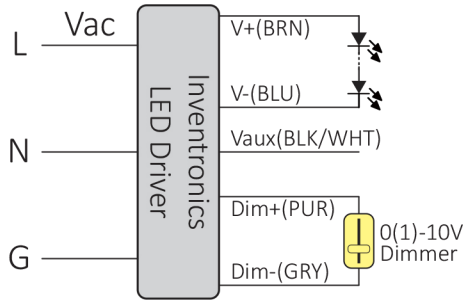

- Notes:**
1. The dimmer can also be replaced by an active 0-10V voltage source signal or passive components like resistors and zener.
 2. Do NOT connect Dim- to the output V- or V+, otherwise the driver will not work properly.
 3. If dimming is not used, Dim + should be open or connect to Vaux.

AFTER-SALE SERVICE

Hangzhou KULON Technology Co., Ltd (“KULON”) warrants this KULON-branded hardware product against defects in materials and workmanship under normal use for a period of FIVE (5) YEAR from the date of purchase. KULON provides free repair or replacement within warranty period. KULON shall charge against defeats by abnormal storage, usage, connection or change the structure or any components of the product.

*Damage by thunder stroke over 10KV(L,N to FG) /6KV(L to N) will not covered by warranty based on IEC61000-4-5.

The product (LED lighting equipment, electrical , electronic equipment) should not be placed in municipal waste. Check local regulations for disposal of electronic products.

- Features and specifications are subject to change without notice.
- The product color may be different with actual due to discrepancy of camera or screen settings.
- kulon (**KULON**) is a trademark of kulon Tech. All other trademarks are trademarks of their respective owners.

