Panel PC 800 with NM10 CPU Board

User's Manual

Version: **1.21 (March 2015)**
Model no.: **MAPPC800B-ENG**

All information contained in this manual is current as of its creation/publication. B&R reserves the right to change the contents of this manual without notice. The information contained herein is believed to be accurate as of the date of publication; however, Bernecker + Rainer Industrie-Elektronik Ges.m.b.H. makes no warranty, expressed or implied, with regard to the products or documentation contained within this manual. In addition, Bernecker + Rainer Industrie-Elektronik Ges.m.b.H. shall not be liable for any incidental or consequential damages in connection with or arising from the furnishing, performance or use of the product(s) in this documentation. Software names, hardware names and trademarks are registered by their respective companies.

Chapter 1: General information

Chapter 2: Technical data

Chapter 3: Installation

Chapter 4: Software

Chapter 5: Standards and certifications

Chapter 6: Accessories

Chapter 7: Maintenance and service

Appendix A

Chapter 1 General information.....	12
1 Manual history.....	12
2 Safety guidelines.....	13
2.1 Intended use.....	13
2.2 Protection against electrostatic discharge.....	13
2.2.1 Packaging.....	13
2.2.2 Guidelines for proper ESD handling.....	13
2.3 Policies and procedures.....	13
2.4 Transport and storage.....	14
2.5 Installation.....	14
2.6 Operation.....	14
2.6.1 Protection against touching electrical parts.....	14
2.6.2 Environmental conditions - Dust, moisture, corrosive gases.....	14
2.6.3 Viruses and dangerous programs.....	14
2.7 Environmentally friendly disposal.....	15
2.7.1 Separation of materials.....	15
3 Organization of safety notices.....	15
4 Guidelines.....	15
5 Overview.....	16
Chapter 2 Technical data.....	19
1 Introduction.....	19
1.1 Features.....	20
1.2 System components / configuration.....	21
1.2.1 Configuration - Base system.....	21
1.2.2 Accessory and software configuration.....	22
2 Complete system.....	23
2.1 Temperature specifications.....	23
2.1.1 Maximum ambient temperatures.....	24
2.1.2 Minimum ambient temperatures.....	25
2.1.3 Temperature monitoring.....	25
2.1.4 Temperature sensor locations.....	25
2.2 Humidity specifications.....	26
2.3 Power management.....	27
2.3.1 Supply voltage block diagram.....	27
2.3.2 Power calculation with 5PC820.1505-00.....	28
2.3.3 Power calculation with 5PC820.1906-00.....	29
2.4 Block diagrams.....	30
2.4.1 Bus unit 5AC803.BX01-00.....	30
2.4.2 Bus unit 5AC803.BX01-01.....	31
2.4.3 Bus unit 5AC803.BX02-00.....	32
2.4.4 Bus unit 5AC803.BX02-01.....	33
2.5 Serial number sticker.....	34
2.6 Device interfaces and slots.....	35
2.6.1 +24 VDC power supply.....	35
2.6.2 Monitor/Panel interface - RGB.....	36
2.6.3 COM1 serial interface.....	37
2.6.4 Ethernet 1 (ETH1).....	38
2.6.5	38
2.6.6	38
2.6.7 CompactFlash slot 1.....	40
2.6.8 CompactFlash slot 2.....	40
2.6.9 MIC, Line IN, Line OUT.....	41
2.6.10 Add-on UPS slot.....	41
2.6.11 Power button.....	42
2.6.12 Reset button.....	42
2.6.13 LED status indicators.....	43

2.6.14 CMOS profile switch.....	43
2.6.15 Battery.....	44
2.6.16 Slide-in compact slot.....	45
2.6.17 PCIec slot (Card slot).....	45
3 Individual components.....	46
3.1 System units.....	46
3.1.1 5PC820.1505-00.....	46
3.1.2 5PC820.1906-00.....	52
3.2 NM10 CPU boards.....	58
3.2.1 General information.....	58
3.2.2 Order data.....	58
3.2.3 Technical data.....	58
3.3 Heat sink.....	60
3.3.1 5AC803.HS00-04.....	60
3.4 Main memory.....	61
3.4.1 5MMDDR.xxxx-02.....	61
3.5 Expansions.....	62
3.5.1 General information.....	62
3.5.2 Order data.....	62
3.5.3 Inserts.....	62
3.5.4 Technical data.....	62
3.5.5 5AC803.SX01-00 - Dimensions.....	63
3.5.6 5AC803.SX02-00 - Dimensions.....	64
3.5.7 Slot for bus units.....	64
3.5.8 Slide-in slot 1.....	66
3.6 Bus units.....	67
3.6.1 General information.....	67
3.6.2 Order data.....	67
3.6.3 Technical data.....	67
3.7 Adapters.....	69
3.7.1 5AC803.BC01-00.....	69
3.7.2 5AC803.BC02-00.....	69
3.8 PCIec plug-in cards.....	70
3.8.1 General information.....	70
3.8.2 Dimensions.....	70
3.8.3 5ACPCC.ETH0-00.....	71
3.8.4 5ACPCC.MPL0-00.....	73
3.9 Drives.....	77
3.9.1 5AC801.HDDI-00.....	77
3.9.2 5AC801.HDDI-03.....	79
3.9.3 5AC801.HDDI-04.....	81
3.9.4 5AC801.SSDI-00.....	83
3.9.5 5AC801.SSDI-01.....	87
3.9.6 5AC801.SSDI-02.....	89
3.9.7 5AC801.SSDI-03.....	91
3.9.8 5AC801.SSDI-04.....	94
3.9.9 5AC801.SSDI-05.....	97
3.9.10 5MMSSD.0060-00.....	99
3.9.11 5MMSSD.0060-01.....	101
3.9.12 5MMSSD.0128-01.....	104
3.9.13 5MMSSD.0180-00.....	107
3.9.14 5MMSSD.0256-00.....	109
3.9.15 5AC801.ADAS-00.....	111
3.9.16 5AC801.HDDS-00.....	112
3.9.17 5AC801.DVDS-00.....	114
3.9.18 5AC801.DVRS-00.....	116
3.9.19 5ACPCI.RAIC-05.....	119

3.9.20 5ACPCI.RAIC-06.....	122
3.9.21 5MMHDD.0250-00.....	125
3.9.22 5MMHDD.0500-00.....	127
3.10 Fan kit.....	129
3.10.1 5AC803.FA01-00.....	129
3.10.2 5AC803.FA02-00.....	130
3.10.3 5AC803.FA03-00.....	132
Chapter 3 Installation.....	134
1 Installation.....	134
1.1 Important installation information.....	134
1.2 Installation with clamping blocks.....	134
1.3 Mounting orientation.....	136
1.3.1 Mounting orientation 0° and +/- 45°.....	136
1.3.2 Mounting orientation with 5AC801.DVRS-00.....	137
1.3.3 Mounting orientation with 5AC801.DVDS-00.....	138
1.4 Spacing for air circulation.....	139
2 Cable connections.....	140
3 Grounding concept.....	141
4 General instructions for performing temperature testing.....	142
4.1 Procedure.....	142
4.2 Evaluating temperatures in Windows operating systems.....	142
4.2.1 Evaluating with the B&R Control Center.....	142
4.2.2 Evaluating with the BurnInTest tool from Passmark.....	143
4.3 Evaluating temperatures in operating systems other than Windows.....	145
4.4 Evaluating the measurement results.....	145
5 Connection examples.....	146
5.1 One office TFT via RGB onboard.....	146
6 Touch screen calibration.....	147
6.1 Windows XP Professional.....	147
6.2 Windows XP Embedded.....	147
6.3 Windows Embedded Standard 2009.....	147
6.4 Windows 7 Professional / Ultimate.....	147
6.5 Windows Embedded Standard 7 Embedded / Premium.....	147
6.6 Windows CE.....	147
6.7 Automation Runtime / Visual Components.....	147
7 Connecting USB peripheral devices.....	148
7.1 Locally on the PPC800.....	148
8 Configuring a SATA RAID set.....	149
8.1 Create RAID set.....	150
8.2 Create RAID set - Striped.....	150
8.3 Create RAID set - Mirrored.....	151
8.4 Delete RAID set.....	151
8.5 Rebuild mirrored set.....	152
8.6 Resolve conflicts.....	152
8.7 Low level format.....	153
9 Tips for extending the service life of the display.....	154
9.1 Backlight.....	154
9.1.1 How can the service life of the backlight be extended?.....	154
9.2 Screen burn-in.....	154
9.2.1 What causes screen burn-in?.....	154
9.2.2 How can screen burn-in be avoided?.....	154
10 Pixel errors.....	154
11 Known problems/issues.....	155
Chapter 4 Software.....	156
1 BIOS options.....	156

1.1 General information.....	156
1.2 BIOS setup and boot procedure.....	156
1.2.1 BIOS Setup keys.....	157
1.3 Main.....	158
1.4 Advanced.....	159
1.4.1 Graphics configuration.....	160
1.4.2 Baseboard/Panel features.....	161
1.4.3 Hardware monitoring.....	165
1.4.4 PCI configuration.....	166
1.4.5 PCI Express configuration.....	168
1.4.6 RTC wake settings.....	174
1.4.7 ACPI settings.....	175
1.4.8 CPU configuration.....	176
1.4.9 Memory configuration.....	178
1.4.10 Chipset configuration.....	179
1.4.11 IDE configuration.....	180
1.4.12 USB configuration.....	181
1.4.13 Serial port console redirection.....	182
1.5 Boot.....	185
1.5.1 Boot device priority.....	185
1.5.2 Boot configuration.....	186
1.6 Security.....	187
1.7 Save & Exit.....	189
1.8 BIOS default settings.....	190
1.8.1 Main.....	190
1.8.2 Advanced.....	190
1.8.3 Boot.....	194
1.8.4 Security.....	194
1.9 Allocation of resources.....	195
1.9.1 RAM address assignment.....	195
1.9.2 I/O address assignment.....	195
1.9.3 Interrupt assignments in PIC mode.....	195
1.9.4 Interrupt assignment in APIC mode.....	195
2 Upgrade information.....	197
2.1 BIOS upgrade.....	197
2.1.1 Important information.....	197
2.1.2 Procedure with MS-DOS.....	197
2.2 Firmware upgrade.....	199
2.2.1 Procedure.....	199
2.2.2 Possible upgrade problems and software dependencies (for V1.02).....	200
2.3 Creating an MS-DOS boot diskette in Windows XP.....	201
2.4 Creating a bootable USB flash drive for B&R upgrade files.....	203
2.4.1 Requirements.....	203
2.4.2 Procedure.....	203
2.4.3 How to access MS-DOS.....	203
2.5 Creating a bootable CompactFlash card for B&R upgrade files.....	204
2.5.1 Requirements.....	204
2.5.2 Procedure.....	204
2.5.3 How to access MS-DOS.....	204
3 Microsoft DOS.....	205
3.1 Order data.....	205
3.2 Known problems.....	205
3.3 Resolutions and color depths.....	205
4 Windows XP Professional.....	206
4.1 General information.....	206
4.2 Order data.....	206
4.3 Overview.....	206

4.4 Installation.....	206
4.4.1 Installation on a PCI SATA RAID controller - 5ACPCI.RAIC-03, 5ACPCI.RAIC-05, 5ACPCI.RAIC-06.....	206
4.5 Drivers.....	207
5 Windows 7.....	208
5.1 General information.....	208
5.2 Order data.....	208
5.3 Overview.....	208
5.4 Installation.....	208
5.4.1 Installation on a PCI SATA RAID controller - 5ACPCI.RAIC-03, 5ACPCI.RAIC-05, 5ACPCI.RAIC-06.....	209
5.5 Drivers.....	209
5.6 Special considerations, limitations.....	209
5.7 Supported display resolutions.....	209
6 Windows Embedded Standard 2009.....	210
6.1 General information.....	210
6.2 PPC800 (NM10) - Order data.....	210
6.3 Overview.....	210
6.4 Features with WES2009 (Windows Embedded Standard 2009).....	210
6.5 Installation.....	211
6.6 Drivers.....	211
6.6.1 Touch screen driver.....	211
6.7 Supported display resolutions.....	211
7 Windows Embedded Standard 7.....	212
7.1 General information.....	212
7.2 PPC800 (NM10) - Order data.....	212
7.3 Overview.....	212
7.4 Features with WES7 (Windows Embedded Standard 7).....	212
7.5 Installation.....	213
7.6 Drivers.....	213
7.6.1 Touch screen driver.....	213
7.7 Supported display resolutions.....	213
8 Automation Runtime.....	214
8.1 General information.....	214
8.2 Order data.....	214
8.3 Automation Runtime Windows (ARwin).....	214
8.4 Technology Guarding.....	215
9 B&R Automation Device Interface (ADI) - Control Center.....	216
9.1 Functions.....	216
9.2 Installation.....	217
9.3 SDL Equalizer settings.....	218
9.4 UPS configuration.....	219
9.4.1 Installing the UPS service for the B&R add-on UPS.....	219
9.4.2 Displaying UPS default values.....	219
9.4.3 Changing UPS battery settings.....	220
9.4.4 Updating UPS battery settings.....	221
9.4.5 Saving UPS battery settings.....	222
9.4.6 Configuring UPS system settings.....	222
9.4.7 Changing additional UPS settings.....	223
9.4.8 Procedure following power failure.....	225
10 B&R Automation Device Interface (ADI) Development Kit.....	226
11 B&R Automation Device Interface (ADI) .NET SDK.....	228
12 B&R Key Editor.....	230
Chapter 5 Standards and certifications.....	232
1 Standards and guidelines.....	232
1.1 CE mark.....	232

1.2 EMC directive.....	232
1.3 Low voltage directive.....	232
2 Certifications.....	233
2.1 GOST-R.....	233
Chapter 6 Accessories.....	234
1 Replacement CMOS batteries.....	234
1.1 0AC201.91 / 4A0006.00-00.....	234
1.1.1 General information.....	234
1.1.2 Order data.....	234
1.1.3 Technical data.....	234
2 Power connectors.....	236
2.1 0TB103.9x.....	236
2.1.1 General information.....	236
2.1.2 Order data.....	236
2.1.3 Technical data.....	236
3 DVI/Monitor adapter.....	237
3.1 5AC900.1000-00.....	237
3.2 General information.....	237
3.3 Order data.....	237
4 USB interface cover.....	238
4.1 5AC900.1201-00.....	238
4.1.1 General information.....	238
4.1.2 Order data.....	238
4.2 5AC900.1201-01.....	238
4.2.1 General information.....	238
4.2.2 Order data.....	238
5 Clamping blocks.....	239
5.1 5AC900.BLOC-00.....	239
5.1.1 General information.....	239
5.1.2 Order data.....	239
6 Uninterruptible power supply.....	240
6.1 Features.....	240
6.2 Requirements.....	240
6.3 5AC600.UPSI-00.....	241
6.3.1 General information.....	241
6.3.2 Order data.....	241
6.3.3 Technical data.....	241
6.3.4 Installation.....	241
6.4 5AC600.UPSB-00.....	243
6.4.1 General information.....	243
6.4.2 Order data.....	243
6.4.3 Technical data.....	243
6.4.4 Service life.....	244
6.4.5 Deep discharge cycles.....	244
6.4.6 Dimensions.....	245
6.4.7 Drilling template.....	245
6.4.8 Installation instructions.....	245
6.5 5CAUPS.00xx-00.....	246
6.5.1 General information.....	246
6.5.2 Order data.....	246
6.5.3 Technical data.....	246
6.6 5AC600.UPSF-00.....	247
6.6.1 General information.....	247
6.6.2 Order data.....	247
6.7 5AC600.UPSF-01.....	247
6.7.1 General information.....	247

6.7.2 Order data.....	247
7 External UPS.....	248
7.1 General information.....	248
7.2 Order data.....	248
8 PCI plug-in cards.....	250
8.1 5ACPCI.ETH1-01.....	250
8.1.1 General information.....	250
8.1.2 Order data.....	250
8.1.3 Technical data.....	250
8.1.4 Driver support.....	251
8.1.5 Dimensions.....	252
8.2 5ACPCI.ETH3-01.....	253
8.2.1 General information.....	253
8.2.2 Order data.....	253
8.2.3 Technical data.....	253
8.2.4 Driver support.....	254
8.2.5 Dimensions.....	255
9 CompactFlash cards.....	256
9.1 General information.....	256
9.2 General information.....	256
9.2.1 Flash technology.....	256
9.2.2 Wear leveling.....	256
9.2.3 ECC error correction.....	256
9.2.4 S.M.A.R.T. support.....	256
9.2.5 Maximum reliability.....	257
9.3 5CFCRD.xxxx-06.....	258
9.3.1 General information.....	258
9.3.2 Order data.....	258
9.3.3 Technical data.....	259
9.3.4 Temperature/Humidity diagram.....	262
9.3.5 Dimensions.....	262
9.3.6 Benchmark.....	263
9.4 5CFCRD.xxxx-03.....	264
9.4.1 General information.....	264
9.4.2 Order data.....	264
9.4.3 Technical data.....	264
9.4.4 Temperature/Humidity diagram.....	266
9.4.5 Dimensions.....	266
9.5 Known problems/issues.....	267
10 USB flash drives.....	268
10.1 5MMUSB.2048-00.....	268
10.1.1 General information.....	268
10.1.2 Order data.....	268
10.1.3 Technical data.....	268
10.1.4 Temperature/Humidity diagram.....	269
10.2 5MMUSB.xxxx-01.....	270
10.2.1 General information.....	270
10.2.2 Order data.....	270
10.2.3 Technical data.....	270
10.2.4 Temperature/Humidity diagram.....	271
11 USB media drive.....	272
11.1 5MD900.USB2-02.....	272
11.1.1 General information.....	272
11.1.2 Order data.....	272
11.1.3 Interfaces.....	272
11.1.4 Technical data.....	272
11.1.5 Dimensions.....	274

11.1.6 Dimensions with front cover.....	274
11.1.7 Cutout installation.....	275
11.1.8 Contents of delivery.....	275
11.1.9 Installation.....	275
11.2 5A5003.03.....	276
11.2.1 General information.....	276
11.2.2 Order data.....	276
11.2.3 Technical data.....	276
11.2.4 Dimensions.....	276
11.2.5 Contents of delivery.....	276
11.2.6 Installation.....	277
12 HMI Drivers & Utilities DVD.....	278
12.1 5SWHMI.0000-00.....	278
12.1.1 General information.....	278
12.1.2 Order data.....	278
12.1.3 Contents (V2.20).....	278
13 Cables.....	281
13.1 USB cables.....	281
13.1.1 5CAUSB.00xx-00.....	281
13.2 RS232 cables.....	282
13.2.1 9A0014.xx.....	282
13.3 Internal supply cable.....	284
13.3.1 5CAMSC.0001-00.....	284
Chapter 7 Maintenance and service.....	285
1 Replacing the battery.....	285
1.1 Evaluating the battery status.....	285
1.2 Procedure.....	285
2 Cleaning.....	287
3 Replacing a CompactFlash card.....	288
4 Installing and replacing slide-in compact drives.....	289
4.1 Procedure.....	289
5 Installing and replacing slide-in drives.....	290
5.1 Procedure.....	290
6 Installing the slide-in compact adapter.....	291
6.1 Procedure.....	291
7 Installing and replacing fan kits.....	293
7.1 Procedure.....	293
8 Installing the UPS module.....	295
8.1 Installation guidelines.....	295
9 Installing the UPS fuse kit on the battery unit.....	297
9.1 Procedure.....	297
10 Installing and replacing bus units.....	299
10.1 Procedure.....	299
11 Installing and replacing adapters.....	300
11.1 Procedure for the 5AC803.BC01-00 adapter.....	300
11.2 Procedure for the 5AC803.BC02-00 adapter.....	301
12 Installing and replacing PCIec plug-in cards.....	302
12.1 Procedure.....	302
13 Installing the side cover.....	303
13.1 PPC800 without expansion.....	303
13.2 PPC800 with an expansion.....	303
14 Replacing a PCI SATA RAID hard disk in a RAID 1 set.....	304
14.1 Procedure.....	304
Appendix A	306
1 Maintenance Controller Extended (MTCX).....	306

1.1 Temperature monitoring - Fan control.....	306
2 Connecting an external device to the mainboard.....	308
3 5-wire AMT touch screen.....	309
3.1 Technical data.....	309
3.2 Temperature/Humidity diagram.....	309
3.3 Cleaning.....	309
4 Panel overlay.....	311
5 Viewing angles.....	312
6 Mounting compatibility.....	313
6.1 Compatibility overview.....	313
6.2 Compatibility details.....	314
6.2.1 Example.....	314
6.2.2 5.7" devices.....	314
6.2.3 10.4" devices.....	316
6.2.4 12.1" devices.....	317
6.2.5 15" devices.....	318
6.2.6 17" devices.....	319
6.2.7 19" devices.....	319
6.2.8 21.3" devices.....	320
7 Glossary.....	321

Chapter 1 • General information

1 Manual history

Version	Date	Change
0.10 Preliminary	19-Dec-12	<ul style="list-style-type: none"> • First version
1.00	12-Mar-13	<ul style="list-style-type: none"> • Added and revised section "BIOS options" on page 156 in "Software" on page 156. • Updated the following drives: "5AC801.HDDI-04" on page 81, "5ACPCI.RAIC-06" on page 122, "5MMHDD.0500-00" on page 127 • Updated general information about drives "5ACPCI.RAIC-05" on page 119 and "5MMHDD.0250-00" on page 125.
1.05	15-May-13	<ul style="list-style-type: none"> • Added section "Hardware monitoring" on page 165 in 4 "Software". • Updated all technical data. • Revised section "Serial number sticker" on page 34. • Updated add-on fuse kit "5AC600.UPSF-00" on page 247 and replacement fuses "5AC600.UPSF-01" on page 247 for the UPS battery unit. • Added drive "5AC801.SSDI-03" on page 91. • Updated replacement SSDs "5MMSSD.0060-00" on page 99, "5MMSSD.0060-01" on page 101 and "5MMSSD.0180-00" on page 107. • Updated technical data for HDD "5AC801.HDDI-04" on page 81.
1.10	20-Aug-13	<ul style="list-style-type: none"> • Updated B&R USB flash drive 5MMUSB.4096-01, see "USB flash drives" on page 268. • Updated slide-in compact drive "5AC801.SSDI-04" on page 94. • Updated replacement SSD "5MMSSD.0128-01" on page 104. • Updated tightening torque of locating screws in section "Cables" on page 281. • Updated sections "B&R Automation Device Interface (ADI) Development Kit" on page 226 and "B&R Automation Device Interface (ADI) .NET SDK" on page 228.
1.15	07-Feb-14	<ul style="list-style-type: none"> • Revised description "Installing the UPS module" on page 295. • Updated slide-in compact drive "5AC801.SSDI-05" on page 97. • Updated replacement SSD "5MMSSD.0256-00" on page 109. • Updated technical data and temperature / relative humidity diagrams for the "5AC801.SSDI-04" on page 94 and "5MMSSD.0128-01" on page 104 SSDs. • Added information about the discontinuation of support for the "Windows XP Professional" on page 206 operating system. • Updated "B&R Automation Device Interface (ADI) - Control Center" on page 216. • Updated "B&R Automation Device Interface (ADI) Development Kit" on page 226. • Updated "B&R Automation Device Interface (ADI) .NET SDK" on page 228. • Updated "B&R Key Editor" on page 230 to version 3.40. • Updated GOST-R certification information in the technical data. • Updated section "GOST-R" on page 233. • Updated section "BIOS options" on page 156.
1.20	02.12.2014	<ul style="list-style-type: none"> • Die Umgebungstemperatur und Luftfeuchtigkeit wurde bei folgenden Laufwerken in den Technischen Daten korrigiert: "5AC801.SSDI-03" on page 91"5AC801.SSDI-04" on page 94"5AC801.SSDI-05" on page 97"5MMSSD.0060-01" on page 101"5MMSSD.0128-01" on page 104"5MMSSD.0256-00" on page 109 • "5CFCRD.xxxx-06" on page 258 • "5PC820.1505-00" on page 46"5PC820.1906-00" on page 52
1.21	2015-03-20	<ul style="list-style-type: none"> • Updated section "Maximum ambient temperatures" on page 24. • Revised pinout of monitor/panel interface, see "Monitor/Panel interface - RGB" on page 36. • Updated order data for system units "5PC820.1505-00" on page 46"5PC820.1906-00" on page 52. • Updated technical data for system units "5PC820.1505-00" on page 46 and "5PC820.1906-00" on page 52. • Updated section "Automation Runtime" on page 214.

Table 1: Manual history

2 Safety guidelines

2.1 Intended use

Programmable logic controllers (PLCs), operating/monitoring devices (industrial PCs, Power Panels, Mobile Panels, etc.) and B&R uninterruptible power supplies have been designed, developed and manufactured for conventional use in industrial environments. They were not designed, developed and manufactured for any use involving serious risks or hazards that could lead to death, injury, serious physical damage or loss of any kind without the implementation of exceptionally stringent safety precautions. In particular, such risks and hazards include the use of these devices to monitor nuclear reactions in nuclear power plants, their use in flight control or flight safety systems as well as in the control of mass transportation systems, medical life support systems or weapons systems.

2.2 Protection against electrostatic discharge

Electrical components that can be damaged by electrostatic discharge (ESD) must be handled accordingly.

2.2.1 Packaging

- **Electrical components with a housing**
...do not require special ESD packaging but must be handled properly (see "Electrical components with a housing").
- **Electrical components without a housing**
...are protected by ESD-suitable packaging.

2.2.2 Guidelines for proper ESD handling

Electrical components with a housing

- Do not touch the connector contacts on connected cables.
- Do not touch the contact tips on circuit boards.

Electrical components without a housing

The following applies in addition to the points listed under "Electrical components with a housing":

- Any persons handling electrical components or devices with installed electrical components must be grounded.
- Components are only permitted to be touched on their narrow sides or front plate.
- Components should always be stored in a suitable medium (ESD packaging, conductive foam, etc.). Metallic surfaces are not suitable storage surfaces!
- Components should not be subjected to electrostatic discharge (e.g. through the use of charged plastics).
- Ensure a minimum distance of 10 cm from monitors and TV sets.
- Measuring instruments and equipment must be grounded.
- Probes on potential-free measuring instruments must be discharged on sufficiently grounded surfaces before taking measurements.

Individual components

- ESD protective measures for individual components are thoroughly integrated at B&R (conductive floors, footwear, arm bands, etc.).
- These increased ESD protective measures for individual components are not necessary for customers handling B&R products.

2.3 Policies and procedures

Electronic devices are never completely failsafe. If the programmable control system, operating/monitoring device or uninterruptible power supply fails, the user is responsible for ensuring that other connected devices, e.g. motors, are brought to a secure state.

When using programmable logic controllers or operating/monitoring devices as control systems together with a soft PLC (e.g. B&R Automation Runtime or comparable product) or slot PLC (e.g. B&R LS251 or comparable product), safety precautions relevant to industrial control systems (e.g. the provision of safety devices such as emergency stop circuits, etc.) must be observed in accordance with applicable national and international regulations. The same applies for all other devices connected to the system, such as drives.

All tasks such as the installation, commissioning and servicing of devices are only permitted to be carried out by qualified personnel. Qualified personnel are those familiar with the transport, mounting, installation, commissioning and operation of devices who also have the appropriate qualifications (e.g. IEC 60364). National accident prevention regulations must be observed.

The safety notices, connection descriptions (type plate and documentation) and limit values listed in the technical data are to be read carefully before installation and commissioning and must be observed.

2.4 Transport and storage

During transport and storage, devices must be protected against undue stress (mechanical loads, temperature, moisture, corrosive atmospheres, etc.).

2.5 Installation

- These devices are not ready for use upon delivery and must be installed and wired according to the specifications in this documentation in order for the EMC limit values to apply.
- Installation must be performed according to this documentation using suitable equipment and tools.
- Devices are only permitted to be installed by qualified personnel without voltage applied. Before installation, voltage to the control cabinet must be switched off and prevented from being switched on again.
- General safety guidelines and national accident prevention regulations must be observed.
- Electrical installation must be carried out in accordance with applicable guidelines (e.g. line cross sections, fuses, protective ground connections).

2.6 Operation

2.6.1 Protection against touching electrical parts

To operate programmable logic controllers, operating and monitoring devices, and uninterruptible power supplies, certain components must carry dangerous voltage levels. Touching one of these parts can result in a life-threatening electric shock. This could lead to death, severe injury or damage to equipment.

Before turning on the programmable logic controller, operating/monitoring devices or uninterruptible power supply, the housing must be properly grounded (PE rail). Ground connections must be established even when testing or operating operating/monitoring devices or the uninterruptible power supply for a short time!

Before turning the device on, all parts that carry voltage must be securely covered. During operation, all covers must remain closed.

2.6.2 Environmental conditions - Dust, moisture, corrosive gases

The use of operating/monitoring devices (e.g. industrial PCs, Power Panels, Mobile Panels, etc.) and uninterruptible power supplies in very dusty environments should be avoided. Dust collection on the devices can affect functionality and may prevent sufficient cooling, especially in systems with active cooling systems (fans).

The presence of corrosive gases can also lead to malfunctions. When combined with high temperature and humidity, corrosive gases – e.g. with sulfur, nitrogen and chlorine components – can induce chemical reactions that can damage electronic components very quickly. Signs of the presence of corrosive gases are blackened copper surfaces and cable ends on existing equipment.

For operation in dusty or moist conditions, correctly installed (e.g. cutout installations) operating/monitoring devices like the Automation Panel or Power Panel are protected on the front. The back of all devices must be protected from dust and moisture and cleaned at suitable intervals.

2.6.3 Viruses and dangerous programs

This system is subject to potential risk each time data is exchanged or software is installed from a data medium (e.g. diskette, CD-ROM, USB flash drive, etc.), a network connection or the Internet. The user is responsible for assessing these dangers, implementing preventive measures such as virus protection programs, firewalls, etc. and making sure that software is only obtained from trusted sources.

2.7 Environmentally friendly disposal

All B&R programmable controllers, operating/monitoring devices and uninterruptible power supplies are designed to inflict as little harm as possible on the environment.

2.7.1 Separation of materials

It is necessary to separate different materials so the device can undergo an environmentally friendly recycling process.

Component	Disposal
Programmable logic controllers Operating/Monitoring devices Uninterruptible power supply Batteries and rechargeable batteries Cables	Electronics recycling
Cardboard box / Paper packaging	Cardboard box / Paper recycling
Plastic packaging	Plastic recycling

Table 2: Environmentally friendly separation of materials

Disposal must comply with applicable legal regulations.

3 Organization of safety notices

Safety notices in this manual are organized as follows:

Safety notice	Description
Danger!	Disregarding these safety guidelines and notices can be life-threatening.
Warning!	Disregarding these safety guidelines and notices can result in severe injury or substantial damage to equipment.
Caution!	Disregarding these safety guidelines and notices can result in injury or damage to equipment.
Information:	This information is important for preventing errors.

Table 3: Description of the safety notices used in this documentation

4 Guidelines

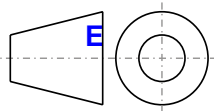

European dimension standards apply to all dimension diagrams in this document.

All dimensions are specified in mm.

Range of nominal sizes	General tolerance according to DIN ISO 2768 (medium)
Up to 6 mm	±0.1 mm
For 6 to 30 mm	±0.2 mm
For 30 to 120 mm	±0.3 mm
For 120 to 400 mm	±0.5 mm
For 400 to 1000 mm	±0.8 mm

Table 4: Range of nominal sizes

5 Overview

Product ID	Short description	on page
	24 VDC UPS modules	
9A0100.11	UPS 24 VDC, 24 VDC input, 24 VDC output, serial interface	248
	Accessories	
5AC900.1201-00	USB interface cover M20 IP65 flat	238
5AC900.1201-01	USB interface cover M20 IP65 curved	238
5AC900.BLOC-00	Terminal block with brackets, 10 pcs.; replacement part	239
5ACPCI.ETH1-01	PCI Ethernet card 1x 10/100	250
5ACPCI.ETH3-01	PCI Ethernet card 3x 10/100	253
5CAMSC.0001-00	Internal supply cable	284
	Adapter	
5AC803.BC01-00	1 compact PCI Express PPC800 adapter	69
5AC803.BC02-00	1 compact slide-in PPC800 adapter	69
	Automation Runtime	
0TG1000.01	Technology Guard	214
1TG4600.10-5	Automation Runtime Windows, TG license	214
	Batteries	
0AC201.91	Lithium batteries 4 pcs., 3 V / 950 mAh button cell We hereby state that the lithium cells contained in this shipment qualify as "partly regulated". Handle with care. If the package is damaged, inspect the cells, repack intact cells and protect the cells against short circuit. For emergency information, call RENATA SA at +41 61 319 28 27.	234
4A0006.00-000	Lithium battery, 3 V / 950 mAh, button cell	234
	Battery units	
9A0100.12	UPS battery unit type A, 24 V, 7 Ah, incl. battery cage	248
9A0100.14	UPS battery unit type B, 24 V, 2.2 Ah, incl. battery cage	248
9A0100.16	UPS battery unit type C, 24 V, 4.5 Ah, incl. battery cage	248
	Bus units	
5AC803.BX01-00	PPC800 bus; 1 PCI, 1 slide-in slot	67
5AC803.BX01-01	PPC800 bus; 1 PCI Express, 1 slide-in slot	67
5AC803.BX02-00	PPC800 bus; 2 PCI, 1 slide-in slot	67
5AC803.BX02-01	PPC800 bus; 1 PCI, 1 PCI Express, 1 slide-in slot	67
	CPU boards	
5PC800.CCAX-00	Intel Atom N2800 CPU board, 1.86 GHz, dual core, 533 MHz FSB, 1 MB L2 cache; NM10 chipset; 1 slot for SO-DIMM DDR3 module	58
	CompactFlash	
5CFCRD.016G-06	CompactFlash 16 GB B&R (SLC) ≤ Rev. D0	258
5CFCRD.032G-06	CompactFlash 32 GB B&R (SLC) ≤ Rev. C0	258
5CFCRD.0512-06	CompactFlash 512 MB B&R (SLC) ≤ Rev. E0	258
5CFCRD.1024-06	CompactFlash 1 GB B&R (SLC) ≤ Rev. E0	258
5CFCRD.2048-06	CompactFlash 2 GB B&R (SLC) ≤ Rev. E0	258
5CFCRD.4096-06	CompactFlash 4 GB B&R (SLC) ≤ Rev. E0	258
5CFCRD.8192-06	CompactFlash 8 GB B&R (SLC) ≤ Rev. E0	258
	CompactFlash-cards	
5CFCRD.0064-03	CompactFlash 64 MB Western Digital (SLC)	264
5CFCRD.0128-03	CompactFlash 128 MB Western Digital (SLC)	264
5CFCRD.0256-03	CompactFlash 256 MB Western Digital (SLC)	264
5CFCRD.0512-03	CompactFlash 512 MB Western Digital (SLC)	264
5CFCRD.1024-03	CompactFlash 1 GB Western Digital (SLC)	264
5CFCRD.2048-03	CompactFlash 2 GB Western Digital (SLC)	264
5CFCRD.4096-03	CompactFlash 4 GB Western Digital (SLC)	264
5CFCRD.8192-03	CompactFlash 8 GB Western Digital (SLC)	264
	Drives	
5AC801.ADAS-00	SATA hard disk adapter for operating a slide-in compact hard disk in a slide-in slot	111
5AC801.DVDS-00	DVD-ROM SATA slide-in drive	114
5AC801.DVRS-00	DVD-R/RW DVD+R/RW SATA slide-in drive	116
5AC801.HDDI-00	40 GB SATA slide-in compact hard disk; 24/7 operation with extended temperature range. Note: please see the manual for information about using this hard disk	77
5AC801.HDDI-03	250 GB slide-in compact SATA hard disk, 24/7 operation. Note: please see the manual for information about using this hard disk	79
5AC801.HDDI-04	500 GB SATA hard disk, slide-in compact, 24/7 operation Note: please see the manual for information about using this hard disk	81
5AC801.HDDS-00	40 GB SATA slide-in hard disk; 24/7 operation with extended temperature range. Note: please see the manual for information about using this hard disk	112
5AC801.SSDI-00	32 GB SATA SSD (SLC), slide-in compact	83
5AC801.SSDI-01	60 GB SATA slide-in compact SSD (MLC)	87
5AC801.SSDI-02	180 GB SATA slide-in compact SSD (MLC)	89
5AC801.SSDI-03	60 GB SATA slide-in compact SSD (MLC)	91
5AC801.SSDI-04	128 GB SATA SSD (MLC), slide-in compact	94
5AC801.SSDI-05	256 GB SATA slide-in compact SSD (MLC)	97
5ACPCI.RAIC-05	PCI RAID system SATA 2x 250 GB; Note: please see the manual for information about using this hard disk	119
5ACPCI.RAIC-06	PCI RAID System 2x 500 GB - SATA	122
5MMHDD.0250-00	250 GB SATA hard disk; replacement for 5AC801.HDDI-03 and 5ACPCI.RAIC-05; note: please see the manual for information about using this hard disk	125
5MMHDD.0500-00	500 GB hard disk - SATA	127
5MMSSD.0060-00	60 GB SSD MLC - Intel - SATA	99

Product ID	Short description	on page
5MMSSD.0060-01	60 GB SSD MLC - Intel - SATA	101
5MMSSD.0128-01	128 GB SSD MLC - Toshiba - SATA	104
5MMSSD.0180-00	180 GB SSD MLC - Intel - SATA	107
5MMSSD.0256-00	256 GB SSD MLC - Slide-in compact - Toshiba - SATA	109
Expansions		
5AC803.SX01-00	PPC800 expansion; 1 PCI/PCI Express and 1 slide-in slot (bus 5AC803.BX01-00 or 5AC803.BX01-01 required)	62
5AC803.SX02-00	PPC800 expansion; 2 PCI/PCI Express and 1 slide-in slot (bus 5AC803.BX02-00 or 5AC803.BX02-01 required)	62
Fan kits		
5AC803.FA01-00	PPC800 fan kit for system units without an expansion	129
5AC803.FA02-00	PPC800 fan kit for system units with expansion 5AC803.SX01-00	130
5AC803.FA03-00	PPC800 fan kit for system units with expansion 5AC803.SX02-00	132
Heat sinks		
5AC803.HS00-04	PPC800 heat sink for CPU board with Atom dual-core processor N2800	60
Interface cards		
5ACPC.C.ETH0-00	PCIe Ethernet card 1x 10/100/1000 For APC820 and PPC800.	71
5ACPC.C.MPL0-00	PCIe POWERLINK card, 2 POWERLINK interfaces, 512 kB SRAM; for APC820 and PPC800.	73
MS-DOS		
9S0000.01-010	OEM Microsoft MS-DOS 6.22, German floppy disks, only supplied together with a new PC	205
9S0000.01-020	OEM Microsoft MS-DOS 6.22, English floppy disks, only supplied together with a new PC	205
Main memory for GM45 CPU boards		
5MMDDR.2048-02	SO-DIMM DDR3 RAM 2048 MB PC3-8500	61
5MMDDR.4096-02	SO-DIMM DDR3 RAM 4096 MB PC3-8500	61
Miscellaneous		
5AC900.1000-00	DVI (male connector) to CRT (female connector) adapter. For connecting a standard monitor to a DVI-I interface.	237
Other		
5SWHMI.0000-00	HMI Drivers & Utilities DVD	278
RS232 cables		
9A0014.02	RS232 extension cable for remote operation of a display unit with touch screen, 1.8 m	282
9A0014.05	RS232 extension cable for remote operation of a display unit with touch screen, 5 m	282
9A0014.10	RS232 extension cable for remote operation of a display unit with touch screen, 10 m	282
Replacement batteries		
9A0100.13	UPS batteries type A (replacement part), 2x 12 V, 7 Ah, for battery unit 9A0100.12	248
9A0100.15	UPS batteries type B (replacement part), 2x 12 V, 2.2 Ah, for battery unit 9A0100.14	248
9A0100.17	UPS batteries type C (replacement part), 2x 12 V, 4.5 Ah, for battery unit 9A0100.16	248
Systemeinheiten		
5PC820.1505-00	Panel PC 820 15" XGA TFT display with touch screen (resistive); connections for 1x RS232, 5x USB 2.0, Smart Display Link/DVI/Monitor, 2x Ethernet 10/100/1000, HDA sound, add-on UPS slot, expandable with 1 or 2 PCI / PCI Express slots, optional CompactPCI Express and slide-in compact slot; IP65 protection (front); order 24 VDC connector for supply voltage separately (screw clamp: 0TB103.9; cage clamp: 0TB103.91)	46
5PC820.1906-00	Panel PC 820 19" SXGA color TFT display with touch screen (resistive); connections for 1x RS232, 5x USB 2.0, Smart Display Link/DVI/Monitor, 2x Ethernet 10/100/1000, HDA sound, add-on UPS slot, expandable with 1 or 2 PCI / PCI Express slots, optional CompactPCI Express and slide-in compact slot; IP65 protection (front); order 24 VDC connector for supply voltage separately (screw clamp: 0TB103.9; cage clamp: 0TB103.91)	52
Terminal blocks		
0TB103.9	Connector 24 VDC - 3-pin female - Screw clamps 3.31 mm ²	236
0TB103.91	Connector 24 VDC - 3-pin female - Cage clamps 3.31 mm ²	236
USB accessories		
5A5003.03	Front cover for drives - 5A5003.02 - 5MD900.USB2	276
5MD900.USB2-02	USB 2.0 drive combination - DVD-R/RW, DVD+R/RW - CompactFlash slot	272
5MMUSB.2048-00	USB 2.0 flash drive, 2048 MB	268
5MMUSB.2048-01	USB 2.0 flash drive, 2048 MB, B&R	270
5MMUSB.4096-01	USB 2.0 flash drive, 4096 MB, B&R	270
USB cables		
5CAUSB.0018-00	USB 2.0 connection cable type A - type B, 1.8 m	281
5CAUSB.0050-00	USB 2.0 connection cable type A - type B, 5 m	281
Uninterruptible power supplies		
5AC600.UPSB-00	Battery unit 5 Ah; for APC620, APC810 or PPC800 UPS	243
5AC600.UPSF-00	UPS fuse kit for battery unit 5AC600.UPSB-00 up to revision D0.	247
5AC600.UPSF-01	UPS fuse, 5 pcs.	247
5AC600.UPSI-00	UPS module for APC620, APC810, PPC800; for system units 5PC600.SX01-00 (beginning with rev. H0), 5PC600.SX02-00 (beginning with rev. G0), 5PC600.SX02-01 (beginning with rev. H0), 5PC600.SX05-00 (beginning with rev. F0), 5PC600.SX05-01 (beginning with rev. F0), 5PC600.SF03-00 (beginning with rev. A0), 5PC810.SX*. 5PC820.1505-00, 5PC820.1906-00. Order cable (5CAUPS.0005-00 or 5CAUPS.0030-00) and battery unit (5AC600.UPSB-00) separately.	241
5CAUPS.0005-00	UPS cable 0.5 m; for UPS 5AC600.UPSI-00	246
5CAUPS.0030-00	UPS cable 3 m - For 5AC600.IUPS-00	246
Windows 7 Professional/Ultimate		
5SWWI7.1100-ENG	Windows 7 Professional SP1 - 32-bit - English - DVD	208
5SWWI7.1100-GER	Windows 7 Professional SP1 - 32-bit - German - DVD	208
5SWWI7.1300-MUL	Windows 7 Ultimate SP1 - 32-bit - Multilingual - DVD	208
Windows Embedded Standard 2009		
5SWWXP.0739-ENG	Microsoft OEM Windows Embedded Standard 2009, English; for PPC800 with NM10 chipset; order CompactFlash separately (at least 1 GB).	210
Windows Embedded Standard 7		
5SWWI7.1539-ENG	Microsoft OEM Windows Embedded Standard 7 32-bit, Service Pack 1, English; for PPC800 with NM10 chipset; order CompactFlash separately (at least 16 GB).	212

Product ID	Short description	on page
5SWWI7.1739-MUL	Microsoft OEM Windows Embedded Standard 7 Premium 32-bit, Service Pack 1, multilingual; for PPC800 with NM10 chipset; order CompactFlash separately (at least 16 GB).	212
	Windows XP Professional	
5SWWXP.0600-ENG	Windows XP Professional SP3 - English - CD	206
5SWWXP.0600-GER	Windows XP Professional SP3 - German - CD	206
5SWWXP.0600-MUL	Windows XP Professional SP3 - Multilingual - CD	206

Chapter 2 • Technical data

1 Introduction

The Panel PC 800 covers an extremely wide performance range – relying on efficient Intel Atom N2800 processors and Core2 Duo processors for applications with exceptionally high performance requirements. Brilliant 15" XGA and 19" SXGA touch screen displays provide a simple and intuitive user interface. Flexibility was raised to a completely new level when designing the PPC800. This makes it possible to add several different options to the cost-effective base device. This includes up to two PCI and PCI Express slots, modular drives, additional interfaces and an integrated UPS. The chipset, processor and other components are connected directly to the heat sink using heat conductive materials. This makes it possible to operate not only Atom processors, but also certain dual-core processors without a fan at all.



1.1 Features

- 15" and 19" diagonals
- Latest processor technology - Atom N2800 (dual core)
- Up to 4 GB main memory
- 2 CompactFlash slots (type I)
- Upgrade expansions with 1 or 2 slots for PCI / PCI Express (PCIe) cards and a slide-in drive slot
- 1 optional PCIec (PCI Express compact) card slot (can be upgraded with an adapter)
- 1 optional slide-in compact slot (can be upgraded with an adapter)
- 5x USB 2.0
- 2x Ethernet 10/100/1000 Mbit interfaces
- 1x RS232 interface, modem-compatible
- 24 VDC supply voltage
- BIOS (AMI UEFI)
- Real-time clock (RTC, battery-backed)
- Easy slide-in drive replacement (SATA hot plugging)
- HDA sound
- Add-on UPS slot

1.2 System components / configuration

The PPC800 system can be assembled to meet individual requirements and operating conditions.

The following components are absolutely essential for operation:

- System unit
- CPU board
- Heat sink (depends on the CPU board)
- Main memory
- Drive (mass storage device such as CompactFlash card or hard disk) for the operating system
- Software

1.2.1 Configuration - Base system

















Configuration - Base system	
System unit	Select 1
	5PC820.1505-00
	5PC820.1906-00
CPU board / Heat sink / Main memory	
CPU board	Select 1
	5PC800.CCAX-00
Heat sinks	Select 1
	5AC803.HS00-04
Main memory	Select 1
	5MMDDR.2048-02 5MMDDR.4096-02

Figure 1: Configuration - Base system

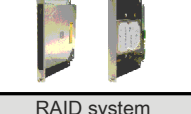
1.2.2 Accessory and software configuration

Accessory and software configuration			
Configuration of a system unit with adapter			
Adapters ¹⁾	Select one or both		
	5AC803.BC01-00 ↓	5AC803.BC02-00 ↓	
	PCIec plug-in cards, Select 1	Slide-in compact drives, select 1	
	5ACPCC.ETH0-00 (PCIec Ethernet card 10/100/1000) 5ACPCC.MPL0-00 (PCIec POWERLINK MN 2-port)	5AC801.HDDI-00 (40 GByte) 5AC801.HDDI-04 (500 GB) 5AC801.SSDI-03 (60 GB) 5AC801.SSDI-04 (128 GB) 5AC801.SSDI-05 (256 GB)	
Configuration of a system unit with expansion			
Expansion	No expansion	1x PCI/PCIe + 1x slide-in slot	2x PCI/PCIe + 1x slide-in slot
	/	5AC803.SX01-00	5AC803.SX02-00
Bus units		Select 1	Select 1
	/	5AC803.BX01-00 5AC803.BX01-01	5AC803.BX02-00 5AC803.BX02-01
Fan kit	Select 1		
	5AC803.FA01-00	5AC803.FA02-00	5AC803.FA03-00
Slide-idrives		Select 1	
	/	5AC801.HDDS-00 (40 GB) 5AC801.DVDS-00 (DVD drive) 5AC801.DVRS-00 (DVD writer) 5AC801.ADAS-00 (adapter)	
RAID system		Select 1	
	/	5ACPCI.RAIC-06 (2x 500 GByte, occupies 1 PCI slot) 5MMHDD.0500-00 (SATA-HDD replacement 500 GByte)	
CompactFlash	Select 1		
	5CFCRD.0512-06, 5CFCRD.1024-06, 5CFCRD.2048-06, 5CFCRD.4096-06, 5CFCRD.8192-06, 5CFCRD.016G-06, 5CFCRD.032G-06	5CFCRD.0064-03, 5CFCRD.0128-03, 5CFCRD.0256-03, 5CFCRD.0512-03, 5CFCRD.1024-03, 5CFCRD.2048-03, 5CFCRD.4096-03, 5CFCRD.8192-03	
UPS battery	Select 1		
	5AC600.UPSI-00 (add-on UPS module) 5AC600.UPSB-00 (UPS battery unit) Connection cable: 5CAUPS.0005-00 (0.5 meters) or 5CAUPS.0030-00 (3 meters)		
Power connectors	Select 1		
	0TB103.9 (screw clamp) 0TB103.91 (cage clamp)		
Software	Select 1		
	Windows XP 5SWWWXP.0600-ENG 5SWWWXP.0600-GER 5SWWWXP.0600-MUL Windows 7 5SWWI7.1100-ENG 5SWWI7.1100-GER 5SWWI7.1300-MUL	Windows Embedded Standard 2009 5SWWWXP.0739-ENG Windows Embedded Standard 7 5SWWI7.1539-ENG 5SWWI7.1739-MUL	Automation Runtime 1TG4600.10-5 0TG1000.01 Microsoft DOS 9S0000.01-010 9S0000.01-020

1) If both adapters are used, then a PCIec plug-in card and a slide-in compact drive can be used in a single device.

in compact drive can be used in

Figure 2: Accessory and software configuration

2 Complete system

2.1 Temperature specifications

CPU boards can be combined with various other components such as drives, main memory, additional plug-in cards, etc. depending on the system unit and fan kit. The many different configurations possible result in varying maximum ambient temperatures, which can be seen in the following tables in this section.

Information:

The maximum specified ambient temperatures for operation with and without a fan kit have been determined under worst-case conditions. Experience has shown that higher ambient temperatures can be reached in typical applications, e.g. those in Microsoft Windows. Testing and evaluation must be performed on-site by the user (temperatures can be read in BIOS or with the B&R Control Center).

Information regarding worst-case conditions

- Thermal Analysis Tool (TAT V3.8) from Intel for simulating a 100% processor load
- BurnInTest tool (BurnInTest V4.0 Pro from Passmark Software) for simulating a 100% load on the interface via loop back adapters (serial interfaces, slide-in drives, USB ports, audio outputs)
- Maximum system expansion and power consumption

What must be considered when determining the maximum ambient temperature?

- Operating the complete system with or without fan kit

2.1.1 Maximum ambient temperatures

Information:

Only specified mounting orientations are permitted. See chapter "Installation", section "Mounting orientation" on page 136.

		Operation without Fan kit	Operation where Fan kit		
		5PC800.CCAX-00	5PC800.CCAX-00		
All temperature values in degrees Celsius (°C) at 500 m above sea level.					
The maximum ambient temperature is typically derated by 1°C per 1000 meters (starting at 500 meters above sea level).					
Maximum ambient temperature		50	60		
What else can also be operated at the max. ambient temperature, or are there any limits?				Temperature limits	Location of sensor(s)
Slide-in compact drives	Onboard CompactFlash ¹⁾	✓	✓	80	Board power
	5AC801.HDDI-00	✓	✓	80	
	5AC801.HDDI-03	45	50	60	
	5AC801.HDDI-04	45	50	60	
	5AC801.SSDI-00	✓	✓	70	
	5AC801.SSDI-01	✓	✓	70	
	5AC801.SSDI-02	✓	✓	70	
	5AC801.SSDI-03 ≤ Rev. C0	✓	✓	70	
	5AC801.SSDI-03 ≥ Rev. D0	✓	✓	80	
	5AC801.SSDI-04 ≤ Rev. C0	✓	✓	70	
	5AC801.SSDI-04 ≥ Rev. D0	✓	✓	80	
5AC801.SSDI-05	✓	✓	80		
Slide-in drives	5AC801.HDDS-00	✓	✓	80	Slide-in Drive 1
	5AC801.DVDS-00	✓	50	50	
	5AC801.DVRS-00	✓	50	50	
Main memory	5MMDDR.2048-02	✓	✓	-	Power supply
	5MMDDR.4096-02	✓	✓	-	
System units	5PC820.1505-00	✓	✓	80	Power supply
	5PC820.1906-00	45	50	80	
Additional plug-in cards PCIe / PCI card slot	5ACPCC.ETH0-00	✓	✓	-	Additional plug-in cards
	5ACPCC.MPL0-00	✓	✓	-	
	5ACPCI.RAIC-05 (24 hours / standard)	45	50	-	
	5ACPCI.RAIC-06 (24 hours / standard)	45	50	-	

1) Only possible with a CompactFlash card from B&R that is compatible with the device.

Table 5: Ambient temperatures

2.1.1.1 How is the maximum ambient temperature determined?

1. The CPU board is selected (i.e. operation with or without a fan kit).
2. The "Maximum ambient temperature" row shows the maximum ambient temperature for the complete system, including the respective CPU board.

Information:

Maximum temperature data is for operation at 500 meters. The maximum ambient temperature is typically derated by 1°C per 1000 meters (starting at 500 meters above sea level).

3. Incorporating additional drives (slide-in), main memory, additional plug-in cards, etc. can change the temperature limits of a PPC800 system.

If there is a "✓" next to the component, it can be used at the maximum ambient temperature of the complete system without problems.

If there is a specific temperature, for example "50", next to the component, then the ambient temperature of the complete PPC800 system cannot exceed this temperature.

2.1.2 Minimum ambient temperatures

For systems containing one of the following components, the minimum ambient temperature is +5°C: 5AC801.DVDS-00, 5AC801.DVRS-00. If none of these components are used, then the minimum ambient temperature is 0°C.

2.1.3 Temperature monitoring

Sensors monitor temperature values at various places in the PPC800 (board I/O, board ETH2, board power, power supply, slide-in drive 1, IF slot). The location of these temperature sensors is illustrated in "Temperature sensor locations" on page 25. The value listed in the table represents the defined maximum temperature for this measurement point. An alarm is not triggered if this temperature is exceeded. The temperatures¹⁾ can be read in BIOS (Advanced - Baseboard/Panel features - Baseboard monitor) or in approved Microsoft Windows operating systems using the B&R Control Center.

In addition, the hard disks for PPC800 systems available from B&R are equipped with S.M.A.R.T, or Self-Monitoring, Analysis, and Reporting Technology. This makes it possible to read various parameters, e.g. temperature, using software (such as HDD Thermometer, a freeware program) on approved Microsoft operating systems (except Windows CE).

2.1.4 Temperature sensor locations

Sensors monitor temperature values at many different locations in the PPC800. These temperatures can be read in BIOS (Advanced - Baseboard/Panel features - Baseboard monitor) or in approved Microsoft operating systems using the B&R Control Center²⁾.

For applications that don't use Windows, the temperatures can be evaluated using the B&R implementation guide. In addition to the implementation guide, there are also programs available in MS-DOS.

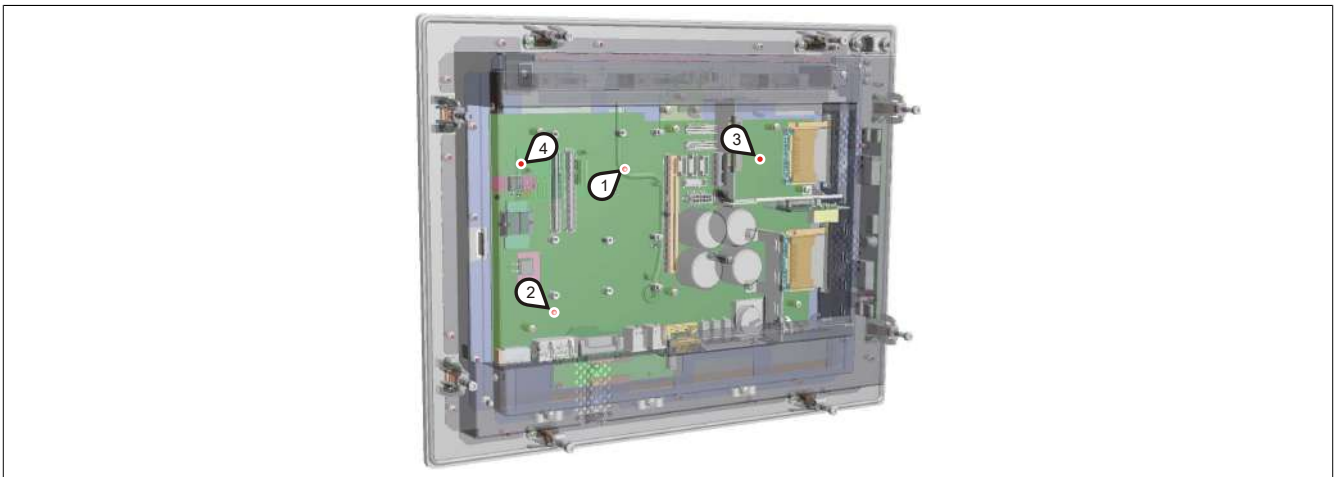

Figure 3: Temperature sensor locations

Position	Measurement point for	Measurement	Max. specified
1	Board I/O	Board temperature in the I/O area (sensor on the mainboard)	80°C
2	Board ETH2	Baseboard temperature near the ETH2 controller (sensor on the mainboard)	80°C
3	Board power	Board power supply temperature (sensor on the mainboard)	80°C
4	Power supply	Power supply temperature	80°C
-	Slide-in drive 1	Slide-in drive temperature (sensor integrated in the slide-in slot).	Depends on the slide-in drive being used
-	IF slot	PCIec slot temperature; the sensor is located directly on the plug-in card.	Depends on the plug-in card being used

Table 6: Temperature sensor locations

¹⁾ The temperature measured approximates the immediate ambient temperature but may also be influenced by neighboring components.

²⁾ The ADI driver containing the B&R Control Center is available in the Downloads section of the B&R website (www.br-automation.com).

2.2 Humidity specifications

The following table lists the minimum and maximum relative humidity values for the individual components that are relevant for the humidity limitations of a complete system. The lowest and highest common values are always used when establishing these limits.

Component		Operation	Storage / Transport
NM10 COM Express CPU boards		10 to 90%	5 to 95%
Main memory for CPU boards		10 to 90%	5 to 95%
Slide-in compact drives	5AC801.HDDI-00	5 to 90%	5 to 95%
	5AC801.HDDI-03	5 to 95%	5 to 95%
	5AC801.HDDI-04	5 to 95%	5 to 95%
	5AC801.SSDI-00	5 to 95%	5 to 95%
	5AC801.SSDI-01	5 to 95%	5 to 95%
	5AC801.SSDI-02	5 to 95%	5 to 95%
	5AC801.SSDI-03 ≤ Rev. C0	8 bis 90%	8 to 95%
	5AC801.SSDI-03 ≥ Rev. D0	5 bis 90%	5 bis 95%
	5AC801.SSDI-04 ≤ Rev. C0	8 bis 90%	8 to 95%
	5AC801.SSDI-04 ≥ Rev. D0	5 bis 90%	5 bis 95%
Slide-in drives	5AC801.HDDS-00	5 to 90%	5 to 90%
	5AC801.DVDS-00	8 to 90%	5 to 95%
	5AC801.DVRS-00	8 to 90%	5 to 95%
Additional plug-in cards	5ACPCI.RAIC-05 (24 hours / standard)	5 to 95%	5 to 95%
	5ACPCI.RAIC-06 (24 hours / standard)	5 to 95%	5 to 95%
	5MMHDD.0250-00 (24 hours / standard)	5 to 95%	5 to 95%
	5MMHDD.0500-00 (24 hours / standard)	5 to 95%	5 to 95%
Accessories	5CFCRD.xxxx-06 CompactFlash cards	85%	85%
	5CFCRD.xxxx-03 CompactFlash cards	8 to 95%	8 to 95%
	5MMUSB.2048-00 flash drive	10 to 90%	5 to 90%
	5MMUSB.xxxx-01 flash drive	85%	85%
	5MD900.USB2-02 USB media drive	20 to 80%	5 to 90% / 5 to 95%

Table 7: Overview of humidity specifications for individual components

The specifications listed correspond to the relative humidity at an ambient temperature of 30°C. More detailed information about specific temperature-dependent humidity values can be found in the technical data for the individual components.

2.3 Power management

2.3.1 Supply voltage block diagram

The following block diagram illustrates the simplified structure of the PPC800 supply voltage.

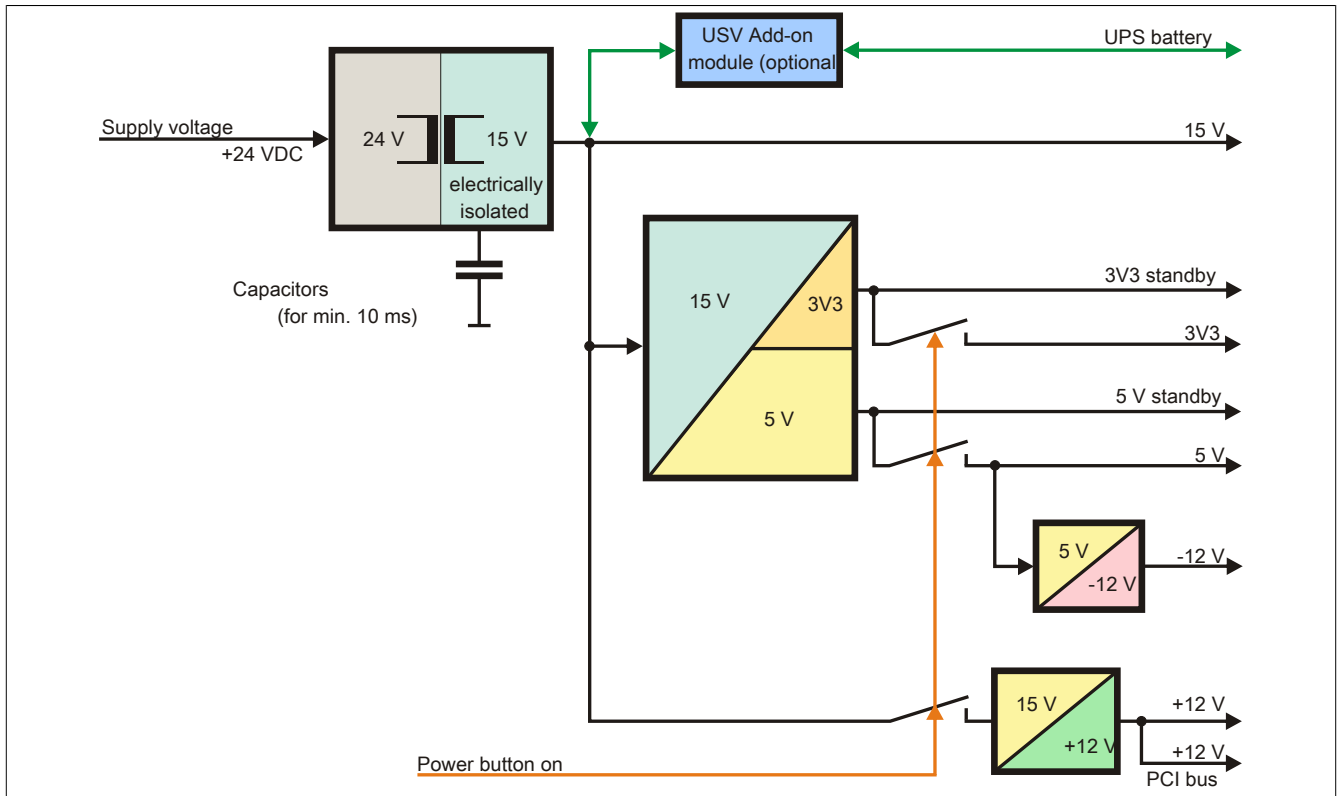

Figure 4: Supply voltage block diagram

Description

15 V is generated from the supply voltage using a DC-to-DC converter. This electrically isolated 15 V supplies additional DC-to-DC converters that generate the remaining voltage.

After the system is turned on (e.g. using the power button), the 3V3 and 5 V voltages are applied to the bus. At the 5 V output, another DC-to-DC converter generates -12 V and applies this to the bus. An additional DC-to-DC converter generates +12 V.

The optional add-on UPS (with battery unit) is supplied with 15 V and provides an uninterrupted power supply of the 15 V bus during a power failure.

2.3.2 Power calculation with 5PC820.1505-00

Information:		CPU board	Current system		
All values in watts The values for the suppliers are maximum values. The values for the consumers are average maximum values, but not peak values.		5PC800.CCAX-00	Enter values in this column		
		Total power supply power (maximum)			
			130		
		Add-on UPS module, optional	7.5		
		Backlight display 15"	14		
		Maximum possible at +12V			
			75		
Total power supply	+12 V	CPU board, permanent consumers	13		
		2048 MB RAM, max. 1 with 3 W each			
		4096 MB RAM, max. 1 with 4 W each			
		Fan kit, optional	2.4		
		Power consumption of the PClec card, optional, max. 4 W ²⁾			
		PCI card limit, optional (max. 3 W without fan kit, max. 6 W with fan kit) ¹⁾			
		PCIe x1 card limit, optional (max. 3 W without fan kit, max. 20 W with fan kit) ¹⁾			
		Consumers +12 V ∑			
				Maximum possible at +5V	
					65
	+5 V	System unit, permanent consumers	4		
		Hard disk (slide-in compact)	4		
		Slide-in drive (hard disk, DVD-ROM, etc.)	4		
		USB peripherals USB2 and USB4 with 2.5 W each			
		USB peripherals USB1, USB3 and USB5 with 5 W each			
		Power consumption of the PClec card, optional, max. 4 W ²⁾			
		PCI card limit, optional (max. 3 W without fan kit, max. 20 W with fan kit) ¹⁾			
		Maximum possible at -12V			
			1.2		
	-12 V	PCI card limit, optional (max. 1.2 W with or without fan kit) ¹⁾			
		Consumers -12 V ∑			
		Consumers +5 V ∑			
		Maximum possible at 3V3			
			40		
	3V3	System unit, permanent consumers	9		
		CompactFlash, 1 W each			
		Power consumption of the PClec card, optional, max. 4 W ²⁾			
		PCI card limit, optional (max. 3 W without fan kit, max. 15 W with fan kit) ¹⁾			
		PCIe x1 card limit, optional (max. 3 W without fan kit, max. 10 W with fan kit) ¹⁾			
		Consumers 3V3 ∑			
		Consumers ∑			

1) The total performance of one PCI/PCIe card per PCI slot (= sum of the power consumption for each voltage range) may not exceed the limits stated for operation with or without a fan kit.

2) The total performance of one PClec card per PClec slot (= sum of the power consumption for each voltage area) may not exceed the limits stated for operation with or without a fan kit.

Table 8: Power calculation for 15" PPC800

Information:

The PClec card must not consume more than a total of 4 W (12 V / 5 V / 3V3)!

2.3.3 Power calculation with 5PC820.1906-00

Information:		CPU board	Current system
All values in watts The values for the suppliers are maximum values. The values for the consumers are average maximum values, but not peak values.		5PC800.CCAX-00	Enter values in this column
Total power supply power (maximum)			130
Add-on UPS module, optional		7.5	
Backlight display 19"		32	
Maximum possible at +12V			75
+12 V	CPU board, permanent consumers	13	
	2048 MB RAM, max. 1 with 3 W each		
	4096 MB RAM, max. 1 with 4 W each		
	Fan kit, optional	2.4	
	Power consumption of the PClec card, optional, max. 4 W ²⁾		
	PCI card limit, optional (max. 3 W without fan kit, max. 6 W with fan kit) ¹⁾		
	PCIe x1 card limit, optional (max. 3 W without fan kit, max. 20 W with fan kit) ¹⁾		
Consumers +12 V ∑			
Maximum possible at +5V			65
+5 V	System unit, permanent consumers	12	
	Hard disk (slide-in compact)	4	
	Slide-in drive (hard disk, DVD-ROM, etc.)	4	
	USB peripherals USB2 and USB4 with 2.5 W each		
	USB peripherals USB1, USB3 and USB5 with 5 W each		
	Power consumption of the PClec card, optional, max. 4 W ²⁾		
	PCI card limit, optional (max. 3 W without fan kit, max. 20 W with fan kit) ¹⁾		
Maximum possible at -12V			1.2
-12 V	PCI card limit, optional (max. 1.2 W with or without fan kit) ¹⁾		
Consumers -12 V ∑			
Consumers +5 V ∑			
Maximum possible at 3V3			40
3V3	System unit, permanent consumers	9	
	CompactFlash, 1 W each		
	Power consumption of the PClec card, optional, max. 4 W ²⁾		
	PCI card limit, optional (max. 3 W without fan kit, max. 15 W with fan kit) ¹⁾		
	PCIe x1 card limit, optional (max. 3 W without fan kit, max. 10 W with fan kit) ¹⁾		
Consumers 3V3 ∑			
Consumers ∑			

1) The total performance of one PCI/PCIe card per PCI slot (= sum of the power consumption for each voltage range) may not exceed the limits stated for operation with or without a fan kit.

2) The total performance of one PClec card per PClec slot (= sum of the power consumption for each voltage area) may not exceed the limits stated for operation with or without a fan kit.

Table 9: Power calculation for 19" PPC800

Information:

The PClec card must not consume more than a total of 4 W (12 V / 5 V / 3V3)!

2.4 Block diagrams

The following block diagrams show the simplified structure of system units (5PC820.1505-00 / 5PC820.1906-00) with a NM10 CPU board that depend on different bus units.

2.4.1 Bus unit 5AC803.BX01-00

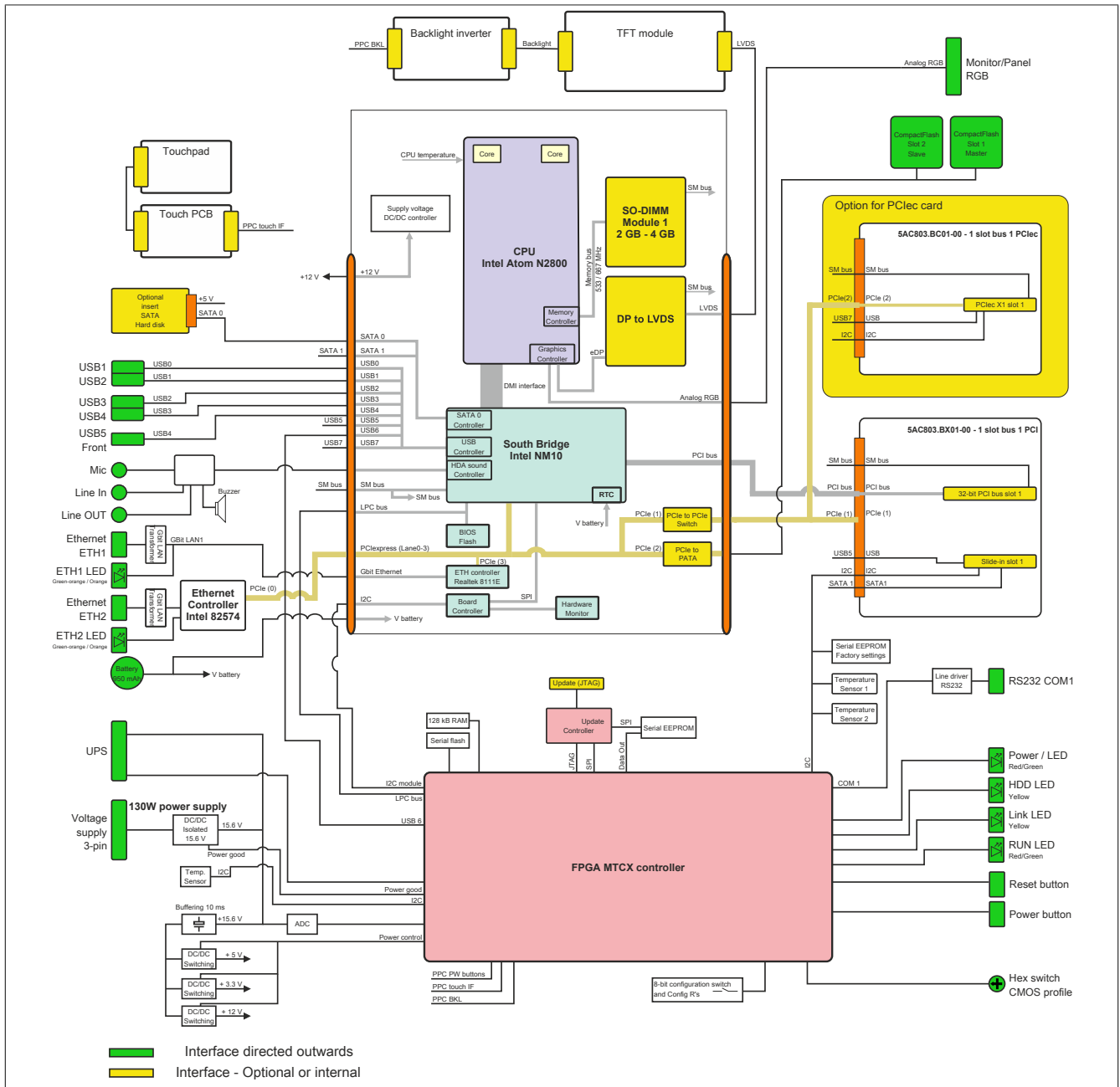

Figure 5: Block diagram with bus unit 5AC803.BX01-00

2.4.2 Bus unit 5AC803.BX01-01

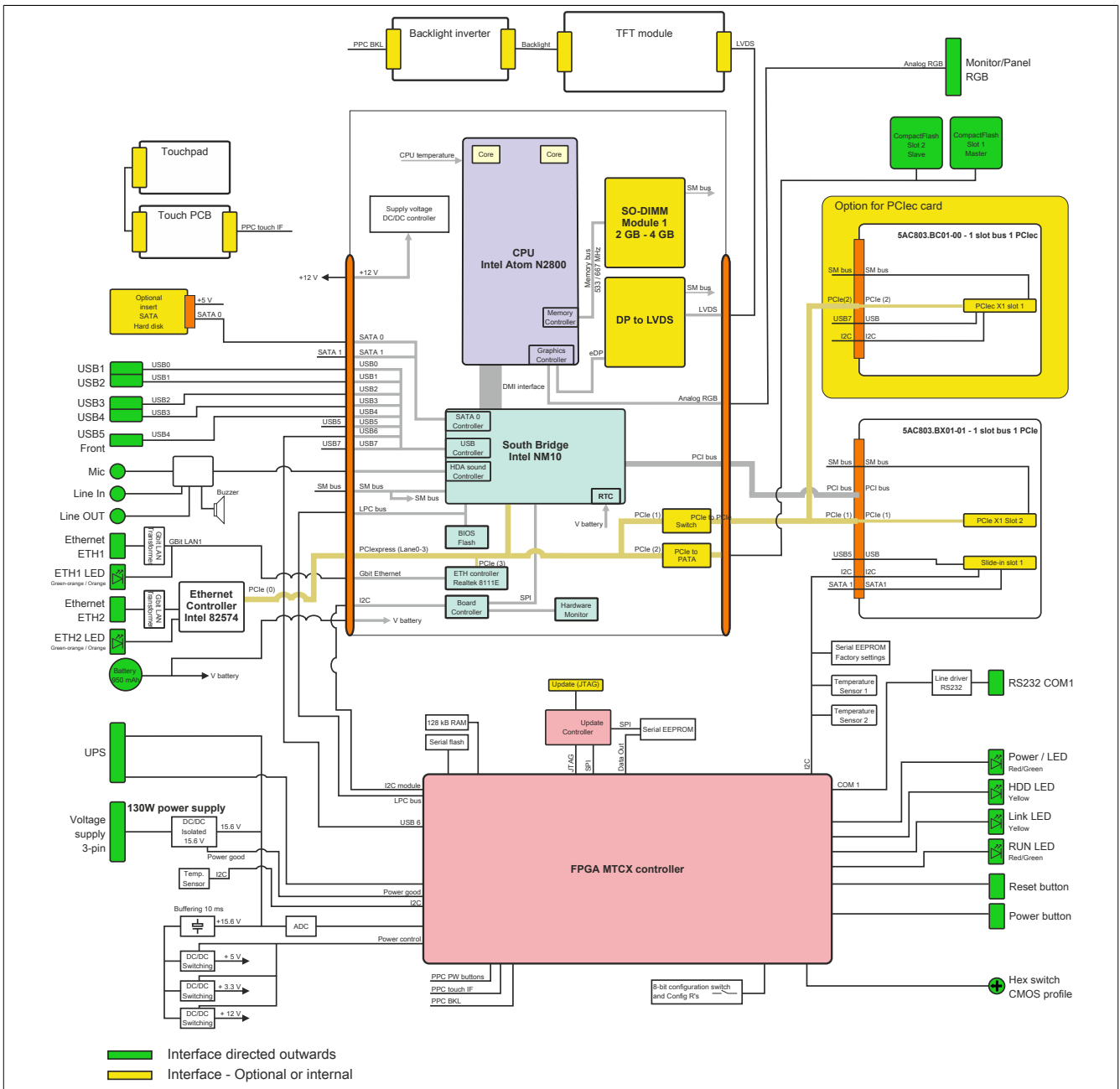

Figure 6: Block diagram with bus unit 5AC803.BX01-01

2.4.3 Bus unit 5AC803.BX02-00

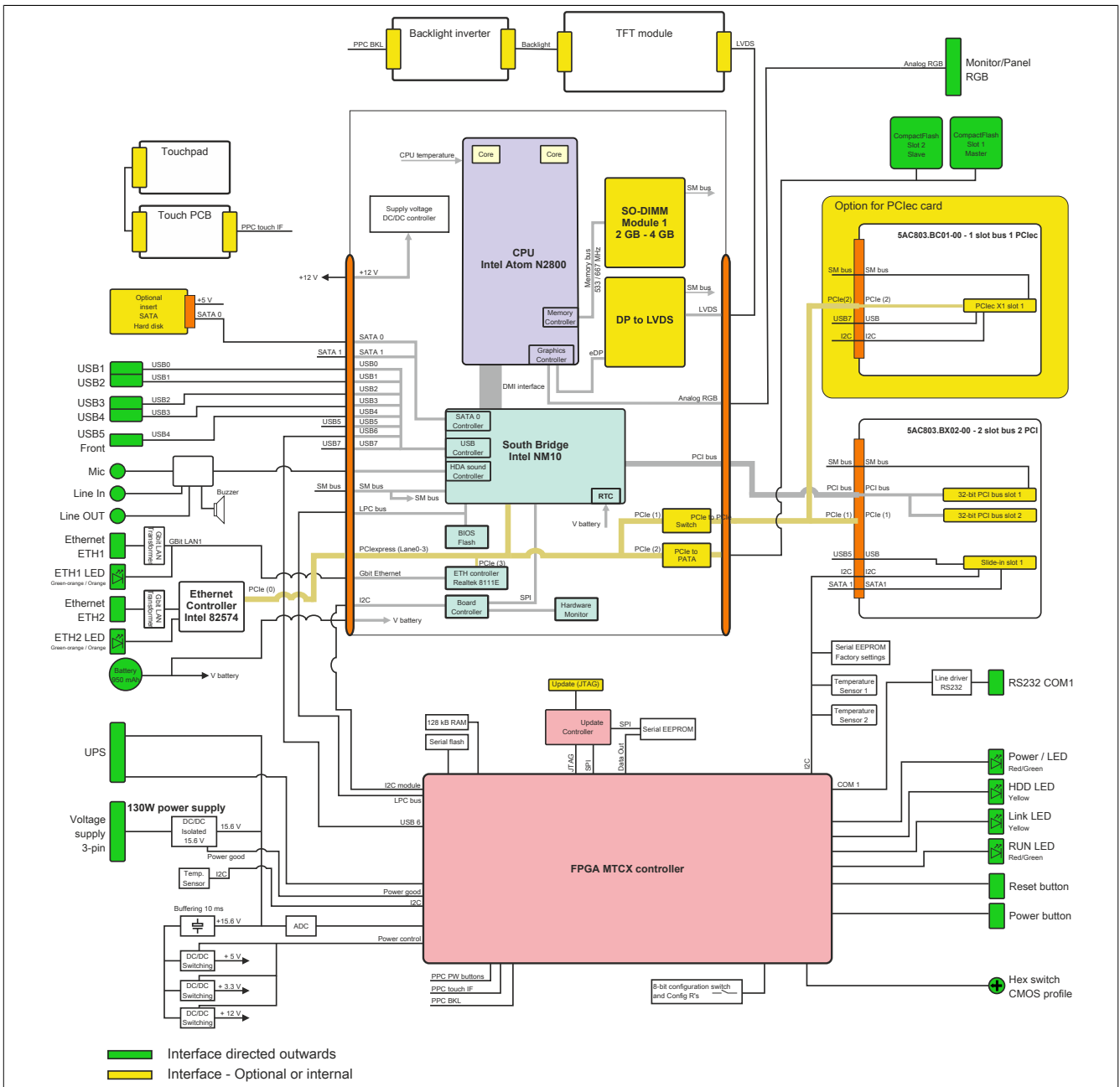

Figure 7: Block diagram with bus unit 5AC803.BX02-00

2.4.4 Bus unit 5AC803.BX02-01

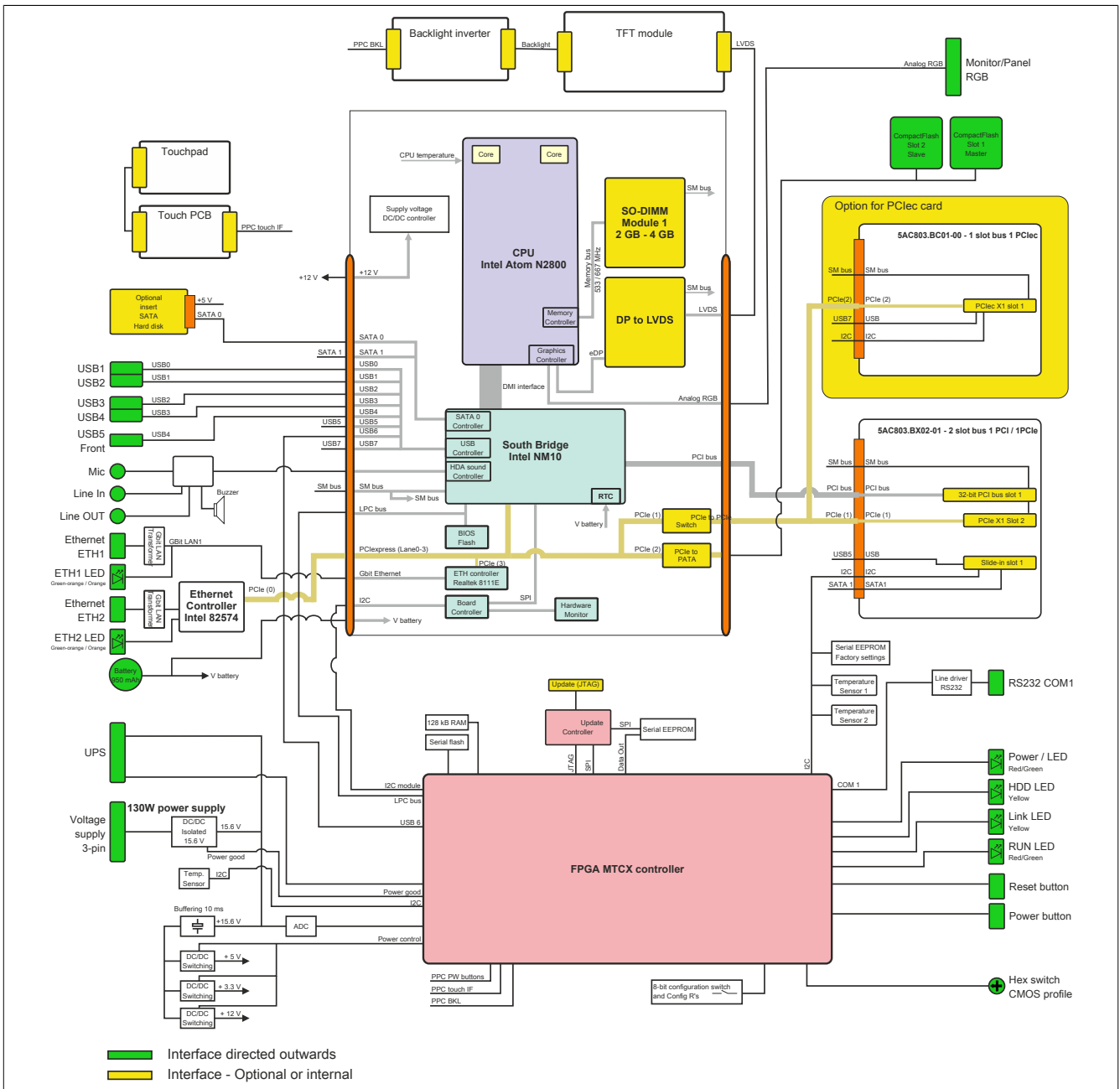

Figure 8: Block diagram with bus unit 5AC803.BX02-01

2.5 Serial number sticker

A unique serial number sticker with a barcode (Code 128) is affixed to each B&R device for identification purposes. This serial number represents all of the individual components built into the system (model number, name, revision, serial number, delivery date and duration of warranty).



Figure 9: Serial number sticker (back)

This information can also be found on the B&R website by entering the serial number of the complete system in the search field tab (after selecting the "Serial number" option) at the top of the website (www.br-automation.com). The search provides a detailed list of installed components.

Serial number entered h z.B.: AF210168454

wecheln auf den Tab „Serialnummer“

List of installed components shown after searching for a serial nu

SERIAL	MATERIAL	REVISION	LIEFERUNG	GEWAHRLEISTUNGSENDE
B15B0168428	5PCB220198 001-00	C0	*NV	*N/A
AF210168454	5PC820 1505-00	A2	*NV	*N/A
A3CA0168483	5PC800 B945-00	C0	*NV	*N/A
A3E50168807	5MMD0R 0512-01	B0	*NV	*N/A
AF270168430	5AC803 SX01-00	A0	*NV	*N/A
AF290168515	5AC803 BX01-00	A5	*NV	*N/A
AF2E0168475	5AC803 BC02-00	A5	*NV	*N/A
AF2D0168456	5AC803 BC01-00	A5	*NV	*N/A
AF300168466	5AC803 FA02-00	A0	*NV	*N/A
AF230168467	5AC803 HS00-00	A5	*NV	*N/A

Figure 10: Example of serial number search

2.6 Device interfaces and slots

2.6.1 +24 VDC power supply

The 3-pin male connector required for the power supply interface is not included in delivery. It can be ordered from B&R using model number 0TB103.9 (screw clamp) or 0TB103.91 (cage clamp).

The pinout is listed in the following table and printed on the PPC800 housing. The supply voltage is protected internally by a soldered fuse (15 A, fast-acting) to prevent damage to the device in the event of an overload (fuse replacement necessary) or if the voltage supply is connected incorrectly (reverse polarity protection - fuse replacement not necessary). The device must be returned to B&R for repairs if the fuse is blown in the event of an error.

Power supply		Buchse, 3-polig, male +24 VDC power supply 
Protected against reverse polarity		
Pin	Description	
1	+	
2	Functional ground	
3	-	
Model number	Short description	
Terminal blocks		
0TB103.9	Male connector 24 V 5.08 3-pin screw clamps	
0TB103.91	Male connector 24 V 5.08 3-pin cage clamps	

Table 10: 24 VDC power supply interface

2.6.1.1 Grounding

Caution!

Functional ground (pin 2 of power supply and ground connection) must be kept as short as possible and connected to the largest possible wire cross section at the central grounding point (e.g. the control cabinet or system).

The ground connection is located at the top right on the back of the PPC800 system.

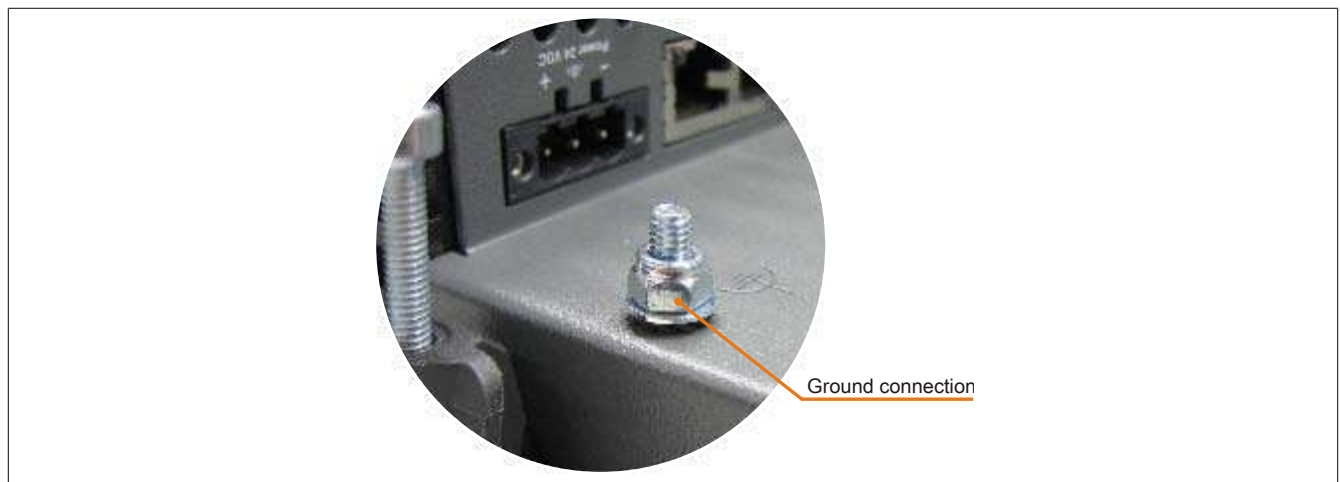

Figure 11: Ground connection

The M4 self-locking nut must be used, for example, to fasten a copper strip to a central grounding point in the control cabinet or system where the PPC800 is installed. The largest possible conductor cross section should be used (at least 2.5 mm²).

2.6.2 Monitor/Panel interface - RGB

Monitor/Panel interface - RGB	
The following is an overview of the video signals available on the monitor/panel output. For details, see the technical data for the CPU board being used.	
CPU board	Video signals with all system unit variants
5PC800.CCAX-00	RGB



Table 11: Monitor/Panel interface - RGB

Information:

The RGB interface uses an analog signal; the line length depends on the resolution and prevailing environmental conditions. This interface is therefore only recommended for service purposes.

2.6.2.1 Pinout

Pin	Assignment	Description	Pin	Assignment	Description
1	NC	Not connected	16	HPD	Hot plug detect
2	NC	Not connected	17	NC	Not connected
3	NC	Not connected	18	NC	Not connected
4	NC	Not connected	19	NC	Not connected
5	NC	Not connected	20	NC	Not connected
6	DDC clock	DDC-based control signal (clock)	21	NC	Not connected
7	DDC data	DDC-based control signal (data)	22	NC	Not connected
8	Analog V-Sync	Analog vertical synchronization	23	NC	Not connected
9	NC	Not connected	24	NC	Not connected
10	NC	Not connected	C1	ANALOG RED	Analog red
11	NC	Not connected	C2	ANALOG GREEN	Analog green
12	NC	Not connected	C3	ANALOG BLUE	Analog blue
13	NC	Not connected	C4	ANALOG HORZ SYNC	Analog horizontal synchronization
14	+5 V power ¹⁾	+5 V power supply	C5	ANALOG GND	Analog ground (return for R, G and B signals)
15	Ground (return for +5 V, HSync and VSync)	Ground			

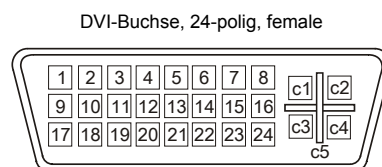

Table 12: Pinbelegung DVI-Anschluss

1) Protected internally by a multifuse.

2.6.3 COM1 serial interface

COM1 serial interface ¹⁾	
RS232	
Type	RS232, modem-capable, not electrically isolated
UART	16550-compatible, 16-byte FIFO
Transfer rate	Max. 115 kbaud
Cable length	Max. 15 meters
Pin	Assignment
1	DCD
2	RXD
3	TXD
4	DTR
5	GND
6	DSR
7	RTS
8	CTS
9	RI

DSUB-Buchse, 9-polig, male

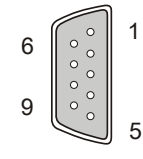

The diagram shows a 9-pin male D-sub connector. The pins are arranged in a vertical row. The numbering is as follows: Pin 1 is at the top right, Pin 2 is below it, Pin 3 is below Pin 2, Pin 4 is below Pin 3, Pin 5 is at the bottom right, Pin 6 is at the top left, Pin 7 is below it, Pin 8 is below Pin 7, and Pin 9 is at the bottom left.

Table 13: COM1 - Pinout

1) The interfaces, etc. available on the device or module have been numbered as such for easy identification. This numbering may differ from that used by the particular operating system.

2.6.4 Ethernet 1 (ETH1)

This Ethernet controller is integrated in the CPU board and connected to external devices via the system unit.

Ethernet 1 interface (ETH1) ¹⁾		
Controller	RTL 8111E	
Cabling	S/STP (Cat 5e)	
Transfer rate	10/100/1000 Mbit/s ²⁾	
Cable length	Max. 100 m (min. Cat 5e)	
Speed LED	On	Off
Green	100 Mbit/s	10 Mbit/s ³⁾
Orange	1000 Mbit/s	-
Link LED	On	Off
Orange	Link (Ethernet network connection available)	Activity (blinking) (Data transfer in progress)

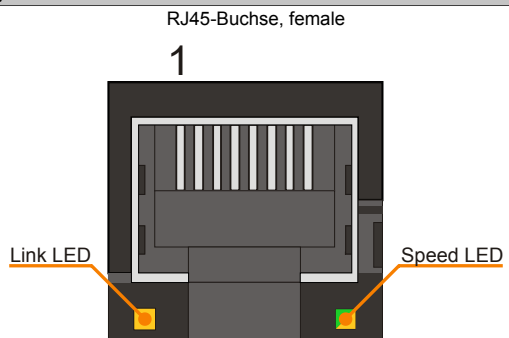

Table 14: Ethernet interface (ETH1)

- 1) The interfaces, etc. available on the device or module have been numbered as such for easy identification. This numbering may differ from that used by the particular operating system.
- 2) Switching takes place automatically.
- 3) The 10 Mbit/s transfer speed / connection only exists if the Link LED is also lit at the same time.

Driver support

A special driver is required in order to operate the Realtek 8111E Ethernet controller. Drivers for approved operating systems are available in the Downloads section of the B&R website (www.br-automation.com).

Information:

Required drivers can only be downloaded from the B&R website, not from manufacturer websites.

Dieser Ethernet-Controller ist im Basisboard integriert und wird über die Systemeinheit nach außen geführt.

Ethernet-Schnittstelle (ETH2) ¹⁾		
Controller	Intel 82574	
Cabling	S/STP (Cat 5e)	
Transfer rate	10/100/1000 Mbit/s ²⁾	
Cable length	Max. 100 m (min. Cat 5e)	
Speed LED	On	Off
Green	100 Mbit/s	10 Mbit/s ³⁾
Orange	1000 Mbit/s	-
Link LED	On	Off
Orange	Link (Ethernet network connection available)	Activity (blinking) (data transfer in progress)

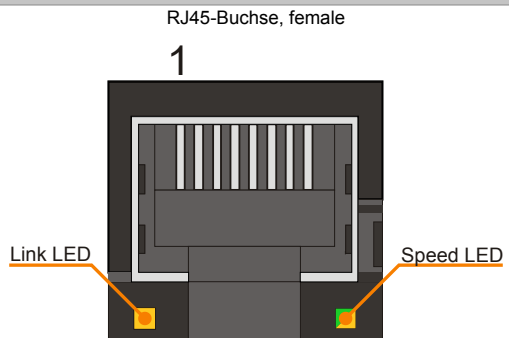

Table 15: Ethernet-Schnittstelle (ETH2)

- 1) The interfaces, etc. available on the device or module have been numbered as such for easy identification. This numbering may differ from that used by the particular operating system.
- 2) Switching takes place automatically.
- 3) The 10 Mbit/s transfer speed / connection only exists if the Link LED is also lit at the same time.

Driver support

A special driver is required in order to operate the Intel 82574 Ethernet controller. Drivers for approved operating systems are available in the Downloads section of the B&R website (www.br-automation.com).

Information:

Required drivers can only be downloaded from the B&R website, not from manufacturer websites.

The PPC800 features a USB 2.0 (Universal Serial Bus) host controller with multiple USB ports, 5 of which are accessible externally for the user.

Warning!

Peripheral USB devices can be connected to the USB interfaces on this device. Due to the vast number of USB devices available on the market, B&R cannot guarantee their performance. All USB devices provided by B&R are guaranteed to function properly.

Caution!

Because this interface is designed according to general PC specifications, extreme care should be exercised with regard to EMC, cable routing, etc.

USB1,2,3,4

Universal Serial Bus (USB1, USB2, USB3, USB4 ¹⁾)	
Type	USB 2.0
Design	Type A
Transfer rate	Low speed (1.5 Mbit/s), full speed (12 Mbit/s), high speed (480 Mbit/s)
Current load ²⁾ USB1, USB3 USB2, USB4	Max. 1 A Max. 500 mA
Cable length	Max. 5 m (without hub)

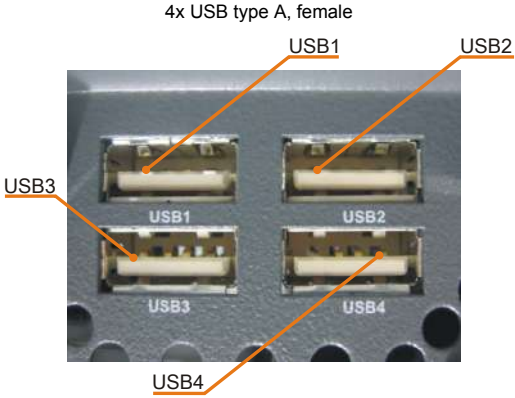

Table 16: USB1-, USB2-, USB3-, USB4-Schnittstellen

- 1) The interfaces, etc. available on the device or module have been numbered as such for easy identification. This numbering may differ from that used by the particular operating system.
- 2) Each USB port is protected by a maintenance-free "USB current limiting circuit breaker" (max. 500 mA or 1 A).

USB5

Universal Serial Bus (USB5) ¹⁾	
Type	USB 2.0
Design	Type A
Transfer rate	Low speed (1.5 Mbit/s), full speed (12 Mbit/s), high speed (480 Mbit/s)
Current load ²⁾ USB5	Max. 1 A
Cable length	Max. 5 m (without hub)

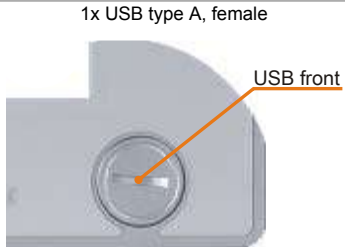

Table 17: USB5-Schnittstelle

- 1) The interfaces, etc. available on the device or module have been numbered as such for easy identification. This numbering may differ from that used by the particular operating system.
- 2) Each USB port is protected by a maintenance-free "USB current-limiting circuit breaker" (max. 1 A).

2.6.7 CompactFlash slot 1

This CompactFlash slot is a standard component on an PPC800 system and internally connected with the chipset via PCIe to PATA bridge. Type I CompactFlash cards are supported.

CompactFlash slot (CF1)	
Connection	PCIe to PATA
CompactFlash Type	Type I
Model number	Short description
CompactFlash	
5CFCRD.0512-06	CompactFlash 512 MB B&R
5CFCRD.1024-06	CompactFlash 1024 MB B&R
5CFCRD.2048-06	CompactFlash 2048 MB B&R
5CFCRD.4096-06	CompactFlash 4096 MB B&R
5CFCRD.8192-06	CompactFlash 8192 MB B&R
5CFCRD.016G-06	CompactFlash 16 GB B&R
5CFCRD.032G-06	CompactFlash 32 GB B&R
5CFCRD.0064-03	CompactFlash 64 MB WD
5CFCRD.0128-03	CompactFlash 128 MB WD
5CFCRD.0256-03	CompactFlash 256 MB WD
5CFCRD.0512-03	CompactFlash 512 MB WD
5CFCRD.1024-03	CompactFlash 1024 MB WD
5CFCRD.2048-03	CompactFlash 2048 MB WD
5CFCRD.4096-03	CompactFlash 4096 MB WD
5CFCRD.8192-03	CompactFlash 8192 MB WD



Table 18: CompactFlash slot (CF1)

Warning!

Power must be turned off before inserting or removing CompactFlash cards.

2.6.8 CompactFlash slot 2

This CompactFlash slot is a standard component on an PPC800 system and internally connected with the chipset via PCIe to PATA bridge. Type I CompactFlash cards are supported.

CompactFlash slot (CF2)	
Connection	PCIe to PATA
CompactFlash Type	Type I
Model number	Short description
CompactFlash	
5CFCRD.0512-06	CompactFlash 512 MB B&R
5CFCRD.1024-06	CompactFlash 1024 MB B&R
5CFCRD.2048-06	CompactFlash 2048 MB B&R
5CFCRD.4096-06	CompactFlash 4096 MB B&R
5CFCRD.8192-06	CompactFlash 8192 MB B&R
5CFCRD.016G-06	CompactFlash 16 GB B&R
5CFCRD.032G-06	CompactFlash 32 GB B&R
5CFCRD.0064-03	CompactFlash 64 MB WD
5CFCRD.0128-03	CompactFlash 128 MB WD
5CFCRD.0256-03	CompactFlash 256 MB WD
5CFCRD.0512-03	CompactFlash 512 MB WD
5CFCRD.1024-03	CompactFlash 1024 MB WD
5CFCRD.2048-03	CompactFlash 2048 MB WD
5CFCRD.4096-03	CompactFlash 4096 MB WD
5CFCRD.8192-03	CompactFlash 8192 MB WD



Table 19: CompactFlash slot (CF2)

Warning!

An- und Abstecken der CompactFlash-Karte darf nur in spannungslosem Zustand erfolgen!

2.6.9 MIC, Line IN, Line OUT

All PPC800 systems include an HDA-compatible sound chip with access to the MIC, Line IN and Line OUT channels from the outside.

MIC, Line IN, Line OUT		3.5 mm jack, female
Controller	Realtek ALC 662	
MIC	Connection of a mono microphone with a 3.5 mm jack	
Line IN	Stereo Line IN signal supplied via a 3.5 mm jack	
Line OUT	Connection of a stereo playback device (e.g. amplifier) via a 3.5 mm jack	

Table 20: MIC, Line IN, Line OUT

Driver support

A special driver is required in order to operate the audio controller. Drivers for approved operating systems are available in the Downloads section of the B&R website (www.br-automation.com).

Information:

Required drivers can only be downloaded from the B&R website, not from manufacturer websites.

2.6.10 Add-on UPS slot

An optional Automation PC add-on UPS module can be installed in this slot.

Add-on UPS slot		
Pinout with installed add-on UPS module		
1	+	
2	+	
3	-	
4	-	
5	NTC (for battery temperature measurement)	
6	NTC (for battery temperature measurement)	
Model number	Short description	
Uninterruptible power supply		
5AC600.UPSI-00	Add-on UPS module	
5AC600.UPSB-00	Battery unit 5 Ah	
5CAUPS.0005-00	UPS cable 0.5 m	
5CAUPS.0030-00	UPS cable 3 m	

Table 21: Add-on UPS slot

For additional information about the UPS module, see "Accessories" on page 234.

2.6.11 Power button

Auf Grund der vollen ATX-Netzteilunterstützung besitzt der Power Taster verschiedenste Funktionalitäten.

Power button	
<p>Der Power Taster verhält sich wie z.B. der Netzschalter bei aktuellen Desktop PCs mit ATX-Netzteil:</p> <p>Pressing the power button does not reset the MTCX processor.</p>	

Table 22: Power button

2.6.12 Reset button

Reset button	
<p>Pushing the reset button triggers a hardware and PCI reset. The PPC800 is restarted (cold restart).</p> <p>Pressing the reset button does not reset the MTCX processor.</p>	

Table 23: Reset button

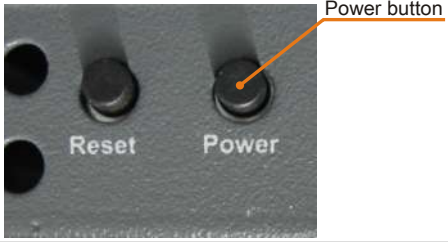
Warning!

A system reset can result in lost data!

2.6.13 LED status indicators

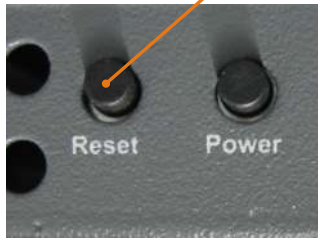
LED status indicators are located on the back of the system unit.

LED status indicators			
LED	Color	Status	Description
Power	Green	On	Supply voltage OK
	Red	On	System in standby mode (S5: Soft-off mode, S4: Hibernation mode suspend-to-disk or S3: Suspend-to-RAM)
	Orange ¹⁾	On	Supply voltage not OK, system operating on battery power
	Red/Green	Blinking	Service function for MTCX upgrade: A red/green blinking power LED indicates a faulty or incomplete MTCX upgrade. The MTCX runs using the firmware version installed when delivered. This could be caused by a power failure during an MTCX upgrade. An MTCX upgrade must be performed again.
HDD	Yellow	On	Indicates IDE drive access (CF, HDD, CD, etc.)
Link	Yellow	On	Indicates an active SDL connection on the monitor/panel interface
		Blinking	Indicates that an active SDL connection has been interrupted by a loss of power to the display unit
Run	Green	On	Application running
		Off	Application not running

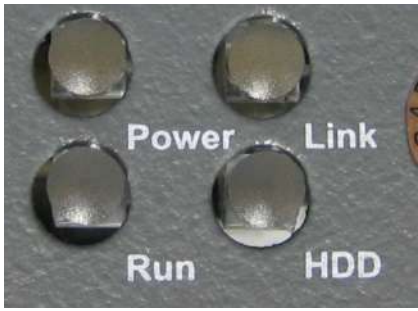

Table 24: LED status indicators

1) Only lit when an add-on UPS module is installed.

2.6.14 CMOS profile switch

CMOS profile switch	
Different BIOS default value profiles can be specified using the 16-position CMOS profile switch.	
Switch position	Description
0	Profile 0: Reserved for default profile
5	Profile 5: Optimized for system units 5PC820.1505-00 and 5PC820.1906-00



Table 25: CMOS profile switch

Information:

The factory default switch position represents the optimal BIOS default values for this system and should therefore not be changed.

The position of the CMOS profile switch is displayed in BIOS Setup and in the B&R ADI Control Center (among other places).

2.6.15 Battery

The lithium battery (3 V, 950 mAh) buffers the internal real-time clock (RTC) and individually stored BIOS settings. It is located behind the black cover on the front of the device. The battery's buffer lifespan is at least 2½ years (at 50°C, 8.5 µA for the components being supplied and a self-discharge of 40%). The battery has a limited service life and should be replaced regularly (after the specified service life at the latest).

Battery		
Battery Type	Renata 950 mAh	
Removable	Yes, accessible from the outside	
Service life	2½ years ¹⁾	
Model number	Short description	
	Batteries	
0AC201.91	Lithium batteries, 4 pcs., 3 V / 950 mAh, button cell	
4A0006.00-000	Lithium battery, 1 pc., 3 V / 950 mAh, button cell	

Table 26: Battery

1) At 50°C, 8.5 µA of the supplied components and a self-discharge of 40%.

Evaluating the battery status

The status of the battery is determined immediately after the device is started and subsequently checked by the system every 24 hours. During this measurement, the battery is subjected to a brief load (approximately 1 second) and then evaluated. Once determined, the battery status is displayed in BIOS (Advanced - OEM features - System board features - Voltage values) and in the B&R Control Center (ADI driver); it can also be read in a customer application using the ADI library.

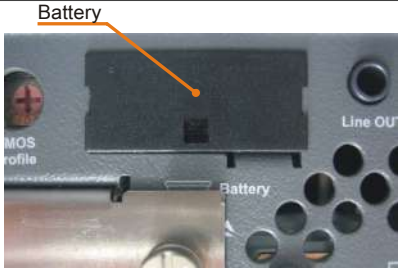
Battery status	Function
N/A	The hardware or firmware being used is too old and does not support reading the battery status.
GOOD	Data buffering is intact.
BAD	From the point when battery capacity is recognized as insufficient (BAD), data buffering is intact for approximately another 500 hours.

Table 27: Battery status

From the point when battery capacity is recognized as insufficient, data buffering is intact for approximately another 500 hours. When replacing the battery, data is buffered for approximately 10 minutes by a gold leaf capacitor.

2.6.16 Slide-in compact slot

The internal connection between the slide-in compact slot and the chipset is made via SATA II.

Slide-in compact slot	
Connection	SATA II
Model number	Short description
Adapters	
5AC803.BC02-00	PPC800 1 slide-in compact adapter
Drives	
5AC801.HDDI-00	40 GB SATA hard disk, slide-in compact, 24/7 operation with extended temperature range. Note: Please see the manual for information about using this hard disk.
5AC801.HDDI-03	250 GB SATA hard disk, slide-in compact, 24/7 operation. Note: Please see the manual for information about using this hard disk.
5AC801.HDDI-04	500 GB SATA hard disk, slide-in compact, 24/7 operation. Note: Please see the manual for information about using this hard disk.
5AC801.SSDI-00	32 GB SATA SSD (SLC), slide-in compact
5AC801.SSDI-01	60 GB SATA SSD (SLC), slide-in compact
5AC801.SSDI-02	180 GB SATA SSD (SLC), slide-in compact
5AC801.SSDI-03	60 GB SATA SSD (SLC), slide-in compact
5AC801.SSDI-04	128 GB SATA SSD (SLC), slide-in compact
5AC801.SSDI-05	256 GB SATA SSD (SLC), slide-in compact



Table 28: Slide-in compact slot

Information:

The adapter 5AC803.BC02-00 is required for the use of slide-in compact drives.

Information:

The SATA II interface allows disks to be replaced during operation (hot plugging). In order to take advantage of this capability, this feature must be supported by the operating system.

2.6.17 PClec slot (Card slot)

PClec slot	
Model number	Short description
Adapters	
5AC803.BC01-00	PPC800 1 PCI Express compact adapter
Plug-in cards	
5ACPCC.ETH0-00	Compact PCIe Ethernet card 1x 10/100/1000
5ACPCC.MPL0-00	PClec POWERLINK card, 2 POWERLINK interfaces, 512 kB SRAM



Table 29: PClec slot

Information:

The adapter 5AC803.BC01-00 is required to use PClec plug-in cards.

Information:

Only B&R PClec cards that have been specially designed for the Automation PC 820 and Panel PC 800 can be used.

For more information, see "PClec plug-in cards" on page 70.

3 Individual components

3.1 System units

3.1.1 5PC820.1505-00

3.1.1.1 General information

- 15" TFT XGA color display
- Analog resistive touch screen
- Robust design
- Compact installation depth
- Fanless operation
- 1 optional PCI Express compact slot
- 1 optional slide-in compact slot
- Optional PCI and PCIe slots and optional slide-in drives, optional expansions available

3.1.1.2 Order data

Model number	Short description	Figure
	System units	
5PC820.1505-00	Panel PC 820 15" XGA TFT display with touch screen (resistive); connections for 1x RS232, 5x USB 2.0, Smart Display Link/DVI/Monitor, 2x Ethernet 10/100/1000, HDA sound, add-on UPS slot, expandable with 1 or 2 PCI / PCI Express slots, optional CompactPCI Express and slide-in compact slot; IP65 protection (front); order 24 VDC connector for supply voltage separately (screw clamp: 0TB103.9; cage clamp: 0TB103.91)	
	Required accessories	
	CPU boards	
5PC800.CCAX-00	Intel Atom N2800 CPU board, 1.86 GHz, dual core, 533 MHz FSB, 1 MB L2 cache; NM10 chipset; 1 slot for SO-DIMM DDR3 module	
	Terminal blocks	
0TB103.9	Connector, 24 VDC, 3-pin female, 3.31 mm ² screw clamp, protected against vibration by the screw flange	
0TB103.91	Connector, 24 VDC, 3-pin female, 3.31 mm ² cage clamp, protected against vibration by the screw flange	
	Main memory	
5MMDDR.2048-02	SO-DIMM DDR3 RAM 2048 MB PC3-8500	
5MMDDR.4096-02	SO-DIMM DDR3 RAM 4096 MB PC3-8500	
	Heat sink	
5AC803.HS00-04	PPC800 heat sink for CPU board with Atom dual-core processor N2800.	
	Optional accessories	
	Adapters	
5AC803.BC01-00	1 compact PCI Express PPC800 adapter	
5AC803.BC02-00	1 compact slide-in PPC800 adapter	
	Bus units	
5AC803.BX01-00	PPC800 bus; 1 PCI, 1 slide-in slot	
5AC803.BX01-01	PPC800 bus; 1 PCI Express, 1 slide-in slot	
5AC803.BX02-00	PPC800 bus; 2 PCI, 1 slide-in slot	
5AC803.BX02-01	PPC800 bus; 1 PCI, 1 PCI Express, 1 slide-in slot	
	Plug-in cards	
5ACPCC.ETH0-00	PCIEc Ethernet card 1x 10/100/1000 For APC820 and PPC800.	
5ACPCC.MPL0-00	PCIEc POWERLINK card, 2 POWERLINK interfaces, 512 kB SRAM; for APC820 and PPC800.	
	Expansions	
5AC803.SX01-00	PPC800 expansion; 1 PCI/PCI Express and 1 slide-in slot (bus 5AC803.BX01-00 or 5AC803.BX01-01 required)	
5AC803.SX02-00	PPC800 expansion; 2 PCI/PCI Express and 1 slide-in slot (bus 5AC803.BX02-00 or 5AC803.BX02-01 required)	
	Drives	
5AC801.ADAS-00	SATA hard disk adapter for operating a slide-in compact hard disk in a slide-in slot	
5AC801.DVDS-00	DVD-ROM SATA slide-in drive	
5AC801.DVRS-00	DVD-R/RW DVD+R/RW SATA drive, slide-in	
5AC801.HDDI-00	40 GB slide-in compact SATA hard disk, 24/7 operation with extended temperature range. Note: Please see the manual for information about using this hard disk.	

Table 30: 5PC820.1505-00 - Order data

Model number	Short description	Figure
5AC801.HDDI-04	500 GB slide-in compact SATA hard disk; 24/7 operation. Note: Please see the manual for information about using this hard disk.	
5AC801.HDDS-00	40 GB slide-in SATA hard disk; 24/7 operation with extended temperature range. Note: Please see the manual for information about using this hard disk.	
5AC801.SSDI-03	60 GB SATA SSD (MLC), slide-in compact	
5AC801.SSDI-04	128 GB SATA SSD (MLC), slide-in compact	
5AC801.SSDI-05	256 GB SATA SSD (MLC), slide-in compact	
Fan kit		
5AC803.FA01-00	PPC800 fan kit for system units without an expansion	
5AC803.FA02-00	PPC800 fan kit for system units with expansion 5AC803.SX01-00	
5AC803.FA03-00	PPC800 fan kit for system units with expansion 5AC803.SX02-00	
Uninterruptible power supply		
5AC600.UPSI-00	UPS module for APC620, APC810, PPC800; for system units 5PC600.SX01-00 (starting with Rev. H0), 5PC600.SX02-00 (starting with Rev. G0), 5PC600.SX02-01 (starting with Rev. H0), 5PC600.SX05-00 (starting with Rev. F0), 5PC600.SX05-01 (starting with Rev. F0), 5PC600.SF03-00 (starting with Rev. A0), 5PC810.SX*. 5PC820.1505-00, 5PC820.1906-00. Order cable (5CAUPS.0005-00 or 5CAUPS.0030-00) and battery unit (5AC600.UPSB-00) separately	

Table 30: 5PC820.1505-00 - Order data

3.1.1.3 Interfaces

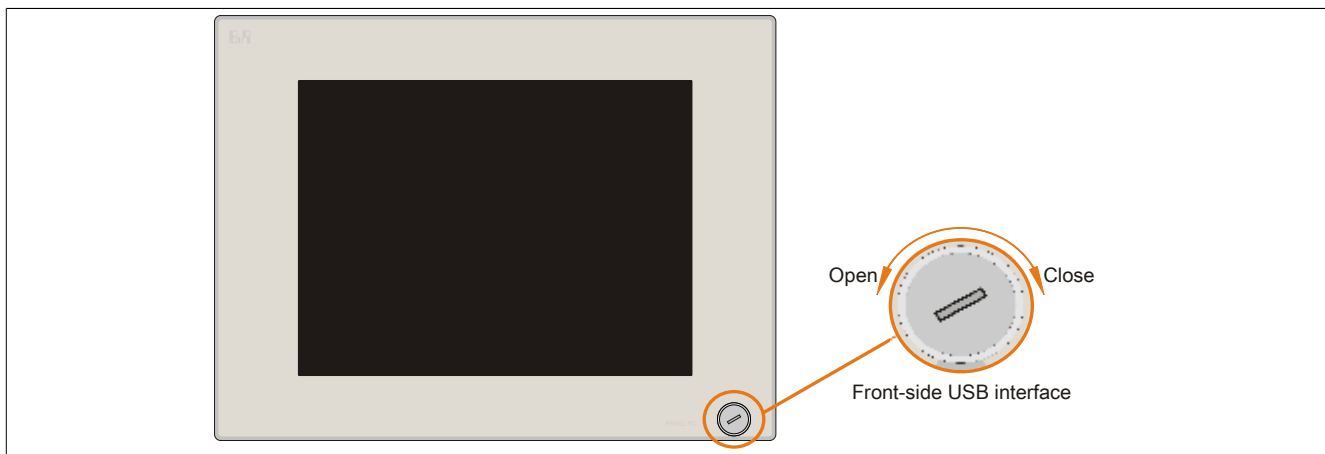

Figure 12: 5PC820.1505-00 - Front view

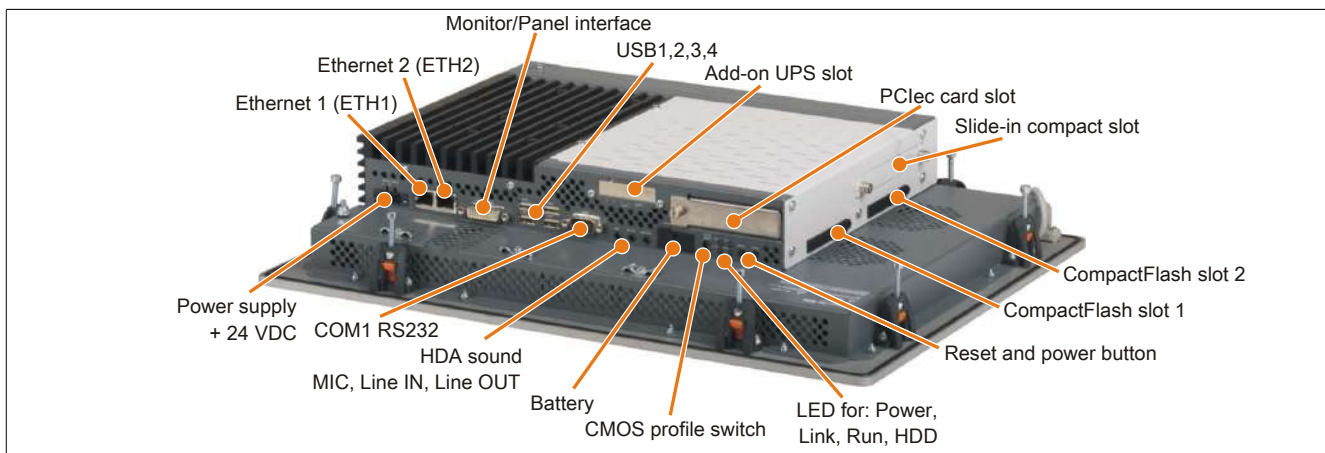

Figure 13: 5PC820.1505-00 - Rear view

Warning!

Do not remove the fastening screws from the heat sink since this component is connected to the processor and chipset via a thermal coupling. If this connection is interrupted, the B&R Industrial PC must be sent back to the factory for repair. Removing the fastening screws (protected by a seal) voids all warranty.

During operation, surface temperatures of the heat sink may reach 70°C ("hot surface" warning).

3.1.1.4 Technical data

Product ID	5PC820.1505-00	
Revision	C0	F0
General information		
LEDs	Power, HDD, Link, Run	
B&R ID code	0xAF21	
Battery		
Type	Renata 950 mAh	
Service life	2½ years	
Removable	Yes, accessible from the outside	
Execution	Lithium ion	
Power button	Yes	
Reset button	Yes	
Buzzer	Yes	
Certification		
CE	Yes	
cULus	Yes	
GOST-R	Yes	
Controller		
Boot loader	BIOS	

Table 31: 5PC820.1505-00, 5PC820.1505-00 - Technical data

Product ID		5PC820.1505-00	
Power failure logic			
Controller		MTCX ¹⁾	
Buffer time		10 ms	
Graphics			
Controller		Depends on the CPU board being used	
Memory			
Type		Depends on the CPU board being used	
Memory size		Depends on the CPU board being used	
Interfaces			
COM1			
Type		RS232, modem-capable, not electrically isolated	
Execution		9-pin male DSUB connector	
UART		16550-compatible, 16-byte FIFO	
Max. baud rate		115 kbit/s	
CompactFlash slot 1			
Type		Type I	
CompactFlash slot 2			
Type		Type I	
USB			
Quantity		5	
Type		USB 2.0	
Execution		Type A	
Transfer rate		Low speed (1.5 Mbit/s), full speed (12 Mbit/s), high speed (480 Mbit/s)	
Current load		Max. 500 mA or 1 A per connection	
Ethernet			
Quantity		2	
Execution		Shielded RJ45 port	
Transfer rate		10/100/1000 Mbit/s	
Audio			
Type		HDA sound	
Inputs		Microphone, Line IN	
Outputs		Line OUT	
Display			
Type		Color TFT	
Display size		15" (381 mm)	
Colors		16 million	
Resolution		XGA, 1024 x 768 pixels	
Contrast		550:1	800:1
Viewing angles			
Horizontal		Direction R = 60° / Direction L = 60°	Direction R = 80° / Direction L = 80°
Vertical		Direction U = 45° / Direction D = 55°	Direction U = 80° / Direction D = 80°
Backlight			
Type		CCFL	LED
Brightness		250 cd/m ²	350 cd/m ²
Half-brightness time ²⁾		50,000 h	
Touch screen ³⁾			
Type		AMT	
Technology		Analog, resistive	
Controller		Elo, serial, 12-bit	
Transmittance		81% ±3%	
Inserts			
PCI slots			
Quantity		1 or 2 (optional) ⁴⁾	
PCIe slots			
Quantity		1 ⁵⁾	
PCIec slots			
Quantity		Optional ⁶⁾	
Slide-in drives		Depends on the component (on the expansion and bus unit being used)	
Slide-in compact drives		Optional ⁷⁾	
Add-on UPS slot		Yes	
Insert for fan kit		Yes	
Electrical characteristics			
Nominal voltage		24 VDC ±25%	
Nominal current		6 A	
Starting current		Typ. 10 A, max. 50 A for <300 µs	
Power consumption		Depends on the component	
Electrical isolation		Yes	
Operating conditions			
Height of drop		1 m on industrial surfaces (in original packaging)	
EN 60529 protection		Back: IP20 Front: IP65, dust and sprayed water protection	

Table 31: 5PC820.1505-00, 5PC820.1505-00 - Technical data

Product ID	5PC820.1505-00
Environmental conditions	
Temperature	
Operation	Depends on the component
Storage	-20 to 60°C
Transport	-20 to 60°C
Relative humidity	
Operation	10 to 85%, non-condensing
Storage	T ≤ 40°C: 5 to 90%, non-condensing T > 40°C: <90%, non-condensing
Transport	T ≤ 40°C: 5 to 90%, non-condensing T > 40°C: <90%, non-condensing
Vibration	
Operation (continuous)	2 to 9 Hz: 1.75 mm amplitude / 9 to 150 Hz: 0.5 g
Operation (occasional)	2 to 9 Hz: 3.5 mm amplitude / 9 to 150 Hz: 1 g
Storage	2 to 8 Hz: 7.5 mm amplitude / 8 to 200 Hz: 2 g / 200 to 500 Hz: 4 g
Transport	2 to 8 Hz: 7.5 mm amplitude / 8 to 200 Hz: 2 g / 200 to 500 Hz: 4 g
Shock	
Operation	15 g, 11 ms
Storage	30 g, 15 ms
Transport	30 g, 15 ms
Mechanical characteristics	
Housing	
Material	Metal
Front	
Frame	Naturally anodized aluminum
Design	Gray
Panel overlay	
Material	Polyester
Light background	Similar to Pantone 427CV
Gasket	Flat gasket around display front
Dimensions	
Width	435 mm
Height	330 mm
Depth	Depends on the component
Weight	5500 g (depends on the component)

Table 31: 5PC820.1505-00, 5PC820.1505-00 - Technical data

- 1) Maintenance Controller Extended.
- 2) At an ambient temperature of 25°C. Reducing the brightness by 50% can result in an approximately 50% increase in the half-brightness time.
- 3) Touch screen drivers for approved operating systems are available in the Downloads section of the B&R website.
- 4) The PCI slots available depend on the expansion and bus unit being used.
- 5) The PCIe slots available depend on the expansion and bus unit being used.
- 6) Optional with PCIe adapter 5AC803.BC01-00.
- 7) Optional with slide-in compact adapter 5AC803.BC02-00.

3.1.1.5 Dimensions

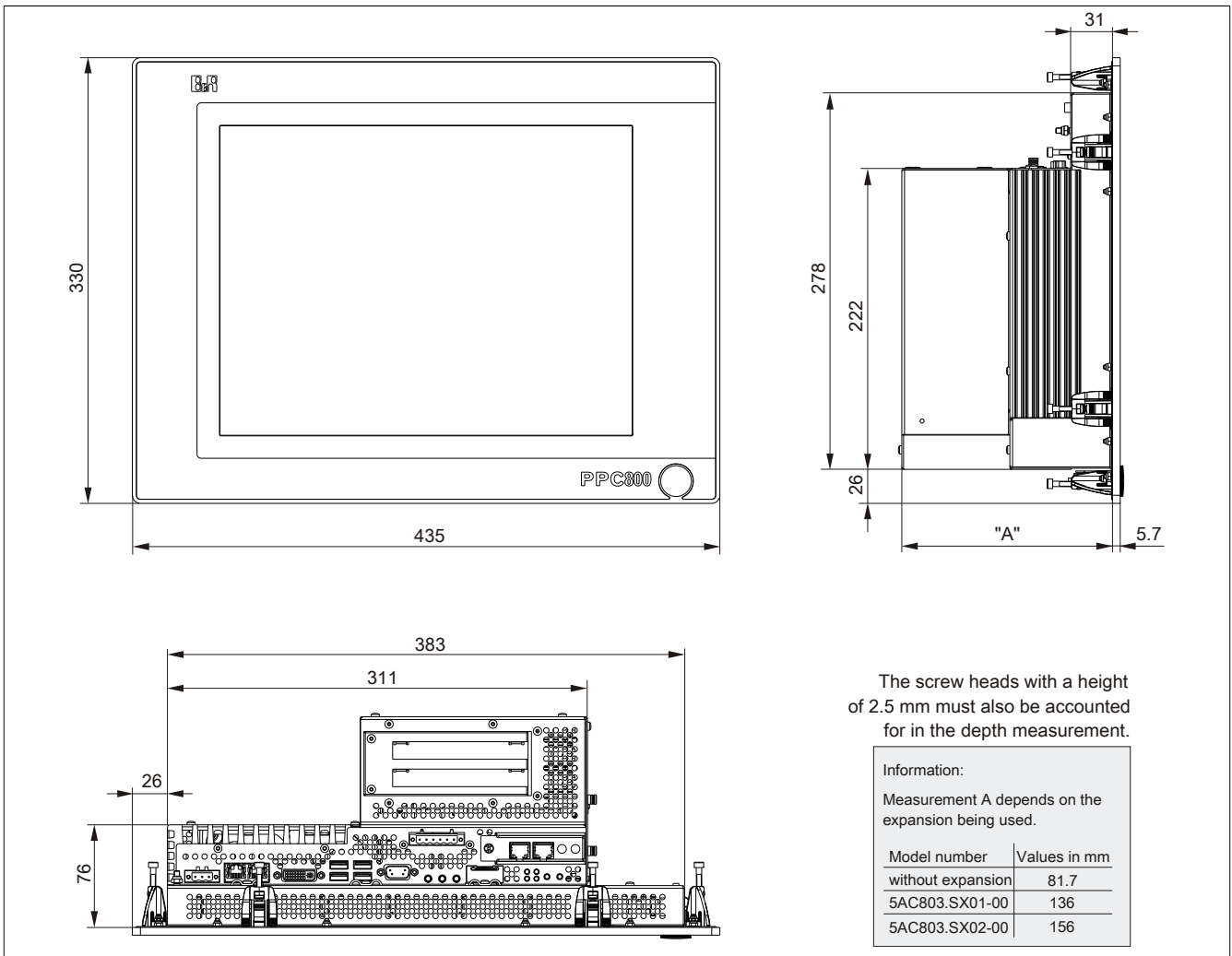

Figure 14: 5PC820.1505 - Dimensions

3.1.1.6 Cutout

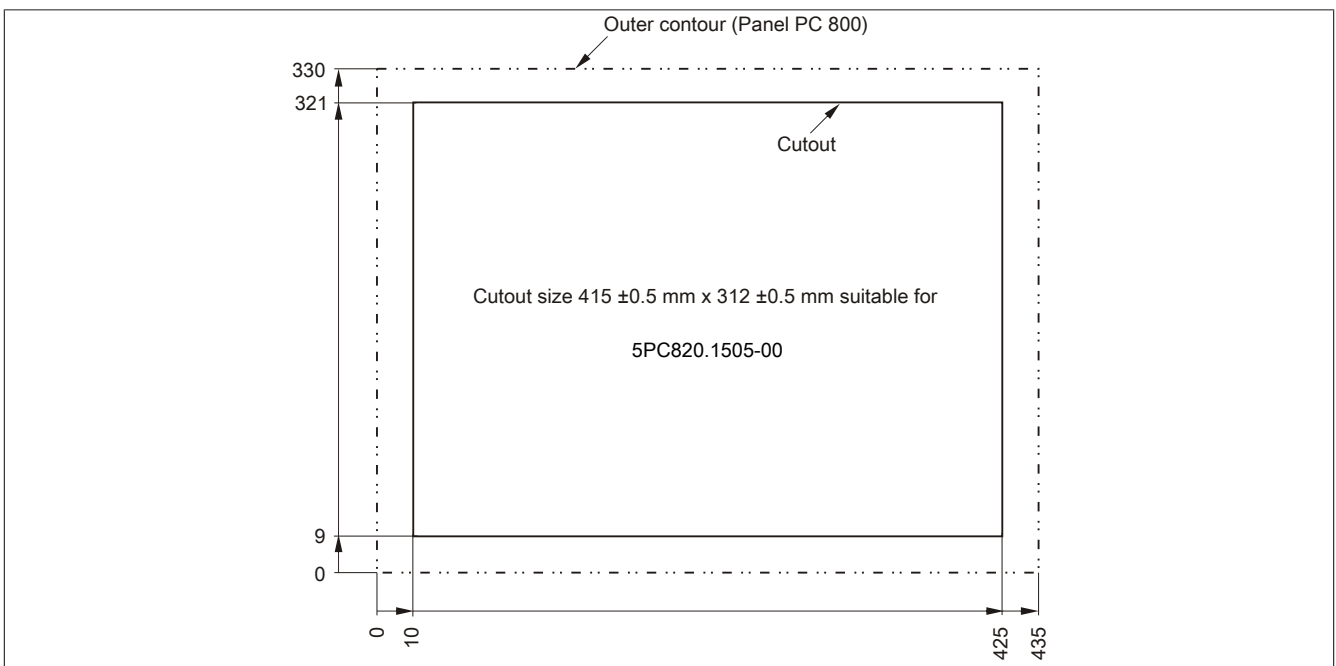

Figure 15: 5PC820.1505-00 - Cutout installation

3.1.2 5PC820.1906-00

3.1.2.1 General information

- 19" TFT SXGA color display
- Analog resistive touch screen
- Robust design
- Compact installation depth
- Fanless operation
- 1 optional PCI Express compact slot
- 1 optional slide-in compact slot
- Optional PCI and PCIe slots and optional slide-in drives, optional expansions available

3.1.2.2 Order data

Model number	Short description	Figure
	System units	
5PC820.1906-00	Panel PC 820 19" SXGA color TFT display with touch screen (resistive); connections for 1x RS232, 5x USB 2.0, Smart Display Link/DVI/Monitor, 2x Ethernet 10/100/1000, HDA sound, add-on UPS slot, expandable with 1 or 2 PCI / PCI Express slots, optional CompactPCI Express and slide-in compact slot; IP65 protection (front); order 24 VDC connector for supply voltage separately (screw clamp: 0TB103.9; cage clamp: 0TB103.91)	
	Required accessories	
	CPU boards	
5PC800.CCAX-00	Intel Atom N2800 CPU board, 1.86 GHz, dual core, 533 MHz FSB, 1 MB L2 cache; NM10 chipset; 1 slot for SO-DIMM DDR3 module	
	Terminal blocks	
0TB103.9	Connector, 24 VDC, 3-pin female, 3.31 mm ² screw clamp, protected against vibration by the screw flange	
0TB103.91	Connector, 24 VDC, 3-pin female, 3.31 mm ² cage clamp, protected against vibration by the screw flange	
	Main memory	
5MMDDR.2048-02	SO-DIMM DDR3 RAM 2048 MB PC3-8500	
5MMDDR.4096-02	SO-DIMM DDR3 RAM 4096 MB PC3-8500	
	Heat sink	
5AC803.HS00-04	PPC800 heat sink for CPU board with Atom dual-core processor N2800.	
	Optional accessories	
	Adapters	
5AC803.BC01-00	1 compact PCI Express PPC800 adapter	
5AC803.BC02-00	1 compact slide-in PPC800 adapter	
	Bus units	
5AC803.BX01-00	PPC800 bus; 1 PCI, 1 slide-in slot	
5AC803.BX01-01	PPC800 bus; 1 PCI Express, 1 slide-in slot	
5AC803.BX02-00	PPC800 bus; 2 PCI, 1 slide-in slot	
5AC803.BX02-01	PPC800 bus; 1 PCI, 1 PCI Express, 1 slide-in slot	
	Plug-in cards	
5ACPC.ETH0-00	PCIEc Ethernet card 1x 10/100/1000 For APC820 and PPC800.	
5ACPC.MPL0-00	PCIEc POWERLINK card, 2 POWERLINK interfaces, 512 kB SRAM; for APC820 and PPC800.	
	Expansions	
5AC803.SX01-00	PPC800 expansion; 1 PCI/PCI Express and 1 slide-in slot (bus 5AC803.BX01-00 or 5AC803.BX01-01 required)	
5AC803.SX02-00	PPC800 expansion; 2 PCI/PCI Express and 1 slide-in slot (bus 5AC803.BX02-00 or 5AC803.BX02-01 required)	
	Drives	
5AC801.ADAS-00	SATA hard disk adapter for operating a slide-in compact hard disk in a slide-in slot	
5AC801.DVDS-00	DVD-ROM SATA slide-in drive	
5AC801.DVRS-00	DVD-R/RW DVD+R/RW SATA drive, slide-in	
5AC801.HDDI-00	40 GB slide-in compact SATA hard disk, 24/7 operation with extended temperature range. Note: Please see the manual for information about using this hard disk.	
5AC801.HDDI-04	500 GB slide-in compact SATA hard disk; 24/7 operation. Note: Please see the manual for information about using this hard disk.	
5AC801.HDDS-00	40 GB slide-in SATA hard disk; 24/7 operation with extended temperature range. Note: Please see the manual for information about using this hard disk.	
5AC801.SSDI-03	60 GB SATA SSD (MLC), slide-in compact	

Table 32: 5PC820.1906-00 - Order data

Model number	Short description	Figure
5AC801.SSDI-04	128 GB SATA SSD (MLC), slide-in compact	
5AC801.SSDI-05	256 GB SATA SSD (MLC), slide-in compact	
	Fan kit	
5AC803.FA01-00	PPC800 fan kit for system units without an expansion	
5AC803.FA02-00	PPC800 fan kit for system units with expansion 5AC803.SX01-00	
5AC803.FA03-00	PPC800 fan kit for system units with expansion 5AC803.SX02-00	
	Uninterruptible power supply	
5AC600.UPSI-00	UPS module for APC620, APC810, PPC800; for system units 5PC600.SX01-00 (starting with Rev. H0), 5PC600.SX02-00 (starting with Rev. G0), 5PC600.SX02-01 (starting with Rev. H0), 5PC600.SX05-00 (starting with Rev. F0), 5PC600.SX05-01 (starting with Rev. F0), 5PC600.SF03-00 (starting with Rev. A0), 5PC810.SX*. 5PC820.1505-00, 5PC820.1906-00. Order cable (5CAUPS.0005-00 or 5CAUPS.0030-00) and battery unit (5AC600.UPSB-00) separately	

Table 32: 5PC820.1906-00 - Order data

3.1.2.3 Interfaces

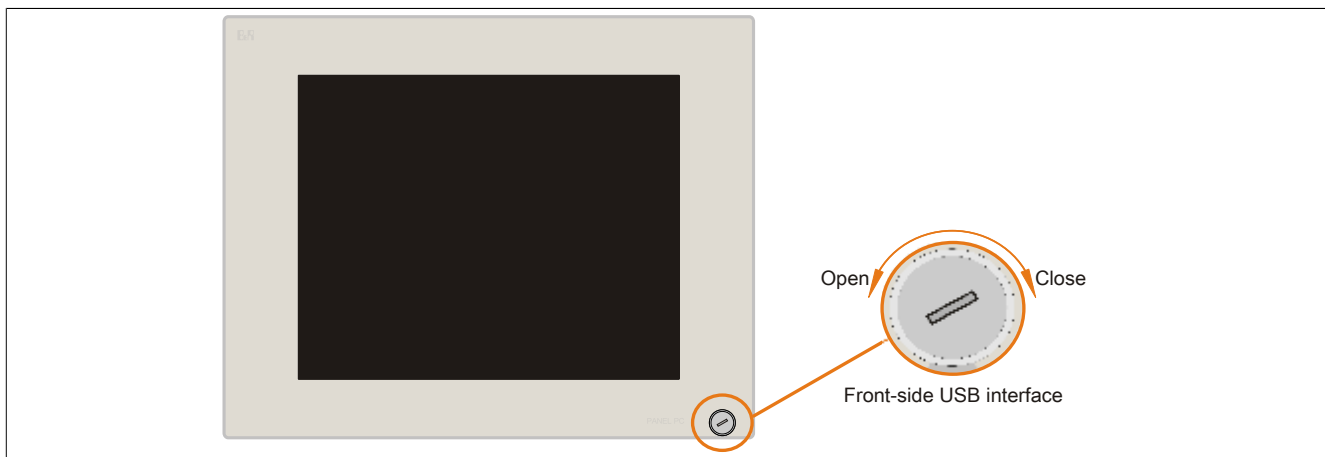

Figure 16: 5PC820.1906-00 - Front view

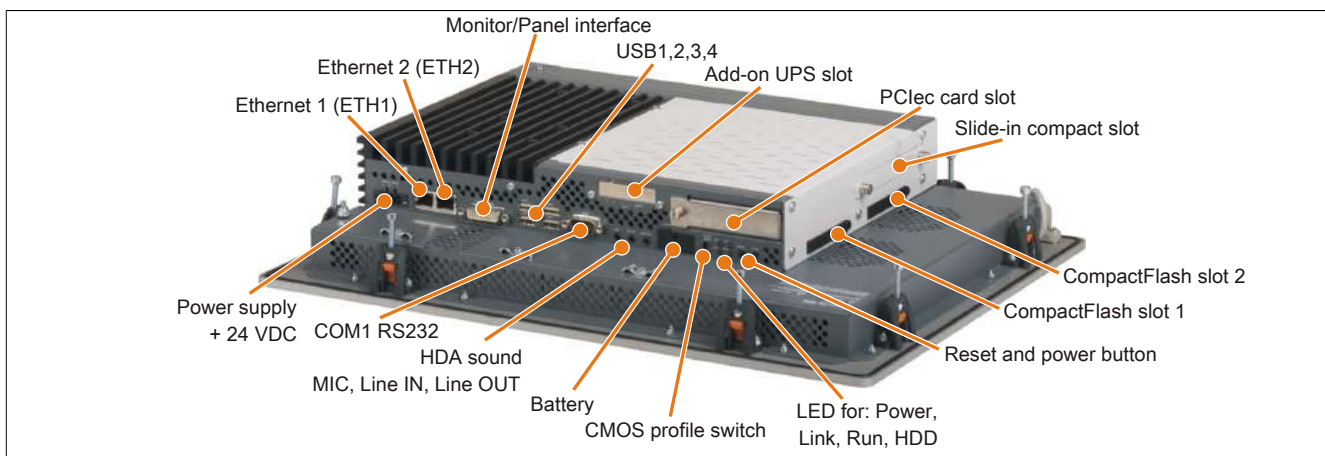

Figure 17: 5PC820.1906-00 - Rear view

Warning!

Do not remove the fastening screws from the heat sink since this component is connected to the processor and chipset via a thermal coupling. If this connection is interrupted, the B&R Industrial PC must be sent back to the factory for repair. Removing the fastening screws (protected by a seal) voids all warranty.

During operation, surface temperatures of the heat sink may reach 70°C ("hot surface" warning).

3.1.2.4 Technical data

Product ID	5PC820.1906-00	
Revision	C0	F0
General information		
LEDs	Power, HDD, Link, Run	
B&R ID code	0xAF22	
Battery	Renata 950 mAh	
Type	2½ years	
Service life	Yes, accessible from the outside	
Removable	Lithium ion	
Execution		
Power button	Yes	
Reset button	Yes	
Buzzer	Yes	
Certification		
CE	Yes	
cULus	Yes	
GOST-R	Yes	
Controller		
Boot loader	BIOS	

Table 33: 5PC820.1906-00, 5PC820.1906-00 - Technical data

Product ID		5PC820.1906-00	
Power failure logic			
Controller		MTCX ¹⁾	
Buffer time		10 ms	
Graphics			
Controller		Depends on the CPU board being used	
Memory			
Type		Depends on the CPU board being used	
Memory size		Depends on the CPU board being used	
Interfaces			
COM1			
Type		RS232, modem-capable, not electrically isolated	
Execution		9-pin male DSUB connector	
UART		16550-compatible, 16-byte FIFO	
Max. baud rate		115 kbit/s	
CompactFlash slot 1			
Type		Type I	
CompactFlash slot 2			
Type		Type I	
USB			
Quantity		5	
Type		USB 2.0	
Execution		Type A	
Transfer rate		Low speed (1.5 Mbit/s), full speed (12 Mbit/s), high speed (480 Mbit/s)	
Current load		Max. 500 mA or 1 A per connection	
Ethernet			
Quantity		2	
Execution		Shielded RJ45 port	
Transfer rate		10/100/1000 Mbit/s	
Audio			
Type		HDA sound	
Inputs		Microphone, Line IN	
Outputs		Line OUT	
Display			
Type		Color TFT	
Display size		19" (480 mm)	
Colors		16 million	
Resolution		SXGA, 1280 x 1024 pixels	
Contrast		900:1	1000:1
Viewing angles			
Horizontal		Direction R = 85° / Direction L = 85°	
Vertical		Direction R = 89° / Direction L = 89°	
Direction U = 85° / Direction D = 85°		Direction U = 89° / Direction D = 89°	
Backlight			
Type		CCFL	LED
Brightness		300 cd/m ²	
Half-brightness time ²⁾		50,000 h	
Touch screen ³⁾			
Type		AMT	
Technology		Analog, resistive	
Controller		Elo, serial, 12-bit	
Transmittance		81% ±3%	
Inserts			
PCI slots			
Quantity		1 or 2 (optional) ⁴⁾	
PCIe slots			
Quantity		1 ⁵⁾	
PCIec slots			
Quantity		Optional ⁶⁾	
Slide-in drives		Depends on the component (on the expansion and bus unit being used)	
Slide-in compact drives		Optional ⁷⁾	
Add-on UPS slot		Yes	
Insert for fan kit		Yes	
Electrical characteristics			
Nominal voltage		24 VDC ±25%	
Nominal current		6 A	
Starting current		Typ. 10 A, max. 50 A for <300 µs	
Power consumption		Depends on the component	
Electrical isolation		Yes	
Operating conditions			
Height of drop		1 m on industrial surfaces (in original packaging)	
EN 60529 protection		Back: IP20 Front: IP65, dust and sprayed water protection	

Table 33: 5PC820.1906-00, 5PC820.1906-00 - Technical data

Product ID	5PC820.1906-00
Environmental conditions	
Temperature	
Operation	Depends on the component
Storage	-20 to 60°C
Transport	-20 to 60°C
Relative humidity	
Operation	10 to 85%, non-condensing
Storage	T ≤ 40°C: 5 to 90%, non-condensing T > 40°C: <90%, non-condensing
Transport	T ≤ 40°C: 5 to 90%, non-condensing T > 40°C: <90%, non-condensing
Vibration	
Operation (continuous)	2 to 9 Hz: 1.75 mm amplitude / 9 to 150 Hz: 0.5 g
Operation (occasional)	2 to 9 Hz: 3.5 mm amplitude / 9 to 150 Hz: 1 g
Storage	2 to 8 Hz: 7.5 mm amplitude / 8 to 200 Hz: 2 g / 200 to 500 Hz: 4 g
Transport	2 to 8 Hz: 7.5 mm amplitude / 8 to 200 Hz: 2 g / 200 to 500 Hz: 4 g
Shock	
Operation	15 g, 11 ms
Storage	30 g, 15 ms
Transport	30 g, 15 ms
Mechanical characteristics	
Housing	
Material	Metal
Front	
Frame	Naturally anodized aluminum
Design	Gray
Panel overlay	
Material	Polyester
Light background	Similar to Pantone 427CV
Gasket	Flat gasket around display front
Dimensions	
Width	527 mm
Height	421 mm
Depth	Depends on the component
Weight	10000 g (depends on the component)

Table 33: 5PC820.1906-00, 5PC820.1906-00 - Technical data

- 1) Maintenance Controller Extended.
- 2) At an ambient temperature of 25°C. Reducing the brightness by 50% can result in an approximately 50% increase in the half-brightness time.
- 3) Touch screen drivers for approved operating systems are available in the Downloads section of the B&R website.
- 4) The PCI slots available depend on the expansion and bus unit being used.
- 5) The PCIe slots available depend on the expansion and bus unit being used.
- 6) Optional with PCIe adapter 5AC803.BC01-00.
- 7) Optional with slide-in compact adapter 5AC803.BC02-00.

3.1.2.5 Dimensions

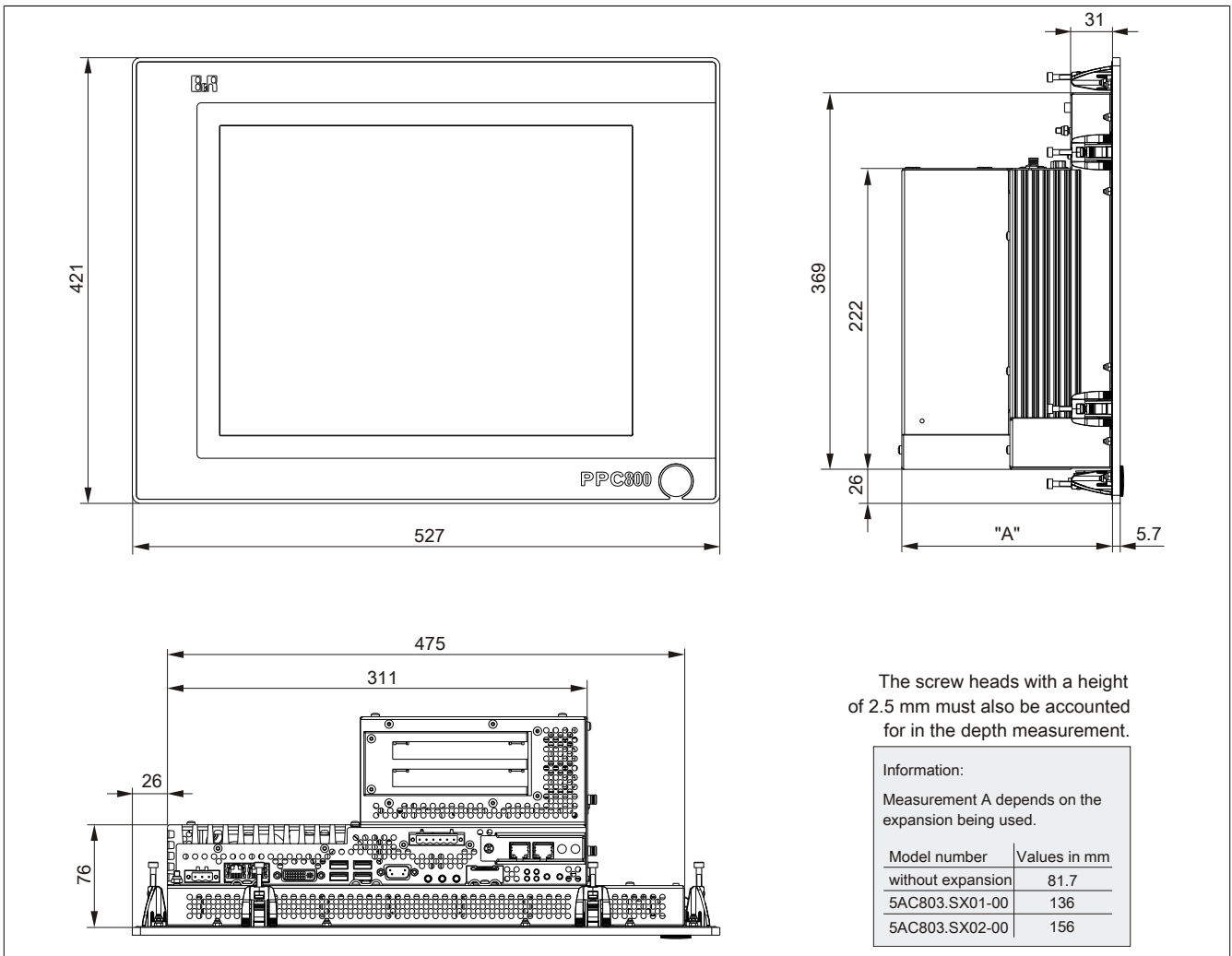

Figure 18: 5PC820.1906-00 - Dimensions

3.1.2.6 Cutout

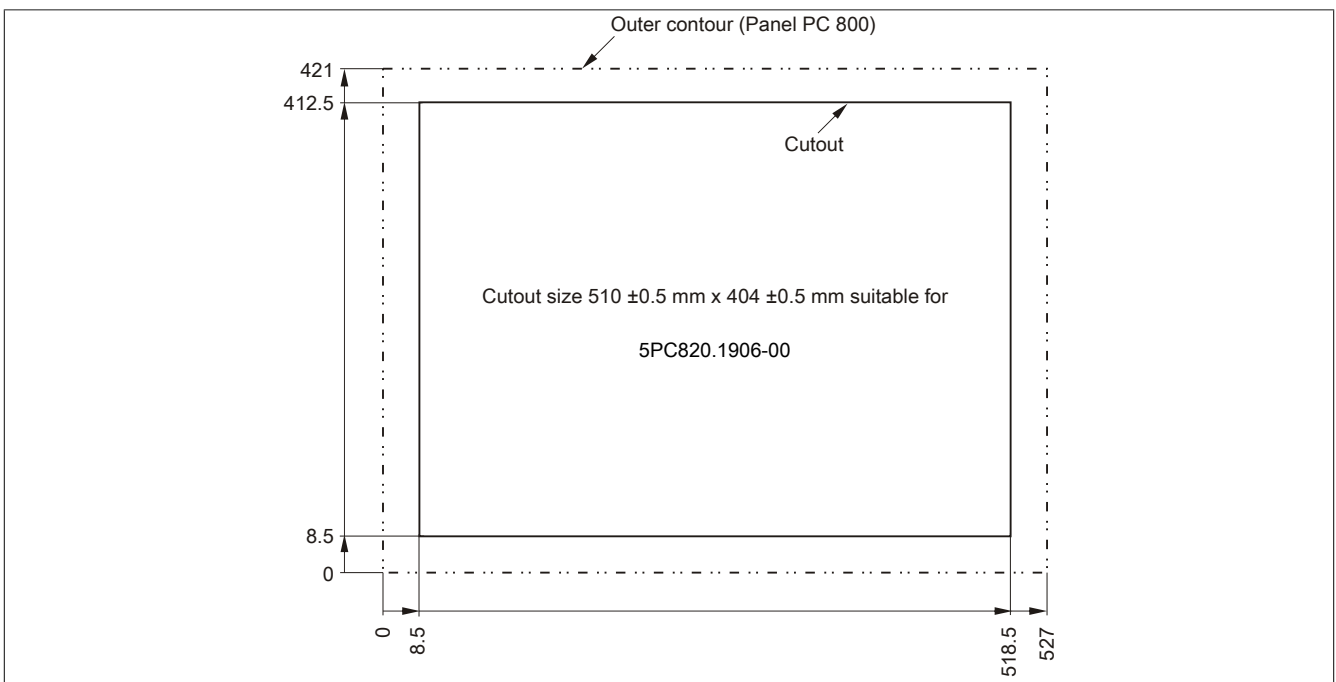

Figure 19: 5PC820.1906-00 - Cutout installation

3.2 NM10 CPU boards

3.2.1 General information

NM10 CPU boards are equipped with one DDR3 memory slot for a maximum of 4 GB. Additionally, the Intel® GMA 3600 is integrated with 384 MB memory and a maximum resolution of 1920 x 1200 pixels (WUXGA).

- Intel® dual-core Atom N2800 1.86 GHz
- Intel® NM10 chipset
- 1x DDR3 memory slot
- Intel® GMA 3600
- AMI BIOS (UEFI)

3.2.2 Order data

Model number	Short description	Figure
	CPU boards	
5PC800.CCAX-00	Intel Atom N2800 CPU board, 1.86 GHz, dual core, 533 MHz FSB, 1 MB L2 cache; NM10 chipset; 1 slot for SO-DIMM DDR3 module	
	Required accessories	
	Main memory for GM45 CPU boards	
5MMDDR.2048-02	SO-DIMM DDR3 RAM 2048 MB PC3-8500	
5MMDDR.4096-02	SO-DIMM DDR3 RAM 4096 MB PC3-8500	

Table 34: 5PC800.CCAX-00 - Order data

3.2.3 Technical data

Product ID	5PC800.CCAX-00
General information	
Certification	
CE	Yes
GOST-R	Yes
Controller	
Boot loader	embedded AMI BIOS (UEFI)
Processor	
Type	Intel® Atom™ N2800 dual core
Clock frequency	1860 MHz
Number of cores	2
Architectures	32 nm
L1 cache	2x 56 kB
L2 cache	2x 512 kB
External bus	1066 MHz
Intel® 64 Architecture	Yes
Intel® Hyper-Threading Technology	Yes
Intel® Virtualization Technology (VT-x)	No
Enhanced Intel SpeedStep® Technology	Yes
Expanded command set	SSE2, SSE3, SSSE3
Chipset	Intel® NM10
Real-time clock	
Precision	At 25°C: typ. 12 ppm (1 seconds) per day ¹⁾
Battery backed	Yes
Memory slot	
Type	DDR3
Memory size	Max. 4 GB

Table 35: 5PC800.CCAX-00 - Technical data

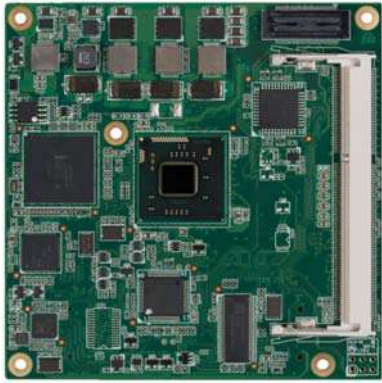
Product ID	5PC800.CCAX-00
Graphics	
Controller	Intel® Graphics Media Accelerator 3600
Memory	Up to 384 MB ²⁾
Color depth	Max. 32-bit
Resolution	
RGB	350 MHz RAMDAC, resolutions up to 1920 x 1200
Mass memory management	2x SATA, 2x PATA
Power management	ACPI 3.0 with battery support

Table 35: 5PC800.CCAX-00 - Technical data

- 1) At max. specified ambient temperature: typically 58 ppm (5 seconds) - worst-case 220 ppm (19 seconds).
- 2) Allocated in main memory.

3.3 Heat sink

3.3.1 5AC803.HS00-04

3.3.1.1 Order data

Model number	Short description	Figure
	Heat sinks	
5AC803.HS00-04	PPC800 heat sink for CPU board with Atom dual-core processor N2800	

Table 36: 5AC803.HS00-04 - Order data

3.3.1.2 Technical data

Product ID	5AC803.HS00-04
General information	
Suitable for CPU boards	5PC800.CCAX-00
Suitable for the following system units	5PC820.1505-00 5PC820.1906-00
Certification	
CE	Yes
GOST-R	Yes
Mechanical characteristics	
Material	Aluminum, black-coated with copper heat pipes
Dimensions	
Width	143 mm
Height	183.5 mm
Depth	60 mm
Weight	1200 g

Table 37: 5AC803.HS00-04 - Technical data

3.4 Main memory

3.4.1 5MMDDR.xxxx-02

3.4.1.1 General information

These 204-pin DDR3 main memory modules operate at 1066 MHz and range in size from 2 GB to 4 GB.

3.4.1.2 Order data

Model number	Short description	Figure
	Main memory for GM45 CPU boards	
5MMDDR.2048-02	SO-DIMM DDR3 RAM 2048 MB PC3-8500	
5MMDDR.4096-02	SO-DIMM DDR3 RAM 4096 MB PC3-8500	

Table 38: 5MMDDR.2048-02, 5MMDDR.4096-02 - Order data

3.4.1.3 Technical data

Product ID	5MMDDR.2048-02	5MMDDR.4096-02
General information		
Certification		
CE		Yes
cULus		Yes
cULus HazLoc Class 1 Division 2	-	Yes ¹⁾
ATEX Zone 22	-	Yes ¹⁾
GOST-R		Yes
Controller		
Memory		
Type		SO-DIMM DDR3 SDRAM
Memory size	2 GB	4 GB
Construction		204-pin
Organization	256M x 64-bit	512M x 64-bit
Speed		DDR3-1066 (PC3-8500)

Table 39: 5MMDDR.2048-02, 5MMDDR.4096-02 - Technical data

1) Yes, although applies only if all components installed within the complete system have this certification

Information:

A main memory module can only be replaced at B&R.

3.5 Expansions

3.5.1 General information

This is an optional expansion for the PPC800 and has inserts for up to 2 PCI/PCIe slots (only in connection with a bus unit) and a slide-in drive.

3.5.2 Order data

Model number	Short description	Figure
	Expansions	
5AC803.SX01-00	PPC800 expansion; 1 PCI/PCI Express and 1 slide-in slot (bus 5AC803.BX01-00 or 5AC803.BX01-01 required)	
5AC803.SX02-00	PPC800 expansion; 2 PCI/PCI Express and 1 slide-in slot (bus 5AC803.BX02-00 or 5AC803.BX02-01 required)	
	Required accessories	
	Bus units	
5AC803.BX01-00	PPC800 bus; 1 PCI, 1 slide-in slot	
5AC803.BX01-01	PPC800 bus; 1 PCI Express, 1 slide-in slot	
5AC803.BX02-00	PPC800 bus; 2 PCI, 1 slide-in slot	
5AC803.BX02-01	PPC800 bus; 1 PCI, 1 PCI Express, 1 slide-in slot	
	Fan kits	
5AC803.FA02-00	PPC800 fan kit for system units with expansion 5AC803.SX01-00	
5AC803.FA03-00	PPC800 fan kit for system units with expansion 5AC803.SX02-00	
	Optional accessories	
	Drives	
5AC801.ADAS-00	SATA hard disk adapter for operating a slide-in compact hard disk in a slide-in slot	
5AC801.DVDS-00	DVD-ROM SATA slide-in drive	
5AC801.DVRS-00	DVD-R/RW DVD+R/RW SATA slide-in drive	
5AC801.HDDS-00	40 GB SATA slide-in hard disk; 24/7 operation with extended temperature range. Note: please see the manual for information about using this hard disk	
5ACPCI.RAIC-05	PCI RAID system SATA 2x 250 GB; Note: please see the manual for information about using this hard disk	
5ACPCI.RAIC-06	PCI RAID System 2x 500 GB - SATA	

Table 40: 5AC803.SX01-00, 5AC803.SX02-00 - Order data

3.5.3 Inserts

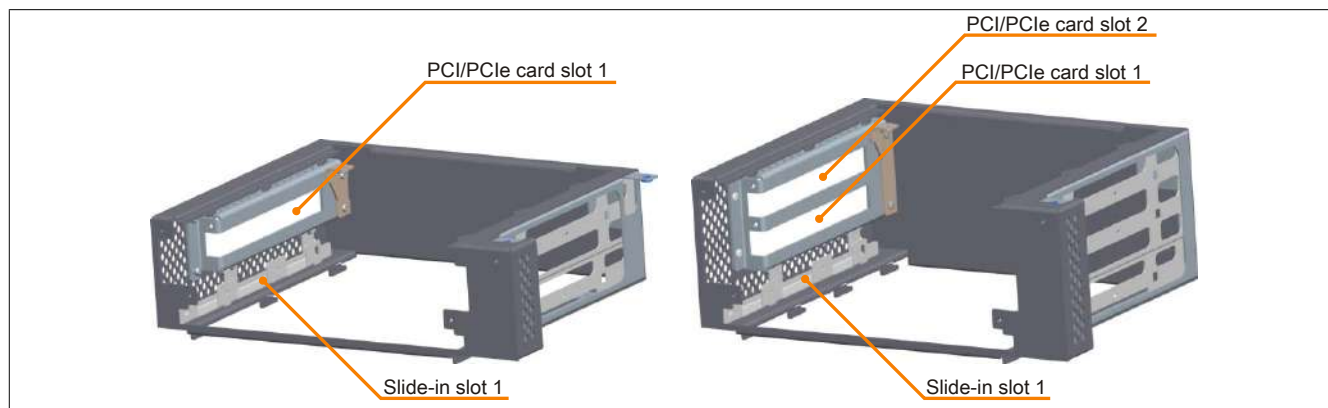

Figure 20: 5AC803.SX01-00, 5AC803.SX02-00 - Slots

3.5.4 Technical data

Product ID	5AC803.SX01-00	5AC803.SX02-00
General information		
Certification		
CE		Yes
GOST-R		Yes
Inserts		
PCI / PCIe slots		
Quantity	1	2
Slide-in drives		1

Table 41: 5AC803.SX01-00, 5AC803.SX02-00 - Technical data

Product ID	5AC803.SX01-00	5AC803.SX02-00
Mechanical characteristics		
Dimensions		
Width		167 mm
Height		222 mm
Depth	60 mm	80 mm
Weight	Approx. 1000 g	

Table 41: 5AC803.SX01-00, 5AC803.SX02-00 - Technical data

3.5.5 5AC803.SX01-00 - Dimensions

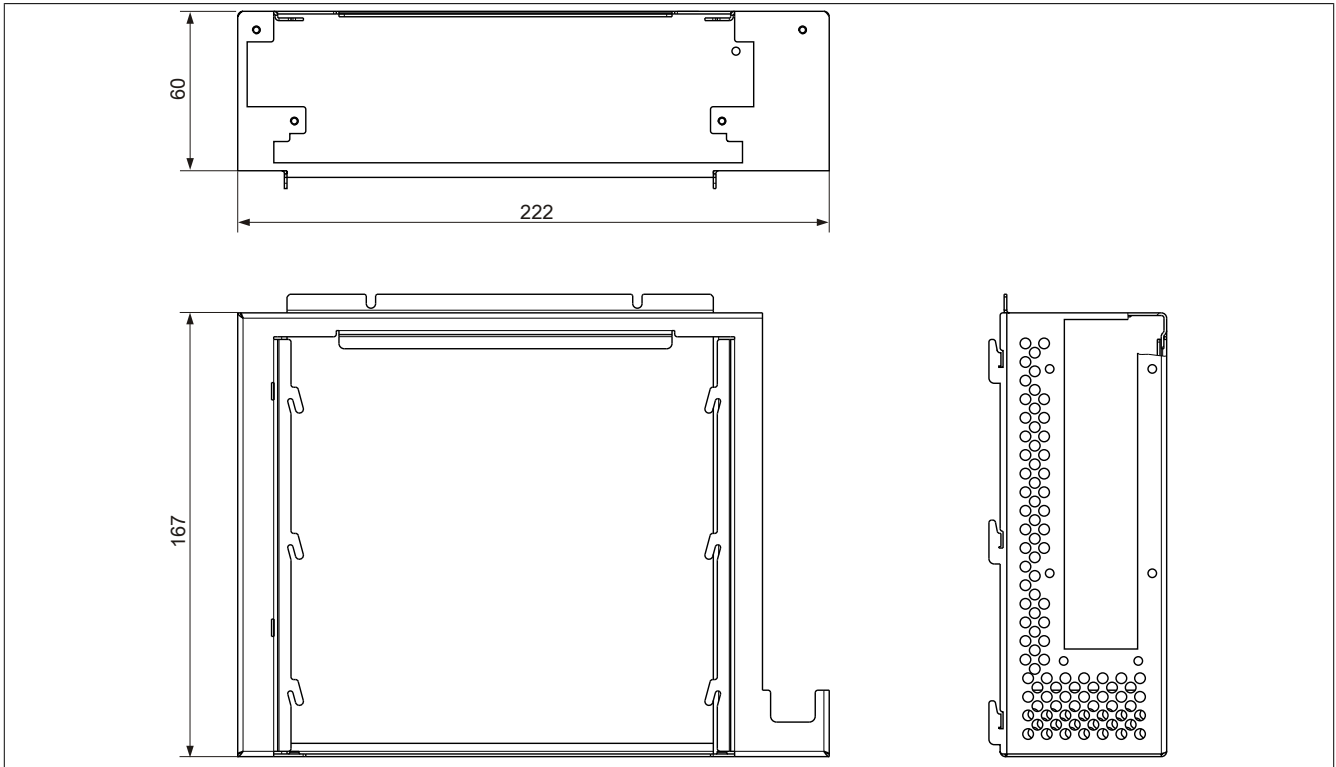

Figure 21: 5AC803.SX01-00 - Dimensions

3.5.6 5AC803.SX02-00 - Dimensions

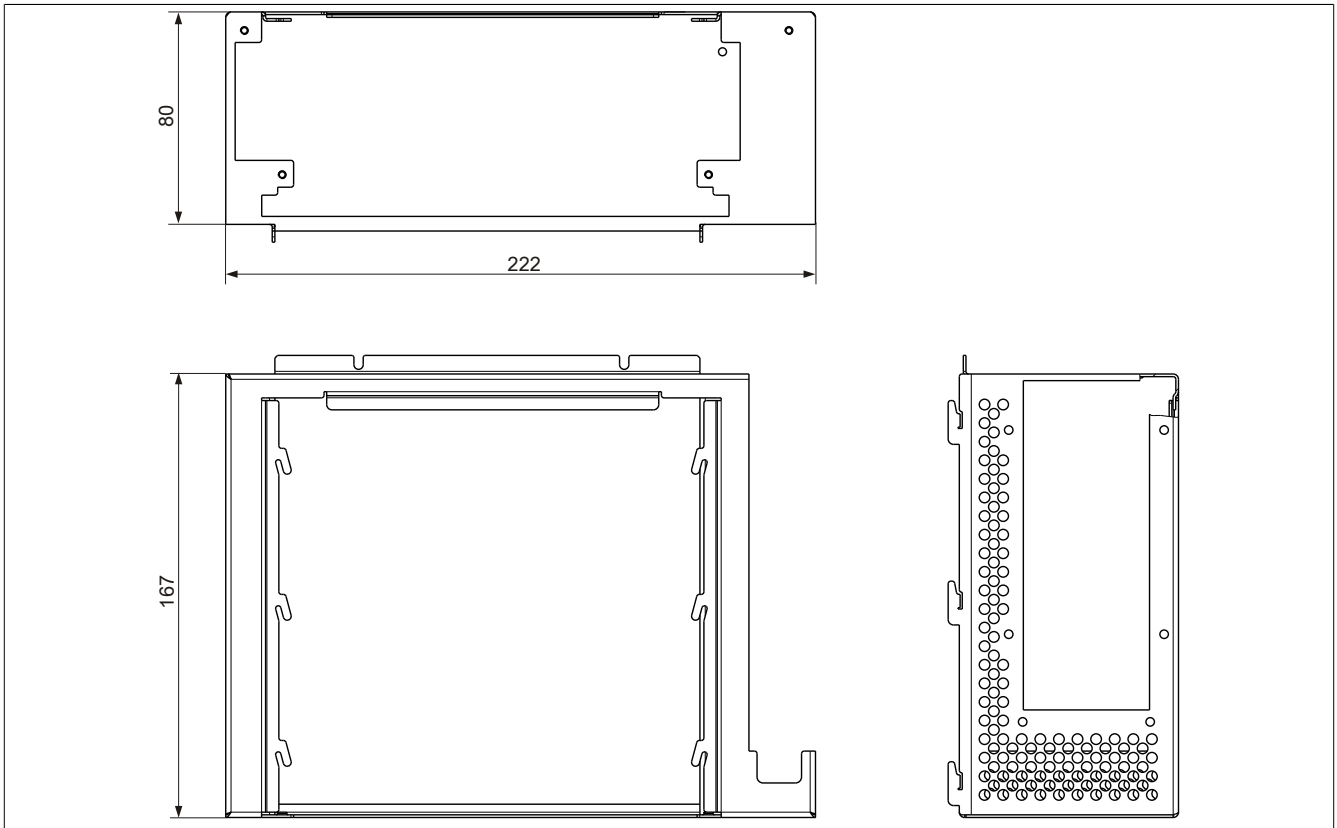

Figure 22: 5AC803.SX02-00 - Dimensions

3.5.7 Slot for bus units

3.5.7.1 Card slot (PCI / PCIe)

Standard PCI 2.2 half-size cards or PCI Express (PCIe) half-size cards can be installed depending on the type of bus unit. They cannot exceed the following dimensions.



Figure 23: Standard half-size PCI card - Dimensions

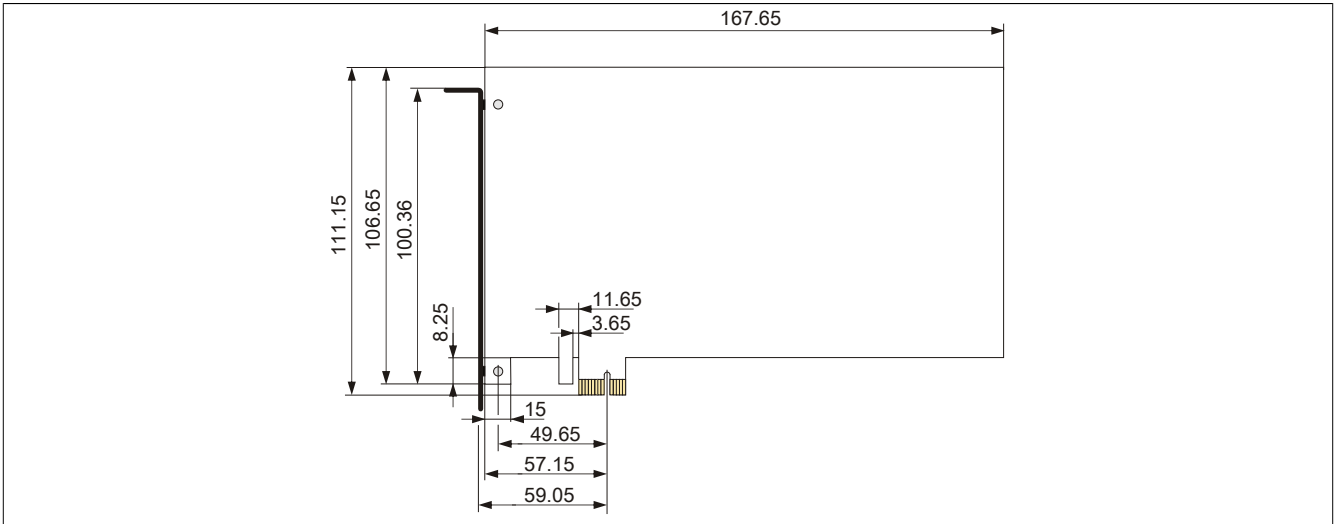

Figure 24: Standard half-size PCIe card - Dimensions

3.5.8 Slide-in slot 1

The internal connection between slide-in slot 1 and the chipset is made via SATA II and USB.

Slide-in slot 1	
Connection	SATA II and USB
Model number	Short description
	Drives
5AC801.ADAS-00	APC810 and PPC800 slide-in compact adapter
5AC801.HDDS-00	APC810 and PPC800 slide-in HDD EE25
5AC801.DVRS-00	APC810 and PPC800 slide-in DVD-R/RW
5AC801.DVDS-00	APC810 and PPC800 slide-in DVD-ROM



Table 42: Slide-in slot 1

Information:

The SATA II interface allows disks to be replaced during operation (hot plugging). In order to take advantage of this capability, this feature must be supported by the operating system.

3.6 Bus units

3.6.1 General information

Bus units are compatible with expansions with 1 or 2 card slots and provide support for PCI and/or PCI Express.

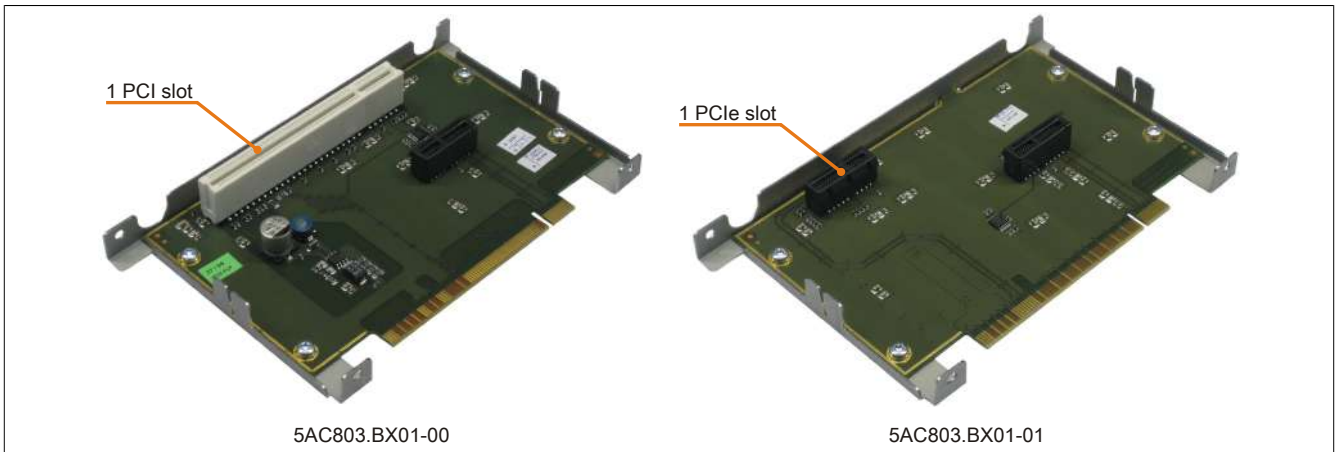

Figure 25: 1-slot bus units

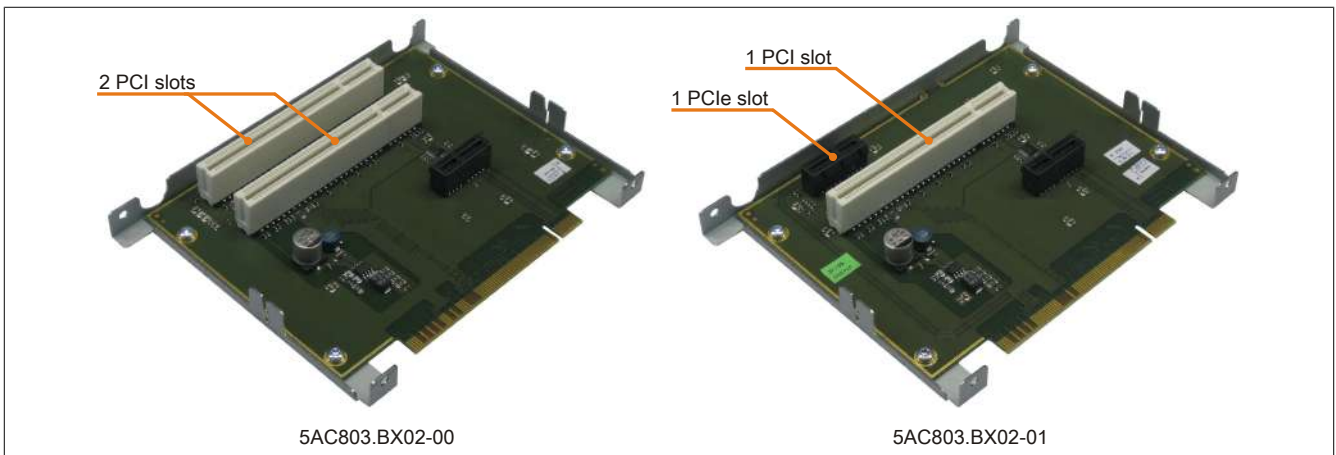

Figure 26: 2-slot bus units

3.6.2 Order data

Model number	Short description	Figure
Bus units		
5AC803.BX01-00	PPC800 bus; 1 PCI, 1 slide-in slot	
5AC803.BX01-01	PPC800 bus; 1 PCI Express, 1 slide-in slot	
5AC803.BX02-00	PPC800 bus; 2 PCI, 1 slide-in slot	
5AC803.BX02-01	PPC800 bus; 1 PCI, 1 PCI Express, 1 slide-in slot	

Table 43: 5AC803.BX01-00, 5AC803.BX01-01, 5AC803.BX02-00, 5AC803.BX02-01 - Order data

3.6.3 Technical data

Product ID	5AC803.BX01-00	5AC803.BX01-01	5AC803.BX02-00	5AC803.BX02-01
General information				
Certification				
CE				Yes
GOST-R				Yes

Table 44: 5AC803.BX01-00, 5AC803.BX01-01, 5AC803.BX02-00, 5AC803.BX02-01 - Technical data

Product ID	5AC803.BX01-00	5AC803.BX01-01	5AC803.BX02-00	5AC803.BX02-01
Inserts				
PCI slots				
Quantity	1	-	2	1
Type	32-bit	-	32-bit	32-bit
Execution	PCI half-size	-	PCI half-size	PCI half-size
Standard	2.2	-	2.2	2.2
Bus speed	33 MHz	-	33 MHz	33 MHz
PCIe slots				
Quantity	-	1	-	1
Execution	-	PCIe half-size	-	PCIe half-size
Standard	-	1.0 a	-	1.0 a
Bus speed	-	x1 (250 MB/s)	-	x1 (250 MB/s)

Table 44: 5AC803.BX01-00, 5AC803.BX01-01, 5AC803.BX02-00, 5AC803.BX02-01 - Technical data

3.7 Adapters

3.7.1 5AC803.BC01-00

3.7.1.1 General information

This adapter can be used to operate a PCI Express compact plug-in card in PPC800 system units.

3.7.1.2 Order data

Model number	Short description	Figure
	Adapter	
5AC803.BC01-00	1 compact PCI Express PPC800 adapter	
	Required accessories	
	Interface cards	
5ACPCC.ETH0-00	PCIec Ethernet card 1x 10/100/1000 For APC820 and PPC800.	
5ACPCC.MPL0-00	PCIec POWERLINK card, 2 POWERLINK interfaces, 512 kB SRAM; for APC820 and PPC800.	

Table 45: 5AC803.BC01-00 - Order data

3.7.2 5AC803.BC02-00

3.7.2.1 General information

This adapter can be used to operate a slide-in compact drive in PPC800 system units.

3.7.2.2 Order data

Model number	Short description	Figure
	Adapter	
5AC803.BC02-00	1 compact slide-in PPC800 adapter	
	Required accessories	
	Drives	
5AC801.HDDI-00	40 GB SATA slide-in compact hard disk; 24/7 operation with extended temperature range. Note: please see the manual for information about using this hard disk	
5AC801.HDDI-04	500 GB SATA hard disk, slide-in compact, 24/7 operation Note: please see the manual for information about using this hard disk	
5AC801.SSDI-00	32 GB SATA SSD (SLC), slide-in compact	
5AC801.SSDI-03	60 GB SATA slide-in compact SSD (MLC)	
5AC801.SSDI-04	128 GB SATA SSD (MLC), slide-in compact	

Table 46: 5AC803.BC02-00 - Order data

3.8 PClec plug-in cards

3.8.1 General information

PClec plug-in cards are equipped with a sensor that monitors the card's temperature. This is read out in BIOS and in the ADI.

3.8.2 Dimensions

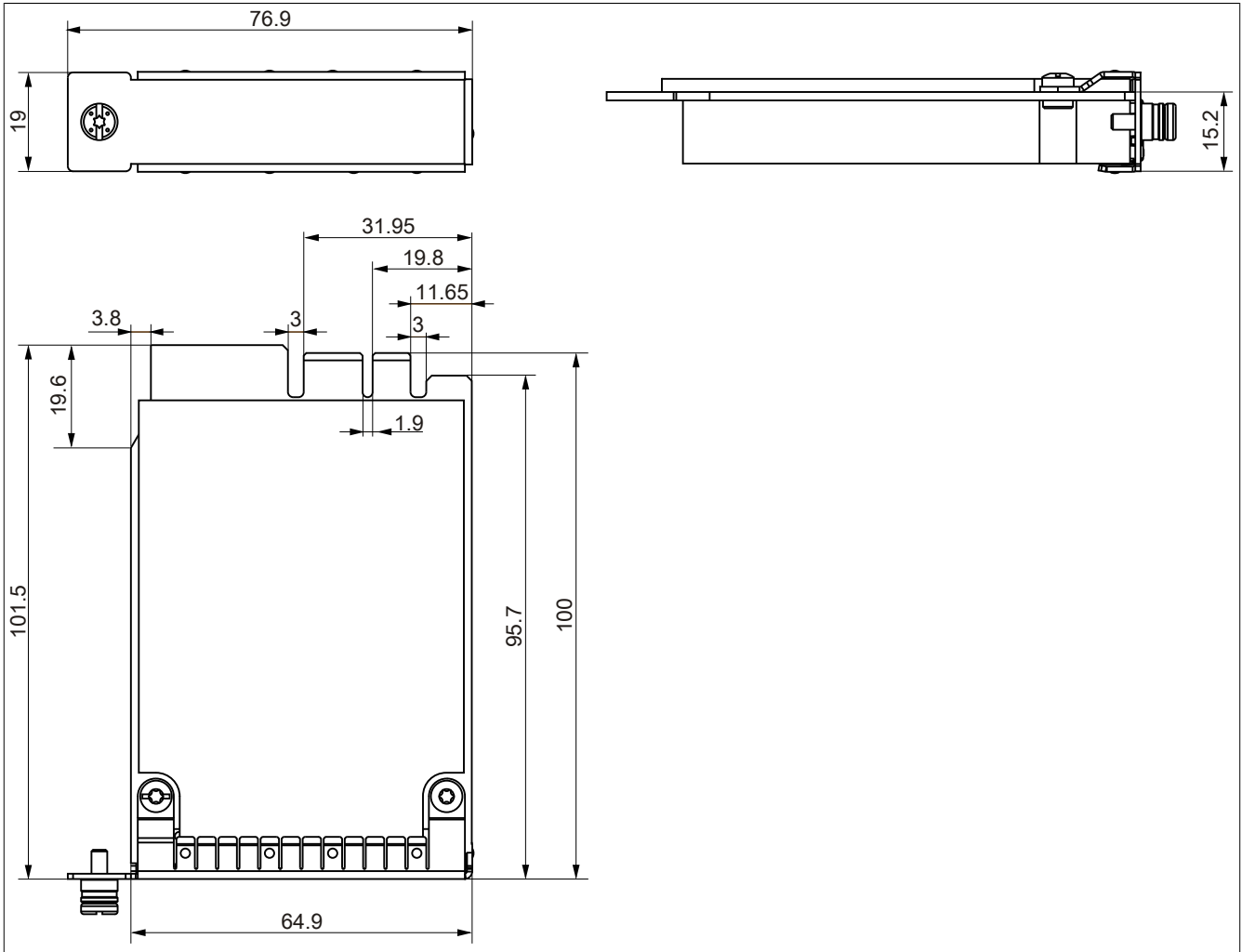

Figure 27: PCI Express compact plug-in cards - Dimensions

Information:

Only B&R PClec cards that have been specially designed for the Automation PC 820 and Panel PC 800 can be used.

3.8.3 5ACPCC.ETH0-00

3.8.3.1 General information

This PCI Express compact Ethernet card has a 10/100/1000 Mbit/s network connection and can be used as an additional network interface in a PCI Express compact slot.

- PCIe Ethernet card
- 1 network connection (10/100/1000 Mbit/s)

When used in a PPC800

Information:

The adapter 5AC803.BC01-00 is required to use PCIe plug-in cards.

3.8.3.2 Order data

Model number	Short description	Figure
	Interface cards	
5ACPCC.ETH0-00	PCIe Ethernet card 1x 10/100/1000 For APC820 and PPC800.	

Table 47: 5ACPCC.ETH0-00 - Order data

3.8.3.3 Technical data

Product ID	5ACPCC.ETH0-00
General information	
B&R ID code	0xAB25
Diagnostics Data transfer	Yes, using status LED
Certification CE GOST-R	Yes Yes
Interfaces	
Ethernet Quantity Controller Design Transfer rate Cable length	1 Intel 82574 Shielded RJ45 port 10/100/1000 Mbit/s Max. 100 m between two stations (segment length)
Mechanical characteristics	
Slot	PCIe module

Table 48: 5ACPCC.ETH0-00 - Technical data

3.8.3.3.1 Ethernet interface

Information:

The following characteristics, features and limit values only apply to this individual component and can deviate from those specified for the complete system. For the complete system in which this individual component is used, refer to the data given specifically for that device.

Ethernet interface (ETH ¹⁾)		
Controller	Intel 82574	
Cabling	S/STP (Cat 5e)	
Transfer rate	10/100/1000 Mbit/s ²⁾	
Cable length	Max. 100 m (min. Cat 5e)	
Speed LED	On	Off
Green	100 Mbit/s	10 Mbit/s ³⁾
Orange	1000 Mbit/s	-
Link LED	On	Off
Orange	Link (Ethernet network connection available)	Activity (blinking - data transfer in progress)

Female RJ45 connector

1

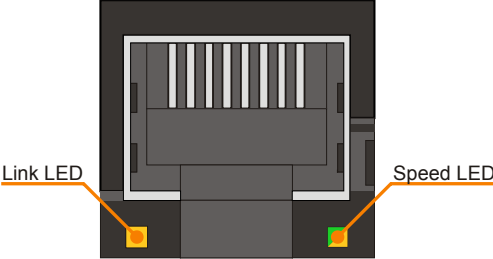

Table 49: 5ACPCC.ETH0-00 - Ethernet interface

- 1) The interfaces, etc. available on the device or module have been numbered as such for easy identification. This numbering may differ from that used by the particular operating system.
- 2) Switching takes place automatically.
- 3) The 10 Mbit/s transfer speed / connection is only present if the IF slot Link LED is also lit at the same time.

Driver support

A special driver is required in order to operate the Intel 82574 Ethernet controller. Drivers for approved operating systems are available in the Downloads section of the B&R website (www.br-automation.com).

Information:

Required drivers can only be downloaded from the B&R website, not from manufacturer websites.

3.8.4 5ACPCC.MPL0-00

3.8.4.1 General information

This PCI Express compact POWERLINK card is equipped with two POWERLINK interfaces, two station number switches and a card number switch for differentiating between modules. This PCI Express compact POWERLINK card can be used as an additional POWERLINK interface in a PCI Express compact slot.

- PClec POWERLINK card
- 2 POWERLINK interfaces
- 2 station number switches
- Card number switch

When used in a PPC800

Information:

The adapter 5AC803.BC01-00 is required to use PClec plug-in cards.

3.8.4.2 Order data

Model number	Short description	Figure
5ACPCC.MPL0-00	Interface cards PClec POWERLINK card, 2 POWERLINK interfaces, 512 kB SRAM; for APC820 and PPC800.	

Table 50: 5ACPCC.MPL0-00 - Order data

3.8.4.3 Technical data

Product ID	5ACPCC.MPL0-00
General information	
B&R ID code	0xAB27
Diagnostics Data transfer	Yes, using status LED
Certification CE GOST-R	Yes Yes
Controller	
SRAM Size Remanent variables in power failure mode	512 kB 128 kB (e.g. for Automation Runtime, see AS help documentation)
Interfaces	
POWERLINK Quantity Transmission Design Transfer rate Node switches Cable length	2 100 Base-T (ANSI/IEEE 802.3) Internal 2x hub, 2x shielded RJ45 port 100 Mbit/s 2 Max. 100 m between two stations (segment length)
Mechanical characteristics	
Slot	PClec module

Table 51: 5ACPCC.MPL0-00 - Technical data

3.8.4.3.1 POWERLINK interface

Information:

The following characteristics, features and limit values only apply to this individual component and can deviate from those specified for the complete system. For the complete system in which this individual component is used, refer to the data given specifically for that device.

POWERLINK card 2 connections		
Cabling	S/STP (Cat 5e)	
Cable length	Max. 100 m (min. Cat 5e)	
Speed LED	On	Off
Green/Red	See Status/Error LED.	
Link LED	On	Off
Yellow	Link (POWERLINK network connection available)	Activity (blinking - data transfer in progress)

Female RJ45 connector

1

Table 52: 5ACPCC.MPL0-00 - POWERLINK interface

3.8.4.3.2 Status/Error LED

The Status/Error LED is a green and red dual LED. The LED status can have different meanings depending on the operating mode.

Ethernet mode

In this mode, the interface is operated as an Ethernet interface.

Green - Status	Description
On	Interface being operated as an Ethernet interface

Table 53: Status/Error LED - Ethernet mode

POWERLINK V1

LED status indicators		Status of the POWERLINK station
Green	Red	
On	Off	The POWERLINK station is running with no errors.
Off	On	A fatal system error has occurred. The error type can be read using the PLC logbook. An irreparable problem has occurred. The system cannot properly carry out its tasks. This state can only be changed by resetting the module.
Blinking alternately		The POWERLINK managing node has failed. This error code can only occur when operated as a controlled node.
Off	Blinking	System failure. The red blinking LED signals a certain type of error using a blink code (see section "System stop error codes" on page 76).

Table 54: Status/Error LED - POWERLINK V1 operating mode

POWERLINK

Red - Error	Description
On	<p>The interface is in an error state (failed Ethernet frames, increased number of collisions on the network, etc.). If an error occurs in the following states, then the green LED blinks over the red LED:</p> <ul style="list-style-type: none"> BASIC_ETHERNET PRE_OPERATIONAL_1 PRE_OPERATIONAL_2 READY_TO_OPERATE

Table 55: Status/Error LED - POWERLINK - Error

Green - Status	Description
Off NOT_ACTIVE	<p>Mode The interface is in NOT_ACTIVE mode or:</p> <ul style="list-style-type: none"> • Switched off • Starting up • Not configured correctly in Automation Studio • Defective <p>Managing node (MN) The bus is being monitored for POWERLINK frames. If a frame is not received within the configured time window (timeout), the interface switches immediately to PRE_OPERATIONAL_1 mode (single flash). If POWERLINK communication is detected before the time expires, however, then the MN will not be started.</p> <p>Controlled node (CN) The bus is being monitored for POWERLINK frames. If a corresponding frame is not received within the defined time frame (timeout), then the module switches immediately to BASIC_ETHERNET mode (flickering). If POWERLINK communication is detected before this time expires, however, the interface switches immediately to PRE_OPERATIONAL_1 mode (single flash).</p>
Green flickering (approx. 10 Hz) BASIC_ETHERNET	<p>Mode The interface is in BASIC_ETHERNET mode and being operated as an Ethernet TCP/IP interface.</p> <p>Managing node (MN) This state can only be exited by resetting the interface.</p> <p>Controlled node (CN) If POWERLINK communication is detected while in this state, the interface switches to the PRE_OPERATIONAL_1 state (single flash).</p>
Single flash (approx. 1 Hz) PRE_OPERATIONAL_1	<p>Mode The interface is in PRE_OPERATIONAL_1 mode.</p> <p>Managing node (MN) The MN starts "reduced cycle" operation. Cyclic communication is not yet taking place.</p> <p>Controlled node (CN) The module can be configured by the MN in this state. The CN waits until it receives an SoC frame and then switches to the PRE_OPERATIONAL_2 state (double flash). An LED lit red in this state indicates failure of the MN.</p>
Double flash (approx. 1 Hz) PRE_OPERATIONAL_2	<p>Mode The interface is in the PRE_OPERATIONAL_2 state.</p> <p>Managing node (MN) The MN begins cyclic communication (cyclic input data is not yet being evaluated). The CNs are configured in this state.</p> <p>Controlled node (CN) The interface can be configured by the MN in this state. A command then switches the state to READY_TO_OPERATE (triple flash). An LED lit red in this mode indicates failure of the MN.</p>
Triple flash (approx. 1 Hz) READY_TO_OPERATE	<p>Mode The interface is in the READY_TO_OPERATE state.</p> <p>Managing node (MN) Cyclic and asynchronous communication is taking place. Any received PDO data is ignored.</p> <p>Controlled node (CN) The configuration of the module is completed. Normal cyclic and asynchronous communication is taking place. The PDO data being sent corresponds to the PDO mapping. Cyclic data is not yet being evaluated, however. An LED lit red in this mode indicates failure of the MN.</p>
On OPERATIONAL	<p>Mode The interface is in OPERATIONAL mode. PDO mapping is active and cyclic data is being evaluated.</p>
Blinking (approx. 2.5 Hz) STOPPED	<p>Mode The interface is in STOPPED mode.</p> <p>Managing node (MN) This status is not possible for the MN.</p> <p>Controlled node (CN) No output data is being produced, and no input data is being received. It is only possible to enter or leave this mode after the MN has given the appropriate command.</p>

Table 56: Status/Error LED - POWERLINK - Status

System stop error codes

Incorrect configuration or defective hardware can cause a system stop error.

The error code is indicated by the red Error LED using four switch-on phases. Each switch-on phase has a duration of either 150 ms or 600 ms. The error code is repeated every 2 seconds.

Error description	Error code indicated by red Status LED
RAM error: The interface is defective and must be replaced.	• • • - Pause • • • - Pause
Hardware error: The interface or a system component is defective and must be replaced.	- • • - Pause - • • - Pause

Table 57: System stop error codes

Key	•	...150 ms
	-	...600 ms
	Pause	2 second delay

3.8.4.3.3 POWERLINK station number

POWERLINK station number (x1, x16)		
Both of these hex switches (x16, x1) are used to configure the POWERLINK station number. Station numbers between #00 and #FD are permitted.		
Switch position		
x1	x16	Description
0	0	Operation as managing node
1 ... D	0 ... F	station number Operation as controlled node
E	F	Reserved
F	F	Reserved

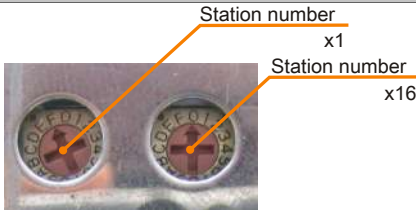

Table 58: POWERLINK station number (x1, x16)

3.8.4.3.4 Card number switch

The one-digit card number (\$ – \$F) is configured using the card number switch. This number is used to identify the module.

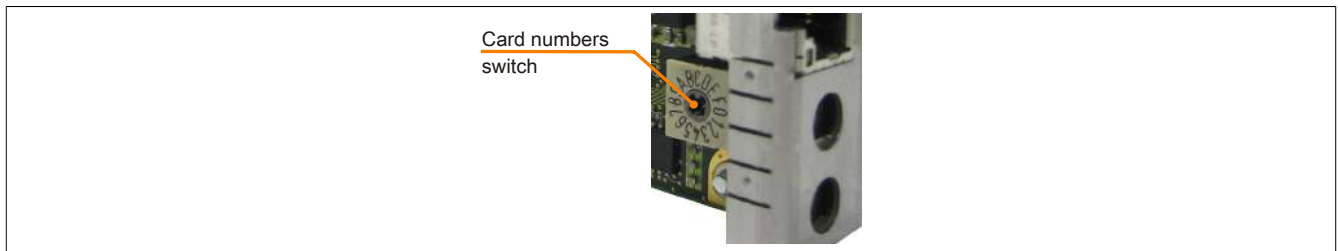

Figure 28: POWERLINK card - 2-port node number switch

If the card is operated with Automation Runtime, then the card number switch must match the slot number in Automation Studio.



Figure 29: Integrating the POWERLINK plug-in card in Automation Studio

3.8.4.3.5 SRAM

The 2-port 5ACPCC.MPL0-00 POWERLINK card has 512 kB SRAM.

3.9 Drives

3.9.1 5AC801.HDDI-00

3.9.1.1 General information

This 40 GB slide-in compact hard disk is specified for 24-hour operation, features an extended temperature range and can be used in APC810 and PPC800 system units.

When used in a PPC800

Information:

The adapter 5AC803.BC02-00 is required for the use of slide-in compact drives.

When inserted in the slide-in compact slot, the slide-in compact drive is accessed internally via SATA.

3.9.1.2 Order data

Model number	Short description	Figure
5AC801.HDDI-00	Drives 40 GB SATA slide-in compact hard disk; 24/7 operation with extended temperature range. Note: please see the manual for information about using this hard disk	

Table 59: 5AC801.HDDI-00 - Order data

3.9.1.3 Technical data

Information:

The following characteristics, features and limit values only apply to this individual component and can deviate from those specified for the complete system. For the complete system in which this individual component is used, refer to the data given specifically for that device.

Product ID	5AC801.HDDI-00
General information	
Certification	
CE	Yes
cULus	Yes
GOST-R	Yes
GL	Yes ¹⁾
Hard disk drive	
Capacity	40 GB
Number of heads	1
Number of sectors	78,140,160
Bytes per sector	512
Cache	8 MB
Speed	5400 rpm ±1%
Startup time	Typ. 3 s (from 0 rpm to read access)
MTBF	750,000 POH ²⁾
S.M.A.R.T. support	Yes
Interface	SATA
Access time	5.6 ms
Data transfer rate	
Internal	Max. 450 Mbit/s
To/From host	Max. 150 MB/s (Ultra DMA mode 5)

Table 60: 5AC801.HDDI-00 - Technical data

Product ID	5AC801.HDDI-00
Positioning time	
Minimum (track to track)	1 ms
Nominal (read only)	12.5 ms
Maximum (read only)	23 ms
Environmental conditions	
Temperature ³⁾	
Operation ⁴⁾	-30 to 85°C
24-hour operation ⁵⁾	-30 to 85°C
Storage	-40 to 95°C
Transport	-40 to 95°C
Relative humidity ⁶⁾	
Operation	5 to 90%, non-condensing
Storage	5 to 95%, non-condensing
Transport	5 to 95%, non-condensing
Vibration	
Operation	5 to 500 Hz: 2 g; no unrecoverable errors
Storage	5 to 500 Hz: 5 g; no unrecoverable errors
Transport	5 to 500 Hz: 5 g; no unrecoverable errors
Shock	
Operation	300 g and 2 ms duration; no unrecoverable errors 150 g and 11 ms duration; no unrecoverable errors
Storage	800 g and 2 ms duration; no unrecoverable errors
Transport	400 g and 0.5 ms duration; no unrecoverable errors 800 g and 2 ms duration; no unrecoverable errors 400 g and 0.5 ms duration; no unrecoverable errors
Altitude	
Operation	-300 to 5000 m
Storage	-300 to 12192 m
Mechanical characteristics	
Installation	Fixed ⁷⁾
Dimensions	
Width	13 mm
Height	98 mm
Depth	105 mm
Weight	134 g
Manufacturer information	
Manufacturer	Seagate
Manufacturer's product ID	ST940817SM

Table 60: 5AC801.HDDI-00 - Technical data

- 1) Yes, although applies only if all components installed within the complete system have this certification
- 2) With 8760 POH (power-on hours) per year and 70°C surface temperature.
- 3) Temperature values at an elevation of 305 meters. The temperature specification must be reduced linearly by 1°C every 305 meters. The temperature increase and decrease can be a maximum of 20°C per hour.
- 4) Standard operation refers to 333 POH (power-on hours) per month.
- 5) 24-hour operation refers to 732 POH (power-on hours) per month.
- 6) Humidity gradient: Maximum 15% per hour.
- 7) Slide-in compact installation.

3.9.1.4 Temperature humidity diagram

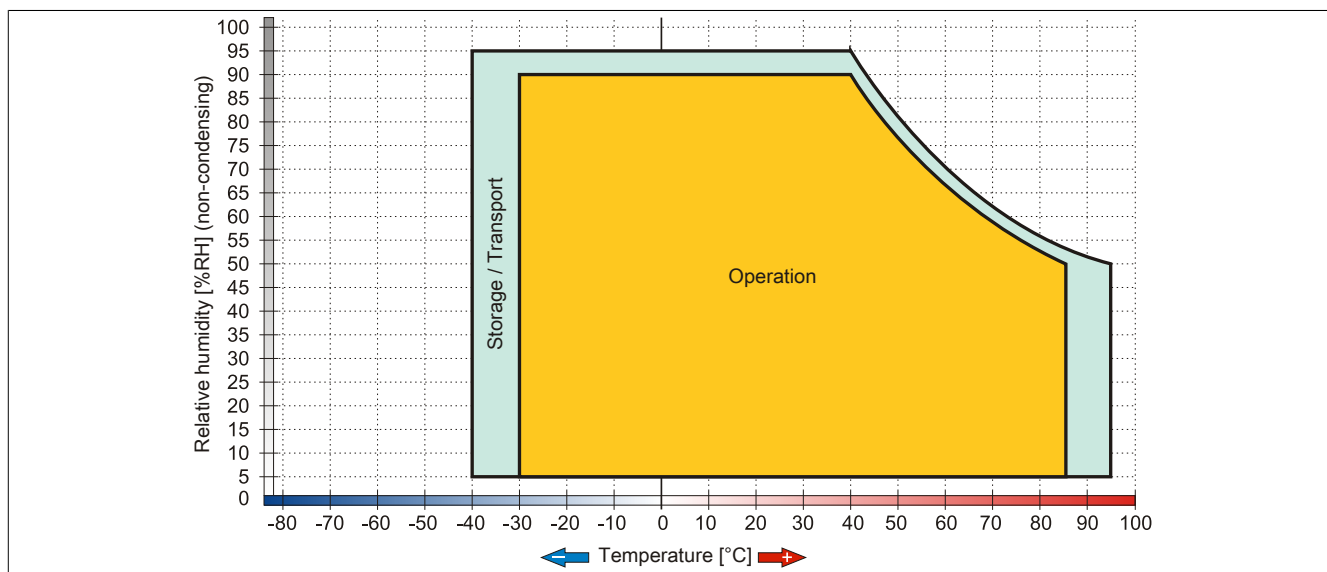

Figure 30: 5AC801.HDDI-00 - Temperature humidity diagram

3.9.2 5AC801.HDDI-03

3.9.2.1 General information

This 250 GB slide-in compact hard disk is specified for 24-hour operation and can be used in APC810 and PPC800 system units.

When used in a PPC800

Information:

The adapter 5AC803.BC02-00 is required for the use of slide-in compact drives.

When inserted in the slide-in compact slot, the slide-in compact drive is accessed internally via SATA.

3.9.2.2 Order data

Model number	Short description	Figure
	Drives	
5AC801.HDDI-03	250 GB slide-in compact SATA hard disk, 24/7 operation. Note: please see the manual for information about using this hard disk	
	Optional accessories	
	Drives	
5MMHDD.0250-00	250 GB SATA hard disk; replacement for 5AC801.HDDI-03 and 5ACPCI.RAIC-05; note: please see the manual for information about using this hard disk	

Table 61: 5AC801.HDDI-03 - Order data

3.9.2.3 Technical data

Information:

The following characteristics, features and limit values only apply to this individual component and can deviate from those specified for the complete system. For the complete system in which this individual component is used, refer to the data given specifically for that device.

Product ID	5AC801.HDDI-03
General information	
Certification	
CE	Yes
cULus	Yes
cULus HazLoc Class 1 Division 2	Yes ¹⁾
ATEX Zone 22	Yes ¹⁾
GOST-R	Yes
GL	Yes ¹⁾
Hard disk drive	
Capacity	250 GB
Number of heads	1
Number of sectors	488,397,168
Bytes per sector	512
Cache	8 MB
Speed	5400 rpm ±0.2%
Startup time	Typ. 3.6 s (from 0 rpm to read access)
MTBF	550,000 POH ²⁾
S.M.A.R.T. support	Yes
Interface	SATA
Access time	5.56 ms
Supported transfer modes	SATA 1.0, Serial ATA Revision 2.6 PIO mode 0-4, multiword DMA mode 0-2, UDMA mode 0-6
Data transfer rate	
Internal	Max. 1175 Mbit/s
To/From host	Max. 150 MB/s (SATA I), max. 300 MB/s (SATA II)

Table 62: 5AC801.HDDI-03 - Technical data

Product ID	5AC801.HDDI-03
Positioning time	
Minimum (track to track)	1 ms
Nominal (read only)	14 ms
Maximum (read only)	30 ms
Environmental conditions	
Temperature ³⁾	
Operation ⁴⁾	0 to 60°C
24-hour operation ⁵⁾	0 to 60°C
Storage	-40 to 70°C
Transport	-40 to 70°C
Relative humidity ⁶⁾	
Operation	5 to 95%, non-condensing
Storage	5 to 95%, non-condensing
Transport	5 to 95%, non-condensing
Vibration	
Operation	5 to 500 Hz: 0.5 g; no unrecoverable errors
Storage	5 to 500 Hz: 5 g; no unrecoverable errors
Transport	5 to 500 Hz: 5 g; no unrecoverable errors
Shock	
Operation	350 g and 2 ms duration; no unrecoverable errors
Storage	800 g and 2 ms duration; no unrecoverable errors
Transport	1000 g and 1 ms duration; no unrecoverable errors
Transport	600 g and 0.5 ms duration; no unrecoverable errors
Transport	800 g and 2 ms duration; no unrecoverable errors
Transport	1000 g and 1 ms duration; no unrecoverable errors
Transport	600 g and 0.5 ms duration; no unrecoverable errors
Altitude	
Operation	-300 to 3048 m
Storage	-300 to 12192 m
Mechanical characteristics	
Installation	Fixed ⁷⁾
Dimensions	
Width	13 mm
Height	98 mm
Depth	105 mm
Weight	134 g
Manufacturer information	
Manufacturer	Seagate
Manufacturer's product ID	ST9250315AS

Table 62: 5AC801.HDDI-03 - Technical data

- 1) Yes, although applies only if all components installed within the complete system have this certification
- 2) With 8760 POH (power-on hours) per year and 25°C surface temperature.
- 3) Temperature values at an elevation of 305 meters. The temperature specification must be reduced linearly by 1°C every 305 meters. The temperature increase and decrease can be a maximum of 20°C per hour.
- 4) Standard operation refers to 333 POH (power-on hours) per month.
- 5) 24-hour operation refers to 732 POH (power-on hours) per month.
- 6) Humidity gradient: Maximum 30% per hour.
- 7) Slide-in compact installation.

3.9.2.4 Temperature humidity diagram

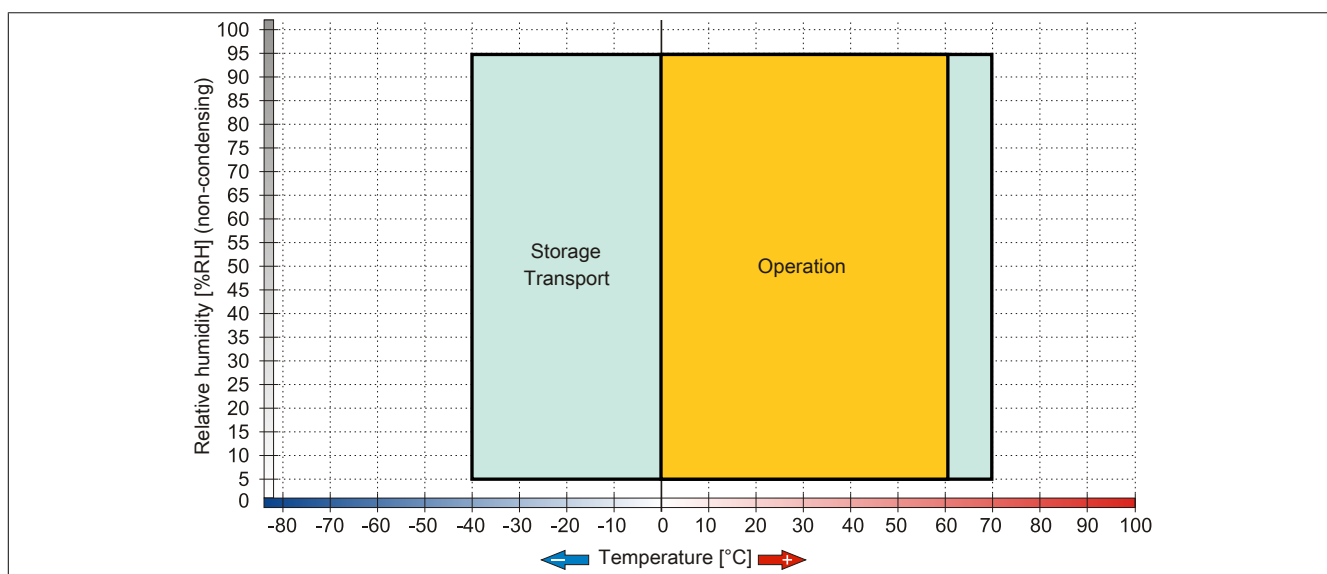

Figure 31: 5AC801.HDDI-03 - Temperature humidity diagram

3.9.3 5AC801.HDDI-04

3.9.3.1 General information

This 500 GB slide-in compact hard disk is specified for 24-hour operation and can be used in APC810 and PPC800 system units.

- 500 GB hard disk
- Slide-in compact
- Specified for 24-hour operation
- S.M.A.R.T. support

When used in a PPC800

Information:

The adapter 5AC803.BC02-00 is required for the use of slide-in compact drives.

When inserted in the slide-in compact slot, the slide-in compact drive is accessed internally via SATA.

3.9.3.2 Order data

Model number	Short description	Figure
	Drives	
5AC801.HDDI-04	500 GB SATA hard disk, slide-in compact, 24/7 operation Note: please see the manual for information about using this hard disk	
	Optional accessories	
	Drives	
5MMHDD.0500-00	500 GB hard disk - SATA	

Table 63: 5AC801.HDDI-04 - Order data

3.9.3.3 Technical data

Information:

The following characteristics, features and limit values only apply to this accessory and can deviate from those specified for the complete system. The data specifications for the complete system take precedence over those of individual components.

Product ID	5AC801.HDDI-04
General information	
Certification	
CE	Yes
cULus	Yes
GOST-R	Yes
GL	Yes ¹⁾
Hard disk drive	
Capacity	500 GB
Number of heads	2
Number of sectors	976,773,168
Bytes per sector	512 (logical) / 4096 (physical)
Cache	16 MB
Speed	5400 rpm ±0.2%
Startup time	Typ. 3.5 s (from 0 rpm to read access)
Service life	5 years
MTBF	1,000,000 POH ²⁾
S.M.A.R.T. support	Yes
Interface	SATA
Access time	5.5 ms
Supported transfer modes	SATA II
Data transfer rate	
Internal	Max. 147 MB/s
To/From host	Max. 150 MB/s (SATA I), max. 300 MB/s (SATA II)
Positioning time	
Nominal (read only)	11 ms
Maximum (read only)	21 ms

Table 64: 5AC801.HDDI-04 - Technical data

Product ID	5AC801.HDDI-04
Environmental conditions	
Temperature ³⁾	
Operation ⁴⁾	0 to 60°C
24-hour operation ⁵⁾	0 to 60°C
Storage	-40 to 70°C
Transport	-40 to 70°C
Relative humidity ⁶⁾	
Operation	5 to 95%, non-condensing
Storage	5 to 95%, non-condensing
Transport	5 to 95%, non-condensing
Vibration	
Operation (continuous)	5 to 500 Hz: 0.25 g; no unrecoverable errors
Operation (occasional)	5 to 500 Hz: 0.5 g; no unrecoverable errors
Storage	10 to 500 Hz: 5 g; no unrecoverable errors
Transport	10 to 500 Hz: 5 g; no unrecoverable errors
Shock	
Operation	400 g and 2 ms duration; no unrecoverable errors
Storage	1000 g and 2 ms duration; no unrecoverable errors
Transport	1000 g and 2 ms duration; no unrecoverable errors
Altitude	
Operation	-305 to 3048 m
Storage	-305 to 12192 m
Mechanical characteristics	
Installation	Fixed ⁷⁾
Dimensions	
Width	13 mm
Height	98 mm
Depth	105 mm
Weight	134 g
Manufacturer information	
Manufacturer	Western Digital
Manufacturer's product ID	WD5000LUCT

Table 64: 5AC801.HDDI-04 - Technical data

- 1) Yes, although applies only if all components installed within the complete system have this certification
- 2) With 8760 POH (power-on hours) per year and 25°C surface temperature.
- 3) Temperature values at an elevation of 305 meters. The temperature specification must be reduced linearly by 1°C every 305 meters. The temperature increase and decrease can be a maximum of 20°C per hour.
- 4) Standard operation refers to 333 POH (power-on hours) per month.
- 5) 24-hour operation refers to 732 POH (power-on hours) per month.
- 6) Humidity gradient: Maximum 20% per hour.
- 7) Slide-in compact installation.

3.9.3.4 Temperature humidity diagram

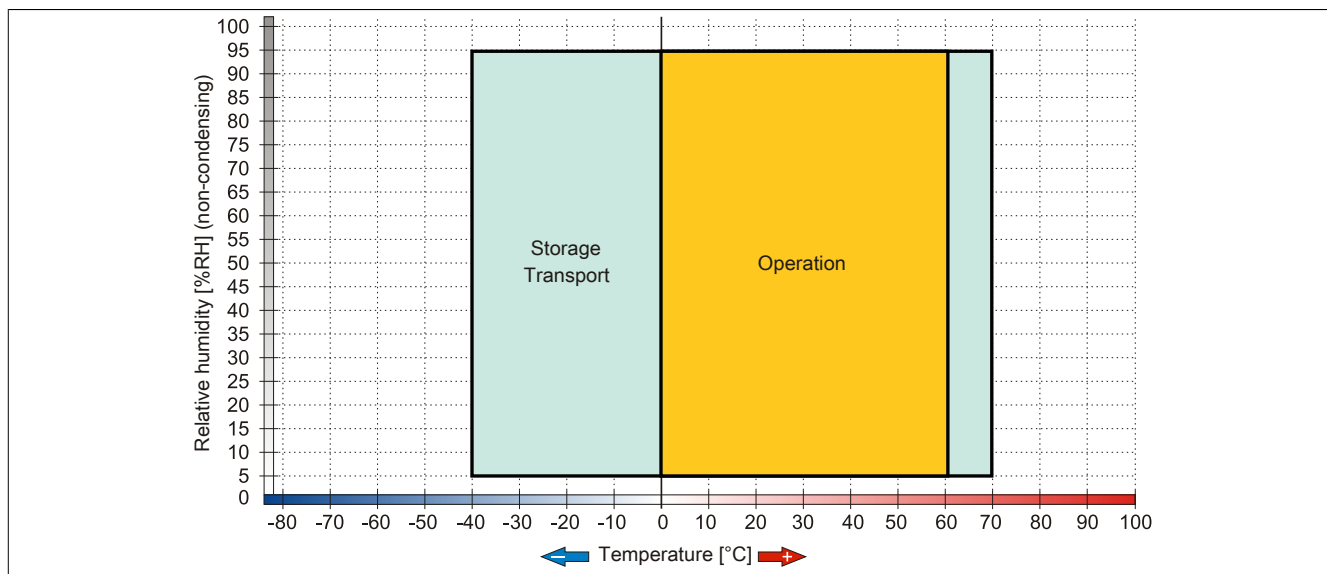

Figure 32: 5AC801.HDDI-04 - Temperature humidity diagram

3.9.4 5AC801.SSDI-00

3.9.4.1 General information

This 32 GB slide-in compact SSD (solid-state drive) is based on single-level cell (SLC) technology and can be used in APC810 and PPC800 system units.

When used in a PPC800

Information:

The adapter 5AC803.BC02-00 is required for the use of slide-in compact drives.

When inserted in the slide-in compact slot, the slide-in compact drive is accessed internally via SATA.

3.9.4.2 Order data

Model number	Short description	Figure
	Drives	
5AC801.SSDI-00	32 GB SATA SSD (SLC), slide-in compact	

Table 65: 5AC801.SSDI-00 - Order data

3.9.4.3 Technical data

Caution!

A sudden power failure may result in data loss! In very rare cases, the mass storage device may also become damaged.

To prevent damage and loss of data, the use of a UPS is recommended.

Information:

The following characteristics, features and limit values only apply to this individual component and can deviate from those specified for the complete system. For the complete system in which this individual component is used, refer to the data given specifically for that device.

Product ID	5AC801.SSDI-00
General information	
Certification	
CE	Yes
cULus	Yes
GOST-R	Yes
GL	Yes ¹⁾
Solid state drive	
Capacity	32 GB
Data reliability	<1 unrecoverable error in 10 ¹⁵ bit read accesses
MTBF	2,000,000 hours
Power on/off cycles	50,000
S.M.A.R.T. support	Yes
Interface	SATA
Maintenance	None
Continuous reading	Max. 250 MB/s
Continuous writing	Max. 170 MB/s

Table 66: 5AC801.SSDI-00 - Technical data

Technical data • Individual components

Product ID	5AC801.SSDI-00
IOPS ²⁾	
4k read	35,000
4k write	3,300
Endurance	
SLC flash	Yes
Guaranteed data volume	
Guaranteed	700 TB
Results for 5 years	350 GB/day
Wear leveling	Static
Error correction coding (ECC)	Yes
Compatibility	SATA revision 2.6 compliant, compatible with SATA 1.5 Gbit/s and 3 Gbit/s interface rates ATA/ATAPI-7 SSD Enhanced SMART ATA feature set Native Command Queuing (NCQ)
Environmental conditions	
Temperature	
Operation	0 to 70°C
Storage	-55 to 95°C
Transport	-55 to 95°C
Relative humidity	
Operation	5 to 95%, non-condensing
Storage	5 to 95%, non-condensing
Transport	5 to 95%, non-condensing
Vibration	
Operation	7 to 800 Hz: 2.17 g
Storage	10 to 500 Hz: 3.13 g
Transport	10 to 500 Hz: 3.13 g
Shock	
Operation	1000 g, 0.5 ms
Storage	1000 g, 0.5 ms
Transport	1000 g, 0.5 ms
Altitude	
Operation	-300 to 12192 m
Storage	-300 to 12192 m
Transport	-300 to 12192 m
Mechanical characteristics	
Installation	Fixed ³⁾
Dimensions	
Width	13 mm
Height	98 mm
Depth	105 mm
Weight	118 g
Manufacturer information	
Manufacturer	Intel
Manufacturer's product ID	SSDSA2SH032G1

Table 66: 5AC801.SSDI-00 - Technical data

- 1) Yes, although applies only if all components installed within the complete system have this certification
- 2) IOPS: Random read and write input/output operations per second.
- 3) Slide-in compact installation.

3.9.4.4 Temperature/Humidity diagram

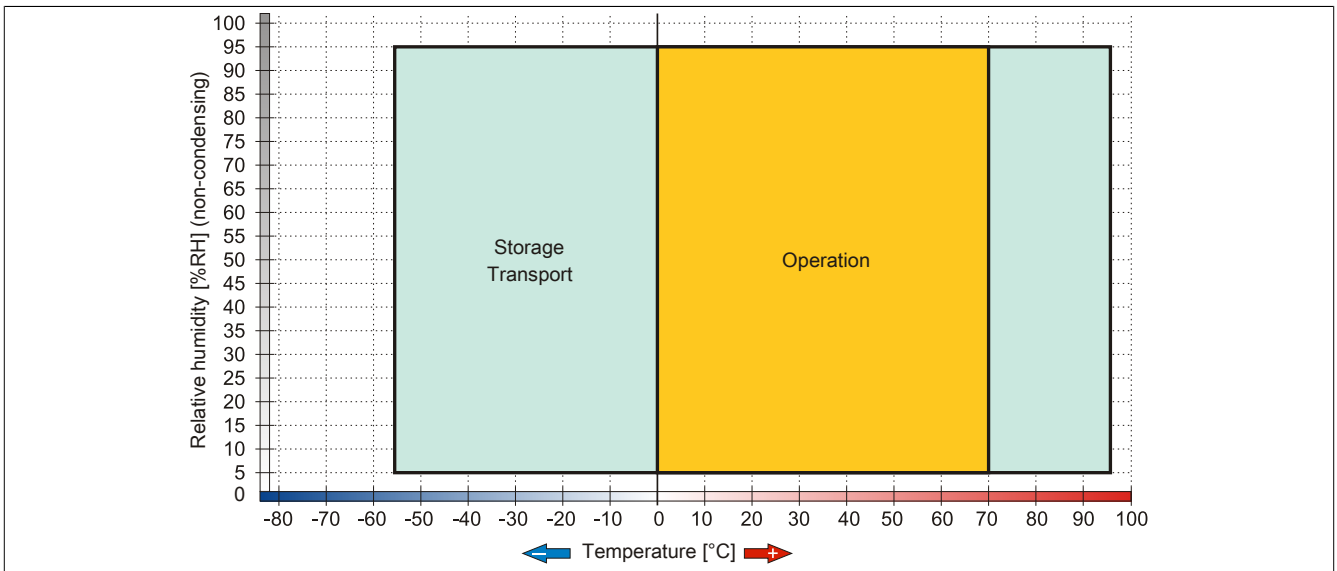

Figure 33: 5AC801.SSDI-00 - Temperature/Humidity diagram

3.9.4.5 Benchmark

The following two benchmarks show a comparison of the Intel solid-state drive (5AC801.SSDI-00) and the Seagate hard disk (5AC801.HDDI-00) for cyclic reading and writing.

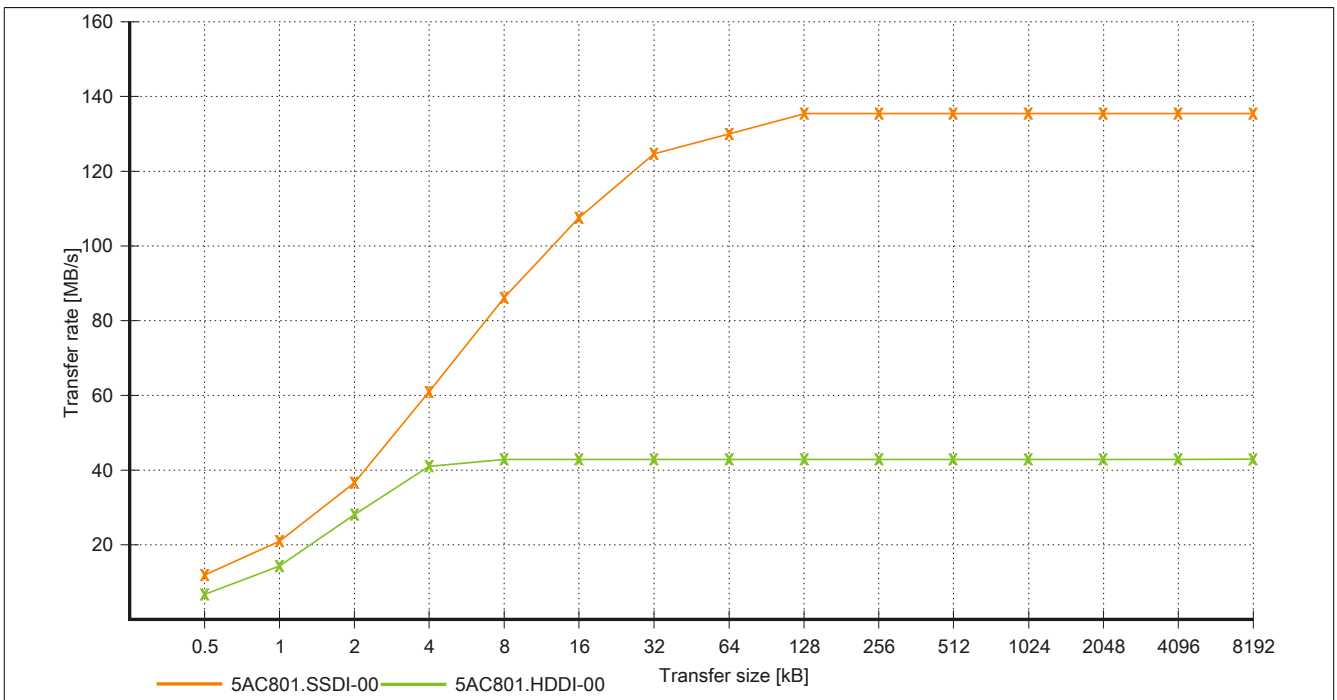

Figure 34: 5AC801.SSDI-00 - ATTO disk benchmark v2.34 - cyclic read

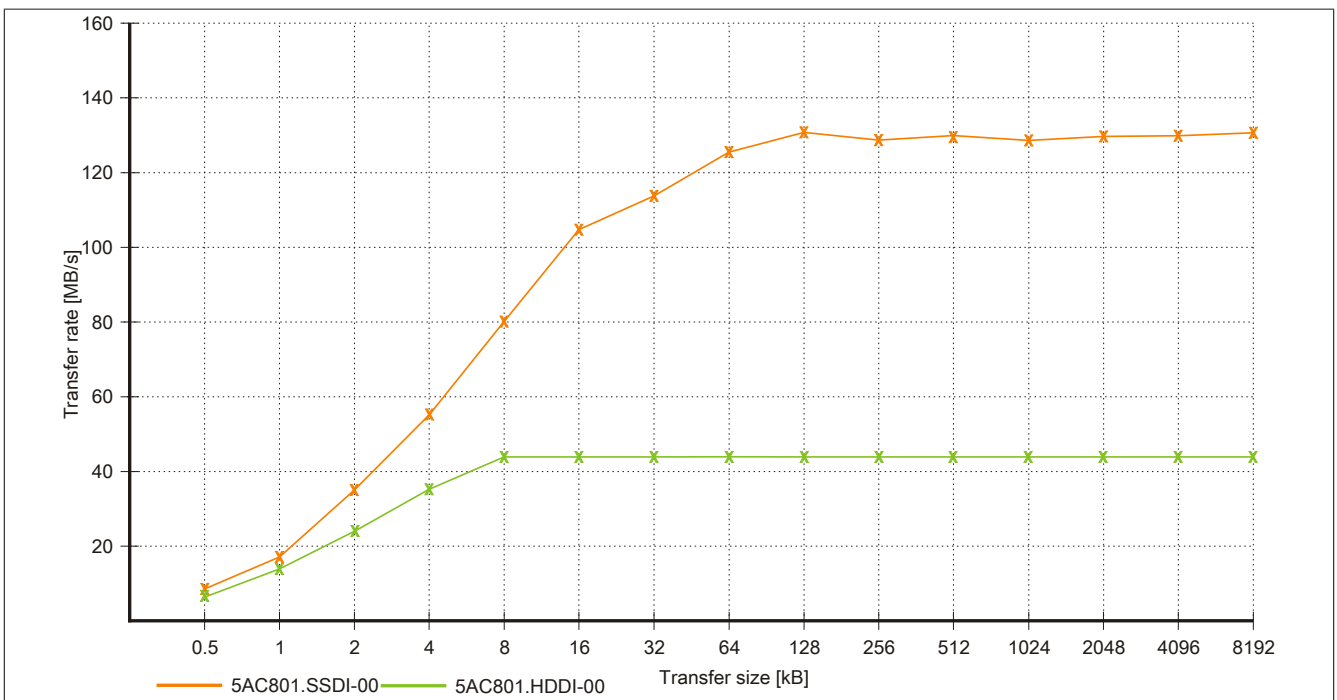

Figure 35: 5AC801.SSDI-00 - ATTO disk benchmark v2.34 - cyclic write

3.9.5 5AC801.SSDI-01

3.9.5.1 General information

This 60 GB slide-in compact SSD (solid-state drive) is based on multi-level cell (MLC) technology and can be used in APC810 and PPC800 system units.

When used in a PPC800

Information:

The adapter 5AC803.BC02-00 is required for the use of slide-in compact drives.

When inserted in the slide-in compact slot, the slide-in compact drive is accessed internally via SATA.

3.9.5.2 Order data

Model number	Short description	Figure
	Drives	
5AC801.SSDI-01	60 GB SATA slide-in compact SSD (MLC)	
	Optional accessories	
	Drives	
5MMSSD.0060-00	60 GB SSD MLC - Intel - SATA	

Table 67: 5AC801.SSDI-01 - Order data

3.9.5.3 Technical data

Caution!

A sudden power failure may result in data loss! In very rare cases, the mass storage device may also become damaged.

To prevent damage and loss of data, the use of a UPS is recommended.

Information:

The following characteristics, features and limit values only apply to this accessory and can deviate from those specified for the complete system. The data specifications for the complete system take precedence over those of individual components.

Product ID	5AC801.SSDI-01
General information	
Certification	
CE	Yes
cULus	Yes
GOST-R	Yes
GL	Yes ¹⁾
Solid-state drive	
Capacity	60 GB
Data reliability	<1 unrecoverable error in 10 ¹⁶ bit read accesses
MTBF	1,200,000 hours
S.M.A.R.T. support	Yes
Interface	SATA
Maintenance	None
Sequential read	Max. 550 MB/s with SATA 6 Gbit/s Max. 280 MB/s with SATA 3 Gbit/s
Sequential write	Max. 475 MB/s with SATA 6 Gbit/s Max. 245 MB/s with SATA 3 Gbit/s

Table 68: 5AC801.SSDI-01 - Technical data

Product ID	5AC801.SSDI-01
IOPS ²⁾	
4k read	15,000
4k write	
Typical	23,000
Maximum	80,000
Endurance	
MLC flash	Yes
Compatibility	SATA 3.0 compliant ACS-2 SSD Enhanced SMART ATA feature set Native Command Queuing (NCQ)
Environmental conditions	
Temperature	
Operation	0 to 70°C
Storage	-55 to 95°C
Transport	-55 to 95°C
Relative humidity	
Operation	5 to 95%, non-condensing
Storage	5 to 95%, non-condensing
Transport	5 to 95%, non-condensing
Vibration	
Operation	5 to 700 Hz: 2.17 g
Storage	5 to 800 Hz: 3.13 g
Transport	5 to 800 Hz: 3.13 g
Shock	
Operation	1500 g, 0.5 ms
Storage	1500 g, 0.5 ms
Transport	1500 g, 0.5 ms
Altitude	
Operation	-300 to 12192 m
Storage	-300 to 12192 m
Transport	-300 to 12192 m
Mechanical characteristics	
Installation	Fixed ³⁾
Dimensions	
Width	13 mm
Height	98 mm
Depth	105 mm
Weight	118 g
Manufacturer information	
Manufacturer	Intel
Manufacturer's product ID	SSDSC2CW060A3

Table 68: 5AC801.SSDI-01 - Technical data

- 1) Yes, although applies only if all components installed within the complete system have this certification
- 2) IOPS: Random read and write input/output operations per second.
- 3) Slide-in compact installation.

3.9.5.4 Temperature humidity diagram

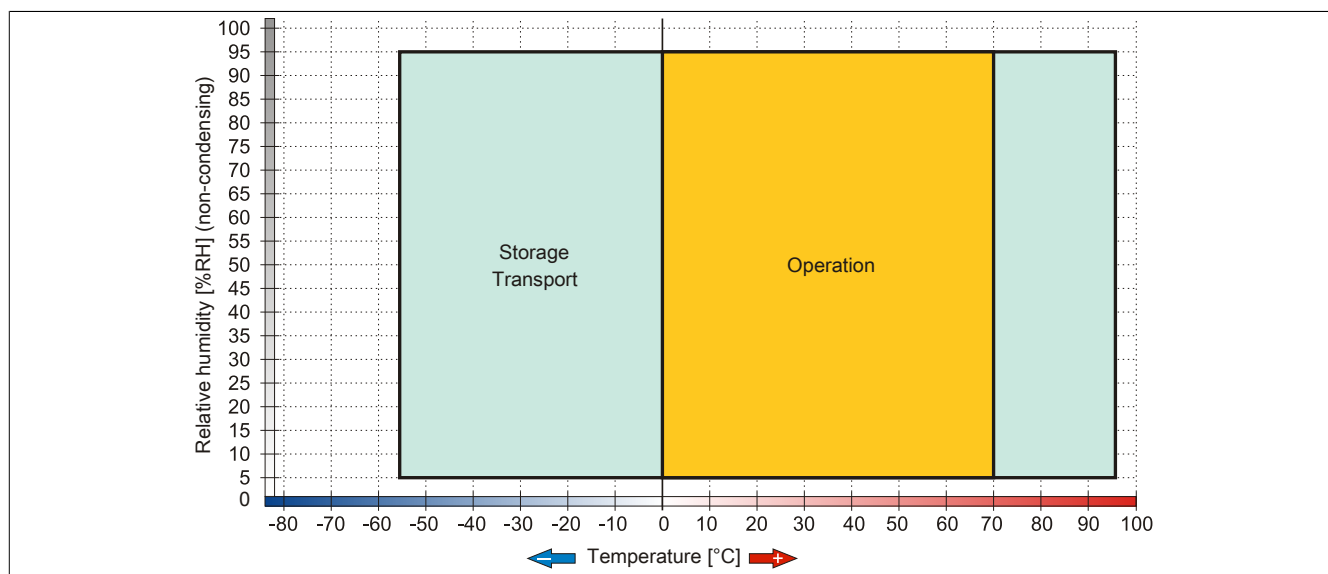

Figure 36: 5AC801.SSDI-01 - Temperature humidity diagram

3.9.6 5AC801.SSDI-02

3.9.6.1 General information

This 180 GB slide-in compact SSD (solid-state drive) is based on multi-level cell (MLC) technology and can be used in APC810 and PPC800 system units.

When used in a PPC800

Information:

The adapter 5AC803.BC02-00 is required for the use of slide-in compact drives.

When inserted in the slide-in compact slot, the slide-in compact drive is accessed internally via SATA.

3.9.6.2 Order data

Model number	Short description	Figure
	Drives	
5AC801.SSDI-02	180 GB SATA slide-in compact SSD (MLC)	
	Optional accessories	
	Drives	
5MMSSD.0180-00	180 GB SSD MLC - Intel - SATA	

Table 69: 5AC801.SSDI-02 - Order data

3.9.6.3 Technical data

Caution!

A sudden power failure may result in data loss! In very rare cases, the mass storage device may also become damaged.

To prevent damage and loss of data, the use of a UPS is recommended.

Information:

The following characteristics, features and limit values only apply to this accessory and can deviate from those specified for the complete system. The data specifications for the complete system take precedence over those of individual components.

Product ID	5AC801.SSDI-02
General information	
Certification	
CE	Yes
cULus	Yes
GOST-R	Yes
GL	Yes ¹⁾
Solid-state drive	
Capacity	180 GB
Data reliability	<1 unrecoverable error in 10 ¹⁶ bit read accesses
MTBF	1,200,000 hours
S.M.A.R.T. support	Yes
Interface	SATA
Maintenance	None
Sequential read	Max. 550 MB/s with SATA 6 Gbit/s Max. 280 MB/s with SATA 3 Gbit/s
Sequential write	Max. 520 MB/s with SATA 6 Gbit/s Max. 260 MB/s with SATA 3 Gbit/s

Table 70: 5AC801.SSDI-02 - Technical data

Product ID	5AC801.SSDI-02
IOPS ²⁾	
4k read	50,000
4k write	
Typical	60,000
Maximum	80,000
Endurance	
MLC flash	Yes
Compatibility	SATA 3.0 compliant ACS-2 SSD Enhanced SMART ATA feature set Native Command Queuing (NCQ)
Environmental conditions	
Temperature	
Operation	0 to 70°C
Storage	-55 to 95°C
Transport	-55 to 95°C
Relative humidity	
Operation	5 to 95%, non-condensing
Storage	5 to 95%, non-condensing
Transport	5 to 95%, non-condensing
Vibration	
Operation	5 to 700 Hz: 2.17 g
Storage	5 to 800 Hz: 3.13 g
Transport	5 to 800 Hz: 3.13 g
Shock	
Operation	1500 g, 0.5 ms
Storage	1500 g, 0.5 ms
Transport	1500 g, 0.5 ms
Altitude	
Operation	-300 to 12192 m
Storage	-300 to 12192 m
Transport	-300 to 12192 m
Mechanical characteristics	
Installation	Fixed ³⁾
Dimensions	
Width	13 mm
Height	98 mm
Depth	105 mm
Weight	118 g
Manufacturer information	
Manufacturer	Intel
Manufacturer's product ID	SSDSC2CW180A3

Table 70: 5AC801.SSDI-02 - Technical data

- 1) Yes, although applies only if all components installed within the complete system have this certification
- 2) IOPS: Random read and write input/output operations per second.
- 3) Slide-in compact installation.

3.9.6.4 Temperature humidity diagram

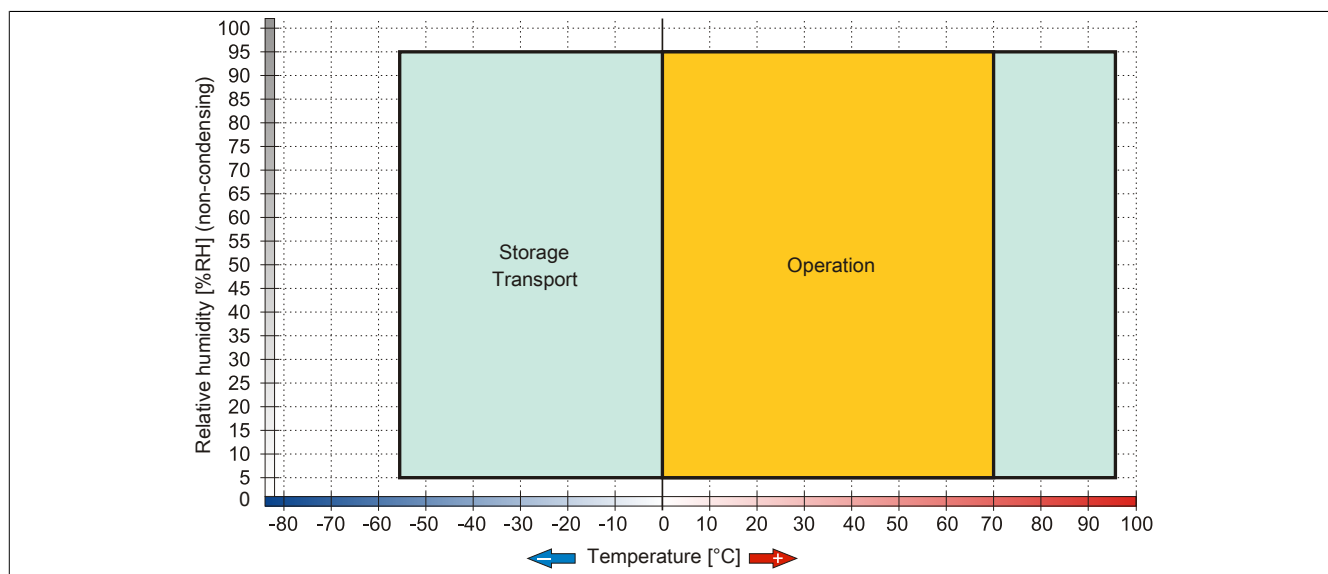

Figure 37: 5AC801.SSDI-02 - Temperature humidity diagram

3.9.7 5AC801.SSDI-03

3.9.7.1 General information

This 60 GB slide-in compact SSD (solid-state drive) is based on multi-level cell (MLC) technology and can be used in APC810 and PPC800 system units.

When used in a PPC800

Information:

The adapter 5AC803.BC02-00 is required for the use of slide-in compact drives.

When inserted in the slide-in compact slot, the slide-in compact drive is accessed internally via SATA.

3.9.7.2 Order data

Model number	Short description	Figure
	Drives	
5AC801.SSDI-03	60 GB SATA slide-in compact SSD (MLC)	
	Optional accessories	
	Drives	
5MMSSD.0060-01	60 GB SSD MLC - Intel - SATA	

Table 71: 5AC801.SSDI-03 - Order data

3.9.7.3 Technical data

Caution!

A sudden power failure may result in data loss! In very rare cases, the mass storage device may also become damaged.

To prevent damage and loss of data, the use of a UPS is recommended.

Information:

The following characteristics, features and limit values only apply to this accessory and can deviate from those specified for the complete system. The data specifications for the complete system take precedence over those of individual components.

Product ID	5AC801.SSDI-03	
Revision	C0	D0
General information		
Certification		
CE		Yes
cULus		Yes
GOST-R		Yes
GL		Yes ¹⁾
Solid-state drive		
Capacity		60 GB
Data reliability		<1 unrecoverable error in 10 ¹⁵ bit read accesses
MTBF		1,500,000 hours
S.M.A.R.T. support		Yes
Interface		SATA
Maintenance		None
Sequential read		Max. 510 MB/s
Sequential write		Max. 430 MB/s
IOPS ²⁾		
4k read		Max. 50,000 (random)
4k write		Max. 25,000 (random)
Endurance		
MLC flash		Yes
Guaranteed data volume		
Guaranteed		35 TBW ³⁾
Compatibility		SATA 3.0 compliant ACS-2 SSD Enhanced SMART ATA feature set Native Command Queuing (NCQ)

Table 72: 5AC801.SSDI-03, 5AC801.SSDI-03 - Technical data

Product ID	5AC801.SSDI-03	
Environmental conditions		
Temperature	0 to 70°C	-30 to 85°C
Operation		
Storage		-40 to 85°C
Transport		-40 to 85°C
Relative humidity		
Operation	8 to 90%, non-condensing	5 to 90%, non-condensing
Storage	8 to 95%, non-condensing	5 to 95%, non-condensing
Transport	8 to 95%, non-condensing	5 to 95%, non-condensing
Vibration		
Operation		10 to 2000 Hz: 20 g
Storage		10 to 2000 Hz: 20 g
Transport		10 to 2000 Hz: 20 g
Shock		
Operation		1500 g, 0.5 ms
Storage		1500 g, 0.5 ms
Transport		1500 g, 0.5 ms
Altitude		
Operation		-300 to 12192 m
Storage		-300 to 12192 m
Transport		-300 to 12192 m
Mechanical characteristics		
Installation		Fixed ⁴⁾
Dimensions		
Width		13 mm
Height		98 mm
Depth		105 mm
Weight		118 g
Manufacturer information		
Manufacturer		Toshiba
Manufacturer's product ID	THNSNH060GBST	THNSNJ060WCST

Table 72: 5AC801.SSDI-03, 5AC801.SSDI-03 - Technical data

- 1) Yes, although applies only if all components installed within the complete system have this certification
- 2) IOPS: Random read and write input/output operations per second.
- 3) TBW: Terabytes written
- 4) Slide-in compact installation.

3.9.7.4 Temperature humidity diagram

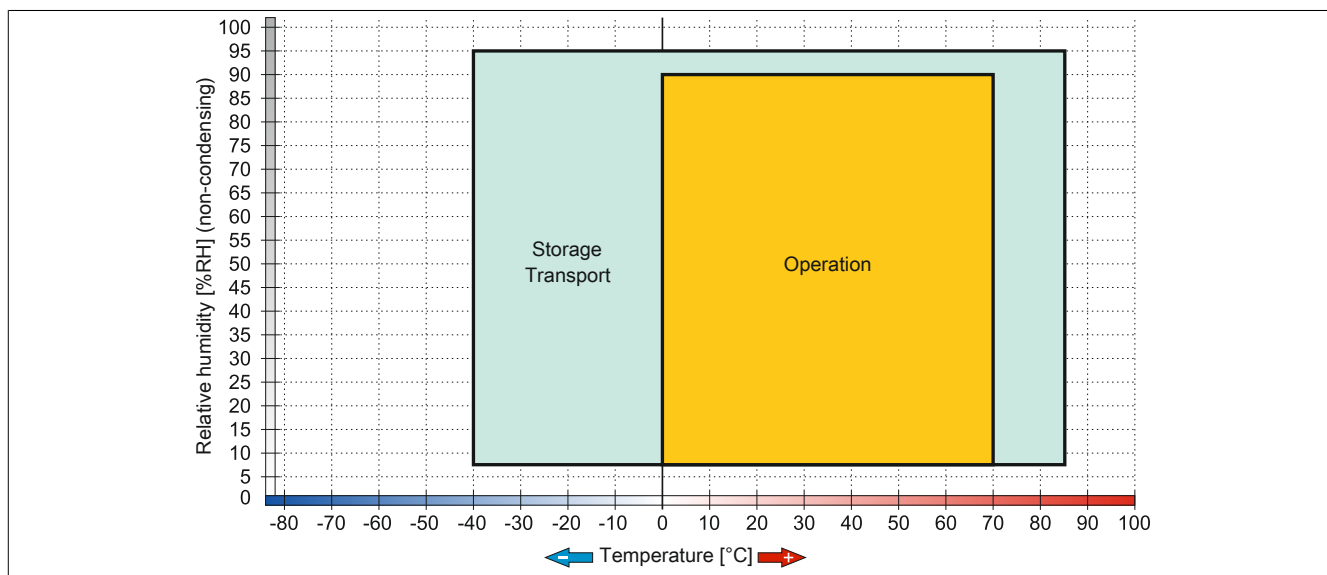

Figure 38: 5AC801.SSDI-03 ≤ Rev. C0 - Temperature/Humidity diagram

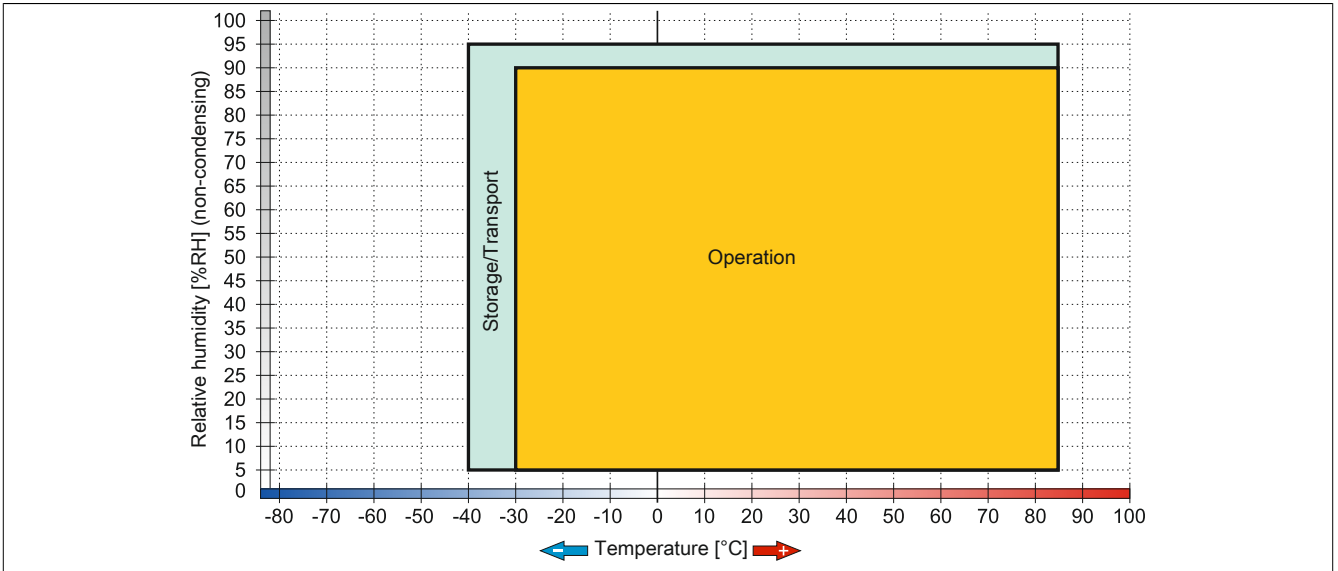

Figure 39: 5AC801.SSDI-03 ≥ Rev. D0 - Temperature/Humidity diagram

3.9.8 5AC801.SSDI-04

3.9.8.1 General information

This 128 GB slide-in compact SSD (solid-state drive) is based on multi-level cell (MLC) technology and can be used in APC810 and PPC800 system units.

When used in a PPC800

Information:

The adapter 5AC803.BC02-00 is required for the use of slide-in compact drives.

When inserted in the slide-in compact slot, the slide-in compact drive is accessed internally via SATA.

3.9.8.2 Order data

Model number	Short description	Figure
	Drives	
5AC801.SSDI-04	128 GB SATA SSD (MLC), slide-in compact	
	Optional accessories	
	Drives	
5MMSSD.0128-01	128 GB SSD MLC - Toshiba - SATA	

Table 73: 5AC801.SSDI-04 - Order data

3.9.8.3 Technical data

Caution!

A sudden power failure may result in data loss! In very rare cases, the mass storage device may also become damaged.

To prevent damage and loss of data, the use of a UPS is recommended.

Information:

The following characteristics, features and limit values only apply to this accessory and can deviate from those specified for the complete system. The data specifications for the complete system take precedence over those of individual components.

Product ID	5AC801.SSDI-04	
Revision	C0	D0
General information		
Certification		
CE		Yes
cULus		Yes
GOST-R		Yes
GL		Yes ¹⁾
Solid-state drive		
Capacity		128 GB
Data reliability		<1 unrecoverable error in 10 ¹⁵ bit read accesses
MTBF		1,500,000 hours
S.M.A.R.T. support		Yes
Interface		SATA
Maintenance		None
Sequential read		Max. 510 MB/s
Sequential write		Max. 450 MB/s

Table 74: 5AC801.SSDI-04, 5AC801.SSDI-04 - Technical data

Product ID		5AC801.SSDI-04	
IOPS ²⁾ 4k read 4k write		Max. 85,000 (random) Max. 35,000 (random)	
Endurance			
MLC flash		Yes	
Guaranteed data volume Guaranteed		74 TBW ³⁾	
Compatibility		SATA 3.0 compliant ACS-2 SSD Enhanced SMART ATA feature set Native Command Queuing (NCQ)	
Environmental conditions			
Temperature Operation Storage Transport	0 to 70°C	-40 to 85°C	-30 to 85°C
Relative humidity Operation Storage Transport	8 to 90%, non-condensing 8 to 95%, non-condensing 8 to 95%, non-condensing		5 to 90%, non-condensing 5 to 95%, non-condensing 5 to 95%, non-condensing
Vibration Operation Storage Transport		10 to 2000 Hz: 20 g 10 to 2000 Hz: 20 g 10 to 2000 Hz: 20 g	
Shock Operation Storage Transport		1500 g, 0.5 ms 1500 g, 0.5 ms 1500 g, 0.5 ms	
Altitude Operation Storage Transport		-300 to 12192 m -300 to 12192 m -300 to 12192 m	
Mechanical characteristics			
Installation		Fixed ⁴⁾	
Dimensions Width Height Depth		13 mm 98 mm 105 mm	
Weight		118 g	
Manufacturer information			
Manufacturer		Toshiba	
Manufacturer's product ID	THNSNH128GBST		THNSNJ128WCST

Table 74: 5AC801.SSDI-04, 5AC801.SSDI-04 - Technical data

- 1) Yes, although applies only if all components installed within the complete system have this certification
- 2) IOPS: Random read and write input/output operations per second.
- 3) TBW: Terabytes written
- 4) Slide-in compact installation.

3.9.8.4 Temperature humidity diagram

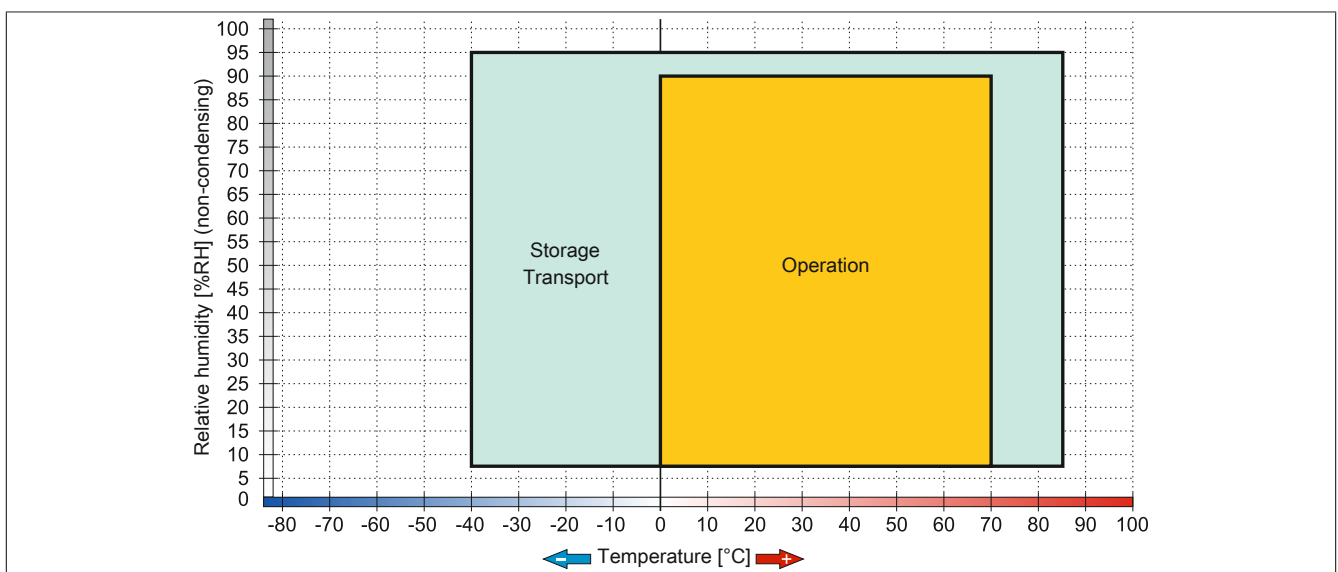

Figure 40: 5AC801.SSDI-04 ≤ Rev. C0 - Temperature/Humidity diagram

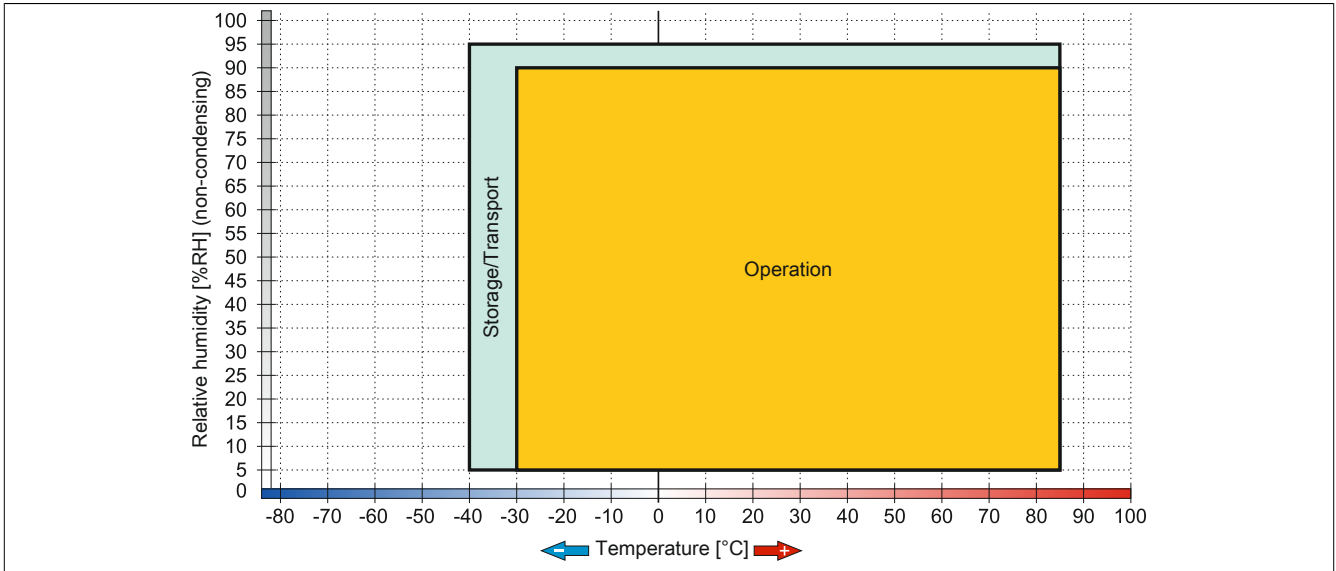

Figure 41: 5AC801.SSDI-04 ≥ Rev. D0 - Temperature/Humidity diagram

3.9.9 5AC801.SSDI-05

3.9.9.1 General information

This 256 GB slide-in compact SSD (solid-state drive) is based on multi-level cell (MLC) technology and can be used in APC810 and PPC800 system units.

When used in a PPC800

Information:

The adapter 5AC803.BC02-00 is required for the use of slide-in compact drives.

When inserted in the slide-in compact slot, the slide-in compact drive is accessed internally via SATA.

3.9.9.2 Order data

Model number	Short description	Figure
	Drives	
5AC801.SSDI-05	256 GB SATA slide-in compact SSD (MLC)	
	Optional accessories	
	Drives	
5MMSSD.0256-00	256 GB SSD MLC - Slide-in compact - Toshiba - SATA	

Table 75: 5AC801.SSDI-05 - Order data

3.9.9.3 Technical data

Caution!

A sudden power failure may result in data loss! In very rare cases, the mass storage device may also become damaged.

To prevent damage and loss of data, the use of a UPS is recommended.

Information:

The following characteristics, features and limit values only apply to this accessory and can deviate from those specified for the complete system. The data specifications for the complete system take precedence over those of individual components.

Product ID	5AC801.SSDI-05
General information	
Certification	
CE	Yes
cULus	Yes
GOST-R	Yes
GL	Yes ¹⁾
Solid-state drive	
Capacity	256 GB
Data reliability	<1 unrecoverable error in 10 ¹⁵ bit read accesses
MTBF	1,500,000 hours
S.M.A.R.T. support	Yes
Interface	SATA
Maintenance	None
Sequential read	Max. 510 MB/s
Sequential write	Max. 460 MB/s
IOPS ²⁾	
4k read	Max. 90,000 (random)
4k write	Max. 35,000 (random)

Table 76: 5AC801.SSDI-05 - Technical data

Product ID	5AC801.SSDI-05
Endurance	
MLC flash	Yes
Guaranteed data volume Guaranteed	148 TBW ³⁾
Compatibility	SATA 3.0 compliant ACS-2 SSD Enhanced SMART ATA feature set Native Command Queuing (NCQ)
Environmental conditions	
Temperature	
Operation	-30 to 85°C
Storage	-40 to 85°C
Transport	-40 to 85°C
Relative humidity	
Operation	5 to 90%, non-condensing
Storage	5 to 95%, non-condensing
Transport	5 to 95%, non-condensing
Vibration	
Operation	10 to 2000 Hz: 20 g
Storage	10 to 2000 Hz: 20 g
Transport	10 to 2000 Hz: 20 g
Shock	
Operation	1500 g, 0.5 ms
Storage	1500 g, 0.5 ms
Transport	1500 g, 0.5 ms
Altitude	
Operation	-300 to 12192 m
Storage	-300 to 12192 m
Transport	-300 to 12192 m
Mechanical characteristics	
Installation	Fixed ⁴⁾
Dimensions	
Width	13 mm
Height	98 mm
Depth	105 mm
Weight	118 g
Manufacturer information	
Manufacturer	Toshiba
Manufacturer's product ID	THNSNJ256WCST

Table 76: 5AC801.SSDI-05 - Technical data

- 1) Yes, although applies only if all components installed within the complete system have this certification
- 2) IOPS: Random read and write input/output operations per second.
- 3) TBW: Terabytes written
- 4) Slide-in compact installation.

3.9.9.4 Temperature humidity diagram

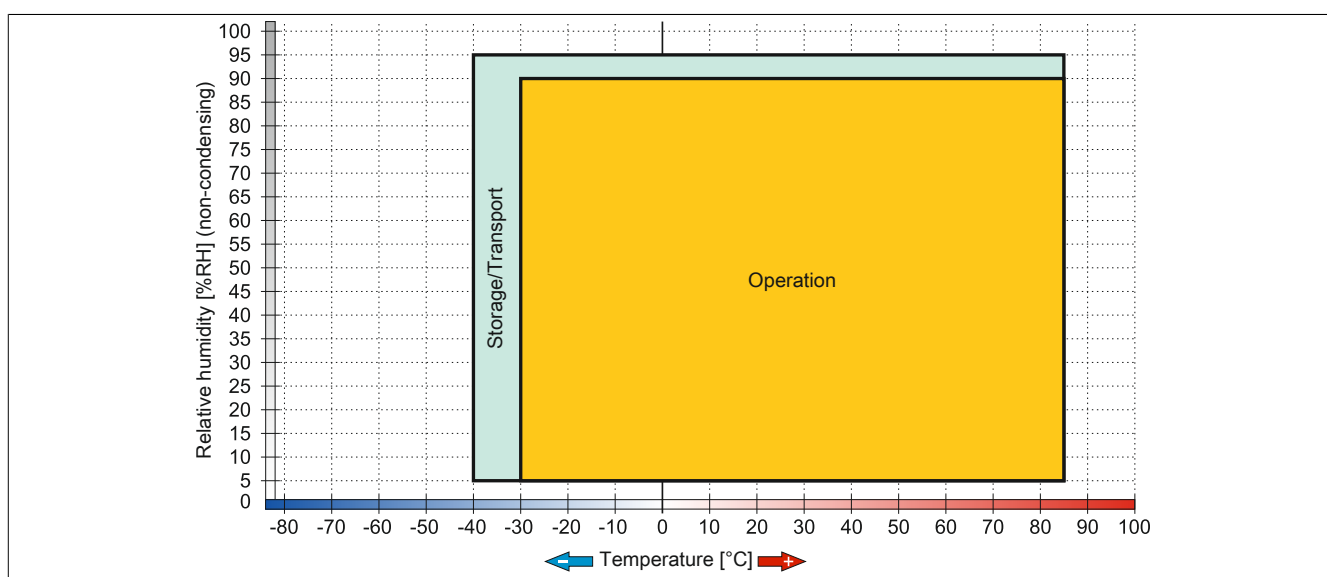

Figure 42: 5AC801.SSDI-05 - Temperature humidity diagram

3.9.10 5MMSSD.0060-00

3.9.10.1 General information

This 60 GB slide-in compact SSD (solid-state drive) is based on multi-level cell (MLC) technology and can be used as a replacement or accessory part.

- Replacement for 5AC801.SSDI-01 or 5AC901.CSSD-01 SSD drives
- Accessory for the APC510 (optional SSD for I/O board)

3.9.10.2 Order data

Model number	Short description	Figure
	Drives	
5MMSSD.0060-00	60 GB SSD MLC - Intel - SATA	

Table 77: 5MMSSD.0060-00 - Order data

3.9.10.3 Technical data

Caution!

A sudden power failure may result in data loss! In very rare cases, the mass storage device may also become damaged.

To prevent damage and loss of data, the use of a UPS is recommended.

Information:

The following characteristics, features and limit values only apply to this accessory and can deviate from those specified for the complete system. The data specifications for the complete system take precedence over those of individual components.

Product ID	5MMSSD.0060-00
General information	
Certification	
CE	Yes
cULus	Yes
cULus HazLoc Class 1 Division 2	Yes ¹⁾
GOST-R	Yes
Solid-state drive	
Capacity	60 GB
Data reliability	<1 unrecoverable error in 10 ¹⁶ bit read accesses
MTBF	1,200,000 hours
S.M.A.R.T. support	Yes
Interface	SATA
Maintenance	None
Sequential read	Max. 550 MB/s with SATA 6 Gbit/s Max. 280 MB/s with SATA 3 Gbit/s
Sequential write	Max. 475 MB/s with SATA 6 Gbit/s Max. 245 MB/s with SATA 3 Gbit/s
IOPS ²⁾	
4k read	15,000
4k write	
Typical	23,000
Maximum	80,000
Endurance	
MLC flash	Yes
Compatibility	SATA 3.0 compliant ACS-2 SSD Enhanced SMART ATA feature set Native Command Queuing (NCQ)

Table 78: 5MMSSD.0060-00 - Technical data

Product ID	5MMSSD.0060-00
Environmental conditions	
Temperature	
Operation	0 to 70°C
Storage	-55 to 95°C
Transport	-55 to 95°C
Relative humidity	
Operation	5 to 95%, non-condensing
Storage	5 to 95%, non-condensing
Transport	5 to 95%, non-condensing
Vibration	
Operation	5 to 700 Hz: 2.17 g
Storage	5 to 800 Hz: 3.13 g
Transport	5 to 800 Hz: 3.13 g
Shock	
Operation	1500 g, 0.5 ms
Storage	1500 g, 0.5 ms
Transport	1500 g, 0.5 ms
Altitude	
Operation	-300 to 12192 m
Storage	-300 to 12192 m
Transport	-300 to 12192 m
Mechanical characteristics	
Dimensions	
Width	9.5 mm
Height	69 mm
Depth	100 mm
Weight	78 g
Manufacturer information	
Manufacturer	Intel
Manufacturer's product ID	SSDSC2CW060A3

Table 78: 5MMSSD.0060-00 - Technical data

- 1) Yes, although applies only if all components installed within the complete system have this certification
- 2) IOPS: Random read and write input/output operations per second.

3.9.10.4 Temperature humidity diagram

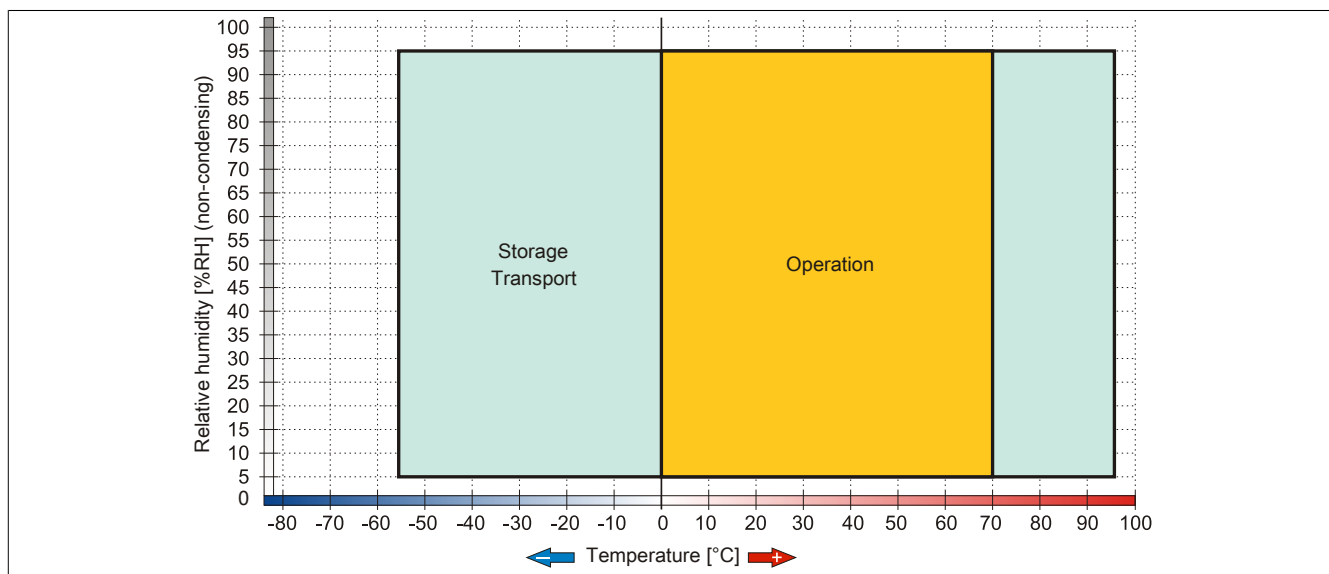

Figure 43: 5MMSSD.0060-00 - Temperature humidity diagram

3.9.11 5MMSSD.0060-01

3.9.11.1 General information

This 60 GB slide-in compact SSD (solid-state drive) is based on multi-level cell (MLC) technology and can be used as a replacement or accessory part.

- Replacement for 5AC801.SSDI-03 or 5AC901.CSSD-03 SSD drives
- Accessory for the APC510 (optional SSD for I/O board)

3.9.11.2 Order data

Model number	Short description	Figure
	Drives	
5MMSSD.0060-01	60 GB SSD MLC - Intel - SATA	

Table 79: 5MMSSD.0060-01 - Order data

3.9.11.3 Technical data

Caution!

A sudden power failure may result in data loss! In very rare cases, the mass storage device may also become damaged.

To prevent damage and loss of data, the use of a UPS is recommended.

Information:

The following characteristics, features and limit values only apply to this accessory and can deviate from those specified for the complete system. The data specifications for the complete system take precedence over those of individual components.

Product ID	5MMSSD.0060-01	
Revision	C0	D0
General information		
Certification		
CE		Yes
cULus		Yes
cULus HazLoc Class 1 Division 2		Yes ¹⁾
GOST-R		Yes
Solid-state drive		
Capacity	60 GB	
Data reliability	<1 unrecoverable error in 10 ¹⁵ bit read accesses	
MTBF	1,500,000 hours	
S.M.A.R.T. support	Yes	
Interface	SATA	
Maintenance	None	
Sequential read	Max. 510 MB/s	
Sequential write	Max. 430 MB/s	
IOPS ²⁾		
4k read		Max. 50,000 (random)
4k write		Max. 25,000 (random)
Endurance		
MLC flash	Yes	
Guaranteed data volume		
Guaranteed	35 TBW ³⁾	
Compatibility	SATA 3.0 compliant ACS-2 SSD Enhanced SMART ATA feature set Native Command Queuing (NCQ)	
Environmental conditions		
Temperature		
Operation	0 to 70°C	-30 to 85°C
Storage		-40 to 85°C
Transport		-40 to 85°C

Table 80: 5MMSSD.0060-01, 5MMSSD.0060-01 - Technical data

Product ID		5MMSSD.0060-01	
Relative humidity			
Operation	8 to 90%, non-condensing		5 to 90%, non-condensing
Storage	8 to 95%, non-condensing		5 to 95%, non-condensing
Transport	8 to 95%, non-condensing		5 to 95%, non-condensing
Vibration			
Operation		10 to 2000 Hz: 20 g	
Storage		10 to 2000 Hz: 20 g	
Transport		10 to 2000 Hz: 20 g	
Shock			
Operation		1500 g, 0.5 ms	
Storage		1500 g, 0.5 ms	
Transport		1500 g, 0.5 ms	
Altitude			
Operation		-300 to 12192 m	
Storage		-300 to 12192 m	
Transport		-300 to 12192 m	
Mechanical characteristics			
Dimensions			
Width	9.5 mm		7 mm
Height		69 mm	
Depth		100 mm	
Weight		78 g	
Manufacturer information			
Manufacturer		Toshiba	
Manufacturer's product ID	THNSNH060GBST		THNSNJ060WCST

Table 80: 5MMSSD.0060-01, 5MMSSD.0060-01 - Technical data

- 1) Yes, although applies only if all components installed within the complete system have this certification.
- 2) IOPS: Random read and write input/output operations per second.
- 3) TBW: Terabytes written.

3.9.11.4 Temperature/Humidity diagram

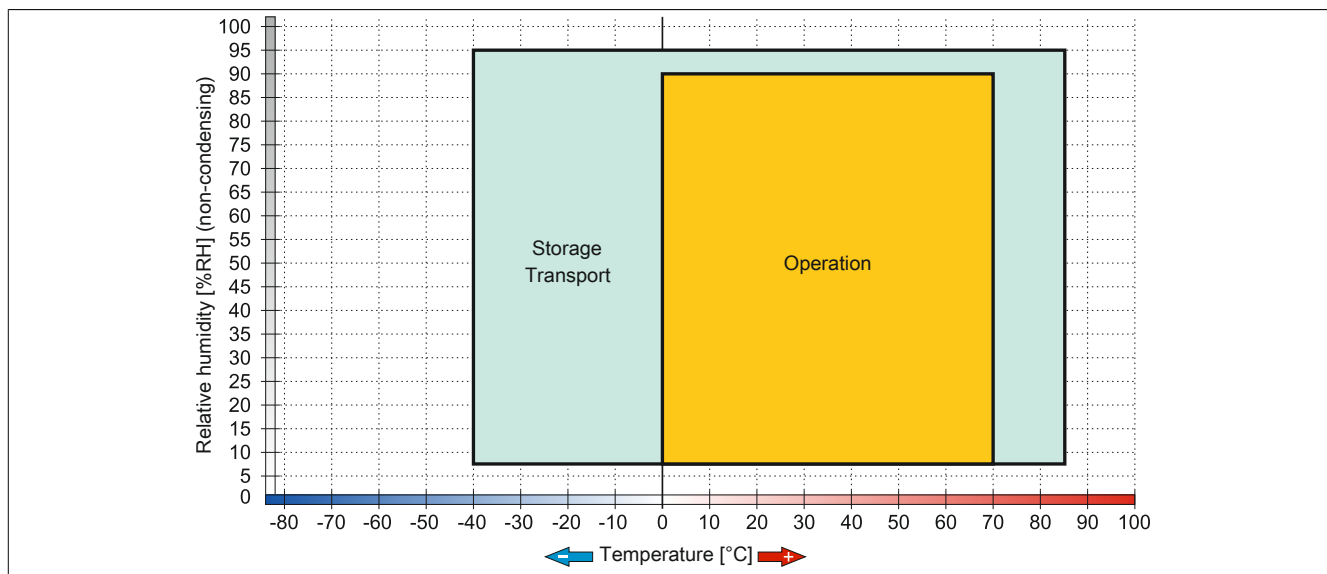

Figure 44: 5MMSSD.0060-01 ≤ Rev. C0 - Temperature/Humidity diagram

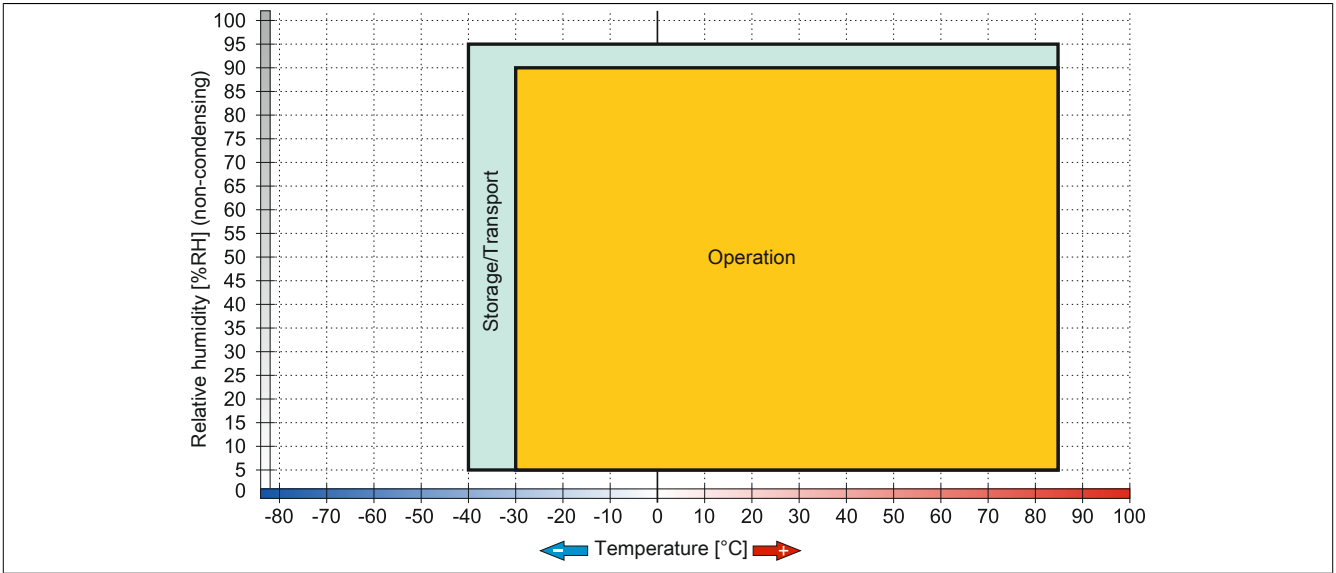

Figure 45: 5MMSSD.0060-01 ≥ Rev. D0 - Temperature/Humidity diagram

3.9.12 5MMSSD.0128-01

3.9.12.1 General information

This 128 GB slide-in compact SSD (solid-state drive) is based on multi-level cell (MLC) technology and can be used as a replacement or accessory part.

- Replacement for 5AC801.SSDI-04 or 5AC901.CSSD-04 SSD drives
- Accessory for the APC510 (optional SSD for I/O board)

3.9.12.2 Order data

Model number	Short description	Figure
	Drives	
5MMSSD.0128-01	128 GB SSD MLC - Toshiba - SATA	

Table 81: 5MMSSD.0128-01 - Order data

3.9.12.3 Technical data

Caution!

A sudden power failure may result in data loss! In very rare cases, the mass storage device may also become damaged.

To prevent damage and loss of data, the use of a UPS is recommended.

Information:

The following characteristics, features and limit values only apply to this accessory and can deviate from those specified for the complete system. The data specifications for the complete system take precedence over those of individual components.

Product ID	5MMSSD.0128-01	
Revision	C0	D0
General information		
Certification		
CE		Yes
cULus		Yes
cULus HazLoc Class 1 Division 2		Yes ¹⁾
GOST-R		Yes
Solid-state drive		
Capacity	128 GB	
Data reliability	<1 unrecoverable error in 10 ¹⁵ bit read accesses	
MTBF	1,500,000 hours	
S.M.A.R.T. support	Yes	
Interface	SATA	
Maintenance	None	
Sequential read	Max. 510 MB/s	
Sequential write	Max. 450 MB/s	
IOPS ²⁾		
4k read	Max. 85,000 (random)	
4k write	Max. 35,000 (random)	
Endurance		
MLC flash	Yes	
Guaranteed data volume		
Guaranteed	74 TBW ³⁾	
Compatibility	SATA 3.0 compliant ACS-2 SSD Enhanced SMART ATA feature set Native Command Queuing (NCQ)	

Table 82: 5MMSSD.0128-01, 5MMSSD.0128-01 - Technical data

Product ID	5MMSSD.0128-01		
Environmental conditions			
Temperature	0 to 70°C		-30 to 85°C
Operation			
Storage			-40 to 85°C
Transport			-40 to 85°C
Relative humidity			
Operation	8 to 90%, non-condensing		5 to 90%, non-condensing
Storage	8 to 95%, non-condensing		5 to 95%, non-condensing
Transport	8 to 95%, non-condensing		5 to 95%, non-condensing
Vibration			
Operation	10 to 2000 Hz: 20 g		
Storage	10 to 2000 Hz: 20 g		
Transport	10 to 2000 Hz: 20 g		
Shock			
Operation	1500 g, 0.5 ms		
Storage	1500 g, 0.5 ms		
Transport	1500 g, 0.5 ms		
Altitude			
Operation	-300 to 12192 m		
Storage	-300 to 12192 m		
Transport	-300 to 12192 m		
Mechanical characteristics			
Dimensions			
Width	9.5 mm		7 mm
Height			69 mm
Depth			100 mm
Weight	78 g		
Manufacturer information			
Manufacturer	Toshiba		
Manufacturer's product ID	THNSNH128GBST		THNSNJ128WCST

Table 82: 5MMSSD.0128-01, 5MMSSD.0128-01 - Technical data

- 1) Yes, although applies only if all components installed within the complete system have this certification.
- 2) IOPS: Random read and write input/output operations per second.
- 3) TBW: Terabytes written.

3.9.12.4 Temperature/Humidity diagram

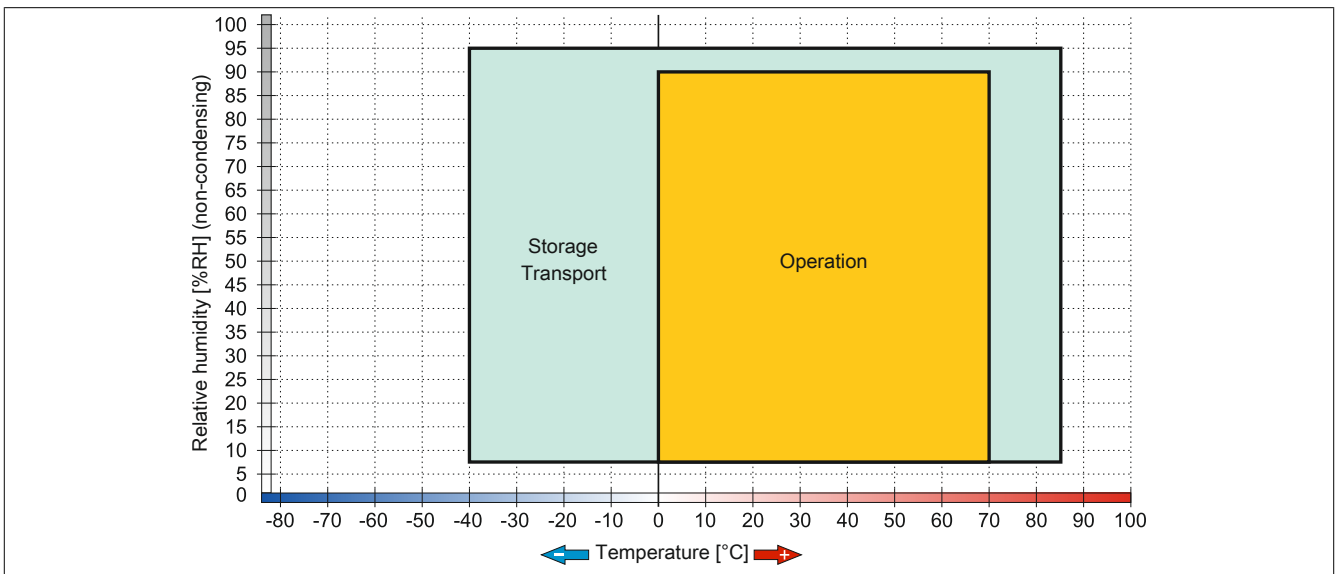

Figure 46: 5MMSSD.0128-01 ≤ Rev. C0 - Temperature/Humidity diagram

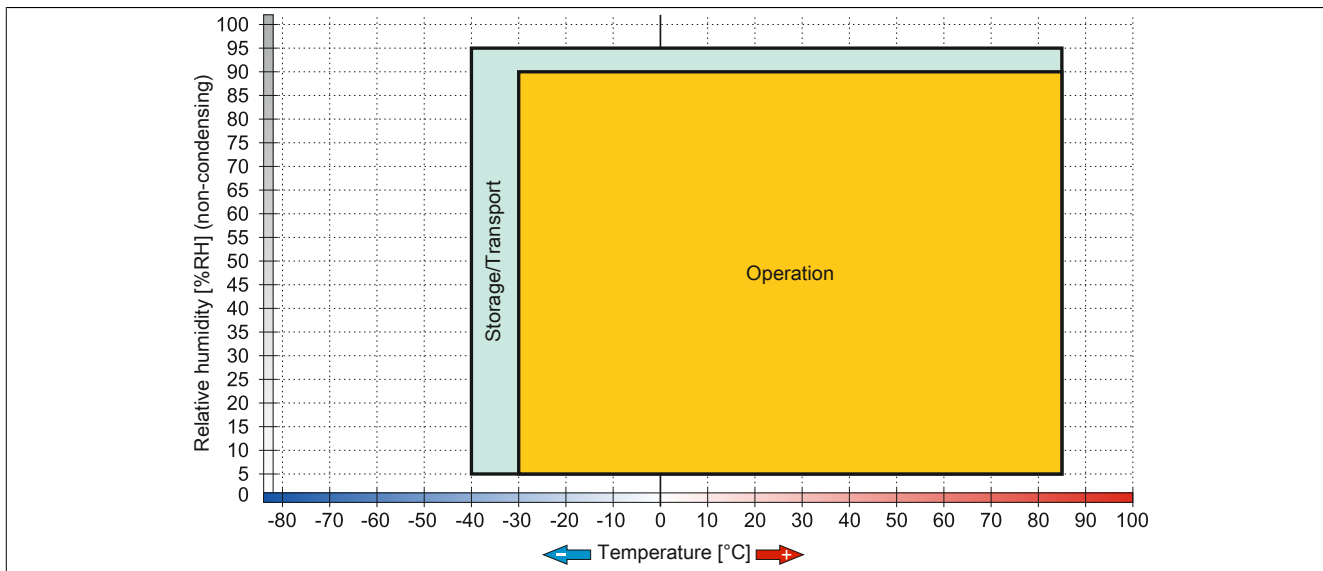

Figure 47: 5MMSSD.0128-01 ≥ Rev. D0 - Temperature/Humidity diagram

3.9.13 5MMSSD.0180-00

3.9.13.1 General information

This 180 GB slide-in compact SSD (solid-state drive) is based on multi-level cell (MLC) technology and can be used as a replacement or accessory part.

- Replacement for 5AC801.SSDI-02 or 5AC901.CSSD-02 SSD drives
- Accessory for the APC510 (optional SSD for I/O board)

3.9.13.2 Order data

Model number	Short description	Figure
	Drives	
5MMSSD.0180-00	180 GB SSD MLC - Intel - SATA	

Table 83: 5MMSSD.0180-00 - Order data

3.9.13.3 Technical data

Caution!

A sudden power failure may result in data loss! In very rare cases, the mass storage device may also become damaged.

To prevent damage and loss of data, the use of a UPS is recommended.

Information:

The following characteristics, features and limit values only apply to this accessory and can deviate from those specified for the complete system. The data specifications for the complete system take precedence over those of individual components.

Product ID	5MMSSD.0180-00
General information	
Certification	
CE	Yes
cULus	Yes
cULus HazLoc Class 1 Division 2	Yes ¹⁾
GOST-R	Yes
Solid-state drive	
Capacity	180 GB
Data reliability	<1 unrecoverable error in 10 ¹⁶ bit read accesses
MTBF	1,200,000 hours
S.M.A.R.T. support	Yes
Interface	SATA
Maintenance	None
Sequential read	Max. 550 MB/s with SATA 6 Gbit/s Max. 280 MB/s with SATA 3 Gbit/s
Sequential write	Max. 520 MB/s with SATA 6 Gbit/s Max. 260 MB/s with SATA 3 Gbit/s
IOPS ²⁾	
4k read	50,000
4k write	
Typical	60,000
Maximum	80,000
Endurance	
MLC flash	Yes
Compatibility	SATA 3.0 compliant ACS-2 SSD Enhanced SMART ATA feature set Native Command Queuing (NCQ)

Table 84: 5MMSSD.0180-00 - Technical data

Product ID	5MMSSD.0180-00
Environmental conditions	
Temperature	
Operation	0 to 70°C
Storage	-55 to 95°C
Transport	-55 to 95°C
Relative humidity	
Operation	5 to 95%, non-condensing
Storage	5 to 95%, non-condensing
Transport	5 to 95%, non-condensing
Vibration	
Operation	5 to 700 Hz: 2.17 g
Storage	5 to 800 Hz: 3.13 g
Transport	5 to 800 Hz: 3.13 g
Shock	
Operation	1500 g, 0.5 ms
Storage	1500 g, 0.5 ms
Transport	1500 g, 0.5 ms
Altitude	
Operation	-300 to 12192 m
Storage	-300 to 12192 m
Transport	-300 to 12192 m
Mechanical characteristics	
Dimensions	
Width	9.5 mm
Height	69 mm
Depth	100 mm
Weight	78 g
Manufacturer information	
Manufacturer	Intel
Manufacturer's product ID	SSDSC2CW180A3

Table 84: 5MMSSD.0180-00 - Technical data

- 1) Yes, although applies only if all components installed within the complete system have this certification
- 2) IOPS: Random read and write input/output operations per second.

3.9.13.4 Temperature humidity diagram

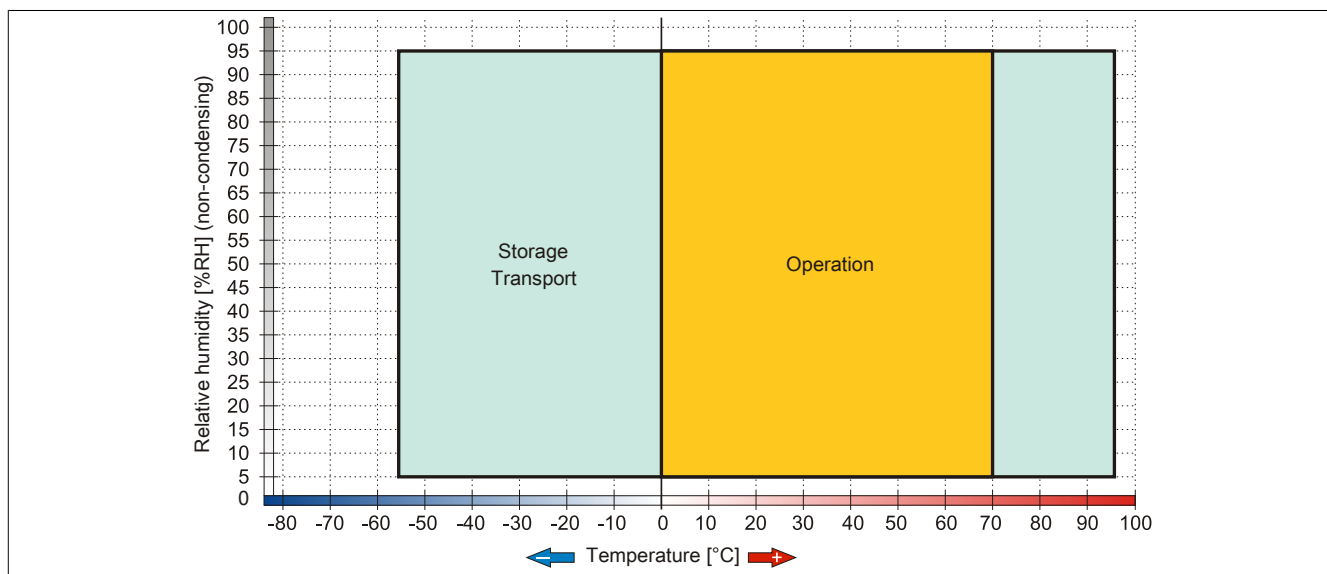

Figure 48: 5MMSSD.0180-00 - Temperature humidity diagram

3.9.14 5MMSSD.0256-00

3.9.14.1 General information

This 256 GB slide-in compact SSD (solid-state drive) is based on multi-level cell (MLC) technology and can be used as a replacement or accessory part.

- Replacement for 5AC801.SSDI-05 or 5AC901.CSSD-05 SSD drives
- Accessory for the APC510 (optional SSD for I/O board)

3.9.14.2 Order data

Model number	Short description	Figure
	Drives	
5MMSSD.0256-00	256 GB SSD MLC - Slide-in compact - Toshiba - SATA	

Table 85: 5MMSSD.0256-00 - Order data

3.9.14.3 Technical data

Caution!

A sudden power failure may result in data loss! In very rare cases, the mass storage device may also become damaged.

To prevent damage and loss of data, the use of a UPS is recommended.

Information:

The following characteristics, features and limit values only apply to this accessory and can deviate from those specified for the complete system. The data specifications for the complete system take precedence over those of individual components.

Product ID	5MMSSD.0256-00
General information	
Certification	
CE	Yes
cULus	Yes
cULus HazLoc Class 1 Division 2	Yes ¹⁾
Solid-state drive	
Capacity	256 GB
Data reliability	<1 unrecoverable error in 10 ¹⁵ bit read accesses
MTBF	1,500,000 hours
S.M.A.R.T. support	Yes
Interface	SATA
Maintenance	None
Sequential read	Max. 510 MB/s
Sequential write	Max. 460 MB/s
IOPS ²⁾	
4k read	Max. 90,000 (random)
4k write	Max. 35,000 (random)
Endurance	
MLC flash	Yes
Guaranteed data volume	
Guaranteed	148 TBW ³⁾
Compatibility	SATA 3.0 compliant ACS-2 SSD Enhanced SMART ATA feature set Native Command Queuing (NCQ)

Table 86: 5MMSSD.0256-00 - Technical data

Product ID	5MMSSD.0256-00
Environmental conditions	
Temperature	
Operation	-30 to 85°C
Storage	-40 to 85°C
Transport	-40 to 85°C
Relative humidity	
Operation	5 to 90%, non-condensing
Storage	5 to 95%, non-condensing
Transport	5 to 95%, non-condensing
Vibration	
Operation	10 to 2000 Hz: 20 g
Storage	10 to 2000 Hz: 20 g
Transport	10 to 2000 Hz: 20 g
Shock	
Operation	1500 g, 0.5 ms
Storage	1500 g, 0.5 ms
Transport	1500 g, 0.5 ms
Altitude	
Operation	-300 to 12192 m
Storage	-300 to 12192 m
Transport	-300 to 12192 m
Mechanical characteristics	
Dimensions	
Width	7 mm
Height	69 mm
Depth	100 mm
Weight	78 g
Manufacturer information	
Manufacturer	Toshiba
Manufacturer's product ID	THNSNJ256WCST

Table 86: 5MMSSD.0256-00 - Technical data

- 1) Yes, although applies only if all components installed within the complete system have this certification.
- 2) IOPS: Random read and write input/output operations per second.
- 3) TBW: Terabytes written.

3.9.14.4 Temperature/Humidity diagram

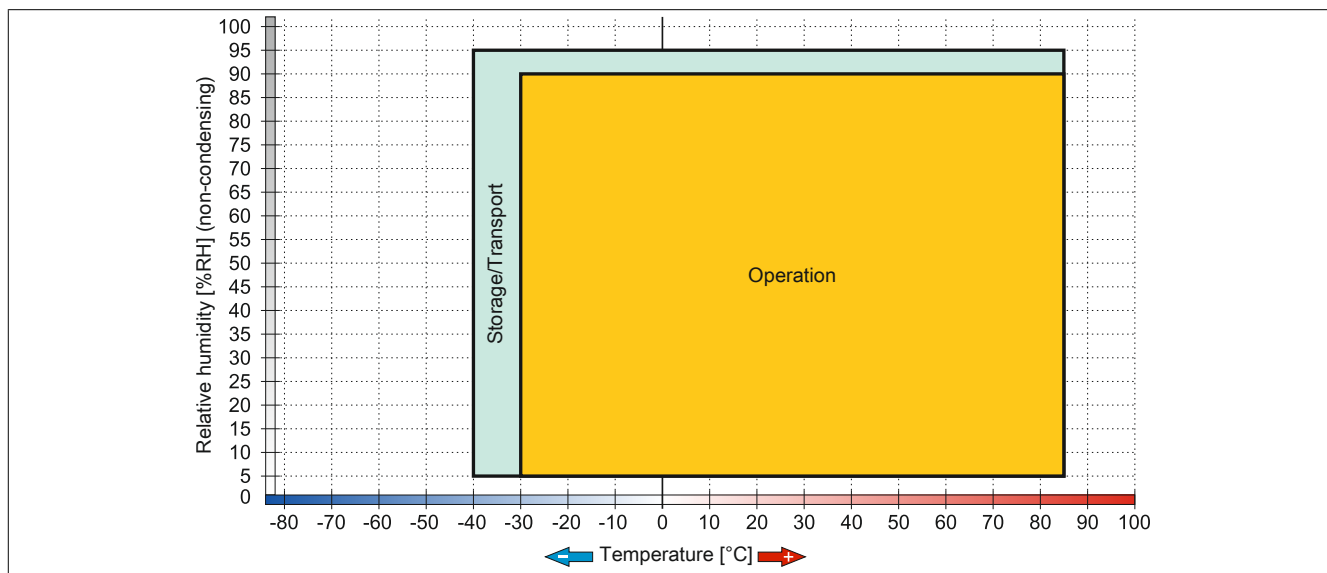

Figure 49: 5MMSSD.0256-00 - Temperature/Humidity diagram

3.9.15 5AC801.ADAS-00

3.9.15.1 General information

The hard disk adapter is a slide-in adapter that allows slide-in compact drives to be installed and operated on a B&R Industrial PC. This adapter can be used in APC810 and PPC800 system units with a slide-in drive slot.

When used in a PPC800

Information:

The expansion 5AC803.SX01-00 or 5AC803.SX02-00 is required in order to use slide-in drives.

3.9.15.2 Order data

Model number	Short description	Figure
	Drives	
5AC801.ADAS-00	SATA hard disk adapter for operating a slide-in compact hard disk in a slide-in slot	

Table 87: 5AC801.ADAS-00 - Order data

3.9.15.3 Technical data

Product ID	5AC801.ADAS-00
General information	
Certification	
CE	Yes
cULus	Yes
GOST-R	Yes
GL	Yes ¹⁾
Mechanical characteristics	
Dimensions	
Width	22 mm
Height	172.5 mm
Depth	150 mm
Weight	328 g

Table 88: 5AC801.ADAS-00 - Technical data

1) Yes, although applies only if all components installed within the complete system have this certification

3.9.16 5AC801.HDDS-00

3.9.16.1 General information

This 40 GB hard disk is specified for 24-hour operation, features an extended temperature range and can be used in APC810 and PPC800 system units with a slide-in drive slot.

Information:

A slide-in drive can be inserted or removed at any time.

When used in a PPC800

Information:

The expansion 5AC803.SX01-00 or 5AC803.SX02-00 is required in order to use slide-in drives.

When inserted in the slide-in slot, the slide-in drive is accessed internally via SATA and USB.

3.9.16.2 Order data

Model number	Short description	Figure
	Drives	
5AC801.HDDS-00	40 GB SATA slide-in hard disk; 24/7 operation with extended temperature range. Note: please see the manual for information about using this hard disk	

Table 89: 5AC801.HDDS-00 - Order data

3.9.16.3 Technical data

Information:

The following characteristics, features and limit values only apply to this individual component and can deviate from those specified for the complete system. For the complete system in which this individual component is used, refer to the data given specifically for that device.

Product ID	5AC801.HDDS-00
General information	
Certification	
CE	Yes
cULus	Yes
GOST-R	Yes
GL	Yes ¹⁾
Hard disk drive	
Capacity	40 GB
Number of heads	1
Number of sectors	78,140,160
Bytes per sector	512
Cache	8 MB
Speed	5400 rpm \pm 1%
Startup time	Typ. 3 s (from 0 rpm to read access)
MTBF	750,000 POH ²⁾
S.M.A.R.T. support	Yes
Interface	SATA
Access time	5.6 ms
Data transfer rate	
Internal	Max. 450 Mbit/s
To/From host	Max. 150 MB/s (Ultra DMA mode 5)

Table 90: 5AC801.HDDS-00 - Technical data

Product ID	5AC801.HDDS-00
Positioning time	
Minimum (track to track)	1 ms
Nominal (read only)	12.5 ms
Maximum (read only)	23 ms
Environmental conditions	
Temperature ³⁾	
Operation ⁴⁾	-30 to 85°C
24-hour operation ⁵⁾	-30 to 85°C
Storage	-40 to 95°C
Transport	-40 to 95°C
Relative humidity ⁶⁾	
Operation	5 to 90%, non-condensing
Storage	5 to 95%, non-condensing
Transport	5 to 95%, non-condensing
Vibration	
Operation	5 to 500 Hz: 2 g; no unrecoverable errors
Storage	5 to 500 Hz: 5 g; no unrecoverable errors
Transport	5 to 500 Hz: 5 g; no unrecoverable errors
Shock	
Operation	300 g and 2 ms duration; no unrecoverable errors 150 g and 11 ms duration; no unrecoverable errors
Storage	800 g and 2 ms duration; no unrecoverable errors
Transport	400 g and 0.5 ms duration; no unrecoverable errors 800 g and 2 ms duration; no unrecoverable errors 400 g and 0.5 ms duration; no unrecoverable errors
Altitude	
Operation	-300 to 5000 m
Storage	-300 to 12192 m
Mechanical characteristics	
Installation	Fixed ⁷⁾
Dimensions	
Width	22 mm
Height	172.5 mm
Depth	150 mm
Weight	387 g
Manufacturer information	
Manufacturer	Seagate
Manufacturer product ID	ST940817SM

Table 90: 5AC801.HDDS-00 - Technical data

- 1) Yes, although applies only if all components installed within the complete system have this certification
- 2) With 8760 POH (power-on hours) per year and 70°C surface temperature.
- 3) Temperature values at an elevation of 305 meters. The temperature specification must be reduced linearly by 1°C every 305 meters. The temperature increase and decrease can be a maximum of 20°C per hour.
- 4) Standard operation refers to 333 POH (power-on hours) per month.
- 5) 24-hour operation refers to 732 POH (power-on hours) per month.
- 6) Humidity gradient: Maximum 15% per hour.
- 7) Slide-in compact installation.

3.9.16.4 Temperature humidity diagram

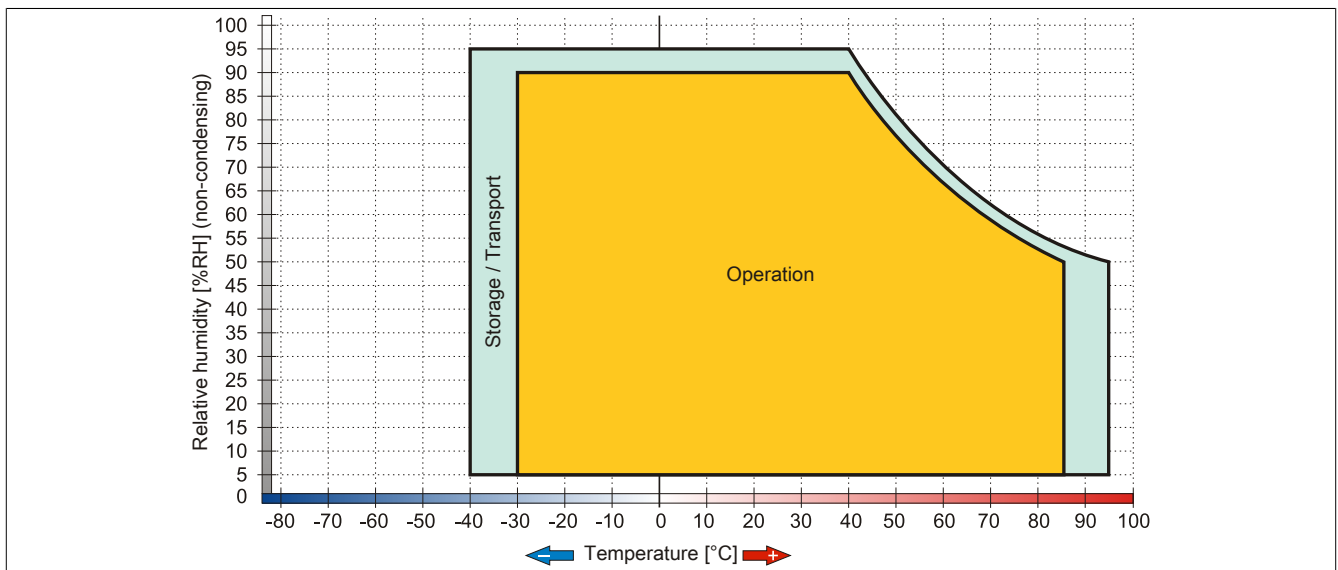

Figure 50: 5AC801.HDDS-00 - Temperature humidity diagram

3.9.17 5AC801.DVDS-00

3.9.17.1 General information

The DVD-ROM slide-in drive can be used in APC810 and PPC800 system units with a slide-in drive slot.

Information:

A slide-in drive can be inserted or removed at any time.

When used in a PPC800

Information:

The expansion 5AC803.SX01-00 or 5AC803.SX02-00 is required in order to use slide-in drives.

When inserted in the slide-in slot, the slide-in drive is accessed internally via SATA and USB.

3.9.17.2 Order data

Model number	Short description	Figure
	Drives	
5AC801.DVDS-00	DVD-ROM SATA slide-in drive	

Table 91: 5AC801.DVDS-00 - Order data

3.9.17.3 Technical data

Information:

The following characteristics, features and limit values only apply to this individual component and can deviate from those specified for the complete system. For the complete system in which this individual component is used, refer to the data given specifically for that device.

Product ID	5AC801.DVDS-00
General information	
Certification	
CE	Yes
cULus	Yes
GOST-R	Yes
GL	Yes ¹⁾
CD / DVD drive	
Data transfer rate	Max. 1.5 Gbit/s
Speed	Max. 5090 rpm \pm 1%
Noise level	Approx. 45 dBA in a distance of 50 cm (full read access)
Compatible formats	CD-DA, CD-ROM mode 1/mode 2 CD-ROM XA mode 2 (form 1, form 2) Photo CD (single/multi-session) Enhanced CD, CD text DVD-ROM, DVD-Video (dual layer), DVD-R (single/multi-border), DVD-R DL (single/multi-border), DVD-RW (single/multi-border), DVD+R (single/multi-session), DVD+R DL (single/multi-session), DVD+RW (single/multi-session), DVD-RAM (4.7 GB, 2.6 GB)
Laser class	Class 1 laser
Service life	60000 POH (power-on hours)
Interface	SATA
Startup time	
CD	Max. 19 seconds (from 0 rpm to read access)
DVD	Max. 19 seconds (from 0 rpm to read access)

Table 92: 5AC801.DVDS-00 - Technical data

Product ID	5AC801.DVDS-00
Access time CD DVD	Average of 130 ms Average of 140 ms
Readable media CD DVD	CD-ROM (12 cm, 8 cm), CD-A CD-R, CD-RW DVD-ROM, DVD-R, DVD-R DL, DVD-RW, DVD+R DVD+R DL, DVD+RW, DVD-RAM
Read speed CD DVD	24x 8x
Environmental conditions	
Temperature ²⁾ Operation Storage Transport	5 to 55°C ³⁾ -20 to 60°C -40 to 65°C
Relative humidity Operation Storage Transport	8 to 80%, non-condensing 5 to 95%, non-condensing 5 to 95%, non-condensing
Vibration Operation Storage Transport	5 to 500 Hz: 0.2 g 5 to 500 Hz: 2 g 5 to 500 Hz: 2 g
Shock Operation Storage Transport	5 g and 11 ms duration 60 g and 11 ms duration 200 g and 2 ms duration 60 g and 11 ms duration 200 g and 2 ms duration
Mechanical characteristics	
Dimensions Width Height Depth	22 mm 172.5 mm 150 mm
Weight	455 g

Table 92: 5AC801.DVDS-00 - Technical data

- 1) Yes, although applies only if all components installed within the complete system have this certification
- 2) Temperature data is for operation at 500 meters. The maximum ambient temperature is typically derated by 1°C per 1000 meters (starting at 500 meters above sea level).
- 3) Drive surface temperature.

3.9.17.4 Temperature humidity diagram

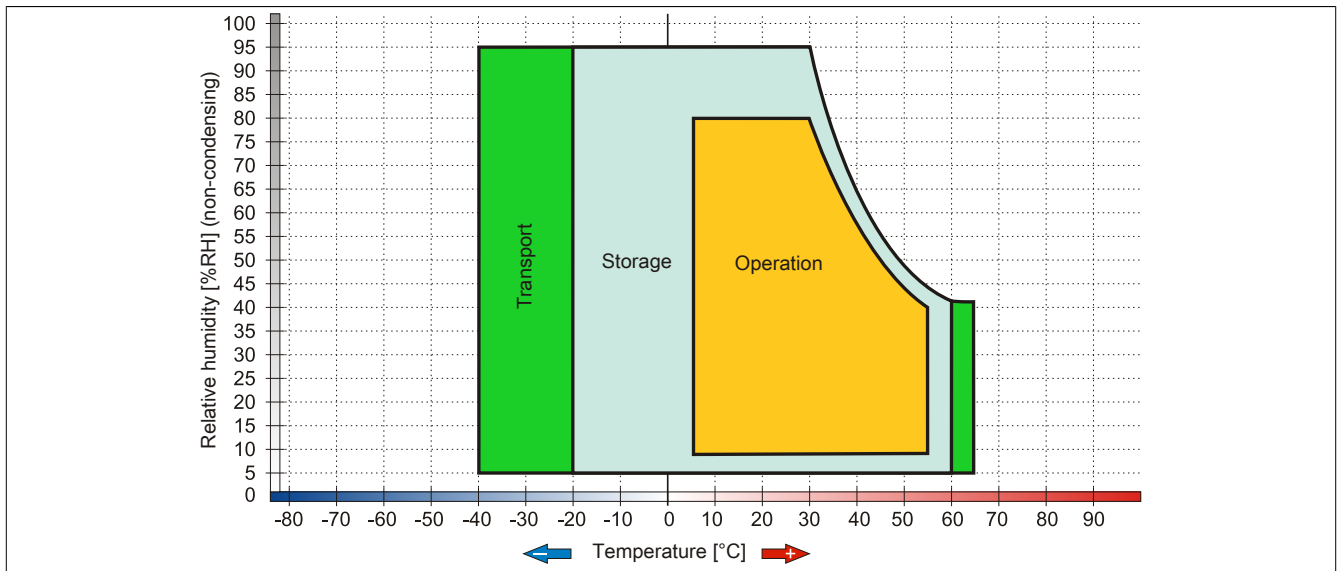

Figure 51: 5AC801.DVDS-00 - Temperature humidity diagram

3.9.17.5 Hot plugging

Hardware revision B0 of the 5AC801.DVDS-00 slide-in DVD-ROM does not offer SATA hot plugging functionality. Hot plugging is possible for other hardware revisions.

3.9.18 5AC801.DVRS-00

3.9.18.1 General information

The DVD-R/RW slide-in drive can be used in APC810 and PPC800 system units with a slide-in drive slot.

Information:

A slide-in drive can be inserted or removed at any time.

When used in a PPC800

Information:

The expansion 5AC803.SX01-00 or 5AC803.SX02-00 is required in order to use slide-in drives.

When inserted in the slide-in slot, the slide-in drive is accessed internally via SATA and USB.

3.9.18.2 Order data

Model number	Short description	Figure
	Drives	
5AC801.DVRS-00	DVD-R/RW DVD+R/RW SATA slide-in drive	
	Optional accessories	
	Other	
5SWUT1.0000-00	OEM Nero CD-RW Software, only available with a CD writer.	

Table 93: 5AC801.DVRS-00 - Order data

3.9.18.3 Technical data

Information:

The following characteristics, features and limit values only apply to this individual component and can deviate from those specified for the complete system. For the complete system in which this individual component is used, refer to the data given specifically for that device.

Product ID	5AC801.DVRS-00
General information	
Certification	
CE	Yes
cULus	Yes
GOST-R	Yes
GL	Yes ¹⁾
CD / DVD drive	
Data buffer capacity	2 MB
Data transfer rate	Max. 33.3 MB/s
Speed	Max. 5160 rpm \pm 1%
Noise level	Approx. 45 dBA in a distance of 50 cm (full read access)
Compatible formats	CD-DA, CD-ROM mode 1/mode 2 CD-ROM XA mode 2 (form 1, form 2) Photo CD (single-/multi-session), Enhanced CD, CD text DVD-ROM, DVD-R, DVD-R (dual layer), DVD-RW, DVD-Video DVD-RAM (4.7GB, 2.6GB) DVD+R, DVD+R (dual layer), DVD+RW
Laser class	Class 1 laser
Service life	60000 POH (power-on hours)
Interface	SATA
Startup time	
CD	Max. 14 seconds (from 0 rpm to read access)
DVD	Max. 15 seconds (from 0 rpm to read access)

Table 94: 5AC801.DVRS-00 - Technical data

Product ID	5AC801.DVRS-00
Access time CD DVD	On average 140 ms (24x) On average 150 ms (8x)
Readable media CD DVD	CD/CD-ROM (12 cm, 8 cm), CD-R, CD-RW DVD-ROM, DVD-R, DVD-R (dual layer), DVD-RW, DVD-RAM, DVD+R, DVD+R (dual layer), DVD+RW, DVD-RAM
Writable media CD DVD	CD-R, CD-RW DVD-R/RW, DVD-R (dual layer), DVD-RAM (4.7 GB), DVD+R/RW, DVD+R (dual layer)
Read speed CD DVD	24x 8x
Write speed CD-R CD-RW DVD+R DVD+R (dual layer) DVD+RW DVD-R DVD-R (dual layer) DVD-RAM ²⁾ DVD-RW	24x, 16x, 10x and 4x 24x, 16x, 10x and 4x 8x, 4x and 2.4x 6x, 4x and 2.4x 4x and 2x 8x, 4x and 2x 6x, 4x and 2x 5x, 3x and 2x 6x, 4x and 2x
Write methods CD DVD	Disk at once, session at once, packet write, track at once Disk at once, incremental, overwrite, sequential, multi-session
Environmental conditions	
Temperature ³⁾ Operation Storage Transport	5 to 55°C ⁴⁾ -20 to 60°C -40 to 65°C
Relative humidity Operation Storage Transport	8 to 80%, non-condensing 5 to 95%, non-condensing 5 to 95%, non-condensing
Vibration Operation Storage Transport	5 to 500 Hz: 0.2 g 5 to 500 Hz: 2 g 5 to 500 Hz: 2 g
Shock Operation Storage Transport	At max. 5 g and 11 ms duration At max. 60 g and 11 ms duration At max. 200 g and 2 ms duration At max. 60 g and 11 ms duration At max. 200 g and 2 ms duration
Mechanical characteristics	
Dimensions Width Height Depth	22 mm 172.5 mm 150 mm
Weight	400 g

Table 94: 5AC801.DVRS-00 - Technical data

- 1) Yes, although applies only if all components installed within the complete system have this certification
- 2) RAM drivers are not provided by the manufacturer. Support of RAM function by "Nero" burning software (model number 5SWUT1.0000-00) or other burning software packages or drivers from third-party providers.
- 3) Temperature specifications refer to operation at 500 meters. The maximum ambient temperature is typically derated by 1°C per 1000 meters (starting at 500 meters above sea level).
- 4) Drive surface temperature.

3.9.18.4 Temperature humidity diagram

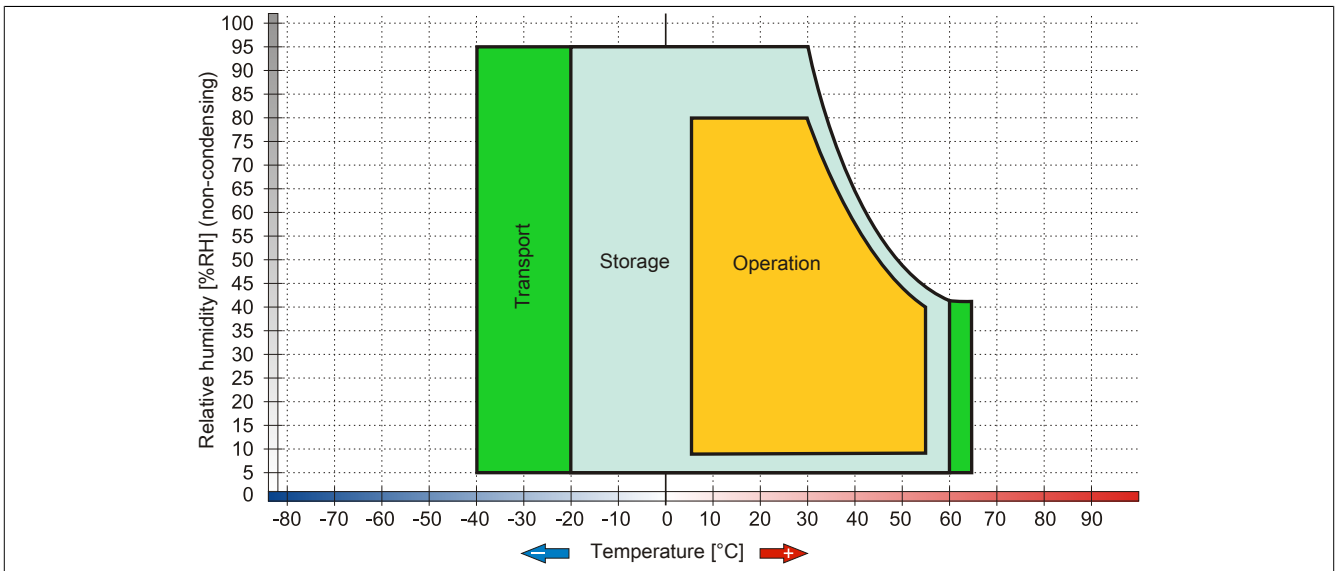

Figure 52: 5AC801.DVRS-00 - Temperature humidity diagram

3.9.19 5ACPCI.RAIC-05

3.9.19.1 General information

This SATA RAID controller supports RAID level 0 and 1 and can be inserted in a PCI slot. The 250 GB hard disks that are used are specified for 24-hour operation (24x7).

- SATA RAID controller
- RAID level 0 (striped) and 1 (mirrored)
- 2 SATA hard disk drives (suitable for 24-hour operation)
- Only requires 1 PCI slot
- Transfer rates up to 150 MB/s



Figure 53: PCI SATA RAID controller

Information:

The PCI SATA RAID controller cannot be used in place of a universal power supply (UPS). If the operating system is not shut down properly, then this will be detected as an error state (with RAID 1 sets) at the next system startup and a complete rebuild is performed. If 250 GB of memory are used, this generally takes approximately 250 minutes (configurable) to complete.

3.9.19.2 Order data

Model number	Short description	Figure
	Drives	
5ACPCI.RAIC-05	PCI RAID system SATA 2x 250 GB; Note: please see the manual for information about using this hard disk	
	Optional accessories	
	Drives	
5MMHDD.0250-00	250 GB SATA hard disk; replacement for 5AC801.HDDI-03 and 5ACPCI.RAIC-05; note: please see the manual for information about using this hard disk	

Table 95: 5ACPCI.RAIC-05 - Order data

3.9.19.3 Technical data

Product ID	5ACPCI.RAIC-05
General information	
Number of hard disks	2
Certification	
CE	Yes
cULus	Yes
cULus HazLoc Class 1 Division 2	Yes ¹⁾
GOST-R	Yes
Controller	
Type	Sil 3512 SATA link
Specification	Serial ATA 1.0
Data transfer rate	Max. 1.5 Gbit/s (150 MB/s)
RAID level	Supports RAID 0, 1
BIOS extension ROM requirements	Approx. 32 kB
Hard disk drive	
Capacity	250 GB
Number of heads	1
Number of sectors	488,397,168
Bytes per sector	512
Cache	8 MB
Speed	5400 rpm ±0.2%
Startup time	Typ. 3.6 s (from 0 rpm to read access)
S.M.A.R.T. support	Yes
Access time	5.56 ms
Supported transfer modes	SATA 1.0, Serial ATA Revision 2.6 PIO mode 0-4, multiword DMA mode 0-2, UDMA mode 0-6
Data transfer rate	
Internal	Max. 1175 Mbit/s
To/From host	Max. 150 MB/s
Positioning time	
Minimum (track to track)	1 ms
Nominal (read only)	14 ms
Maximum (read only)	30 ms
Electrical characteristics	
Power consumption	0.3A at 3.3V (PCI bus) 1A at 5V (PCI bus)
Environmental conditions	
Temperature ²⁾	
Operation ³⁾	0 to 60°C
24-hour operation ⁴⁾	0 to 60°C
Storage	-40 to 70°C
Transport	-40 to 70°C
Relative humidity ⁵⁾	
Operation	5 to 95%, non-condensing
Storage	5 to 95%, non-condensing
Transport	5 to 95%, non-condensing
Vibration ⁶⁾	
Operation (continuous)	5 to 500 Hz: max. 0.125 g; duration 1 octave per minute; no unrecoverable errors
Operation (occasional)	5 to 500 Hz: max. 0.25 g; duration 1 octave per minute; no unrecoverable errors
Storage	5 to 500 Hz: 5 g; duration 0.5 octaves per minute; no damage
Transport	5 to 500 Hz: 5 g; duration 0.5 octaves per minute; no damage
Shock ⁶⁾	
Operation	Max. 125 g, 2 ms; no unrecoverable errors
Storage	Max. 400 g, 2 ms; no damage Max. 500 g, 1 ms; no damage Max. 300 g, 0.5 ms; no damage
Transport	Max. 400 g, 2 ms; no damage Max. 500 g, 1 ms; no damage Max. 300 g, 0.5 ms; no damage
Altitude	
Operation	- 300 to 3048 m
Storage	- 300 to 12192 m
Mechanical characteristics	
Installation	Fixed ⁷⁾
Weight	350 g
Manufacturer information	
Manufacturer	Seagate
Manufacturer's product ID	ST9250315AS

Table 96: 5ACPCI.RAIC-05 - Technical data

- 1) Yes, although applies only if all components installed within the complete system have this certification
- 2) Temperature values at an elevation of 305 meters. The temperature specification must be reduced linearly by 1°C every 305 meters. The temperature increase and decrease can be a maximum of 20°C per hour.
- 3) Standard operation refers to 333 POH (power-on hours) per month.
- 4) 24-hour operation refers to 732 POH (power-on hours) per month.

- 5) Humidity gradient: Maximum 30% per hour.
- 6) Operation in areas prone to vibration and shock can affect performance negatively (reduction of transfer rate).
- 7) Installed in PCI slot.

3.9.19.4 Temperature humidity diagram

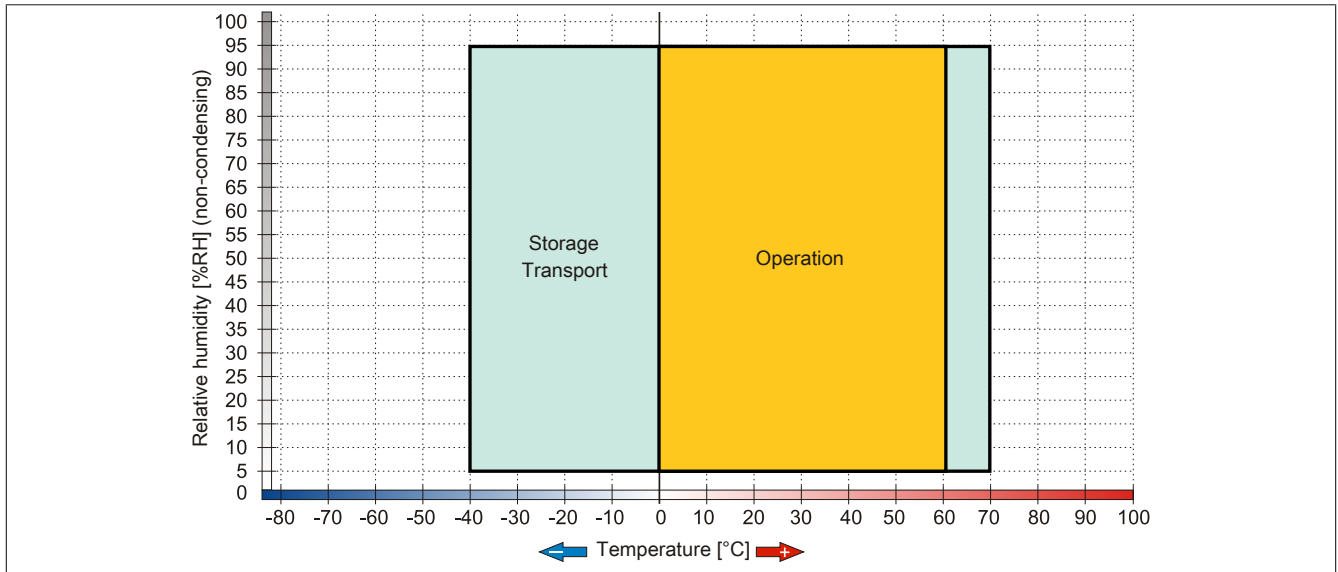

Figure 54: 5ACPCI.RAIC-05 - Temperature humidity diagram

3.9.19.5 Driver support

Special drivers are necessary for operating the PCI SATA RAID controller. Drivers for supported and approved operating systems are available in the Downloads section of the B&R website (www.br-automation.com).

.NET-based SATA Raid™ serial ATA RAID management software can also be found on the B&R website.

Information:

Required drivers can only be downloaded from the B&R website, not from manufacturer websites.

3.9.19.6 Configuration

For information about configuring a SATA RAID set, see 3 "Installation", section 8 "Configuring a SATA RAID set" on page 149.

3.9.19.7 Replacing a HDD

A hard drive can be easily replaced in the event of an error when using the RAID1 (mirroring) configuration without having to reinstall the system. The 250 GB 5MMHDD.0250-00 SATA HDD is available as a replacement hard disk.

For information about performing a replacement, see "Replacing a PCI SATA RAID hard disk in a RAID 1 set" on page 304.

3.9.20 5ACPCI.RAIC-06

3.9.20.1 General information

This SATA RAID controller supports RAID level 0 and 1 and can be inserted in a PCI slot. The 500 GB hard disks that are used are specified for 24-hour operation (24x7).

- SATA RAID controller
- RAID level 0 (striped) and 1 (mirrored)
- 2x 500 GB SATA hard disks (suitable for 24-hour operation)
- Only requires 1 PCI slot
- Transfer rates up to 150 MB/s

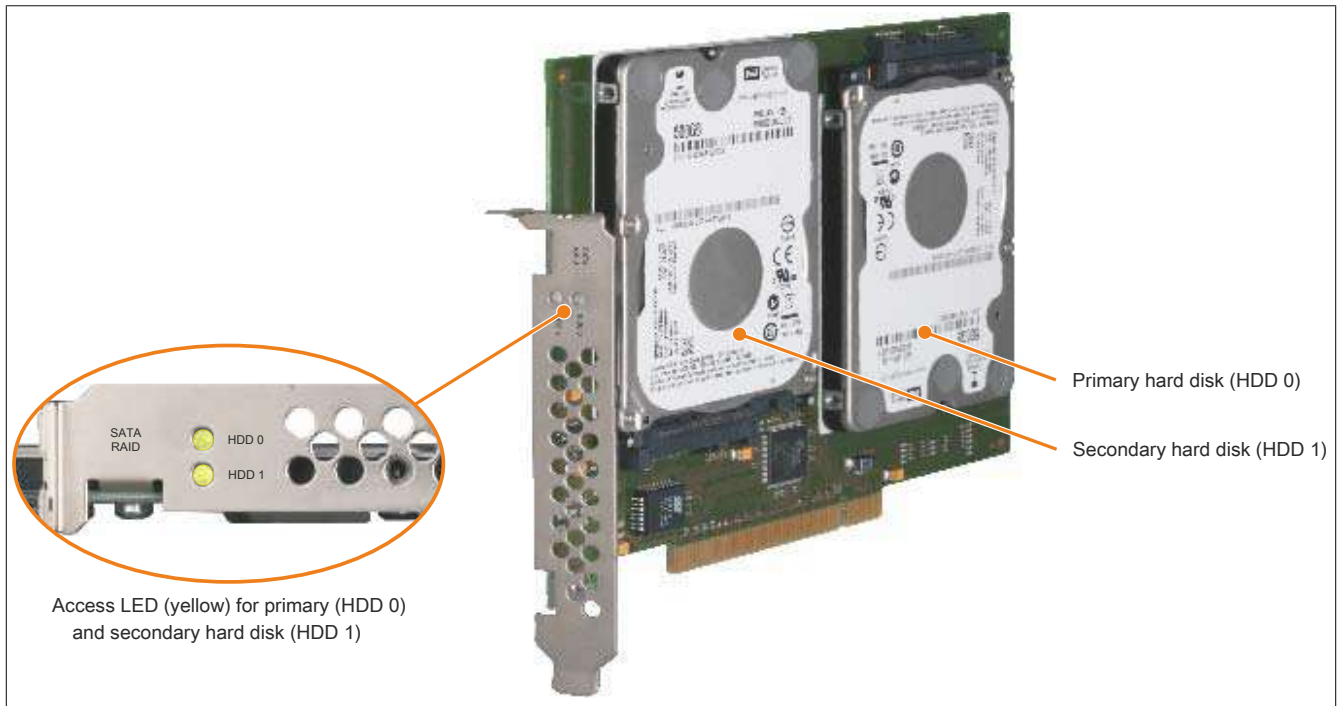

Figure 55: PCI SATA RAID controller

Information:

The PCI SATA RAID controller cannot be used in place of a universal power supply (UPS). If the operating system is not shut down properly, then this will be detected as an error state (with RAID 1 sets) at the next system startup and a complete rebuild is performed. If 500 GB of memory are used, this generally takes approximately 500 minutes (configurable) to complete.

3.9.20.2 Order data

Model number	Short description	Figure
	Drives	
5ACPCI.RAIC-06	PCI RAID System 2x 500 GB - SATA	
	Optional accessories	
	Drives	
5MMHDD.0500-00	500 GB hard disk - SATA	

Table 97: 5ACPCI.RAIC-06 - Order data

3.9.20.3 Technical data

Information:

The following characteristics, features and limit values only apply to this accessory and can deviate from those specified for the complete system. The data specifications for the complete system take precedence over those of individual components.

Product ID	5ACPCI.RAIC-06
General information	
Capacity	2x 500 GB
Number of hard disks	2
Certification	
CE	Yes
cULus	Yes
cULus HazLoc Class 1 Division 2	Yes ¹⁾
GOST-R	Yes
Controller	
Type	Sil 3512 SATA link
Specification	Serial ATA 1.0
Data transfer rate	Max. 1.5 Gbit/s (150 MB/s)
RAID level	Supports RAID 0, 1
BIOS extension ROM requirements	Approx. 32 kB
Hard disk drive ²⁾	
Capacity	500 GB
Number of heads	2
Number of sectors	976,773,168
Bytes per sector	512 (logical) / 4096 (physical)
Cache	16 MB
Speed	5400 rpm ±0.2%
Startup time	Typ. 3.5 s (from 0 rpm to read access)
Service life	5 years
MTBF	1,000,000 POH ³⁾
S.M.A.R.T. support	Yes
Interface	SATA
Access time	5.5 ms
Supported transfer modes	SATA II
Data transfer rate	
Internal	Max. 147 MB/s
To/From host	Max. 150 MB/s (SATA I), max. 300 MB/s (SATA II)
Positioning time	
Nominal (read only)	11 ms
Maximum (read only)	21 ms
Environmental conditions	
Temperature ⁴⁾	
Operation ⁵⁾	0 to 60°C
24-hour operation ⁶⁾	0 to 60°C
Storage	-40 to 70°C
Transport	-40 to 70°C
Relative humidity ⁷⁾	
Operation	5 to 95%, non-condensing
Storage	5 to 95%, non-condensing
Transport	5 to 95%, non-condensing
Vibration ⁸⁾	
Operation (continuous)	5 to 500 Hz: 0.125 g; no unrecoverable errors
Operation (occasional)	5 to 500 Hz: 0.25 g; no unrecoverable errors
Storage	10 to 500 Hz: 5 g; no unrecoverable errors
Transport	10 to 500 Hz: 5 g; no unrecoverable errors
Shock	
Operation	200 g and 2 ms duration; no unrecoverable errors
Storage	1000 g and 2 ms duration; no unrecoverable errors
Transport	1000 g and 2 ms duration; no unrecoverable errors
Altitude	
Operation	-305 to 3048 m
Storage	-305 to 12192 m
Mechanical characteristics	
Installation	Fixed ⁹⁾

Table 98: 5ACPCI.RAIC-06 - Technical data

Product ID	5ACPCI.RAIC-06
Weight	350 g
Manufacturer information	
Manufacturer	Western Digital
Manufacturer's product ID	WD5000LUCT

Table 98: 5ACPCI.RAIC-06 - Technical data

- 1) Yes, although applies only if all components installed within the complete system have this certification
- 2) Technical data for a hard disk.
- 3) With 8760 POH (power-on hours) per year and 25°C surface temperature.
- 4) Temperature values at an elevation of 305 meters. The temperature specification must be reduced linearly by 1°C every 305 meters. The temperature increase and decrease can be a maximum of 20°C per hour.
- 5) Standard operation refers to 333 POH (power-on hours) per month.
- 6) 24-hour operation refers to 732 POH (power-on hours) per month.
- 7) Humidity gradient: Maximum 20% per hour.
- 8) Operation in areas prone to vibration and shock can affect performance negatively (reduction of transfer rate).
- 9) Installed in PCI slot.

3.9.20.4 Temperature humidity diagram

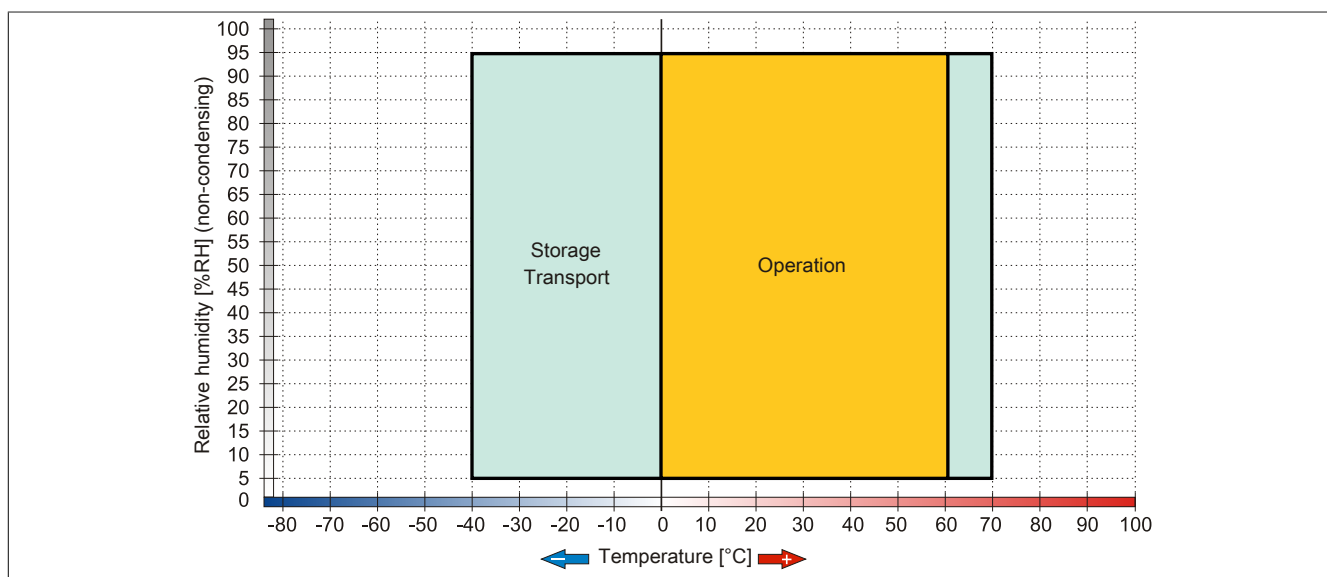

Figure 56: 5ACPCI.RAIC-06 - Temperature humidity diagram

3.9.20.5 Driver support

Special drivers are necessary for operating the PCI SATA RAID controller. Drivers for supported and approved operating systems are available in the Downloads section of the B&R website (www.br-automation.com).

.NET-based SATA Raid™ serial ATA RAID management software can also be found on the B&R website.

Information:

Required drivers can only be downloaded from the B&R website, not from manufacturer websites.

3.9.20.6 Configuration

For information about configuring a SATA RAID set, see 3 "Installation", section 8 "Configuring a SATA RAID set" on page 149.

3.9.20.7 Replacing a HDD

A hard drive can be easily replaced in the event of an error when using the RAID1 (mirroring) configuration without having to reinstall the system. The 500 GB 5MMHDD.0500-00 SATA HDD is available as a replacement hard disk.

For information about performing a replacement, see "Replacing a PCI SATA RAID hard disk in a RAID 1 set" on page 304.

3.9.21 5MMHDD.0250-00

3.9.21.1 General information

This 250 GB hard disk can be used as a replacement part or accessory.

- 250 GB hard disk
- Replacement hard disk for a 5AC801.HDDI-03 hard disk or a 5ACPCI.RAIC-05 RAID controller
- APC510 accessory (optional hard disk for the I/O board)
- Specified for 24-hour operation
- S.M.A.R.T. support

3.9.21.2 Order data

Model number	Short description	Figure
5MMHDD.0250-00	250 GB SATA hard disk; replacement for 5AC801.HDDI-03 and 5ACPCI.RAIC-05; note: please see the manual for information about using this hard disk	

Table 99: 5MMHDD.0250-00 - Order data

3.9.21.3 Technical data

Caution!

A sudden power failure may result in data loss! In very rare cases, the mass storage device may also become damaged.

To prevent damage and loss of data, the use of a UPS is recommended.

Information:

The following characteristics, features and limit values only apply to this individual component and can deviate from those specified for the complete system. For the complete system in which this individual component is used, refer to the data given specifically for that device.

Product ID	5MMHDD.0250-00
General information	
Certification	
CE	Yes
cULus	Yes
cULus HazLoc Class 1 Division 2	Yes ¹⁾
GOST-R	Yes
Hard disk drive	
Capacity	250 GB
Number of heads	1
Number of sectors	488,397,168
Bytes per sector	512
Cache	8 MB
Speed	5400 rpm ±0.2%
Startup time	Typ. 3.6 s (from 0 rpm to read access)
MTBF	550,000 POH ²⁾
S.M.A.R.T. support	Yes
Interface	SATA
Access time	5.56 ms
Supported transfer modes	SATA 1.0, Serial ATA Revision 2.6 PIO mode 0-4, multiword DMA mode 0-2, UDMA mode 0-6
Data transfer rate	
Internal	Max. 1175 Mbit/s
To/From host	Max. 150 MB/s (SATA I), max. 300 MB/s (SATA II)
Positioning time	
Minimum (track to track)	1 ms
Nominal (read only)	14 ms
Maximum (read only)	30 ms

Table 100: 5MMHDD.0250-00 - Technical data

Product ID	5MMHDD.0250-00
Environmental conditions	
Temperature ³⁾	
Operation ⁴⁾	0 to 60°C
24-hour operation ⁵⁾	0 to 60°C
Storage	-40 to 70°C
Transport	-40 to 70°C
Relative humidity ⁶⁾	
Operation	5 to 95%, non-condensing
Storage	5 to 95%, non-condensing
Transport	5 to 95%, non-condensing
Vibration	
Operation	5 to 500 Hz: 0.5 g; no unrecoverable errors
Storage	5 to 500 Hz: 5 g; no unrecoverable errors
Transport	5 to 500 Hz: 5 g; no unrecoverable errors
Shock	
Operation	350 g and 2 ms duration; no unrecoverable errors
Storage	800 g and 2 ms duration; no unrecoverable errors
	1000 g and 1 ms duration; no unrecoverable errors
Transport	600 g and 0.5 ms duration; no unrecoverable errors
	800 g and 2 ms duration; no unrecoverable errors
	1000 g and 1 ms duration; no unrecoverable errors
	600 g and 0.5 ms duration; no unrecoverable errors
Altitude	
Operation	-300 to 3048 m
Storage	-300 to 12192 m
Mechanical characteristics	
Dimensions	
Width	9.5 mm
Height	69 mm
Depth	100 mm
Weight	100 g
Manufacturer information	
Manufacturer	Seagate
Manufacturer product ID	ST9250315AS

Table 100: 5MMHDD.0250-00 - Technical data

- 1) Yes, although applies only if all components installed within the complete system have this certification
- 2) With 8760 POH (power-on hours) per year and 25°C surface temperature.
- 3) Temperature values at an elevation of 305 meters. The temperature specification must be reduced linearly by 1°C every 305 meters. The temperature increase and decrease can be a maximum of 20°C per hour.
- 4) Standard operation refers to 333 POH (power-on hours) per month.
- 5) 24-hour operation refers to 732 POH (power-on hours) per month.
- 6) Humidity gradient: Maximum 30% per hour.

3.9.21.4 Temperature humidity diagram

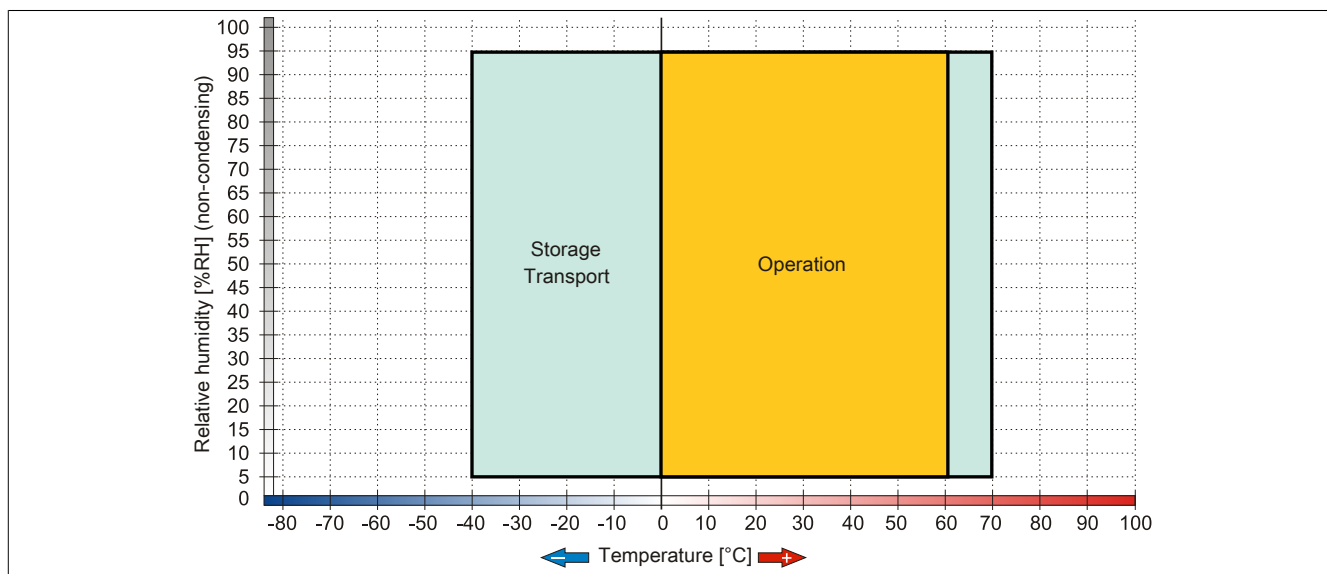

Figure 57: 5MMHDD.0250-00 - Temperature humidity diagram

3.9.22 5MMHDD.0500-00

3.9.22.1 General information

This 500 GB hard disk can be used as a replacement part or accessory.

- 500 GB hard disk
- Replacement hard disk for a 5AC801.HDDI-04 / 5AC901.CHDD-01 hard disk or a 5ACPCI.RAIC-05 RAID controller
- APC510 accessory (optional hard disk for the I/O board)
- Specified for 24-hour operation
- S.M.A.R.T. support

3.9.22.2 Order data

Model number	Short description	Figure
	Drives	
5MMHDD.0500-00	500 GB hard disk - SATA	

Table 101: 5MMHDD.0500-00 - Order data

3.9.22.3 Technical data

Caution!

A sudden power failure may result in data loss! In very rare cases, the mass storage device may also become damaged.

To prevent damage and loss of data, the use of a UPS is recommended.

Information:

The following characteristics, features and limit values only apply to this accessory and can deviate from those specified for the complete system. The data specifications for the complete system take precedence over those of individual components.

Product ID	5MMHDD.0500-00
General information	
Certification	
CE	Yes
cULus	Yes
cULus HazLoc Class 1 Division 2	Yes ¹⁾
GOST-R	Yes
Hard disk drive	
Capacity	500 GB
Number of heads	2
Number of sectors	976,773,168
Bytes per sector	512 (logical) / 4096 (physical)
Cache	16 MB
Speed	5400 rpm ±0.2%
Startup time	Typ. 3.5 s (from 0 rpm to read access)
Service life	5 years
MTBF	1,000,000 POH ²⁾
S.M.A.R.T. support	Yes
Interface	SATA
Access time	5.5 ms
Supported transfer modes	SATA II

Table 102: 5MMHDD.0500-00 - Technical data

Product ID	5MMHDD.0500-00
Data transfer rate	
Internal	Max. 147 MB/s
To/From host	Max. 150 MB/s (SATA I), max. 300 MB/s (SATA II)
Positioning time	
Nominal (read only)	11 ms
Maximum (read only)	21 ms
Environmental conditions	
Temperature ³⁾	
Operation ⁴⁾	0 to 60°C
24-hour operation ⁵⁾	0 to 60°C
Storage	-40 to 70°C
Transport	-40 to 70°C
Relative humidity ⁶⁾	
Operation	5 to 95%, non-condensing
Storage	5 to 95%, non-condensing
Transport	5 to 95%, non-condensing
Vibration	
Operation (continuous)	5 to 500 Hz: 0.25 g; no unrecoverable errors
Operation (occasional)	5 to 500 Hz: 0.5 g; no unrecoverable errors
Storage	10 to 500 Hz: 5 g; no unrecoverable errors
Transport	10 to 500 Hz: 5 g; no unrecoverable errors
Shock	
Operation	400 g and 2 ms duration; no unrecoverable errors
Storage	1000 g and 2 ms duration; no unrecoverable errors
Transport	1000 g and 2 ms duration; no unrecoverable errors
Altitude	
Operation	-305 to 3048 m
Storage	-305 to 12192 m
Mechanical characteristics	
Dimensions	
Width	7 mm
Height	69 mm
Depth	100 mm
Weight	100 g
Manufacturer information	
Manufacturer	Western Digital
Manufacturer's product ID	WD5000LUCT

Table 102: 5MMHDD.0500-00 - Technical data

- 1) Yes, although applies only if all components installed within the complete system have this certification
- 2) With 8760 POH (power-on hours) per year and 25°C surface temperature.
- 3) Temperature values at an elevation of 305 meters. The temperature specification must be reduced linearly by 1°C every 305 meters. The temperature increase and decrease can be a maximum of 20°C per hour.
- 4) Standard operation refers to 333 POH (power-on hours) per month.
- 5) 24-hour operation refers to 732 POH (power-on hours) per month.
- 6) Humidity gradient: Maximum 20% per hour.

3.9.22.4 Temperature humidity diagram

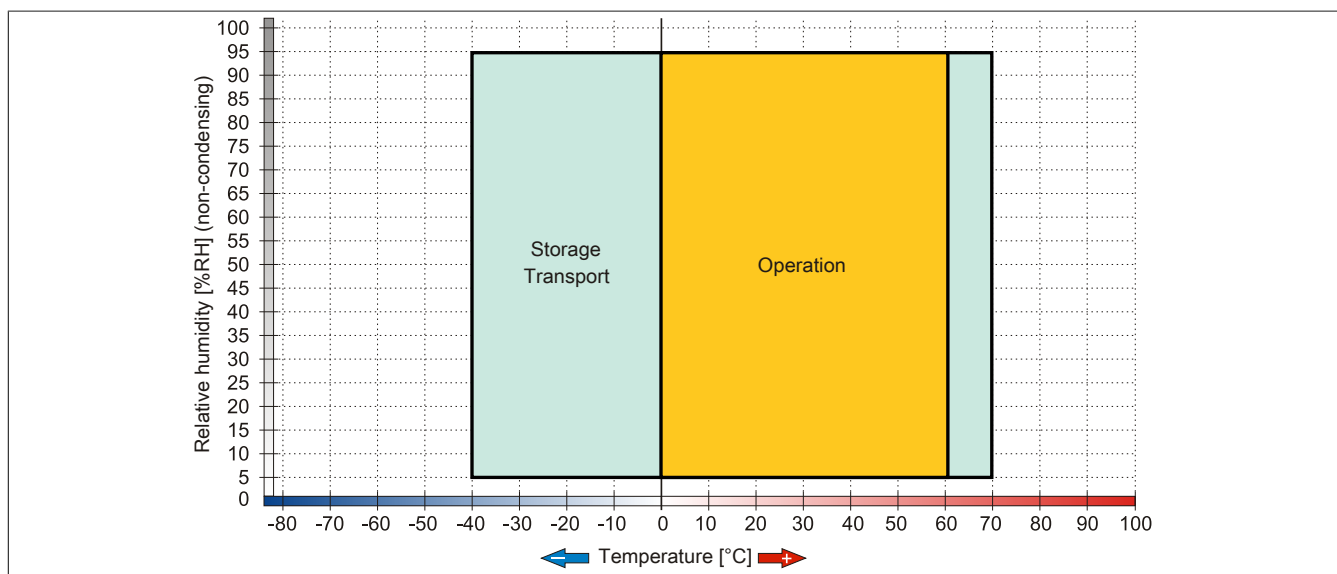

Figure 58: 5MMHDD.0500-00 - Temperature humidity diagram

3.10 Fan kit

Information:

Fans are necessary when using components that must work within certain temperature limits, e.g. DVD combos and PCI cards.

Fan and dust filters are subject to wear and must be checked with appropriate frequency and cleaned or replaced when not functioning properly (e.g. due to dirt and grime).

3.10.1 5AC803.FA01-00

3.10.1.1 General information

This fan kit is an optional addition for PPC800 system units without an expansion.

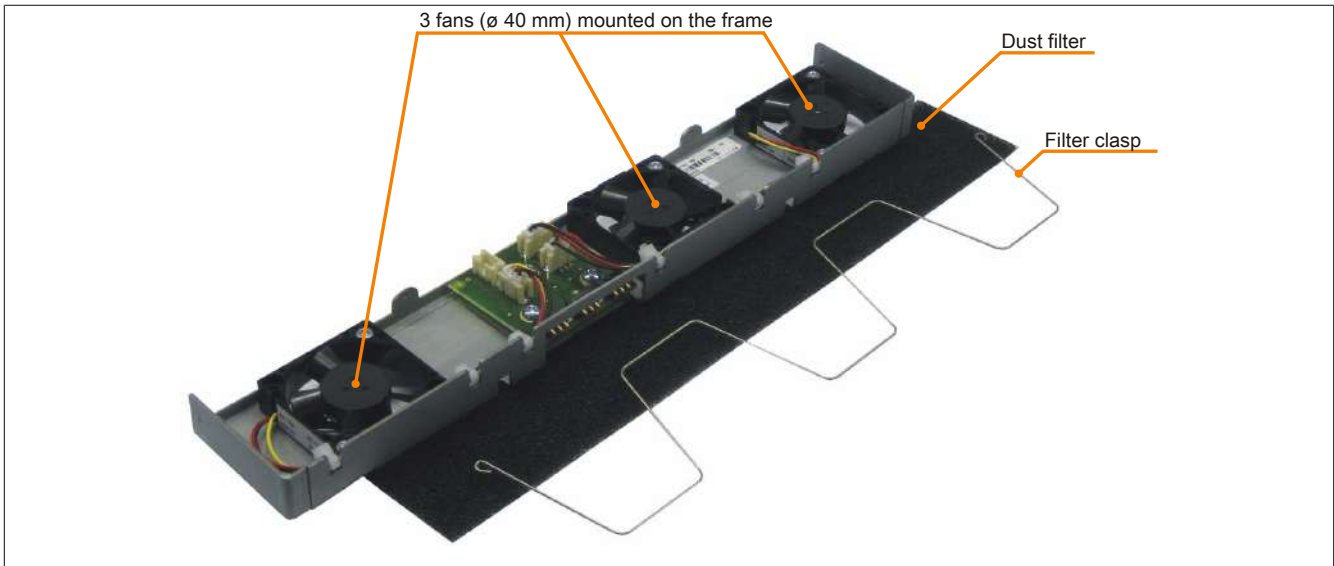

Figure 59: 5AC803.FA01-00 - Fan kit

3.10.1.2 Order data

Model number	Short description	Figure
5AC803.FA01-00	Fan kits PPC800 fan kit for system units without an expansion	

Table 103: 5AC803.FA01-00 - Order data

3.10.1.3 Technical data

Product ID	5AC803.FA01-00
General information	
Number of fans	3
Speed	Max. 6100 rpm
Noise level	21 dB
Service life	29,000 hours at 70°C 95,000 hours at 20°C
Type	Double ball bearings
Certification	
CE	Yes
GOST-R	Yes

Table 104: 5AC803.FA01-00 - Technical data

Product ID	5AC803.FA01-00
Mechanical characteristics	
Dimensions	
Fan	
Width	40 mm
Height	40 mm
Depth	10 mm

Table 104: 5AC803.FA01-00 - Technical data

3.10.2 5AC803.FA02-00

3.10.2.1 General information

This fan kit can be installed as an option on PPC800 system units with the 1-slot expansion.

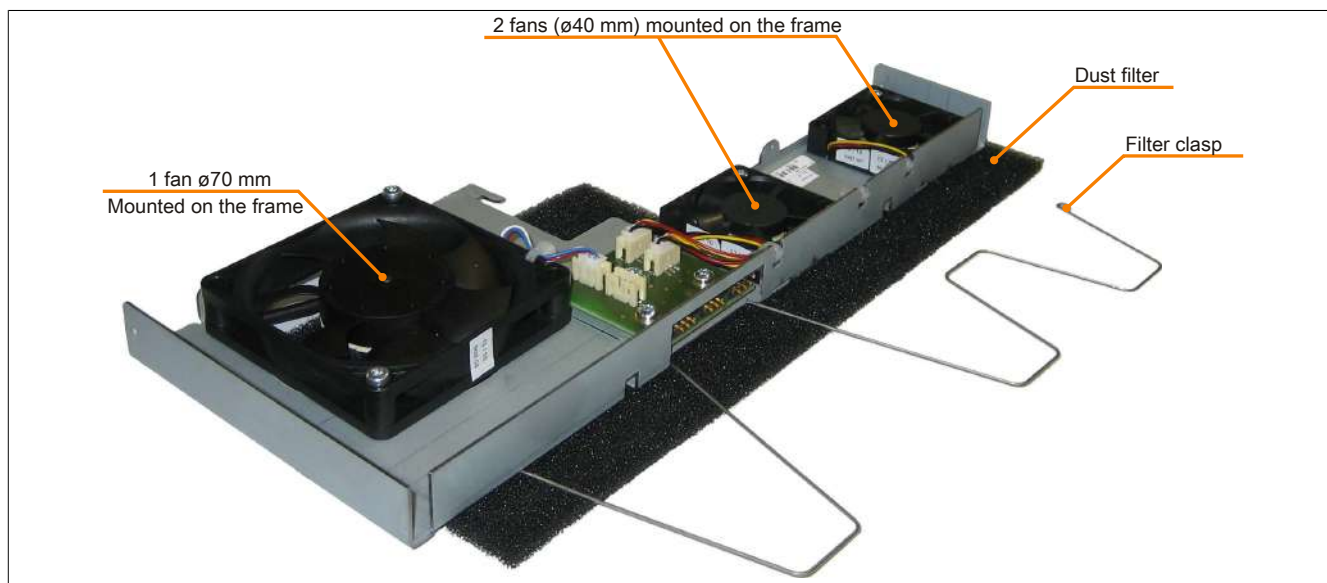

Figure 60: 5AC803.FA02-00 - Fan kit

3.10.2.2 Order data

Model number	Short description	Figure
	Fan kits	
5AC803.FA02-00	PPC800 fan kit for system units with expansion 5AC803.SX01-00	

Table 105: 5AC803.FA02-00 - Order data

3.10.2.3 Technical data

Product ID	5AC803.FA02-00
General information	
Number of fans	3
Speed	Fans 1, 2: max. 6100 rpm Fan 3: 4300 rpm ± 10%
Noise level	Fans 1, 2: 21 dB Fan 3: 5 dB
Service life	Fans 1, 2: 29,000 hours at 70°C, 95,000 hours at 20°C Fan 3: 60,000 hours (at 40°C)
Type	Double ball bearings
Certification	
CE	Yes
GOST-R	Yes

Table 106: 5AC803.FA02-00 - Technical data

Product ID	5AC803.FA02-00
Mechanical characteristics	
Dimensions	
Fan	
Width	Fans 1, 2: 40 mm Fan 3: 70 mm
Height	Fans 1, 2: 40 mm Fan 3: 70 mm
Depth	Fans 1, 2: 10 mm Fan 3: 15 mm

Table 106: 5AC803.FA02-00 - Technical data

3.10.3 5AC803.FA03-00

3.10.3.1 General information

This fan kit can be installed as an option on PPC800 system units with the 2-slot expansion.

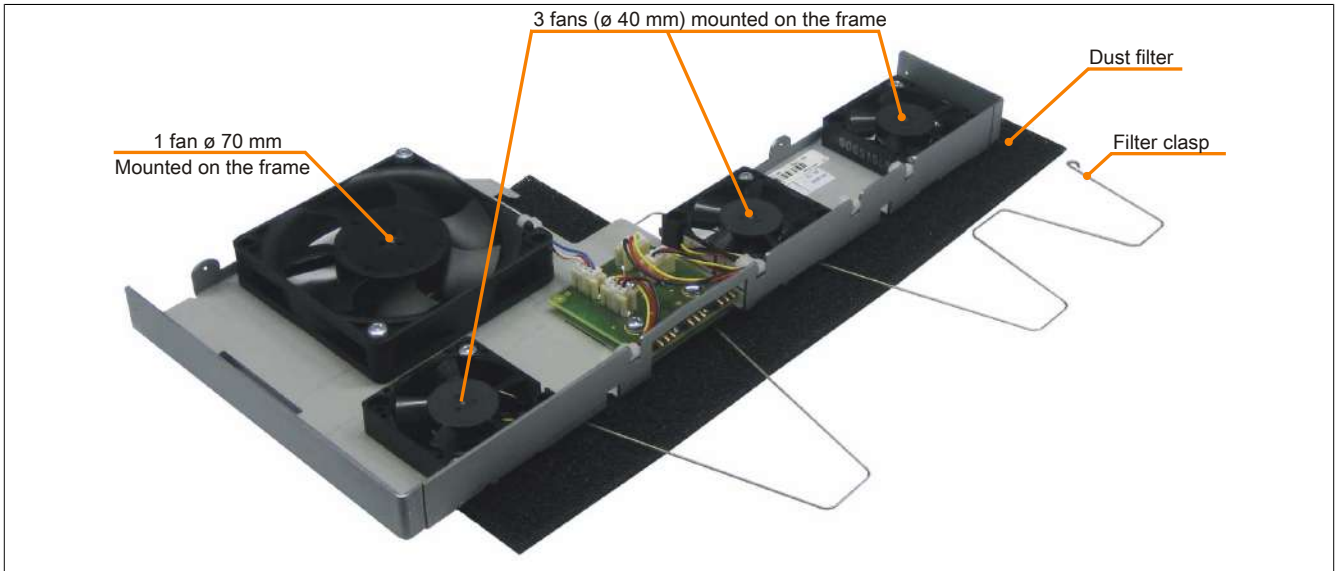

Figure 61: 5AC803.FA03-00 - Fan kit

3.10.3.2 Order data

Model number	Short description	Figure
5AC803.FA03-00	Fan kits PPC800 fan kit for system units with expansion 5AC803.SX02-00	

Table 107: 5AC803.FA03-00 - Order data

3.10.3.3 Technical data

Product ID	5AC803.FA03-00
General information	
Number of fans	4
Speed	Fans 1, 2, 3: max. 6100 rpm Fan 4: 4300 rpm ± 10%
Noise level	Fan 1, 2, 3: 21 dB Fan 4: 5 dB
Service life	Fan 1, 2, 3: 29,000 hours at 70°C, 95,000 hours at 20°C Fan 4: ±60,000 at 40°C
Type	Double ball bearings
Certification	
CE	Yes
GOST-R	Yes

Table 108: 5AC803.FA03-00 - Technical data

Product ID	5AC803.FA03-00
Mechanical characteristics	
Dimensions	
Fan	
Width	Fan 1, 2, 3: 40 mm Fan 4: 70 mm
Height	Fan 1, 2, 3: 40 mm Fan 4: 70 mm
Depth	Fan 1, 2, 3: 10 mm Fan 4: 15 mm

Table 108: 5AC803.FA03-00 - Technical data

Chapter 3 • Installation

1 Installation

Danger!

- All supplied power must be disconnected before removing device covers or components or installing/removing accessories, hardware or cables.
- The power cable must be disconnected from the device and from the voltage supply.
- All covers, components, accessories, hardware and cables must be installed or connected before the device can be connected to the power supply and turned on.

B&R Industrial PCs are best mounted in a wall cutout using the retaining clips or clamping blocks found on the housing (designs may vary).

1.1 Important installation information

- Environmental conditions must be taken into consideration.
- When installed in an enclosure, enough space must be available for air to circulate sufficiently.
- This device must be installed on a flat, clean and burr-free surface.
- This device is only certified for operation in enclosed rooms.
- This device must not be subjected to direct sunlight.
- Ventilation holes must not be covered.
- This device must be installed using one of the approved mounting orientations.
- The wall or control cabinet must be able to withstand four times the total weight of the device.
- The flex radius of connected cables (DVI, SDL, USB, etc.) must not be exceeded.
- This device must be installed in a position that minimizes glare on the screen.
- This device must be installed in a position and orientation that make viewing as easy as possible for the operator.

1.2 Installation with clamping blocks

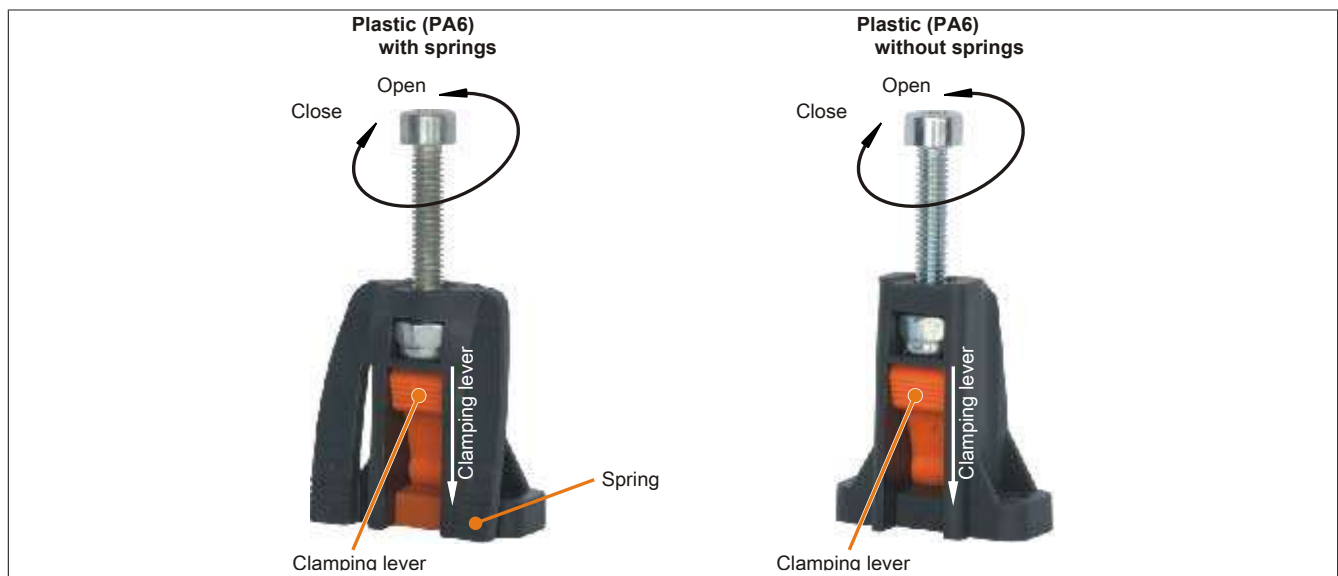

Figure 62: Clamping blocks

Clamping blocks are designed to clamp a maximum thickness of 10 mm and minimum thickness of 2 mm.

A hex key (3 mm) is needed to tighten and loosen the screws. The maximum torque when tightening the clamp is 0.5 Nm.

Devices must be installed on flat, clean and burr-free surface; uneven areas can cause damage to the display when the screws are tightened or intrusion of dust and water.

1.3 Mounting orientation

The PPC800 must be mounted as described in the following sections.

1.3.1 Mounting orientation 0° and +/- 45°

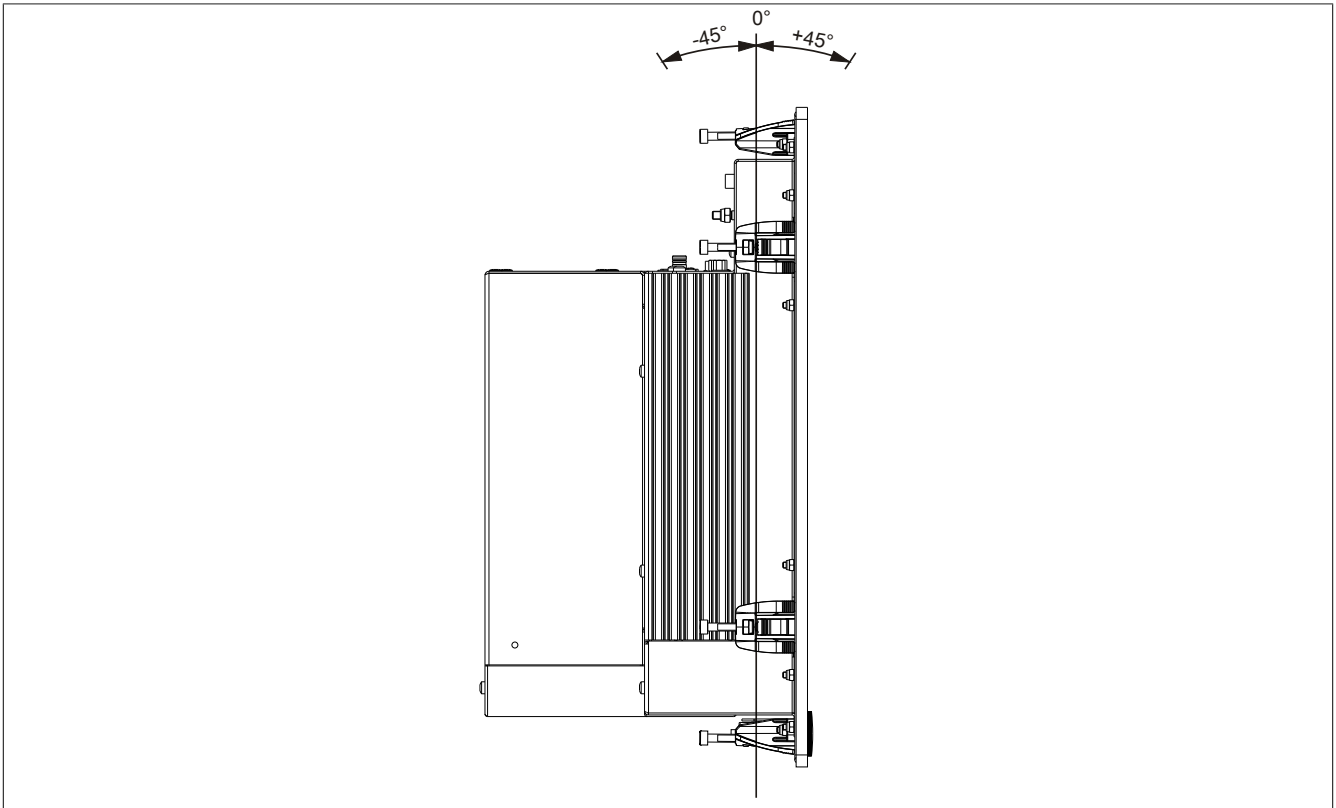

Figure 63: Mounting orientation 0° and +/- 45°

In order to facilitate natural air circulation, devices must be mounted according to the spacing indicated in the section "Spacing for air circulation" on page 139.

1.3.2 Mounting orientation with 5AC801.DVRS-00

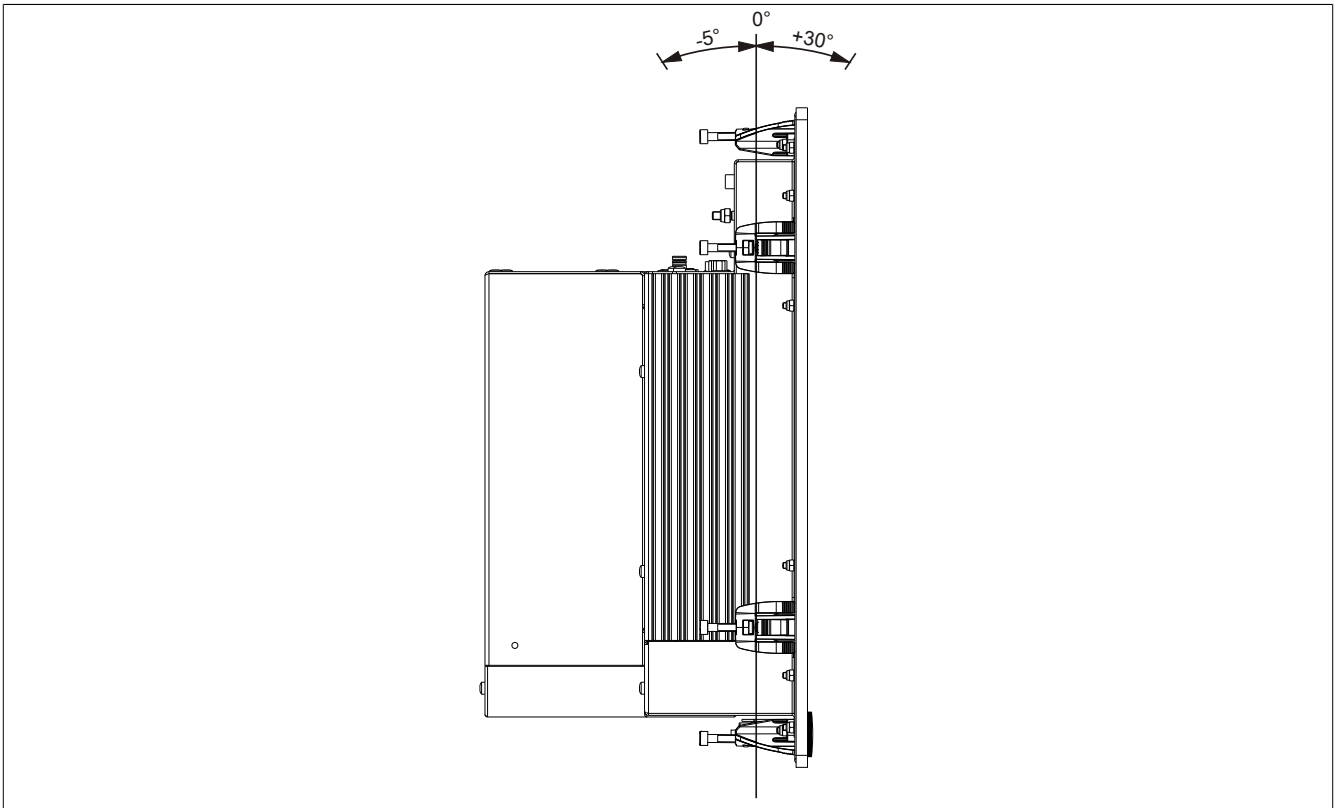

Figure 64: Mounting orientation with 5AC801.DVRS-00

In order to facilitate natural air circulation, devices must be mounted according to the spacing indicated in the section "Spacing for air circulation" on page 139.

1.3.3 Mounting orientation with 5AC801.DVDS-00

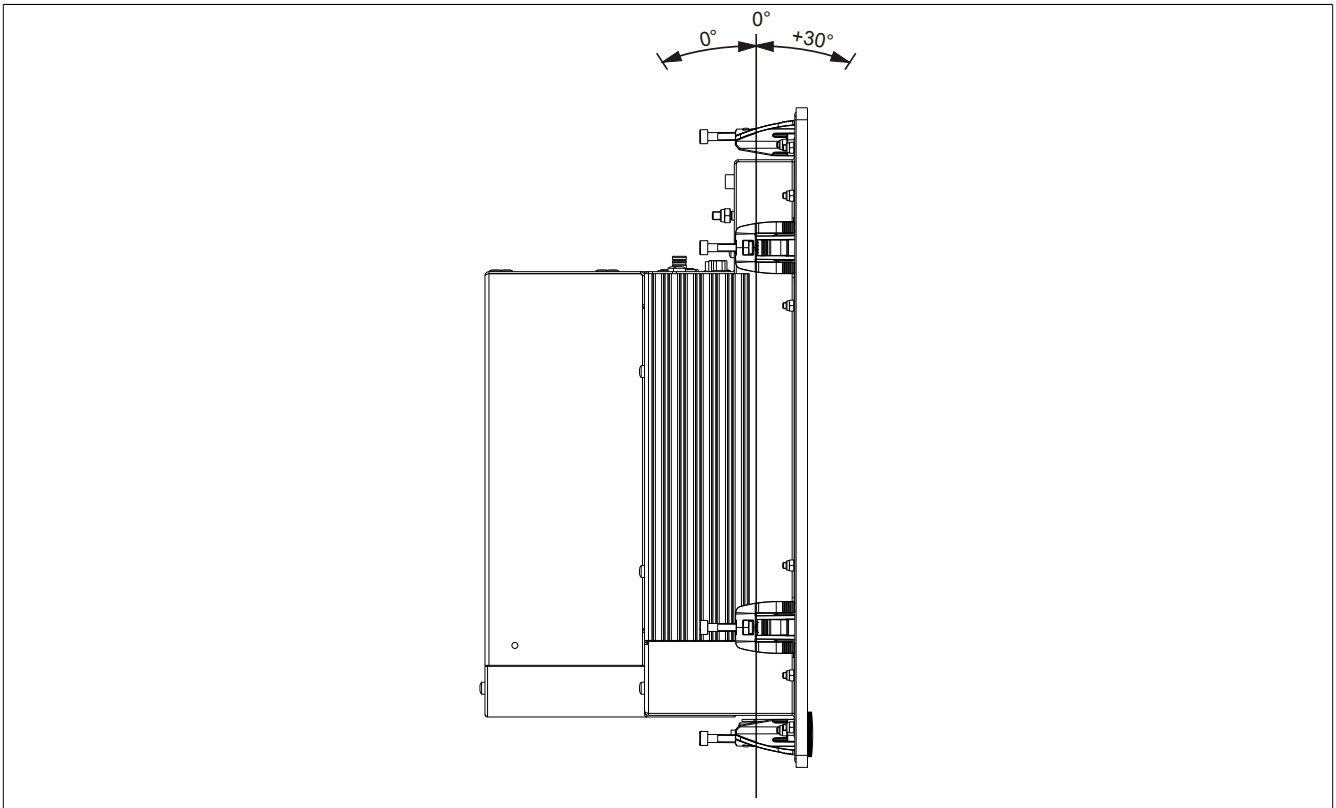

Figure 65: Mounting orientation with 5AC801.DVDS-00

In order to facilitate natural air circulation, devices must be mounted according to the spacing indicated in the section "Spacing for air circulation" on page 139.

1.4 Spacing for air circulation

In order to guarantee sufficient air circulation, allow the specified amount of space above, below, to the side and behind the Panel PC 800 devices. The minimum specified spacing is indicated in the following diagram. This applies to all Panel PC 800 variants.

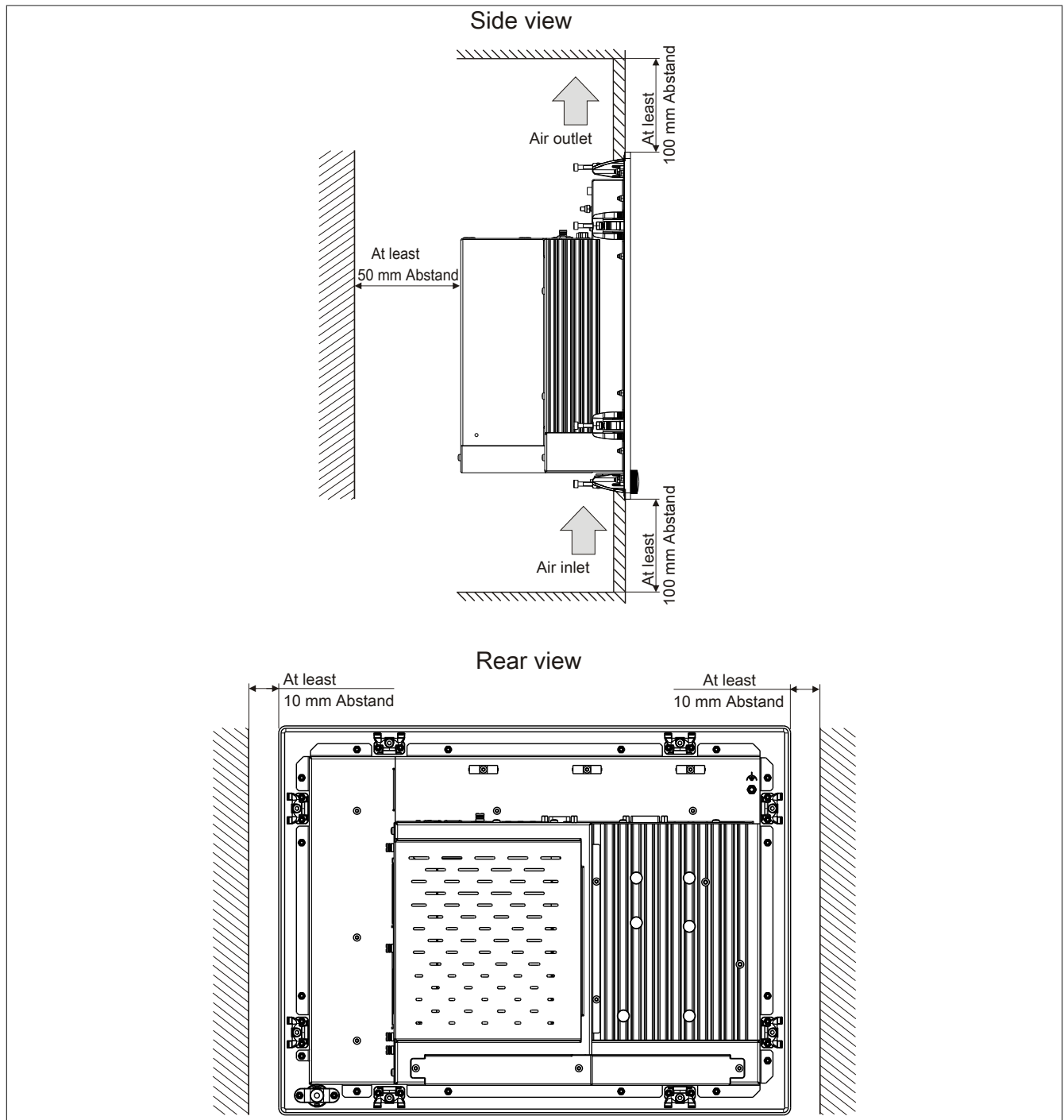

Figure 66: Spacing for air circulation

Information:

The spacing specifications for air circulation are based on the worst-case scenario for operation at the maximum specified ambient temperature (see "Temperature specifications" in the chapter "Technical data").

If the spacing specifications for air circulation cannot be adhered to, then the maximum specified temperatures for the temperature sensors (see "Temperature sensor locations" in the chapter "Technical data") must be monitored by the user and appropriate measures taken if they are exceeded.

2 Cable connections

Flex radius specifications must be taken into account when installing or connecting cables.

Information:

The maximum torque for the locating screws is 0.5 Nm.

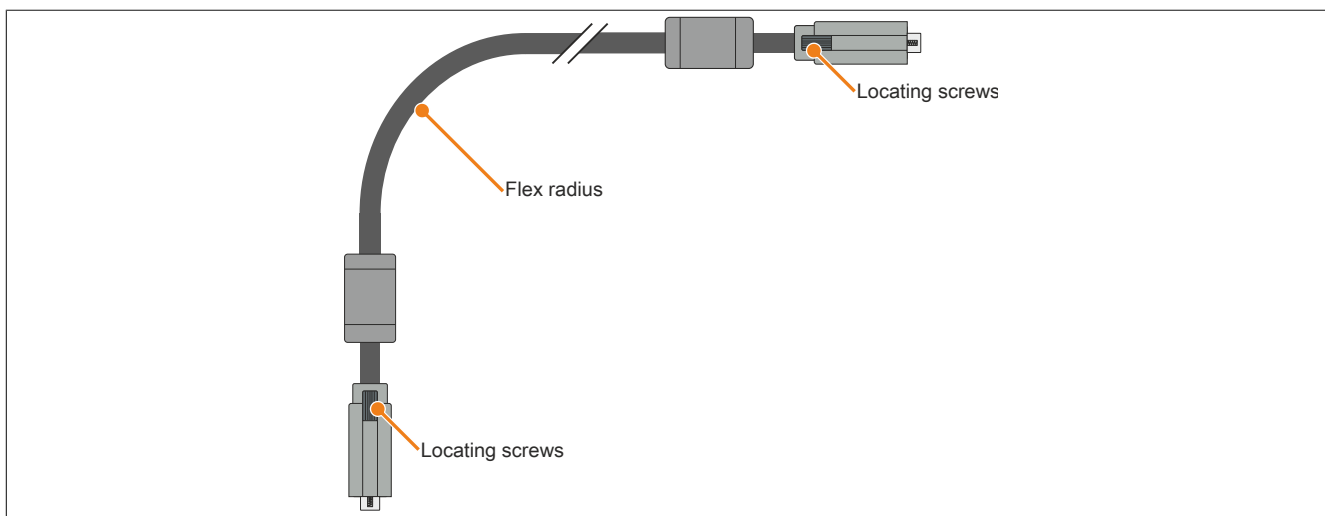

Figure 67: Flex radius - Cable connection

Information:

The specified flex radius is listed in the technical data for the respective cable.

3 Grounding concept

Functional ground is a current path of low impedance between electrical circuits and ground. It is used, for example, to improve immunity to disturbances and not necessarily as a protective measure. It therefore serves only to deflect disturbances, not to provide any kind of protection against electric shock.

This device comes equipped with two functional ground connections:

- Power supply
- Ground connection

To guarantee safe conductance of electric disturbances, the following points must be observed:

- The device must be connected to the central grounding point in the control cabinet using the shortest route possible.
- A cable with a minimum cross section of 2.5 mm^2 per connection should be used. If a cable with wire end sleeves is connected to the 0TB103.9 or 0TB103.91 terminal block, then a cable with maximum 1.5 mm^2 per connection is possible.
- Note the line shielding concept. All data cables connected to the device must be shielded.

Symbol indicating functional ground on the B&R device: 

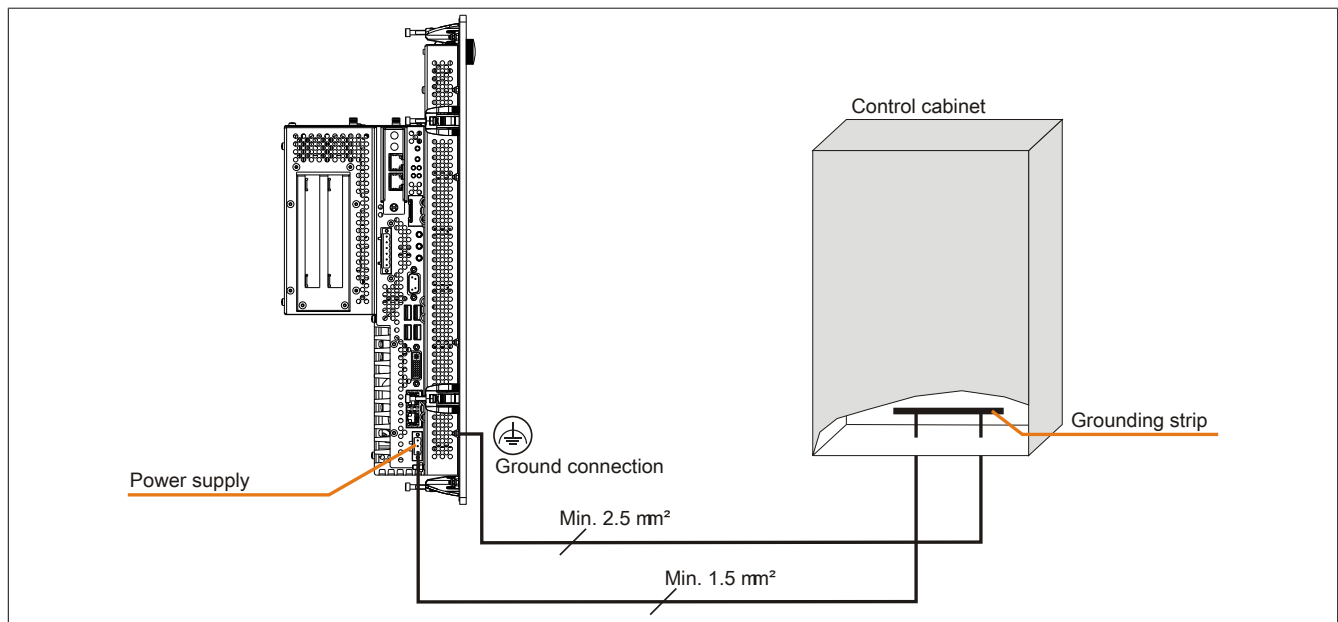

Figure 68: Grounding concept

4 General instructions for performing temperature testing

The purpose of these instructions is to explain general procedures for performing application-specific temperature testing on B&R Industrial PCs and Power Panels. Nevertheless, these instructions are meant to serve only as a guideline.

4.1 Procedure

In order to obtain accurate results, the testing conditions should match the conditions in the field. This means that for the duration of the temperature tests, the target application should be running, the PC should be installed in the control cabinet that will be used, etc.

In addition, a temperature sensor should be installed for the device being tested to provide live monitoring of the ambient temperature. In order to obtain accurate measurements, this sensor should be installed at a distance of 5 to 10 cm from the B&R Industrial PC near the air intake (not near the exhaust).

All B&R Industrial PCs and Power Panels are equipped with internal temperature sensors. These are installed in different locations for each series. The number of sensors and the temperature limits also vary from series to series.

For information about the locations of temperature sensors and the maximum specified values, please see section "Temperature sensor locations" in chapter 2 "Technical data".

To ensure that the thermal situation is evaluated reliably, a minimum of 8 hours is recommended for testing.

4.2 Evaluating temperatures in Windows operating systems

4.2.1 Evaluating with the B&R Control Center

The B&R Control Center can be used to evaluate the temperatures. Temperatures can be viewed on the "Temperatures" property page. The B&R Control Center is available at no cost in the Downloads section of the B&R website (www.br-automation.com). The B&R Control Center uses the B&R Automation Device Interface (ADI).

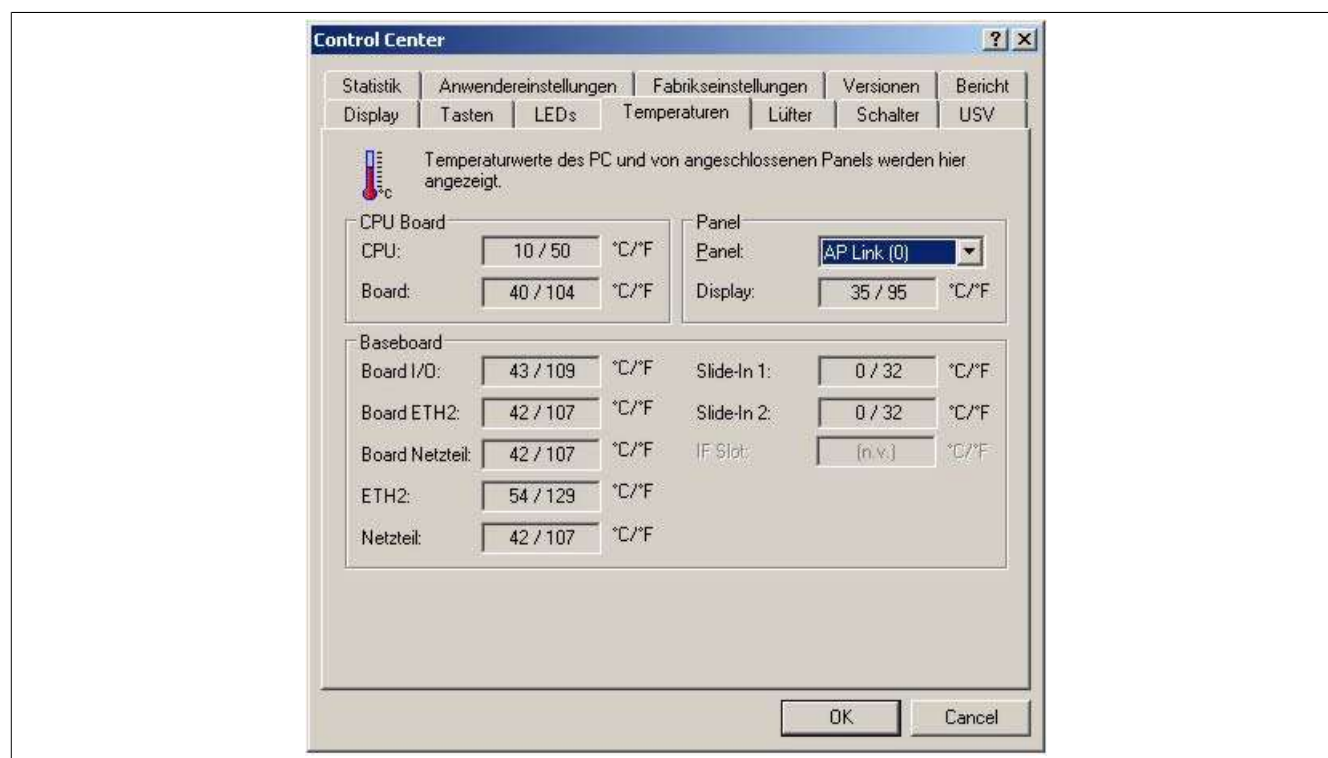

A separate application can be developed if it is necessary to collect historical data.

Information:

Software development kits such as the ADI .NET SDK are available on the B&R website (www.br-automation.com).

4.2.2 Evaluating with the BurnInTest tool from Passmark

If a separate application is not created or used to evaluate the temperature, then B&R recommends using the BurnInTest software tool from Passmark.

Standard and Professional versions of BurnInTest are available. In addition to the software package, there are also various loopback plugs (serial, parallel, USB, etc.) and test CDs/DVDs available. The exact software and loopback plugs used will determine the corresponding load that can be generated on the system and peripheral devices.

Information:

Loopback plugs are also available from Passmark. More information is available at www.passmark.com.

The following screenshots are based on Passmark BurnInTest Pro V4 and a 2-slot APC810 with DVD.

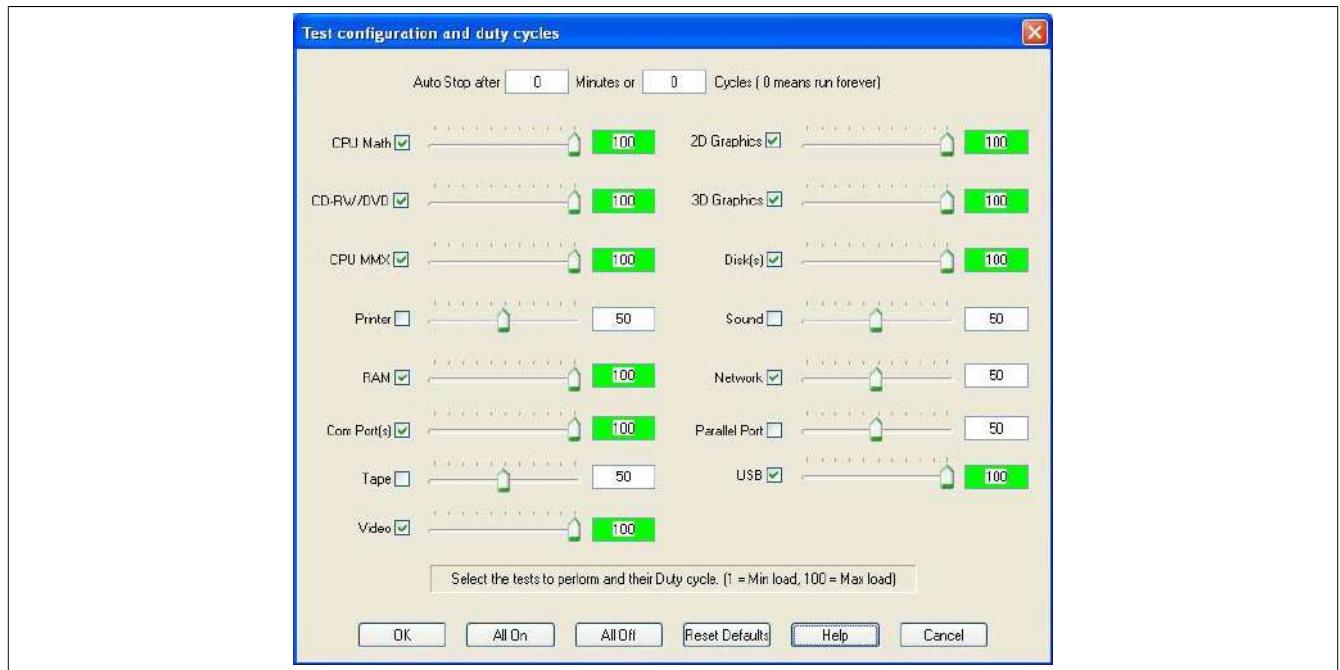

Figure 69: Settings for Passmark BurnInTest Pro V4 and a 2-slot APC810 with DVD

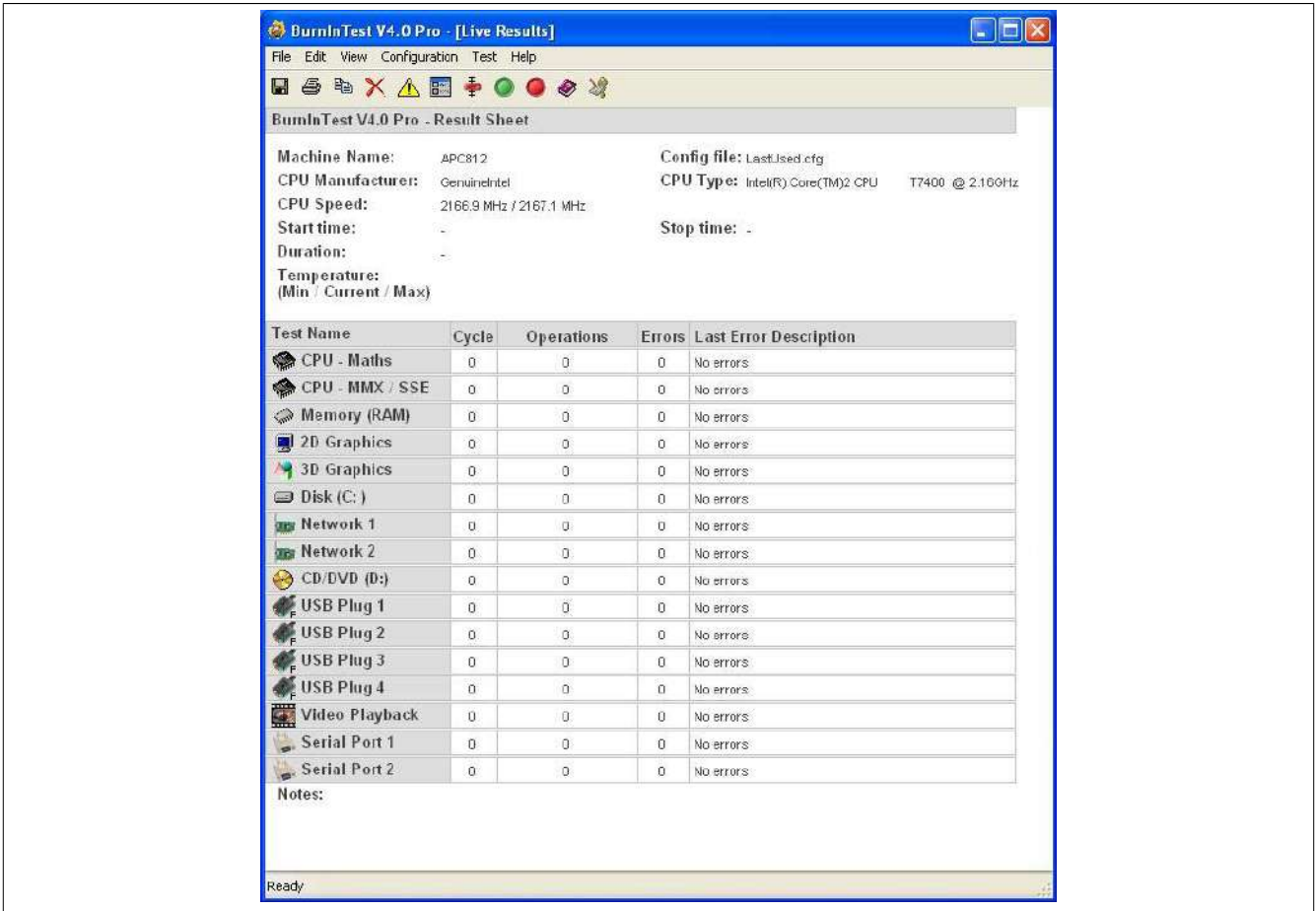

Figure 70: Test overview of a 2-slot APC810 with DVD

The respective test properties may need to be fine-tuned depending on the availability of a loopback plug and DVDs.

Information:

USB flash drives can also be used if a USB loopback plug is not available. The USB flash drives must be detected as formatted drives in Windows. The test USB must then be deselected, and the USB flash drives must be configured as the testing device in the disk properties.



Information:

Serial loopback plugs are relatively easy to create. Simply connect several pins on the serial interface with wires.

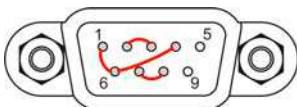

4.3 Evaluating temperatures in operating systems other than Windows

For applications that don't use Windows, temperatures can be evaluated with the help of the B&R implementation guide. In addition to the implementation guide, there are also programs available in MS-DOS.

The implementation guide only describes device-specific functions and not the main functions of the example programs.

If code from the example programs is used, it is important to observe the notes in the implementation guide regarding TODO statements, I/O access functions, etc.

Information:

Example programs and implementation guides for all B&R Industrial PCs and Power Panels are available at no cost from the B&R website (www.br-automation.com).

4.4 Evaluating the measurement results

The maximum temperature value recorded by each sensor must not exceed the temperature limits specified in the user's manuals.

If the temperature tests cannot be performed in a climate-controlled chamber, they can still be performed in an office environment. In this case, however, it is necessary to measure the ambient temperature. Experience at B&R has shown that values measured on passive systems (systems without a fan kit) can be projected linearly based on the ambient temperature. In order to be able to project the temperature values for systems with a fan kit, the fans must be running. It is also important to take values such as speed into consideration.

If the temperature tests are performed in a climate-controlled chamber with fans, the fans will cool the devices and skew the results. Measurement results for passive devices would therefore be unusable in this case. In order to obtain accurate results in climate-controlled chambers with fans, the fans must be turned off and the device must be allowed to run for a sufficient amount of time (several hours) before beginning the test.

Example using a 2-slot APC810

The following example is only valid if the instructions for installation and mounting orientation provided in the user's manual are observed.

Temperature sensor	Measured temperature	Projected temperature	
Ambient temperature	20°C	35°C	45°C
CPU	48°C	63°C	73°C
CPU board	51°C	66°C	76°C
Board I/O	51°C	66°C	76°C
Board ETH2	52°C	67°C	77°C
Board power supply	51°C	66°C	76°C
ETH2	65°C	80°C	90°C
Power supply	51°C	66°C	76°C

Table 109: Evaluation example using a 2-slot APC810

5 Connection examples

The following example provides an overview of the configuration options for connecting external panels with the PPC800. The following question will be answered:

- Which panels can be operated using the monitor/panel interface?

5.1 One office TFT via RGB onboard

An office TFT (analog RGB) with a maximum resolution of 1920 x 1200 (WUXGA) is connected to the integrated RGB interface (onboard).

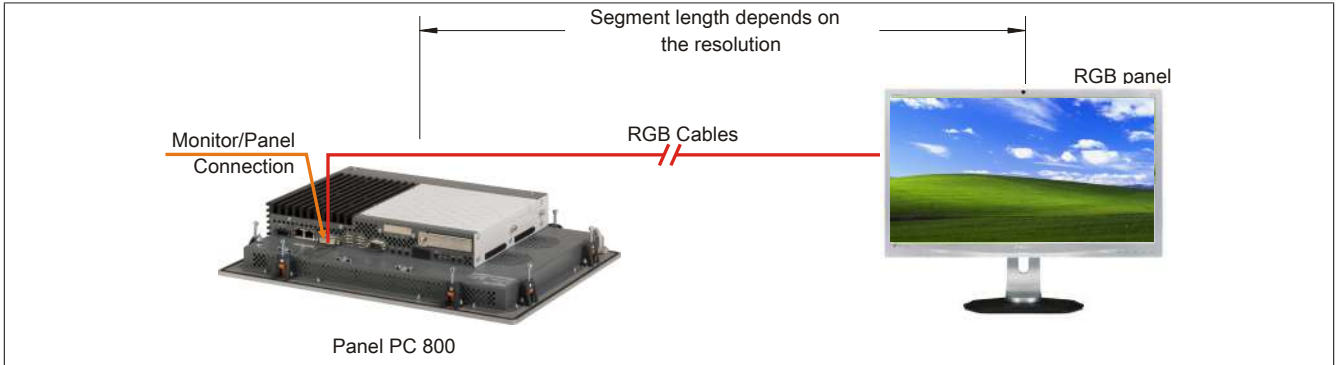

Figure 71: One office TFT via RGB

6 Touch screen calibration

B&R touch screen devices are equipped with a touch controller that supports hardware calibration. As a result, devices are pre-calibrated when delivered. This is an advantageous feature when replacing devices of the same model or type since it avoids having to recalibrate the new device. Nevertheless, calibrating the device is still recommended in order to achieve the best results and to better adapt the touch screen to the user's preferences.

Regardless of this, the touch screen will have to be calibrated once during or following the installation of the touch screen driver.

6.1 Windows XP Professional

After installing Windows XP Professional on the device, the touch screen driver must be installed in order to operate the touch screen. The necessary driver is available in the Downloads section of the B&R website (www.br-automation.com).

6.2 Windows XP Embedded

After starting Windows XP Embedded on the device for the first time (first boot agent), the touch screen driver must be installed in order to operate the touch screen. The necessary driver is available in the Downloads section of the B&R website www.br-automation.com.

6.3 Windows Embedded Standard 2009

After starting Windows Embedded Standard 2009 on the Panel PC or Power Panel for the first time (first boot agent), the corresponding touch screen driver is installed automatically.

On all other devices, the touch screen driver must be installed in order to operate the touch screen. The necessary driver is available in the Downloads section of the B&R website (www.br-automation.com).

6.4 Windows 7 Professional / Ultimate

After installing Windows 7 on the device, the touch screen driver must be installed in order to operate the touch screen. The necessary driver is available in the Downloads section of the B&R website (www.br-automation.com).

6.5 Windows Embedded Standard 7 Embedded / Premium

A touch screen driver will be installed automatically if a touch controller is detected during the Windows Embedded Standard 7 installation.

The touch screen driver must be installed manually if a touch controller was not detected during the Windows Embedded Standard 7 setup or if an Automation Panel 800/900/9x3/9xD has been connected after setup. The necessary driver is available in the Downloads section of the B&R website (www.br-automation.com).

6.6 Windows CE

Windows CE starts the touch screen calibration sequence during its first boot in its default configuration (i.e. delivered state).

6.7 Automation Runtime / Visual Components

The touch screen must be calibrated once for the customer application when commissioning the device and project.

7 Connecting USB peripheral devices

7.1 Locally on the PPC800

Many different peripheral USB devices can be connected to the 5 USB interfaces on the Panel PC 800. These can each handle a load of up to 1 A. The maximum transfer rate is USB 2.0.

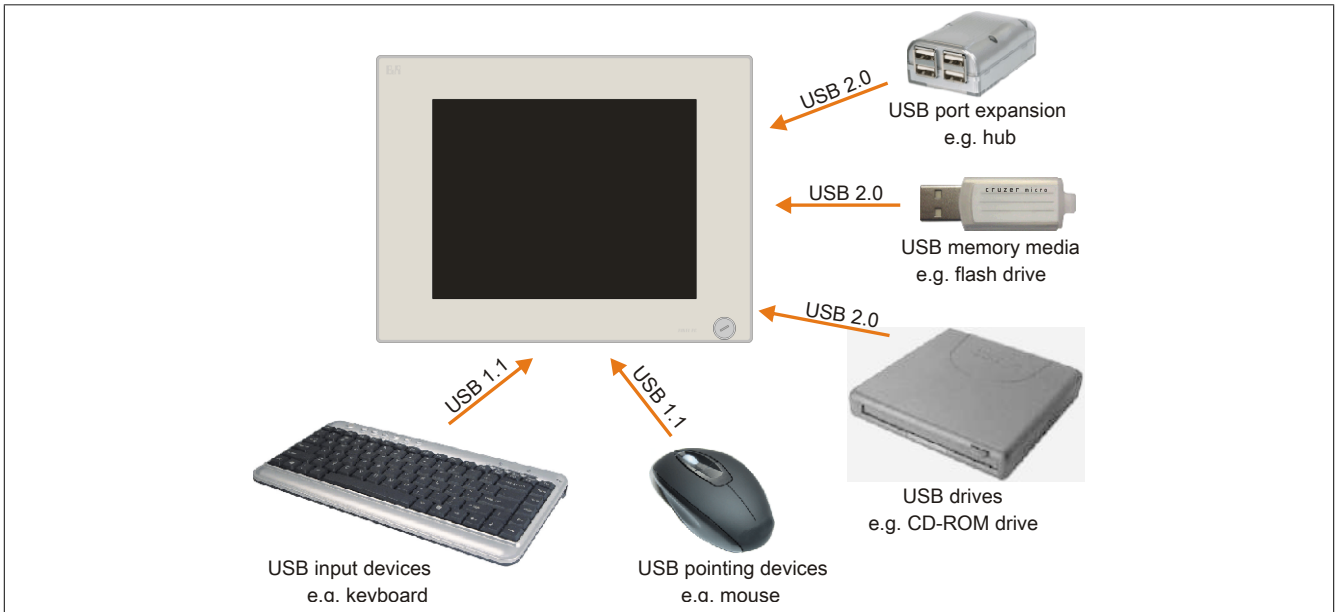

Figure 72: Local connection of USB peripheral devices on the PPC800

8 Configuring a SATA RAID set

Information:

The following software description is valid for PCI SATA controllers 5ACPCI.RAIC-01, 5ACPCI.RAIC-03, 5ACPCI.RAIC-05 and 5ACPCI.RAIC-06.

The "RAID Configuration Utility" in BIOS must be started in order to make the necessary settings. After POST, pressing <Ctrl+S> or <F4> opens the RAID BIOS.

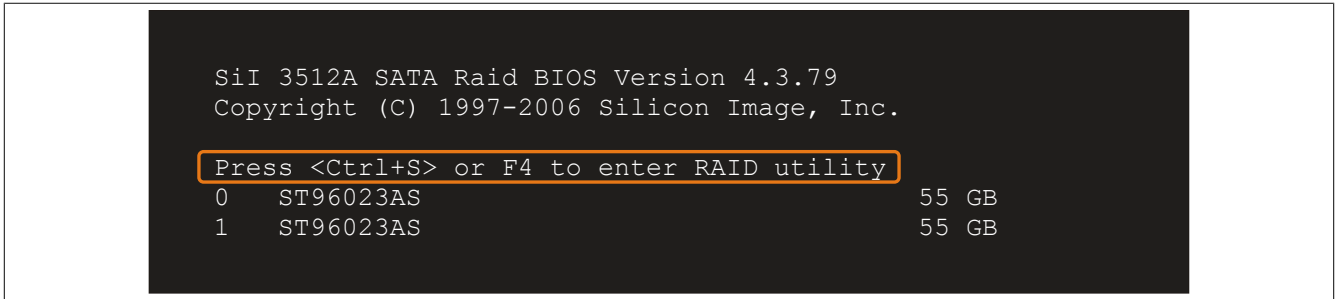

Figure 73: Open the RAID Configuration Utility

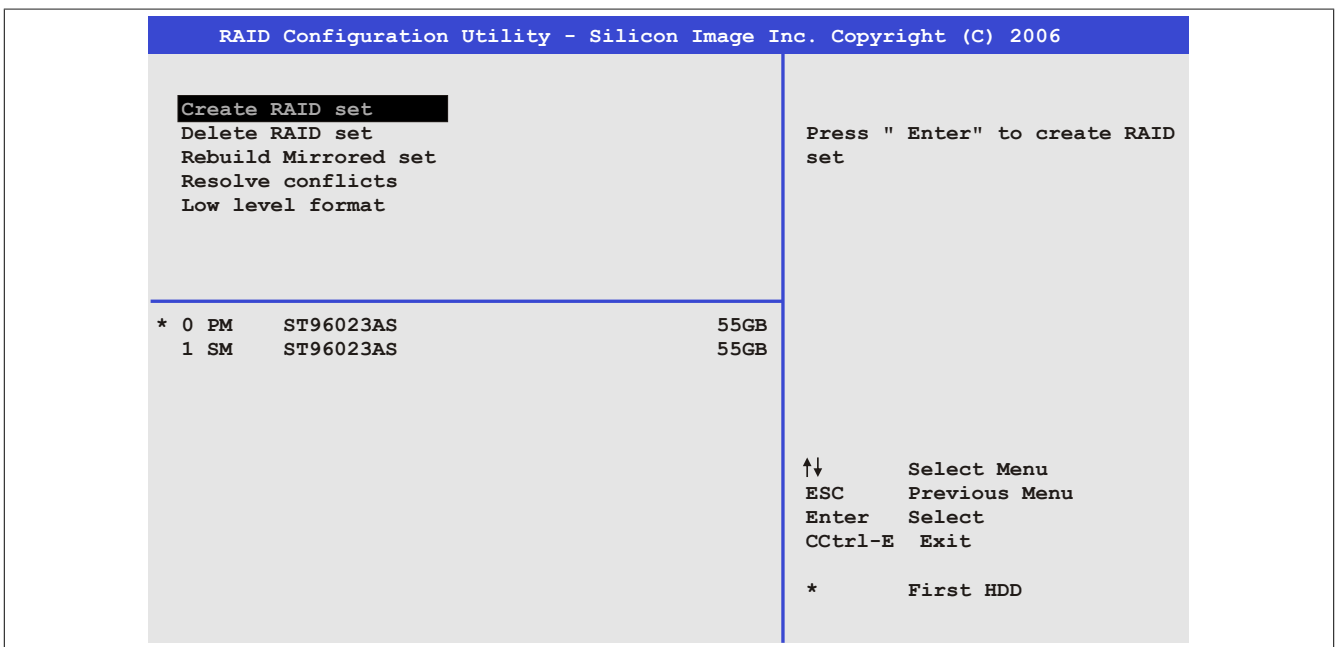

Figure 74: RAID Configuration Utility - Menu

The following keys can be used once inside BIOS Setup:

Key	Function
Cursor ↑	Moves to the previous item
Cursor ↓	Moves to the next item
Enter	Selects an item or opens a submenu
ESC	Returns to the previous menu
Ctrl+E	Saves any changed settings and exits setup

Table 110: BIOS-relevant keys in the RAID Configuration Utility

8.1 Create RAID set

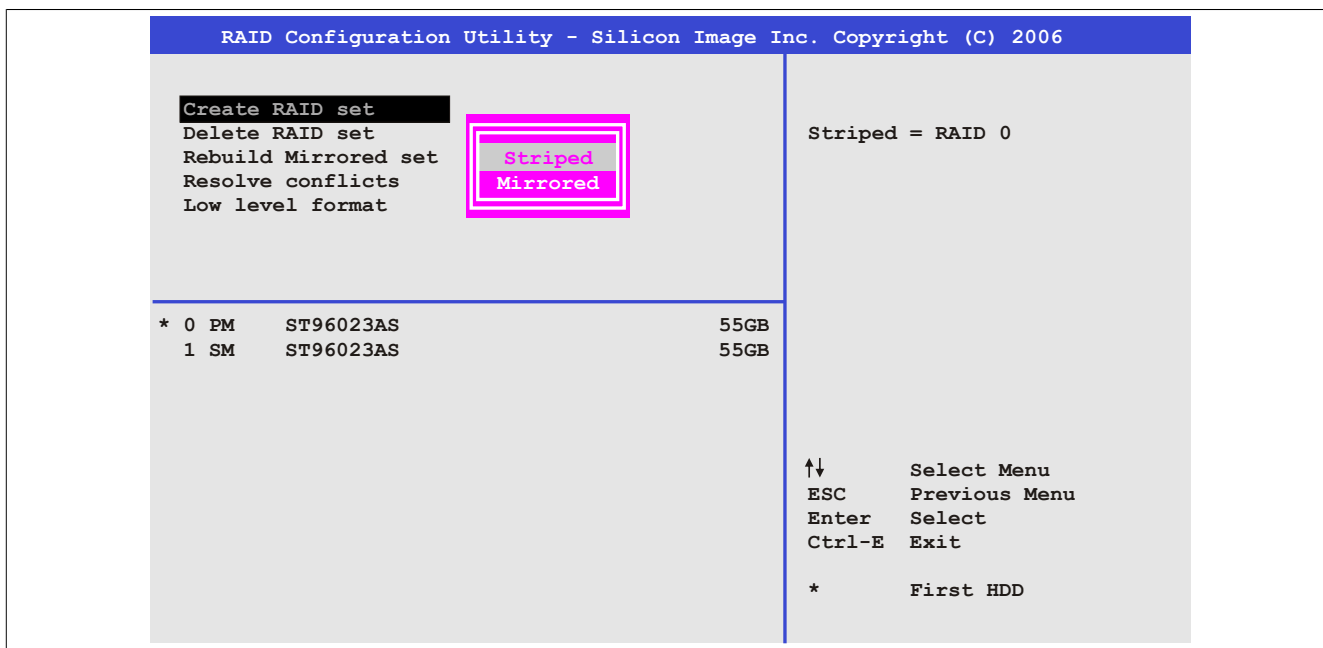

Figure 75: RAID Configuration Utility - Menu

The RAID system can be set up as "Striped" = RAID0 or "Mirrored" = RAID1 using the "Create RAID set" menu option.

8.2 Create RAID set - Striped

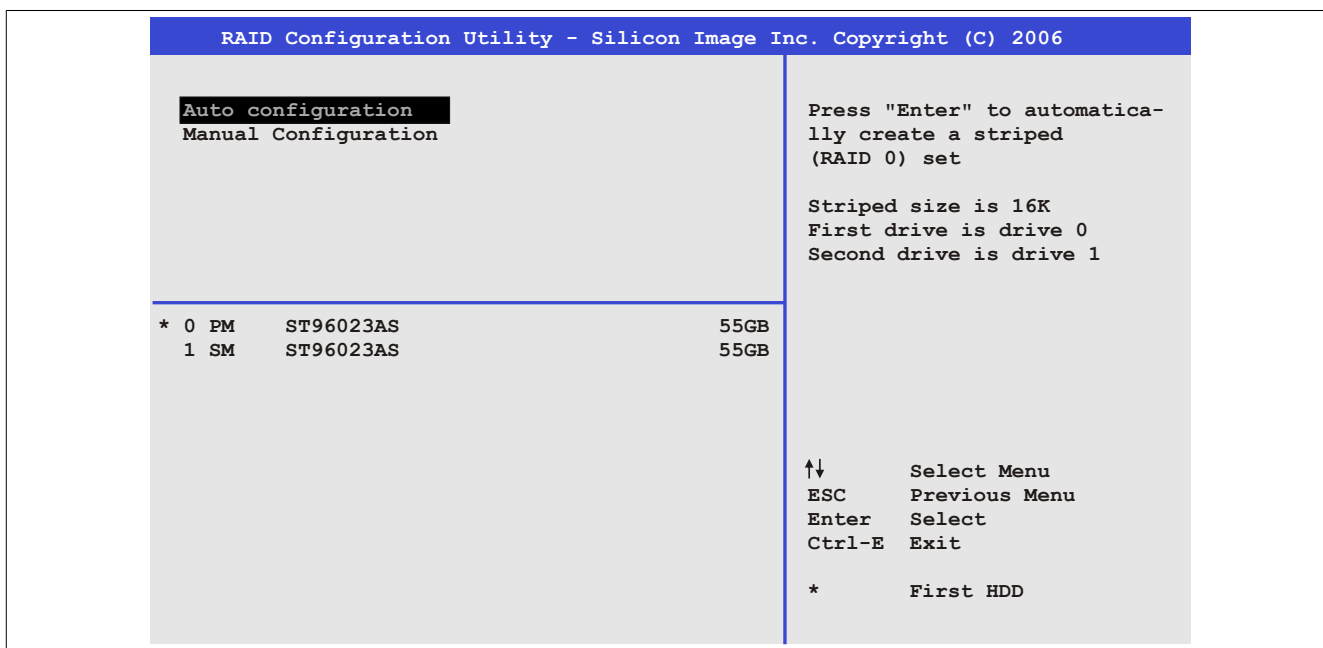

Figure 76: RAID Configuration Utility - Create RAID set - Striped

"Auto configuration"

Auto configuration optimizes all settings.

"Manual configuration"

Allows the first and second HDD to be specified as well as the "Chunk size" (= block size, application-dependent).

8.3 Create RAID set - Mirrored

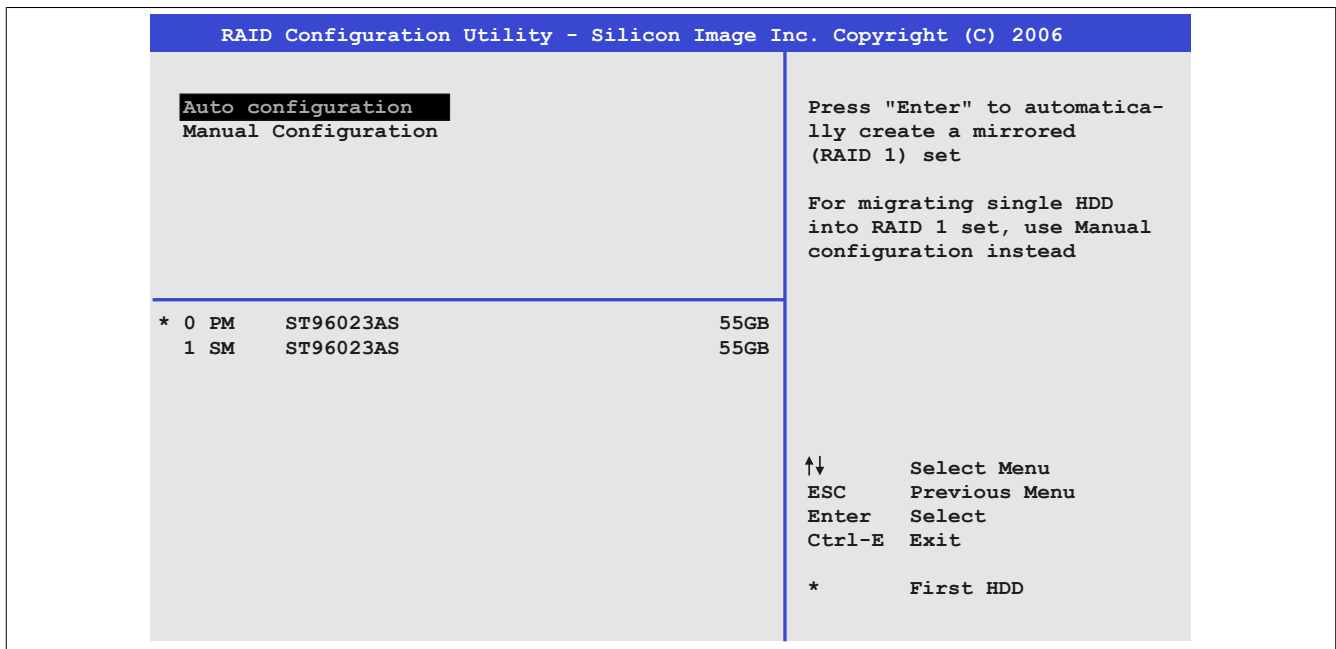

Figure 77: RAID Configuration Utility - Create RAID set - Mirrored

"Auto configuration"

Auto configuration optimizes all settings.

"Manual configuration"

Allows the "Source" and "Target" HDD to be specified as well as whether a rebuild (mirror) should be performed immediately (takes approx. 50 minutes).

8.4 Delete RAID set

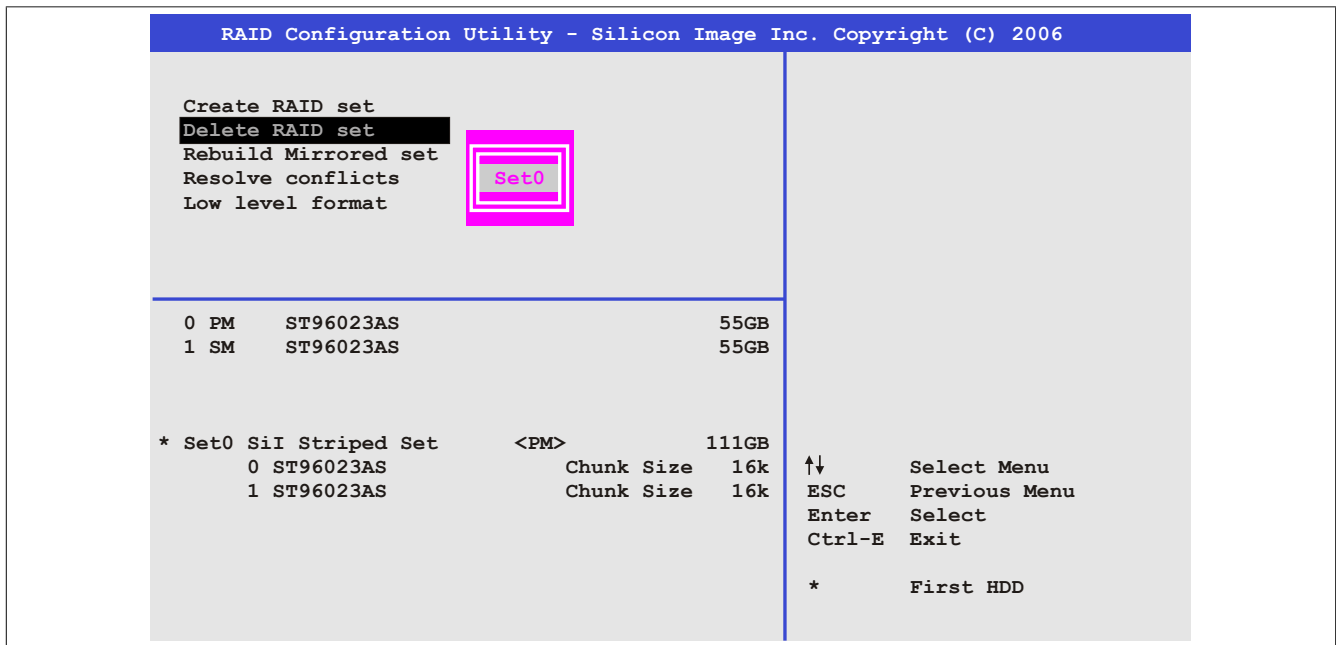

Figure 78: RAID Configuration Utility - Delete RAID set

An existing RAID set can be deleted using the "Delete RAID set" menu option.

8.5 Rebuild mirrored set

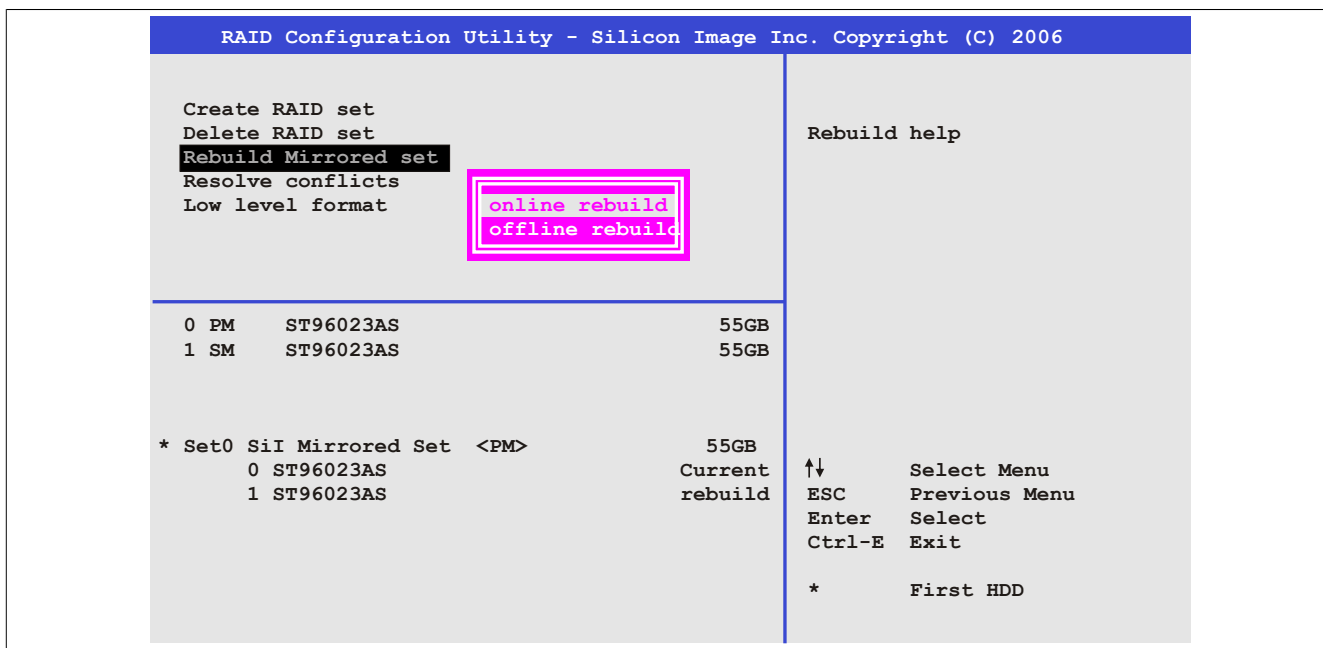

Figure 79: RAID Configuration Utility - Rebuild mirrored set

The "Rebuild mirrored set" menu option can be used to restart a rebuild procedure in a RAID 1 set if an error occurs, if a rebuild procedure was interrupted or if a hard disk was replaced.

If "Online rebuild" is selected, then the rebuild is executed during operation after the system is booted. The installed SATA RAID configuration program may display an event pop-up message: SATA Raid detected a new event before restarting the rebuild. The entire rebuild takes approximately 50 minutes.

If "Offline rebuild" is selected, then a rebuild is performed immediately before the operating system is started (duration depends on the respective memory size).

8.6 Resolve conflicts

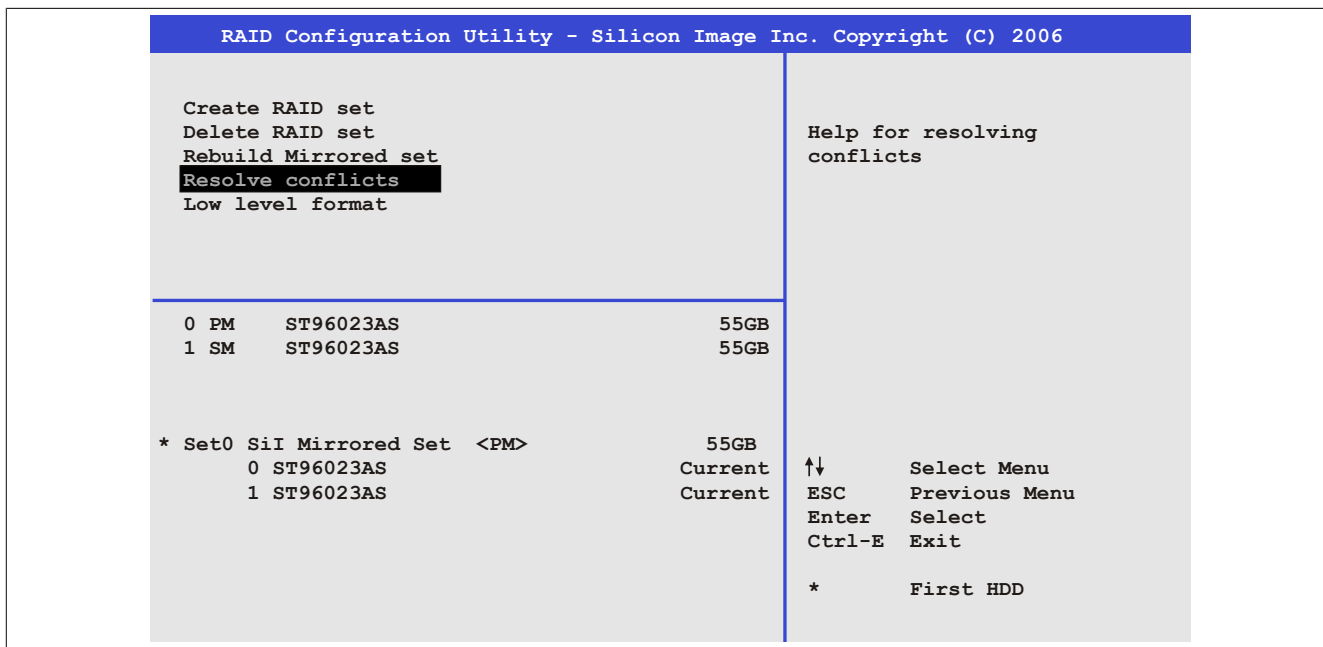

Figure 80: RAID Configuration Utility - Resolve conflicts

Conflicts in a RAID set can be resolved using the "Resolve conflicts" menu option. This function is only available if the status of the hard disk is "Conflict".

8.7 Low level format

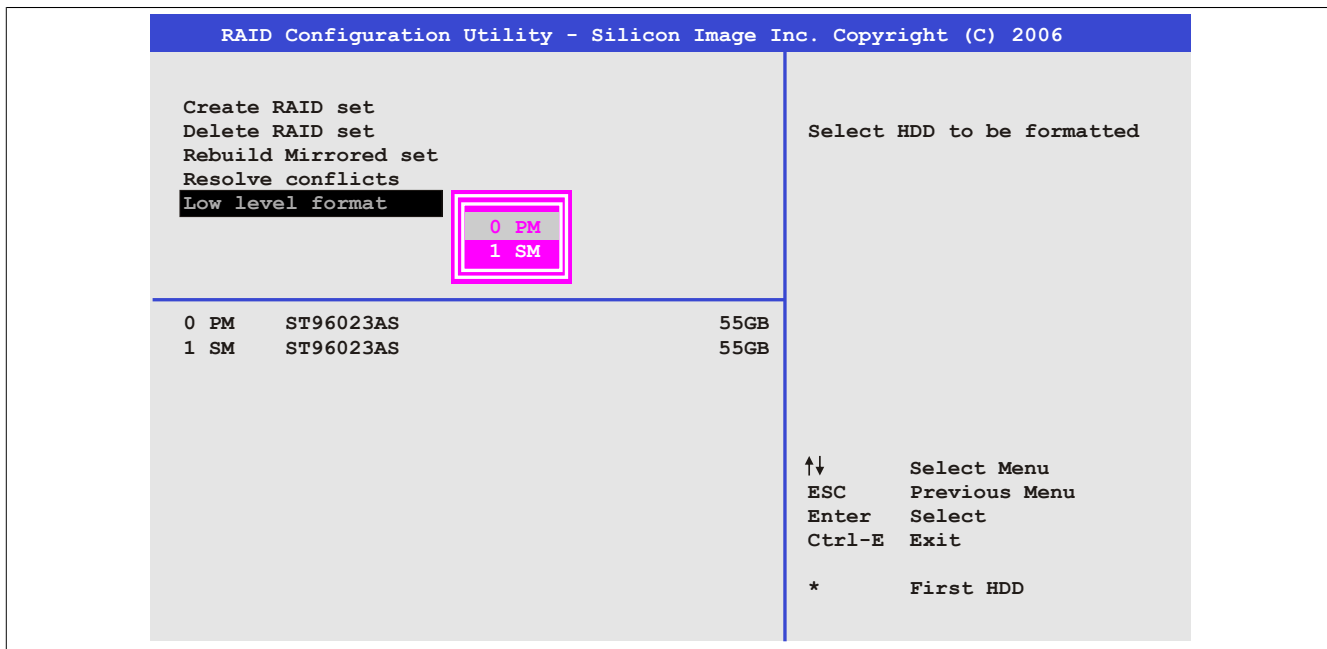

Figure 81: RAID Configuration Utility - Low level format

Individual hard disks can be configured using the "Low level format" menu option. This can only be done if a RAID set is not configured. A low level format of a hard disk takes approx. 40 minutes.

9 Tips for extending the service life of the display

9.1 Backlight

The service life of the backlight is specified by its "half-brightness time". For example, a specified operating time of 50,000 hours means that the display would still retain 50% of its brightness after this time.

9.1.1 How can the service life of the backlight be extended?

- By setting the display brightness to the lowest value that is still comfortable for the eyes
- By using dark images
- By reducing the brightness by 50%, which can result in an approximately 50% increase in the half-brightness time

9.2 Screen burn-in

Screen burn-in refers to the "burning in" of a static image on a display after being displayed for a prolonged period of time. Nevertheless, static images are not the only cause of screen burn-in. Screen burn-in is also referred to as burn-in effect, image retention, memory effect, memory sticking or ghost image.

There are basically two types:

- Area type: This type of screen burn-in is indicated by a dark gray image. The effect will disappear if the display is switched off for a long period of time.
- Line type: This type of screen burn-in can cause lasting damage.

9.2.1 What causes screen burn-in?

- Static images
- No screensaver
- Sharp transitions in contrast (e.g. black/white)
- High ambient temperatures
- Operation outside of specifications

9.2.2 How can screen burn-in be avoided?

- By constantly changing between static and dynamic images
- By avoiding excessive brightness differences between foreground and background elements
- By using colors with similar brightness
- By using complementary colors in follow-up images
- By using a screensaver

10 Pixel errors

Information:

Displays may contain defective pixels (dead/stuck pixels) that result from the manufacturing process. These flaws are not grounds for reclamation or initiating a warranty claim.

11 Known problems/issues

- Using two different types of CompactFlash cards can cause problems with Automation PCs and Panel PCs. For example, it is possible that one of the two cards is not detected during system startup. This is caused by different startup speeds. CompactFlash cards with older technology require significantly more time during system startup than CompactFlash cards with newer technology. This behavior occurs near the end of the time frame provided for startup. The problem described can occur because the startup time for the CompactFlash cards fluctuates due to the different components being used. Depending on the CompactFlash cards being used, this error may occur never, sometimes or always.
- Only RGB is available on the monitor/panel interface.
- If the PCIe slot is operated with an exclusive IRQ, then PCI Express root port 2 must be disabled in BIOS. Disabling PCI Express root port 2 turns off the PCIe to PATA bridge that is using the same PIRQ line as the PCIe slot. As a result, the PCIe slot can again be used exclusively, but the CF1 and CF2 slots are disabled. Only one SATA device can be used as a mass storage device in the slide-in or compact slide-in slot. In addition, ARwin must be configured for shared IRQ operation (see ARwin help documentation).
- The Intel NM10 chipset no longer supports AC'97 sound.

Chapter 4 • Software

1 BIOS options

Information:

The following diagrams and BIOS menu items including descriptions refer to BIOS version 1.11. It is therefore possible that these diagrams and BIOS descriptions will not correspond with the BIOS version actually installed.

1.1 General information

BIOS is an acronym for "Basic Input/Output System". It is the most basic standardized interface between the user and the system (hardware). The BIOS system used in this B&R Industrial PC was developed by American Megatrends Inc.

The BIOS Setup utility can be used to modify basic system configuration settings. These settings are stored in CMOS and EEPROM memory (as a backup).

CMOS data is buffered by a battery (if present) and remains stored on the B&R Industrial PC even when the power is turned off (no 24 VDC supply).

1.2 BIOS setup and boot procedure

BIOS is immediately activated when switching on the power supply or pressing the power button on the B&R Industrial PC. The system checks if the setup data from EEPROM memory is "OK". If the data is "OK", then it is transferred to CMOS. If the data is "Not OK", then the CMOS data is checked to see whether it is valid. An error message is output if the CMOS data contains errors, and the boot procedure can be continued by pressing <F1>. To prevent an error message from appearing at each restart, the BIOS Setup utility can be opened by pressing . The settings can then be re-saved.

BIOS reads the system configuration information, checks and configures the system with the Power-On Self-Test (POST).

When these "preliminaries" are finished, BIOS looks for an operating system on the available data storage devices (hard drive, floppy drive, etc.). BIOS then launches the operating system and hands over to it the control of system operations.

To enter BIOS Setup, the key must be pressed after the USB controller has been initialized as soon as the following message appears on the screen (during POST): "Press DEL or ESC to enter Setup"



Figure 82: Boot screen

1.2.1 BIOS Setup keys

The following keys are enabled during POST:

Information:

Key signals from USB keyboards will only be registered after the USB controller has been initialized.

Keys	Function
DEL, ESC	Opens the main BIOS Setup screen
F12	Network boot
F11	Opens the boot menu. This lists all bootable devices that are connected to the system. Selecting a device with cursor ↑, cursor ↓ and the pressing <ENTER> will boot from that device.
	
<Pause>	Pauses POST. Pressing any other key resumes POST.

Table 111: BIOS-relevant keys for POST

The following keys can be used once inside BIOS Setup:

Key	Function
F1	Opens general help information
Cursor ↑	Moves to the previous item
Cursor ↓	Moves to the next item
Cursor ←	Moves to the previous item
Cursor →	Moves to the next item
+-	Changes the setting for the selected function
Enter	Changes to the selected menu / Confirms selection
Home 1 / PgUp	Jumps to the first BIOS menu item or object
End / PgDn	Jumps to the last BIOS menu item or object
F2	Resets any changes
F9	Loads and configures CMOS default values for all BIOS settings
F10	Saves and exits
ESC	Exits a submenu

Table 112: BIOS-relevant keys

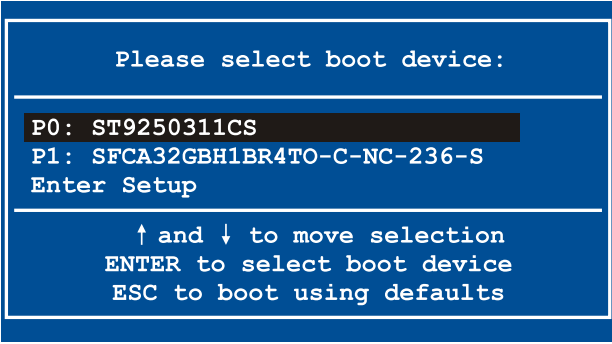
1.3 Main

The main BIOS Setup screen appears immediately after the button is pressed during startup.

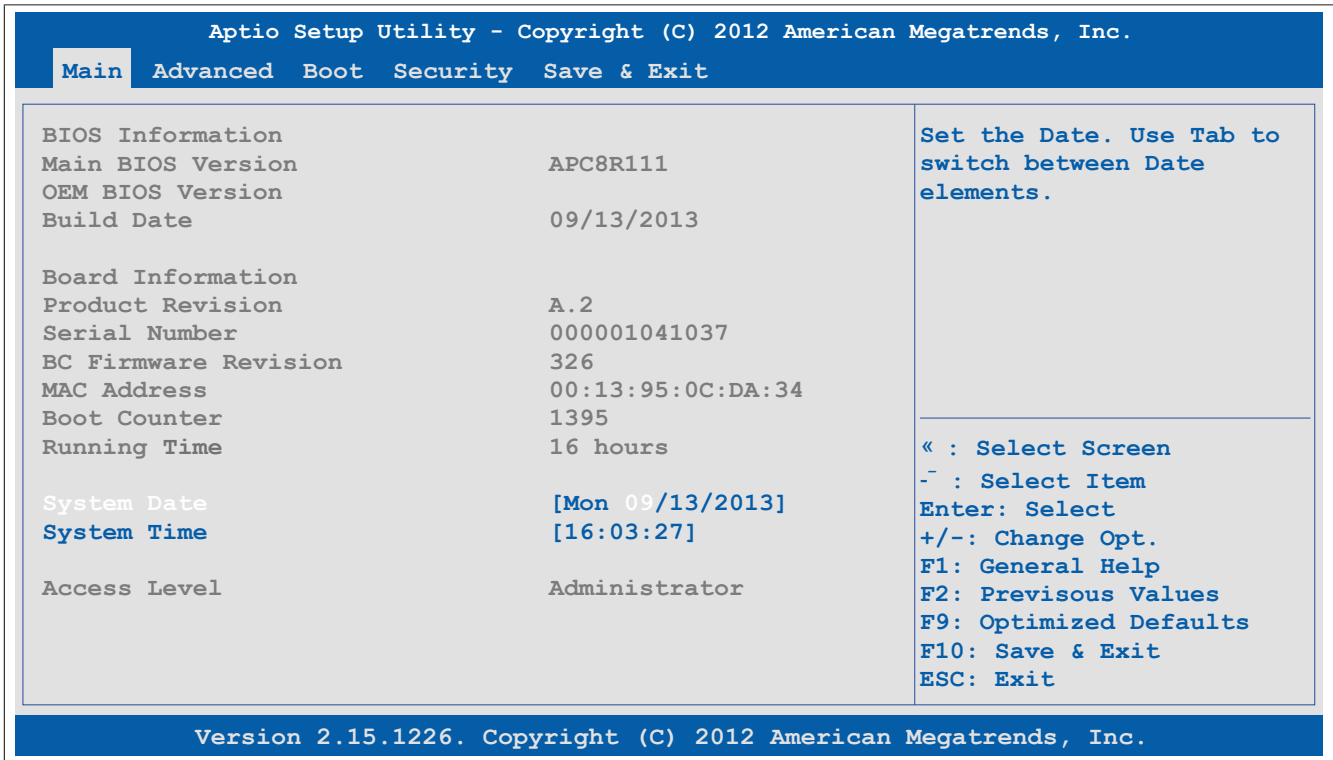

Figure 83: NM10 Main - Übersicht

BIOS setting	Function	Configuration options	Effect
BIOS information			
Main BIOS version	Displays the BIOS version	None	-
OEM BIOS version	Displays the OEM BIOS version	None	-
Build date	Displays the date the BIOS was created	None	-
Board information			
Product revision	Displays the hardware revision of the CPU board	None	-
Serial number	Displays the serial number of the CPU board	None	-
BC firmware rev.	Displays the firmware revision of the CPU board controller	None	-
ETH1 MAC address	Displays the assigned MAC address for the ETH1 interface	None	-
Boot counter	Displays the boot counter; each restart increases the counter by one (max. 16777215)	None	-
Running time	Displays the runtime in hours (max. 65535)	None	-
System date	The currently configured system date. This is buffered by the CMOS battery when the system is switched off.	Changes the system date	Sets the system date in the format Month:Day:Year (mm:dd:yyyy)
System time	The currently configured system time setting. This is buffered by the CMOS battery when the system is switched off.	Changes the system time	Sets the system time in the format Hour:Minute:Second (hh:mm:ss)
Access Level	Indicates the current access level	None	-

Table 113: NM10 Main - Configuration options

1.4 Advanced

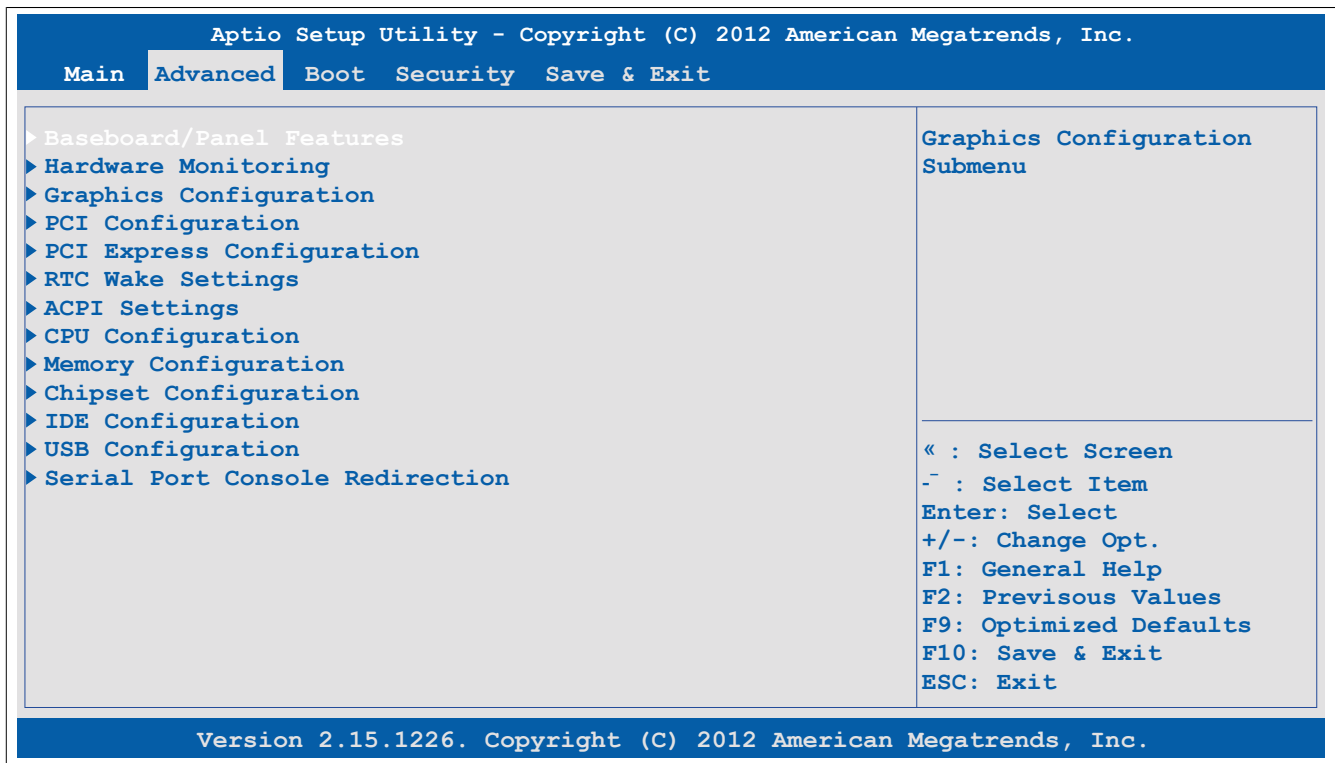

Figure 84: NM10 Advanced - Übersicht

BIOS setting	Function	Configuration options	Effect
Baseboard/Panel features	Configures mainboard and panel features	Enter	Opens the submenu See "Baseboard/Panel features" on page 161
Hardware monitoring	Displays the current voltage levels as well as the CPU and baseboard temperatures	Enter	Opens the submenu See "Hardware monitoring" on page 165
Graphics configuration	Configures graphics settings	Enter	Opens the submenu See "Graphics configuration" on page 160
PCI configuration	Configures PCI devices	Enter	Opens the submenu See "PCI configuration" on page 166
PCI Express configuration	Configures PCI Express devices	Enter	Opens the submenu See "PCI Express configuration" on page 168
RTC wake settings	Configures the start time when switched off	Enter	Opens the submenu See "RTC wake settings" on page 174
ACPI settings	Configures ACPI settings	Enter	Opens the submenu See "ACPI settings" on page 175
CPU configuration	Configures CPU settings	Enter	Opens the submenu See "CPU configuration" on page 176
Memory configuration	Configures main memory settings	Enter	Opens the submenu See "Memory configuration" on page 178
Chipset configuration	Configures chipset settings	Enter	Opens the submenu See "Chipset configuration" on page 179
IDE configuration	Configures IDE settings	Enter	Opens the submenu See "IDE configuration" on page 180
USB configuration	Configures USB settings	Enter	Opens the submenu See "USB configuration" on page 181
Serial port console redirection	Configures the remote console	Enter	Opens the submenu See "Serial port console redirection" on page 182

Table 114: NM10 Advanced - Overview

1.4.1 Graphics configuration

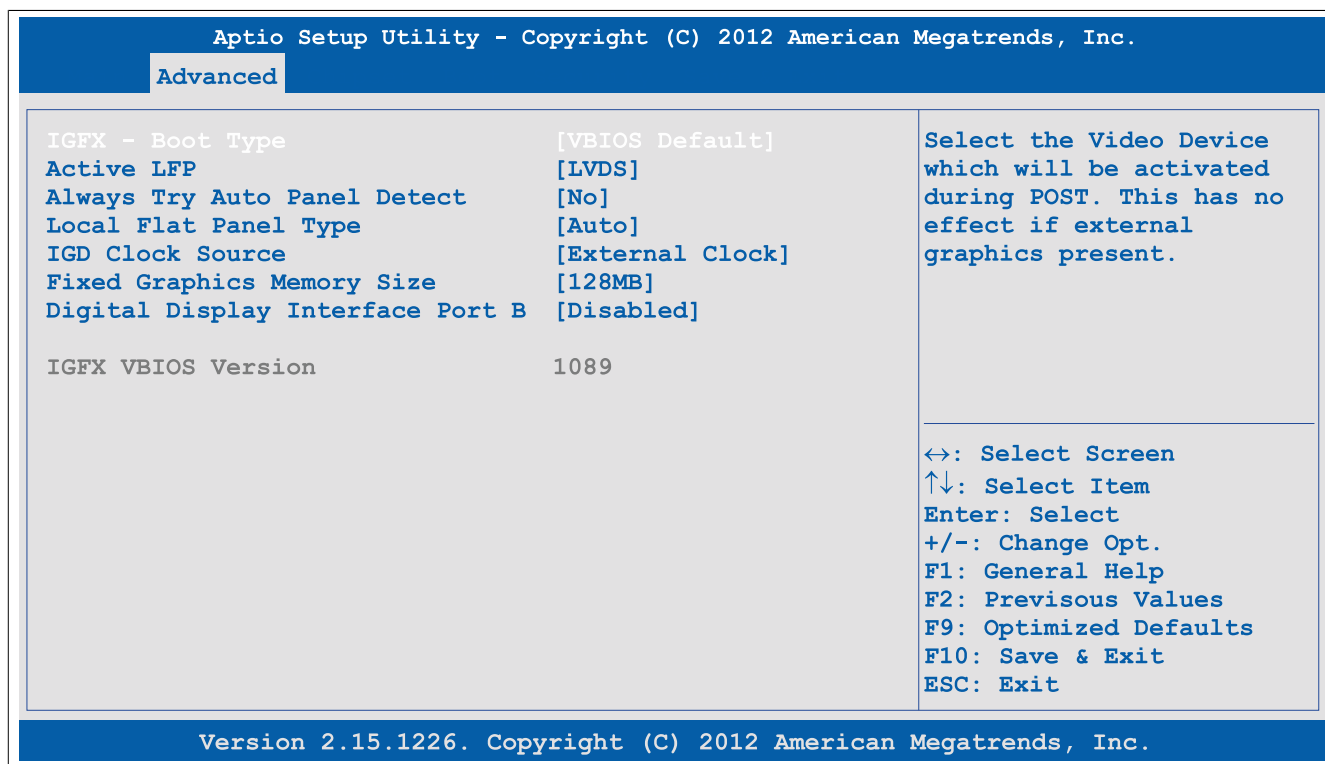

Figure 85: NM10 Advanced - Graphics Configuration

BIOS setting	Function	Configuration options	Effect
IGFX - Boot type	Option for selecting which display device handles graphics output during booting	VBIOS default	Uses VBIOS default settings
		CRT	Uses the CRT (cathode ray tube) channel
		LFP	Uses the LFP (local flat panel) channel
		EFP	Uses the EFP (external flat panel) channel
		CRT + LFP	Uses the CRT and LFP channels
		CRT + EFP	Uses the CRT and EFP channels
Active LFP	Option for selecting the active LFP (local flat panel) channel	No LVDS	Does not use the LVDS channel
		LVDS	Uses an LVDS channel
Always try auto panel detect ¹⁾	Option for configuring automatic panel detection	No	LFP not configured automatically
		Yes	LFP configured automatically
Local flat panel type ¹⁾	Option for manually setting the LFP type	Auto	Automatically defines the LFP type based on EDID data
		VGA (640 x 480) to WUXGA (1920 x 1200)	Manual setting of resolution from 640 x 480 to 1920 x 1200
		Customized EDID 1 - 3	User-specific settings for the LFP type
IGD clock source	Option for selecting the IGD (integrated graphics display) clock source	External clock	External clock
		Internal clock	Internal clock
Fixed graphics memory size	Option for setting a fixed amount of memory that can be used for the internal graphics controller	128 MB	Allocates 128 MB of main memory
		256 MB	Allocates 256 MB of main memory
Digital display interface port B	Option for selecting the display device that is connected to display port B or defining the port as an HDMI/DVI or display port	Disabled	No display device connected
		Display port	Configures the port as a display port
		HDMI/DVI	Configures the port as an HDMI/DVI port
IGFX VBIOS version	Displays the IGFX BIOS version	None	-

Table 115: NM10 Advanced - Graphics configuration - Configuration options

1) These settings are only possible if *Active LFP* is set to *LVDS*.

1.4.2 Baseboard/Panel features

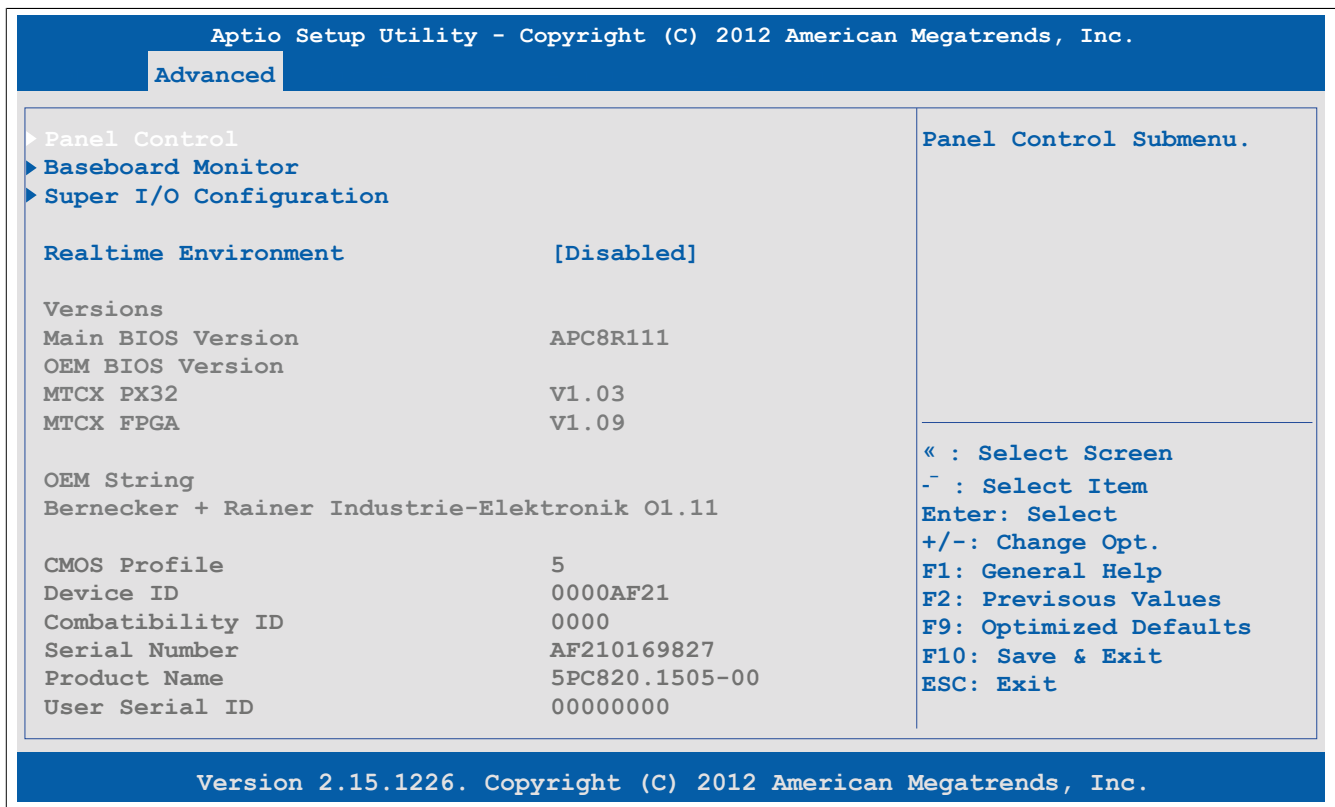

Figure 86: NM10 Advanced - Baseboard/Panel Features

BIOS setting	Function	Configuration options	Effect
Panel control	Displays device-specific information for the connected panel	Enter	Opens the submenu See "Panel control features" on page 162
Baseboard monitor	Displays device-specific information for the CPU board	Enter	Opens the submenu See "Baseboard monitor" on page 163
Super I/O configuration	Configures special interface settings	Enter	Opens the submenu See "Super I/O configuration" on page 164
Real-time environment	Configures settings for real-time operating systems such as ARwin	Disabled	Disables this function
		Enabled Disables hyperthreading, EIST and CPU thermal monitoring	Enables this function
Versions			
Main BIOS version	Displays the installed B&R BIOS version	None	-
OEM BIOS version	Displays the OEM BIOS version	None	-
MTCX PX32	Displays the installed MTCX PX32 version	None	-
MTCX FPGA	Displays the installed MTCX FPGA version	None	-
CMOS Profile	Displays the CMOS profile being used	None	-
Device ID	Displays the device ID of the system board	None	-
Compatibility ID	Displays the version of the device within the same B&R device ID. This ID is needed for Automation Runtime.	None	-
Serial number	Displays the B&R serial number	None	-
Product name	Displays the B&R model number	None	-
User serial ID	Displays the user serial ID. This 8-digit hexadecimal value can be freely specified by the user (e.g. to give the device a unique ID) and can only be changed using the "B&R Control Center" included with the ADI driver.	None	-

Table 116: NM10 Advanced - Baseboard/Panel features - Configuration options

1.4.2.1 Panel control features

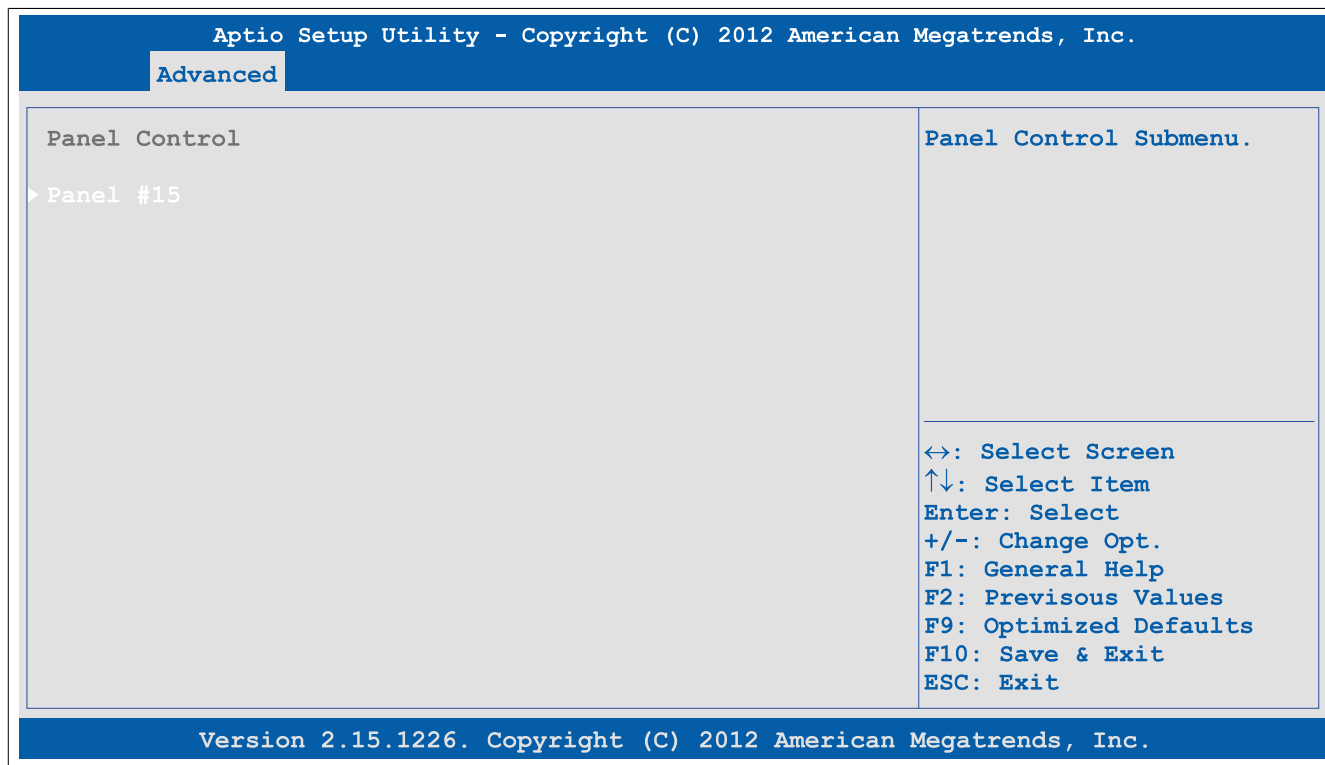

Figure 87: NM10 Advanced - Baseboard/Panel Features - Panel Control

BIOS setting	Function	Configuration options	Effect
Panel #X	Displays the panel properties of the connected panel	Enter	Opens the submenu See "Panel #X" on page 162

Table 117: NM10 Advanced - Baseboard/Panel features - Panel control - Configuration options

1.4.2.1.1 Panel #X

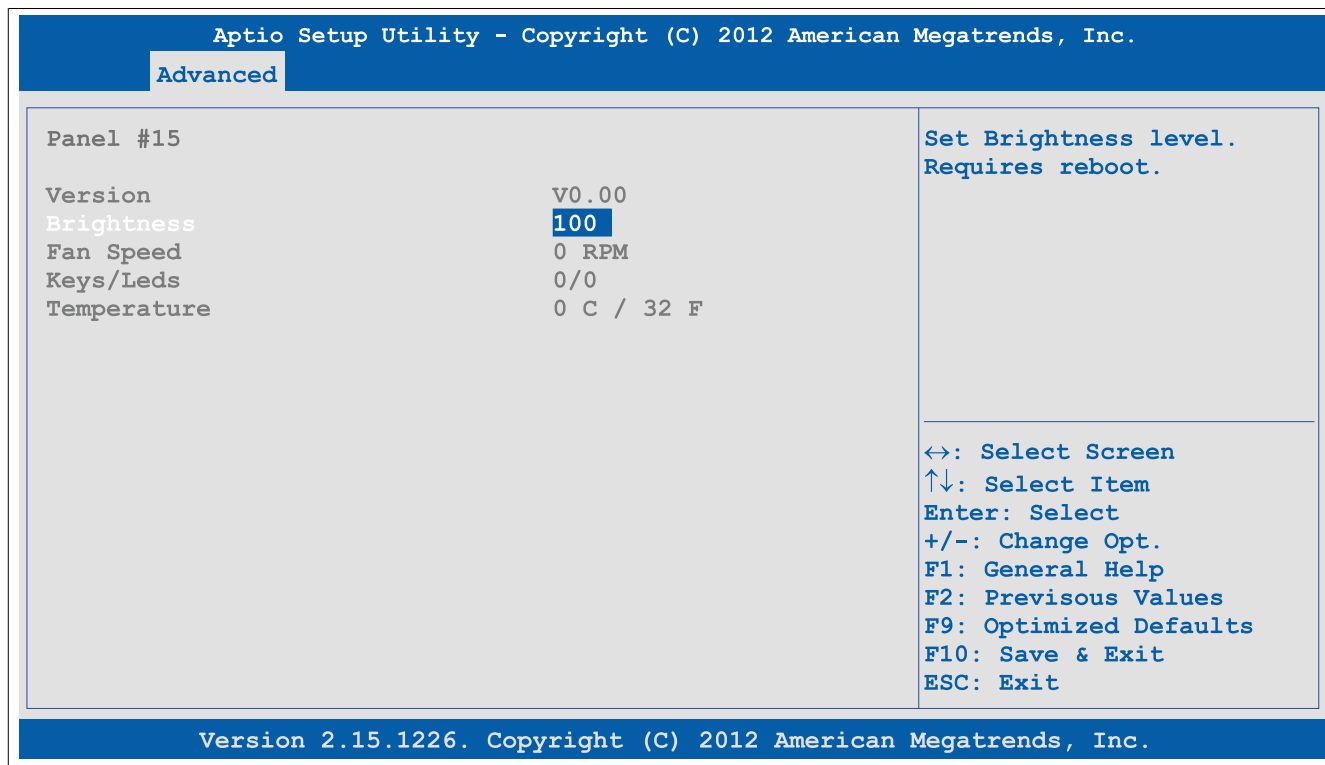

Figure 88: NM10 Advanced - Baseboard/Panel Features - Panel Control - Panel #x

BIOS setting	Function	Configuration options	Effect
Case 3	Displays the current fan speed of case 3 in rpm (revolutions per minute)	None	-
Case 4	Displays the current fan speed of case 4 in rpm (revolutions per minute)	None	-

Table 119: NM10 Advanced - Baseboard/Panel features - Baseboard monitor

1.4.2.3 Super I/O configuration

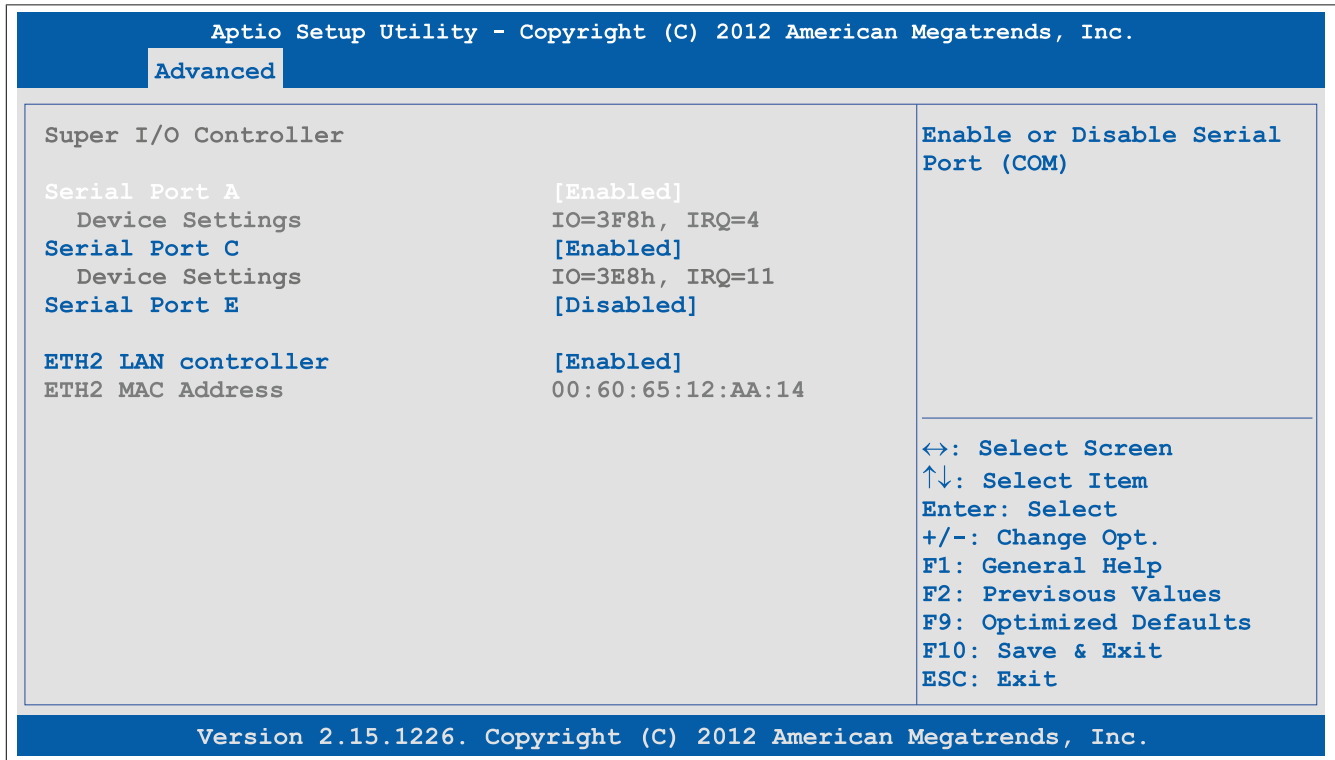

Figure 90: NM10 Advanced - Baseboard/Panel Features - Super I/O Configuration

BIOS setting	Function	Configuration options	Effect
Serial port A	Settings for the COM1 serial interface	Enabled	Enables the interface
		Disabled	Disables the interface
Device settings ¹⁾	Displays the I/O address and interrupt of the COM interface	None	-
Serial port C	Sets the COM port for the touch screen connected to the monitor/panel interface	Enabled	Enables the interface
		Disabled	Disables the interface
Device settings ²⁾	Displays the I/O address and interrupt of the COM interface	None	-
Serial port E	Sets the COM port of the 5AC600.485I-00 B&R add-on interface	Enabled	Enables the interface
		Disabled	Disables the interface
Device settings ³⁾	Displays the I/O address and interrupt of the COM interface ⁴⁾	None	-
ETH2 LAN Controller	Enables/Disables the onboard Ethernet LAN2 controller	Disabled	Disables the ETH2 controller
		Enabled	Enables the ETH2 controller
ETH2 MAC address	Displays the MAC addresses for the Ethernet2 controller	None	-

Table 120: NM10 Advanced - Baseboard/Panel features - Super I/O configuration - Configuration options

- 1) This setting is only available if *Serial port A* is set to *Enabled*.
- 2) This setting is only available if *Serial port C* is set to *Enabled*.
- 3) This setting is only available if *Serial port E* is set to *Enabled*.
- 4) Only displayed after the system has been restarted.

1.4.3 Hardware monitoring

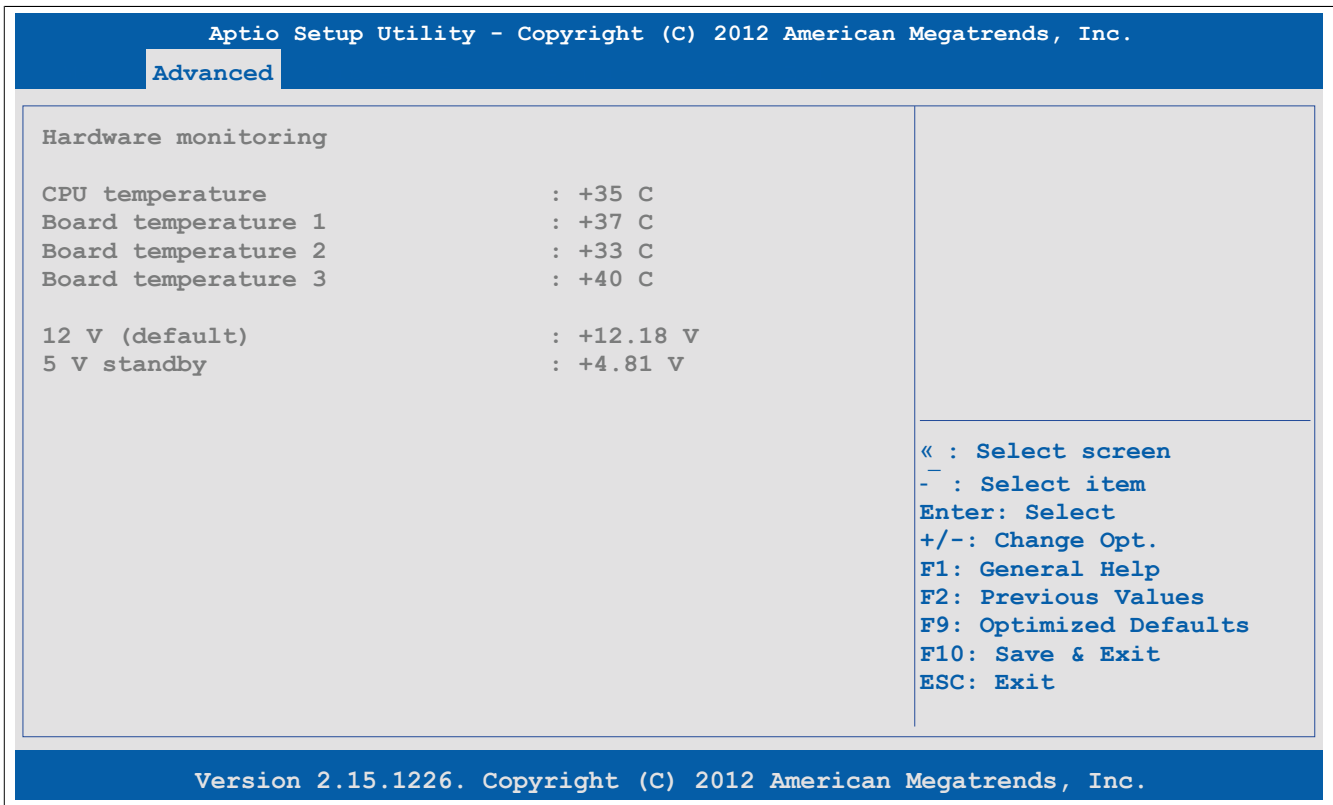

Figure 91: NM10 Advanced - Hardware monitoring

BIOS setting	Function	Configuration options	Effect
Hardware monitoring			
CPU temperature	Displays the current temperature of the CPU sensor in °C	None	-
Board temperature 1	Displays the current temperature of board sensor 1 in °C	None	-
Board temperature 2	Displays the current temperature of board sensor 2 in °C	None	-
Board temperature 2	Displays the current temperature of board sensor 3 in °C	None	-
12 V (default)	Displays the current voltage of the 12 volt supply	None	-
5 V standby	Displays the current voltage of the 5 volt supply	None	-

Table 121: NM10 Advanced - Baseboard/Panel features - Baseboard monitor

1.4.4 PCI configuration

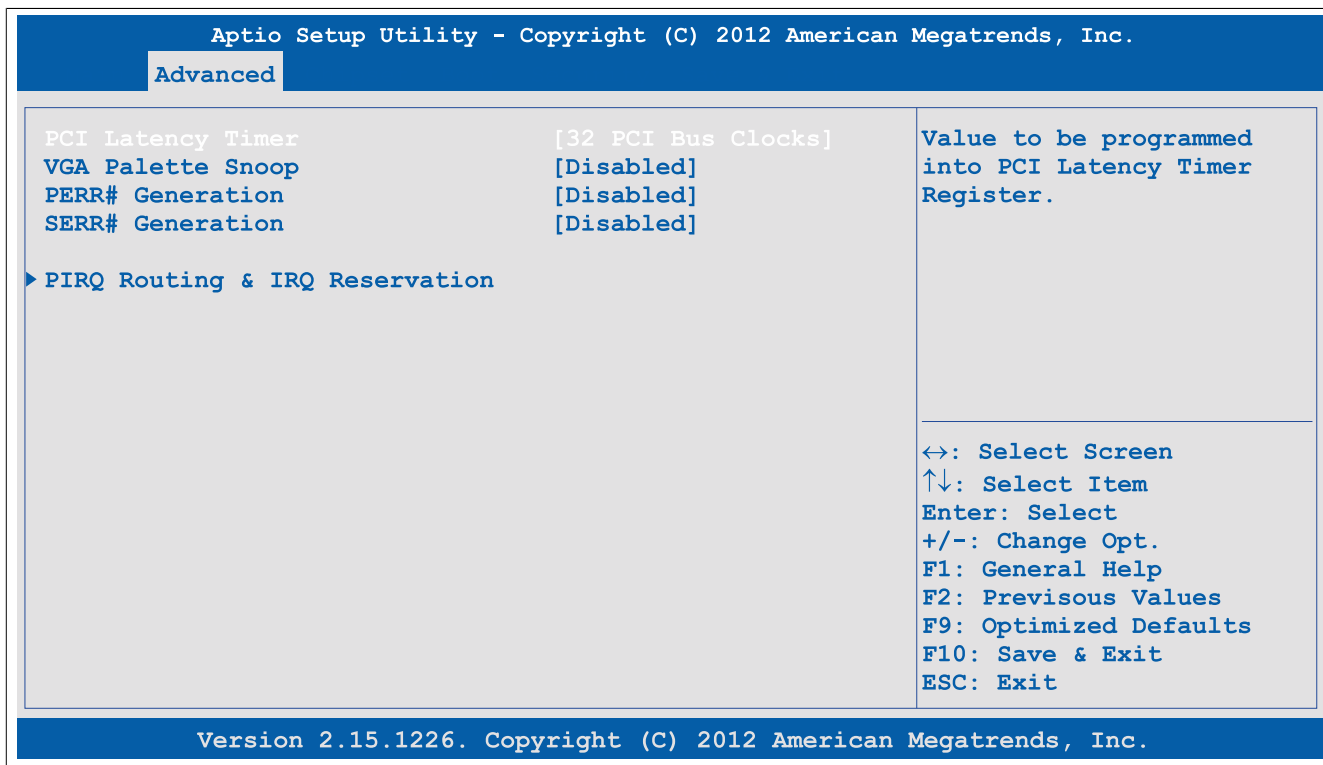

Figure 92: NM10 Advanced - PCI Configuration

BIOS setting	Function	Configuration options	Effect
PCI latency timer	Option for controlling how long (in PCI ticks) one PCI bus card can continue to use the master after another PCI card has requested access	32 PCI bus clocks to 248 PCI bus clocks	Manually sets the value in PCI ticks
VGA palette snoop	Option for supporting graphics cards with 256 colors. This option should only be set to "Enabled" if colors are not displayed correctly.	Disabled	Disables this function
		Enabled	Enables this function
PERR# generation	Option for generating a PERR signal (parity error). This signal indicates a data parity error one cycle after <i>PAR</i> .	Disabled	Disables this function
		Enabled	Enables this function
SERR# generation	Option for generating a SERR signal (system error). This signal indicates a data error or other type of system error when executing a special cycle command.	Disabled	Disables this function
		Enabled	Enables this function
PIRQ routing & IRQ reservation	Configures PIRQ routing	Enter	Opens the submenu See "PIRQ routing & IRQ reservation" on page 167

Table 122: NM10 Advanced - PCI configuration - Configuration options

1.4.4.1 PIRQ routing & IRQ reservation

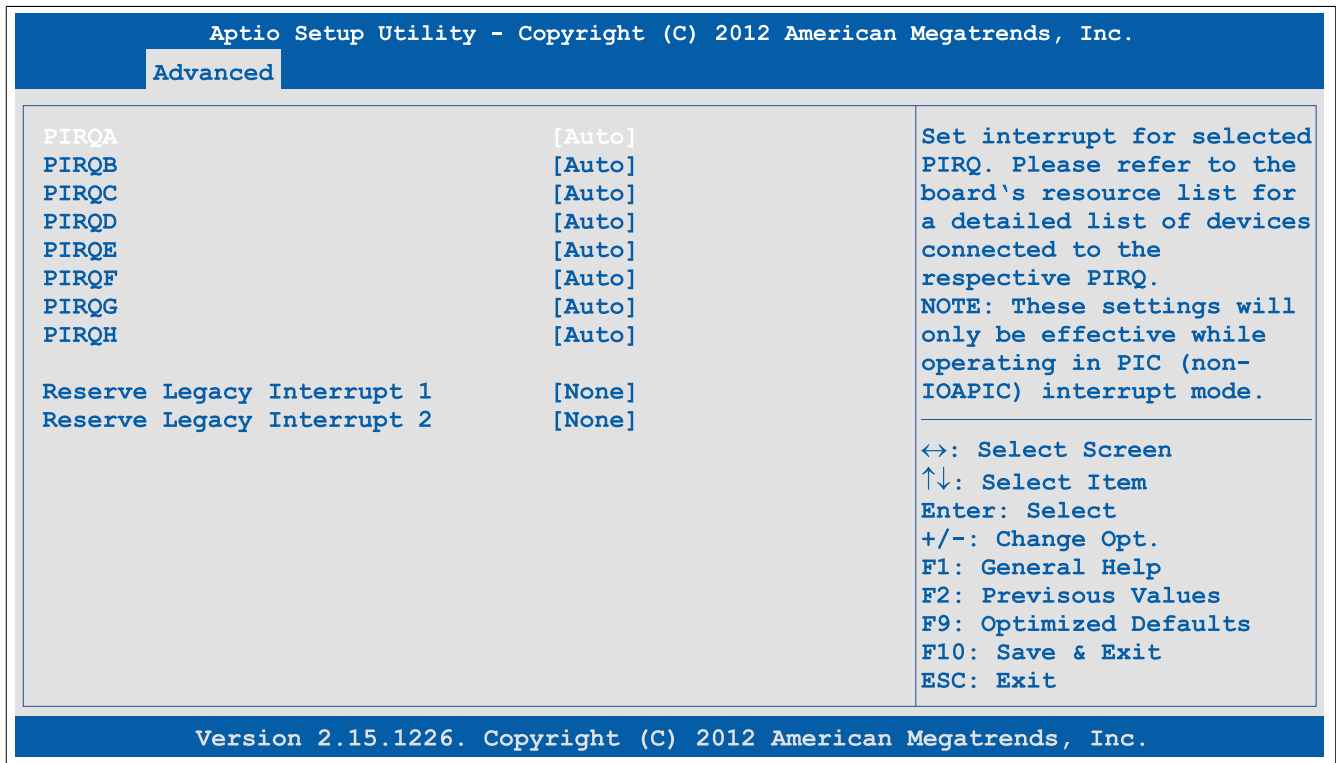

Figure 93: NM10 Advanced - PCI Configuration - PIRQ Routing & IRQ Reservation

BIOS setting	Function	Configuration options	Effect
PIRQA	Option for configuring PIRQ A	Auto	Automatic assignment by BIOS and the operating system
		IRQ3, IRQ4, IRQ5, IRQ6, IRQ10, IRQ11, IRQ14, IRQ15	Manual assignment
PIRQB	Option for configuring PIRQ B	Auto	Automatic assignment by BIOS and the operating system
		IRQ3, IRQ4, IRQ5, IRQ6, IRQ10, IRQ11, IRQ14, IRQ15	Manual assignment
PIRQC	Option for configuring PIRQ C	Auto	Automatic assignment by BIOS and the operating system
		IRQ3, IRQ4, IRQ5, IRQ6, IRQ10, IRQ11, IRQ14, IRQ15	Manual assignment
PIRQD	Option for configuring PIRQ D	Auto	Automatic assignment by BIOS and the operating system
		IRQ3, IRQ4, IRQ5, IRQ6, IRQ10, IRQ11, IRQ14, IRQ15	Manual assignment
PIRQE	Option for configuring PIRQ E	Auto	Automatic assignment by BIOS and the operating system
		IRQ3, IRQ4, IRQ5, IRQ6, IRQ10, IRQ11, IRQ14, IRQ15	Manual assignment
PIRQF	Option for configuring PIRQ F	Auto	Automatic assignment by BIOS and the operating system
		IRQ3, IRQ4, IRQ5, IRQ6, IRQ10, IRQ11, IRQ14, IRQ15	Manual assignment
PIRQG	Option for configuring PIRQ G	Auto	Automatic assignment by BIOS and the operating system
		IRQ3, IRQ4, IRQ5, IRQ6, IRQ10, IRQ11, IRQ14, IRQ15	Manual assignment
PIRQH	Option for configuring PIRQ H	Auto	Automatic assignment by BIOS and the operating system
		IRQ3, IRQ4, IRQ5, IRQ6, IRQ10, IRQ11, IRQ14, IRQ15	Manual assignment
Reserve legacy interrupt 1	Prevents the interrupt reserved here from being made available to a PCI or PCI Express device	None	No interrupt assigned
		IRQ3, IRQ4, IRQ5, IRQ6, IRQ10, IRQ11, IRQ14, IRQ15	Reserves IRQx
Reserve legacy interrupt 2	Prevents the interrupt reserved here from being made available to a PCI or PCI Express device	None	No interrupt assigned
		IRQ3, IRQ4, IRQ5, IRQ6, IRQ10, IRQ11, IRQ14, IRQ15	Reserves IRQx

Table 123: NM10 Advanced - PCI configuration - PIRQ routing & IRQ reservation - Configuration options

1.4.5 PCI Express configuration

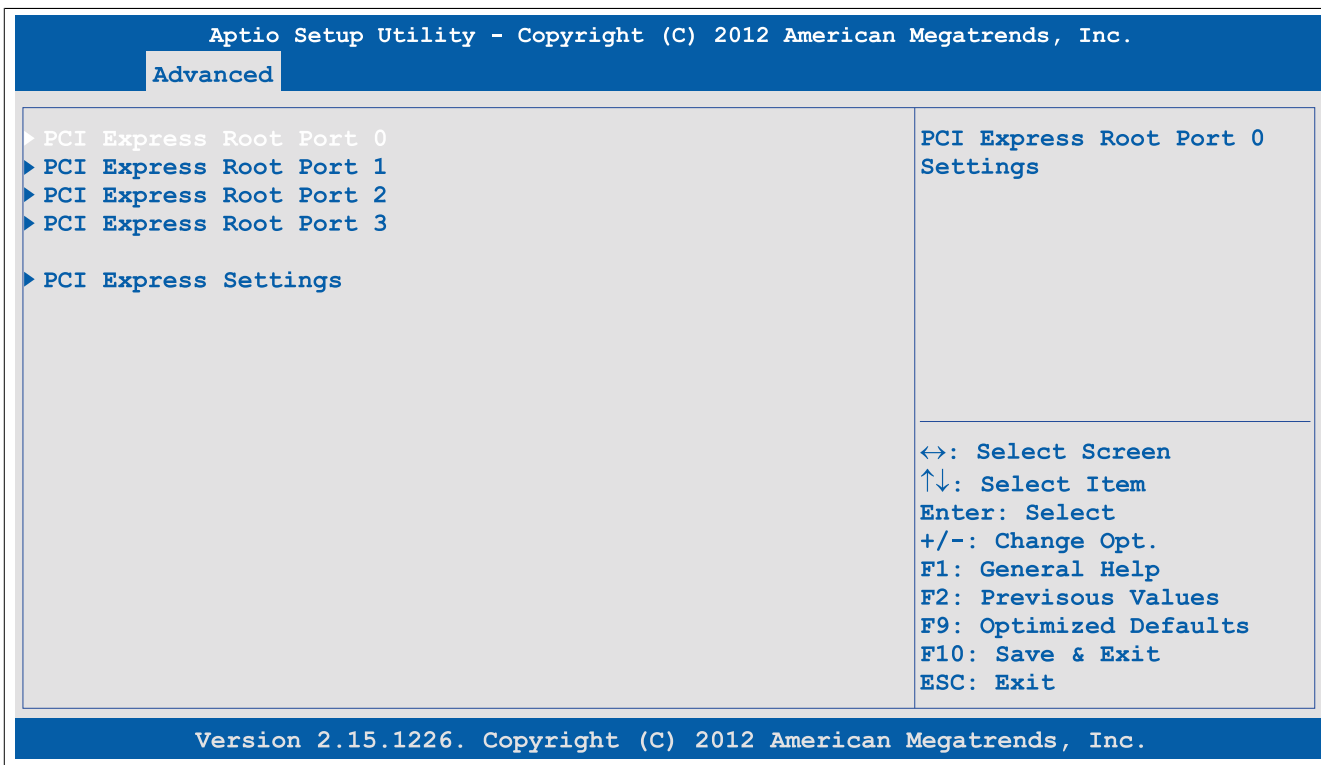

Figure 94: NM10 Advanced - PCI Express Configuration

BIOS setting	Function	Configuration options	Effect
PCI Express root port 0	Configures PCI Express settings on port 0	Enter	Opens the submenu See "PCI Express root port 0" on page 169
PCI Express root port 1	Configures PCI Express settings on port 1	Enter	Opens the submenu See "PCI Express root port x" on page 171
PCI Express root port 2	Configures PCI Express settings on port 2	Enter	Opens the submenu See "PCI Express root port x" on page 171
PCI Express root port 3	Configures PCI Express settings on port 3	Enter	Opens the submenu See "PCI Express root port x" on page 171
PCI Express settings	Configures PCI Express settings	Enter	Opens the submenu See "PCI Express settings" on page 173

Table 124: NM10 Advanced - PCI Express configuration - Overview

1.4.5.1 PCI Express root port 0

Warning!

Improper settings can cause instability or device problems. It is therefore strongly recommended that these settings only be changed by experienced users.

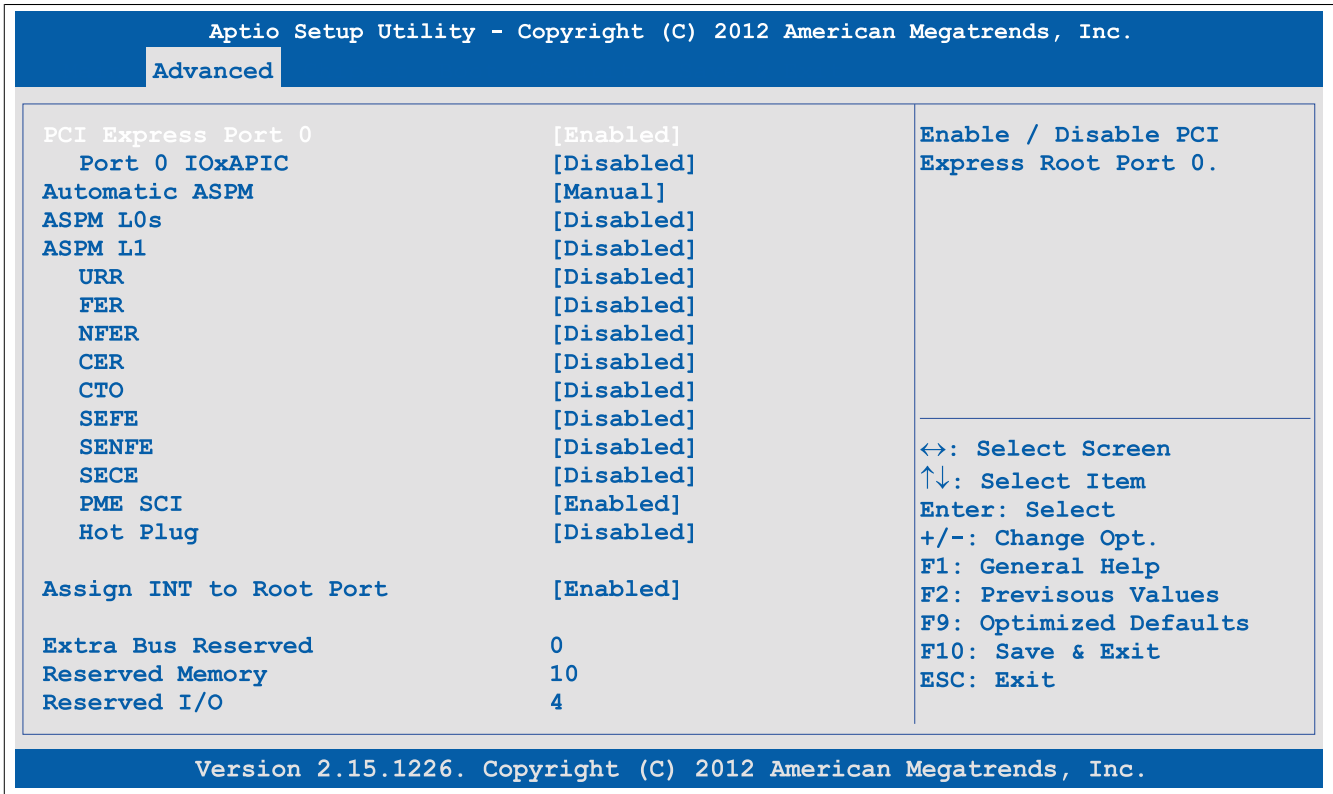

Figure 95: NM10 Advanced - PCI Express Configuration - PCI Express Root Port 0

BIOS setting	Function	Configuration options	Effect
PCI Express port 0	Option for enabling/disabling PCI Express root port 0	Disabled	Disables PCI Express root port 0
		Enabled	Enables PCI Express root port 0
Port 0 IOxAPIC	Option for enabling/disabling PCI Express root port 0 I/O APIC	Disabled	Disables PCI Express root port 0 I/O APIC
		Enabled	Enables PCI Express root port 0 I/O APIC
Automatic ASPM	<i>Active state power management</i> Option for configuring an automatic or manual power saving function (L0s/L1) for PCIe link cards if they do not require full power	Manual	Manual setting of energy saving functions L0s and L1
		Auto	Automatic assignment by BIOS and the operating system
ASPM L0s ¹⁾	Enables/Disables the L0 energy saving function	Disabled	Disables this function
		Root port only	Function only available for the root port
		Endpoint port only	Function only available for the end device port
		Both root and endpoint ports	Function available for the root and end device port
ASPM L1 ¹⁾	Enables/Disables the L1 energy saving function. Power consumption is lower than with L0, but the exit latency is higher.	Disabled	Disables the L1 energy saving function
		Enabled	Enables the L1 energy saving function
URR	<i>Unsupported Request (UR) reporting</i> Option for reporting unsupported requests. Logging of error messages received by the root port is controlled exclusively by the root control register.	Disabled	Disables this function
		Enabled	Enables this function
FER	<i>Fatal error reporting</i> Option for reporting fatal errors. All of the functions of a multifunction device will be monitored. The report for the root port takes place internally inside the root complex.	Disabled	Disables this function
		Enabled	Enables this function
NFER	<i>Non-fatal error reporting</i> Option for reporting non-fatal errors. All of the functions of a multifunction device will be monitored. The report for the root port takes place internally inside the root complex.	Disabled	Disables this function
		Enabled	Enables this function
CER	<i>Correctable error reporting</i>	Disabled	Disables this function

Table 125: NM10 Advanced - PCI Express configuration - PCI Express root port 0 - Configuration options

BIOS setting	Function	Configuration options	Effect
	Option for reporting correctable errors. All of the functions of a multifunction device will be monitored. The report for the root port takes place internally inside the root complex.	Enabled	Enables this function
CT0	<i>PCI Express completion timer T0</i> Option for enabling/disabling the PCI Express completion timer Information: This setting should be set to "Enabled" if the system detected an ROB (processor reorder buffer) timeout.	Disabled	Disables this function
		Enabled	Enables this function
SEFE	<i>System error on fatal error</i> Option for generating a system error if a fatal error is registered by a device on the root port or by the root port itself	Disabled	Disables this function
		Enabled	Enables this function
SENF	<i>System error on non-fatal error</i> Option for generating a system error if a non-fatal error is registered by a device on the root port or by the root port itself	Disabled	Disables this function
		Enabled	Enables this function
SECE	<i>System error on correctable error</i> Option for generating a system error if a correctable error is registered by a device on the root port or by the root port itself	Disabled	Disables this function
		Enabled	Enables this function
PME SCI	Option for generating an SCI if power management is detected	Disabled	Disables this function
		Enabled	Enables this function Enables the root port to generate an SCI if power management is detected
Hot plug	Option for enabling/disabling hot plugging in order to replace components during operation	Disabled	Disables this function
		Enabled	Enables this function
Assign INT to root port	Option for enabling/disabling the IRQ for the root port	Disabled	Disables this function
		Enabled	Enables this function
Extra bus reserved	Option for reserving the extra bus to bridges behind this root bridge	0 to 7	Sets the corresponding bus
Reserved memory	Option for configuring reserved memory for this root bridge	1 to 20	Sets the size of reserved memory between 1 MB and 20 MB
Reserved I/O	Option for configuring a reserved I/O range (4K/8K/12K/16K/20K) for this root bridge	4 to 20	Sets the size of the reserved I/O area between 4 K and 20 K

Table 125: NM10 Advanced - PCI Express configuration - PCI Express root port 0 - Configuration options

1) This setting is only available if *Automatic ASPM* is set to *Manual*.

1.4.5.2 PCI Express root port x

Warning!

Improper settings can cause instability or device problems. It is therefore strongly recommended that these settings only be changed by experienced users.

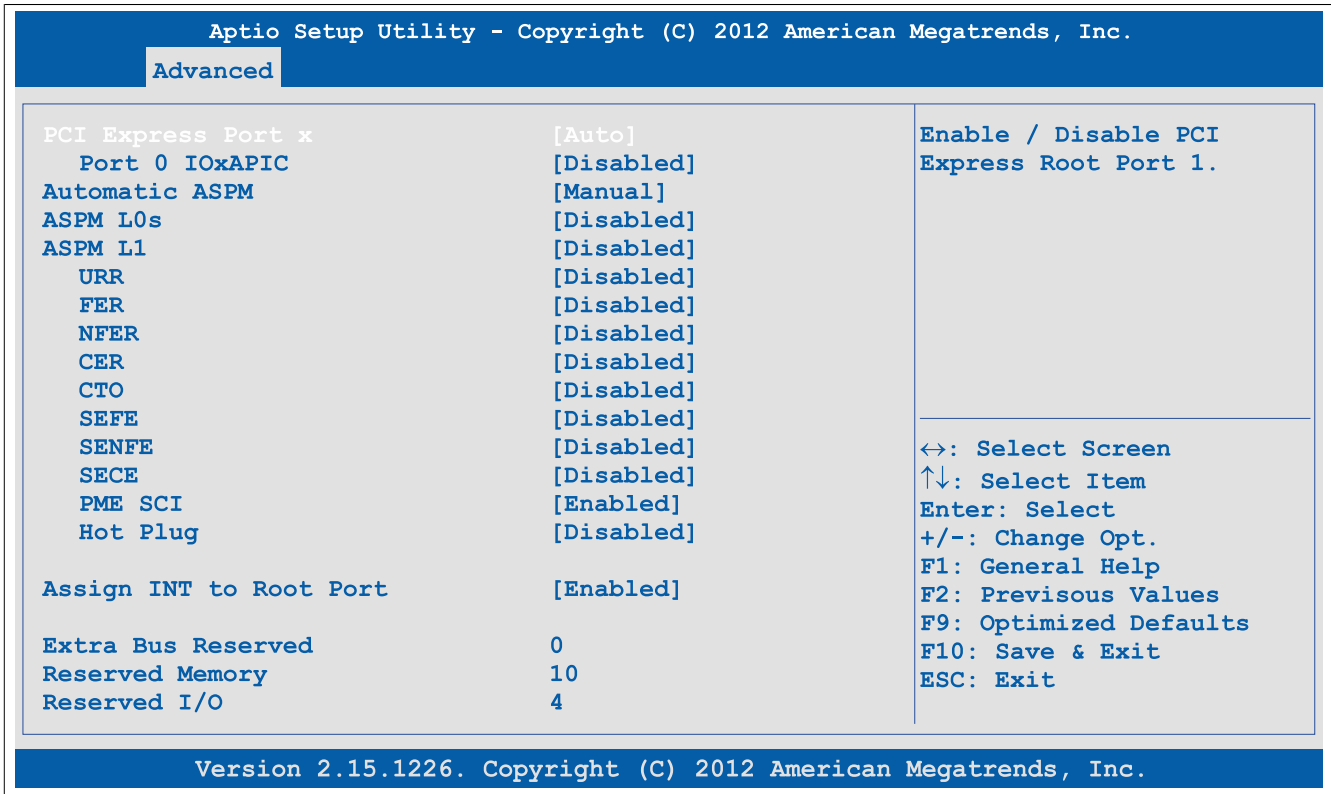

Figure 96: NM10 Advanced - PCI Express Configuration - PCI Express Root Port x

BIOS setting	Function	Configuration options	Effect
PCI Express root port x	Option for enabling/disabling the PCI Express root port	Disabled	Disables PCI Express root port x
		Enabled	Enables PCI Express root port x
		Auto	Automatically enables/disables PCI Express root port x
Port 0 IOxAPIC	Option for enabling/disabling PCI Express root port 0 I/O APIC	Disabled	Disables PCI Express root port 0 I/O APIC
		Enabled	Enables PCI Express root port 0 I/O APIC
Automatic ASPM	<i>Active state power management</i> Option for configuring an automatic or manual power saving function (L0s/L1) for PCIe link cards if they do not require full power	Manual	Manual setting of energy saving functions L0s and L1
ASPM L0s	Enables/Disables the L0 energy saving function	Auto	Automatic assignment by BIOS and the operating system
		Disabled	Disables this function
		Root port only	Function only available for the root port
		Endpoint port only	Function only available for the end device port
ASPM L1	Enables/Disables the L1 energy saving function. Power consumption is lower than with L0, but the exit latency is higher.	Both root and endpoint ports	Function available for the root and end device port
		Disabled	Disables the L1 energy saving function
		Enabled	Enables the L1 energy saving function
URR	<i>Unsupported Request (UR) reporting</i> Option for reporting unsupported requests. Logging of error messages received by the root port is controlled exclusively by the root control register.	Disabled	Disables this function
		Enabled	Enables this function
FER	<i>Fatal error reporting</i> Option for reporting fatal errors. All of the functions of a multifunction device will be monitored. The report for the root port takes place internally inside the root complex.	Disabled	Disables this function
		Enabled	Enables this function
NFER	<i>Non-fatal error reporting</i> Option for reporting non-fatal errors. All of the functions of a multifunction device will be monitored. The report for the root port takes place internally inside the root complex.	Disabled	Disables this function
		Enabled	Enables this function
CER	<i>Correctable error reporting</i>	Disabled	Disables this function

Table 126: NM10 Advanced - PCI Express configuration - PCI Express root port x - Configuration options

BIOS setting	Function	Configuration options	Effect
	Option for reporting correctable errors. All of the functions of a multifunction device will be monitored. The report for the root port takes place internally inside the root complex.	Enabled	Enables this function
CT0	<i>PCI Express completion timer T0</i> Option for enabling/disabling the PCI Express completion timer Information: This setting should be set to "Enabled" if the system detected an ROB (processor reorder buffer) timeout.	Disabled	Disables this function
		Enabled	Enables this function
SEFE	<i>System error on fatal error</i> Option for generating a system error if a fatal error is registered by a device on the root port or by the root port itself	Disabled	Disables this function
		Enabled	Enables this function
SENF	<i>System error on non-fatal error</i> Option for generating a system error if a non-fatal error is registered by a device on the root port or by the root port itself	Disabled	Disables this function
		Enabled	Enables this function
SECE	<i>System error on correctable error</i> Option for generating a system error if a correctable error is registered by a device on the root port or by the root port itself	Disabled	Disables this function
		Enabled	Enables this function
PME SCI	Option for generating an SCI if power management is detected	Disabled	Disables this function
		Enabled	Enables this function Enables the root port to generate an SCI if power management is detected
Hot plug	Option for enabling/disabling hot plugging in order to replace components during operation	Disabled	Disables this function
		Enabled	Enables this function
Assign INT to root port	Option for enabling/disabling the IRQ for the root port	Disabled	Disables this function
		Enabled	Enables this function
Extra bus reserved	Option for reserving the extra bus to bridges behind this root bridge	0 to 7	Sets the corresponding bus
Reserved memory	Option for configuring reserved memory for this root bridge	1 to 20	Sets the size of reserved memory between 1 MB and 20 MB
Reserved I/O	Option for configuring a reserved I/O range (4K/8K/12K/16K/20K) for this root bridge	4 to 20	Sets the size of the reserved I/O area between 4 K and 20 K

Table 126: NM10 Advanced - PCI Express configuration - PCI Express root port x - Configuration options

1) This setting is only available if *Automatic ASPM* is set to *Manual*.

1.4.5.3 PCI Express settings

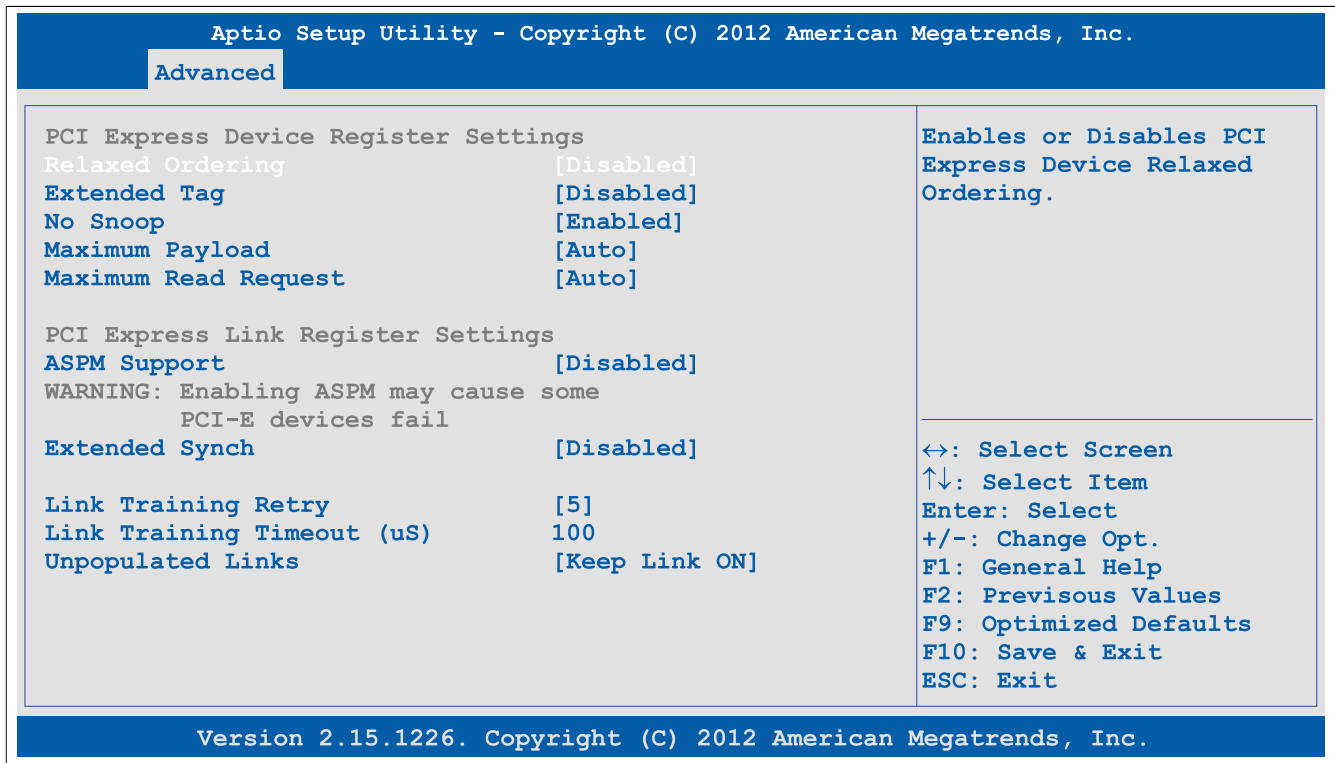

Figure 97: NM10 Advanced - PCI Express Configuration - PCI Express Settings

BIOS setting	Function	Configuration options	Effect
Relaxed ordering	Option for enabling/disabling relaxed ordering	Disabled	Disables this function
		Enabled	Enables this function
Extended tag	Option for enabling/disabling the extended tag	Disabled	Disables this function Only 5 bits can be used.
		Enabled	Enables this function Devices with 8 bits in the requester transaction ID field can be used.
No snoop	Option for enabling/disabling the "No snoop" option	Disabled	Disables this function
		Enabled	Enables this function
Maximum payload	Option for setting the maximum surface packet size for data transfers	Auto	Automatically assigns the packet size
		128 bytes to 4096 bytes	Manual maps the packet size
Maximum read request	Option for setting the maximum read request	Auto	Automatic assignment
		128 bytes to 4096 bytes	Manual assignment
ASPM support ¹⁾	Option for configuring a power saving function (L0s/L1) for PCIe slots if they do not require full power	Disabled	Disables the energy saving function
		Auto	Maximum energy savings. The energy saving function is set to L0 or L1.
		Force L0s	Enables L0 mode
Extended synch	Option for setting an extended synchronization pattern to improve system performance	Disabled	Disables this function
		Enabled	Enables this function
Link training retry	Option for defining the number of times the software should attempt to reroute a link if the previous training attempt was unsuccessful	Disabled	Disables this function
		2	2 link training attempts
		3	3 link training attempts
		5	5 link training attempts
Link training timeout (µS)	Option for defining how many microseconds the software waits before the link training bit in the link status register is queried	10 to 1000	Time setting in µs
Unpopulated links	Option for enabling/disabling PCIe slots where no devices are connected	Keep link on	Keeps PCIe slots where no devices are connected enabled
		Disable link	Disables PCIe slots where no devices are connected to save power

Table 127: NM10 Advanced - PCI Express configuration - PCI Express settings - Configuration options

1) ASPM = Active state power management.

1.4.6 RTC wake settings

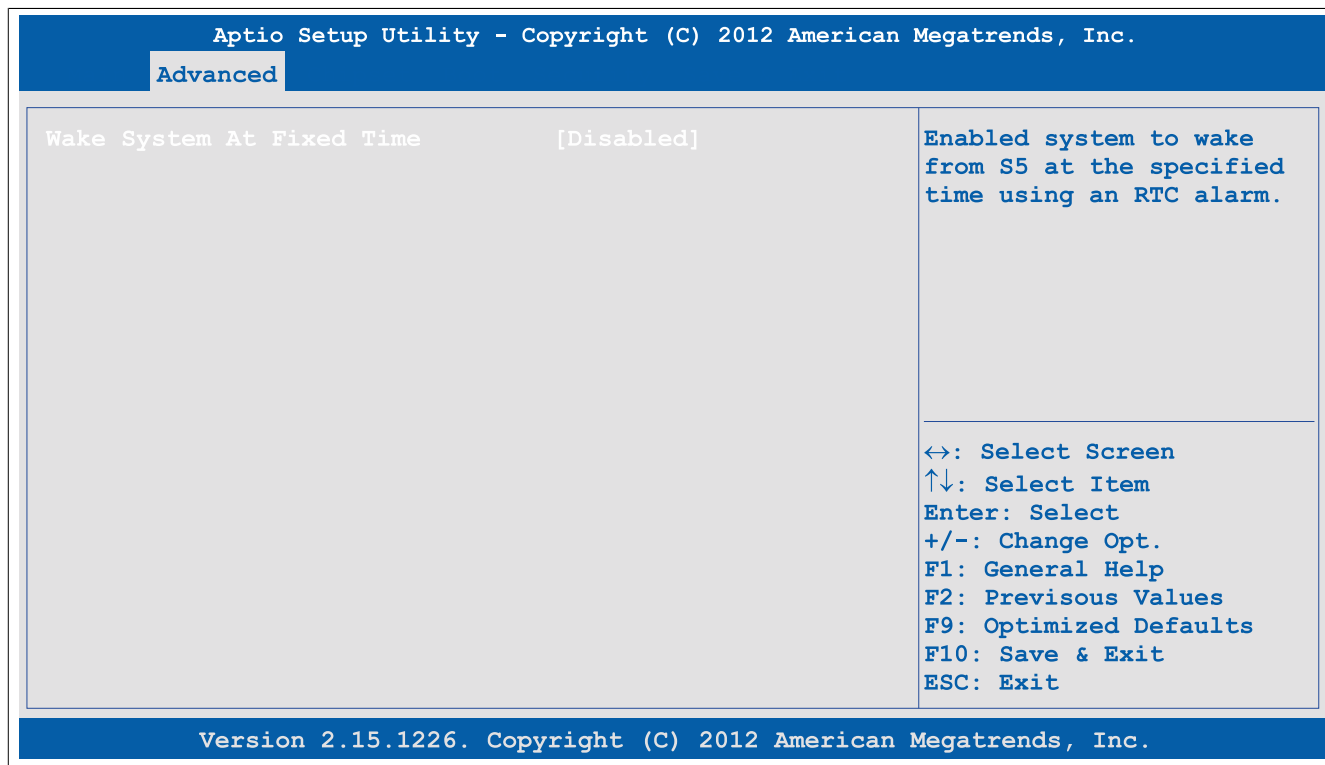

Figure 98: NM10 Advanced - RTC Wake Settings

BIOS setting	Function	Configuration options	Effect
Wake system at fixed time	Option for setting the time (to the second) when the system should boot from a switched-off state (ACPI S5)	Disabled	Disables this function
		Enabled	Enables this function
Wake up hour ¹⁾	Option for setting the hour	0 to 23	Example: If set to 3, the system will start up at 3 AM. If set to 15, the system will start up at 3 PM.
Wake up minute ¹⁾	Option for setting the minute	0 to 59	Example: If set to 15, the system will start up at minute 15.
Wake up second ¹⁾	Option for setting the second	0 to 59	Example: If set to 32, the system will start up at second 32.

Table 128: NM10 Advanced - RTC wake settings - Configuration options

1) This setting is only available if *Wake system At fixed time* is set to *Enabled*.

1.4.7 ACPI settings

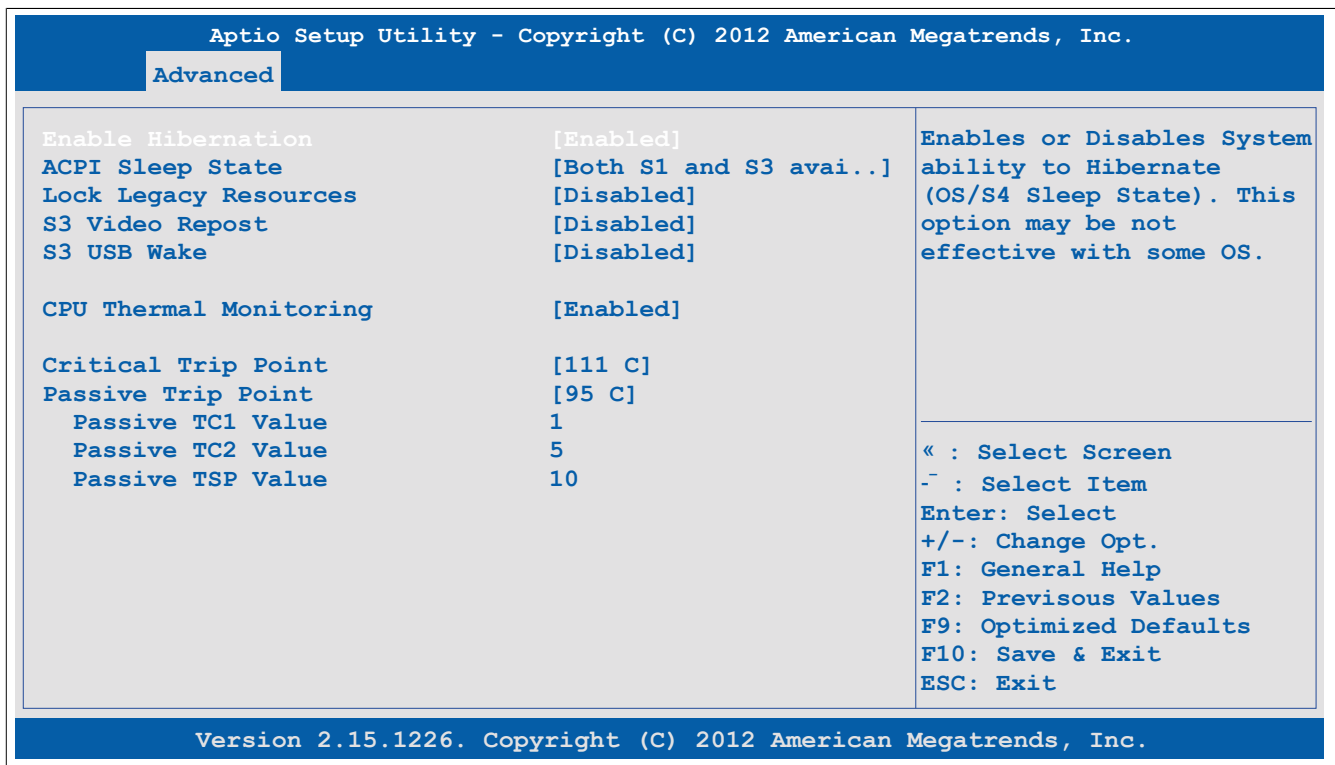

Figure 99: NM10 Advanced - ACPI Settings

BIOS setting	Function	Configuration options	Effect
Enable hibernation	Option for enabling/disabling the hibernate function. This can put the operating system into the S4 state. This option may not have any effect on some operating systems.	Disabled	Disables this function
		Enabled	Enables this function
ACPI sleep state	Selects the ACPI status to be used when Suspend mode is enabled	Suspend disabled	Disables this function
		S1 only (CPU stop clock)	Sets S1 as Suspend mode. Only a few functions are disabled and are available again at the touch of a button.
		S3 only (Suspend to RAM)	Sets S3 as Suspend mode. The current state of the operating system is written to RAM, which is then the only component to receive power.
Lock legacy resources	Option for configuring whether the operating system is permitted to configure legacy resources	Disabled	Disables this function
		Enabled	Enables this function
S3 video repost	Option for determining whether graphic POST should be executed again after starting from status S3	Disabled	Disables this function
		Enabled	Enables this function
S3 USB wake	Option for configuring whether connected USB devices can generate ACPI events	Disabled	Disables this function
		Enabled	Enables this function
CPU thermal monitoring ¹⁾	Option for enabling/disabling CPU thermal monitoring	Enabled	Enables CPU thermal monitoring, displays temperature values in SCPI and generates SMI
		Disabled	Disables CPU thermal monitoring. Disabled is recommended for real-time applications.
Critical trip point	Option for configuring a CPU temperature at which the operating system automatically shuts down	POR	Sets the critical trip point to 100°C
		79 C, 87 C, 95 C, 103 C, 111 C, 119 C, 127 C	Temperature setting for the critical trip point. Configurable in increments of 8°C.
Passive trip point	Option for configuring an ACPI passive trip point temperature at which the operating system throttles the CPU speed	Disabled	Disables this function
		71 C, 79 C, 87 C, 95 C	Temperature setting for the passive trip point in °C
Passive TC1 value	Option for setting the TC1 value for the ACPI passive cooling formula	1 to 16	Sets the TC1 value
Passive TC2 value	Option for setting the TC2 value for the ACPI passive cooling formula	1 to 16	Sets the TC2 value

Table 129: NM10 Advanced - ACPI settings - Configuration options

BIOS setting	Function	Configuration options	Effect
Passive TSP value	Option for setting the TSP value for the ACPI passive cooling formula The TSP value specifies how often the operating system reads the temperature in a tenth of a second.	2 to 32	Sets the TSP value

Table 129: NM10 Advanced - ACPI settings - Configuration options

1) This setting is only available if *Advanced - Baseboard/Panel features - Realtime environment* is set to *Disabled*.

1.4.8 CPU configuration

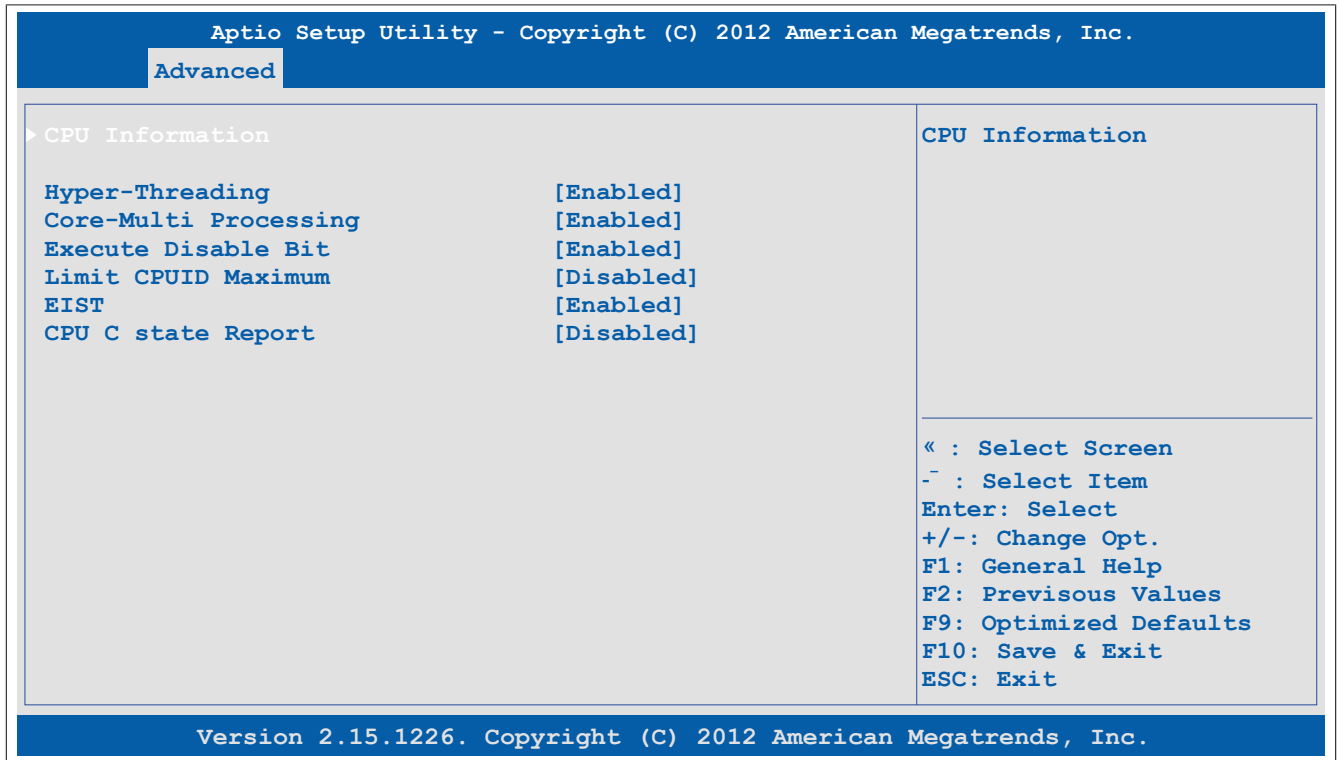

Figure 100: NM10 Advanced - CPU Configuration

BIOS setting	Function	Configuration options	Effect
CPU information	Displays CPU properties	Enter	Opens the submenu See "CPU information" on page 177
Hyper-Threading	Option for enabling/disabling Intel hyper-threading technology	Disabled	Disables this function
		Enabled	Enables this function Each processor core can execute multiple tasks (threads) at a time. Intel hyper-threading technology increases processor throughput and improves the overall performance of multi-thread software.
Core-multi processing	Option for enabling/disabling core-multi processing	Disabled	Disables this function
		Enabled	Enables this function
Execute disable bit	Option for enabling/disabling hardware support for prevention of data execution	Disabled	Disables this function
		Enabled	Enables this function
Limit CPUID maximum	Option for limiting the CPUID value. This may be necessary for older operating systems. Information: This option must be set to <i>Disabled</i> when using Windows XP.	Disabled	The processor returns the current maximum value when the CPUID value is requested.
		Enabled	The processor limits the maximum CPUID value to 03h if necessary if the processor supports a higher value.
EIST	Option for enabling/disabling Intel® SpeedStep™ technology	Disabled	Disables Intel® SpeedStep™ technology
		Enabled	Enables Intel® SpeedStep™ technology
CPU C state report	Option for enabling/disabling the CPU C report to the operating system	Disabled	Disables this function. No report is sent to the operating system.
		Enabled	Enables this function
Enhanced C state ¹⁾	Option to enable/disable enhanced C state	Disabled	Disables this function
		Enabled	Enables this function
CPU hard C4E ¹⁾	TBD	Disabled	Disables this function
		Enabled	Enables this function
CPU C6 state ¹⁾	TBD	Disabled	Disables this function

Table 130: NM10 Advanced - CPU configuration - Configuration options

BIOS setting	Function	Configuration options	Effect
C4 exit timing ¹⁾	Option for enabling/disabling C4 exit timing	Enabled	Enables this function
		Default	Uses the default
		Fast	Fast timing
		Slow	Slow timing
C-state POPDOWN ¹⁾	TBD	Disabled	Disables this function
		Enabled	Enables this function
C-state POPUP ¹⁾	TBD	Disabled	Disables this function
		Enabled	Enables this function

Table 130: NM10 Advanced - CPU configuration - Configuration options

1) This setting is only available if *CPU C state report* is set to *Enabled*.

1.4.8.1 CPU information

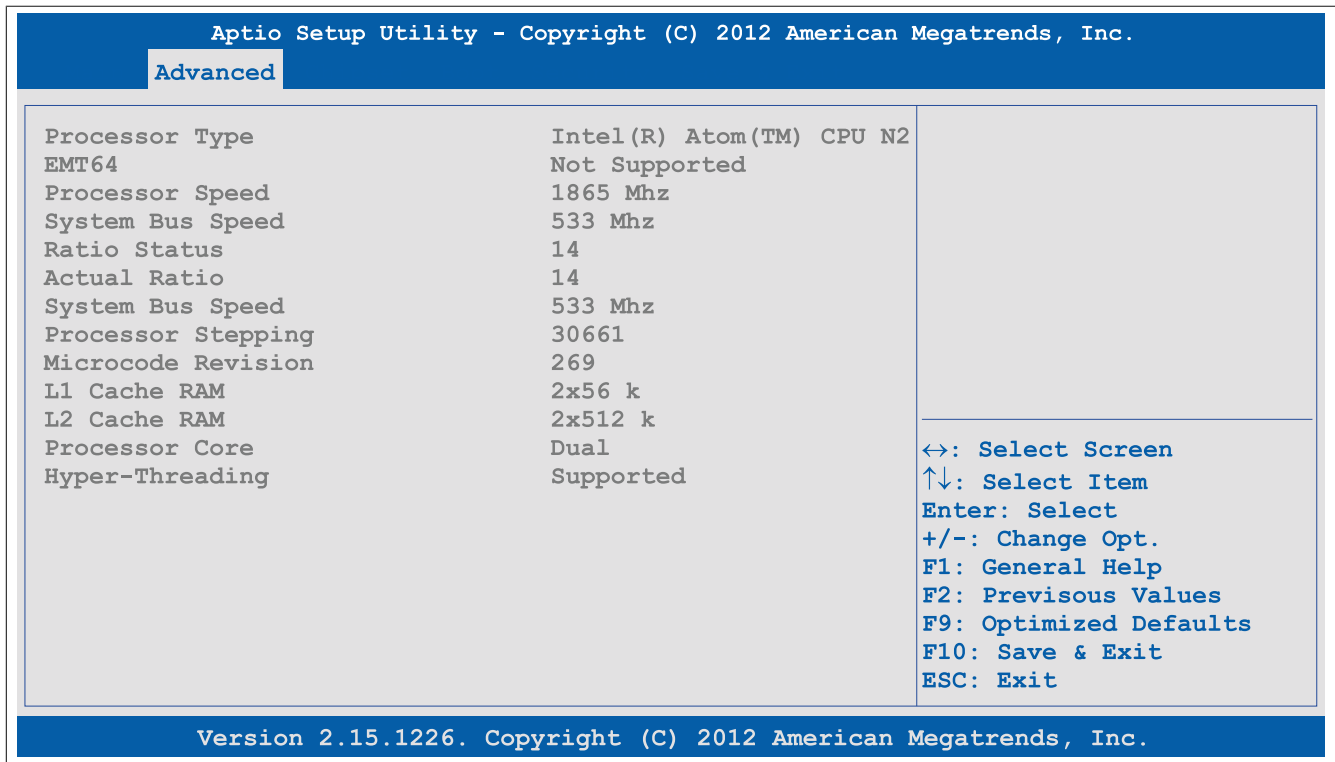

Figure 101: NM10 Advanced - CPU Configuration - CPU Information

BIOS setting	Function	Configuration options	Effect
Processor type	Displays the processor type	None	-
EMT64	TBD	None	-
Processor speed	Displays the processor clock frequency	None	-
System bus speed	Displays the system clock frequency	None	-
Ratio status	Displays the processor multiplier status	None	-
Actual ratio	Displays the current processor multiplier status	None	-
System bus speed	Displays the system clock frequency	None	-
Processor stepping	Displays the processor ID	None	-
Microcode revision	Displays the processor microcode	None	-
L1 cache RAM	Displays the L1 cache	None	-
L2 cache RAM	Displays the L2 cache	None	-
Processor core	Displays the number of processor cores	None	-
Hyper-threading	Displays information about Intel Hyper-Threading technology	None	-

Table 131: NM10 Advanced - CPU configuration - Configuration options

1.4.9 Memory configuration

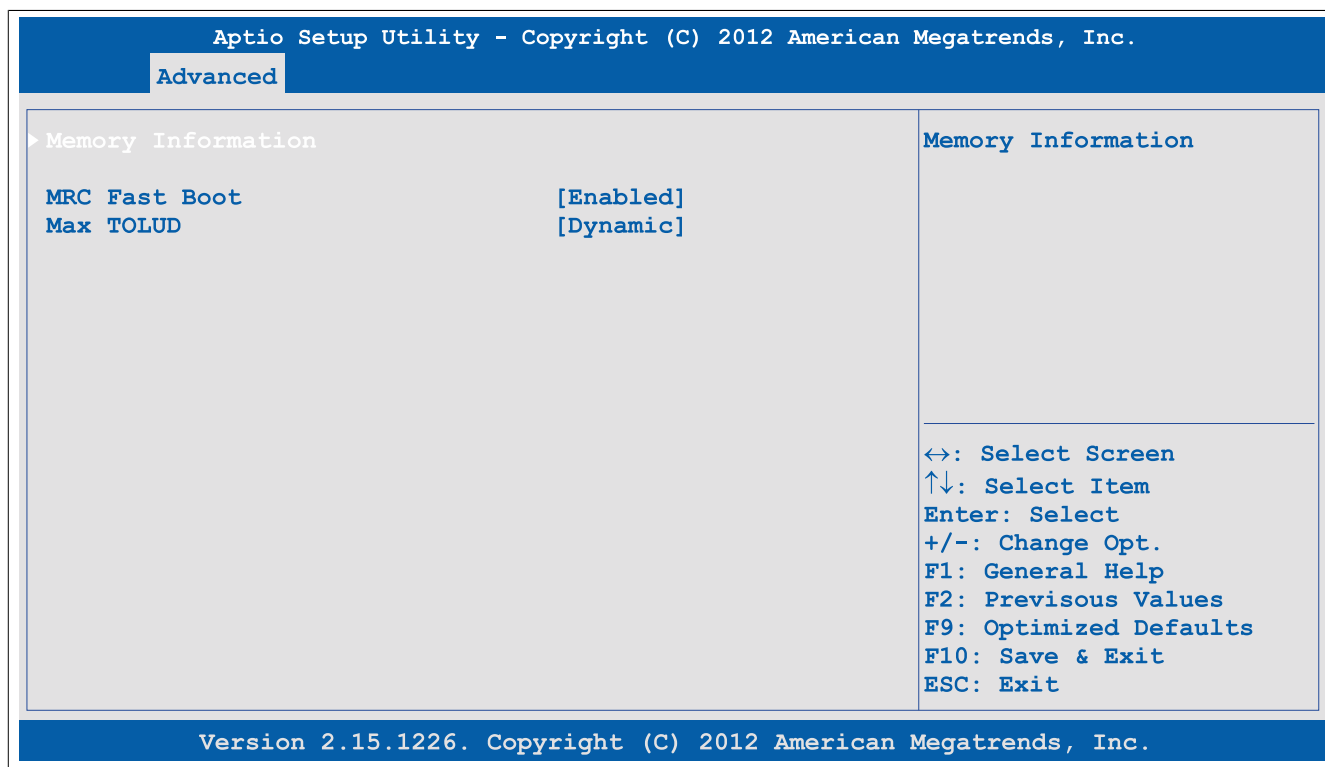

Figure 102: NM10 Advanced - Memory Configuration

BIOS setting	Function	Configuration options	Effect
Memory information	Displays main memory properties	Enter	Opens the submenu See "Memory information" on page 179
MRC fast boot	Option for enabling/disabling MRC fast booting	Enabled	Enables this function
		Disabled	Disables this function
Max TOLUD	Option for configuring the maximum "Top of low usable DRAM"	Dynamic	Automatically adjusts the TOLUD based on the MMIO length of the graphics controller
		1 GB, 1.25 GB, 1.5 GB, 1.75 GB, 2 GB, 2.25 GB, 2.5 GB, 2.75 GB, 3 GB, 3.25 GB	Manual setting of the TOLUD

Table 132: NM10 Advanced - Memory configuration - Configuration options

1.4.9.1 Memory information

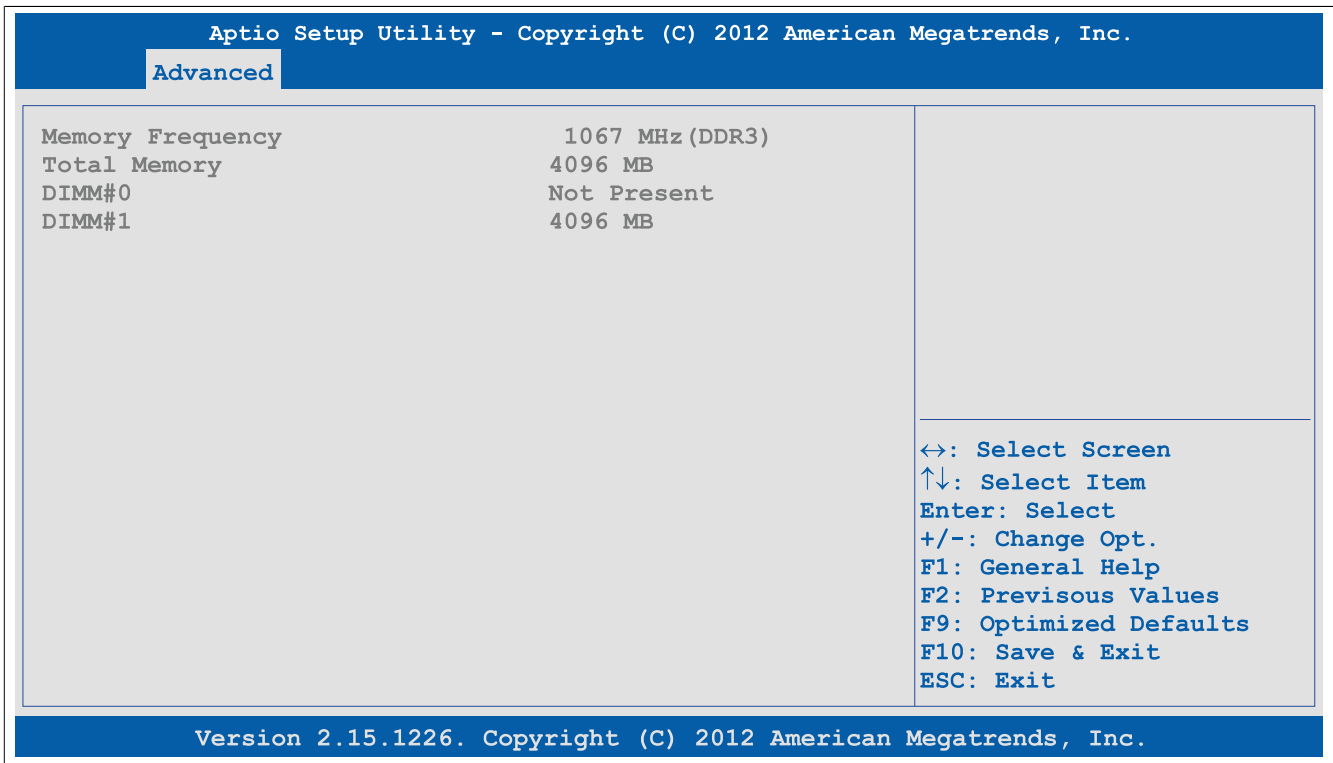

Figure 103: NM10 Advanced - Memory Configuration - Memory Information

BIOS setting	Function	Configuration options	Effect
Memory frequency	Displays the memory clock frequency	None	-
Total memory	Displays the complete system memory size	None	-
DIMM#0	Displays the amount of memory in slot Dimm#0	None	-
DIMM#1	Displays the amount of memory in slot Dimm#1	None	-

Table 133: NM10 Advanced - Memory configuration - Memory information

1.4.10 Chipset configuration

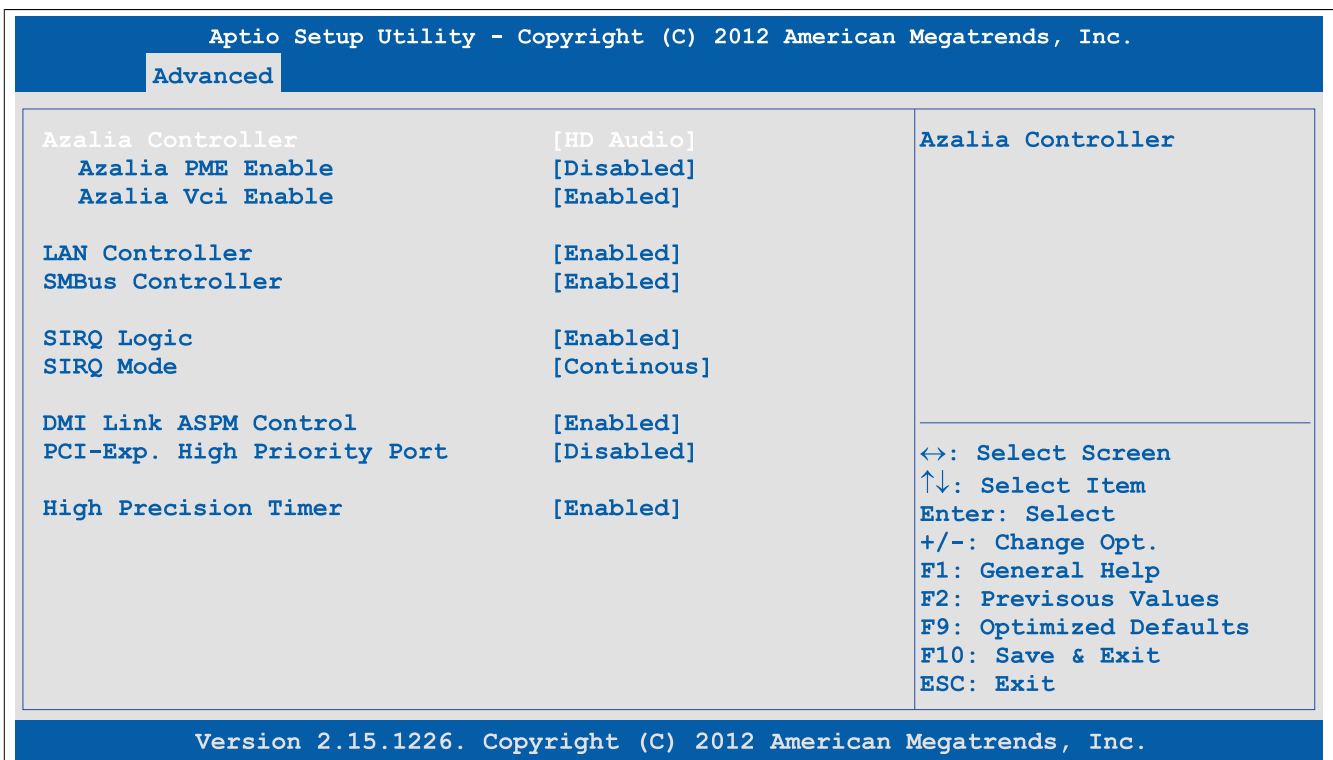

Figure 104: NM10 Advanced - Chipset Configuration

BIOS setting	Function	Configuration options	Effect
Azalia controller	Option for enabling/disabling the audio controller	Disabled	Disables the audio controller
		HD audio	Enables the audio controller
Azalia PME enable ¹⁾	Option for enabling/disabling power management for the audio controller	Disabled	Disables this function
		Enabled	Enables this function
Azalia Vci enable ¹⁾	Option for enabling/disabling video management on the audio controller	Disabled	Disables this function
		Enabled	Enables this function
LAN controller	Option for enabling/disabling the onboard LAN controller	Disabled	Disables the controller
		Enabled	Enables the controller
SMBus controller	Option for enabling/disabling the SMBus (system management bus) controller	Disabled	Disables the controller
		Enabled	Enables the controller
SIRQ logic	Option for enabling/disabling serial IRQ logic	Disabled	Disables this function
		Enabled	Enables this function
SIRQ mode ²⁾	Select the serial IRQ mode	Quiet	SIRQ in quiet mode
		Continuous	SIRQ in continuous mode
DMI link ASPM control	Option for enabling/disabling active state power management (ASPM) for the DMI link	Disabled	Disables the controller
		Enabled	Enables the controller
PCI-Exp. High priority port	Selects the PCI Express priority port	Disabled	Disables this function
		Port 0 - 3	Selects the port
High-precision timer	The HPET is a timer inside the PC. It is able to trigger an interrupt with a high degree of accuracy, which allows other programs to better synchronize a variety of applications.	Disabled	Disables this function
		Enabled	Enables this function. This function is recommended for multimedia applications.

Table 134: NM10 Advanced - Chipset configuration - Configuration options

- 1) This setting is only available if *Azalia controller* is set to *HD audio*.
- 2) This setting is only available if *SIRQ logic* is set to *Enabled*.

1.4.11 IDE configuration

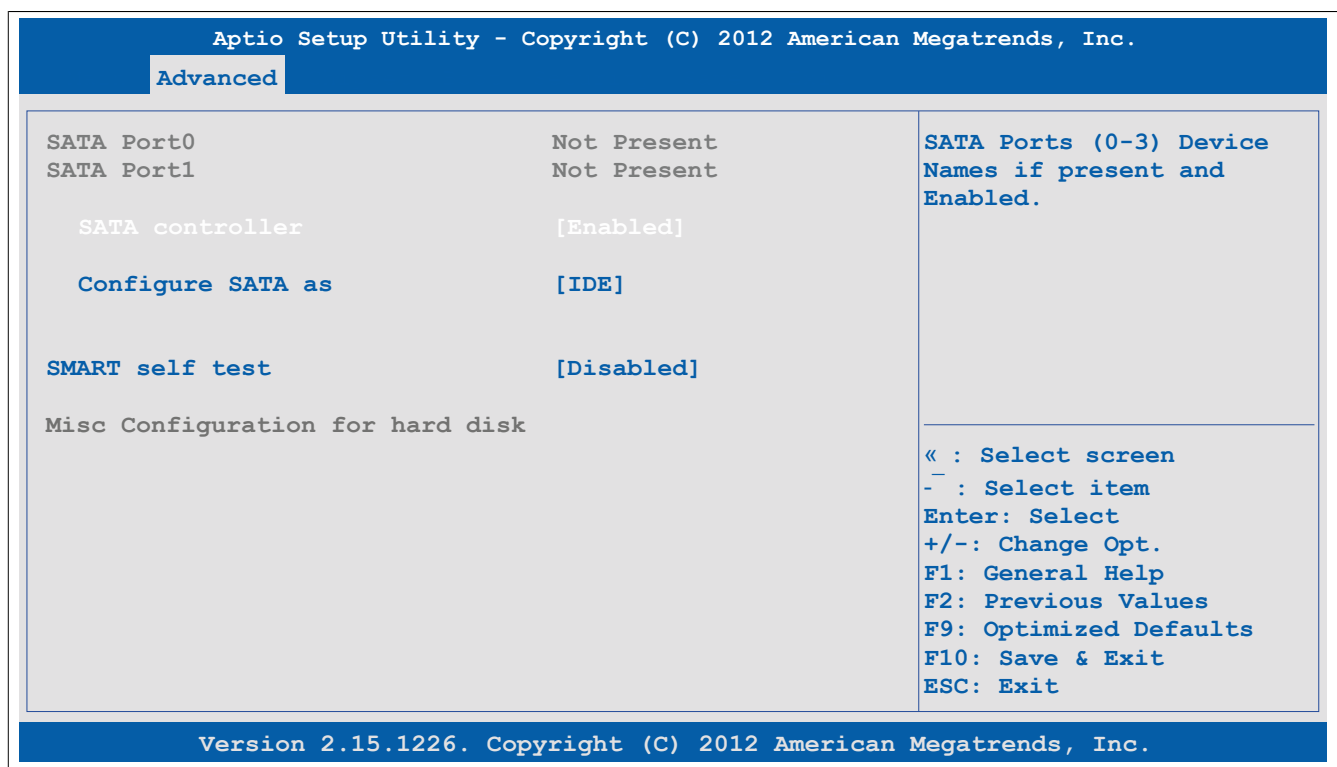

Figure 105: NM10 Advanced - IDE configuration

BIOS setting	Function	Configuration options	Effect
SATA Ports (0-3)	Displays the name of the hardware connected to the respective port	None	-
SATA controller	Option for enabling/disabling the SATA controllers	Disabled	Disables the controllers
		Enabled	Enables the controllers
Configure SATA as ¹⁾	Option for setting the SATA configuration	IDE	Configured as IDE
		AHCI	Configured as AHCI
Port (0-3) speed limit ²⁾	Sets the speed of the SATA ports	No limit	No speed limiting
		GEN1 rate	Maximum transfer rate = 2.5 GT/s
		GEN2 rate	Maximum transfer rate = 5 GT/s
SATA port 0 ²⁾	Option for enabling/disabling SATA port 0	Disabled	Disables SATA port 0
		Enabled	Enables SATA port 0

Table 135: NM10 Advanced - IDE configuration - Configuration options

BIOS setting	Function	Configuration options	Effect
SATA port 0 hot plug ²⁾	Option for configuring hot plugging for SATA port 0	Disabled	Hot plugging not enabled for SATA port 0
		Enabled	Hot plugging enabled for SATA port 0. Devices can be connected/disconnected during operation.
SATA port 1 ²⁾	Option for enabling/disabling SATA port 1	Disabled	Disables SATA port 1
		Enabled	Enables SATA port 1
SATA port 1 hot plug ²⁾	Option for configuring hot plugging for SATA port 1	Disabled	Hot plugging not enabled for SATA port 1
		Enabled	Hot plugging enabled for SATA port 1. Devices can be connected/disconnected during operation.
SMART self test	Option for configuring the SMART self-test during POST	Disabled	Disables this function
		Enabled	Enables this function

Table 135: NM10 Advanced - IDE configuration - Configuration options

- 1) This setting is only available if *SATA controller* is set to *Enabled*.
2) This setting is only available if *SATA controller* is set to *Enabled* and *Configure SATA as* is set to *AHCI*.

1.4.12 USB configuration

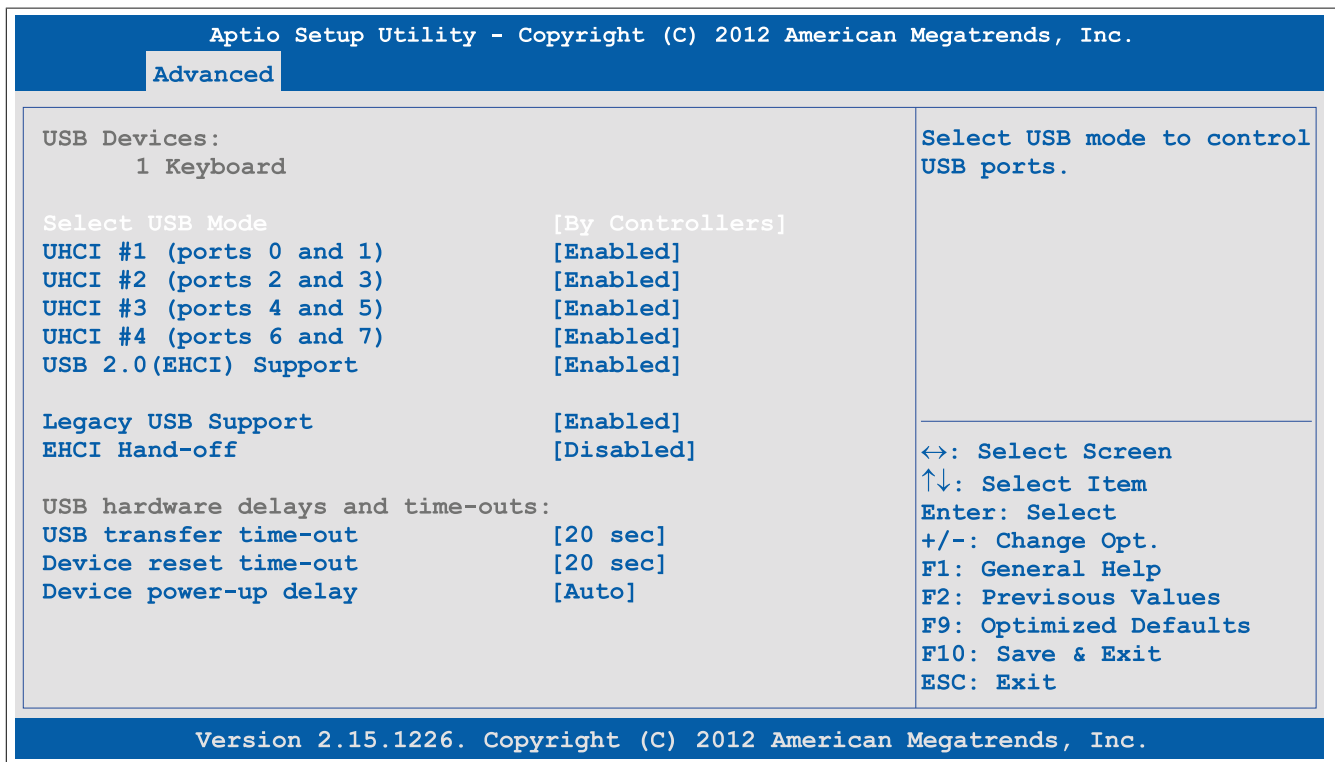

Figure 106: NM10 Advanced - USB Configuration

BIOS setting	Function	Configuration options	Effect
Select USB mode	Selects the USB mode	By ports	Selection by port
		By controllers	Selection by controller
UHCI #1 ¹⁾	Configures USB UHCI controller 1 for USB port	Disabled	Disables the controller
		Enabled	Enables the controller
UHCI #2 - #4 ²⁾	Configures USB UHCI controllers 2 - 4 for USB port	Disabled	Disables the controller
		Enabled	Enables the controller
USB function ³⁾	Switches available USB ports on/off	Disabled	Disables this function
		1-8 USB ports	Enables this function
USB 2.0(EHCI) support ⁴⁾	Enables/Disables USB 2.0 support	Disabled	Disables the controller
		Enabled	Enables the controller
Legacy USB support	Option for configuring legacy USB support. USB ports do not function during startup. USB support is available again after the operating system has started. A USB keyboard is still recognized during POST.	Enabled	Enables this function
		Disabled	Disables this function
		Auto	Automatic enabling
EHCI hand-off	Option for configuring support for operating systems without a fully automated EHCI function	Disabled	Disables this function With operating systems that do not have a fully automated EHCI function, USB devices are only operated with USB 1.1.
		Enabled	Enables USB 2.0 support
USB transfer time-out	Option for configuring the timeout value for control, bulk and interrupt transfers	1 sec, 5 sec, 10 sec, 20 sec	Value in seconds

Table 136: NM10 Advanced - USB configuration - Configuration options

BIOS setting	Function	Configuration options	Effect
Device reset time-out	Option for configuring the time that POST waits for USB memory storage devices after the device start command is issued	10 sec, 20 sec, 30 sec, 40 sec	Value in seconds
Device power-up delay	Option to set the maximum time to wait for a USB device to report to the host controller	Auto	Sets the maximum time automatically. For a root port, 100 ms is set; for a hub port, the data from the hub descriptor is used.
		Manual	Allows the maximum time to be entered manually using the "Device power-up delay in seconds" option
Device power-up delay in seconds ⁵⁾	Option to manually set the maximum time to wait for a USB device to report to the host controller	1 to 40	The maximum time can be entered in seconds.

Table 136: NM10 Advanced - USB configuration - Configuration options

- 1) This setting is only available if *Select USB mode* is set to *By controllers*.
- 2) This setting is only available if *Select USB mode* is set to *By controllers* and UHCI #1 is set to *Enabled*.
- 3) This setting is only available if *Select USB mode* is set to *By ports*.
- 4) This setting is only available if *UHCI #1* is set to *Enabled*.
- 5) This setting is only possible if *Device power-up delay* is set to *Manual*.

1.4.13 Serial port console redirection

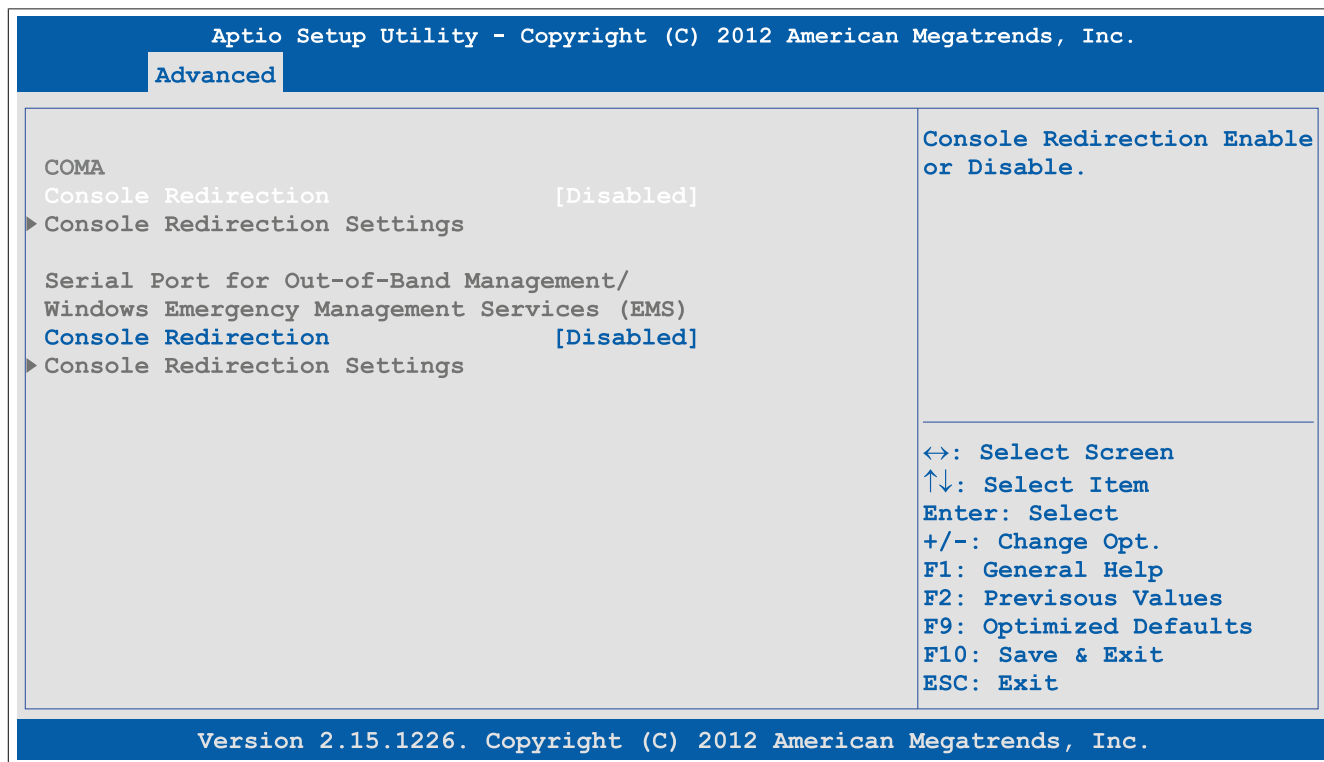

Figure 107: NM10 Advanced - Serial Port Console Redirection

BIOS setting	Function	Configuration options	Effect
COMA			
Console redirection	Option for enabling/disabling console redirection	Disabled	Disables this function
		Enabled	Enables this function
Console redirection settings¹⁾	Configures the remote console	Enter	Opens the submenu See "Console redirection settings (COMA)" on page 183
Serial port for out-of-band management / Windows Emergency Management Services (EMS)			
Console redirection	Option for enabling/disabling console redirection	Disabled	Disables this function
		Enabled	Enables this function
Console redirection settings²⁾	Configures the remote console	Enter	Opens the submenu See "Console redirection settings (EMS)" on page 184

Table 137: NM10 Advanced - Serial port console redirection - Configuration options

- 1) This setting is only available if *Console redirection (COMA)* is set to *Enabled*.
- 2) This setting is only available if *Console redirection (EMS)* is set to *Enabled*.

1.4.13.1 Console redirection settings (COMA)

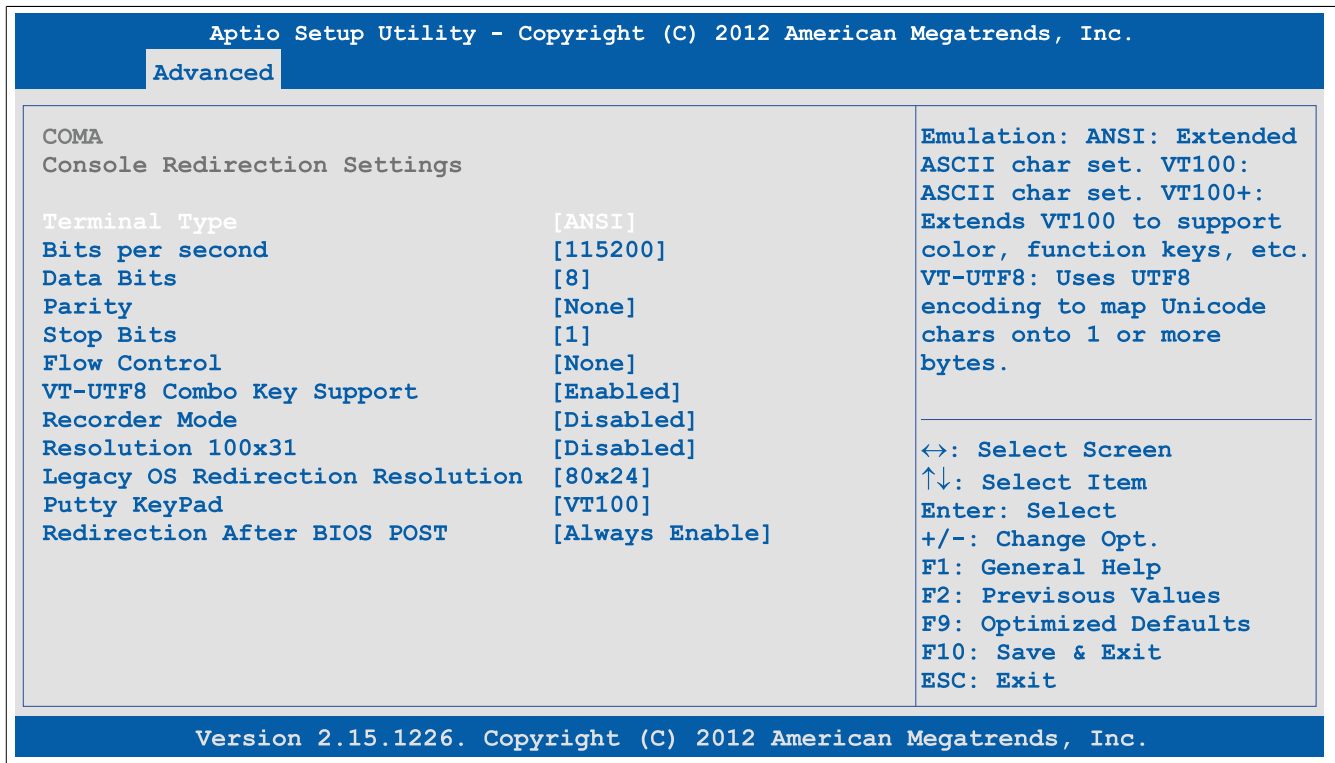

Figure 108: NM10 Console Redirection Settings (COMA)

BIOS setting	Function	Configuration options	Effect
Terminal type	Selects the type of connection	VT100, VT100+, VT-UTF8, ANSI	Configures the connection type manually
Bits per second	Selects the transfer rate in bits per second	9600, 19200, 38400, 57600, 115200	Transfer rate
Data bits	Option for setting the data bits	7, 8	Sets the number of data bits
Parity	Option for setting a parity bit	None	Parity bit not used
		Even	Uses an even number of parity bits
		Odd	Uses an odd number of parity bits
		Mark	Parity bit always 1
	Space	Parity bit always 0	
Stop bits	Sets the number of stop bits	1, 2	Uses 1 or 2 bits as the stop bit
Flow control	Determines how the transfer is controlled via the interface	None	Operates the interface without transfer control
		Hardware RTS/CTS	Uses hardware for interface transfer control.
VT-UTF8 combo key support	Option for enabling/disabling VT-UTF8 combo key support for ANSI and VT100 connections	Disabled	Disables this function
		Enabled	Enables this function
Recorder mode	Option for enabling/disabling recorder mode	Disabled	Disables this function
		Enabled	Enables this function When this setting is used, all control escape sequences are suppressed from the serial redirection output. This may lead to incorrectly formatted screen output but makes automatic storage of the serial console output easier.
Resolution 100x31	Option for enabling/disabling extended terminal resolution	Disabled	Disables this function
		Enabled	Enables this function
Legacy OS redirection resolution	Option for configuring the number of lines and columns for legacy OS redirection	80x24, 80x25	80 x 24 or 80 x 25 resolution
Putty keypad	TBD	VT100	TBD
		LINUX	TBD
		XTERMR6	TBD
		SCO	TBD
		ESCN	TBD
		VT400	TBD
Redirection After BIOS POST	Option for configuring redirection after startup	Always enable	Keeps redirection enabled permanently
		BootLoader	Enables redirection during system startup and when charging

Table 138: NM10 Advanced - Serial port console redirection - Console redirection settings (COMA) - Configuration options

1.4.13.2 Console redirection settings (EMS)



Figure 109: NM10 Console Redirection Settings (EMS)

BIOS setting	Function	Configuration options	Effect
Out-of-band mgmt port	Indicator	None	-
Terminal type	Selects the type of connection	VT100, VT100+, VT-UTF8, ANSI	Configures the connection type manually
Bits per second	Selects the transfer rate in bits per second	9600, 19200, 57600, 115200	Transfer rate
Flow control	Determines how the transfer is controlled via the interface	None	Operates the interface without transfer control
		Hardware RTS/CTS	Uses hardware for interface transfer control.
		Software Xon/Xoff	Uses software for interface transfer control
Data bits	Displays the number of data bits	None	-
Parity	Displays the parity bit	None	-
Stop bits	Displays the number of stop bits	None	-

Table 139: NM10 Advanced - Serial port console redirection - Console redirection settings (EMS) - Configuration options

1.5 Boot

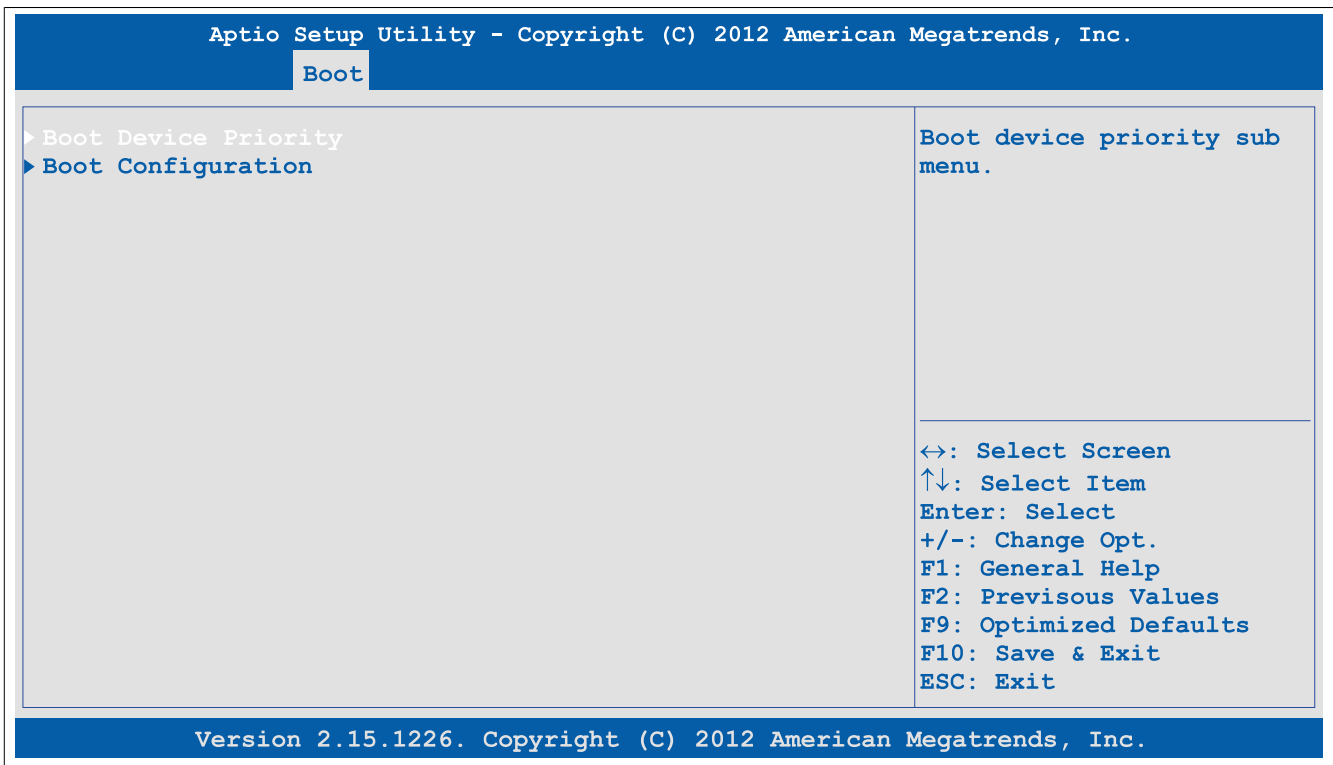

Figure 110: NM10 Boot - Übersicht

BIOS setting	Function	Configuration options	Effect
Boot device priority	Configures the boot order	Enter	Opens the submenu See "Boot device priority" on page 185
Boot configuration	Configures boot properties	Enter	Opens the submenu See "Boot configuration" on page 186

Table 140: NM10 Boot - Overview

1.5.1 Boot device priority

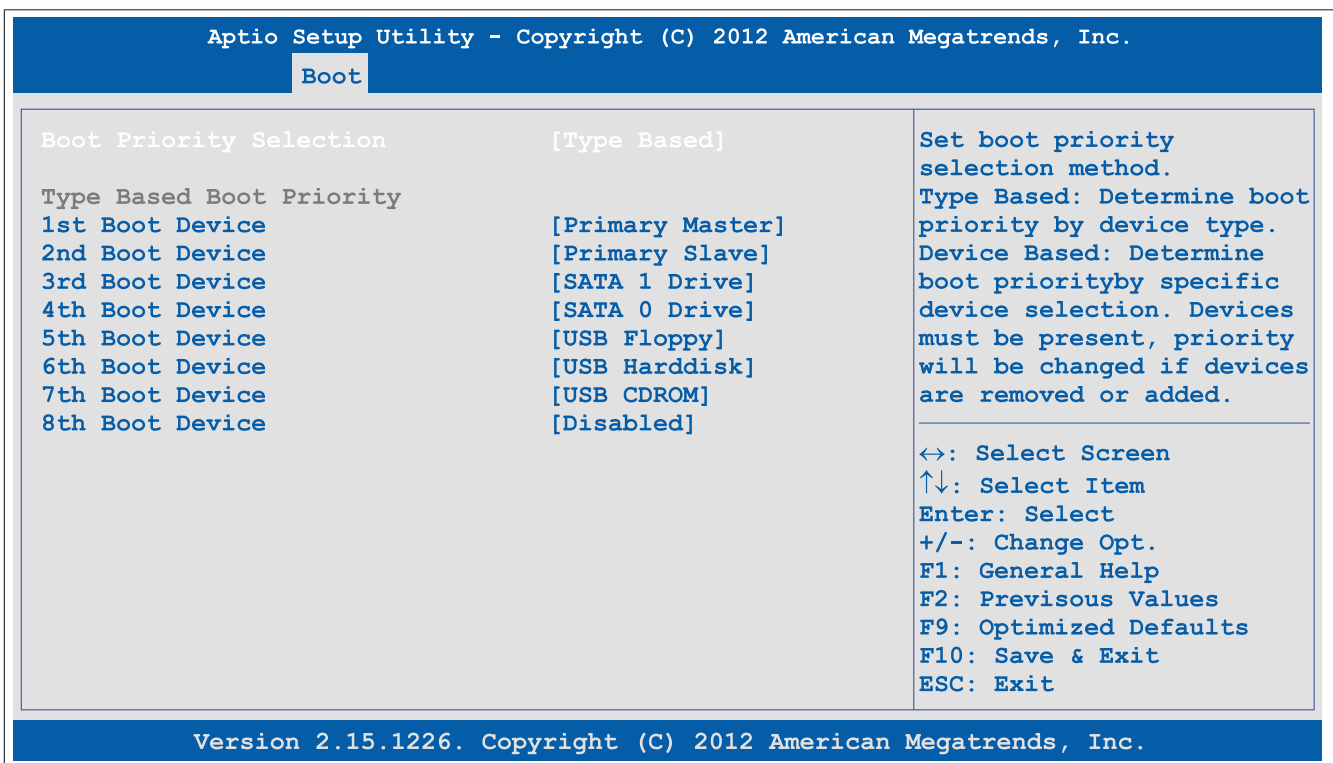

Figure 111: NM10 Boot - Boot Device Priority

BIOS setting	Function	Configuration options	Effect
Boot priority selection	Option for determining the method for how drives should be booted	Device based	Only lists devices that are recognized by the system. The order of devices in this list can be changed. Information: It is only possible to use either "Device based" or "Type based". Using both together is not permitted.
		Type based	The boot sequence of a device type list can be changed. It is also possible to add device types that are not connected to this list. Information: It is only possible to use either "Device based" or "Type based". Using both together is not permitted.
1st boot device	Option for selecting drives to be used for booting	Disabled, SATA 0 drive, SATA 1 drive, Primary master, Primary slave, USB floppy, USB hard disk, USB CDROM, Onboard LAN, External LAN, Other BEV device	Specifies the desired boot sequence
2nd boot device			
3rd boot device			
4th boot device			
5th boot device			
6th boot device			
7th boot device			
8th boot device			

Table 141: Boot - Boot device priority - Configuration options

1.5.2 Boot configuration

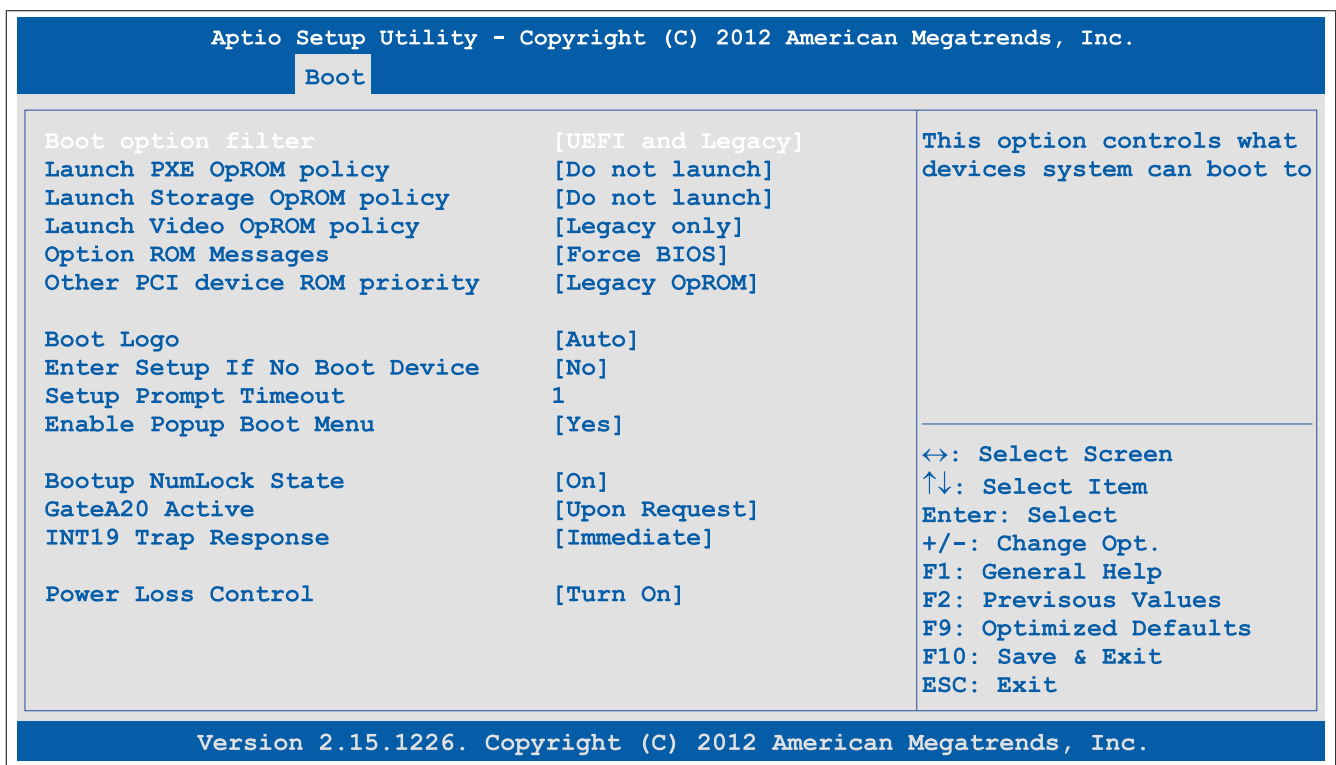

Figure 112: NM10 Boot - Boot Configuration

BIOS setting	Function	Configuration options	Effect
Boot option filter	Option for setting the boot option filter	UEFI and legacy	Allows booting with UEFI and legacy devices
		Legacy only	Allows booting with legacy devices only
		UEFI only	Allows booting with UEFI devices only
Launch PXE OpROM policy	Option for booting from PXE Option ROM	Do not launch	Does not boot from PXE Option ROM
		UEFI only	Boots from UEFI ROM
		Legacy only	Boots from legacy ROM
Launch storage OpROM policy	Option for booting from Storage Option ROM	Do not launch	Does not boot from Storage Option ROM
		UEFI only	Boots from UEFI ROM
		Legacy only	Boots from legacy ROM

Table 142: Boot - Boot configuration - Configuration options

BIOS setting	Function	Configuration options	Effect
Launch video OpROM policy	Option for booting from Video Option ROM	Do not launch	Does not boot from Video Option ROM
		UEFI only	Boots from UEFI ROM
		Legacy only	Boots from legacy ROM
Option ROM messages	Option to display Option ROM messages during POST	Force BIOS	Displays Option ROM messages during POST
		Keep current	Does not display Option ROM messages during POST
Other PCI device ROM priority	Option for selecting other PCI boot devices	UEFI OpROM	Uses UEFI PCI devices
		Legacy OpROM	Uses Legacy PCI devices
Boot logo	Option for configuring the boot logo	Disabled	Does not display the boot logo
		Enabled	Displays the boot logo
		Auto	Displays the boot logo? TBD
Enter setup if no boot device	Option for configuring whether the setup screen is displayed when no bootable drive is connected	No	Does not display the setup screen
		Yes	Displays the setup screen
Setup prompt timeout	Option for configuring how long the setup activation key (key for entering BIOS) is displayed	1 to 65534	Displays the setup activation key for x seconds
		65535	Displays the setup activation key for an unlimited amount of time
Enable popup boot menu	Option for enabling/disabling the popup boot menu	Yes	Enables this function. Pressing "F11" during POST allows a boot device to be selected.
		No	Disables this function. It is not possible to select a boot device during POST. Devices will boot in their configured order.
Bootup NumLock state	Option for configuring the numeric keypad when booting the system	On	Enables the numeric keypad
		Off	Only enables the cursor (movement) functions of the numeric keypad
GateA20 active	Option for defining how memory above 1 MB is accessed	Upon request	GA20 can be disabled.
		Always	GA20 is not disabled.
INT19 trap response	TBD	Immediate	TBD
		Postponed	TBD
Power loss control	Specifies whether the system should be on/off following power loss	Remain off	Keeps the PPC800 turned off
		Turn on	Turns on the PPC800
		Last state	Enables the previous state

Table 142: Boot - Boot configuration - Configuration options

1.6 Security

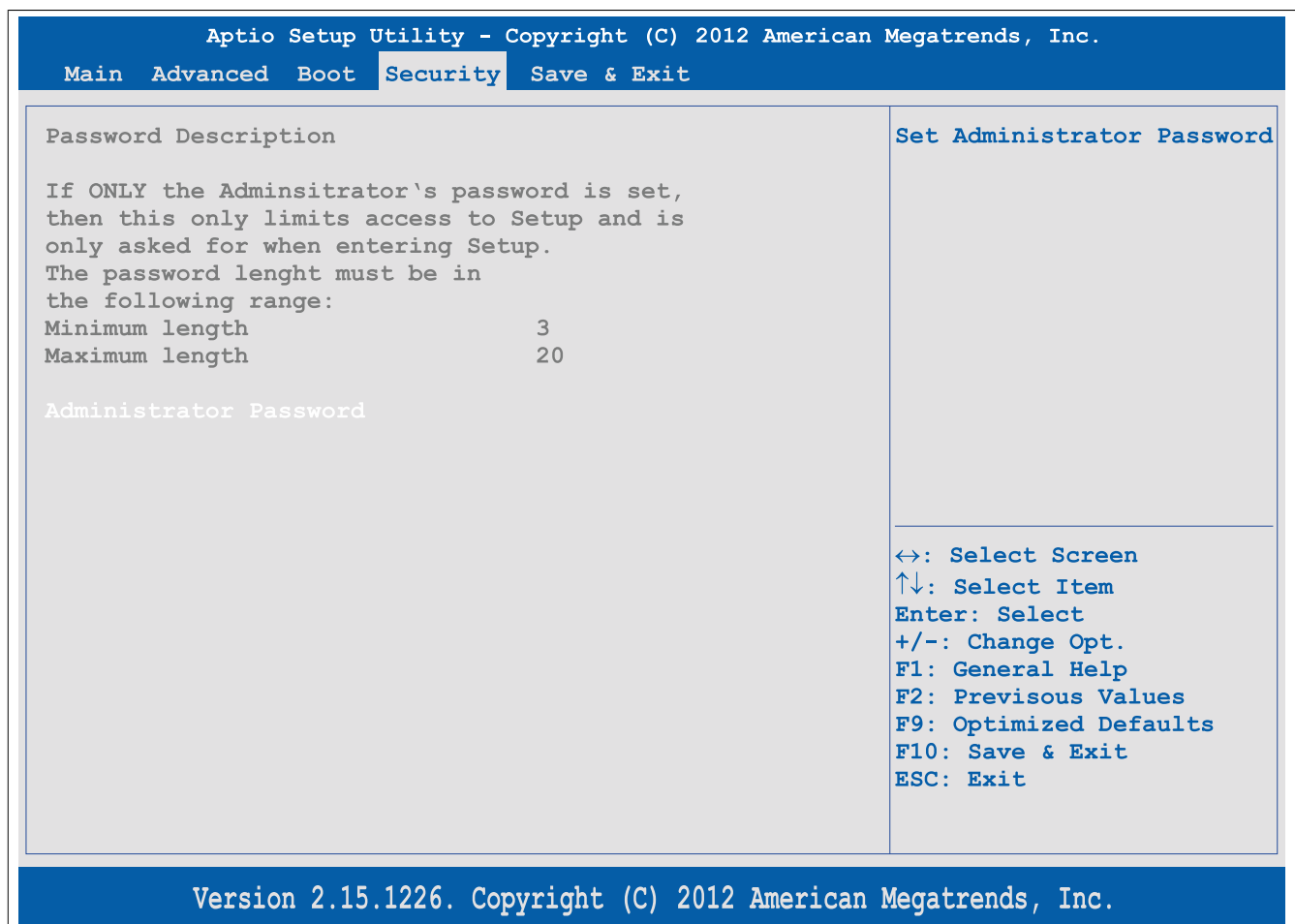

Figure 113: NM10 Security - Übersicht

BIOS setting	Function	Configuration options	Effect
Administrator password	Function for entering/changing the administrator password	Enter	Password entry

Table 143: NM10 Security menu - Configuration options

1.7 Save & Exit

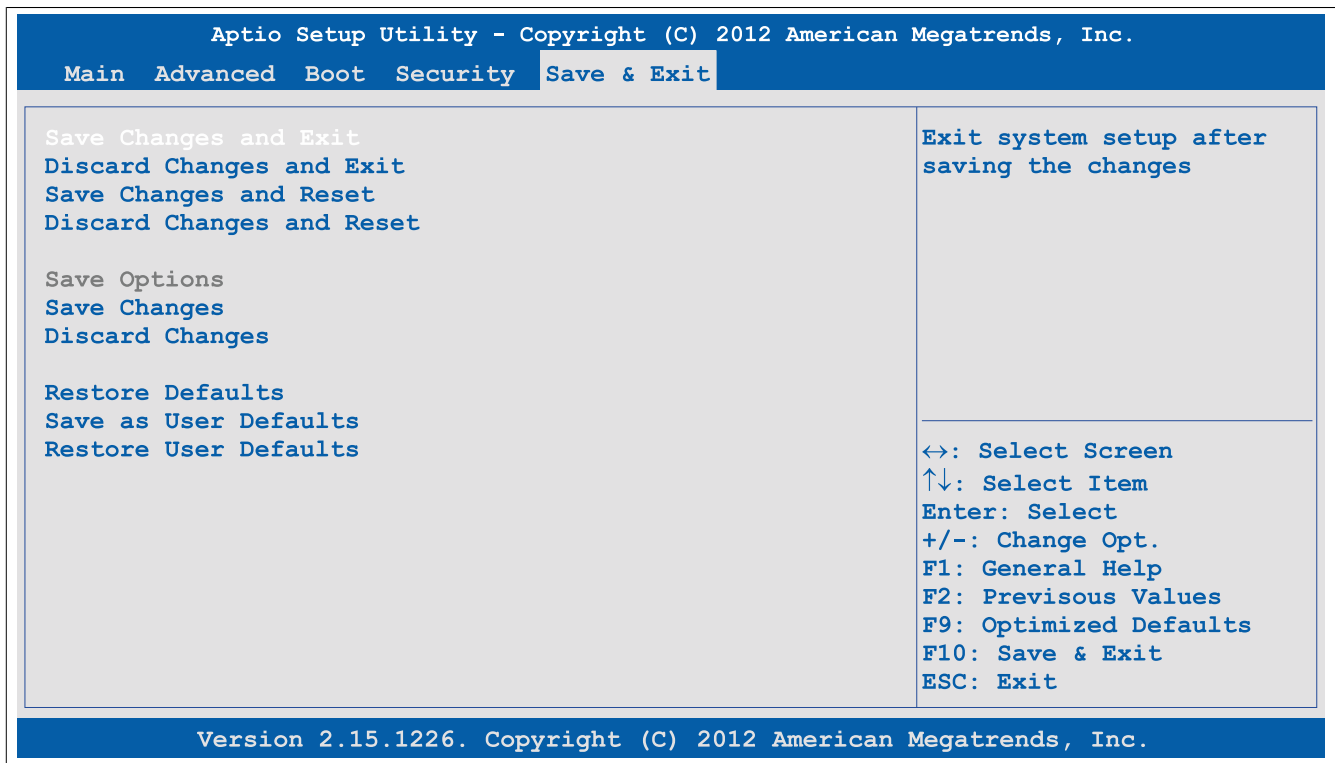

Figure 114: NM10 Save & Exit - Übersicht

BIOS setting	Function	Configuration options	Effect
Save changes and exit	Selecting this option closes BIOS Setup. Any changes made are saved to CMOS after confirmation.	Yes / No	
Discard changes and exit	Selecting this option closes BIOS Setup without saving any changes made.	Yes / No	
Save changes and reset	Selecting this option closes BIOS Setup. Any changes made are saved to CMOS after confirmation, and the system is rebooted.	Yes / No	
Discard changes and reset	Selecting this option closes BIOS Setup without saving any changes made. The system is then rebooted.	Yes / No	
Save changes	Any changes made are saved to CMOS after confirmation.	Yes / No	
Discard changes	This option can be used to reset any settings that may have been made but have been forgotten in the meantime (provided they have not yet been saved).	Yes / No	
Restore defaults	This option restores BIOS default values.	Yes / No	
Save as user defaults	This option saves the defined values as user defaults.	Yes / No	
Restore user defaults	This option restores the user default values.	Yes / No	

Table 144: NM10 Save & Exit menu - Configuration options

1.8 BIOS default settings

The various positions of the CMOS profile hex switch can be used to load predefined BIOS profile settings.

Information:

The factory default switch position represents the optimal BIOS default values for this system and should therefore not be changed.

If the function "Restore defaults" is selected in the main BIOS setup menu, or if "Save & Exit" is selected (or F9 is pressed) in the individual setup screens, the following BIOS settings are the optimized values that will be used.

Profile number	Optimized for	Switch position	Note
Profile 0	Reserved	0	
Profile 5	System unit 5PC820.1505-00 / 5PC820.1906-00	5	The default settings for this profile can be found in the PPC800 user's manual. This can be downloaded at no cost from the B&R website.

Table 145: Profile overview

The following pages provide an overview of the BIOS default settings for the different CMOS profile switch positions. Settings highlighted in yellow are variations from the BIOS default profile (=profile 0).

1.8.1 Main

Setting/Option	Profile 0	Profile 5	My settings
Main BIOS version	-	-	
OEM BIOS version	-	-	
Build date	-	-	
Product revision	-	-	
Serial number	-	-	
BC firmware rev.	-	-	
ETH 1 MAC Address	-	-	
Boot counter	-	-	
Running time	-	-	
System date	-	-	
System time	-	-	
Access Level	-	-	

Table 146: NM10 Main - Profile settings

1.8.2 Advanced

1.8.2.1 Graphics configuration

Setting/Option	Profile 0	Profile 5	My setting
IGFX - Boot type	VBIOS default	VBIOS default	
Active LFP	LVDS	LVDS	
Always try auto panel detect	No	No	
Local flat panel type	Auto	Auto	
IGD clock source	External clock	External clock	
Fixed graphics memory size	128 MB	128 MB	
Digital display interface port B	Disabled	Disabled	
IGFX VBIOS version	-	-	

Table 147: NM10 Advanced - Graphics configuration - Profile settings

1.8.2.2 Baseboard/Panel features

Setting/Option	Profile 0	Profile 5	My setting
Real-time environment	Disabled	Disabled	
Main BIOS version	-	-	
MTCX PX32	-	-	
MTCX FPGA	-	-	
OEM string	-	-	
CMOS Profile	-	-	
Device ID	-	-	
Compatibility ID	-	-	
Serial number	-	-	
Product name	-	-	
User serial ID	-	-	
Panel control			
Panel #15			

Table 148: NM10 Advanced - Baseboard/Panel features - Profile settings

Setting/Option	Profile 0	Profile 5	My setting
Version	-	-	
Brightness	100%	100%	
Fan speed	-	-	
Keys/LEDs	-	-	
Temperature	-	-	
Baseboard monitor			
CMOS battery	-	-	
Board I/O	-	-	
Board ETH2	-	-	
Board power	-	-	
Power supply	-	-	
Slide-in drive 1	-	-	
IF slot	-	-	
Case 1	-	-	
Case 2	-	-	
Case 3	-	-	
Case 4	-	-	
Super I/O configuration			
Serial port A	Enabled	Enabled	
Device settings	-	-	
Serial port B	Disabled	n/a	
Serial port C	Enabled	Enabled	
Serial port D	Disabled	n/a	
Serial port E	Disabled	Disabled	
Hardware security key	Disabled	n/a	
CAN controller	Disabled	n/a	
ETH2 LAN Controller	Enabled	Enabled	
ETH2 MAC Address	-	-	

Table 148: NM10 Advanced - Baseboard/Panel features - Profile settings

1.8.2.3 Hardware monitoring

Setting/Option	Profile 0	Profile 5	My setting
CPU temperature	-	-	
Board temperature 1	-	-	
Board temperature 2	-	-	
Board temperature 3	-	-	
12 V (default)	-	-	
5 V standby	-	-	

Table 149: NM10 Advanced - Hardware monitoring - Profile settings

1.8.2.4 PCI configuration

Setting/Option	Profile 0	Profile 5	My setting
PCI latency timer	32 PCI bus clocks	32 PCI bus clocks	
VGA palette snoop	Disabled	Disabled	
PERR# generation	Disabled	Disabled	
SERR# generation	Disabled	Disabled	
PIRQ routing & IRQ reservation			
PIRQA	Auto	Auto	
PIRQB	Auto	Auto	
PIRQC	Auto	Auto	
PIRQD	Auto	Auto	
PIRQE	Auto	Auto	
PIRQF	Auto	Auto	
PIRQG	Auto	Auto	
PIRQH	Auto	Auto	
Reserve legacy interrupt 1	None	None	
Reserve legacy interrupt 1	None	None	

Table 150: NM10 Advanced - PCI configuration - Profile settings

1.8.2.5 PCI Express configuration

Setting/Option	Profile 0	Profile 5	My setting
PCI Express root port 0			
PCI Express port 0	Enabled	Enabled	
Port 0 IOxAPIC	Disabled	Disabled	
Automatic ASPM	Manual	Manual	
ASPM L0s	Disabled	Disabled	

Table 151: NM10 Advanced - PCI Express - Profile settings

Setting/Option	Profile 0	Profile 5	My setting
ASPM L1	Disabled	Disabled	
URR	Disabled	Disabled	
FER	Disabled	Disabled	
NFER	Disabled	Disabled	
CER	Disabled	Disabled	
CTO	Disabled	Disabled	
SEFE	Disabled	Disabled	
SENF	Disabled	Disabled	
SECE	Disabled	Disabled	
PME SCI	Enabled	Enabled	
Hot plug	Disabled	Disabled	
Assign INT to root port	Enabled	Enabled	
Extra bus reserved	0	0	
Reserved memory	10	10	
Reserved I/O	4	4	
PCI Express root port x (1-3)			
PCI Express port x (1-3)	Auto	Auto	
Port 0 IOxAPIC	Disabled	Disabled	
Automatic ASPM	Manual	Manual	
ASPM L0s	Disabled	Disabled	
ASPM L1	Disabled	Disabled	
URR	Disabled	Disabled	
FER	Disabled	Disabled	
NFER	Disabled	Disabled	
CER	Disabled	Disabled	
CTO	Disabled	Disabled	
SEFE	Disabled	Disabled	
SENF	Disabled	Disabled	
SECE	Disabled	Disabled	
PME SCI	Enabled	Enabled	
Hot plug	Disabled	Disabled	
Assign INT to root port	Enabled	Enabled	
Extra bus reserved	0	0	
Reserved memory	10	10	
Reserved I/O	4	4	
PCI Express settings			
Relaxed ordering	Disabled	Disabled	
Extended tag	Disabled	Disabled	
No snoop	Enabled	Enabled	
Maximum payload	Auto	Auto	
Maximum read request	Auto	Auto	
ASPM support	Disabled	Disabled	
Extended synch	Disabled	Disabled	
Link training retry	5	5	
Link training timeout (uS)	100	100	
Unpopulated links	Keep link ON	Keep link ON	

Table 151: NM10 Advanced - PCI Express - Profile settings

1.8.2.6 RTC wake settings

Setting/Option	Profile 0	Profile 5	My setting
Wake system at fixed time	Disabled	Disabled	

Table 152: NM10 Advanced - RTC wake - Profile settings

1.8.2.7 ACPI settings

Setting/Option	Profile 0	Profile 5	My setting
Enable hibernation	Enabled	Enabled	
ACPI sleep state	Both S1 and S3 avai...	Both S1 and S3 avai...	
Lock legacy resources	Disabled	Disabled	
S3 video repost	Disabled	Disabled	
S3 USB wake	Disabled	Disabled	
CPU thermal monitoring	Enabled	Enabled	
Critical trip point	111 C	111 C	
Passive trip point	95 C	95 C	
Passive TC1 value	1	1	
Passive TC2 value	5	5	
Passive TSP value	10	10	

Table 153: NM10 Advanced - ACPI settings - Profile settings

1.8.2.8 CPU configuration

Setting/Option	Profile 0	Profile 5	My setting
Hyper-Threading	Enabled	Enabled	
Core-multi processing	Enabled	Enabled	
Execute disable bit	Enabled	Enabled	
Limit CPUID maximum	Disabled	Disabled	
EIST	Enabled	Enabled	
CPU C state report	Disabled	Disabled	
CPU information			
Processor type	-	-	
EMT 64	-	-	
Processor speed	-	-	
System bus speed	-	-	
Ratio status	-	-	
Actual ratio	-	-	
System bus speed	-	-	
Processor stepping	-	-	
Microcode revision	-	-	
L1 cache RAM	-	-	
L2 cache RAM	-	-	
Processor core	-	-	
Hyper-Threading	-	-	

Table 154: NM10 Advanced - CPU configuration - Profile settings

1.8.2.9 Memory configuration

Setting/Option	Profile 0	Profile 5	My setting
MRC fast boot	Enabled	Enabled	
Max TOLUD	Dynamic	Dynamic	
Memory information			
Memory frequency	-	-	
Total memory	-	-	
DIMM#0	-	-	
DIMM#1	-	-	

Table 155: NM10 Advanced - Memory configuration - Profile settings

1.8.2.10 Chipset configuration

Setting/Option	Profile 0	Profile 5	My setting
Azalia controller	HD audio	HD audio	
Azalia PME enable	Disabled	Disabled	
Azalia Vci enable	Enabled	Enabled	
LAN controller	Enabled	Enabled	
SMBus controller	Enabled	Enabled	
SIRQ logic	Enabled	Enabled	
SIRQ mode	Continuous	Continuous	
DMI link ASPM control	Enabled	Enabled	
PCI-Exp. High priority port	Disabled	Disabled	
High precision timer	Enabled	Enabled	

Table 156: NM10 Advanced - Chipset configuration - Profile settings

1.8.2.11 IDE configuration

Setting/Option	Profile 0	Profile 5	My setting
SATA Port0	-	-	
SATA Port1	-	-	
SATA controller	Enabled	Enabled	
Configure SATA as	IDE	IDE	
SMART self test	Disabled	Disabled	

Table 157: NM10 Advanced - IDE configuration - Profile settings

1.8.2.12 USB configuration

Setting/Option	Profile 0	Profile 5	My setting
Select USB mode	By controllers	By controllers	
UHCI #1 (ports 0 and 1)	Enabled	Enabled	
UHCI #2 (ports 2 and 3)	Enabled	Enabled	
UHCI #3 (ports 4 and 5)	Enabled	Enabled	

Table 158: NM10 Advanced - USB configuration - Profile settings

Setting/Option	Profile 0	Profile 5	My setting
UHCI #4 (ports 6 and 7)	Enabled	Enabled	
USB 2.0(EHCI) support	Enabled	Enabled	
Legacy USB support	Enabled	Enabled	
EHCI hand-off	Disabled	Disabled	
USB transfer time-out	20 sec	20sec	
Device reset time-out	20 sec	20sec	
Device power-up delay	Auto	Auto	

Table 158: NM10 Advanced - USB configuration - Profile settings

1.8.2.13 Serial port console redirection

Setting/Option	Profile 0	Profile 5	My setting
Console redirection (COMA)	Disabled	Disabled	
Console redirection (EMS)	Disabled	Disabled	

Table 159: NM10 Advanced - Serial port console redirection - Profile settings

1.8.3 Boot

Setting/Option	Profile 0	Profile 5	My setting
Boot device priority			
Boot priority selection	Type based	Type based	
1st boot device	Onboard LAN	Primary master	
2nd boot device	Primary master	Primary Slave	
3rd boot device	Primary Slave	SATA 1 drive	
4th boot device	USB floppy	SATA 0 drive	
5th boot device	Disabled	USB floppy	
6th boot device	Disabled	USB hard disk	
7th boot device	Disabled	USB CDROM	
8th boot device	Disabled	Disabled	
Boot configuration			
Boot option filter	UEFI and legacy	UEFI and legacy	
Launch PXE OpROM policy	Legacy only	Do not launch	
Launch storage OpROM policy	Do not launch	Do not launch	
Launch video OpROM policy	Legacy only	Legacy only	
Option ROM messages	Force BIOS	Force BIOS	
Other PCI device ROM priority	Legacy OpROM	Legacy OpROM	
Boot logo	Auto	Auto	
Enter setup if no boot device	No	No	
Setup prompt timeout	1	1	
Enable popup boot menu	Yes	Yes	
Bootup NumLock state	On	On	
GateA20 active	Upon request	Upon request	
INT19 trap response	Immediate	Immediate	
Power loss control	Turn on	Turn on	

Table 160: NM10 Boot - Overview of profile settings

1.8.4 Security

Setting/Option	Profile 0	Profile 5	My setting
Administrator password	-	-	

Table 161: NM10 Security - Profile settings

1.9 Allocation of resources

1.9.1 RAM address assignment

RAM address	Address in hexadecimal	Resource
(TOM - 384 kB) – TOM ¹⁾	N.A.	ACPI reclaim, PCI memory range, Video,... ²⁾
1024 kB – (TOM - xxxx)	100000h - N.A.	Extended memory
869 kB – 1024 kB	0E0000h - 0FFFFFFh	Runtime BIOS
768 kB – 869 kB	0C0000h - 0DFFFFh	Expansion area
640 kB – 768 kB	0A0000h - 0BFFFFh	Video memory and BIOS
639 kB – 640 kB	09FC00h - 09FFFFh	Extended BIOS data
0 – 639 kB	000000h - 09FC00h	Conventional memory

Table 162: RAM address assignment

1) TOM = Top of memory: max. installed DRAM.

1.9.2 I/O address assignment

I/O address	Resource
0000h - 00FFh	Motherboard resources
0170h - 0177h	Secondary IDE channel
01F0h - 01F7h	Primary IDE channel
02E8h - 02EFh	COM4
0376h - 0376h	Secondary IDE channel command port
0377h - 0377h	Secondary IDE channel status port
03B0h - 03DFh	Video system
03E8h - 03EFh	COM3
03F6h - 03F6h	Primary IDE channel command port
03F7h - 03F7h	Primary IDE channel status port
03F8h - 03FFh	COM1
04D0h - 04D1h	Motherboard resources
0500h - 053Fh	Motherboard resources
0800h - 087Fh	Motherboard resources
0A00h - 0A7Fh	Motherboard resources
0CF8h - 0CFBh	PCI config address register
0CFCh - 0CFFh	PCI config data register
0D00h - FFFFh	PCI / PCI Express bus ¹⁾
4100h - 417Fh	MTCX
FF00h - FF07h	IDE bus master register

Table 163: I/O address assignment

1) The BIOS assigns the PCI and PCI Express bus I/O resources from FFF0h downward. Devices that are not compatible with PnP/PCI/PCI Express cannot use the I/O resources in this range.

1.9.3 Interrupt assignments in PIC mode

IRQ	0	1	2	3	4	5	6	7	8	9	10	11	12	13	14	15	NMI	NONE
System timer	•																	
Keyboard		•																
IRQ cascade			•															
COM1 (serial port A)				○	•	○	○	○			○	○	○					
ACPI ¹⁾										•								
Real-time clock									•									
Coprocessor (FPU)														•				
Primary IDE channel ²⁾															•			
Secondary IDE channel ²⁾																•		
B&R	COM3 (COM C)			○	○	○	○	○			○	○	○					•
	COM5 (COM E)			○	○	○	○	○			○	○	○					•

Table 164: IRQ interrupt assignments in PIC mode

1) **A**dvanced **C**onfiguration and **P**ower **I**nterface.

2) If the SATA configuration in BIOS is set to Enhanced mode for all SATA ports, IRQs 14 and 15 are enabled for the system and the SATA ports use other IRQs.

- ... Default setting
- ... Optional setting

1.9.4 Interrupt assignment in APIC mode

A total of 23 IRQs are available in APIC (**A**dvanced **P**rogrammable **I**nterrupt **C**ontroller) mode. Enabling this option is only effective if done before the Windows operating system is installed.

IRQ	0	1	2	3	4	5	6	7	8	9	10	11	12	13	14	15	16	17	18	19	20	21	22	23	NMI	NONE
System timer	•																									
Keyboard		•																								
IRQ cascade			•																							
COM1 (serial port A)				○	•	○	○	○			○	○	○													
ACPI ¹⁾										•																
Real-time clock										•																
Coprocessor (FPU)														•												
Primary IDE channel ²⁾															•											
Secondary IDE channel ²⁾																•										
B&R COM3 (COM C)				○	○	○	○	○			○	○	○													•
PIRQ A ³⁾																	•									
PIRQ B ⁴⁾																		•								
PIRQ C ⁵⁾																			•							
PIRQ D ⁶⁾																				•						
PIRQ E ⁷⁾																					•					
PIRQ F ⁸⁾																						•				
PIRQ G ⁹⁾																							•			
PIRQ H ¹⁰⁾																								•		

Table 165: IRQ interrupt assignments in APIC mode

- 1) Advanced Configuration and Power Interface.
- 2) If the SATA configuration in BIOS is set to Enhanced mode for all SATA ports, IRQs 14 and 15 are enabled for the system and the SATA ports use other IRQs.
- 3) PIRQ A: for PCIe; UHCI Host Controller 3, VGA controller, PCI Express root port 0
- 4) PIRQ B: For PCIe; PCI Express root port 1, PCIe to PCIe bridge.
- 5) PIRQ C: for PCIe; PCI Express Root Port 2, PCIe to PATA Bridge, IF slot
- 6) PIRQ D: for PCIe; UHCI host controller 1, serial ATA controller 0 + 1 in enhanced/native mode, PCI express root port 3, SM bus controller, RTL8111E (ETH1)
- 7) PIRQ E: PCI Bus INTD, UHCI Host Controller 2, HDA Audio
- 8) PIRQ F: PCI Bus INTA
- 9) PIRQ G: PCI Bus INTB
- 10) PIRQ H: PCI Bus INTC, UHCI Host Controller 0, EHCI Host Controller 0

- ... Default setting
- ... Optional setting

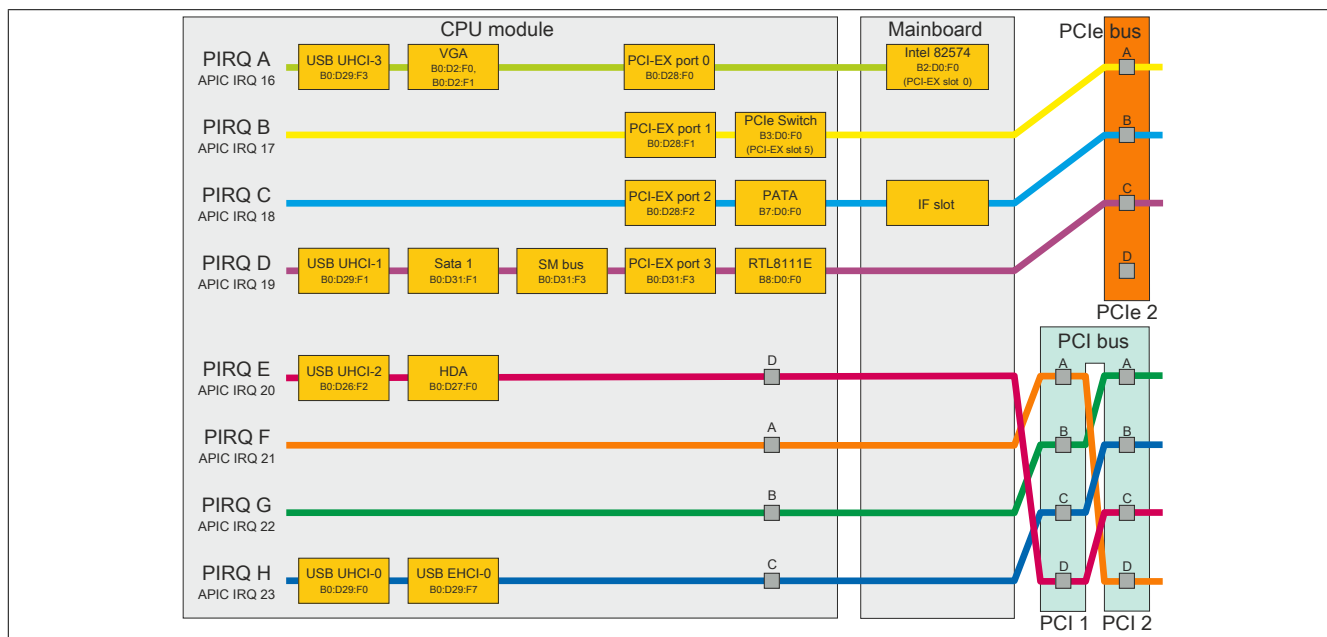

Figure 115: PCI and PCIe routing with enabled APIC for NM10 CPU boards

2 Upgrade information

Warning!

The BIOS and firmware on B&R devices must be kept current. New versions can be downloaded from the B&R website (www.br-automation.com).

2.1 BIOS upgrade

An upgrade may be necessary in order to accomplish the following:

- Updating implemented functions or adding newly implemented functions or components to BIOS Setup (information about changes can be found in the Readme file for the BIOS upgrade).

2.1.1 Important information

Information:

Customized BIOS settings are deleted when upgrading BIOS.

Before starting an upgrade, it helps to determine the various software versions.

2.1.1.1 Which BIOS version and firmware are already installed on the PPC800?

This information can be found on the following BIOS Setup screen:

- After switching on the PPC800, BIOS Setup can be accessed by pressing .
- From the BIOS main menu "Advanced", select "Baseboard/Panel features".

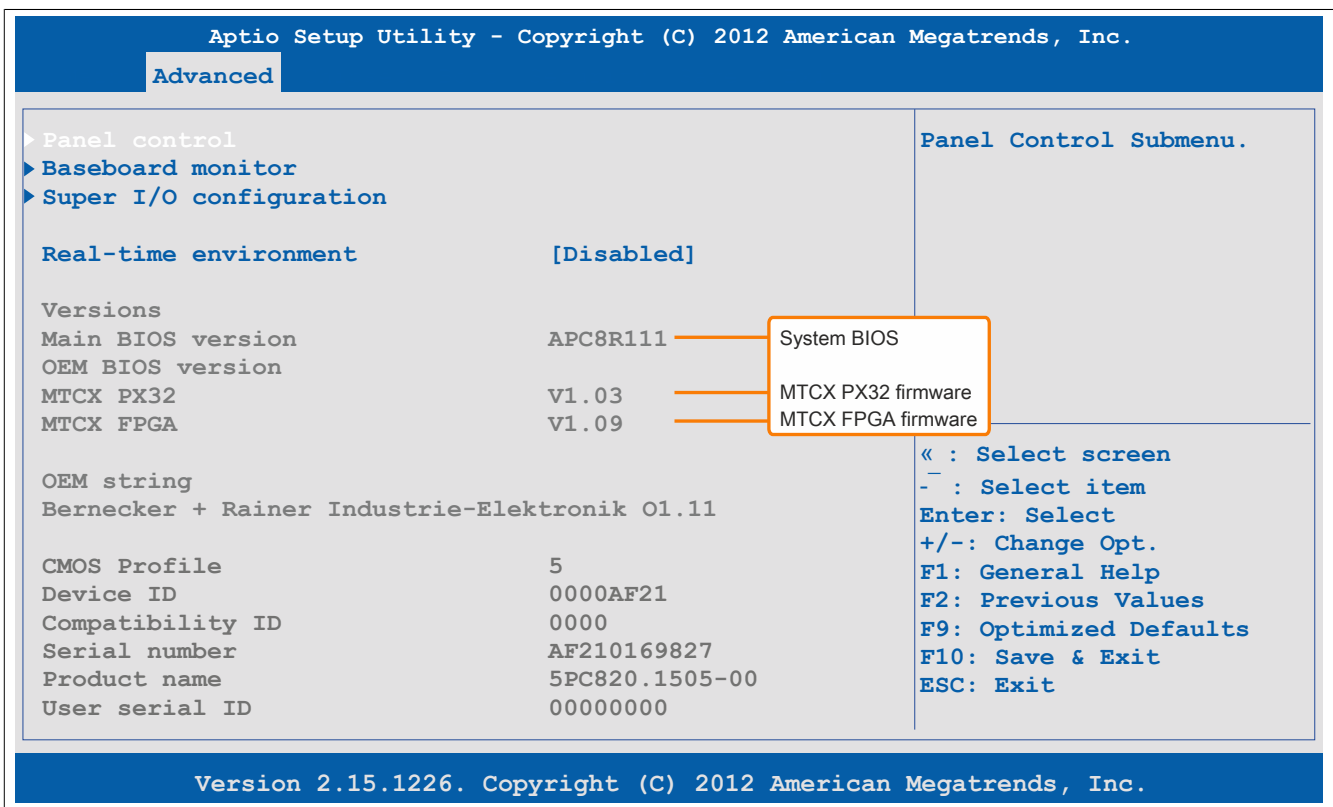

Figure 116: Software version

2.1.2 Procedure with MS-DOS

1. Download the .zip file from the B&R website (www.br-automation.com).
2. Create bootable media.

Information:

In MS-DOS, Win95 and Win98, a blank HD disk can be made bootable by typing "sys a:" or "format a: /s" on the command line.

Information about creating a bootable diskette in Windows XP can be found on page 201.

Information on creating a USB flash drive for a B&R upgrade can be found on page 203.

Information on creating a CompactFlash card for a B&R upgrade can be found on page 204.

3. Copy the contents of the .zip file to the bootable media. If the B&R upgrade was already added when creating the bootable media with the B&R Embedded OS Installer, then this step is not necessary.
4. Connect the bootable media to the B&R device and reboot.
5. The following boot menu will be shown after startup:

```
1. Upgrade AMI (UEFI) BIOS for N2800 (5PC800.CCAX-00)
2. Exit
```

Item 1:

BIOS is automatically upgraded (default after 5 seconds).

Item 2:

Returns to the shell (MS-DOS)

Information:

If a button is not pressed within 5 seconds, then item 1 "Upgrade AMI BIOS for NM10" is automatically carried out and the industrial PC is updated automatically.

6. The system must be rebooted after a successful upgrade.
7. Reboot and press to enter BIOS Setup and load the setup defaults, then select "Save changes and exit".

2.2 Firmware upgrade

The "Firmware upgrade (MTCX, SDLR, UPS)" software makes it possible to update the firmware for multiple controllers (MTCX, SDLR, UPS) depending on the PPC800 system variant.

The latest firmware upgrade is available in the Downloads section of the B&R website (www.br-automation.com).

2.2.1 Procedure

Proceed as follows to carry out a firmware upgrade:

1. Download the .zip file from the B&R website (www.br-automation.com).
2. Create bootable media.

Information:

In MS-DOS, Win95 and Win98, a blank HD disk can be made bootable by typing "sys a:" or "format a: /s" on the command line.

Information about creating a bootable diskette in Windows XP can be found on page 201.

Information on creating a USB flash drive for a B&R upgrade can be found on page 203.

Information on creating a CompactFlash card for a B&R upgrade can be found on page 204.

3. Copy the contents of the .zip file to the bootable media. If the B&R upgrade was already added when creating the bootable media with the B&R Embedded OS Installer, then this step is not necessary.
4. Connect the bootable media to the B&R device and reboot.
5. The following boot menu will be shown after startup:

Information:

The following boot menu options including descriptions are based on Version 1.02 of the PPC800 upgrade (MTCX, SDLR, SDLT, UPSI) disk. In some cases, these descriptions might not match the version you are currently using.

```

1. Upgrade MTCX (PPC800) PX32 and FPGA
2. Upgrade SDLR (AP800/AP900) on Monitor/Panel
2.1. Upgrade SDLR on AP 0 (AP800/AP900)
2.2. Upgrade SDLR on AP 1 (AP800/AP900)
2.3. Upgrade SDLR on AP 2 (AP800/AP900)
2.4. Upgrade SDLR on AP 3 (AP800/AP900)
2.5. Upgrade all SDLR (AP800/AP900)
2.6. Return to Main Menu
3. Upgrade Add-on UPS (Firmware and Battery Settings)
3.1. Upgrade Add-on UPS Firmware (5AC600.UPSI-00)
3.2. Upgrade Battery Settings (5AC600.UPSB-00)
3.3. Return to Main Menu
4. Exit

```

Item 1:

Automatically upgrades the PX32 and FPGA of the MTCX (default after 5 seconds)

Item 2:

Opens Submenu 1 for upgrading the SDLR controller on the monitor/panel interface

2.1 Upgrade SDLR on AP 0 (AP800/AP900)

Automatically updates the SDLR controller on the Automation Panel 0 interface

2.2 Upgrade SDLR on AP 1 (AP800/AP900)

Automatically updates the SDLR controller on the Automation Panel 1 interface

2.3 Upgrade SDLR on AP 2 (AP800/AP900)

Automatically updates the SDLR controller on the Automation Panel 2 interface

2.4 Upgrade SDLR on AP 3 (AP800/AP900)

Automatically updates the SDLR controller on the Automation Panel 3 interface

2.5 Upgrade all SDLR (AP800/AP900)

Automatically updates all SDLR controllers on all Automation Panels on the monitor/panel interface (default selection after 5 sec)

2.6 Return to main menu

Returns to the main menu

Item 3:

Opens Submenu 3 for upgrading the add-on UPS firmware and battery settings

3.1 Upgrade add-on UPS firmware (5AC600.UPSI-00)

Updates the firmware for the add-on UPS

3.2 Upgrade battery settings (5AC600.UPSB-00)

Automatically updates the battery settings for 5AC600.UPSB-00

3.3 Return to main menu

Returns to the main menu

Item 4:

Returns to the shell (MS-DOS)

- The system must be rebooted after a successful upgrade.

2.2.2 Possible upgrade problems and software dependencies (for V1.02)

- The SDLR firmware can only be updated if an Automation Panel with Automation Panel Link transceiver (5DLSDL.1000-01) and Automation Panel Link receiver (5DLSDL.1000-00) is connected.
- Automation Panel Link transceivers (5DLSDL.1000-01) or Automation Panel Link receivers (5DLSDL.1000-00) with a firmware version less than or equal to V00.10 can no longer be combined with Automation Panel Link transceivers (5DLSDL.1000-01) or Automation Panel Link receivers (5DLSDL.1000-00) with a firmware version greater than or equal to V01.04. Daisy chain mode is not possible with this type of a combination.
- If a UPS (e.g. 5AC600.UPSI-00) + battery unit (e.g. 5AC600.UPSB-00) is connected to the system and ready to be operated, then either the battery must be disconnected or the Power button pushed after upgrading the MTCX or SDLT (to put the system in standby mode) before powering the system off and back on. If this is not done, the firmware upgrade will not work since the UPS is buffering the system.

2.3 Creating an MS-DOS boot diskette in Windows XP

1. Insert a blank 1.44 MB HD diskette into the disk drive.
2. Open Windows Explorer.
3. Right-click on the 3½ floppy diskette icon and select "Format".

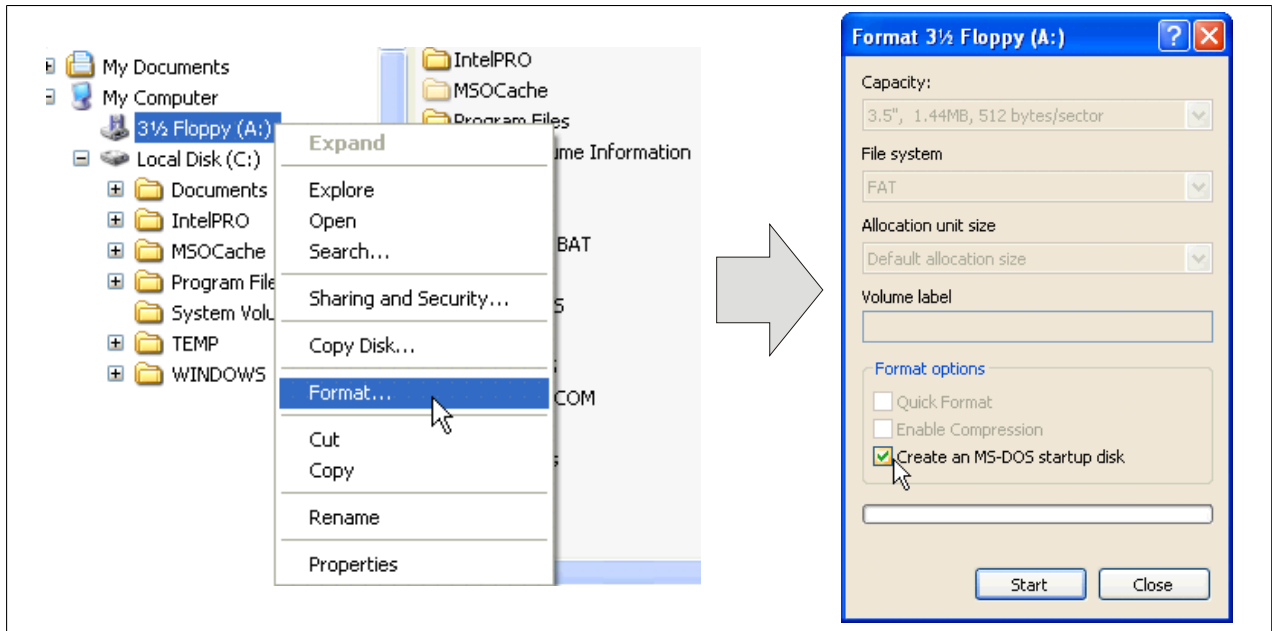

Figure 117: Creating a bootable diskette in Windows XP - Step 1

4. Select the **"Create an MS-DOS startup disk"** option, click on **"Start"** and acknowledge the warning message with "OK".



Figure 118: Creating a bootable diskette in Windows XP - Step 2



Figure 119: Creating a bootable diskette in Windows XP - Step 3

After creating the startup disk, some of the files must be deleted because of the size of the update.

To do this, all files (hidden system files, etc.) must be visible on the diskette.

In Windows Explorer, go to the "Tools" menu, select "Folder options" and open the "View" tab. Then deselect the option "Hide protected operating system files (Recommended)" (enabled by default) and enable the option "Show hidden files and folders".

before				after			
Name	Size	Type	Date Modified	Name	Size	Type	Date Modified
DISPLAY.SYS	17 KB	System file	6/8/2000 5:00 PM	AUTOEXEC.BAT	0 KB	MS-DOS Batch File	3/22/2006 10:08 AM
EGA2.CPI	58 KB	CPI File	6/8/2000 5:00 PM	COMMAND.COM	91 KB	MS-DOS Application	6/8/2000 5:00 PM
EGA3.CPI	58 KB	CPI File	6/8/2000 5:00 PM	CONFIG.SYS	0 KB	System file	3/22/2006 10:08 AM
EGA.CPI	58 KB	CPI File	6/8/2000 5:00 PM	DISPLAY.SYS	17 KB	System file	6/8/2000 5:00 PM
KEYB.COM	22 KB	MS-DOS Application	6/8/2000 5:00 PM	EGA2.CPI	58 KB	CPI File	6/8/2000 5:00 PM
KEYBOARD.SYS	34 KB	System file	6/8/2000 5:00 PM	EGA3.CPI	58 KB	CPI File	6/8/2000 5:00 PM
KEYBRD2.SYS	32 KB	System file	6/8/2000 5:00 PM	EGA.CPI	58 KB	CPI File	6/8/2000 5:00 PM
KEYBRD3.SYS	31 KB	System file	6/8/2000 5:00 PM	IO.SYS	114 KB	System file	5/15/2001 6:57 PM
KEYBRD4.SYS	13 KB	System file	6/8/2000 5:00 PM	KEYB.COM	22 KB	MS-DOS Application	6/8/2000 5:00 PM
MODE.COM	29 KB	MS-DOS Application	6/8/2000 5:00 PM	KEYBOARD.SYS	34 KB	System file	6/8/2000 5:00 PM
				KEYBRD2.SYS	32 KB	System file	6/8/2000 5:00 PM
				KEYBRD3.SYS	31 KB	System file	6/8/2000 5:00 PM
				KEYBRD4.SYS	13 KB	System file	6/8/2000 5:00 PM
				MODE.COM	29 KB	MS-DOS Application	6/8/2000 5:00 PM
				MSDOS.SYS	1 KB	System file	4/7/2001 1:40 PM

Figure 120: Creating a bootable diskette in Windows XP - Step 4

Name	Size	Type	Date Modified
AUTOEXEC.BAT	0 KB	MS-DOS Batch File	3/22/2006 10:08 AM
COMMAND.COM	91 KB	MS-DOS Application	6/8/2000 5:00 PM
CONFIG.SYS	0 KB	System file	3/22/2006 10:08 AM
DISPLAY.SYS	17 KB	System file	6/8/2000 5:00 PM
EGA2.CPI	58 KB	CPI File	6/8/2000 5:00 PM
EGA3.CPI	58 KB	CPI File	6/8/2000 5:00 PM
EGA.CPI	58 KB	CPI File	6/8/2000 5:00 PM
IO.SYS	114 KB	System file	5/15/2001 6:57 PM
KEYB.COM	22 KB	MS-DOS Application	6/8/2000 5:00 PM
KEYBOARD.SYS	34 KB	System file	6/8/2000 5:00 PM
KEYBRD2.SYS	32 KB	System file	6/8/2000 5:00 PM
KEYBRD3.SYS	31 KB	System file	6/8/2000 5:00 PM
KEYBRD4.SYS	13 KB	System file	6/8/2000 5:00 PM
MODE.COM	29 KB	MS-DOS Application	6/8/2000 5:00 PM
MSDOS.SYS	1 KB	System file	4/7/2001 1:40 PM

Figure 121: Creating a bootable diskette in Windows XP - Step 5

Now all files (selected) except Command.com, IO.sys and MSDOS.sys can be deleted.

2.4 Creating a bootable USB flash drive for B&R upgrade files

When used in connection with a B&R Industrial PC, it is possible to upgrade (e.g. BIOS) from one of the USB flash drives available from B&R. To do this, the USB flash drive must be prepared accordingly. This is done with the B&R Embedded OS Installer, which can be downloaded at no cost from the B&R website (www.br-automation.com).

2.4.1 Requirements

The following is required to create a bootable USB flash drive:

- B&R USB flash drive
- B&R Industrial PC
- USB media drive
- B&R Embedded OS Installer (V3.00 or higher)

2.4.2 Procedure

1. Connect the USB flash drive to the PC.
2. If the drive list is not refreshed automatically, update the list using the **Drives > Refresh** command.
3. Select the desired USB flash drive in the drive list.
4. Change to the **Action** tab and select **Install a B&R update to a USB flash drive** as the type of action.
5. Enter the path to the MS-DOS operating system files. If the files are part of a .zip archive, then click on the button **From .zip file**. If the files are stored in a directory on the hard drive, then click on the button **From folder**.
6. In the **B&R upgrade** text box, it is also possible to enter the path to the .zip file for the B&R upgrade disk and select the file.
7. Click on the **Start action** button in the toolbar.

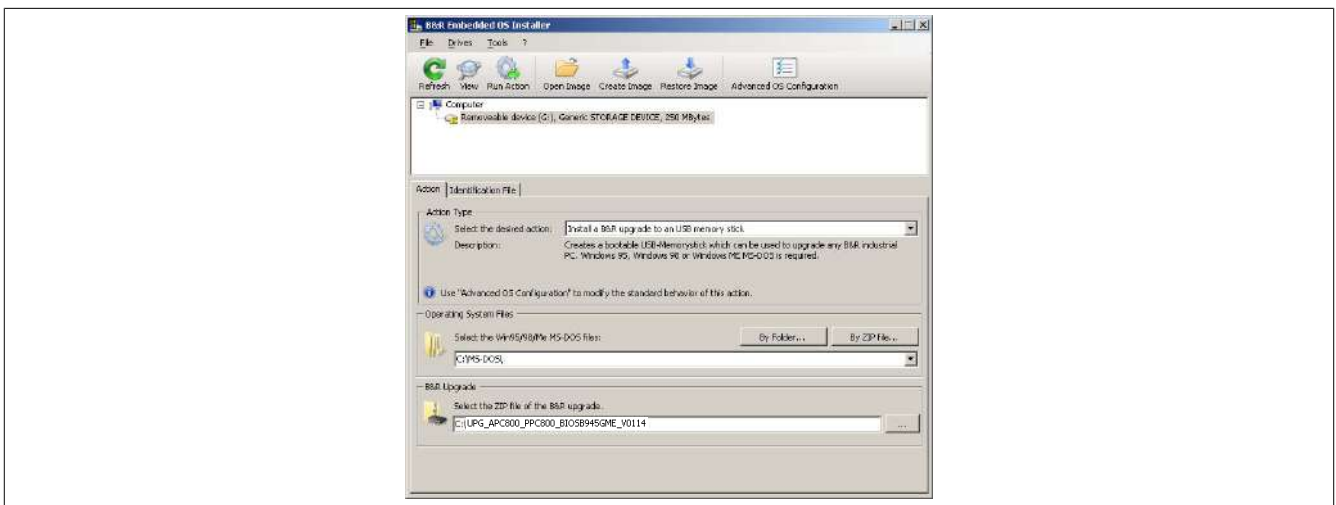

Figure 122: Creating a USB flash drive for B&R upgrade files

2.4.3 How to access MS-DOS

Information about creating an MS-DOS boot diskette can be found in section see "Creating an MS-DOS boot diskette in Windows XP" on page 201. The files from the diskette are then copied to the hard drive.

2.5 Creating a bootable CompactFlash card for B&R upgrade files

When used in connection with a B&R industrial PC, it is possible to upgrade (e.g. upgrade BIOS) from one of the CompactFlash cards available from B&R. To do this, the CompactFlash card must be prepared accordingly. This is done with the B&R Embedded OS Installer, which can be downloaded at no cost from the B&R website (www.br-automation.com).

2.5.1 Requirements

The following peripherals are required for creating a bootable CompactFlash card:

- CompactFlash card
- B&R Industrial PC
- USB media drive
- B&R Embedded OS Installer (at least V3.10)

2.5.2 Procedure

1. Insert the CompactFlash card in the CF slot on the industrial PC.
2. If the drive list is not refreshed automatically, the list can be updated using the command **Drives > Refresh**.
3. Select the desired CompactFlash card from the drive list.
4. Change to the **Action** tab and select **Install a B&R Update to a CompactFlash card** as the type of action.
5. Enter the path to the MS-DOS operating system files. If the files are part of a .zip archive, then click on the button **From .zip file**. If the files are stored in a directory on the hard drive, then click on the button **From folder**.
6. In the **B&R upgrade** text box, it is also possible to enter the path to the .zip file for the B&R upgrade disk and select the file.
7. Click on the **Start action** button in the toolbar.



Figure 123: Creating a CompactFlash card for B&R upgrade files

2.5.3 How to access MS-DOS

Information about creating an MS-DOS boot diskette can be found in section see "Creating an MS-DOS boot diskette in Windows XP" on page 201. The files from the diskette are then copied to the hard drive.

3 Microsoft DOS

3.1 Order data

Model number	Short description	Figure
	MS-DOS	
9S0000.01-010	OEM Microsoft MS-DOS 6.22, German floppy disks, only supplied together with a new PC	
9S0000.01-020	OEM Microsoft MS-DOS 6.22, English floppy disks, only supplied together with a new PC	

Table 166: 9S0000.01-010, 9S0000.01-020 - Order data

3.2 Known problems

Either no drivers are available for the following hardware components or only with limitations:

- HDA sound is not supported.
- USB 2.0: only USB 1.1 rates can be achieved.
- "Graphics engine 2" (for e.g. extended desktop mode) cannot be used.
- Some "ACPI control" functions in BIOS cannot be used.

3.3 Resolutions and color depths

The following table shows the tested resolutions and color depths on the monitor/panel interface with NM10 CPU boards.

Resolutions for RGB	Color depth		
	8-bit	16-bit	24-bit
640 x 480	✓	✓	✓
800 x 600	✓	✓	✓
1024 x 768	✓	✓	✓
1280 x 1024	✓	✓	✓
1600 x 1200	✓	✓	✓
1920 x 1200	✓	✓	✓

Table 167: Tested resolutions and color depths for RGB signals

4 Windows XP Professional

4.1 General information

Information:

Discontinuation of support for Windows XP by Microsoft:

After April 8th, 2014, Microsoft will no longer be providing any security updates, hotfixes, support (free or paid) or technical resources for Windows XP.

4.2 Order data

Model number	Short description	Figure
	Windows XP Professional	
5SWWXP.0600-GER	Windows XP Professional SP3 - German - CD	
5SWWXP.0600-ENG	Windows XP Professional SP3 - English - CD	
5SWWXP.0600-MUL	Windows XP Professional SP3 - Multilingual - CD	

Table 168: 5SWWXP.0600-GER, 5SWWXP.0600-ENG, 5SWWXP.0600-MUL - Order data

4.3 Overview

Model number	Edition	Target system	Chipset	Service pack	Language	Minimum hard disk space required	Minimum RAM required
5SWWXP.0600-GER	Professional	APC510 APC511 APC620 APC810 APC820 APC910 PPC700 PPC725 PPC800 PPC900 PP500	945GME GM45 QM77/HM76 NM10 US15W	SP3	German	≤2.1 GB	128 MB
5SWWXP.0600-ENG	Professional	APC510 APC511 APC620 APC810 APC820 APC910 PPC700 PPC725 PPC800 PPC900 PP500	945GME GM45 QM77/HM76 NM10 US15W	SP3	English	≤2.1 GB	128 MB
5SWWXP.0600-MUL	Professional	APC510 APC511 APC620 APC810 APC820 APC910 PPC700 PPC725 PPC800 PPC900 PP500	945GME GM45 QM77/HM76 NM10 US15W	SP3	Multilingual	≤2.1 GB	128 MB

4.4 Installation

B&R preinstalls the required Windows XP Professional version on the desired storage device (e.g. CompactFlash card, etc.). All of the drivers required for operation (graphics, network, etc.) are also installed in this process.

4.4.1 Installation on a PCI SATA RAID controller - 5ACPCI.RAIC-03, 5ACPCI.RAIC-05, 5ACPCI.RAIC-06

The following steps are necessary to install Windows XP Professional on a PCI SATA RAID controller:

1. Download the RAID driver from the B&R website www.br-automation.com and copy the files to a diskette.

2. Connect the media drive (5MD900.USB2-02) to the USB port.
3. Insert the diskette and Windows XP Professional CD in the media drive and boot from the CD.
4. Press the F6 key during installation to install a third-party SCSI or driver.
5. Press the "s" key when asked about installing an additional drive. Insert the diskette into the floppy drive. Press "Enter" and select the driver.
6. Follow the installation instructions.
7. The installer will copy the files to the Windows XP Professional folder and restart the B&R Industrial PC.

Information:

- **Not all USB FDD drives are supported by the Windows XP installer (see Microsoft KB 916196).**
- **Depending on the system, the boot order may have to be changed in BIOS.**

4.5 Drivers

Current drivers for all approved operating systems are available in the Downloads section of the B&R website (www.br-automation.com).

Information:

Required drivers can only be downloaded from the B&R website, not from manufacturer websites.

5 Windows 7

5.1 General information

Windows® 7 offers a wealth of innovative features and performance improvements. Faster switching to power saving mode, quicker restores, less memory usage and high-speed detection of USB devices are just a few of the advantages provided by Windows® 7. Both English and German are available in Windows® 7 Professional, while Windows® 7 Ultimate supports up to 35 different languages (up to 36 languages in Service Pack 1). Product activation is not necessary on B&R PCs, which is a huge advantage for simple logistical procedures relating to machine automation.

All of the Windows® operating systems offered by B&R are from the Microsoft Embedded division. This guarantees much longer availability, especially compared to products offered on the consumer market.

5.2 Order data

Model number	Short description	Figure
	Windows 7 Professional/Ultimate	
5SWWI7.1100-GER	Windows 7 Professional SP1 - 32-bit - German - DVD	
5SWWI7.1100-ENG	Windows 7 Professional SP1 - 32-bit - English - DVD	
5SWWI7.1300-MUL	Windows 7 Ultimate SP1 - 32-bit - Multilingual - DVD	

Table 169: 5SWWI7.1100-GER, 5SWWI7.1100-ENG, 5SWWI7.1300-MUL - Order data

5.3 Overview

Model number	Edition	Target system	Chipset	Service pack	Architecture	Language	Minimum hard disk space required	Minimum RAM required
5SWWI7.1100-GER	Professional	APC510 APC511 APC810 APC910 APC2100 PPC800 PPC900 PPC2100 PP500	945GME GM45 QM77/HM76 NM10 US15W Bay Trail	SP1	32-bit	German	16 GB	1 GB
5SWWI7.1100-ENG	Professional	APC510 APC511 APC810 APC910 APC2100 PPC800 PPC900 PPC2100 PP500	945GME GM45 QM77/HM76 NM10 US15W Bay Trail	SP1	32-bit	English	16 GB	1 GB
5SWWI7.1300-MUL	Ultimate	APC510 APC511 APC810 APC910 APC2100 PPC800 PPC900 PPC2100 PP500	945GME GM45 QM77/HM76 NM10 US15W Bay Trail	SP1	32-bit	Multilingual	16 GB ¹⁾	1 GB

1) The memory used by additional language packs is not taken into account in the minimum size of the disk.

5.4 Installation

B&R preinstalls the required Windows 7 version on the desired storage device (e.g. CompactFlash card, etc.). All of the drivers required for operation (graphics, network, etc.) are also installed in this process.

5.4.1 Installation on a PCI SATA RAID controller - 5ACPCI.RAIC-03, 5ACPCI.RAIC-05, 5ACPCI.RAIC-06

The following steps are necessary to install Windows 7 on a PCI SATA RAID controller:

1. Download the RAID driver for Windows 7 from the B&R website at www.br-automation.com and copy the data to a folder on a USB flash drive.
2. Boot using the Windows 7 DVD.
3. Follow the installation steps until a page appears asking "Where do you want to install Windows?".
4. Plug the USB flash drive with the RAID drivers into an available USB port.
5. Click on "Load driver" and navigate to the directory containing the RAID drivers. Then click Next to continue.
6. Remove the USB flash drive.
7. The Windows 7 installation can now be performed as usual.

Information:

Depending on the system, the boot order may have to be changed in BIOS.

5.5 Drivers

Current drivers for all approved operating systems are available in the Downloads section of the B&R website (www.br-automation.com).

Information:

Required drivers can only be downloaded from the B&R website, not from manufacturer websites.

5.6 Special considerations, limitations

- Windows 7 does not contain a Beep.sys file, which means that an audible signal is not sounded when pressing a key, for example.
- There is currently no support for the Windows 7 system rating (although this does not apply to PP500, APC2100, APC510, APC511, APC910, PPC2100 or PPC800 devices with an NM10 chipset).

5.7 Supported display resolutions

In accordance with Microsoft requirements, Windows 7 requires XGA resolution (1024 x 768) or higher in order to allow unimpeded operation of the Windows user interface (including system dialog boxes, etc.). A lower resolution can be selected for applications.

6 Windows Embedded Standard 2009

6.1 General information

Windows® Embedded Standard 2009 is the modular version of Windows® XP Professional. It is used if XP applications should be executed with a minimal operating system size. Together with CompactFlash memory, Windows® Embedded Standard 2009 makes it possible to use the Microsoft desktop operating system in harsh environmental conditions. In addition to the familiar features included in Windows® XP Professional, Windows® Embedded Standard 2009 has been improved with regard to dependability by adding a write filter for individual memory partitions. By protecting individual partitions such as the boot partition, the PC system can be started without problems even after an unexpected power failure. B&R offers complete images for industrial PCs, Power Panel and Mobile Panel devices to make the transition to Windows® Embedded Standard 2009 as easy as possible. In addition to Windows® Embedded Standard 2009, the standard Windows® XP Professional operating system is also available in English, German and a multilingual version.

Windows® Embedded Standard 2009 is based on the same binary files as Windows® XP Professional with Service Pack 3 and is optimally tailored to the hardware being used. In other words, only the functions and modules required by the respective device are included. Windows® Embedded Standard 2009 is also based on the same reliable code as Windows® XP Professional with SP3. It provides industry with leading reliability, security and performance improvements as well as the latest technology for web browsing and extensive device support.

6.2 PPC800 (NM10) - Order data

Model number	Short description	Figure
	Windows Embedded Standard 2009	
5SWWXP.0739-ENG	Microsoft OEM Windows Embedded Standard 2009, English; for PPC800 with NM10 chipset; order CompactFlash separately (at least 1 GB).	
	Required accessories	
	CompactFlash-cards	
5CFCRD.016G-06	CompactFlash 16 GB B&R (SLC)	
5CFCRD.1024-06	CompactFlash 1 GB B&R (SLC)	
5CFCRD.2048-06	CompactFlash 2 GB B&R (SLC)	
5CFCRD.4096-06	CompactFlash 4 GB B&R (SLC)	
5CFCRD.8192-06	CompactFlash 8 GB B&R (SLC)	

Table 170: 5SWWXP.0739-ENG - Order data

6.3 Overview

Model number	Target system	Chipset	Language	Minimum disk size	Minimum RAM required
5SWWXP.0739-ENG	PPC800	NM10	English	1 GB	256 MB

6.4 Features with WES2009 (Windows Embedded Standard 2009)

The following list of features shows the most important device functions included in Windows Embedded Standard 2009.

Function	Included?
Enhanced Write Filter (EWF)	✓
File-Based Write Filter (FBWF)	✓
Page file	Configurable
Administrator accounts	✓
User accounts	Configurable
Explorer shell	✓
Registry filter	✓
Internet Explorer 8.0	✓
Internet Information Service (IIS)	-
Terminal service	✓
Windows Firewall	✓
MSN Explorer	-
Outlook Express	-
Administrative Tools	✓
Remote Desktop	✓
Remote Assistance	-
.NET Framework	-
ASP.NET	-
OpenGL support	✓
Local network bridge	✓

Table 171: Device functions in Windows Embedded Standard 2009

Function	Included?
Codepages / User locales / Keyboards	✓
Disk Management Service	✓
Windows Installer Service	✓
Class Installer	✓
CoDevice Installer	✓
Media Player 64	✓
DirectX 9.0c	✓
Accessories	✓
Number of fonts	89

Table 171: Device functions in Windows Embedded Standard 2009

6.5 Installation

Windows Embedded Standard 2009 is already preinstalled on a suitable CompactFlash card by B&R (minimum 1 GB). The system is then automatically configured when it is switched on for the first time. This procedure takes approximately 10 minutes, with the device being rebooted a number of times.

6.6 Drivers

All drivers required for operation are preinstalled along with the operating system. If an older version of a driver is still being used, its latest version can be downloaded and installed from the B&R website (www.br-automation.com). It is important that Enhanced Write Filter (EWF) is disabled for this.

6.6.1 Touch screen driver

In order to operate Automation Panel 800 or Automation Panel 900 touch screen devices, the touch screen driver must be installed manually or the touch screen interface updated in the device manager. The driver is available in the Downloads section of the B&R website (www.br-automation.com). It is important that Enhanced Write Filter (EWF) is enabled for this.

Information:

Required drivers can only be downloaded from the B&R website, not from manufacturer websites.

6.7 Supported display resolutions

In accordance with Microsoft requirements, Windows Embedded Standard 2009 requires SVGA resolution (800 x 600) or higher in order to allow unimpeded operation of the Windows user interface (including system dialog boxes, etc.). A lower resolution can be selected for applications.

7 Windows Embedded Standard 7

7.1 General information

The successor to Windows® XP Embedded is Windows® Embedded Standard 7. As with previous versions, this embedded operating system offers full system support for B&R Industrial PCs. In addition to brand new features that are also included in Windows® 7 Professional, Windows® Embedded Standard 7 includes embedded components such as Enhanced Write Filter, File-Based Write Filter, Registry Filter and USB Boot. Windows® Embedded Standard 7 is available in two different versions. The main difference between them has to do with multilingual support. Windows® Embedded Standard 7 is only available in a single language, whereas Windows® Embedded Standard 7 Premium supports the installation of several languages simultaneously.

With Windows® Embedded Standard 7, Microsoft has made substantial improvements in the area of security. The AppLocker program, available in the premium version, can prevent the execution of unknown or potentially undesired applications that are being installed over a network or from drives that are directly connected. A tiered approach allows the differentiation between scripts (.ps1, .bat, .cmd, .vbs and .js), installation files (.msi, .msp) and libraries (.dll, .ocx). AppLocker can also be configured to record undesired activity and display it in the Event Viewer. Windows® Embedded Standard 7 is available as both a 32-bit and 64-bit version³⁾, which ensures that even the most demanding applications have the level of support they need.

7.2 PPC800 (NM10) - Order data

Model number	Short description	Figure
	Windows Embedded Standard 7	
5SWWI7.1539-ENG	Microsoft OEM Windows Embedded Standard 7 32-bit, Service Pack 1, English; for PPC800 with NM10 chipset; order CompactFlash separately (at least 16 GB).	
5SWWI7.1739-MUL	Microsoft OEM Windows Embedded Standard 7 Premium 32-bit, Service Pack 1, multilingual; for PPC800 with NM10 chipset; order CompactFlash separately (at least 16 GB).	
	Required accessories	
	CompactFlash-cards	
5CFCRD.016G-06	CompactFlash 16 GB B&R (SLC)	
	Optional accessories	
	Windows Embedded Standard 7	
5SWWI7.1900-MUL	Windows Embedded Standard 7 SP1 - 32-bit - Language Pack DVD	

Table 172: 5SWWI7.1539-ENG, 5SWWI7.1739-MUL - Order data

7.3 Overview

Model number	Edition	Target system	Chipset	Service pack	Architecture	Language	Minimum disk size	Minimum RAM required
5SWWI7.1539-ENG	Embedded	PPC800	NM10	SP1	32-bit	English	16 GB	1 GB
5SWWI7.1739-MUL	Premium	PPC800	NM10	SP1	32-bit	Multilingual	16 GB ¹⁾	1 GB

1) The memory used by additional language packs is not taken into account in the minimum size of the disk.

7.4 Features with WES7 (Windows Embedded Standard 7)

The feature list displays the essential device functions and differences in Windows Embedded Standard 7 and Windows Embedded Standard 7 Premium.

Function	Windows Embedded Standard 7	Windows Embedded Standard 7 Premium
Enhanced Write Filter (EWF)	✓	✓
File-Based Write Filter (FBWF)	✓	✓
Administrator accounts	✓	✓
User accounts	Configurable	Configurable
Windows Explorer shell	✓	✓
Registry filter	✓	✓
Internet Explorer 8.0	✓	✓
Internet Information Service (IIS) 7.0	✓	✓
Anti-malware (Windows Defender)	-	✓
Add-ons (Snipping Tool, Sticky Notes)	-	✓
Windows Firewall	✓	✓
.NET Framework 3.5	✓	✓
Remote Desktop Protocol 7.0	✓	✓
File Compression Utility	✓	✓
Windows Installer Service	✓	✓

Table 173: Device functions in Windows Embedded Standard 7

³⁾ 64-bit versions are not supported by all systems.

Function	Windows Embedded Standard 7	Windows Embedded Standard 7 Premium
Windows XP mode	-	-
Media Player 12	✓	✓
DirectX	✓	✓
Multilingual user interface packs in the same image	-	✓
International components and language services	✓	✓
Language pack setup	✓	✓
Windows update	Configurable	Configurable
Windows PowerShell 2.0	✓	✓
BitLocker	-	✓
AppLocker	-	✓
Tablet PC support	-	✓
Multitouch Support	-	✓
Boot from USB flash drive	✓	✓
Accessories	✓	✓
Page file	Configurable	Configurable
Number of fonts	134	134

Table 173: Device functions in Windows Embedded Standard 7

7.5 Installation

Windows Embedded Standard 7 wird schon im Hause B&R auf einer geeigneten CompactFlash-Karte (mind. 8 GByte bzw. 16 GByte) vorinstalliert. The system is then automatically configured when it is switched on for the first time. Dieser Vorgang nimmt ca. 30 Minuten in Anspruch und das Gerät wird dabei einige Male automatisch rebootet.

Information:

If Enhanced Write Filter (EWF) should be used, all mass storage devices should be disconnected from the system during installation or SYSPREP (except for the boot drive). It is also possible to disable additional mass storage devices in BIOS.

7.6 Drivers

All drivers required for operation are preinstalled along with the operating system. If an older version of a driver is still being used, its latest version can be downloaded and installed from the B&R website (www.br-automation.com). It is important that Enhanced Write Filter (EWF) is disabled for this.

7.6.1 Touch screen driver

A touch screen driver will be installed automatically if a touch controller is detected during the Windows Embedded Standard 7 installation. If a touch controller is not detected during Windows Embedded Standard 7 installation or a B&R Automation Panel is connected at a later time, then the touch screen driver needs to be installed manually or the additional touch screen interface must be selected in the touch screen settings in the Windows Control Panel. The driver is available in the Downloads section of the B&R website (www.br-automation.com). It is important that both Enhanced Write Filter (EWF) and File Based Write Filter (FBWF) are disabled for this.

Information:

Required drivers can only be downloaded from the B&R website, not from manufacturer websites.

7.7 Supported display resolutions

In accordance with Microsoft requirements, Windows Embedded Standard 7 requires XGA resolution (1024 x 768) or higher in order to allow unimpeded operation of the Windows user interface (including system dialog boxes and apps, etc.). A lower resolution can be selected for applications.

8 Automation Runtime

8.1 General information

An integral component of Automation Studio is the Automation Runtime real-time operating system. This real-time operating system is the software kernel that allows applications to run on a target system.

- Guaranteed highest possible performance for the hardware being used
- Runs on all B&R target systems
- Makes the application hardware-independent
- Easy portability of applications between B&R target systems
- Deterministic behavior guaranteed by cyclic system
- Configurable jitter tolerance in all task classes
- Supports all major programming languages such as IEC 61131-3 and C
- Extensive function library conforming to IEC 61131-3 as well as the expanded B&R Automation library
- Integrated into Automation NET. Access to all networks and bus systems via function calls or the Automation Studio™ configuration

B&R Automation Runtime is fully embedded in the corresponding target system (the hardware where Automation Runtime is installed). It allows application programs to access I/O systems (e.g. via the fieldbus) and other devices (interfaces, networks, etc.).

8.2 Order data

Model number	Short description	Figure
	Automation Runtime	
0TG1000.01	Technology Guard	
1TG4600.10-5	Automation Runtime Windows, TG license	

Table 174: 0TG1000.01, 1TG4600.10-5 - Order data

8.3 Automation Runtime Windows (ARwin)

System requirements

The following software versions (or higher) are required to operate Automation Runtime Windows on a Panel PC 800:

- ARwin upgrade AR 4.02
- Automation Studio V3.0.90
- Technology Guard

Information:

In order to use Automation Runtime Windows (ARwin), the BIOS setting *Advanced - Realtime environment* must be set to *Enabled*.

Information:

In ARwin 4.06 ist kein gleichzeitiger ADI-Zugriff aus Windows und ARwin mehr möglich, da die ADI-Schnittstelle von ARwin gesperrt wird.

Um von Windows und ARwin gleichzeitig auf die ADI-Schnittstelle zugreifen zu können sind folgende Komponenten erforderlich:

- ADI Treiber V1.8 (oder höher)
- ARwin I4.06 (oder höher)

8.4 Technology Guarding

Technology Guarding is a licensing approach used to safeguard individual software components. Licenses are stored on a "Technology Guard" (also referred to simply as a dongle), which is connected to an available USB interface on the target system.

The B&R software components Automation Runtime Embedded (ARemb), Automation Runtime Windows (ARwin) and Automation Runtime Embedded Terminal require a license, so a Technology Guard must always be used.

Information:

Licensing with the Technology Guarding wizard is available in Automation Studio 4.1 and Automation Runtime 4.08 and higher. Earlier versions of Automation Runtime do not require a Technology Guard.

Additional information about Technology Guarding can be found in the Automation Studio help system.

9 B&R Automation Device Interface (ADI) - Control Center

The ADI (Automation Device Interface) enables access to specific functions on B&R devices. Settings for devices can be read and configured using the B&R Control Center applet in the Control Panel.

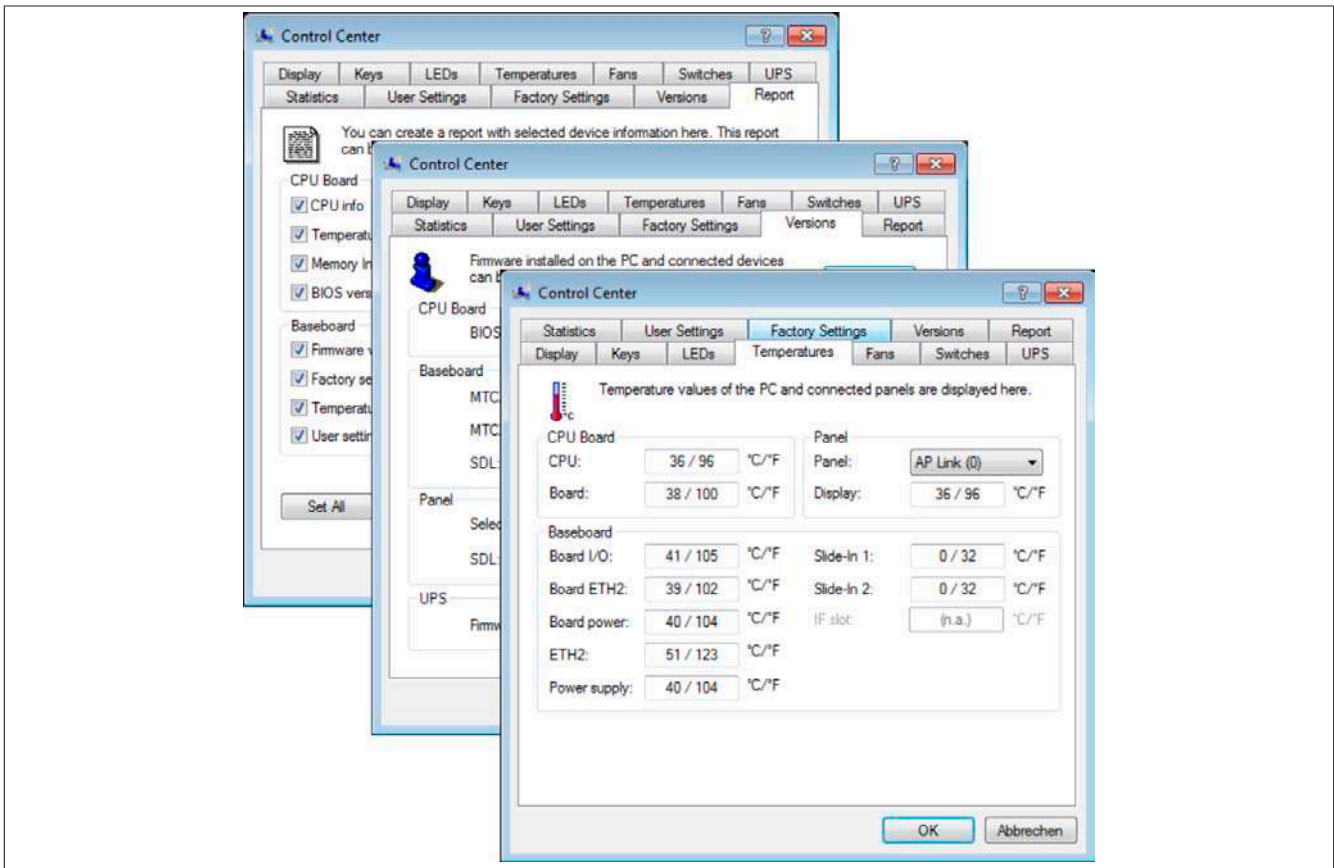

Figure 124: ADI Control Center screenshots - Examples

Information:

The temperature and voltage values (e.g. CPU temperature, core voltage, battery voltage) shown in the corresponding ADI window represent uncalibrated values for informational purposes. They cannot be used to draw any conclusions about hardware alarms or error conditions. The hardware components used have automatic diagnostic functions that can be applied in the event of error.

9.1 Functions

Information:

The functions provided by the Automation Device Interface (ADI) - Control Center vary according to the device series.

- Changing display-specific parameters
- Reading device-specific keys
- Updating the key configuration
- Enabling device-specific LEDs on a membrane keypad or keys
- Reading and calibrating control devices (e.g. key switches, handwheels, joysticks, potentiometers)
- Reading temperatures, fan speeds, statistical data and switch settings
- Reading operating hours (power-on hours)
- Reading user and factory settings
- Reading software versions
- Updating and backing up BIOS and firmware
- Creating reports about the current system (support assistance)
- Setting the SDL equalizer value when adjusting SDL cables
- Changing the user serial ID

Supports the following systems:

- Automation PC 510
- Automation PC 511
- Automation PC 620
- Automation PC 810
- Automation PC 820
- Automation PC 910
- Automation PC 2100
- Panel PC 300
- Panel PC 700
- Panel PC 725
- Panel PC 800
- Panel PC 900
- Panel PC 2100
- Power Panel 100/200
- Power Panel 300/400
- Power Panel 500
- Mobile Panel 40/50
- Mobile Panel 100/200
- Connected Automation Panel 800
- Connected Automation Panel 900

9.2 Installation

A detailed description of the Control Center can be found in the integrated help system. The B&R Automation Device Interface (ADI) driver (also contains Control Center) is available at no charge in the Downloads section of the B&R website (www.br-automation.com).

1. Download and unzip the .zip archive.
2. Close all applications.
3. Run the Setup.exe file (e.g. double-click on it in Explorer).

Information:

The ADI driver is already included in B&R images of embedded operating systems.

If a more current ADI driver version exists (see the Downloads section of the B&R website), it can be installed later. It is important that Enhanced Write Filter (EWF) is disabled for this.

9.3 SDL Equalizer settings

1. Open the **Control Center** in the **Control Panel**.
2. Select the **Display** tab.
3. Click on **Settings**. This opens the following window:

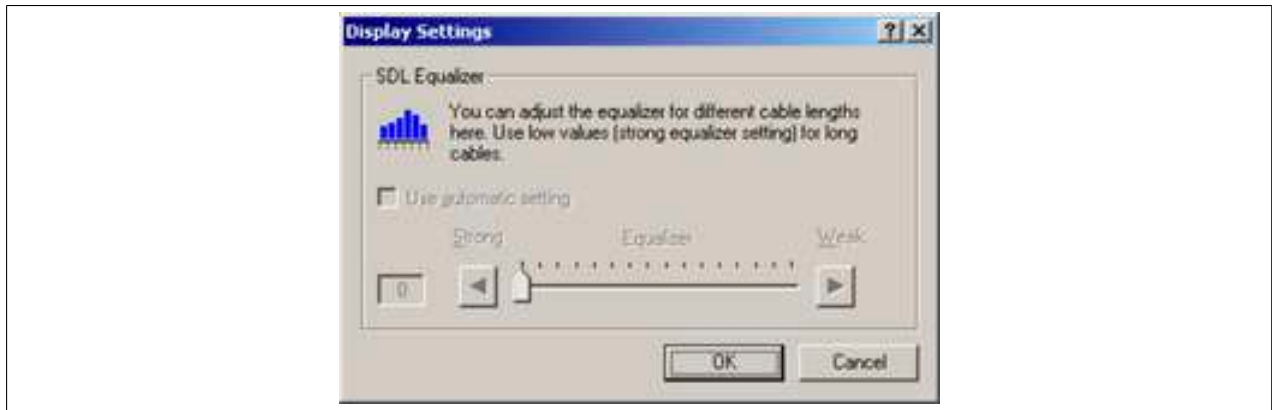

Figure 125: ADI Control Center - SDL Equalizer settings

The settings in this window can be used to configure the SDL Equalizer settings for the display. The equalizer is integrated into Automation Panel devices and adapts the DVI signal to different cable lengths. The equalizer value is automatically calculated based on the cable length. It is possible to set a different equalizer value in order to obtain the best possible display quality (e.g. in the event of low-quality cables or poor DVI signal quality).

The optimal value for the cable length is defined by selecting "Use automatic setting".

The equalizer value can only be changed if the function is supported by Automation Panel 900 (Panel firmware version 1.04 or higher).

9.4 UPS configuration

This window displays the status values for an optionally installed B&R add-on UPS and allows the battery settings for the UPS to be edited, updated and backed up. It is also possible to configure the system settings for the UPS.

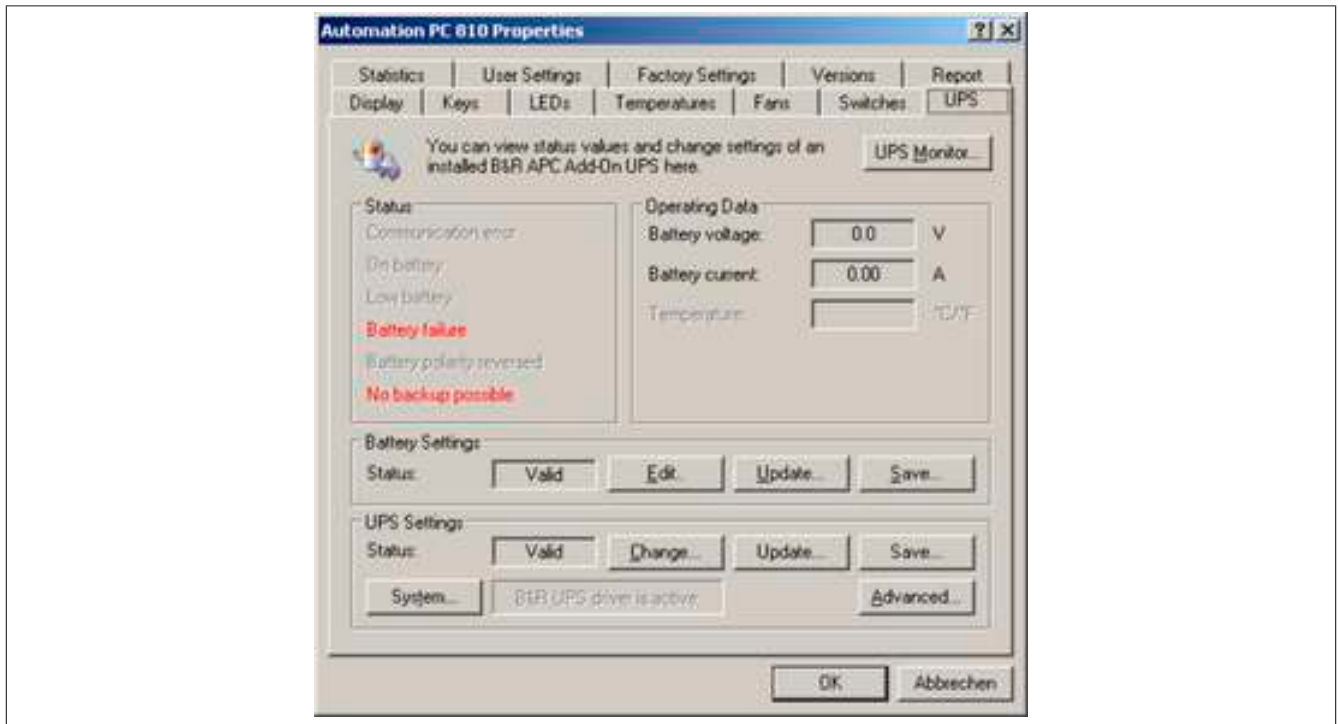

Figure 126: ADI Control Center - UPS settings

Caution!

The installed UPS must be selected and configured in the Power Options section of the Control Panel in order for battery operation to be supported.

Information:

The UPS service is supported in B&R Windows Embedded Version 2.10 and higher.

9.4.1 Installing the UPS service for the B&R add-on UPS

1. Open the **Control Center** in the **Control Panel**.
2. Select the **UPS** tab.
3. Under **UPS settings**, click on **System**. This opens the **Power options** in the Control Panel (**Power options** can also be opened directly from the **Control Panel**).
4. Go to the **UPS** tab and click **Select**.
5. Select "Bernecker + Rainer" as the manufacturer and "APC add-on UPS" as the model and then click **Finish**. The value for the COM connection is only required for a serially connected UPS and is ignored by the APC add-on UPS driver.
6. Click on **Apply** to start the UPS service. The UPS status and details will be displayed after a few seconds.
7. Click **OK**.

The text field next to **System** (on the **UPS** tab in the **Control Center**) also indicates whether the B&R UPS driver is active.

Information:

Administrator rights are required in order to change the energy options or display the UPS status.

9.4.2 Displaying UPS default values

1. Open the **Control Center** in the **Control Panel**.
2. Select the **UPS** tab.

The displayed values are updated automatically.

Information:

The status "Reversed battery polarity" is only displayed if using UPS firmware version 1.08 or higher. With UPS firmware versions 1.07 and older, switching between battery operation and normal operation can lead to a communication error.

3. Select "UPS monitor" to display UPS status changes since the last time the system or UPS driver was started.

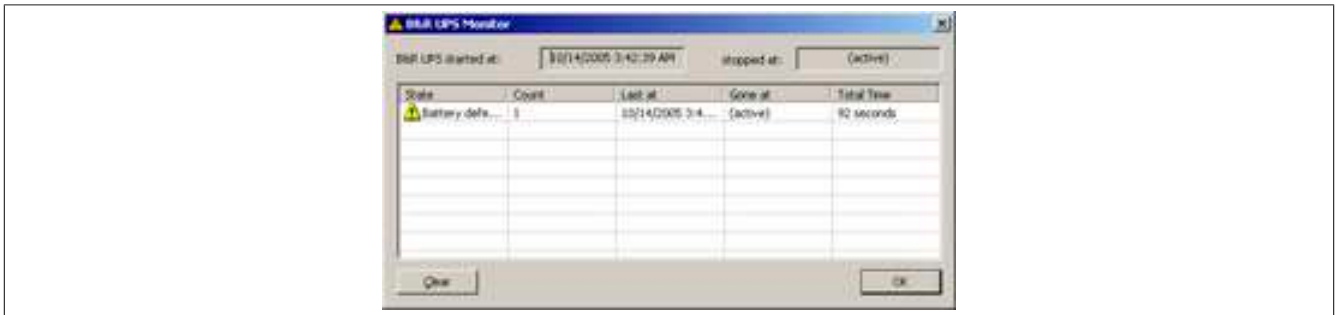

Figure 127: ADI Control Center - UPS monitor

The window is updated automatically when the status changes.

To remove a status from the list, click on **Clear**.

Information:

The current status of the UPS is also displayed on the UPS page in the power options when the UPS service is started in the Windows Control Panel.

Information:

In a German version of Windows XP Professional the battery status is shown as "Low" in the power options even if the battery is OK (Windows error). In an English version, three battery status levels are displayed: unknown, OK and replace. A low battery status is never displayed.

9.4.3 Changing UPS battery settings

1. Open the **Control Center** in the **Control Panel**.
2. Select the **UPS** tab.
3. Under **Battery settings**, click on **Edit**. This opens the "Open" dialog box.
4. Select and **open** the file containing the battery settings.



Figure 128: ADI Control Center - UPS battery settings

This window can be used to change the settings for the UPS battery.

Click **OK** to write the changed settings to the file. The battery settings for the UPS can then be updated with this file.

Information:

To make settings for non-B&R batteries, it is best to make a copy of a file that contains battery settings from B&R under a new name and then adjust the settings in this new file for the battery being used.

Current files with settings for batteries from B&R can be updated using B&R's "Upgrade PPC800 MTCX" software.

Information:

- The current UPS firmware version 1.10 does not use charge end voltage, deep discharge voltage, service life and deep discharge cycles.
- Service life is only included in version 2 (and higher) of the UPS battery settings and only valid for B&R UPS batteries at 25°C ambient temperature.
- Deep discharge cycles are only included in version 3 (and higher) of the UPS battery settings and only valid for UPS batteries from B&R.

Information:

To change the current battery settings on the UPS, they must first be saved to a file.

9.4.4 Updating UPS battery settings

1. Open the **Control Center** in the **Control Panel**.
2. Select the **UPS** tab.
3. Under **Battery settings**, click on **Update**. Clicking on "Open" opens a dialog box.
4. Select and **open** the file containing the battery settings. The "Download" dialog box is opened.

The transfer can be canceled by clicking on **Cancel**. "Cancel" is disabled when writing to flash memory.

Information:

- The UPS cannot be operated while the battery settings are being updated.
- If the transfer is aborted, then the procedure must be repeated until the battery settings have been updated successfully. Otherwise, battery operation will no longer be possible.

Deleting the data in flash memory can take several seconds depending on the memory block being used. The progress indicator is not updated during this time.

Information:

The UPS is automatically restarted after a successful download. This can cause a brief failure in the UPS communication.

9.4.5 Saving UPS battery settings

1. Open the **Control Center** in the **Control Panel**.
2. Select the **UPS** tab.
3. Under "Battery settings", click on **Save**. This opens the "Save as" window.
4. Enter a filename or select an existing file and click on **Save**.

Information:

UPS settings can only be saved with UPS firmware version 1.10 and higher.

The transfer can be aborted by clicking on **Cancel** in the Download dialog box.

9.4.6 Configuring UPS system settings

1. Open the **Control Center** in the **Control Panel**.
2. Select the **UPS** tab.
3. Under **UPS settings**, click on **Change**. This opens the following window:

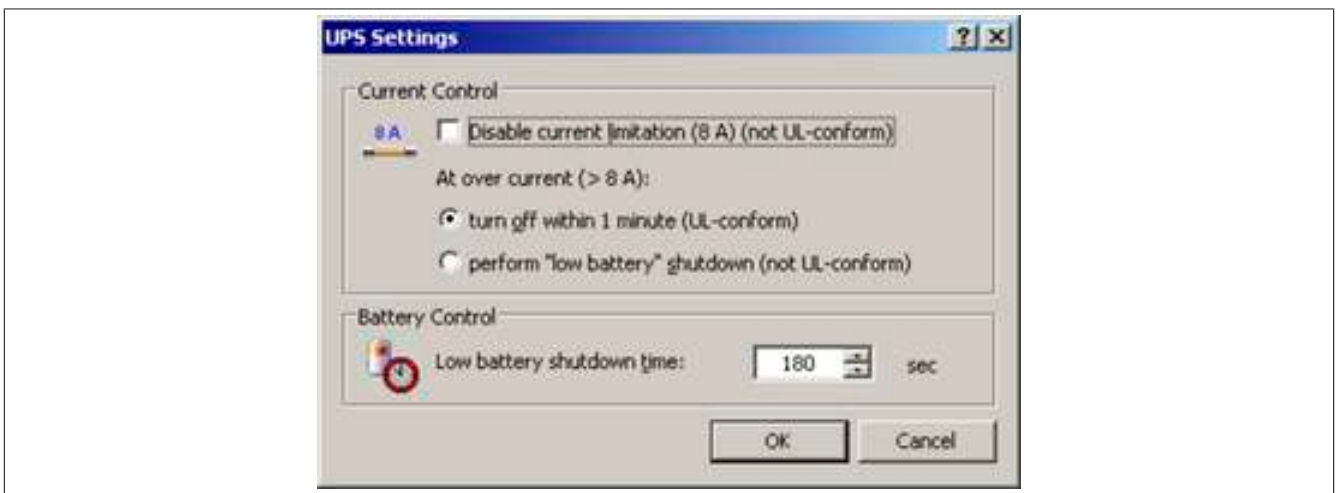

Figure 129: ADI Control Center - UPS settings

Additional information regarding UPS system settings can be found in the Windows help documentation.

Information:

- **UPS settings can only be changed with UPS firmware version 1.10 and higher. If there are no modified settings on the UPS, then the factory or default settings are used.**
- **The UPS is automatically restarted after the UPS settings have been changed. This can cause a brief disruption in communication with the UPS.**
- **Administrator rights are required in order to change the energy options or display the UPS status.**

9.4.6.1 Disabling 8 A current limitation

Information:

It is not UL-compliant to switch off the 8 A current limitation on devices during battery operation!

"Low battery" shutdowns caused by overcurrent >8 A on devices running on the battery are not UL compliant!

Select the checkbox **Disable current limitation (8 A)**.

If current limitation is enabled (checkbox not selected), then the UPS uses battery operation to check whether the UPS battery is discharged with 8 A for longer than 16 seconds. If so, then an overcurrent alarm is sent to the PC.

Information:

Current limitation is only supported with UPS firmware version 1.10 and higher.

Enabling one of the two following options determines how the UPS should perform when an overcurrent alarm occurs:

If **Turn-off within 1 minute** is selected, then the UPS will be switched off within one minute when an overcurrent alarm occurs.

Warning!

The operating system will not be properly shut down if an overcurrent alarm occurs!

If **Perform "low battery" shutdown** is selected, then the UPS will also signal a "Low battery alarm" in addition to the overcurrent alarm and will be switched off after the defined **Low battery shutdown time**. This will allow the operating system to shut down properly when the UPS service is enabled.

9.4.6.2 Changing the shutdown time of the UPS when the battery is low

Enter the **Low battery shutdown time** in seconds. This is the amount of time that the UPS will wait before shutting off the power supply when the battery level is low.

This prevents the UPS battery from becoming too low if the Windows UPS service is not enabled to have the operating system turn off the UPS.

If the UPS service is enabled, then the UPS will be turned off by the operating system in accordance with the **Shutdown time** UPS service in Windows (see "Changing additional UPS settings" on page 223) when the battery level is low. The **Low battery shutdown time** will then be ignored.

Information:

- The low battery shutdown time must be set to at least 60 seconds so that the operating system has enough time to send the shutdown command to the UPS when the battery level is low (normally occurs after approximately 30 seconds).
- The low battery shutdown time can only be set with UPS firmware version 1.10 and higher. UPS firmware version 1.08 always uses a switch-off delay of 180 seconds. UPS firmware versions older than 1.08 do not shut down automatically when the battery level is low.

9.4.7 Changing additional UPS settings

1. Open the **Control Center** in the **Control Panel**.
2. Select the **UPS** tab.
3. Under **UPS settings**, click on **Advanced**. This opens the following window:



Figure 130: ADI Control Center - Advanced UPS settings

Information:

Administrator rights are required in order to display this window.

9.4.7.1 Changing the UPS shutdown time

The **Turn off delay** can be entered under **Windows UPS service** in seconds. This is the length of time that the UPS waits before switching off the power supply. When a critical alarm occurs (e.g. low battery level), the Windows UPS service will send a shutdown command with the turn off delay time to the UPS and shut down the system.

Information:

This time is evaluated by the **Windows UPS Service** but cannot be set in the **UPS system settings** of the power options. This value should only be changed if the system requires longer than the default setting of 180 seconds to shut down.

Caution!

The time entered must be longer than the time required to shut down the operating system.

9.4.7.2 Enabling UPS notifications

Under **B&R UPS driver**, enable the checkbox **Show notifications for UPS status**. Any changes to the UPS status will then trigger a message from the B&R UPS driver.

Information:

Shutting down the system is only reported by the **Windows UPS service**. The **UPS service** also sends other notifications if so enabled in the **UPS system settings** in the power options. These messages are only displayed when the **Windows Messenger service**⁴⁾ is active and the PC is connected to a network. In addition, some conditions of the **B&R add-on UPS** are not detected by the **Windows UPS Service** and therefore do not trigger messages (e.g. when there are no battery settings on the UPS). Windows services can be found by opening the **Control Panel** and selecting **"Services"** under **"Administrative tools"**.

If the checkbox **Show UPS status with UPS monitor** is also enabled, a new message is not displayed for every change. Instead, only a general message and request to start the **B&R UPS monitor** are shown. As long as the UPS monitor is active, no new messages will be displayed.

Information:

Regardless of these options, all changes to the **UPS status** are logged in the **Windows event log** (under **"Application"**).

⁴⁾ The Windows Messenger service is supported starting with B&R Windows Embedded version 2.20 and higher.

9.4.8 Procedure following power failure

9.4.8.1 Overcurrent shutdown

If overcurrent >8 A is present during battery operation for a duration of 16 seconds, then an overcurrent shutdown takes place. A switch-off time of one minute is available to the system.

If power returns during this time, then the shutdown process is aborted.

Information:

Overcurrent shutdown has the highest priority.

9.4.8.2 Low battery shutdown

If the LowBatteryFlag is set during power failure, then a "low battery" shutdown is performed to prevent the battery from fully discharging. Once the switch-off time expires (3 minutes by default), the UPS shuts down.

If an "overcurrent" shutdown or "standard" shutdown is detected during the shutdown process, the "low battery" shutdown is replaced by the respective process.

9.4.8.3 Standard shutdown

The standard shutdown is in effect whenever the UPS service is active; the switch-off time is 3 minutes by default.

If power returns during the switch-off time, then the shutdown procedure is aborted.

If power returns during the shutdown process, then the shutdown timer will run until the B&R Industrial PC enters standby mode, at which point the system will be rebooted.

10 B&R Automation Device Interface (ADI) Development Kit

This software can be used to access B&R Automation Device Interface (ADI) functions directly from Windows applications created in one of the following development environments:

- Microsoft Visual C++ 6.0
- Microsoft Visual Basic 6.0
- Microsoft Embedded Visual C++ 4.0
- Microsoft Visual Studio 2008 (or newer)

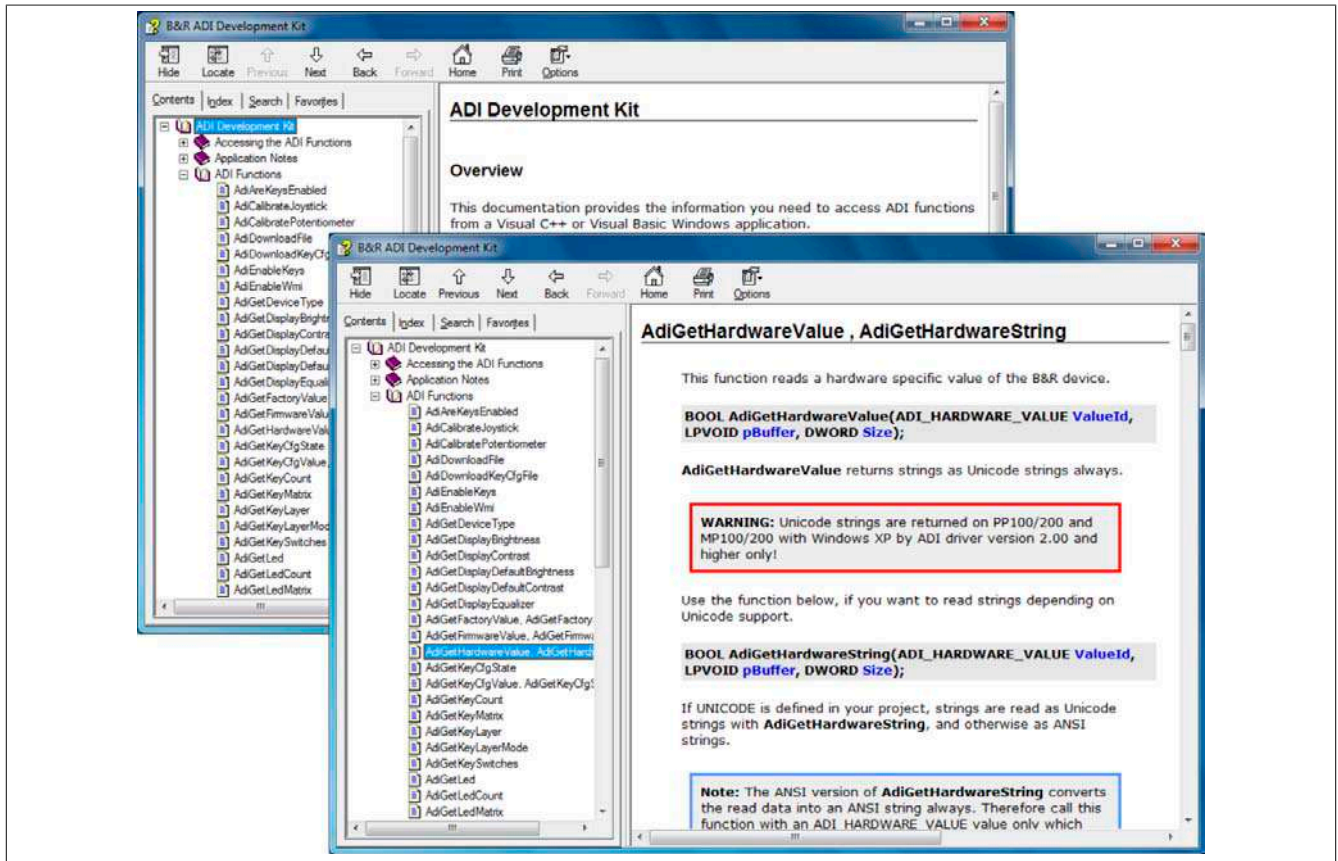

Figure 131: ADI Development Kit Screenshots (Version 3.70)

Features:

- One Microsoft Visual Basic module with ADI function declarations
- Header files and import libraries for Microsoft Visual C++
- Help files for Visual Basic and Visual C++
- Sample projects for Visual Basic and Visual C++
- ADI DLL (for application testing if no ADI driver is installed)

The following systems are supported (version 3.70 and higher):

- Automation PC 510
- Automation PC 511
- Automation PC 620
- Automation PC 810
- Automation PC 820
- Automation PC 910
- Automation PC 2100
- Panel PC 300
- Panel PC 700
- Panel PC 800
- Panel PC 900
- Panel PC 2100

- Power Panel 100/200
- Power Panel 300/400
- Power Panel 500
- Mobile Panel 40/50
- Mobile Panel 100/200

The ADI driver installed on the stated product series must be suitable for that device. The ADI driver is already included in B&R images of embedded operating systems.

A detailed description of how to use ADI functions can be found in the help system.

The B&R Automation Device Interface (ADI) development kit is available at no cost in the Downloads section of the B&R website (www.br-automation.com).

11 B&R Automation Device Interface (ADI) .NET SDK

This software can be used to access B&R Automation Device Interface (ADI) functions directly from .NET applications created using Microsoft Visual Studio 2005 or later.

Supported programming languages:

- Visual Basic
- Visual C++
- Visual C#

System requirements

- Development system: PC with Windows XP or Windows 7 and
 - Microsoft Visual Studio 2005 (or newer)
 - Microsoft .NET Framework 2.0 and/or Microsoft .NET Compact Framework 2.0 (or newer)

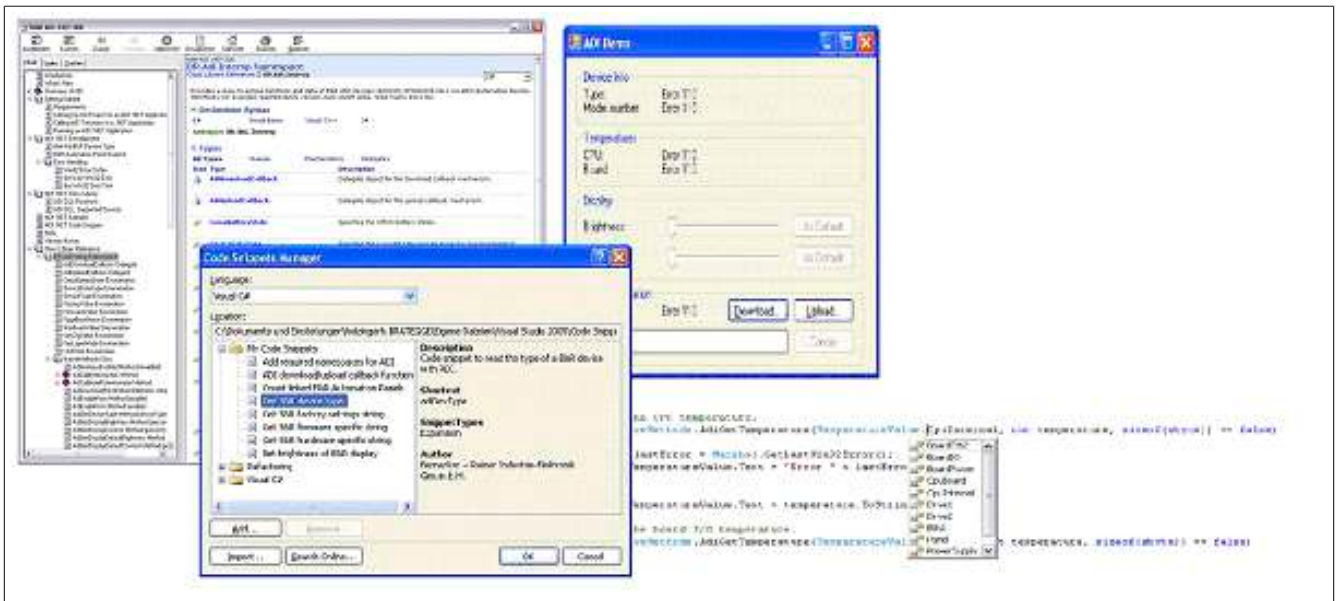

Figure 132: ADI .NET SDK screenshots (version 2.10)

Features (version 2.10 and higher)

- ADI .NET class library
- Help files in HTML Help 1.0 format (.chm), MS Help 2.0 format (.HxS) and MS Help Viewer format (.MSHC) (help documentation is in English only)
- Sample projects and code snippets for Visual Basic, Visual C++ and Visual C#
- ADI DLL (for application testing if no ADI driver is installed)

The following systems are supported (version 2.10 and higher):

- Automation PC 510
- Automation PC 511
- Automation PC 620
- Automation PC 810
- Automation PC 820
- Automation PC 910
- Automation PC 2100
- Panel PC 300
- Panel PC 700
- Panel PC 800
- Panel PC 900
- Panel PC 2100
- Power Panel 100/200
- Power Panel 300/400

- Power Panel 500
- Mobile Panel 40/50
- Mobile Panel 100/200

The ADI driver installed on the stated product series must be suitable for that device. The ADI driver is already included in B&R images of embedded operating systems.

A detailed description of how to use ADI functions can be found in the help system.

The ADI .NET SDK is available in the Downloads section of the B&R website (www.br-automation.com).

12 B&R Key Editor

On display devices, it is often necessary to adapt the function keys and LEDs directly to the application software being used. The B&R Key Editor makes it quick and easy to implement a unique configuration for the application.

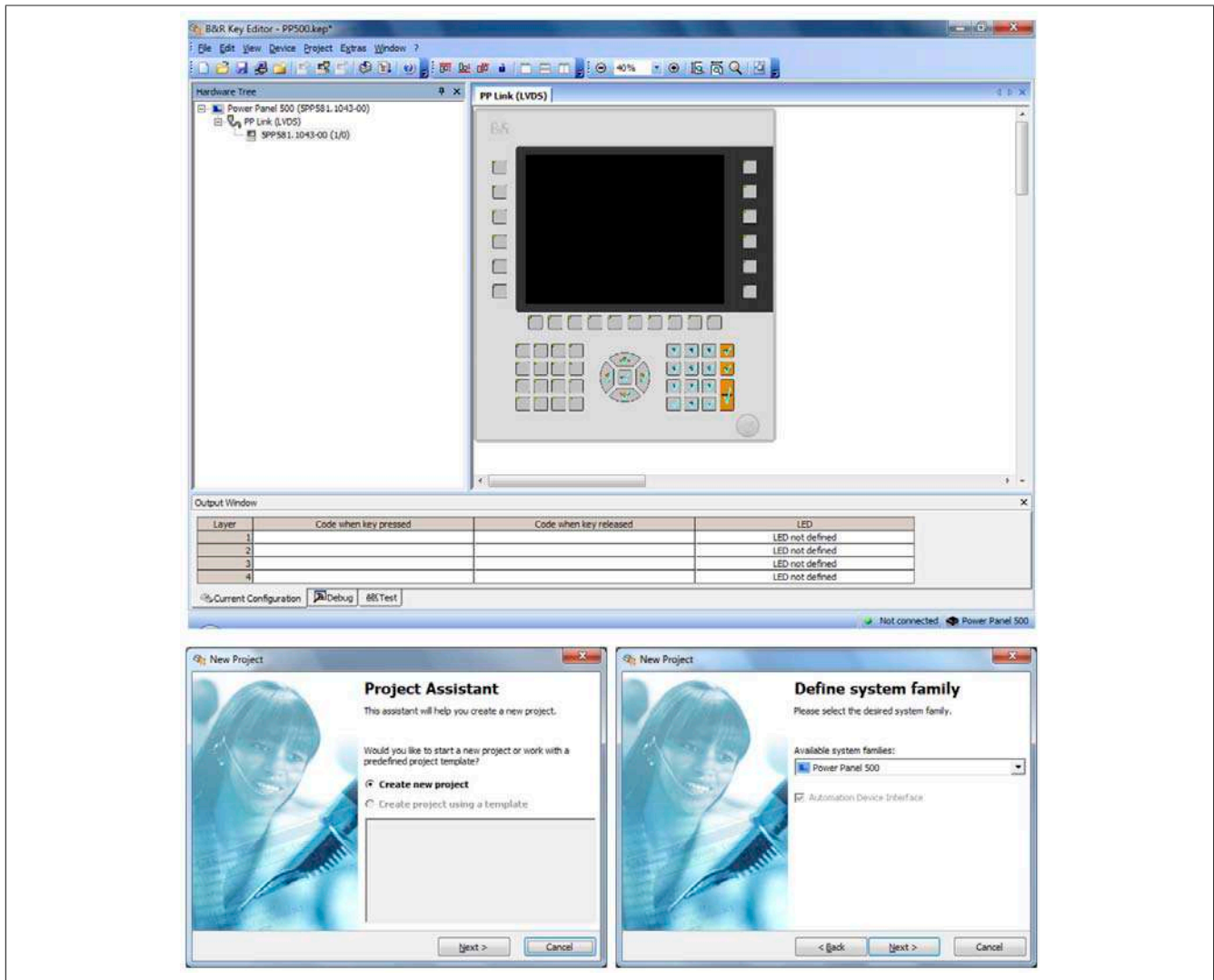

Figure 133: B&R Key Editor screenshots (version 3.50)

Features:

- Configuration of normal keyboard keys (A, B, C, etc.)
- Keyboard shortcuts (CTRL+C, SHIFT+DEL, etc.) using only one key
- Special key functions (change brightness, etc.)
- Assignment of functions to LEDs (HDD access, power, etc.)
- 4 assignments possible per key (using layers)
- Configuration of the panel locking time when multiple Automation Panel 900 devices are connected to Automation PC and Panel PC devices.

The following systems are supported (version 3.50):

- Automation PC 510
- Automation PC 511
- Automation PC 620
- Automation PC 810
- Automation PC 820
- Automation PC 910
- Automation PC 2100
- Automation Panel 800
- Automation Panel 830

- Automation Panel 900
- Automation Panel 9x3 / 9xD
- IPC2000, IPC2001, IPC2002
- IPC5000, IPC5600
- IPC5000C, IPC5600C
- Mobile Panel 40/50
- Mobile Panel 100/200
- Panel PC 300
- Panel PC 700
- Panel PC 800
- Panel PC 900
- Panel PC 2100
- Power Panel 100/200
- Power Panel 300/400
- Power Panel 500

A detailed guide for configuring keys and LEDs can be found in the B&R Key Editor's help system. The B&R Key Editor is available at no cost in the Downloads section of the B&R website (www.br-automation.com). It can also be found on the B&R HMI Drivers & Utilities DVD (model number 5SWHMI.0000-00).

Chapter 5 • Standards and certifications

1 Standards and guidelines

1.1 CE mark



Product complies with all applicable directives and their harmonized EN standards.

1.2 EMC directive

These devices meet the requirements of EC directive "2004/108/EC Electromagnetic compatibility" and are designed for the following areas:

EN 61131-2:2007	Programmable logic controllers - Part 2: Equipment requirements and tests
EN 61000-6 -2:2005	Electromagnetic compatibility (EMC) - Part 6-2: Generic standards - Immunity for industrial environments
EN 61000-6 -4:2007	Electromagnetic compatibility (EMC) - Part 6-4: Generic standards - Emission standard for industrial environments

1.3 Low voltage directive

These devices satisfy the requirements of EC directive "2006/95/EC Low voltage directive" and are designed for the following areas:

EN 61131-2:2007	Programmable logic controllers - Part 2: Equipment requirements and tests
EN 60204-1:2006 + A1:2009	Safety of machinery - Electrical equipment of machines - Part 1: General requirements

2 Certifications

Danger!

A complete system can only receive certification if ALL of the individual components it includes have the applicable certifications. If an individual component is being used that DOES NOT have an applicable certification, then the complete system WILL NOT receive certification.

B&R products and services comply with applicable standards. This includes international standards from organizations such as ISO, IEC and CENELEC, as well as national standards from organizations such as UL, CSA, FCC, VDE, ÖVE, etc. We are committed to ensuring the reliability of our products in an industrial environment.

Unless otherwise specified, the following certifications apply:

2.1 GOST-R



Products with this mark have been certified by an accredited testing laboratory and have been approved for import to the Russian Federation (based on CE compliance).

Chapter 6 • Accessories

The following accessories have successfully completed functional testing at B&R and are approved for use with this device. Nevertheless, it is important to observe any limitations that may apply to the complete system when operated with other individual components. When operating the complete system, the specifications for the individual components must be observed.

All components listed in this manual have been subjected to extensive system and compatibility testing and are approved for use. B&R can make no guarantee regarding the functionality of non-approved accessories.

1 Replacement CMOS batteries

1.1 0AC201.91 / 4A0006.00-000

1.1.1 General information

This lithium battery is needed to back BIOS CMOS data and the real-time clock (RTC).

The battery is subject to wear and must be replaced when the battery power is insufficient ("Bad" status).

1.1.2 Order data

Model number	Short description	Figure
	Batteries	
0AC201.91	Lithium batteries 4 pcs., 3 V / 950 mAh button cell We hereby state that the lithium cells contained in this shipment qualify as "partly regulated". Handle with care. If the package is damaged, inspect the cells, repack intact cells and protect the cells against short circuit. For emergency information, call RENATA SA at +41 61 319 28 27.	
4A0006.00-000	Lithium battery, 3 V / 950 mAh, button cell	

Table 175: 0AC201.91, 4A0006.00-000 - Order data

1.1.3 Technical data

Warning!

The battery is only permitted to be replaced by a Renata CR2477N battery. The use of another battery may present a risk of fire or explosion.

The battery may explode if handled improperly. Do not recharge, disassemble or dispose of in fire.

Information:

The following characteristics, features and limit values only apply to this accessory and can deviate from those specified for the complete system. The data specifications for the complete system take precedence over those of individual components.

Product ID	0AC201.91	4A0006.00-000
General information		
Storage time	Max. 3 years at 30°C	
Certification		
CE	Yes	
cULus	Yes	
Electrical characteristics		
Capacity	950 mAh	
Self-discharging	<1% per year (at 23°C)	
Voltage range	3 V	

Table 176: 0AC201.91, 4A0006.00-000 - Technical data

Product ID	0AC201.91	4A0006.00-000
Environmental conditions		
Temperature Storage	-20 to 60°C	
Relative humidity Operation	0 to 95%	
Storage	0 to 95%	
Transport	0 to 95%	

Table 176: 0AC201.91, 4A0006.00-000 - Technical data

2 Power connectors

2.1 0TB103.9x

2.1.1 General information

This single-row, 3-pin 0TB103 terminal block is used to connect the voltage supply.

2.1.2 Order data

Model number	Short description	Figure
	Terminal blocks	
0TB103.9	Connector 24 VDC - 3-pin female - Screw clamps 3.31 mm ²	
0TB103.91	Connector 24 VDC - 3-pin female - Cage clamps 3.31 mm ²	

Table 177: 0TB103.9, 0TB103.91 - Order data

2.1.3 Technical data

Information:

The following characteristics, features and limit values only apply to this accessory and can deviate from those specified for the complete system. The data specifications for the complete system take precedence over those of individual components.

Product ID	0TB103.9	0TB103.91
General information		
Certification		
CE		Yes
cULus		Yes
cULus HazLoc Class 1 Division 2	Yes ¹⁾	Yes ²⁾
GL	Yes ¹⁾	Yes ²⁾
Terminal block		
Note	Protected against vibration by the screw flange Nominal values according to UL	Protected against vibration by the screw flange Nominal values according to UL
Number of pins	3 (female)	
Type of terminal clamp	Screw clamps	Cage clamps ³⁾
Cable type	Only copper wires (no aluminum wires!)	
Distance between contacts	5.08 mm	
Connection cross section		
AWG wire	26 to 14 AWG	26 to 12 AWG
Wire end sleeves with plastic covering		0.20 to 1.50 mm ²
Solid wires		0.20 to 2.50 mm ²
Fine strand wires	0.20 to 1.50 mm ²	0.20 to 2.50 mm ²
With wire end sleeves		0.20 to 1.50 mm ²
Tightening torque	0.4 Nm	-
Electrical characteristics		
Nominal voltage	300 V	
Nominal current ⁴⁾	10 A / contact	
Contact resistance	≤5 mΩ	

Table 178: 0TB103.9, 0TB103.91 - Technical data

- 1) Yes, although applies only if all components installed within the complete system have this certification
- 2) Yes, although applies only if all components installed within the complete system have this certification.
- 3) Cage clamp terminal blocks cannot be used side-by-side.
- 4) The limit data for each I/O module must be taken into consideration.

3 DVI/Monitor adapter

3.1 5AC900.1000-00

3.2 General information

This adapter enables a standard monitor to be connected to the DVI-I interface.

3.3 Order data

Model number	Short description	Figure
	Miscellaneous	
5AC900.1000-00	DVI (male connector) to CRT (female connector) adapter. For connecting a standard monitor to a DVI-I interface.	

Table 179: 5AC900.1000-00 - Order data

4 USB interface cover

4.1 5AC900.1201-00

4.1.1 General information

Flat front-side USB interface cover for Automation Panel 900, Power Panel 500, Panel PC 700 and Panel PC 800 devices.

4.1.2 Order data

Model number	Short description	Figure
	Accessories	
5AC900.1201-00	USB interface cover M20 IP65 flat	

Table 180: 5AC900.1201-00 - Order data

4.2 5AC900.1201-01

4.2.1 General information

Round front-side knurled USB interface cover (with anti-loss strap) for Automation Panel 900, Power Panel 500, Panel PC 700 and Panel PC 800 devices.

4.2.2 Order data

Model number	Short description	Figure
	Accessories	
5AC900.1201-01	USB interface cover M20 IP65 curved	

Table 181: 5AC900.1201-01 - Order data

5 Clamping blocks

5.1 5AC900.BLOC-00

5.1.1 General information

These replacement clamping blocks are used to mount B&R panel devices.

5.1.2 Order data

Model number	Short description	Figure
	Accessories	
5AC900.BLOC-00	Terminal block with brackets, 10 pcs.; replacement part	

Table 182: 5AC900.BLOC-00 - Order data

6 Uninterruptible power supply

With an optionally integrated UPS, the B&R Industrial PC makes sure that the PC system completes write operations even when a power failure occurs. If the UPS detects a power failure, it switches to battery operation immediately without interruption. Any running programs will be properly terminated by the UPS. This eliminates the chance of inconsistent data (only works if the UPS has already been configured and the drive is enabled).

Information:

- **The monitor/panel is not buffered by the UPS and will shut off when the power fails.**
- **More detailed information about uninterruptible power supplies can be found in the user's manual for the external UPS. This can be downloaded from the B&R website.**

Because the charging circuit is integrated in the housing of the B&R Industrial PC, installation has been simplified to merely attaching the connection cable to the battery unit mounted next to the PC.

Special emphasis was placed on ease of maintenance when the battery unit was designed. Batteries are easily accessible from the front and can be replaced in just a few moments when servicing.

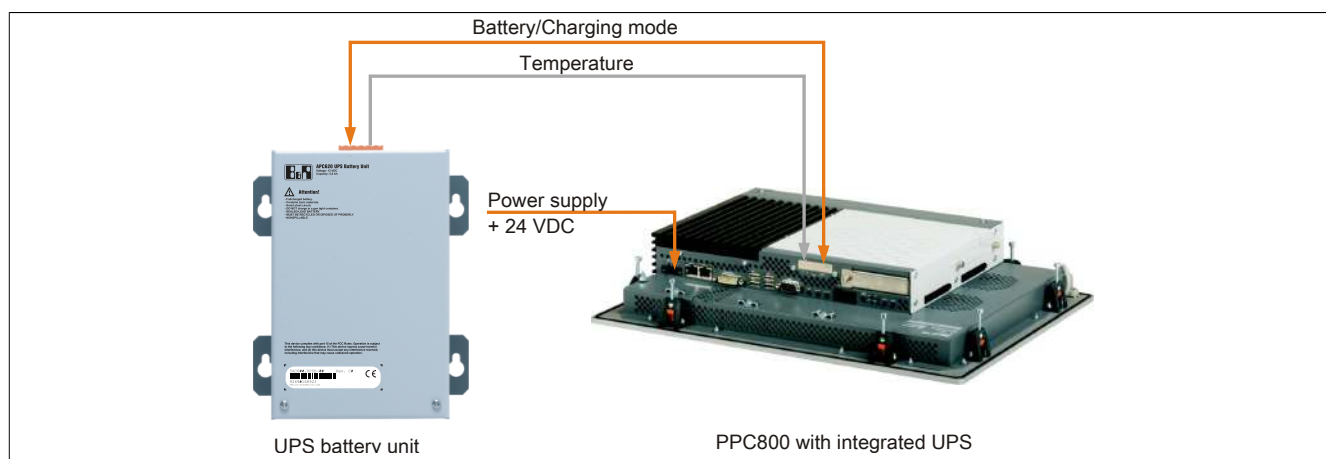

Figure 134: UPS principle

6.1 Features

- Long-lasting, maintenance-free rechargeable batteries
- Communication via integrated interfaces
- Temperature sensor
- Driver software
- Deep discharge protection

6.2 Requirements

- A suitable system unit
- Add-on UPS module 5AC600.UPSI-00
- Battery unit 5AC600.UPSB-00
- UPS connection cable 0.5 m (5CAUPS.0005-00) or 3 m (5CAUPS.0030-00)
- Configuration of the B&R UPS in the ADI Control Center

6.3 5AC600.UPSI-00

6.3.1 General information

This add-on UPS module can easily be installed in an appropriate system unit (for a list of required revisions, see section 6.2 "Requirements" on page 240).

6.3.2 Order data

Model number	Short description	Figure
	Uninterruptible power supplies	
5AC600.UPSI-00	UPS module for APC620, APC810, PPC800; for system units 5PC600.SX01-00 (beginning with rev. H0), 5PC600.SX02-00 (beginning with rev. G0), 5PC600.SX02-01 (beginning with rev. H0), 5PC600.SX05-00 (beginning with rev. F0), 5PC600.SX05-01 (beginning with rev. F0), 5PC600.SF03-00 (beginning with rev. A0), 5PC810.SX*, 5PC820.1505-00, 5PC820.1906-00. Order cable (5CAUPS.0005-00 or 5CAUPS.0030-00) and battery unit (5AC600.UPSB-00) separately.	
	Required accessories	
	Uninterruptible power supplies	
5AC600.UPSB-00	Battery unit 5 Ah; for APC620, APC810 or PPC800 UPS	
5CAUPS.0005-00	UPS cable 0.5 m; for UPS 5AC600.UPSI-00	
5CAUPS.0030-00	UPS cable 3 m - For 5AC600.IUPS-00	

Table 183: 5AC600.UPSI-00 - Order data

6.3.3 Technical data

Information:

The following characteristics, features and limit values only apply to this accessory and can deviate from those specified for the complete system. The data specifications for the complete system take precedence over those of individual components.

Product ID	5AC600.UPSI-00
General information	
Certification	
CE	Yes
cULus	Yes
GOST-R	Yes
GL	Yes ¹⁾
Electrical characteristics	
Power consumption	Max. 7.5 watts
Power failure bypass	Max. 20 min at 150 W load
Deep discharge protection	Yes, at 10 V on the battery unit
Short circuit protection	No
Battery charging data	
Charging current	Max. 0.5 A
Switching threshold	
Battery operation	13 V
Mains operation	15 V

Table 184: 5AC600.UPSI-00 - Technical data

1) Yes, although applies only if all components installed within the complete system have this certification

6.3.4 Installation

This module is installed using the materials included in delivery. For more information regarding installation, see chapter 7 "Maintenance and service".

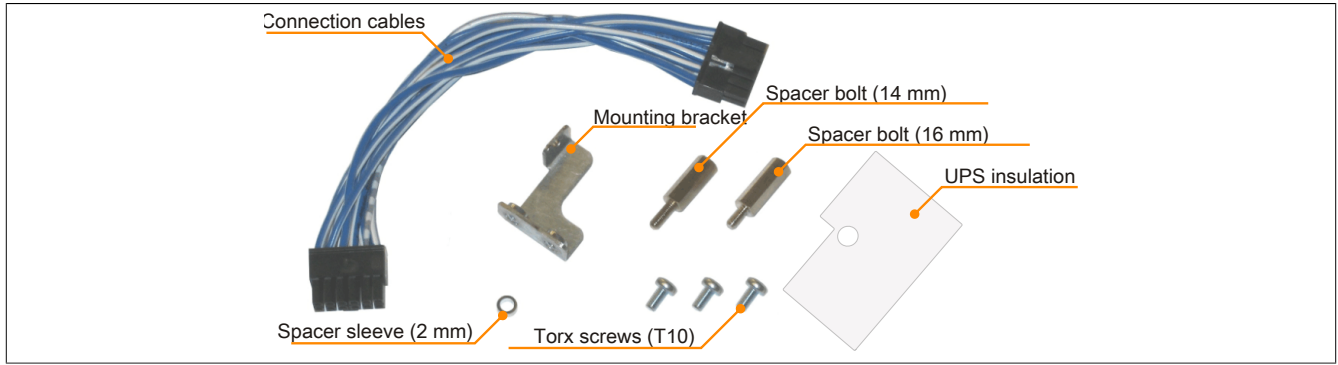

Figure 135: 5AC600. UPSI-00 Add-on UPS module - Installation materials

6.4 5AC600.UPSB-00

6.4.1 General information

The battery unit has a limited service life and should be replaced regularly (after the specified service life at the latest).

6.4.2 Order data

Model number	Short description	Figure
	Uninterruptible power supplies	
5AC600.UPSB-00	Battery unit 5 Ah; for APC620, APC810 or PPC800 UPS	

Table 185: 5AC600.UPSB-00 - Order data

6.4.3 Technical data

Information:

The following characteristics, features and limit values only apply to this accessory and can deviate from those specified for the complete system. The data specifications for the complete system take precedence over those of individual components.

Product ID	5AC600.UPSB-00	
Revision	D0	E0
General information		
Battery		
Type	Energys Cyclon 12 V 5 Ah (6 connected in series)	
Service life	Up to 15 years at 20°C / 10 years at 25°C. ¹⁾	
Execution	Single cell	
Temperature sensor	NTC resistance	
Maintenance interval during storage	6 month interval between charges	
Certification		
CE	Yes	
cULus	Yes	
GOST-R	Yes	
GL	Yes ²⁾	
Charge duration when battery low	Typ. 15 hours	
Electrical characteristics		
Nominal voltage	12 V	
Battery current	Max. 8 A	
Capacity	5 Ah	
Fuse ³⁾	No ⁴⁾	Yes ⁴⁾
Deep discharge voltage	10 V	
Environmental conditions		
Temperature		
Charging mode	-30 to 60°C	
Operation	-40 to 80°C	
Storage	-65 to 80°C	
Transport	-65 to 80°C	
Relative humidity		
Operation	5 to 95%, non-condensing	
Storage	5 to 95%, non-condensing	
Transport	5 to 95%, non-condensing	
Altitude		
Operation	Max. 3000 m	

Table 186: 5AC600.UPSB-00, 5AC600.UPSB-00 - Technical data

Product ID	5AC600.UPSB-00
Mechanical characteristics	
Dimensions	
Width	104 mm ⁵⁾
Length	170.5 mm
Height	87.5 mm
Weight	Approx. 3200 g

Table 186: 5AC600.UPSB-00, 5AC600.UPSB-00 - Technical data

- 1) Depending on the charging and discharging cycles (up to 80% battery capacity).
- 2) Yes, although applies only if all components installed within the complete system have this certification
- 3) 25 A fuse. Replacement fuses can be ordered separately whenever needed.
- 4) The fuse can be installed later in revisions up to and including D0. More information can be found in the "Maintenance and service" chapter of the APC810 and PPC800 user's manuals.
- 5) Dimensions without mounting clips.

6.4.4 Service life

The following diagram shows the relationship between ambient temperature and service life.

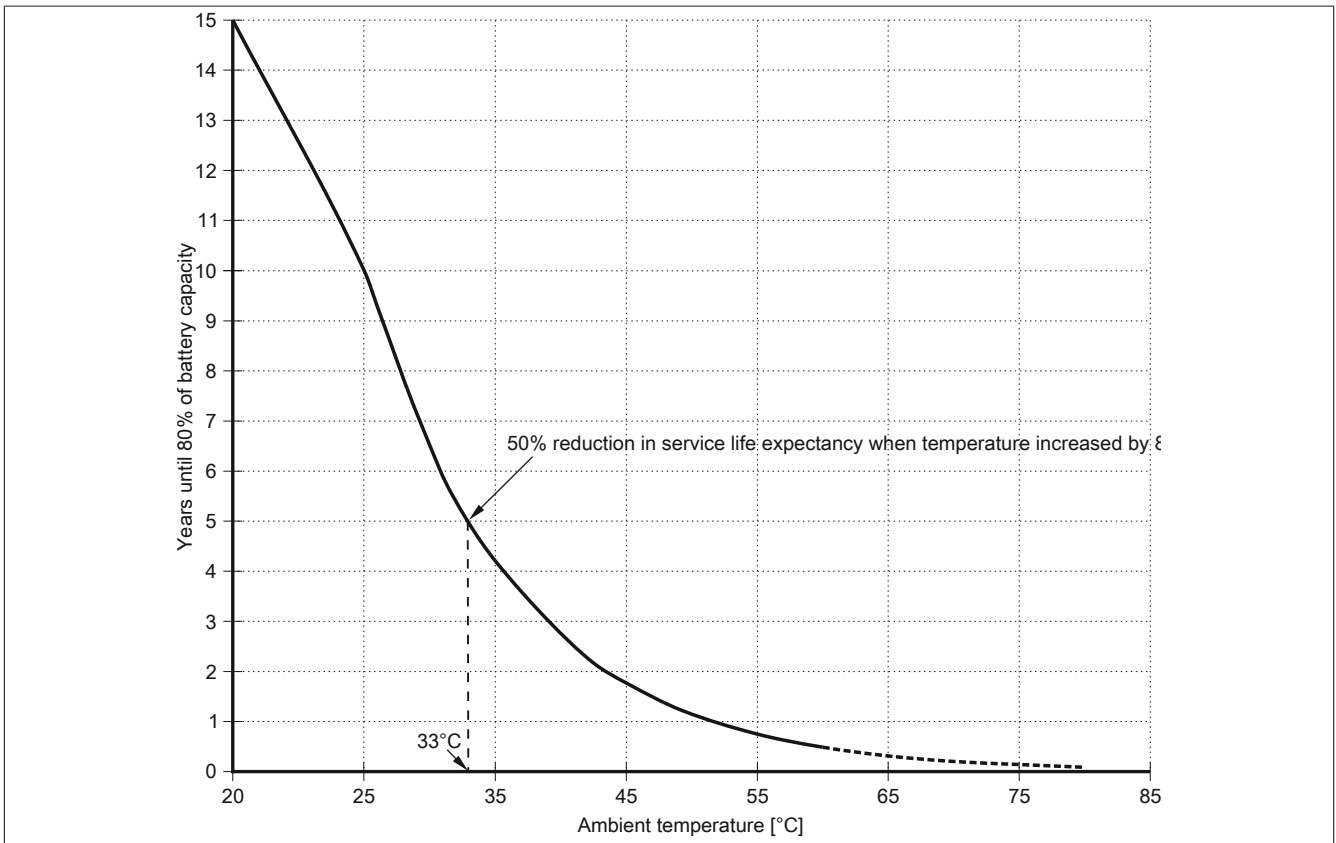

6.4.5 Deep discharge cycles

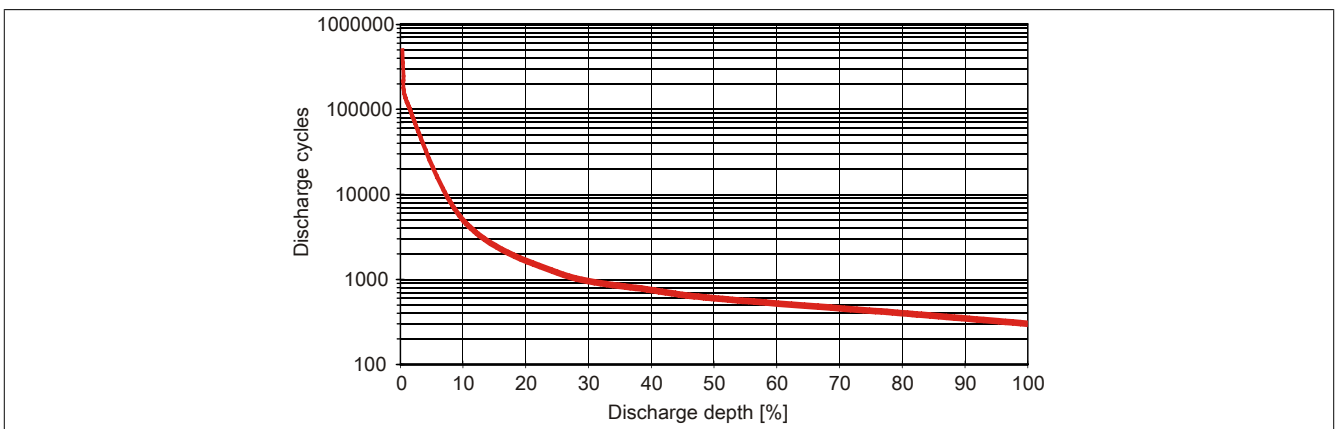

Figure 136: Deep discharge cycles

6.4.6 Dimensions

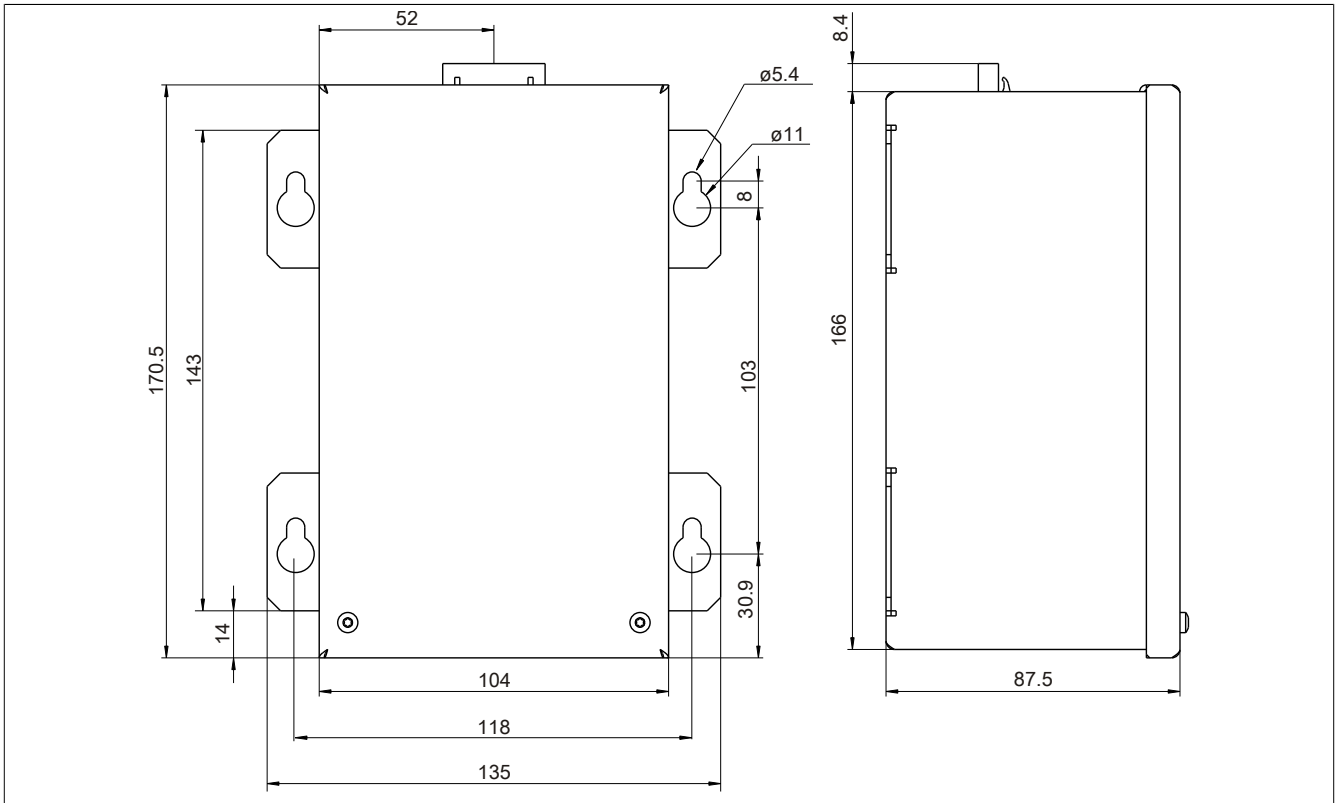

Figure 137: 5PC600.UPSB-00 - Dimensions

6.4.7 Drilling template

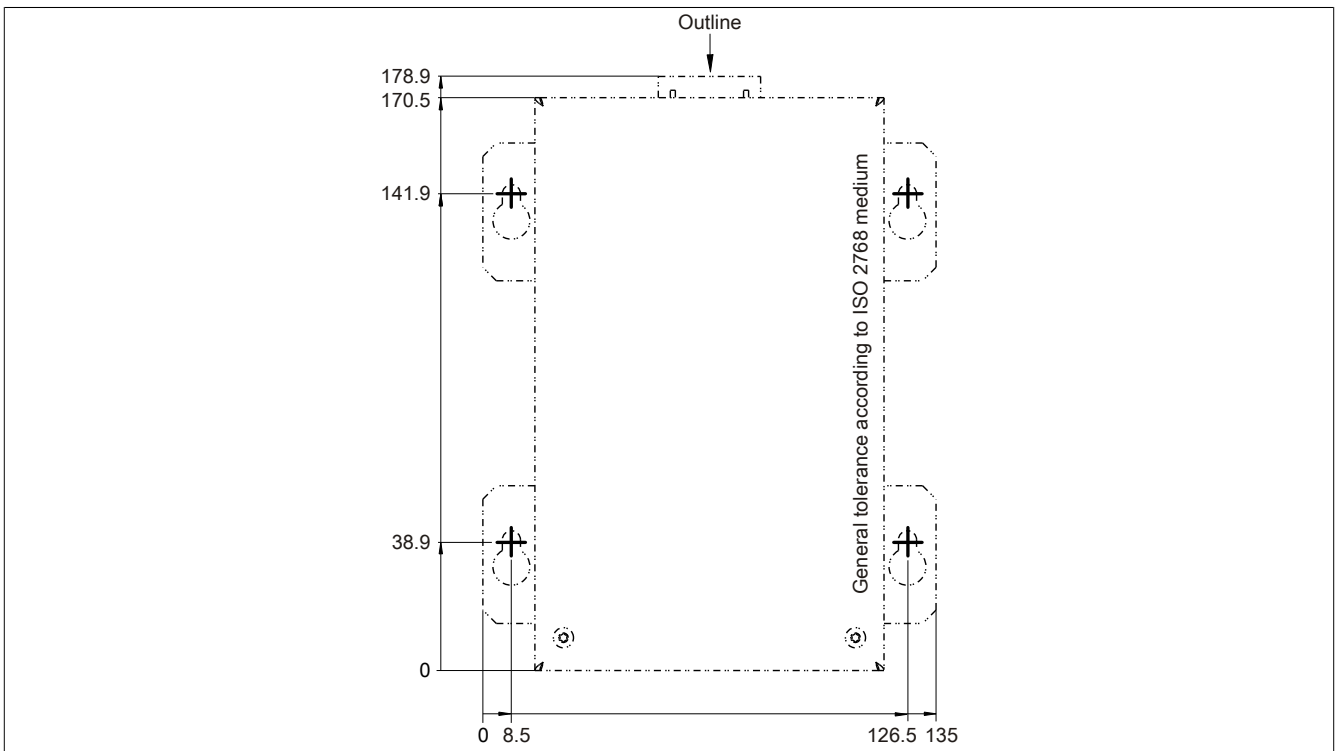

Figure 138: 5PC600.UPSB-00 - Drilling template

6.4.8 Installation instructions

Due to the unique construction of these batteries, they can be stored and operated in any position.

6.5 5CAUPS.00xx-00

6.5.1 General information

The UPS connection cable establishes the connection between the add-on UPS module (5AC600.UPSI-00) and the battery unit (5AC600.UPSB-00). It is available in lengths of 0.5 m and 3 m.

6.5.2 Order data

Model number	Short description	Figure
	Uninterruptible power supplies	
5CAUPS.0005-00	UPS cable 0.5 m; for UPS 5AC600.UPSI-00	
5CAUPS.0030-00	UPS cable 3 m - For 5AC600.IUPS-00	

Table 187: 5CAUPS.0005-00, 5CAUPS.0030-00 - Order data

6.5.3 Technical data

Information:

The following characteristics, features and limit values only apply to this accessory and can deviate from those specified for the complete system. The data specifications for the complete system take precedence over those of individual components.

Product ID	5CAUPS.0005-00	5CAUPS.0030-00
General information		
Certification		
CE		Yes
cULus		Yes
GOST-R		Yes
GL		Yes ¹⁾
Cable construction		
Wire cross section		2x 0.5 mm ² (AWG 20) 4x 2.5 mm ² (AWG 13)
Conductor resistance		At 0.5 mm ² max. 39 Ω/km At 2.5 mm ² max. 7.98 Ω/km
Outer sheathing		
Material		Thermoplastic PVC-based material
Color		Window gray (similar to RAL 7040)
Connector		
Type	6-pin male connector with clamping yoke / 6-pin female multipoint connector with clamping yoke	
Electrical characteristics		
Operating voltage	Max. 300 V	
Peak operating voltage	Typically 12 VDC / max. 15 VDC	
Test voltage		
Wire/Wire	1500 V	
Current load	10 A at 20°C	
Environmental conditions		
Temperature		
Moving	-5 to 80°C	
Static	-30 to 80°C	
Mechanical characteristics		
Dimensions		
Length	0.5 m	3 m
Diameter	8.5 mm ±0.2 mm	
Flex radius		
Moving	10x wire cross section	
Fixed installation	5x wire cross section	
Weight	Approx. 100 g	Approx. 470 g

Table 188: 5CAUPS.0005-00, 5CAUPS.0030-00 - Technical data

1) Yes, although applies only if all components installed within the complete system have this certification

6.6 5AC600.UPSF-00

6.6.1 General information

The UPS fuse kit can be used to add a fuse for the 5AC600.UPSB-00 battery unit.

Information about installing the 5AC600.UPSF-00 fuse kit can be found in the section "Installing the UPS fuse kit on the battery unit" on page 297.

Information:

The 5AC600.UPSF-00 UPS fuse kit is only needed for battery units up to and including revision D0. A 25 A fuse is integrated on the connector circuit board beginning with revision E0.

6.6.2 Order data

Model number	Short description	Figure
	Uninterruptible power supplies	
5AC600.UPSF-00	UPS fuse kit for battery unit 5AC600.UPSB-00 up to revision D0.	
	Optional accessories	
	Uninterruptible power supplies	
5AC600.UPSF-01	UPS fuse, 5 pcs.	

Table 189: 5AC600.UPSF-00 - Order data

6.7 5AC600.UPSF-01

6.7.1 General information

These 25 A fuses are replacement parts for the 5AC600.UPSB-00 battery unit (beginning with revision E0) as well as the 5AC600.UPSF-00 fuse kit.

6.7.2 Order data

Model number	Short description	Figure
	Uninterruptible power supplies	
5AC600.UPSF-01	UPS fuse, 5 pcs.	

Table 190: 5AC600.UPSF-01 - Order data

7 External UPS

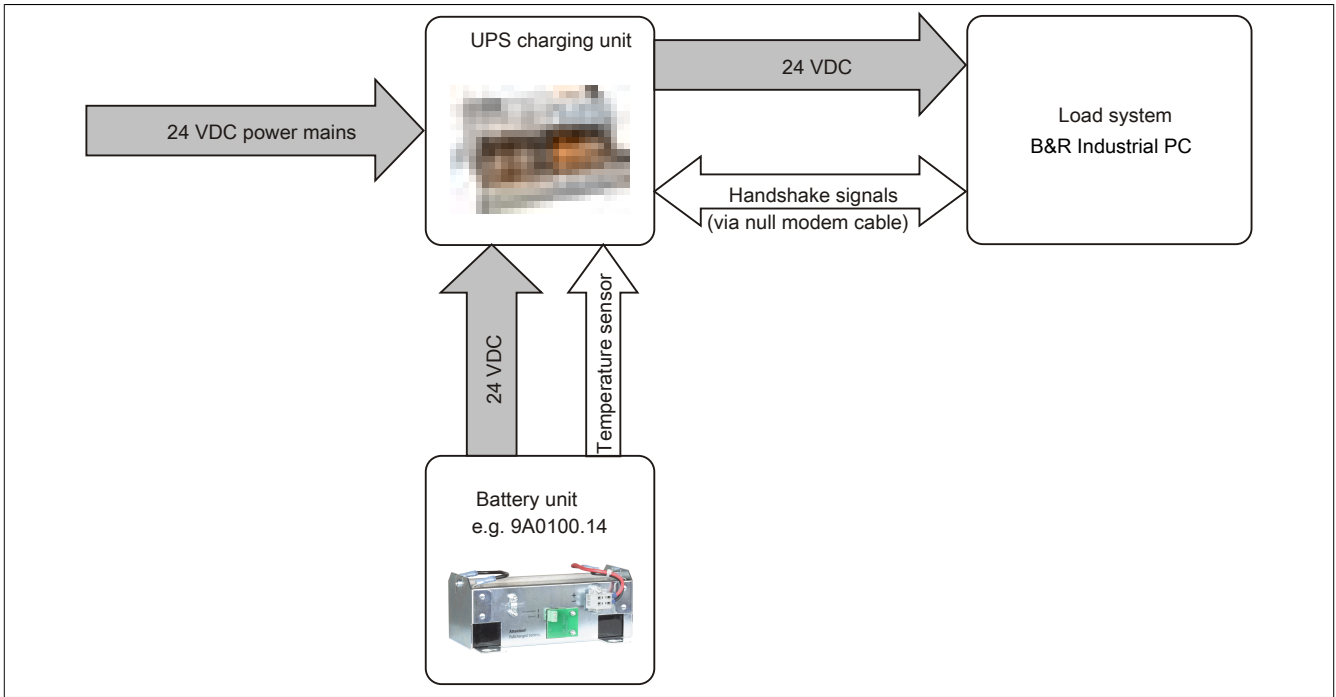

Figure 139: Block diagram of the complete system

7.1 General information

A UPS charging unit, battery unit and null modem cable are required to provide power from an external UPS.

In normal operation, the 24 VDC supply voltage is routed directly to the load system. If the mains supply voltage fails, the UPS battery unit powers the load system power so that shutdown can take place properly without losing data.

Data and commands are exchanged between the UPS and the load system via the handshake signals on the RS232 interface.

Additional information about external UPS is available in the UPS user's manual, which can be downloaded from the B&R website (www.br-automation.com).

7.2 Order data

Model number	Short description	Figure
24 VDC UPS modules		
9A0100.11	UPS 24 VDC, 24 VDC input, 24 VDC output, serial interface	
Battery units		
9A0100.12	UPS battery unit type A, 24 V, 7 Ah, incl. battery cage	
Replacement batteries		
9A0100.13	UPS batteries type A (replacement part), 2x 12 V, 7 Ah, for battery unit 9A0100.12	
9A0100.14	UPS battery unit type B, 24 V, 2.2 Ah, incl. battery cage	
9A0100.15	UPS batteries type B (replacement part), 2x 12 V, 2.2 Ah, for battery unit 9A0100.14	
9A0100.16	UPS battery unit type C, 24 V, 4.5 Ah, incl. battery cage	
9A0100.17	UPS batteries type C (replacement part), 2x 12 V, 4.5 Ah, for battery unit 9A0100.16	
Required accessories		
Battery units		
9A0100.12	UPS battery unit type A, 24 V, 7 Ah, incl. battery cage	
9A0100.14	UPS battery unit type B, 24 V, 2.2 Ah, incl. battery cage	
9A0100.16	UPS battery unit type C, 24 V, 4.5 Ah, incl. battery cage	
Cables		
9A0017.01	RS232 null modem cable, 0.6 m, for connecting UPS and IPC (9-pin female DSUB connector - 9-pin female DSUB connector)	
9A0017.02	RS232 null modem cable, 1.8 m, for connecting UPS and IPC (9-pin female DSUB connector - 9-pin female DSUB connector)	
Optional accessories		
Replacement batteries		

Table 191: 9A0100.11, 9A0100.12, 9A0100.13, 9A0100.14, 9A0100.15, 9A0100.16, 9A0100.17 - Order data

Model number	Short description	Figure
9A0100.13	UPS batteries type A (replacement part), 2x 12 V, 7 Ah, for battery unit 9A0100.12	
9A0100.15	UPS batteries type B (replacement part), 2x 12 V, 2.2 Ah, for battery unit 9A0100.14	
9A0100.17	UPS batteries type C (replacement part), 2x 12 V, 4.5 Ah, for battery unit 9A0100.16	

Table 191: 9A0100.11, 9A0100.12, 9A0100.13, 9A0100.14, 9A0100.15, 9A0100.16, 9A0100.17 - Order data

8 PCI plug-in cards

8.1 5ACPCI.ETH1-01

8.1.1 General information

These universal (3.3 V and 5 V) half-size PCI Ethernet card have a 10/100 Mbit/s network connection and can be inserted and operated in a standard 16-bit PCI slot as an additional network interface.

- PCI Ethernet card
- 1 network connection (10/100 Mbit/s)

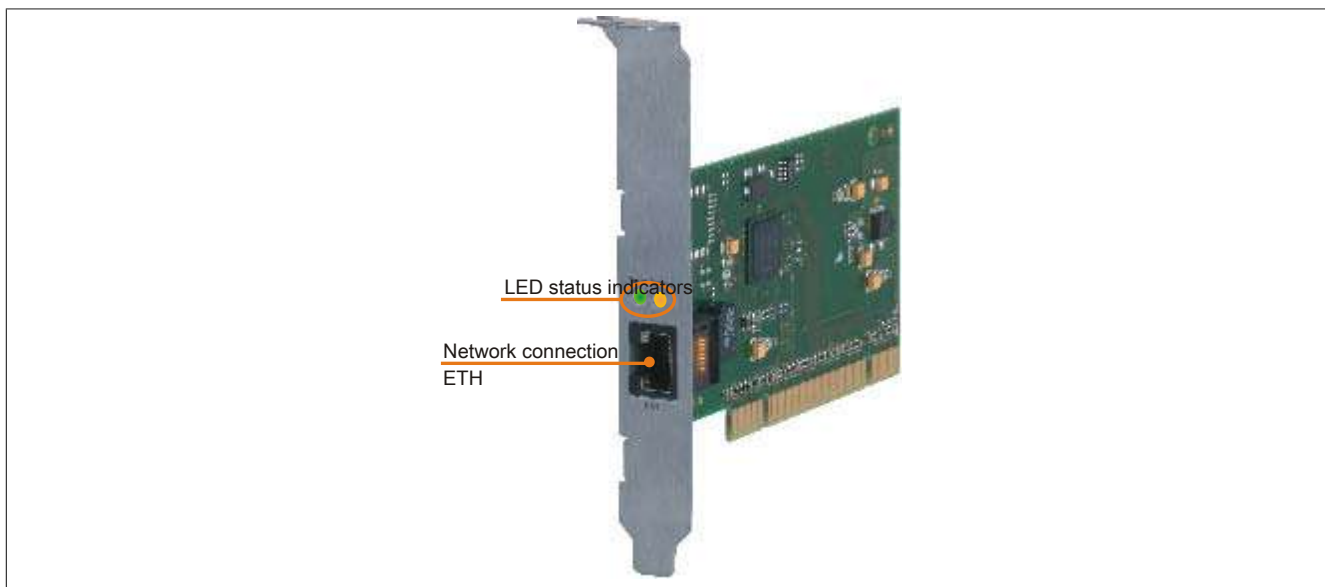

Figure 140: 5ACPCI.ETH1-01 - PCI 10/100 Ethernet card

8.1.2 Order data

Model number	Short description	Figure
5ACPCI.ETH1-01	Accessories PCI Ethernet card 1x 10/100	

Table 192: 5ACPCI.ETH1-01 - Order data

8.1.3 Technical data

Product ID	5ACPCI.ETH1-01
General information	
B&R ID code	0xA58A
Diagnostics	
Data transfer	Yes, using status LED
Certification	
CE	Yes
cULus	Yes
cULus HazLoc Class 1 Division 2	Yes ¹⁾
GOST-R	Yes
GL	Yes ¹⁾

Table 193: 5ACPCI.ETH1-01 - Technical data

Product ID	5ACPCI.ETH1-01
Interfaces	
Ethernet	
Quantity	1
Controller	Intel 82551ER
Execution	Shielded RJ45 port
Transfer rate	10/100 Mbit/s
Cable length	Max. 100 m between two stations (segment length)

Table 193: 5ACPCI.ETH1-01 - Technical data

1) Yes, although applies only if all components installed within the complete system have this certification

8.1.3.1 Ethernet interface

Information:

The following characteristics, features and limit values only apply to this individual component and can deviate from those specified for the complete system. For the complete system in which this individual component is used, refer to the data given specifically for that device.

Ethernet interface		
Controller	Intel 82551ER	
Power supply	Universal card (2 notches) for 3.3 V or 5 V	
Cabling	S/STP (Cat 5e)	
Transfer rate	10/100 Mbit/s	
Cable length	Max. 100 m (min. Cat 5e)	
LED	On	Off
Green	100 Mbit/s	10 Mbit/s
Orange	Link (Ethernet network connection available)	Activity (blinking - data transfer in progress)

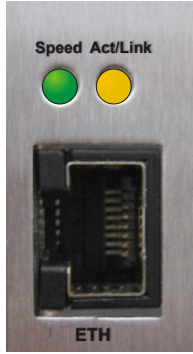

Table 194: 5ACPCI.ETH1-01 - Technical data

8.1.4 Driver support

A special driver is required in order to operate the Intel 82551ER Ethernet controller. Drivers for approved operating systems (Windows XP Professional, Windows XP Embedded and MS-DOS) are available in the Downloads section of the B&R website (www.br-automation.com).

Information:

Required drivers can only be downloaded from the B&R website, not from manufacturer websites.

8.1.5 Dimensions

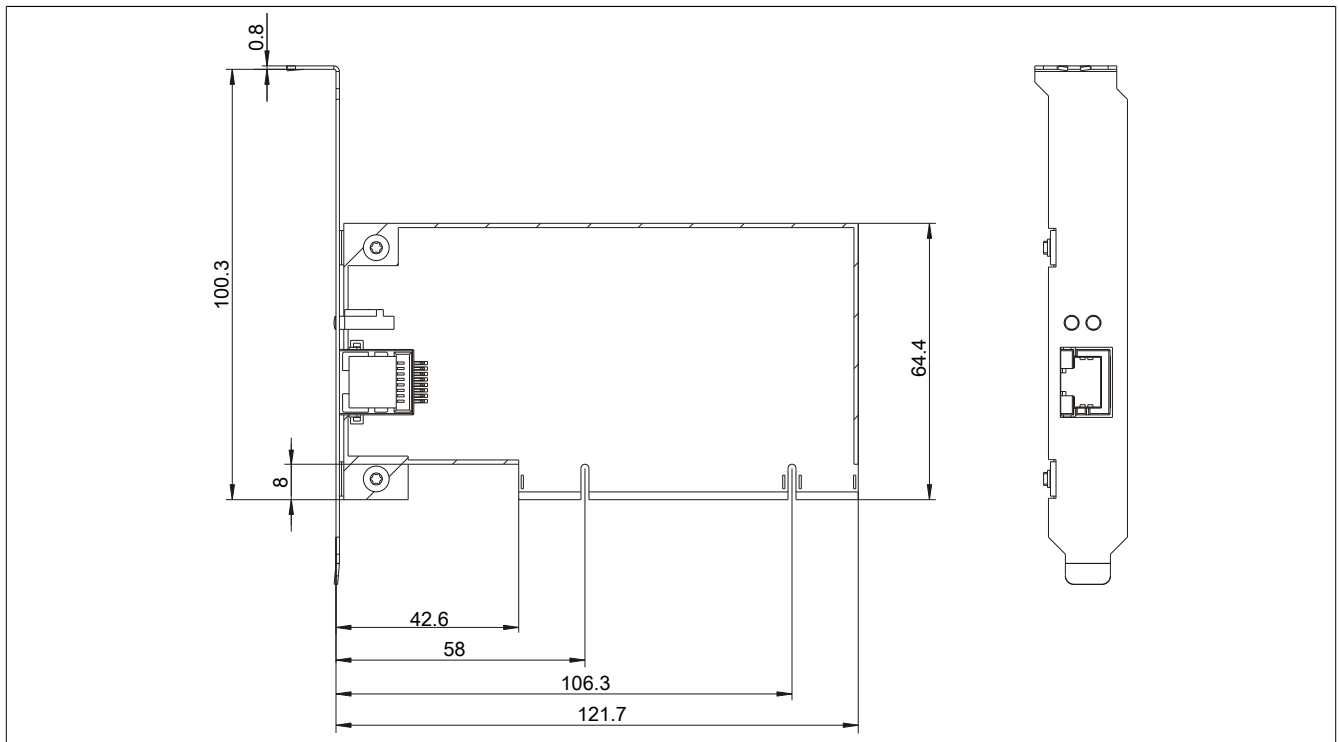

Figure 141: 5ACPCI.ETH1-01 - Dimensions

8.2 5ACPCI.ETH3-01

8.2.1 General information

These universal (3.3 V and 5 V) half-size PCI Ethernet card have three 10/100 Mbit/s network connections and can be inserted and operated in a standard 16-bit PCI slot as an additional network interface.

- PCI Ethernet card
- 3 network connections (10/100 Mbit/s)

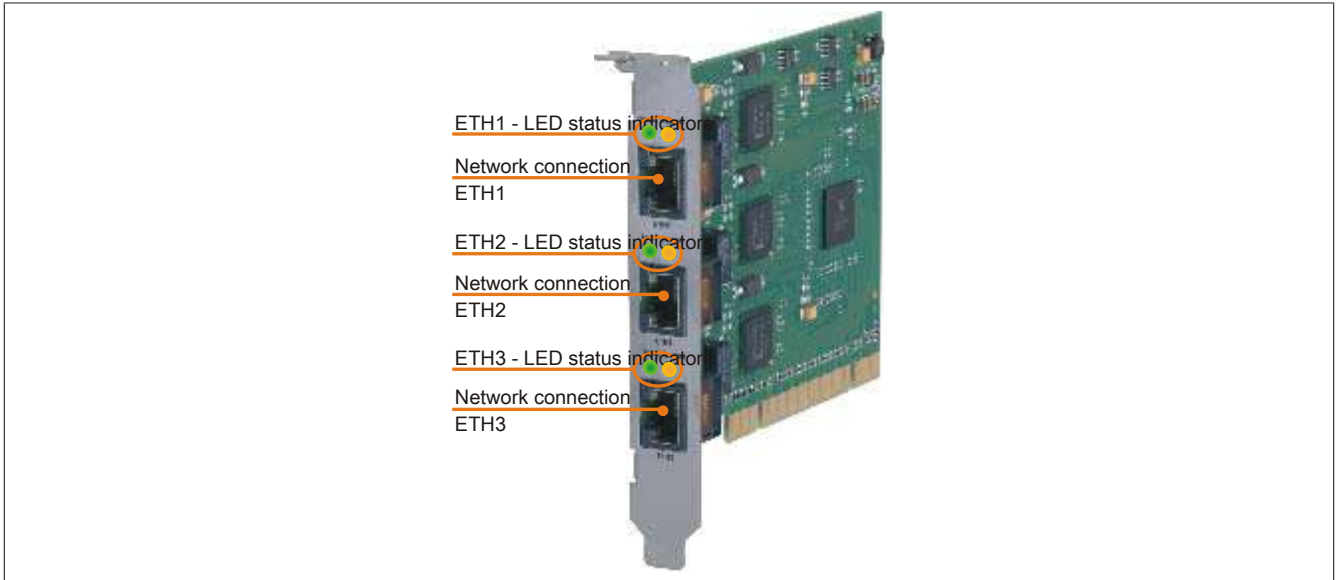

Figure 142: 5ACPCI.ETH3-01 - PCI 10/100 Ethernet card

8.2.2 Order data

Model number	Short description	Figure
Accessories		
5ACPCI.ETH3-01	PCI Ethernet card 3x 10/100	

Table 195: 5ACPCI.ETH3-01 - Order data

8.2.3 Technical data

Product ID	5ACPCI.ETH3-01
General information	
B&R ID code	0xA58B
Diagnostics	
Data transfer	Yes, using status LED
Certification	
CE	Yes
cULus	Yes
cULus HazLoc Class 1 Division 2	Yes ¹⁾
GOST-R	Yes
GL	Yes ¹⁾

Table 196: 5ACPCI.ETH3-01 - Technical data

Product ID	5ACPCI.ETH3-01
Interfaces	
Ethernet	
Quantity	3
Controller	Intel 82551ER
Execution	Shielded RJ45 port
Transfer rate	10/100 Mbit/s
Cable length	Max. 100 m between two stations (segment length)

Table 196: 5ACPCI.ETH3-01 - Technical data

1) Yes, although applies only if all components installed within the complete system have this certification

8.2.3.1 Ethernet interface

Information:

The following characteristics, features and limit values only apply to this individual component and can deviate from those specified for the complete system. For the complete system in which this individual component is used, refer to the data given specifically for that device.

Ethernet interfaces		
Controller	each with Intel 82551ER	
Power supply	Universal card (2 notches) for 3.3 V or 5 V	
Cabling	S/STP (Cat 5e)	
Transfer rate	10/100 Mbit/s	
Cable length	Max. 100 m (min. Cat 5e)	
LED	On	Off
Green	100 Mbit/s	10 Mbit/s
Orange	Link (Ethernet network connection available)	Activity (blinking - data transfer in progress)

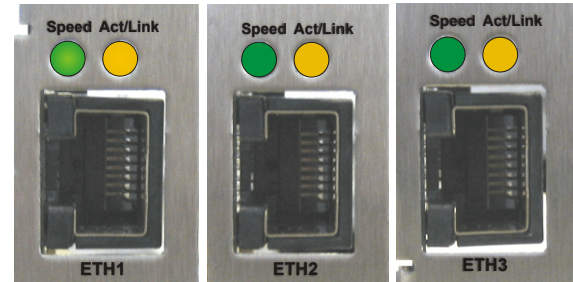

Table 197: 5ACPCI.ETH3-01 - Technical data

8.2.4 Driver support

A special driver is required in order to operate the Intel 82551ER Ethernet controller. Drivers for approved operating systems (Windows XP Professional, Windows XP Embedded and MS-DOS) are available in the Downloads section of the B&R website (www.br-automation.com).

Information:

Required drivers can only be downloaded from the B&R website, not from manufacturer websites.

8.2.5 Dimensions

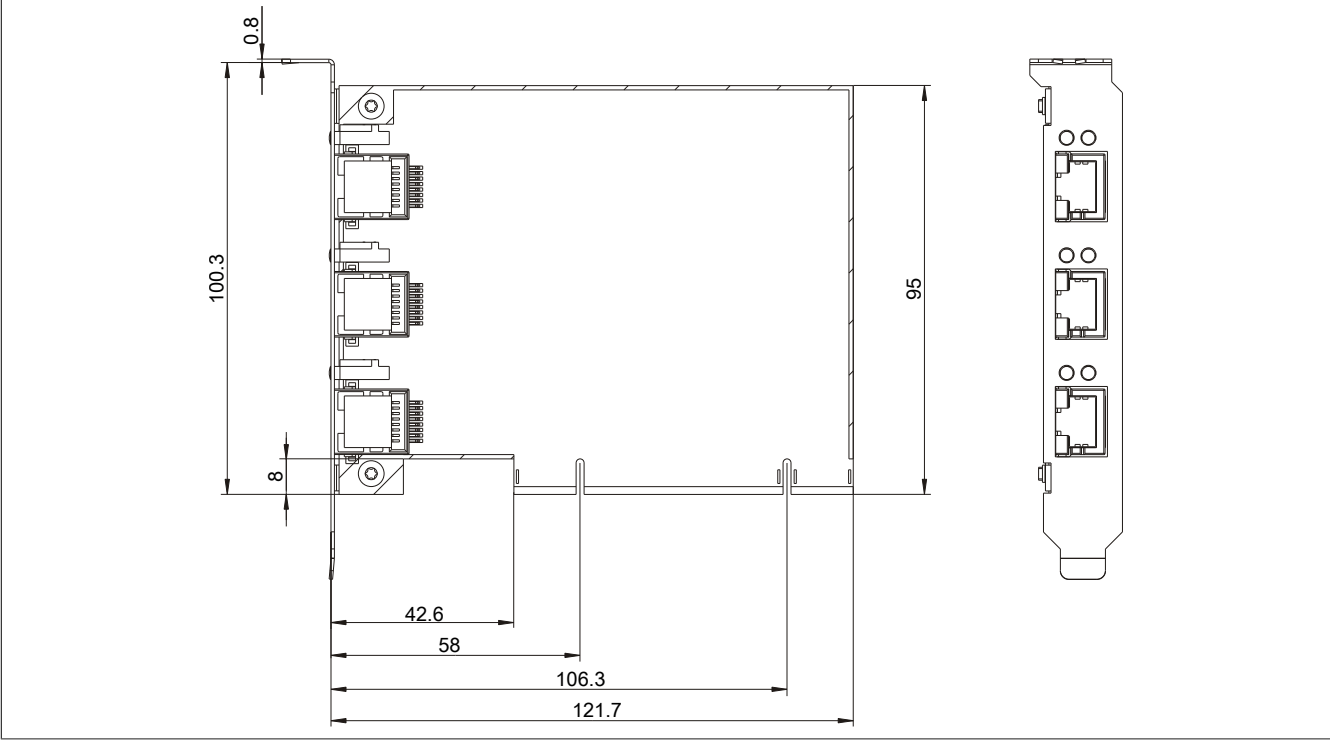

Figure 143: 5ACPCI.ETH3-01 - Dimensions

9 CompactFlash cards

9.1 General information

CompactFlash cards are storage media that are easy to replace. Due to their robustness against environmental influences (e.g. temperature, shock, vibration, etc.), CompactFlash cards are ideal for use as storage media in industrial environments.

9.2 General information

In order to be suited for use in industrial automation, CompactFlash cards must be highly reliable. The following items are very important to achieving the necessary level of reliability:

- The flash technology used
- An efficient algorithm for maximizing service life
- Good mechanisms for detecting and fixing errors in the flash memory

9.2.1 Flash technology

Currently, CompactFlash cards are available with MLC (multi-level cell) and SLC (single-level cell) flash blocks. SLC flash memory has a service life 10 times longer than MLC, which is why only CompactFlash cards with SLC flash blocks are suited for industrial applications.

9.2.2 Wear leveling

Wear leveling is an algorithm that can be used to maximize the service life of a CompactFlash card. There are three different algorithms:

- No wear leveling
- Dynamic wear leveling
- Static wear leveling

The basic idea behind wear leveling is to distribute data over a broad area of blocks or cells on the disk so that the same areas don't have to be cleared and reprogrammed over and over again.

9.2.2.1 No wear leveling

The earliest CompactFlash cards didn't have an algorithm for maximizing service life. The service life of a CompactFlash card was determined only by the guaranteed lifespan of the flash blocks.

9.2.2.2 Dynamic wear leveling

Dynamic wear leveling makes it possible to utilize unused flash blocks when writing to a file.

If the disk is 80% full with files, then only 20% can be used for wear leveling.

The service life of the CompactFlash card is therefore dependent on the amount of unused flash blocks.

9.2.2.3 Static wear leveling

Static wear leveling monitors which data is rarely modified. From time to time, the controller then moves this data to blocks that have already been used frequently in order to prevent further wear on those cells.

9.2.3 ECC error correction

Bit errors can be caused by inactivity or when a certain cell is being operated. Error correction coding (ECC) implemented via hardware or software can detect and correct many errors of this type.

9.2.4 S.M.A.R.T. support

Self-Monitoring, Analysis and Reporting Technology (S.M.A.R.T.) is an industry standard for mass storage devices that has been introduced to monitor important parameters and quickly detect imminent failures. Critical performance and calibration data is monitored and stored in order to help predict the probability of errors.

9.2.5 Maximum reliability

CompactFlash cards used by B&R use SLC flash blocks and static wear leveling together with a powerful ECC algorithm to provide maximum reliability.

9.3 5CFCRD.xxxx-06

9.3.1 General information

Information:

B&R CompactFlash cards 5CFCRD.xxxx-06 and CompactFlash cards from a different manufacturer cannot be used in the same system at the same time. Due to differences in technology (older vs. newer technologies), problems can occur during system startup that are caused by different boot times.

see "Known problems/issues" on page 267

Information:

5CFCRD.xxxx-06 CompactFlash cards are supported on B&R devices with WinCE version ≥ 6.0 .

9.3.2 Order data

Model number	Short description	Figure
	CompactFlash	
5CFCRD.0512-06	CompactFlash 512 MB B&R (SLC) \geq Rev. F0	
5CFCRD.1024-06	CompactFlash 1 GB B&R (SLC) \geq Rev. F0	
5CFCRD.2048-06	CompactFlash 2 GB B&R (SLC) \geq Rev. F0	
5CFCRD.4096-06	CompactFlash 4 GB B&R (SLC) \geq Rev. F0	
5CFCRD.8192-06	CompactFlash 8 GB B&R (SLC) \geq Rev. F0	
5CFCRD.016G-06	CompactFlash 16 GB B&R (SLC) \geq Rev. E0	
5CFCRD.032G-06	CompactFlash 32 GB B&R (SLC) \geq Rev. D0	

Table 198: 5CFCRD.0512-06, 5CFCRD.1024-06, 5CFCRD.2048-06, 5CFCRD.4096-06, 5CFCRD.8192-06, 5CFCRD.016G-06, 5CFCRD.032G-06 - Order data

Model number	Short description	Figure
	CompactFlash	
5CFCRD.0512-06	CompactFlash 512 MB B&R (SLC) \leq Rev. E0	
5CFCRD.1024-06	CompactFlash 1 GB B&R (SLC) \leq Rev. E0	
5CFCRD.2048-06	CompactFlash 2 GB B&R (SLC) \leq Rev. E0	
5CFCRD.4096-06	CompactFlash 4 GB B&R (SLC) \leq Rev. E0	
5CFCRD.8192-06	CompactFlash 8 GB B&R (SLC) \leq Rev. E0	
5CFCRD.016G-06	CompactFlash 16 GB B&R (SLC) \leq Rev. D0	
5CFCRD.032G-06	CompactFlash 32 GB B&R (SLC) \leq Rev. C0	

Table 199: 5CFCRD.0512-06, 5CFCRD.1024-06, 5CFCRD.2048-06, 5CFCRD.4096-06, 5CFCRD.8192-06, 5CFCRD.016G-06, 5CFCRD.032G-06 - Order data

9.3.3 Technical data

Caution!

A sudden loss of power may result in data loss! In very rare cases, the mass storage device may also become damaged.

To prevent damage and loss of data, the use of a UPS device is recommended.

Information:

The following characteristics, features and limit values only apply to this accessory and can deviate from those specified for the complete system. The data specifications for the complete system take precedence over those of individual components.

Product ID	5CFCRD. 0512-06 ≥ Rev. F0	5CFCRD. 1024-06 ≥ Rev. F0	5CFCRD. 2048-06 ≥ Rev. F0	5CFCRD. 4096-06 ≥ Rev. F0	5CFCRD. 8192-06 ≥ Rev. F0	5CFCRD. 016G-06 ≥ Rev. E0	5CFCRD. 032G-06 ≥ Rev. D0
General information							
Capacity	512 MB	1 GB	2 GB	4 GB	8 GB	16 GB	32 GB
Data retention	10 years						
Data reliability	<1 unrecoverable error in 10 ¹⁴ bit read accesses						
Lifetime monitoring	Yes						
MTBF	>3,000,000 hours (at 25°C)						
Maintenance	None						
Supported operating modes	PIO Mode 0-6, Multiword DMA Mode 0-4, Ultra DMA Mode 0-4						
Continuous reading							
Typical	50 MB/s	50 MB/s	59 MB/s	59 MB/s	59 MB/s	59 MB/s	58 MB/s
Maximum	53 MB/s	53 MB/s	65 MB/s	65 MB/s	65 MB/s	65 MB/s	65 MB/s
Continuous writing							
Typical	25 MB/s	25 MB/s	31 MB/s	31 MB/s	31 MB/s	31 MB/s	31 MB/s
Maximum	27 MB/s	27 MB/s	35 MB/s	35 MB/s	35 MB/s	35 MB/s	35 MB/s
Certification							
CE	Yes						
cULus	Yes						
cULus HazLoc Class 1 Division 2	-	-	-	-	-	Yes ¹⁾	-
ATEX Zone 22	-	-	-	-	-	Yes ¹⁾	-
GOST-R	Yes						
GL	Yes ¹⁾						
Endurance							
SLC flash	Yes						
Guaranteed data volume							
Guaranteed ²⁾	50 TB	100 TB	200 TB	400 TB	800 TB	1600 TB	3200 TB
Over 5 years, equates to ²⁾	27.40 GB/day	54.79 GB/day	109.9 GB/day	219.8 GB/day	438.6 GB/day	876.72 GB/day	1753.44 GB/day
Clear/Write cycles							
Guaranteed	100,000						
Wear leveling	Static						
Error correction coding (ECC)	Yes						
S.M.A.R.T. support	Yes						
Support							
Hardware	PP300/400, PP500, PPC300, PPC700, PPC725, PPC800, APC620, APC810, APC820						
Operating systems							
Windows 7 32-bit	No	No	No	No	No	Yes	Yes
Windows 7 64-bit	No	No	No	No	No	No	Yes
Windows Embedded Standard 7 32-bit	No	No	No	No	Yes	Yes	Yes
Windows Embedded Standard 7 64-bit	No	No	No	No	No	Yes	Yes
Windows XP Professional	No	No	No	Yes	Yes	Yes	Yes
Windows XP Embedded	Yes						
Windows Embedded Standard 2009	No	Yes	Yes	Yes	Yes	Yes	Yes
Windows CE 6.0	Yes	Yes	Yes	Yes	Yes	Yes ³⁾	Yes ³⁾
Windows CE 5.0	No						
Software							
PVI Transfer	≥ V3.2.3.8 (part of PVI Development Setup ≥ V2.06.00.3011)	≥ V3.2.3.8 (part of PVI Development Setup ≥ V2.06.00.3011)	≥ V3.2.3.8 (part of PVI Development Setup ≥ V2.06.00.3011)	≥ V3.2.3.8 (part of PVI Development Setup ≥ V2.06.00.3011)	≥ V3.2.3.8 (part of PVI Development Setup ≥ V2.06.00.3011)	≥ V3.6.8.40 (part of PVI Development Setup ≥ V3.0.0.3020)	≥ V4.0.0.8 (part of PVI Development Setup ≥ V3.0.2.3014)
B&R Embedded OS Installer	≥V3.10	≥V3.10	≥V3.10	≥V3.10	≥V3.10	≥V3.20	≥V3.21

Table 200: 5CFCRD.0512-06, 5CFCRD.1024-06, 5CFCRD.2048-06, 5CFCRD.4096-06, 5CFCRD.8192-06, 5CFCRD.016G-06, 5CFCRD.032G-06 - Technical data

Product ID	5CFCRD.0512-06 ≥ Rev. F0	5CFCRD.1024-06 ≥ Rev. F0	5CFCRD.2048-06 ≥ Rev. F0	5CFCRD.4096-06 ≥ Rev. F0	5CFCRD.8192-06 ≥ Rev. F0	5CFCRD.016G-06 ≥ Rev. E0	5CFCRD.032G-06 ≥ Rev. D0
Environmental conditions							
Temperature							
Operation	0 to 70°C						
Storage	-50 to 100°C						
Transport	-50 to 100°C						
Relative humidity							
Operation	Max. 85% at 85°C						
Storage	Max. 85% at 85°C						
Transport	Max. 85% at 85°C						
Vibration							
Operation	20 g peak, 20 to 2000 Hz, 4 in each direction (JEDEC JESD22, method B103) 5.35 g RMS, 15 min per level (IEC 68-2-6)						
Storage	20 g peak, 20 to 2000 Hz, 4 in each direction (JEDEC JESD22, method B103) 5.35 g RMS, 15 min per level (IEC 68-2-6)						
Transport	20 g peak, 20 to 2000 Hz, 4 in each direction (JEDEC JESD22, method B103) 5.35 g RMS, 15 min per level (IEC 68-2-6)						
Shock							
Operation	1.5 kg peak, 0.5 ms 5 times (JEDEC JESD22, method B110) 30 g, 11 ms 1 times (IEC 68-2-27)						
Storage	1.5 kg peak, 0.5 ms 5 times (JEDEC JESD22, method B110) 30 g, 11 ms 1 times (IEC 68-2-27)						
Transport	1.5 kg peak, 0.5 ms 5 times (JEDEC JESD22, method B110) 30 g, 11 ms 1 times (IEC 68-2-27)						
Altitude							
Operation	Max. 4572 m						
Mechanical characteristics							
Dimensions							
Width	42.8 ±0.10 mm						
Length	36.4 ±0.15 mm						
Height	3.3 ±0.10 mm						
Weight	10 g						

Table 200: 5CFCRD.0512-06, 5CFCRD.1024-06, 5CFCRD.2048-06, 5CFCRD.4096-06, 5CFCRD.8192-06, 5CFCRD.016G-06, 5CFCRD.032G-06 - Technical data

- 1) Yes, although applies only if all components installed within the complete system have this certification
- 2) Endurance of B&R CFs (with linear written block size ≥128 kB).
- 3) Not supported by the B&R Embedded OS Installer.

Caution!

A sudden loss of power may result in data loss! In very rare cases, the mass storage device may also become damaged.

To prevent damage and loss of data, the use of a UPS device is recommended.

Information:

The following characteristics, features and limit values only apply to this accessory and can deviate from those specified for the complete system. The data specifications for the complete system take precedence over those of individual components.

Product ID	5CFCRD.0512-06 ≤ Rev. E0	5CFCRD.1024-06 ≤ Rev. E0	5CFCRD.2048-06 ≤ Rev. E0	5CFCRD.4096-06 ≤ Rev. E0	5CFCRD.8192-06 ≤ Rev. E0	5CFCRD.016G-06 ≤ Rev. D0	5CFCRD.032G-06 ≤ Rev. C0
General information							
Capacity	512 MB	1 GB	2 GB	4 GB	8 GB	16 GB	32 GB
Data retention	10 years						
Data reliability	<1 unrecoverable error in 10 ¹⁴ bit read accesses						
Lifetime monitoring	Yes						
MTBF	>3,000,000 hours (at 25°C)						
Maintenance	None						
Supported operating modes	PIO Mode 0-6, Multiword DMA Mode 0-4, Ultra DMA Mode 0-4						
Continuous reading							
Typical	33 MB/s	33 MB/s	33 MB/s	33 MB/s	33 MB/s	36 MB/s	36 MB/s
Maximum	35 MB/s	35 MB/s	35 MB/s	34 MB/s	34 MB/s	37 MB/s	37 MB/s
Continuous writing							
Typical	15 MB/s	15 MB/s	15 MB/s	14 MB/s	14 MB/s	28 MB/s	28 MB/s
Maximum	18 MB/s	18 MB/s	18 MB/s	17 MB/s	17 MB/s	30 MB/s	30 MB/s

Table 201: 5CFCRD.0512-06, 5CFCRD.1024-06, 5CFCRD.2048-06, 5CFCRD.4096-06, 5CFCRD.8192-06, 5CFCRD.016G-06, 5CFCRD.032G-06 - Technical data

Product ID	5CFCRD.0512-06 ≤ Rev. E0	5CFCRD.1024-06 ≤ Rev. E0	5CFCRD.2048-06 ≤ Rev. E0	5CFCRD.4096-06 ≤ Rev. E0	5CFCRD.8192-06 ≤ Rev. E0	5CFCRD.016G-06 ≤ Rev. D0	5CFCRD.032G-06 ≤ Rev. C0	
Certification								
CE	Yes							
cULus	Yes							
cULus HazLoc Class 1 Division 2	-	-	-	-	-	Yes ¹⁾	-	
ATEX Zone 22	-	-	-	-	-	Yes ¹⁾	-	
GOST-R	Yes							
GL	Yes ¹⁾							
Endurance								
SLC flash	Yes							
Guaranteed data volume								
Guaranteed ²⁾	50 TB	100 TB	200 TB	400 TB	800 TB	1600 TB	3200 TB	
Over 5 years, equates to ²⁾	27.40 GB/day	54.79 GB/day	109.9 GB/day	219.8 GB/day	438.6 GB/day	876.72 GB/day	1753.44 GB/day	
Clear/Write cycles								
Guaranteed	100,000							
Wear leveling	Static							
Error correction coding (ECC)	Yes							
S.M.A.R.T. support	Yes							
Support								
Hardware	PP300/400, PP500, PPC300, PPC700, PPC725, PPC800, APC620, APC810, APC820							
Operating systems								
Windows 7 32-bit	No	No	No	No	No	Yes	Yes	
Windows 7 64-bit	No	No	No	No	No	No	Yes	
Windows Embedded Standard 7 32-bit	No	No	No	No	Yes	Yes	Yes	
Windows Embedded Standard 7 64-bit	No	No	No	No	No	Yes	Yes	
Windows XP Professional	No	No	No	Yes	Yes	Yes	Yes	
Windows XP Embedded	Yes							
Windows Embedded Standard 2009	No	Yes	Yes	Yes	Yes	Yes	Yes	
Windows CE 6.0	Yes	Yes	Yes	Yes	Yes	Yes ³⁾	Yes ³⁾	
Windows CE 5.0	No							
Software								
PVI Transfer	≥ V3.2.3.8 (part of PVI Development Setup ≥ V2.06.00.3011)	≥ V3.2.3.8 (part of PVI Development Setup ≥ V2.06.00.3011)	≥ V3.2.3.8 (part of PVI Development Setup ≥ V2.06.00.3011)	≥ V3.2.3.8 (part of PVI Development Setup ≥ V2.06.00.3011)	≥ V3.2.3.8 (part of PVI Development Setup ≥ V2.06.00.3011)	≥ V3.2.3.8 (part of PVI Development Setup ≥ V2.06.00.3011)	≥ V3.6.8.40 (part of PVI Development Setup ≥ V3.0.0.3020)	≥ V4.0.0.8 (part of PVI Development Setup ≥ V3.0.2.3014)
B&R Embedded OS Installer	≥V3.10	≥V3.10	≥V3.10	≥V3.10	≥V3.10	≥V3.10	≥V3.20	≥V3.21
Environmental conditions								
Temperature								
Operation	0 to 70°C							
Storage	-50 to 100°C							
Transport	-50 to 100°C							
Relative humidity								
Operation	Max. 85% at 85°C							
Storage	Max. 85% at 85°C							
Transport	Max. 85% at 85°C							
Vibration								
Operation	20 g peak, 20 to 2000 Hz, 4 in each direction (JEDEC JESD22, method B103) 5.35 g RMS, 15 min per level (IEC 68-2-6)							
Storage	20 g peak, 20 to 2000 Hz, 4 in each direction (JEDEC JESD22, method B103) 5.35 g RMS, 15 min per level (IEC 68-2-6)							
Transport	20 g peak, 20 to 2000 Hz, 4 in each direction (JEDEC JESD22, method B103) 5.35 g RMS, 15 min per level (IEC 68-2-6)							
Shock								
Operation	1.5 kg peak, 0.5 ms 5 times (JEDEC JESD22, method B110) 30 g, 11 ms 1 times (IEC 68-2-27)							
Storage	1.5 kg peak, 0.5 ms 5 times (JEDEC JESD22, method B110) 30 g, 11 ms 1 times (IEC 68-2-27)							
Transport	1.5 kg peak, 0.5 ms 5 times (JEDEC JESD22, method B110) 30 g, 11 ms 1 times (IEC 68-2-27)							
Altitude								
Operation	Max. 4572 m							
Mechanical characteristics								
Dimensions								
Width	42.8 ±0.10 mm							
Length	36.4 ±0.15 mm							
Height	3.3 ±0.10 mm							
Weight	10 g							

Table 201: 5CFCRD.0512-06, 5CFCRD.1024-06, 5CFCRD.2048-06, 5CFCRD.4096-06, 5CFCRD.8192-06, 5CFCRD.016G-06, 5CFCRD.032G-06 - Technical data

- 1) Yes, although applies only if all components installed within the complete system have this certification
- 2) Endurance of B&R CFs (with linear written block size ≥128 kB).
- 3) Not supported by the B&R Embedded OS Installer.

9.3.4 Temperature/Humidity diagram

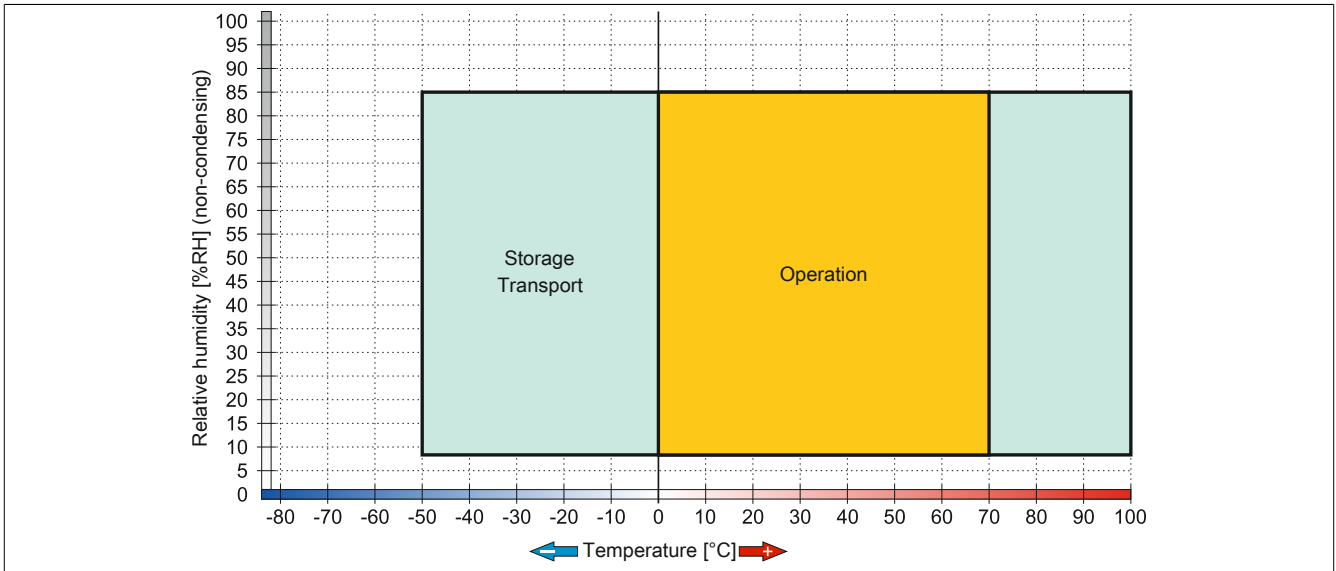

Figure 144: 5CFCRD.xxxx-06 - Temperature/Humidity diagram for CompactFlash cards

9.3.5 Dimensions

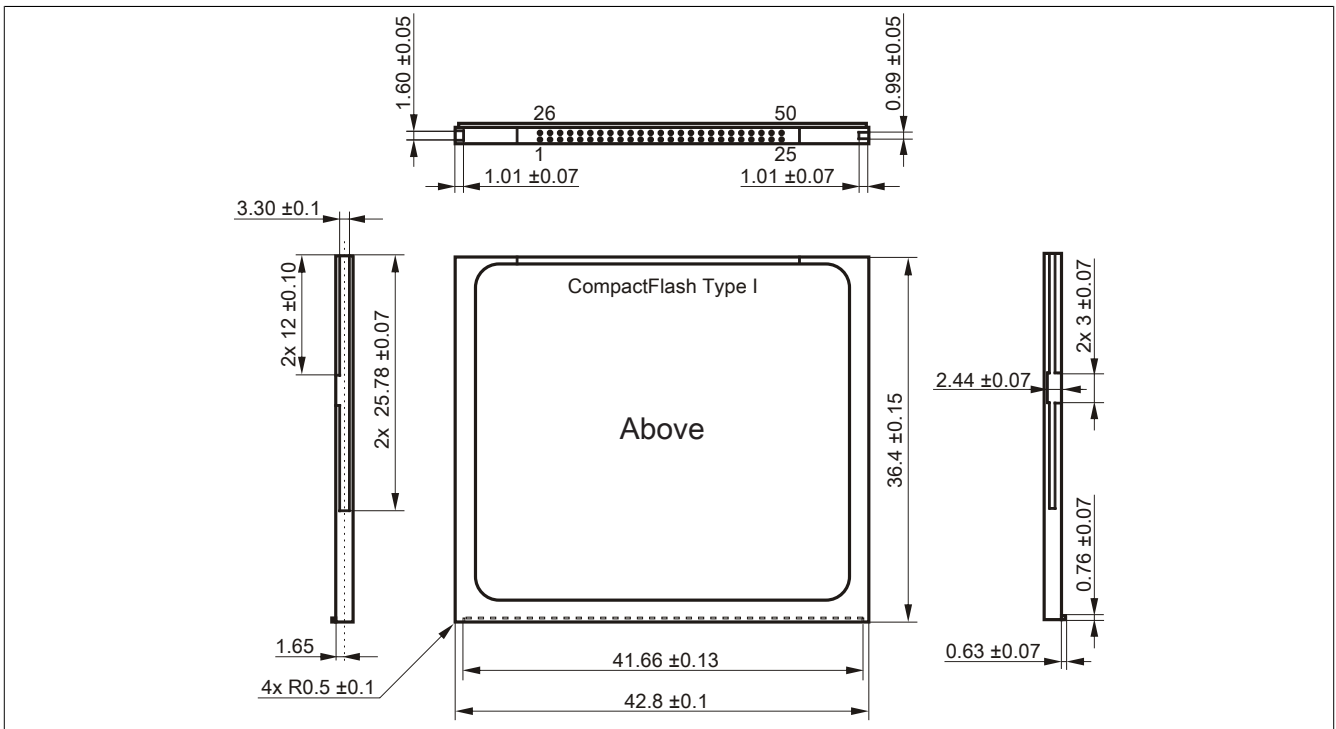

Figure 145: Type I CompactFlash card - Dimensions

9.3.6 Benchmark

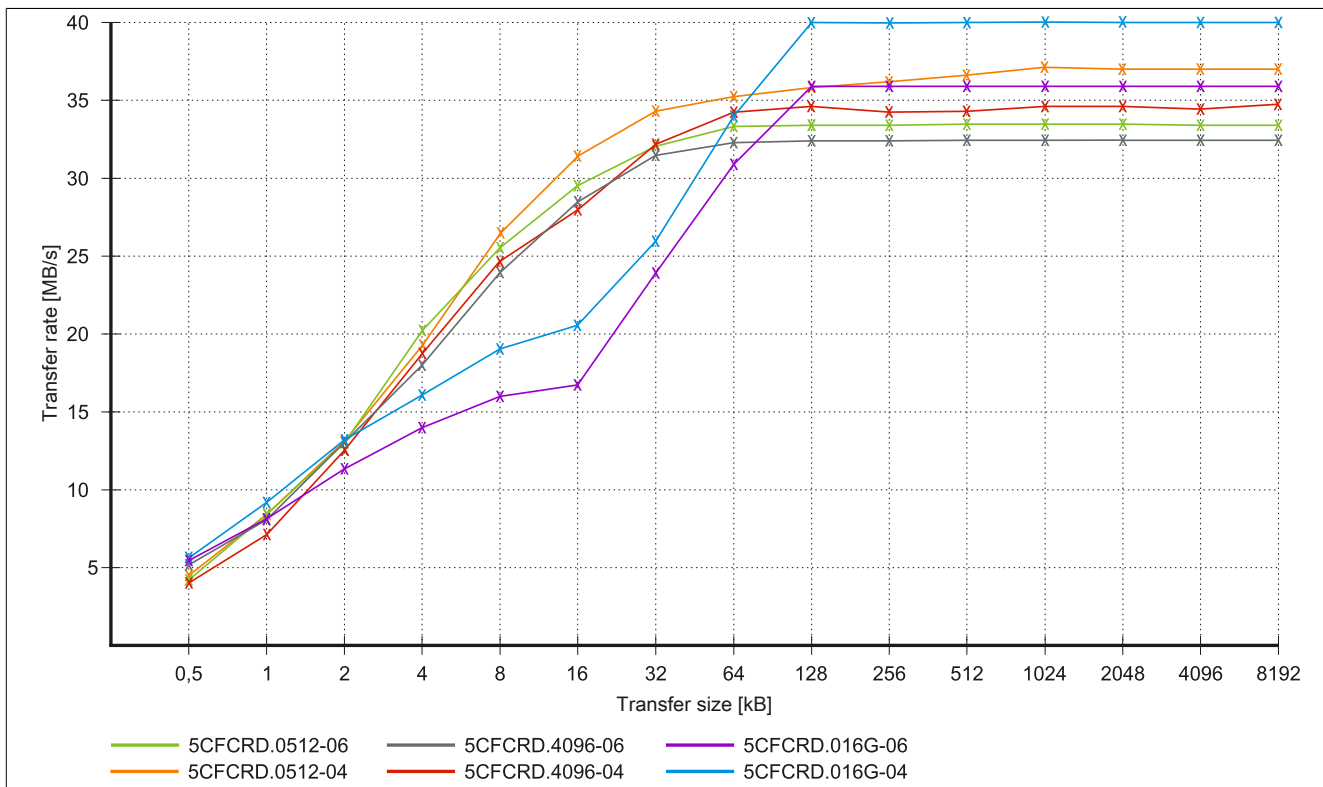

Figure 146: ATTO Disk Benchmark v2.34 read comparison - 5CFCRD.xxxx-04 and 5CFCRD.xxxx-06

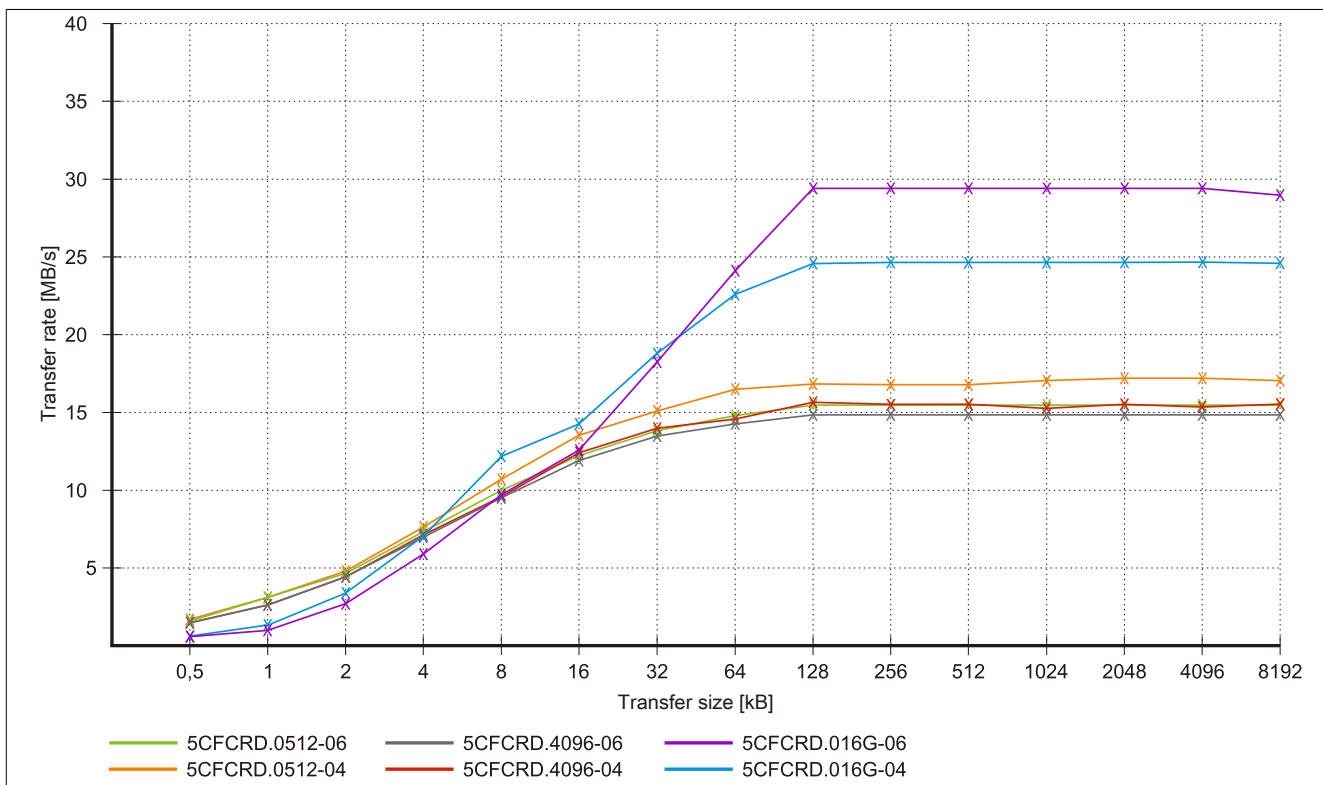

Figure 147: ATTO Disk Benchmark v2.34 write comparison - 5CFCRD.xxxx-04 and 5CFCRD.xxxx-06

9.4 5CFCRD.xxxx-03

9.4.1 General information

Information:

Western Digital CompactFlash cards 5CFCRD.xxxx and CompactFlash cards from a different manufacturer cannot be used in the same system at the same time. Due to differences in technology (older vs. newer technologies), problems can occur during system startup that are caused by different boot times.

see "Known problems/issues" on page 267

Information:

On Windows CE 5.0 devices, 5CFCRD.xxxx-03 CompactFlash cards up to 1 GB are supported.

Information:

On CompactFlash cards 5CFCRD.xxxx-03, only the sticker and the description have changed. The technical data has not been changed.

9.4.2 Order data

Model number	Short description	Figure
	CompactFlash-cards	
5CFCRD.0064-03	CompactFlash 64 MB Western Digital (SLC)	
5CFCRD.0128-03	CompactFlash 128 MB Western Digital (SLC)	
5CFCRD.0256-03	CompactFlash 256 MB Western Digital (SLC)	
5CFCRD.0512-03	CompactFlash 512 MB Western Digital (SLC)	
5CFCRD.1024-03	CompactFlash 1 GB Western Digital (SLC)	
5CFCRD.2048-03	CompactFlash 2 GB Western Digital (SLC)	
5CFCRD.4096-03	CompactFlash 4 GB Western Digital (SLC)	
5CFCRD.8192-03	CompactFlash 8 GB Western Digital (SLC)	

Table 202: 5CFCRD.0064-03, 5CFCRD.0128-03, 5CFCRD.0256-03, 5CFCRD.0512-03, 5CFCRD.1024-03, 5CFCRD.2048-03, 5CFCRD.4096-03, 5CFCRD.8192-03 - Order data

9.4.3 Technical data

Caution!

A sudden loss of power may result in data loss! In very rare cases, the mass storage device may also become damaged.

To prevent damage and loss of data, B&R recommends that you use a UPS device.

Information:

The following characteristics, features and limit values only apply to this accessory and can deviate from those specified for the complete system. The data specifications for the complete system take precedence over those of individual components.

Product ID	5CFCRD.0064-03	5CFCRD.0128-03	5CFCRD.0256-03	5CFCRD.0512-03	5CFCRD.1024-03	5CFCRD.2048-03	5CFCRD.4096-03	5CFCRD.8192-03
General information								
Capacity	64 MB	128 MB	256 MB	512 MB	1 GB	2 GB	4 GB	8 GB
Data retention	10 years							
Data reliability	<1 unrecoverable error in 10 ¹⁴ bit read accesses							
Lifetime monitoring	Yes							

Table 203: 5CFCRD.0064-03, 5CFCRD.0128-03, 5CFCRD.0256-03, 5CFCRD.0512-03, 5CFCRD.1024-03, 5CFCRD.2048-03, 5CFCRD.4096-03, 5CFCRD.8192-03 - Technical data

Product ID	5CFCRD.0064-03	5CFCRD.0128-03	5CFCRD.0256-03	5CFCRD.0512-03	5CFCRD.1024-03	5CFCRD.2048-03	5CFCRD.4096-03	5CFCRD.8192-03
MTBF	>4,000,000 hours (at 25°C)							
Maintenance	None							
Supported operating modes	PIO Mode 0-4, Multiword DMA Mode 0-2							
Sequential read Typical	8 MB/s							
Sequential write Typical	6 MB/s							
Certification CE cULus GOST-R GL	Yes Yes Yes Yes ¹⁾							
Endurance								
SLC flash	Yes							
Clear/Write cycles Typical	>2,000,000							
Wear leveling	Static							
Error correction coding (ECC)	Yes							
S.M.A.R.T. support	No							
Support								
Hardware	MP100/200, PP100/200, PP300/400, PP500, PPC300, PPC700, PPC725, PPC800, Provit 2000, Provit 5000, APC620, APC680, APC810, APC820							
Operating systems								
Windows 7 32-bit	No							
Windows 7 64-bit	No							
Windows Embedded Standard 7, 32-bit	No	No	No	No	No	No	No	Yes
Windows Embedded Standard 7, 64-bit	No							
Windows XP Professional	No	No	No	No	No	No	Yes	Yes
Windows XP Embedded	No	No	No	Yes	Yes	Yes	Yes	Yes
Windows Embedded Standard 2009	No	No	No	No	Yes	Yes	Yes	Yes
Windows CE 6.0	Yes	Yes	Yes	Yes	Yes	Yes	Yes	Yes ²⁾
Windows CE 5.0	Yes	Yes	Yes	Yes	Yes	No	No	No
Software								
PVI Transfer	≥V2.57 (part of PVI Development Setup ≥ V2.5.3.3005)							
B&R Embedded OS Installer	≥V2.21							
Environmental conditions								
Temperature								
Operation	0 to 70°C							
Storage	-50 to 100°C							
Transport	-50 to 100°C							
Relative humidity								
Operation	8 to 95%, non-condensing							
Storage	8 to 95%, non-condensing							
Transport	8 to 95%, non-condensing							
Vibration								
Operation	Max. 16.3 g (159 m/s ² 0-peak)							
Storage	Max. 30 g (294 m/s ² 0-peak)							
Transport	Max. 30 g (294 m/s ² 0-peak)							
Shock								
Operation	Max. 1000 g (9810 m/s ² 0-peak)							
Storage	Max. 3000 g (29430 m/s ² 0-peak)							
Transport	Max. 3000 g (29430 m/s ² 0-peak)							
Altitude								
Operation	Max. 24383 m							
Mechanical characteristics								
Dimensions								
Width	42.8 ±0.10 mm							
Length	36.4 ±0.15 mm							
Height	3.3 ±0.10 mm							
Weight	11.4 g							

Table 203: 5CFCRD.0064-03, 5CFCRD.0128-03, 5CFCRD.0256-03, 5CFCRD.0512-03, 5CFCRD.1024-03, 5CFCRD.2048-03, 5CFCRD.4096-03, 5CFCRD.8192-03 - Technical data

- 1) Yes, although applies only if all components installed within the complete system have this certification
- 2) Not supported by the B&R Embedded OS Installer.

9.4.4 Temperature/Humidity diagram

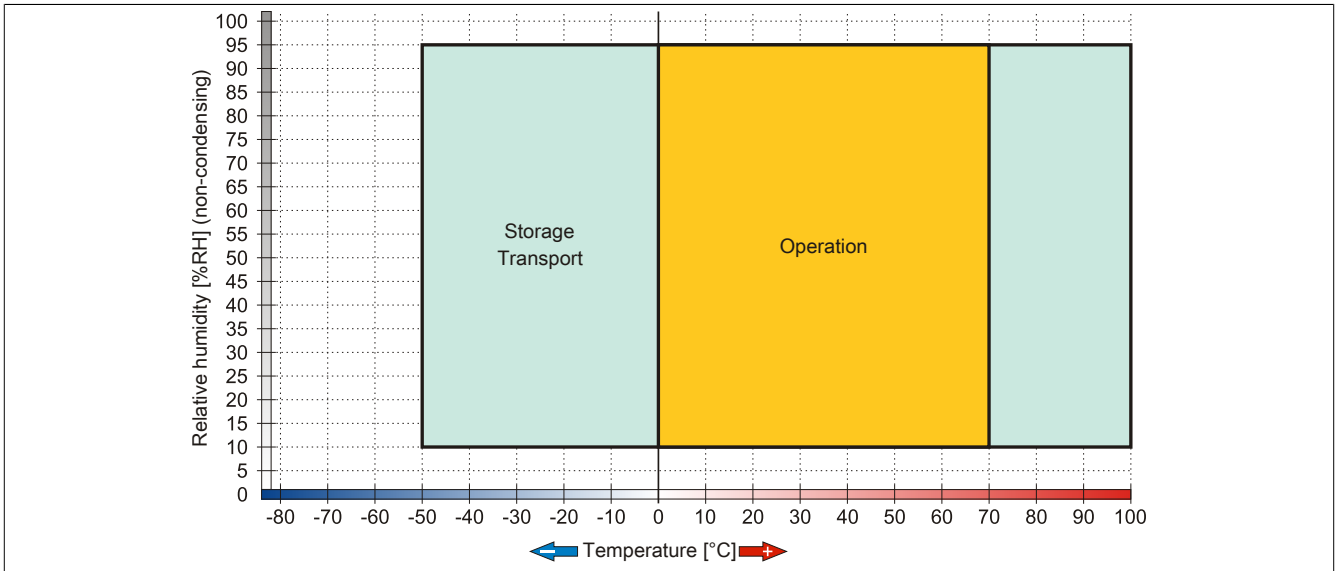

Figure 148: 5CFCRD.xxxx-03 - Temperature/Humidity diagram for CompactFlash cards

9.4.5 Dimensions

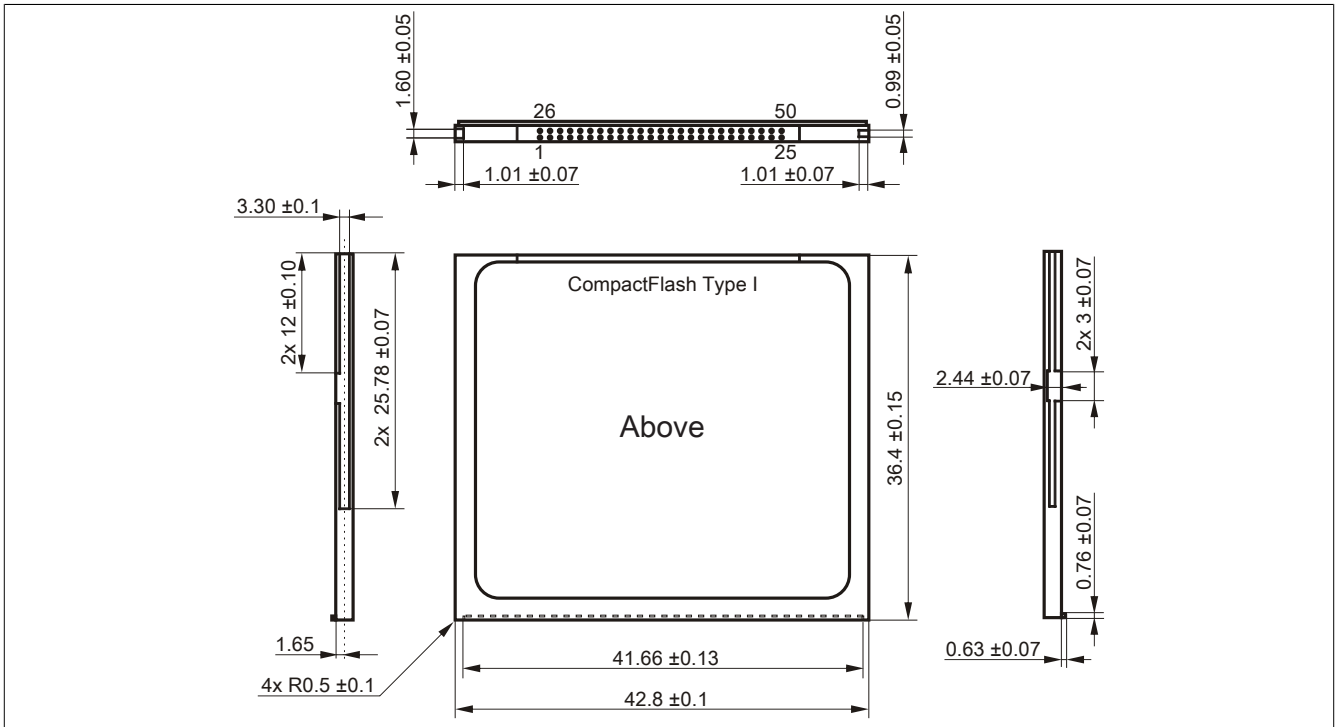

Figure 149: Type I CompactFlash card - Dimensions

9.5 Known problems/issues

The following is a known issue for devices with two CompactFlash slots:

- Using two different types of CompactFlash cards can cause problems with Automation PCs and Panel PCs. For example, it is possible that one of the two cards is not detected during system startup. This is caused by different startup speeds. CompactFlash cards with older technology require significantly more time during system startup than CompactFlash cards with newer technology. This behavior occurs near the end of the time frame provided for startup. The problem described can occur because the startup time for the CompactFlash cards fluctuates due to the different components being used. Depending on the CompactFlash card being used, this error might never, sometimes or always occur.

10 USB flash drives

10.1 5MMUSB.2048-00

10.1.1 General information

USB flash drives are storage media that are easy to exchange. Because of their fast data transfer (USB 2.0), USB flash drives are ideal for use as portable data storage. Without requiring additional drivers ("hot plugging", except in the case of Windows 98SE), the USB flash drive can immediately act as an additional drive for reading or writing data.

Information:

Due to the vast quantity of USB flash drives available on the market as well as their short product life cycle, we reserve the right to supply alternative products at any time. The following measures may therefore be necessary in order to boot from these flash drives as well:

- The flash drive must be reformatted or in some cases even repartitioned (set active partition).
- The flash drive must be the first bootable device in the BIOS boot order; alternatively, the IDE controllers can be disabled in BIOS. This can be avoided in most cases if the "fdisk /mbr" command is additionally executed on the USB flash drive.

10.1.2 Order data

Model number	Short description	Figure
	USB accessories	
5MMUSB.2048-00	USB 2.0 flash drive, 2048 MB	

Table 204: 5MMUSB.2048-00 - Order data

10.1.3 Technical data

Information:

The following characteristics, features and limit values only apply to this accessory and can deviate from those specified for the complete system. The data specifications for the complete system take precedence over those of individual components.

Product ID	5MMUSB.2048-00
General information	
Data retention	10 years
LEDs	1 LED (green) ¹⁾
MTBF	100,000 hours (at 25°C)
Type	USB 1.1, USB 2.0
Maintenance	None
Certification CE	Yes
Interfaces	
USB	
Type	USB 1.1, USB 2.0
Connection	To any USB type A interface
Transfer rate	Low speed (1.5 Mbit/s), full speed (12 Mbit/s), high speed (480 Mbit/s)
Sequential reading	Max. 8.7 MB/s
Sequential writing	Max. 1.7 MB/s
Support	
Operating systems	
Windows XP Professional	Yes
Windows XP Embedded	Yes
Windows ME	Yes
Windows 2000	Yes
Windows CE 5.0	Yes
Windows CE 4.2	Yes
Electrical characteristics	
Power consumption	650 µA sleep mode, 150 mA read/write

Table 205: 5MMUSB.2048-00 - Technical data

Product ID	5MMUSB.2048-00
Environmental conditions	
Temperature	
Operation	0 to 45°C
Storage	-20 to 60°C
Transport	-20 to 60°C
Relative humidity	
Operation	10 to 90%, non-condensing
Storage	5 to 90%, non-condensing
Transport	5 to 90%, non-condensing
Vibration	
Operation	10 to 500 Hz: 2 g (19.6 m/s ² 0-peak), oscillation rate 1/minute
Storage	10 to 500 Hz: 2 g (19.6 m/s ² 0-peak), oscillation rate 1/minute
Transport	10 to 500 Hz: 2 g (19.6 m/s ² 0-peak), oscillation rate 1/minute
Shock	
Operation	Max. 40 g (392 m/s ² 0-peak) and 11 ms duration
Storage	Max. 80 g (784 m/s ² 0-peak) and 11 ms duration
Transport	Max. 80 g (784 m/s ² 0-peak) and 11 ms duration
Altitude	
Operation	Max. 3048 m
Storage	Max. 12192 m
Transport	Max. 12192 m
Mechanical characteristics	
Dimensions	
Width	19 mm
Length	52.2 mm
Height	7.9 mm

Table 205: 5MMUSB.2048-00 - Technical data

1) Indicates data being transferred (sending and receiving).

10.1.4 Temperature/Humidity diagram

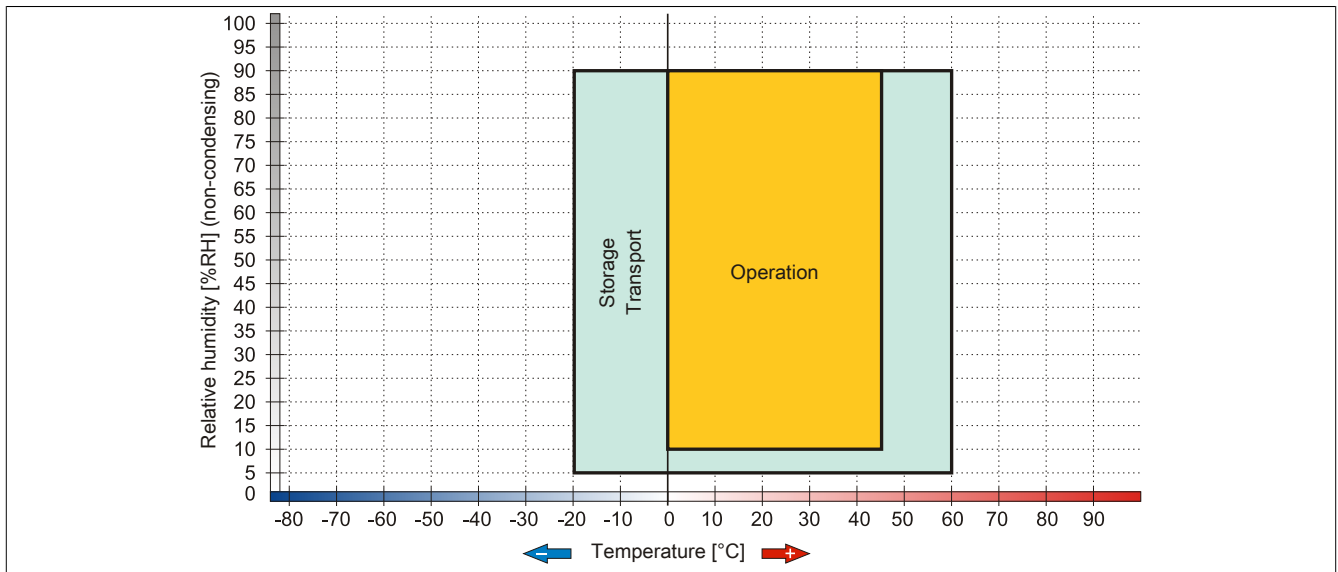

Figure 150: 5MMUSB.2048-00 - Temperature/Humidity diagram

10.2 5MMUSB.xxxx-01

10.2.1 General information

USB flash drives are storage media that are easy to exchange. Because of their fast data transfer (USB 2.0), USB flash drives are ideal for use as portable data storage. Without requiring additional drivers ("hot plugging", except in the case of Windows 98SE), the USB flash drive can immediately act as an additional drive for reading or writing data.

Information:

Due to the vast quantity of USB flash drives available on the market as well as their short product life cycle, we reserve the right to supply alternative products at any time. The following measures may therefore be necessary in order to boot from these flash drives as well:

- The flash drive must be reformatted or in some cases even repartitioned (set active partition).
- The flash drive must be the first bootable device in the BIOS boot order; alternatively, the IDE controllers can be disabled in BIOS. This can be avoided in most cases if the "fdisk /mbr" command is additionally executed on the USB flash drive.

10.2.2 Order data

Model number	Short description	Figure
	USB accessories	
5MMUSB.2048-01	USB 2.0 flash drive, 2048 MB, B&R	
5MMUSB.4096-01	USB 2.0 flash drive, 4096 MB, B&R	

Table 206: 5MMUSB.2048-01, 5MMUSB.4096-01 - Order data

10.2.3 Technical data

Product ID	5MMUSB.2048-01	5MMUSB.4096-01
General information		
Capacity	2 GB	4 GB
LEDs	1 LED (green) ¹⁾	
MTBF	>3,000,000 hours	
Type	USB 1.1, USB 2.0	
Maintenance	None	
Default file system	FAT16	FAT32
Certification		
CE	Yes	
GOST-R	Yes	
Interfaces		
USB		
Type	USB 1.1, USB 2.0	
Connection	To any USB type A interface	
Transfer rate	Low speed (1.5 Mbit/s), full speed (12 Mbit/s), high speed (480 Mbit/s)	
Sequential reading	Full speed max. 1 MB/s, High speed max. 32 MB/s	
Sequential writing	Full speed max. 0.9 MB/s, High speed max. 23 MB/s	
Endurance		
SLC flash	Yes	
Data retention	>10 years	
Data reliability	<1 unrecoverable error in 10 ¹⁴ bit read accesses	
Connection cycles	>1,500	
Support		
Operating systems		
Windows 7	Yes	
Windows XP Professional	Yes	
Windows XP Embedded	Yes	
Windows ME	Yes	
Windows 2000	Yes	
Windows CE 5.0	Yes	
Windows CE 4.2	Yes	
Electrical characteristics		
Current consumption	Max. 500 µA sleep mode, max. 120 mA read/write	

Table 207: 5MMUSB.2048-01, 5MMUSB.4096-01 - Technical data

Product ID	5MMUSB.2048-01	5MMUSB.4096-01
Environmental conditions		
Temperature		
Operation	0 to 70°C	
Storage	-50 to 100°C	
Transport	-50 to 100°C	
Relative humidity		
Operation	85%, non-condensing	
Storage	85%, non-condensing	
Transport	85%, non-condensing	
Vibration		
Operation	20 to 2000 Hz: 20 g (peak)	
Storage	20 to 2000 Hz: 20 g (peak)	
Transport	20 to 2000 Hz: 20 g (peak)	
Shock		
Operation	Max. 1500 g (peak)	
Storage	Max. 1500 g (peak)	
Transport	Max. 1500 g (peak)	
Altitude		
Operation	Max. 3048 m	
Storage	Max. 12192 m	
Transport	Max. 12192 m	
Mechanical characteristics		
Dimensions		
Width	17.97 mm	
Length	67.85 mm	
Height	8.35 mm	

Table 207: 5MMUSB.2048-01, 5MMUSB.4096-01 - Technical data

1) Indicates data being transferred (sending and receiving).

10.2.4 Temperature/Humidity diagram

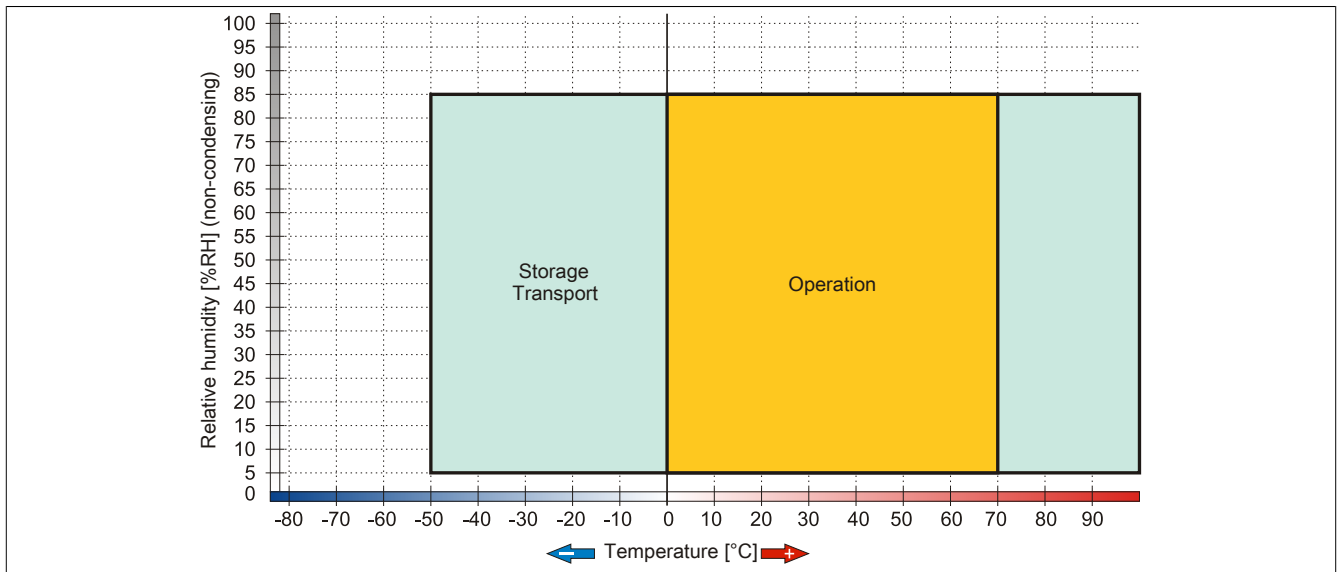

Figure 151: 5MMUSB.xxxx-01 - Temperature/Humidity diagram

11 USB media drive

11.1 5MD900.USB2-02

11.1.1 General information

The USB media drive features a DVD-R/RW DVD+R/RW drive, a CompactFlash slot and one USB port on both the front and back. It is connected to a USB port on the B&R Industrial PC.

- Desktop or rack-mounted operation (mounting rail brackets)
- Integrated DVD-R/RW DVD+R/RW drive
- Integrated IDE/ATAPI CompactFlash slot (hot pluggable)
- Integrated USB 2.0 connection
- +24 VDC supply (back)
- USB 2.0 connection (back)
- Optional front cover

11.1.2 Order data

Model number	Short description	Figure
USB accessories		
5MD900.USB2-02	USB 2.0 drive combination - DVD-R/RW, DVD+R/RW - CompactFlash slot	
Required accessories		
Other		
5SWUTI.0000-00	OEM Nero CD-RW Software, only available with a CD writer.	
Terminal blocks		
0TB103.9	Connector 24 VDC - 3-pin female - Screw clamps 3.31 mm ²	
0TB103.91	Connector 24 VDC - 3-pin female - Cage clamps 3.31 mm ²	
USB cables		
5CAUSB.0018-00	USB 2.0 connection cable type A - type B, 1.8 m	
5CAUSB.0050-00	USB 2.0 connection cable type A - type B, 5 m	

Table 208: 5MD900.USB2-02 - Order data

11.1.3 Interfaces

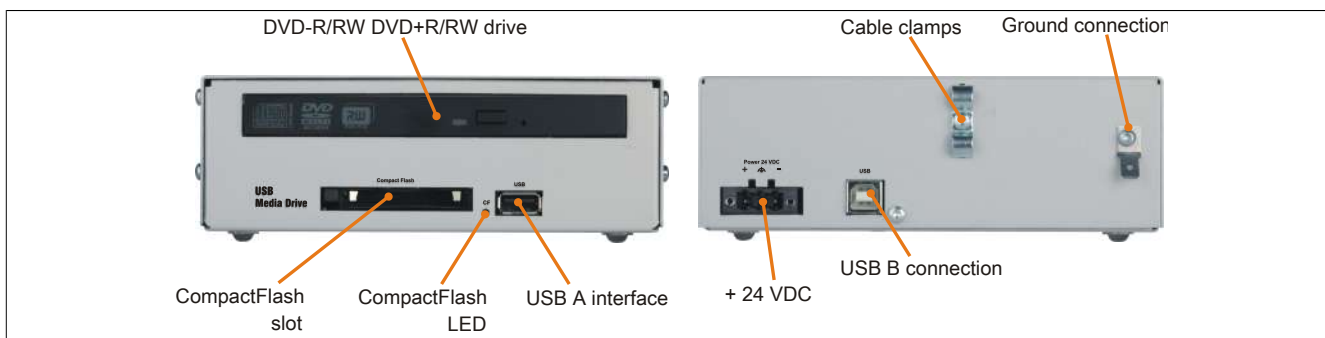

Figure 152: 5MD900.USB2-02 - Interfaces

11.1.4 Technical data

Product ID	5MD900.USB2-02
General information	
Max. cable length	5 m (not including hub)
Certification	
CE	Yes
cULus	Yes
GOST-R	Yes
Interfaces	
CompactFlash slot 1	
Type	Type I
Connection	IDE/ATAPI
Activity LED	Signals read or write access to an inserted CompactFlash card

Table 209: 5MD900.USB2-02 - Technical data

Product ID	5MD900.USB2-02
USB	
Type	USB 2.0
Execution	Type A front Type B back
Transfer rate	Low speed (1.5 Mbit/s), full speed (12 Mbit/s), high speed (480 Mbit/s)
Current load	Max. 500 mA
CD / DVD drive	
Data buffer capacity	2 MB
Data transfer rate	Max. 33.3 MB/s
Speed	Max. 5090 rpm \pm 1%
Noise level	Approx. 45 dBA in a distance of 50 cm (full read access)
Compatible formats	CD-DA, CD-ROM mode 1/mode 2 CD-ROM XA mode 2 (form 1, form 2) Photo CD (single-/multi-session), Enhanced CD, CD text DVD-ROM, DVD-R, DVD-RW, DVD-Video DVD-RAM (4.7GB, 2.6GB) DVD+R, DVD+R (dual layer), DVD+RW
Laser class	Class 1 laser
Service life	60000 POH (power-on hours)
Interface	IDE (ATAPI)
Startup time	
CD	Max. 14 seconds (from 0 rpm to read access)
DVD	Max. 15 seconds (from 0 rpm to read access)
Access time	
CD	Typ. 140 ms (24x)
DVD	Typ. 150 ms (8x)
Readable media	
CD	CD/CD-ROM (12 cm, 8 cm), CD-R, CD-RW
DVD	DVD-ROM, DVD-R, DVD-RW, DVD-RAM, DVD+R, DVD+R (dual layer), DVD+RW
Writable media	
CD	CD-R, CD-RW
DVD	DVD-R/RW, DVD-RAM (4.7 GB), DVD+R/RW, DVD+R (dual layer)
Read speed	
CD	24x
DVD	8x
Write speed	
CD-R	10 to 24x
CD-RW	10 to 24x
DVD+R	3.3 to 8x
DVD+R (dual layer)	2.4 to 4x
DVD+RW	3.3 to 8x
DVD-R	2 to 6x
DVD-R (dual layer)	2 to 4x
DVD-RAM	3 to 5x
DVD-RW	2 to 6x
Write methods	
CD	Disk at once, session at once, packet write, track at once
DVD	Disk at once, incremental, overwrite, sequential
Electrical characteristics	
Nominal voltage	24 VDC \pm 25%
Operating conditions	
EN 60529 protection	Front: IP65 (only with optional front cover), back: IP20
Environmental conditions	
Temperature ¹⁾	
Operation	5 to 45°C
Storage	-20 to 60°C
Transport	-40 to 60°C
Relative humidity	
Operation	20 to 80%
Storage	5 to 90%
Transport	5 to 95%
Vibration	
Operation	5 to 500 Hz: 0.3 g (2.9 m/s ² 0-peak)
Storage	10 to 100 Hz: 2 g (19.6 m/s ² 0-peak)
Transport	10 to 100 Hz: 2 g (19.6 m/s ² 0-peak)
Shock	
Operation	5 g, 11 ms
Storage	60 g, 11 ms
Transport	60 g, 11 ms
Altitude	
Operation	Max. 3000 m

Table 209: 5MD900.USB2-02 - Technical data

Product ID	5MD900.USB2-02
Mechanical characteristics	
Dimensions	
Width	156 mm
Height	52 mm
Depth	140 mm
Weight	Approx. 1100 g (without front cover)

Table 209: 5MD900.USB2-02 - Technical data

- Temperature specifications refer to operation at 500 meters. The maximum ambient temperature is typically derated by 1°C per 1000 meters (starting at 500 meters above sea level).

11.1.5 Dimensions

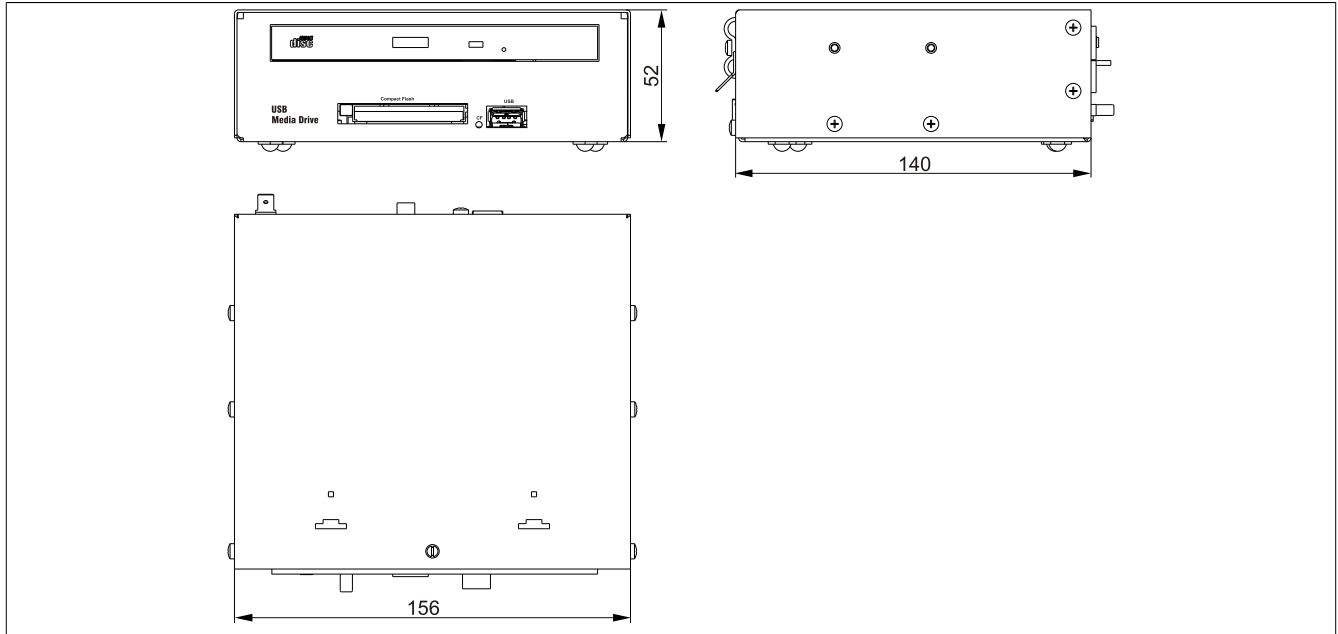

Figure 153: 5MD900.USB2-02 - Dimensions

11.1.6 Dimensions with front cover

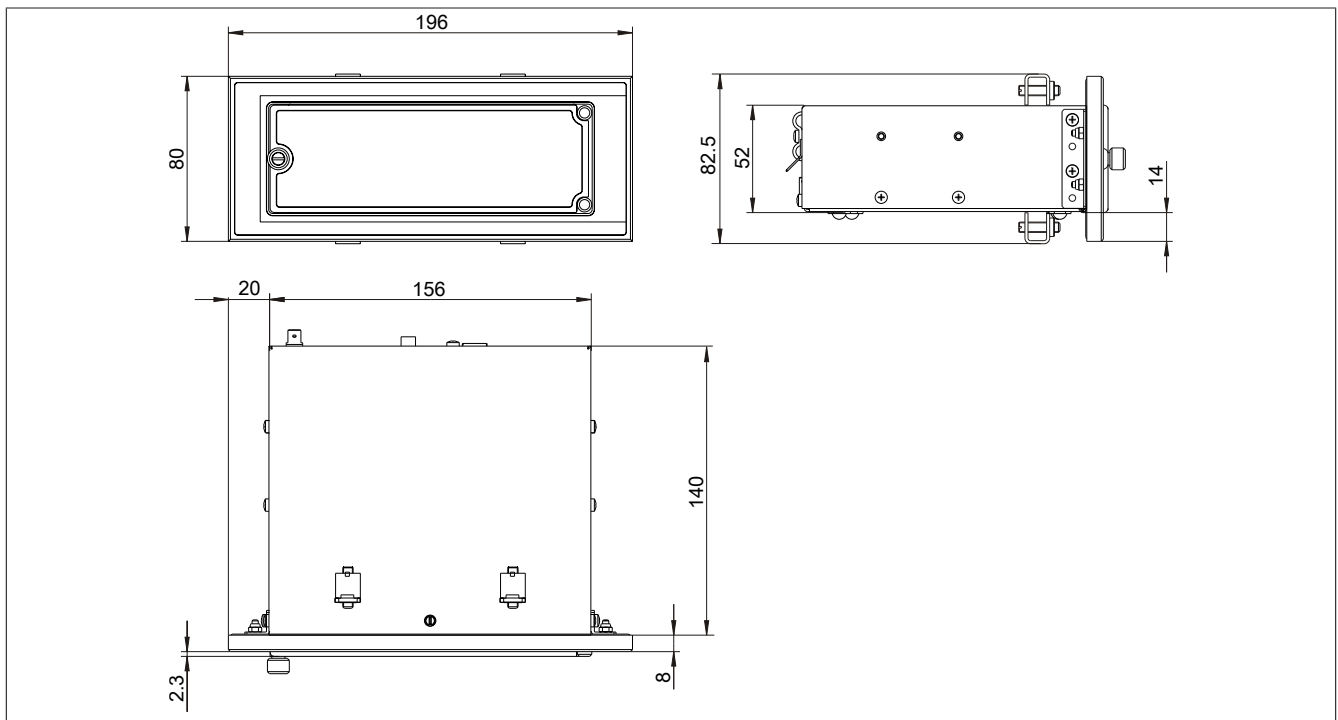

Figure 154: USB media drive with front cover - Dimensions

11.1.7 Cutout installation

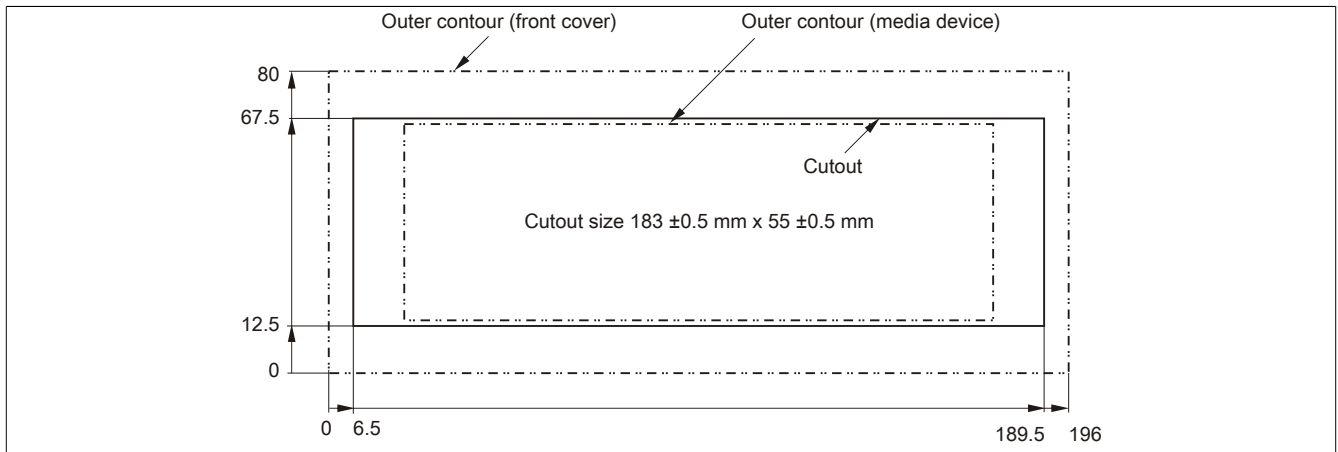

Figure 155: USB media drive with front cover - Installation cutout

11.1.8 Contents of delivery

Quantity	Component
1	USB media drive
2	Mounting rail brackets

Table 210: 5MD900.USB2-02 - Contents of delivery

11.1.9 Installation

The USB media drive can be operated as a desktop device (rubber feet) or as a rack-mounted device (2 mounting rail brackets included).

11.1.9.1 Mounting orientation

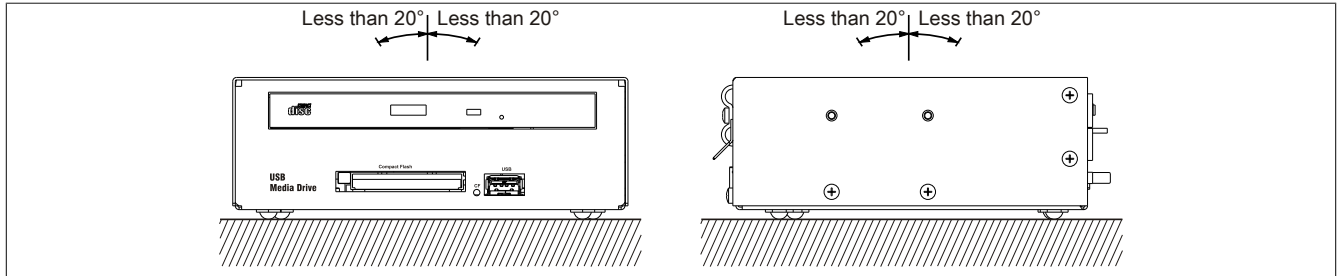

Figure 156: 5MD900.USB2-02 - Mounting orientation

11.2 5A5003.03

11.2.1 General information

This front cover can be mounted on the front of the USB media drive (model number 5MD900.USB2-00, 5MD900.USB2-01 or 5MD900.USB2-02) to protect the interface.

11.2.2 Order data

Model number	Short description	Figure
	USB accessories	
5A5003.03	Front cover for drives - 5A5003.02 - 5MD900.USB2	

Table 211: 5A5003.03 - Order data

11.2.3 Technical data

Product ID	5A5003.03
General information	
Certification	
CE	Yes
cULus	Yes
GOST-R	Yes
Mechanical characteristics	
Front	
Panel overlay	
Light background	Similar to Pantone 427CV
Dimensions	
Width	196 mm
Height	80 mm
Depth	8 mm

Table 212: 5A5003.03 - Technical data

11.2.4 Dimensions

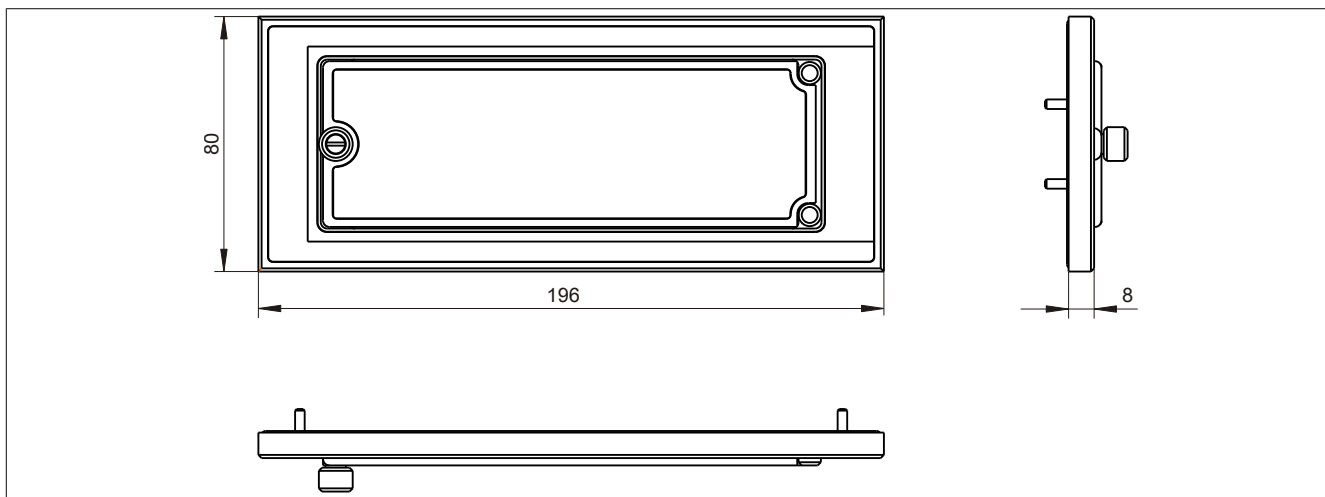

Figure 157: 5A5003.03 - Dimensions

11.2.5 Contents of delivery

Quantity	Component
1	Front cover 5A5003.03 for the USB media drive
4	M3 locknut
4	Cover retaining clip

Table 213: 5A5003.03 - Contents of delivery

11.2.6 Installation

The front cover is attached with 2 mounting rail brackets (included with the USB media drive) and 4 M3 locknuts. The 4 retaining clips provided can be used to mount the USB media drive and front cover as a whole, for example in a control cabinet door.

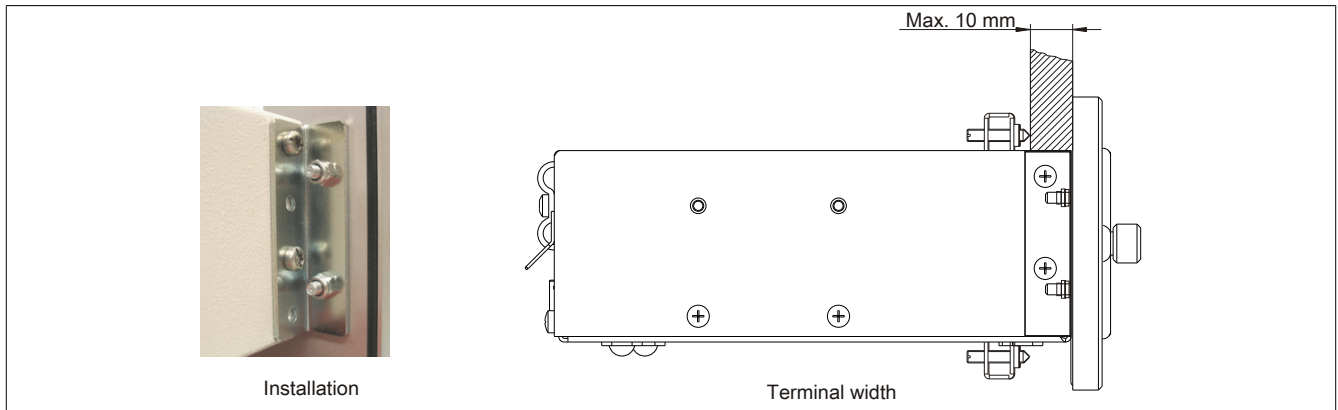

Figure 158: Front cover mounting and installation depth

11.2.6.1 Cutout installation

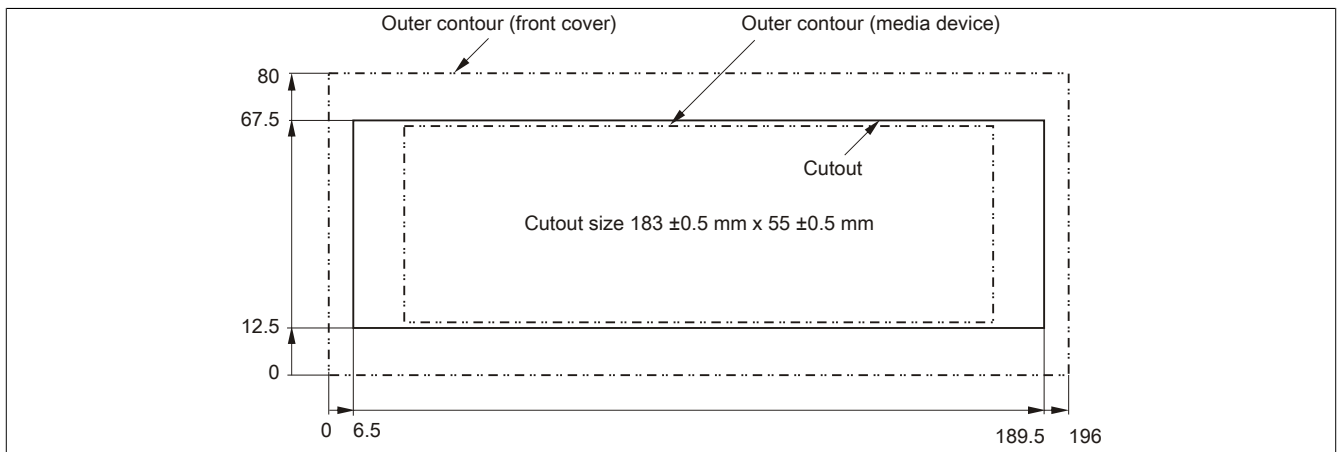

Figure 159: USB media drive with front cover - Installation cutout

12 HMI Drivers & Utilities DVD

12.1 5SWHMI.0000-00

12.1.1 General information

This DVD contains drivers, utilities, software upgrades and user's manuals for B&R panel system products (see the "Industrial PCs" or "Visualization and operation" section of the B&R website at www.br-automation.com).

When the DVD is created, its contents are identical to the files found in the Downloads section of the B&R website (Service / Material-related downloads).

12.1.2 Order data

Model number	Short description	Figure
5SWHMI.0000-00	<p>Other</p> <p>HMI Drivers & Utilities DVD</p>	

Table 214: 5SWHMI.0000-00 - Order data

12.1.3 Contents (V2.20)

BIOS product upgrades

- Automation PC 620 / Panel PC 700 CPU board 815E and 855GME BIOS
- Automation PC 620 / Panel PC 700 CPU board X855GME BIOS
- Automation PC 620 / Panel PC 700 CPU board 945GME BIOS
- Automation PC 620 / Panel PC 700 CPU board 945GME N270 BIOS
- Automation PC 680
- Automation PC 810 / Automation PC 820 / Panel PC 800 B945GME BIOS
- Automation PC 810 / Panel PC 800 945GME N270 CPU board BIOS
- Automation PC 810 / Panel PC 800 GM45 CPU board BIOS
- Provit 2000 product family - IPC2000/2001/2002
- Provit 5000 product family - IPC5000/5600/5000C/5600C
- Power Panel 100 BIOS devices
- Mobile Panel 100 BIOS devices
- Power Panel 100 / Mobile Panel 100 user boot logo
- Power Panel 100 / Mobile Panel 100 REMHOST utility
- Power Panel 300/400 BIOS devices
- Power Panel 300/400 BIOS user boot logo
- Power Panel 500 / Automation PC 510 / Automation PC 511 BIOS
- Panel PC 310

Device drivers

- Automation Device Interface (ADI)
- Audio
- Chipset
- CD-ROM
- LS120

- Graphics
- Network
- PCI / SATA RAID controller
- Touch screen
- Touchpad
- Interface board

Firmware upgrades

- Automation PC 620 / Panel PC 700 (MTCX, SDLR, SDLT)
- Automation PC 810 (MTCX, SDLR, SDLT)
- Automation PC 820 (MTCX, SDLR, SDLT)
- Mobile Panel 100 (SMCX)
- Panel PC 300 (MTCX)
- Power Panel 100 (aPCI)
- Power Panel 300/400 (aPCI)
- Power Panel 300/400 (MTCX)
- Power Panel 500 / Automation PC 510 / Automation PC 511 (MTCX, SDLR, I/O board)
- Panel PC 800 (MTCX, SDLR, SDLT)
- UPS firmware

Utilities/Tools

- B&R Embedded OS Installer
- Windows CE Tools
- User boot logo conversion program
- SATA RAID Installation Utility
- Automation Device Interface (ADI)
- CompactFlash service life calculator (Silicon Systems)
- Miscellaneous
- MTC utilities
- B&R Key Editor
- MTC & Mkey utilities
- Mkey utilities
- UPS configuration software
- ICU ISA configuration
- Intel PCI NIC boot ROM
- Diagnostic programs

Windows

- Windows CE 6.0
- Windows CE 5.0
- Windows CE 4.2
- Windows CE 4.1
- Windows CE Tools
- Windows Embedded Standard 2009
- Windows Embedded Standard 7
- Thin client
- Windows NT Embedded
- Windows XP Embedded
- VNC viewer

MCAD templates for

- Industrial PCs

- Visualization and operating devices
- Slide-in label templates
- Custom designs

ECAD templates for

- Industrial PCs
- Automation PCs
- Automation Panel 900
- Panels (Power Panel)

Documentation for

- Automation PC 511
- Automation PC 620
- Automation PC 680
- Automation PC 810
- Automation PC 820
- Automation Panel 800
- Automation Panel 900
- Panel PC 310
- Panel PC 700
- Panel PC 725
- Panel PC 800
- Power Panel 15/21/35/41
- Power Panel 100/200
- Power Panel 300/400
- Power Panel 500
- Mobile Panel 40/50
- Mobile Panel 100/200
- Mobile Panel connection box
- Provit 2000
- Provit 3030
- Provit 4000
- Provit 5000
- Provit Benchmark
- Provit Mkey
- Windows CE 5.0 help documentation
- Windows CE 6.0 help documentation
- Windows NT Embedded application guide
- Windows XP Embedded application guide
- Uninterruptible power supply
- Implementation guides
- B&R Hilscher fieldbus cards (CANopen, DeviceNet, PROFIBUS, PROFINET)

Service tools

- Acrobat Reader 5.0.5 (freeware in German, English and French)
- Power Archiver 6.0 (freeware in German, English and French)
- Internet Explorer 5.0 (German and English)
- Internet Explorer 6.0 (German and English)

13 Cables

13.1 USB cables

13.1.1 5CAUSB.00xx-00

13.1.1.1 General information

USB cables are designed to achieve USB 2.0 transfer speeds.

13.1.1.2 Order data

Model number	Short description	Figure
USB cables		
5CAUSB.0018-00	USB 2.0 connection cable type A - type B, 1.8 m	
5CAUSB.0050-00	USB 2.0 connection cable type A - type B, 5 m	

Table 215: 5CAUSB.0018-00, 5CAUSB.0050-00 - Order data

13.1.1.3 Technical data

Product ID	5CAUSB.0018-00	5CAUSB.0050-00
General information		
Certification		
CE		Yes
cULus		Yes
GOST-R		Yes
Cable construction		
Wire cross section		AWG 24, 28
Shield		Entire cable
Outer sheathing		
Color		Beige
Connector		
Type	USB type A male and USB type B male	
Mechanical characteristics		
Dimensions		
Length	1.8 m ±30 mm	5 m ±50 mm
Diameter		Max. 5 mm
Flex radius		Min. 100 mm

Table 216: 5CAUSB.0018-00, 5CAUSB.0050-00 - Technical data

13.1.1.4 Cable pinout

Warning!

Field-assembled cables must be wired according to these specifications.

If a field-assembled cable is used, B&R cannot guarantee that it will function properly. All cables provided by B&R are guaranteed to function properly, however.

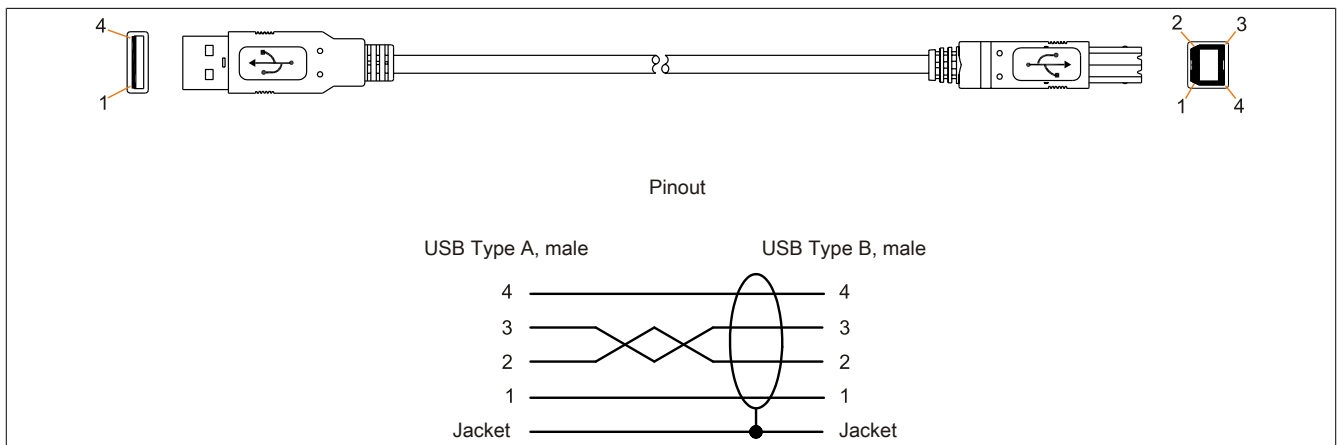

Figure 160: 5CAUSB.00xx-00 USB cables - Pinout

13.2 RS232 cables

13.2.1 9A0014.xx

13.2.1.1 General information

RS232 cables are used as extension cables between two RS232 interfaces.

13.2.1.2 Order data

Model number	Short description	Figure
	RS232 cables	
9A0014.02	RS232 extension cable for remote operation of a display unit with touch screen, 1.8 m	
9A0014.05	RS232 extension cable for remote operation of a display unit with touch screen, 5 m	
9A0014.10	RS232 extension cable for remote operation of a display unit with touch screen, 10 m	

Table 217: 9A0014.02, 9A0014.05, 9A0014.10 - Order data

13.2.1.3 Technical data

Product ID	9A0014.02	9A0014.05	9A0014.10
General information			
Certification		Yes	Yes
CE			
GOST-R	-		
Cable construction			
Wire cross section		AWG 26	
Shield		Entire cable	
Outer sheathing			
Color		Beige	
Connector			
Type		9-pin male/female DSUB connector	
Locating screw tightening torque		Max. 0.5 Nm	
Mechanical characteristics			
Dimensions			
Length	1.8 m ±50 mm	5 m ±80 mm	10 m ±100 mm
Diameter		Max. 5 mm	
Flex radius		Min. 70 mm	

Table 218: 9A0014.02, 9A0014.05, 9A0014.10 - Technical data

13.2.1.4 Cable pinout

Warning!

Field-assembled cables must be wired according to these specifications.

If a field-assembled cable is used, B&R cannot guarantee that it will function properly. All cables provided by B&R are guaranteed to function properly, however.

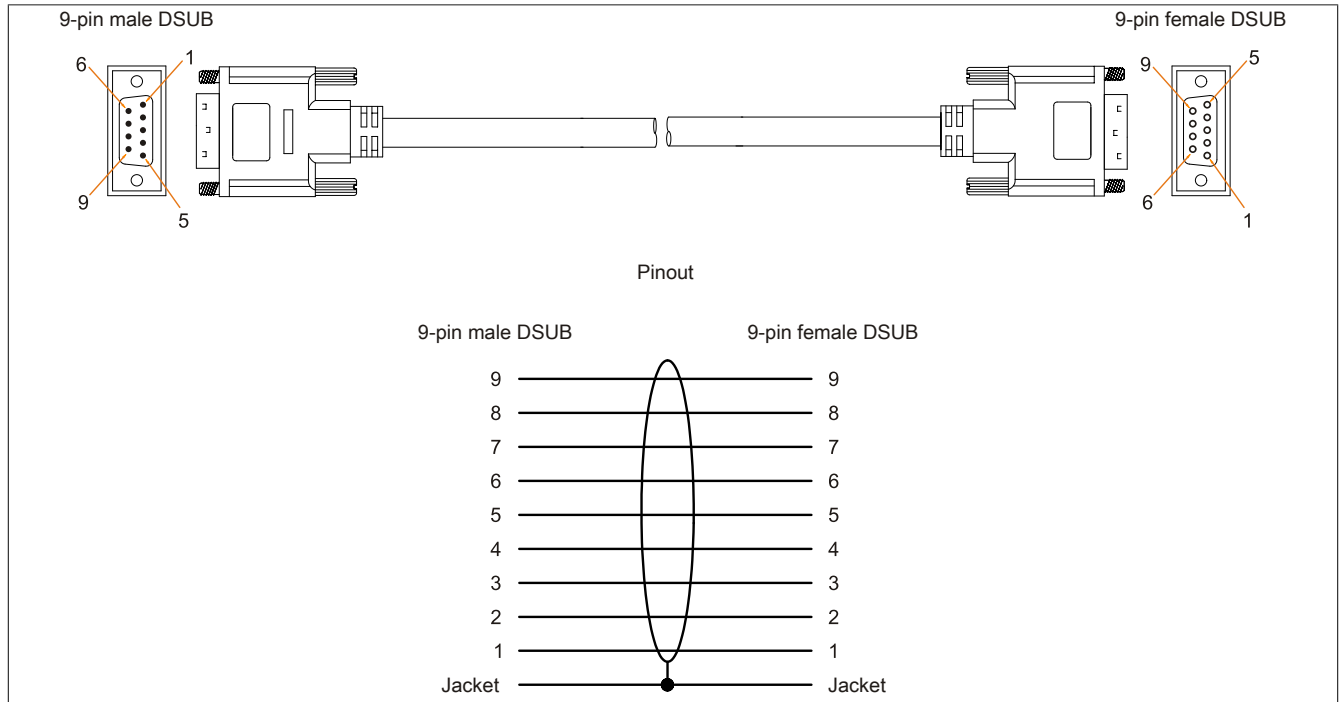

Figure 161: 9A0014.xx RS232 cables - Pinout

13.3 Internal supply cable

13.3.1 5CAMSC.0001-00

13.3.1.1 General information

This supply cable is used internally, for example to provide power to special PCI cards. It is connected to the mainboard.

For requirements and procedures, see "Connecting an external device to the mainboard" on page 308.

Caution!

Power must be turned off before plugging in and unplugging cables.

13.3.1.2 Order data

Model number	Short description	Figure
	Accessories	
5CAMSC.0001-00	Internal supply cable	

Table 219: 5CAMSC.0001-00 - Order data

13.3.1.3 Technical data

Product ID	5CAMSC.0001-00
General information	
Certification	
CE	Yes
GOST-R	Yes
Cable structure	
Wire cross section	AWG 22
Connector	
Type	1x 4-pin male disk drive power connector, 1x 4-pin female connector housing
Mechanical characteristics	
Dimensions	
Length	100 mm ±5 mm
Flexibility	Flexible

Table 220: 5CAMSC.0001-00 - Technical data

Chapter 7 • Maintenance and service

This chapter describes service/maintenance work that can be carried out by a qualified end user.

1 Replacing the battery

The lithium battery buffers the internal real-time clock (RTC) and CMOS data.

Information:

- The product design allows the battery to be changed with the B&R device switched either on or off. In some countries, safety regulations do not allow batteries to be changed while the module is switched on.
- Any BIOS settings that have been made will remain when the battery is changed with the power turned off (stored in nonvolatile EEPROM). The date and time must be reset later since this data is lost when the battery is changed.
- The battery should only be replaced by qualified personnel.

Warning!

The battery is only permitted to be replaced by a Renata CR2477N battery. The use of another battery may present a risk of fire or explosion.

The battery may explode if handled improperly. Do not recharge, disassemble or dispose of in fire.

The following replacement lithium batteries are available: 4A0006.00-000 (1 pc.) and 0AC201.91 (4 pcs.).

1.1 Evaluating the battery status

The status of the battery is determined immediately after the device is started and subsequently checked by the system every 24 hours. During this measurement, the battery is subjected to a brief load (approximately 1 second) and then evaluated. Once determined, the battery status is displayed in BIOS (Advanced - OEM features - System board features - Voltage values) and in the B&R Control Center (ADI driver); it can also be read in a customer application using the ADI library.

Battery status	Function
N/A	The hardware or firmware being used is too old and does not support reading the battery status.
GOOD	Data buffering is intact.
BAD	From the point when battery capacity is recognized as insufficient (BAD), data buffering is intact for approximately another 500 hours.

Table 221: Battery status

From the point when battery capacity is recognized as insufficient, data buffering is intact for approximately another 500 hours. When replacing the battery, data is buffered for approximately 10 minutes by a gold leaf capacitor.

1.2 Procedure

- Disconnect the power supply to the B&R Industrial PC.
- Touch the housing or ground connection in order to discharge any electrostatic charge from your body.
- Remove the cover from the battery compartment and carefully pull out the battery using the removal strip.



Figure 162: Removing the battery

- The battery should not be held by its edges. Insulated tweezers may also be used to insert the battery.

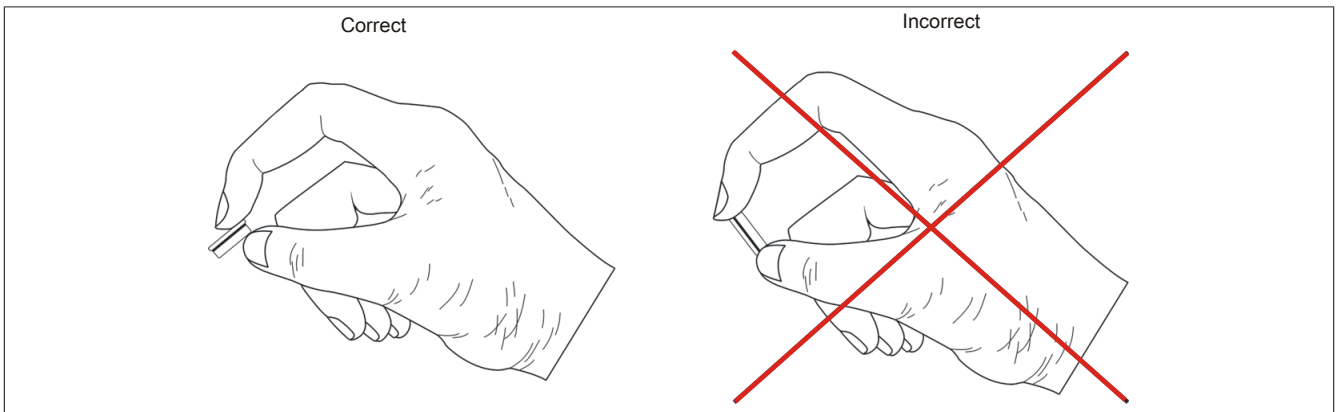

Figure 163: Battery handling

- Insert the new battery with the correct polarity.



Figure 164: Battery polarity

- To make the next battery replacement easier, be sure the removal strip is in place when inserting the battery.
- Reconnect the power supply to the B&R Industrial PC (plug in the power cable).
- Reset the date and time in BIOS.

Warning!

Lithium batteries are considered hazardous waste. Used batteries should be disposed of in accordance with applicable local regulations.

2 Cleaning

Danger!

This device can only be cleaned when switched off in order to prevent unintended functions from being triggered when handling the touch screen or pressing keys.

This device should be cleaned with a moist cloth. The cloth should be moistened with water and detergent, a screen cleaning agent or alcohol (ethanol). The cleaning agent should be applied to the cloth beforehand, not sprayed directly on the device! Aggressive solvents, chemicals, scouring agents, pressurized air or steam jets should never be used.

Information:

Displays with a touch screen should be cleaned regularly.

3 Replacing a CompactFlash card

Caution!

Power must be turned off before replacing CompactFlash cards.

The CompactFlash card can be replaced quickly and easily by pressing the ejector (see image) with a pointed object such as a pen.

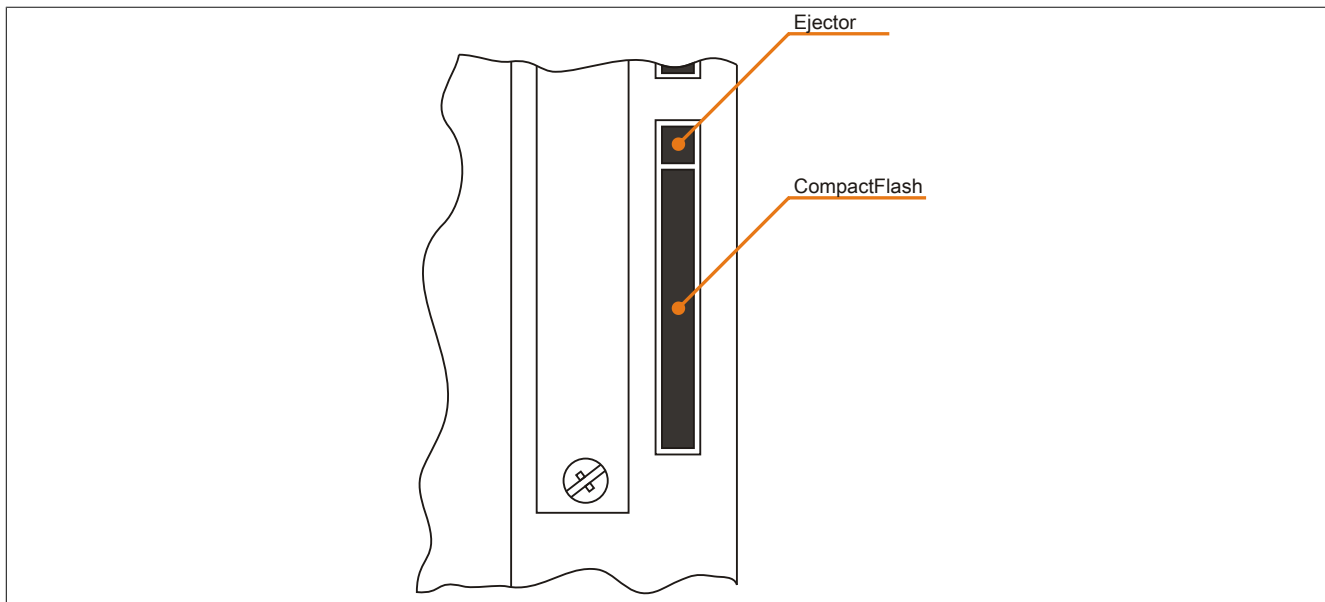

Figure 165: CompactFlash + ejector

4 Installing and replacing slide-in compact drives

Information:

The SATA I interface allows disks to be replaced during operation (hot plugging). In order to take advantage of this capability, this feature must be supported by the operating system.

4.1 Procedure

1. Loosen and remove the two quick release screws on the protective cover / slide-in compact drive.



Figure 166: Loosening the quick release screws

2. Insert the compact SATA drive and tighten the quick release screws.



Figure 167: Inserting the compact SATA drive

5 Installing and replacing slide-in drives

Slide-in drives can be installed and replaced in system units with 1 card slot or in expansions with 2 card slots.

5.1 Procedure

1. Disconnect the power supply to the B&R Industrial PC.
2. Touch the housing or ground connection in order to discharge any electrostatic charge from your body.
3. Remove the dummy slide-in module or slide-in drive by unscrewing the two quick release screws.



Figure 168: Loosening the quick release screws

4. Insert the slide-in drive and tighten with the two ¼ turn screws.

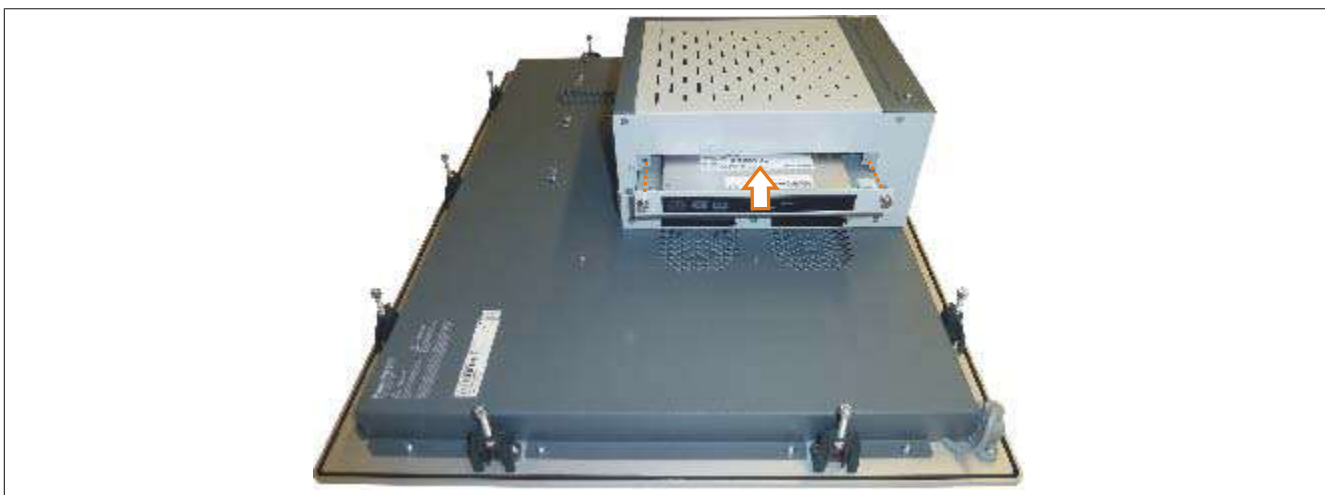

Figure 169: Installing the slide-in drive

6 Installing the slide-in compact adapter

Slide-in compact adapters can be installed and replaced in system units with 1 card slot or in expansions with 2 card slots. A slide-in compact drive (e.g. slide-in compact HDD) can be installed in a slide-in slot using the slide-in compact adapter.

6.1 Procedure

1. Disconnect the power supply to the B&R Industrial PC.
2. Touch the housing or ground connection in order to discharge any electrostatic charge from your body.
3. Remove the dummy slide-in module or slide-in drive by unscrewing the two quick release screws.



Figure 170: Loosening the quick release screws

4. Insert the slide-in compact adapter and tighten the two quick release screws.

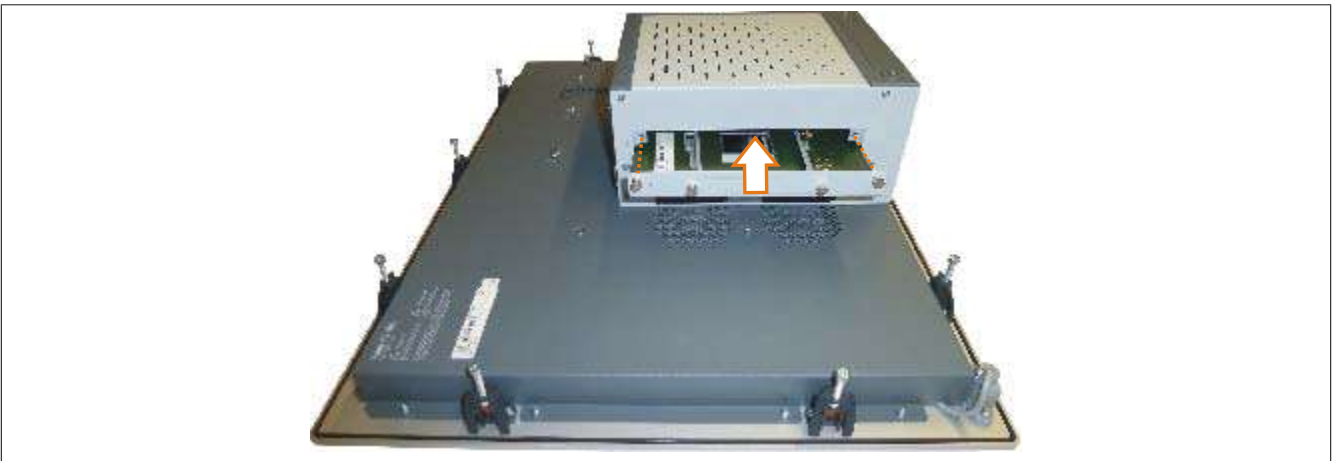

Figure 171: Installing the slide-in compact adapter

5. Once the adapter has been installed, the slide-in compact drive can be inserted.



Figure 172: Inserting the slide-in compact drive

7 Installing and replacing fan kits

Information:

The following section illustrates a characteristic example of a PPC800 model without expansion. The only difference in this procedure compared to models with an expansion is the number of combi-Torx screws to loosen.

7.1 Procedure

1. Loosen the indicated combi-Torx screws (T10) and remove the fan kit cover.

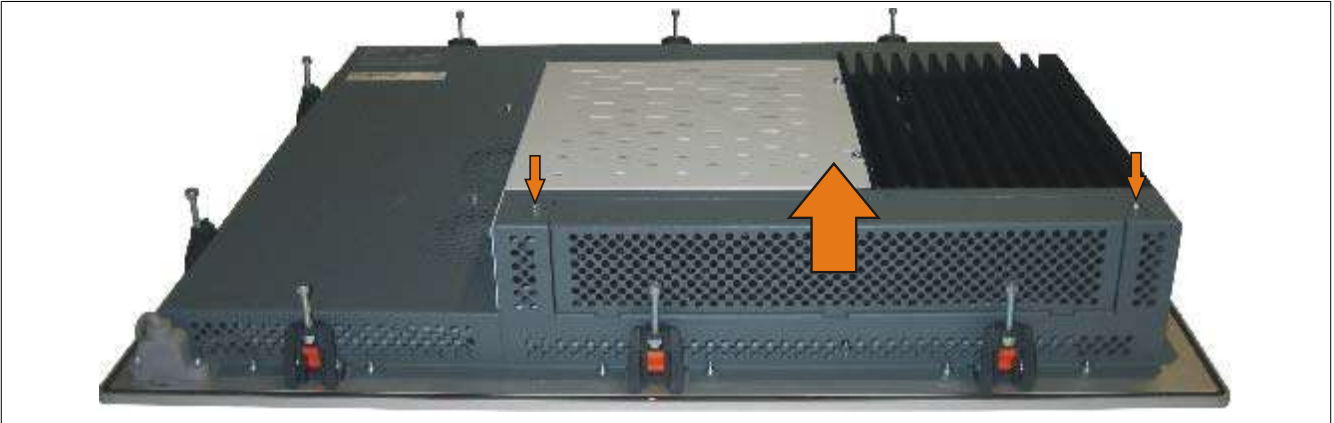

Figure 173: Removing the fan kit cover

2. Insert the fan kit frame and press down until it is fully fastened into the terminal.

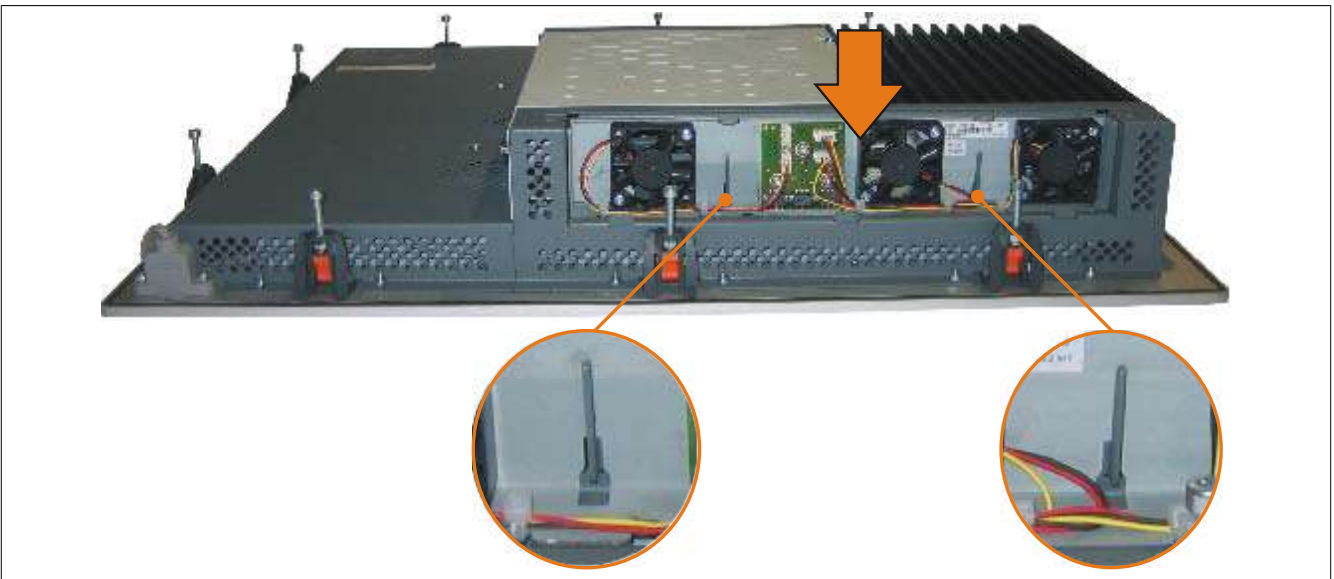

Figure 174: Inserting the fan kit

3. Place the dust filter in the fan kit cover and secure it with the filter clasp.

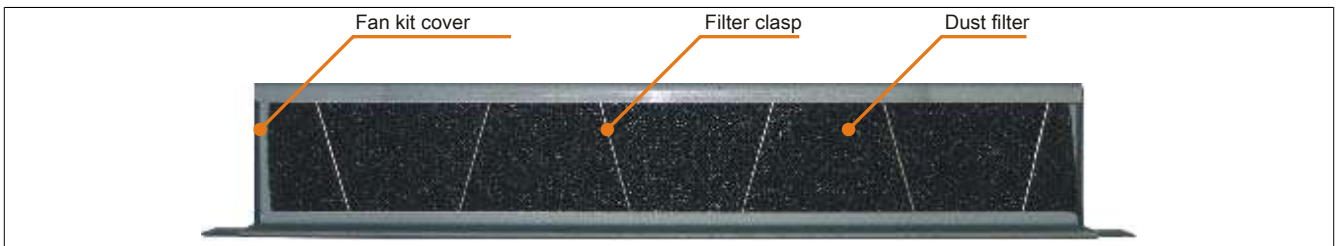

Figure 175: Securing the dust filter with the filter clasp

4. Place the fan kit cover in the housing and fasten using the Torx screws removed earlier.

Information:

The dust filter should be checked regularly depending on the area of use and degree of contamination.

8 Installing the UPS module

This module is installed using the materials included in delivery.

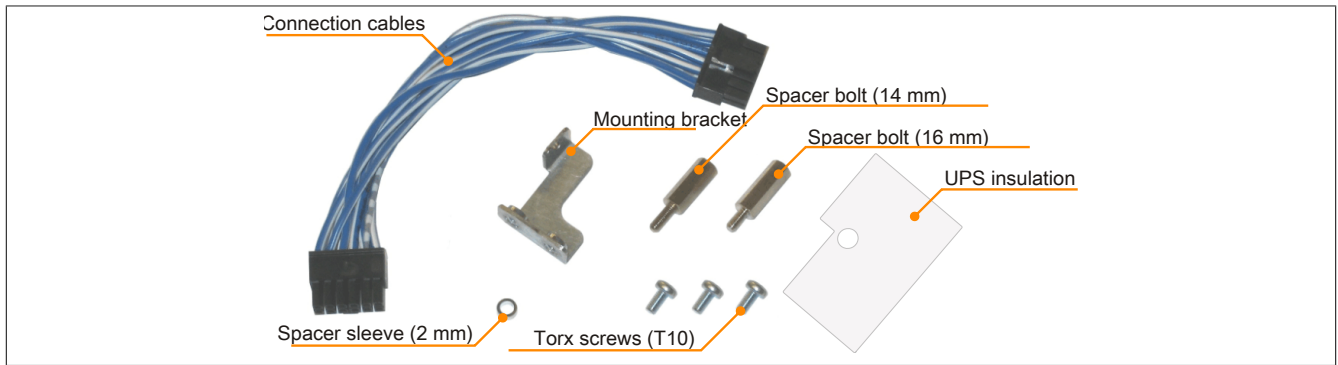

Figure 176: 5AC600.UPSI-00 Add-on UPS module - Installation materials

8.1 Installation guidelines

1. Remove the side cover (see "Installing the side cover" on page 303).
2. Remove the UPS module cover by removing the 2 marked Torx screws (T10).

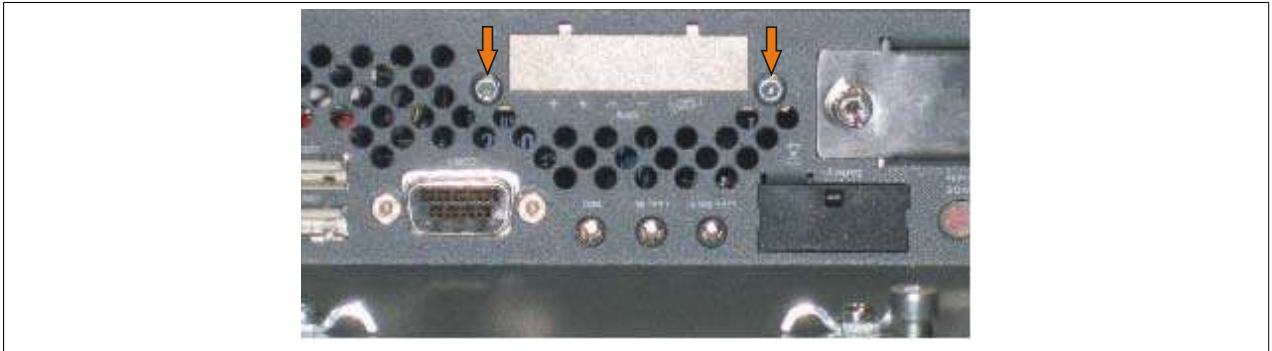

Figure 177: Removing the UPS module cover

3. Attach the UPS isolation to the bottom/rear of the UPS module and install both using 2 Torx screws (T10) on the housing and 1 Torx screw (T10) on the mainboard (spacer bolt). Use the previously removed Torx screws and the Torx screws from the installation material.

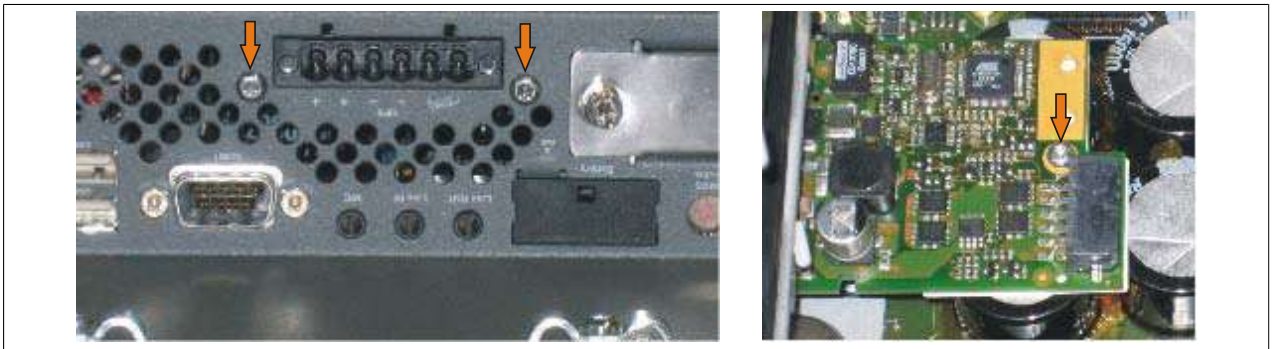

Figure 178: Installing the UPS module

4. Attach the connection cable (see marked female connector).

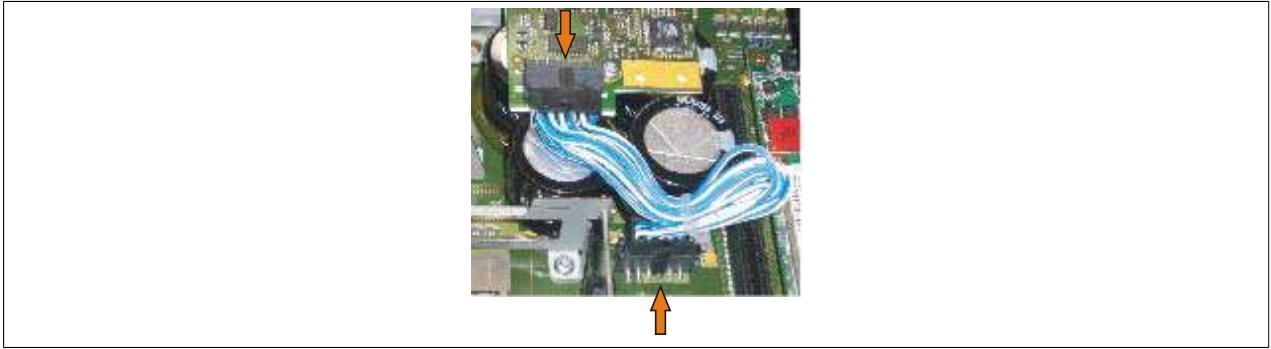

Figure 179: Attaching the connection cable

Information:

When connecting the cable, make sure that the connector locks into place.

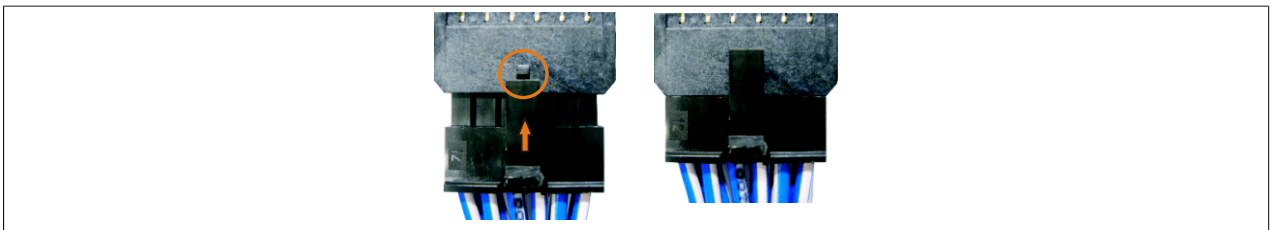

Figure 180: Connector locking mechanism

5. Attach the side cover.

9 Installing the UPS fuse kit on the battery unit

Information:

The 5AC600.UPSF-00 UPS fuse kit is only needed for battery units up to and including revision D0. A 25 A fuse is integrated on the connector circuit board beginning with revision E0.

9.1 Procedure

1. Power to the 5AC600.UPSB-00 battery unit must be disconnected by unplugging the UPS connection cable from the B&R Industrial PC.
2. Remove the cover on the battery unit. This is done by unscrewing the two Torx screws (T10) so that the cover can be removed by sliding it towards the orange connector.



Figure 181: Removing the cover for the battery unit

3. To install the fuse, the red cable must be disconnected from the battery circuit board.



Figure 182: Disconnecting the cable

4. The male fuse kit connector must be connected to the female connector on the red cable (1). The female fuse kit connector must be connected to the male connector on the battery circuit board (2).

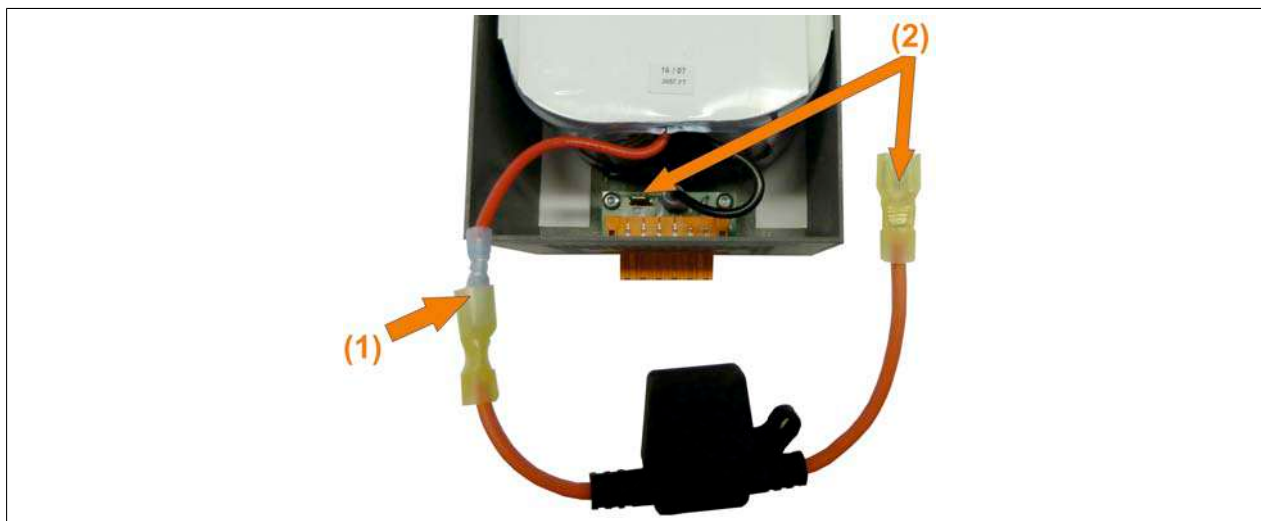

Figure 183: Connecting the fuse

5. The fuse can then be secured in the battery unit.



Figure 184: Securing the fuse

6. The cover for the battery unit can now be reattached. Insert the clips on the cover into the notch on the battery unit and tighten down the cover with the Torx screws removed previously.
7. Reconnect the 5AC600. UPSB-00 battery unit to the B&R Industrial PC.

10 Installing and replacing bus units

Bus units can be installed and replaced in system units with 1 card slot or in expansions with 2 card slots.

10.1 Procedure

1. Disconnect the power supply to the Panel PC 800.
2. Touch the housing or ground connection in order to discharge any electrostatic charge from your body.
3. Remove the side cover (see "Installing the side cover" on page 303).
4. Loosen the Torx screws (T10) mounted to the mainboard.



Figure 185: Removing the screws

5. Plug the bus unit into the bus unit slot and fasten it using three Torx screws (T10).

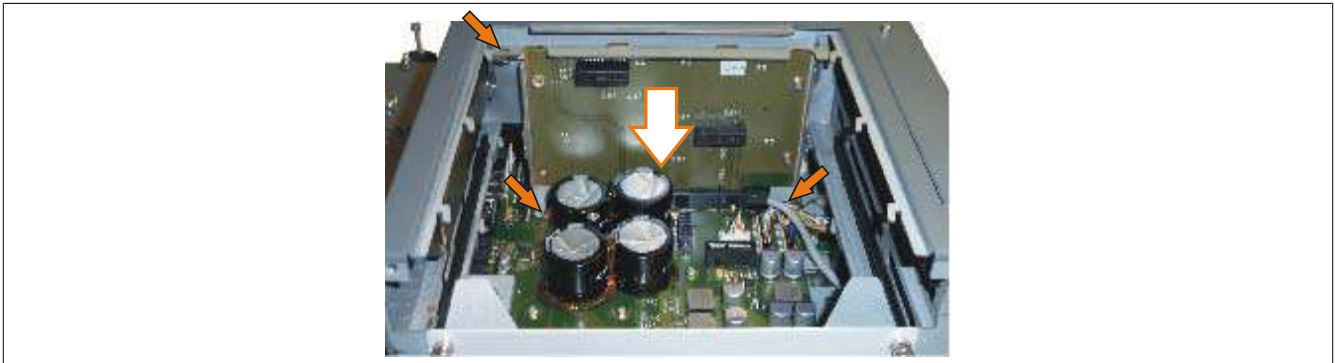

Figure 186: Installing the bus unit

6. Attach the side cover.

11 Installing and replacing adapters

1. Remove the side cover (see "Installing the side cover" on page 303).
2. Remove the 1 card slot or the 2 card slot expansion.

11.1 Procedure for the 5AC803.BC01-00 adapter

1. Loosen the Torx screws (T10) mounted to the mainboard.



Figure 187: Removing the screws

2. Place the adapter and guide rails in the intended positions and fasten them using the Torx screws (T10) removed earlier.

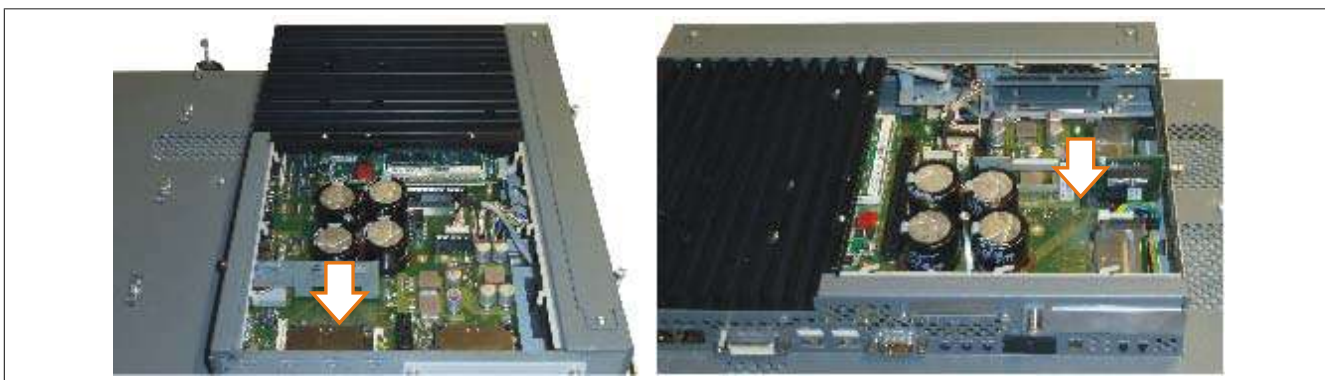

Figure 188: Installing the 5AC803.BC01-00 adapter

3. Attach the side cover.

11.2 Procedure for the 5AC803.BC02-00 adapter

1. Insert the adapter into the intended slot.



Figure 189: Installing the 5AC803.BC02-00 adapter

2. Attach the side cover.

12 Installing and replacing PCIe plug-in cards

12.1 Procedure

1. Loosen the quick release screws and remove the PCIe module cover.



Figure 190: Removing the PCIe module cover

2. Slide the PCIe plug-in card into place.

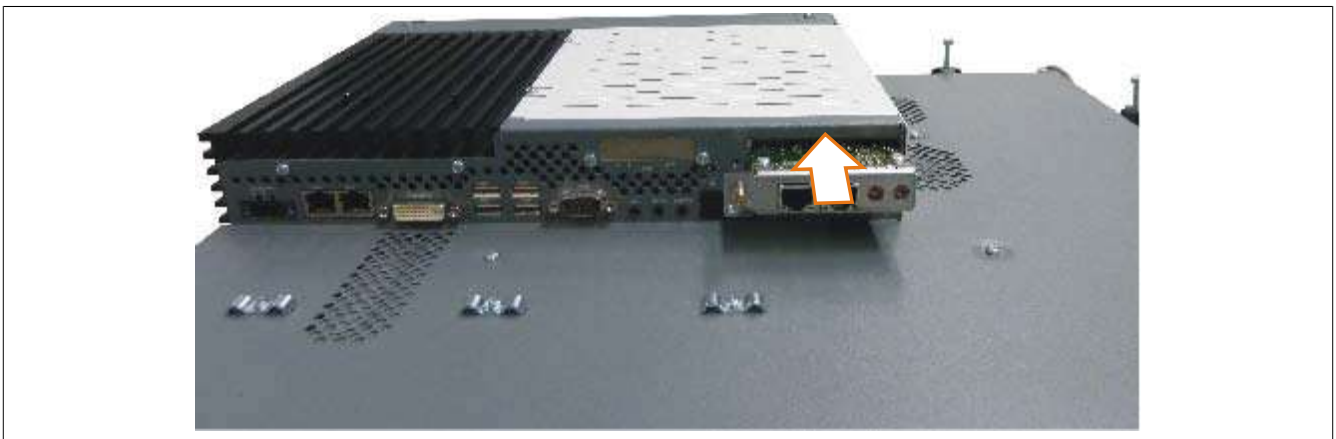

Figure 191: Inserting the PCIe plug-in card

3. Fasten the PCIe plug-in card using the quick release screws.

13 Installing the side cover

The side cover can be easily removed by loosening the Torx (T10) screws. The number of Torx screws can vary depending on the system.

13.1 PPC800 without expansion

1. Disconnect the power supply to the Panel PC 800.
2. Touch the housing or ground connection in order to discharge any electrostatic charge from your body.
3. Loosen the indicated combi-Torx screws (T10).
4. After the screws have been removed, the side cover can be removed by sliding it away from the heat sink.

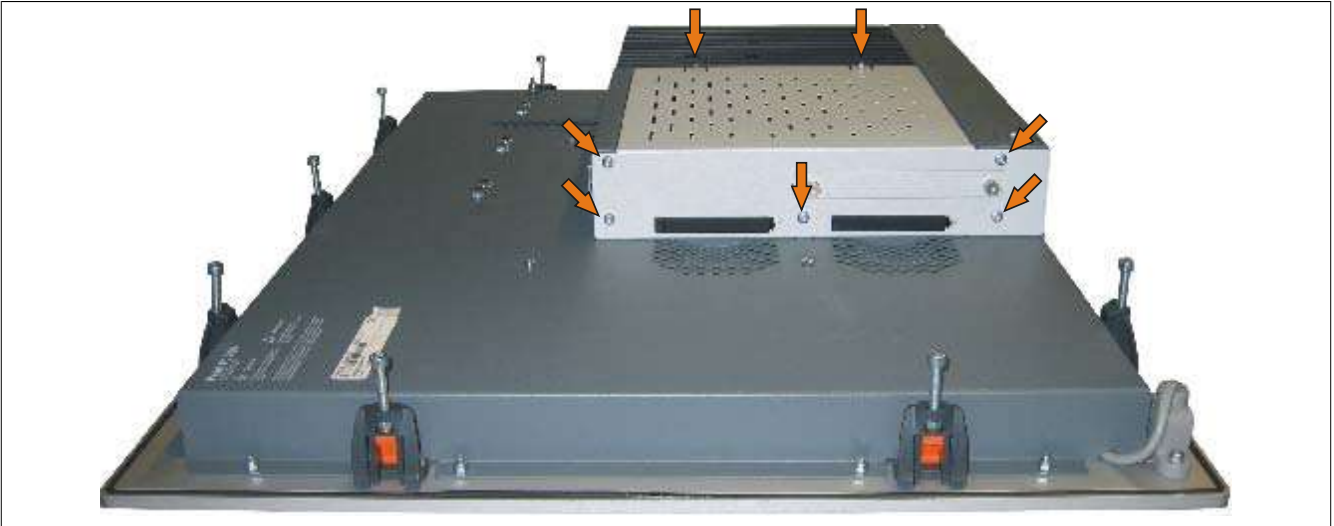

Figure 192: Installing the side cover on a PPC800 without an expansion

13.2 PPC800 with an expansion

1. Disconnect the power supply to the Panel PC 800.
2. Touch the housing or ground connection in order to discharge any electrostatic charge from your body.
3. Loosen the indicated combi-Torx screws (T10).
4. After the screws have been removed, the side cover can be removed by sliding it away from the heat sink.

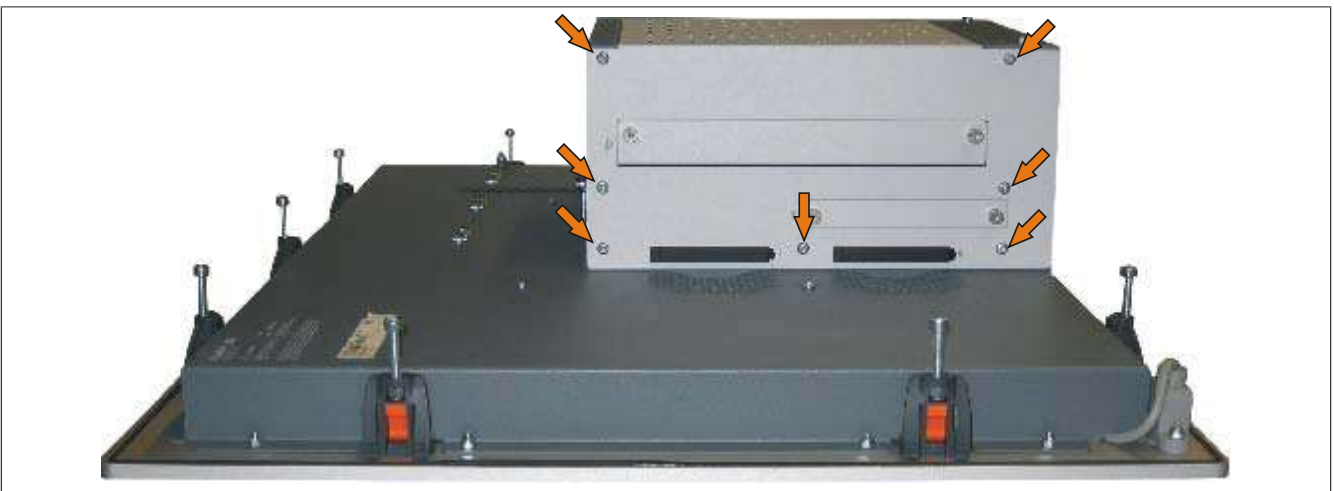

Figure 193: Installing the side cover on a PPC800 with an expansion (1-slot expansion shown in image)

14 Replacing a PCI SATA RAID hard disk in a RAID 1 set

This example assumes that the secondary hard disk (HDD1) is defective in a RAID 1 configuration. In such a case, the defective hard disk can be replaced by the replacement drive SATA hard disk.

Model number of PCI SATA RAID controller	Model number of required replacement SATA HDD	Note
5ACPCI.RAIC-01	5ACPCI.RAIC-02	60 GB hard disk
5ACPCI.RAIC-03	5ACPCI.RAIC-04	160 GB hard disk
5ACPCI.RAIC-05	5MMHDD.0250-00	250 GB hard disk
5ACPCI.RAIC-06	5MMHDD.0500-00	500 GB hard disk

Table 222: Overview of required replacement SATA HDD for PCI SATA HDD RAID controller

A size 10 Torx screwdriver is needed to replace the hard disk.

14.1 Procedure

1. Disconnect the power supply.
2. Touch the housing or ground connection in order to discharge any electrostatic charge from your body.
3. Remove the side cover.
4. Remove the SATA RAID insert.
5. Loosen the 4 appropriate fastening screws (M3x5).

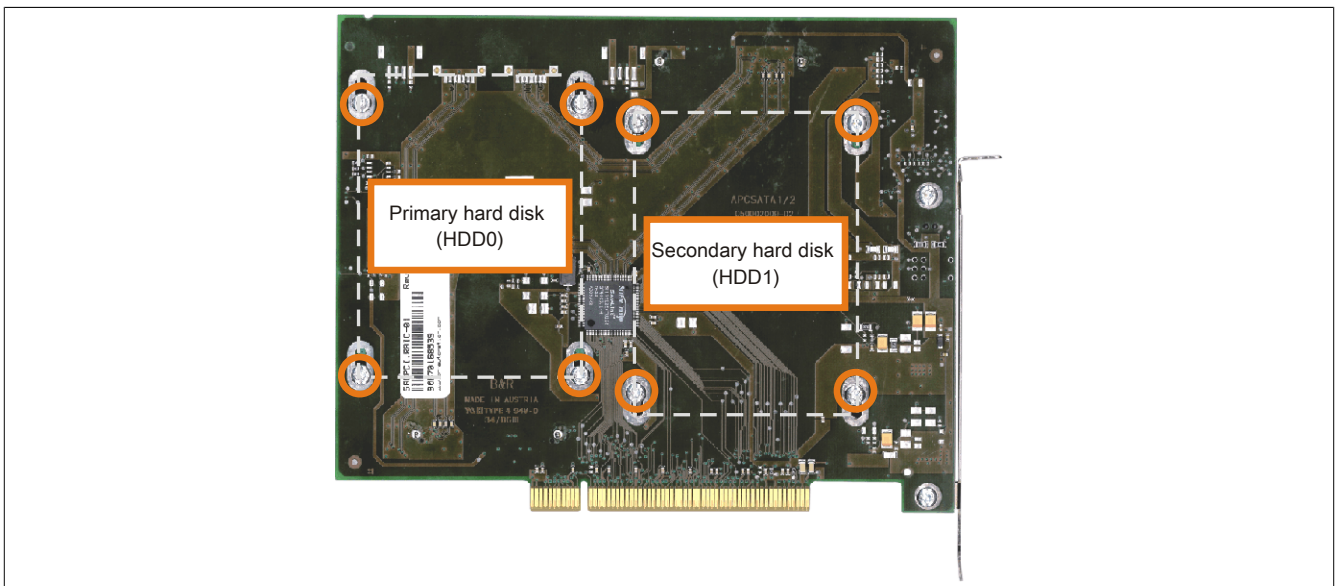

Figure 194: Screw layout on the back side of the 5ACPCI.RAIC-03 SATA RAID controller

6. On the front side, slide the hard disk down and away (Replacing the hard disk - left image).
7. Insert the new hard disk carefully into the connector (Replacing the hard disk - right image), being careful to only touch it on the front, not on the top.

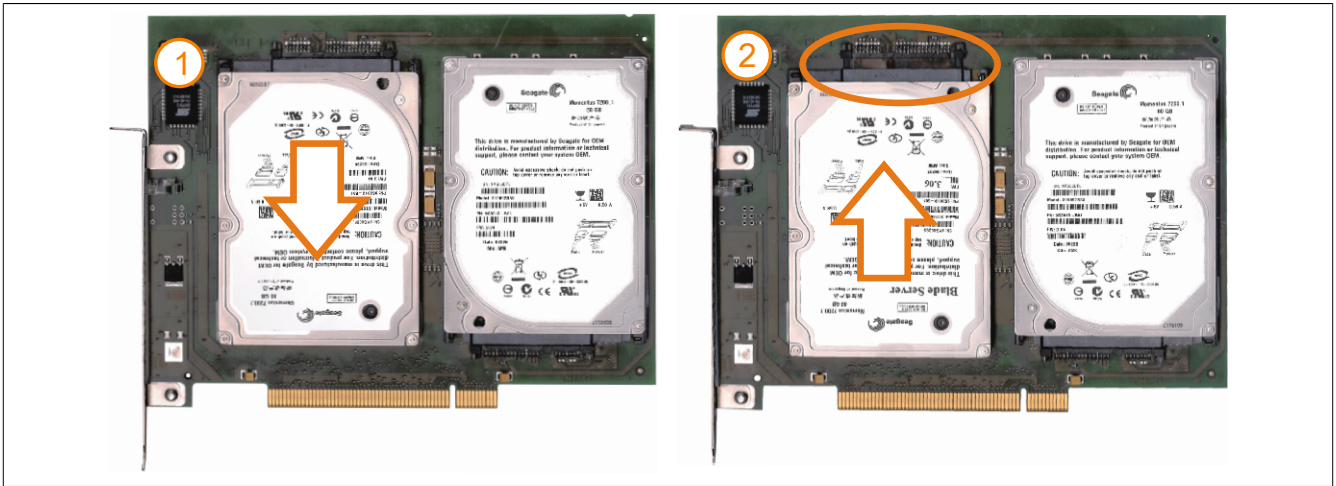

Figure 195: Replacing the hard disk

8. Re-secure the hard disk using the 4 fastening screws (M3x5) used earlier.
9. Reassemble the device in the reverse order.
10. An error message is output by the RAID BIOS after starting the system: "RAID1 set is in Rebuild status. The rebuild will continue after boot sequence is complete".
11. A rebuild can be performed immediately in SATA RAID BIOS or once the PC has booted - see "Rebuild mirrored set" on page 152.

Appendix A

1 Maintenance Controller Extended (MTCX)

The MTCX controller (FPGA processor) is located on the mainboard (part of every system unit).

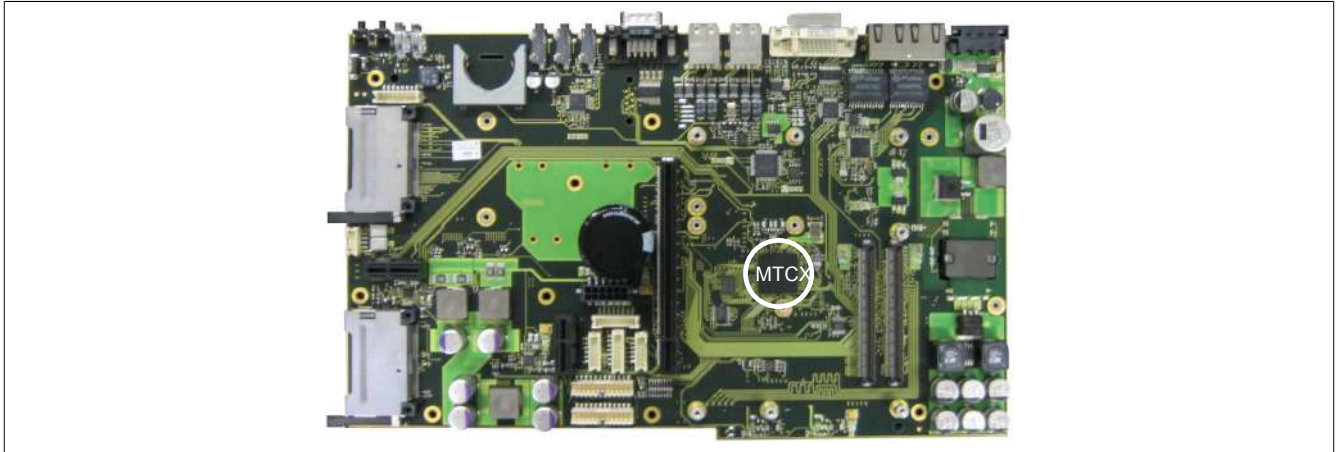

Figure 196: MTCX controller location

The MTCX is responsible for the following monitoring and control functions:

- Power on (power OK sequencing) and power failure logic
- Watchdog handling (NMI and reset handling)
- Temperature monitoring
- Fan control
- Key handling / coordination (matrix keyboard on Automation Panel 900 devices configurable using B&R Key Editor, PS/2 keyboard)
- LED handling (matrix keyboard with LEDs on Automation Panel 900 devices configurable using B&R Key Editor)
- Advanced desktop operation (USB forwarding)
- Daisy chain display operation (touch screen, USB forwarding)
- Panel locking mechanism (can be configured using B&R Control Center - ADI driver)
- Backlight control for connected B&R displays
- Statistical data recording (power cycles - records every switch-on, power on and fan hour; each full hour is counted, i.e. not increased at 50 minutes)
- SDL data transfer (display, matrix keyboard, touch screen, service data, USB)
- LED status indicators (HDD, Link, Run)

Extended MTCX functions are available by upgrading firmware ¹⁾. The version can be read in BIOS ("Advanced" - Baseboard/Panel Features) or in approved Microsoft Windows operating systems with the B&R Control Center.

1.1 Temperature monitoring - Fan control

The MTCX constantly monitors the temperature using temperature sensors, which directly determines how the fans are controlled. The speed depends on the measured temperature. The limit values depend on the MTCX firmware version being used.

¹⁾ Available in the Downloads section of the B&R website (www.br-automation.com).

Sensor range	Startup temperature	Max fan speed at:
Board I/O	60°C	76°C
Board ETH2	60°C	76°C
Board power	60°C	76°C
Power supply	60°C	76°C
Slide-in drive 1	44°C	60°C
IF slot	65°C	81°C

Table 223: Temperature limits of the fan (MTCX PX32 V1.01)

Once the startup temperature is reached, the device is started at the minimum fan speed. The maximum fan speed is reached at a startup temperature of 16°C. The fan speed in this area is controlled depending on the temperature.

For example, slide-in 1: $44^{\circ}\text{C} + 16^{\circ}\text{C} = 60^{\circ}\text{C}$ --> Maximum fan speed

The fans will only be shut off again if the evaluation temperature is more than 6°C below the switch-on temperature for a period of 30 minutes (=overshoot time).

2 Connecting an external device to the mainboard

A male connector on the mainboard allows +5 VDC and +12 VDC to be rerouted in order to provide power to special PCI cards, for example.

This voltage can be accessed using the "5CAMSC.0001-00" on page 284. The connector is located near the reset or power button (see image). In order to reach the connector, the side cover (see "Installing the side cover" on page 303) of the PPC800 as well as any slide-in drives and PCIe and PCI plug-in cards must be removed.



Figure 197: Connector location for external devices

Connector for external devices			
Pin	Assignment	Power	4-pin connector, male 
1	+12 VDC	Max. 10 watts	
2	GND		
3	GND	Max. 5 watts	
4	+5 VDC		

Table 224: Connector on the mainboard - Pinout

Connections are protected with a 1 A multi-fuse.

3 5-wire AMT touch screen

3.1 Technical data

Information:

The following characteristics, features and limit values only apply to this individual component and can deviate from those specified for the complete system. For the complete system in which this individual component is used, refer to the data given specifically for that device.

Product ID	5-wire AMT touch screen
General information	
Certification	
CE	Yes
c-UL-us	Yes
Manufacturer	AMT
Release pressure	< 1 N
Light permeability	81 ±3%
Environmental conditions	
Temperature	
Operation	- 20 to 70°C
Storage	- 40 to 80°C
Transport	- 40 to 80°C
Relative humidity	
Operation	90% at max. 50°C
Storage	90% RH at max. 60°C for 504 hours
Transport	90% RH at max. 60°C for 504 hours
Operating conditions	
Service life	36 million touch operations at the same position (release pressure: 250 g, interval: 2x per second)
Chemical resistance ¹⁾	Acetone, methylene chloride, methyl ethyl ketone, isopropyl alcohol, hexane, turpentine, mineral spirits, unleaded gasoline, diesel, motor oil, gear lubricating oil, antifreeze, ammonia-based glass cleaner, chemical cleaning agents, household cleaning agents, vinegar, coffee, tea, lubricant, cooking oil, salt
Enabling driver	Finger, pointer, credit card, glove Touch screen drivers for approved operating systems are available in the Downloads section of the B&R website (www.br-automation.com).

Table 225: 5-wire AMT touch screen - Technical data

- 1) The active area of the touch screen is resistant to these chemicals for a period of one hour at 25°C.

3.2 Temperature/Humidity diagram

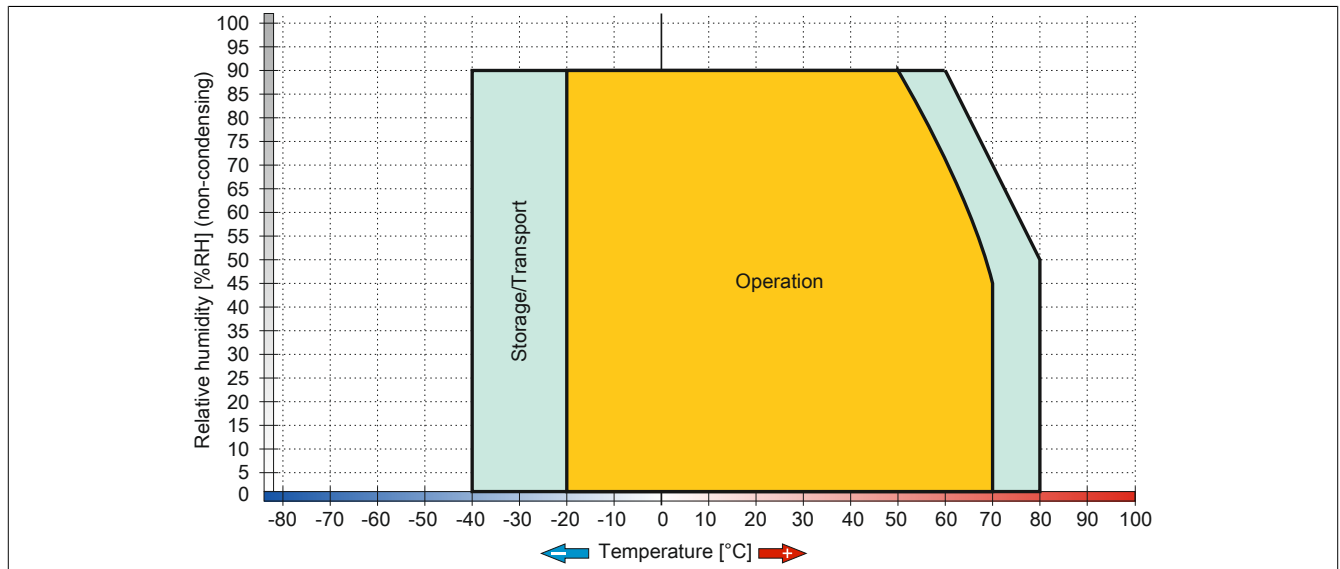

Figure 198: 5-wire AMT touch screen - Temperature/Humidity diagram

3.3 Cleaning

Danger!

This device can only be cleaned when switched off in order to prevent unintended functions from being triggered when handling the touch screen or pressing keys.

This device should be cleaned with a moist cloth. The cloth should be moistened with water and detergent, a screen cleaning agent or alcohol (ethanol). The cleaning agent should be applied to the cloth beforehand, not sprayed directly on the device! Aggressive solvents, chemicals, scouring agents, pressurized air or steam jets should never be used.

Information:

Displays with a touch screen should be cleaned regularly.

4 Panel overlay

The panel overlay conforms to DIN 42115 (Part 2). This means it is resistant to exposure to the following chemicals for a 24-hour period with no visible signs of damage:

Information:

The following characteristics, features and limit values only apply to this individual component and can deviate from those specified for the complete system.

Ethanol Cyclohexanol Diacetone alcohol Glycol Isopropanol Glycerine Methanol Triacetin Dowandol DRM/PM	Formaldehyde 37 to 42% Acetaldehyde Aliphatic hydrocarbons Toluene Xylene White spirits	Trichloroethane Ethyl acetate Diethyl ether N-Butyl acetate Amyl acetate Butylcellosolve Ether
Acetone Methyl ethyl ketone Dioxan Cyclohexanone MIBK Isophorone	Formic acid < 50% Acetic acid < 50% Phosphoric acid < 30% Hydrochloric acid < 36% Nitric acid < 10% Trichloroacetic acid < 50% Sulphuric acid < 10%	Sodium hypochlorite < 20% Hydrogen peroxide < 25% Potassium carbonate Washing agents Tenside Fabric conditioner Ferrous chloride (FeCl ₂) Ferrous chloride (FeCl ₃) Dibutyl phthalate Dioctyl phthalate Sodium carbonate
Ammonia < 40% Caustic soda < 40% Potassium hydroxide Alkali carbonate Bichromate Potassium Acetonitrile Sodium bisulphate	Cutting oil Diesel oil Linseed oil Paraffin oil Blown castor oil Silicon oil Turpentine oil substitute Brake fluid Aviation fuel Gasoline Water Sea water Decon	

Table 226: Chemical resistance of the panel overlay

The panel overlay conforms to DIN 42115 section 2 for exposure to glacial acetic acid for less than one hour without visible damage.

5 Viewing angles

Viewing angle specifications (R, L, U, D) for the display types are listed in the technical data for each device.

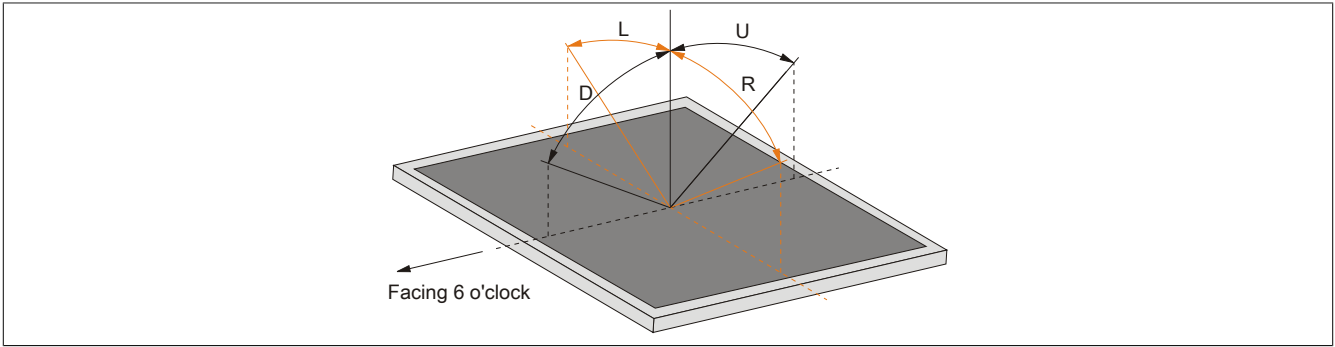

6 Mounting compatibility

This section describes the compatibility of the installation dimensions for Power Panel 100/200, Power Panel 300/400, Power Panel 500, Automation Panel 900, Automation Panel 700 and Panel PC 800 devices according to device display size.

The outer dimensions of the device types are identical for the respective display sizes.

The different device types are abbreviated as follows:

Device type	Abbreviation
Power Panel 100/200	PP100/200
Power Panel 300/400	PP300/400
Power Panel 500	PP500
Automation Panel 900	AP900
Panel PC 700	PPC700
Panel PC 800	PPC800

Table 227: Product abbreviations

6.1 Compatibility overview

The following table provides an overview of PP100/200, PP300/400, PP500, AP900, PPC700 and PPC800 devices. Detailed information can be found in the section 6.2 "Compatibility details" on page 314.

Compatibility between device types is represented on each line by matching symbols.

Size	Format	Compatible	PP100/200	PP300/400	PP500	AP900	PPC700	PPC800
5.7"	Horizontal1	Outer dimensions	■	■	■	-	-	-
		Installation dimensions	●	●	●	-	-	-
	Horizontal2	Outer dimensions	■	■	■	-	-	-
		Installation dimensions	●	●	●	-	-	-
	Vertical1	Outer dimensions	■	■	■	-	-	-
		Installation dimensions	●	●	▲	-	-	-
10.4"	Horizontal 1	Outer dimensions	■	■	■	■	■	-
		Installation dimensions	●	●	●	●	●	-
	Horizontal2	Outer dimensions	■	■	■	■	■	-
		Installation dimensions	●	●	▲	▲	▲	-
	Vertical1	Outer dimensions	■	■	■	■	■	-
		Installation dimensions	●	●	▲	▲	▲	-
12.1"	Horizontal1	Outer dimensions	■	■	■	■	■	-
		Installation dimensions	●	●	▲	▲	▲	-
15"	Horizontal1	Outer dimensions	■	■	■	■	■	■
		Installation dimensions	●	●	▲	●	●	●
	Vertical1	Outer dimensions	■	■	■	■	■	-
		Installation dimensions	●	●	▲	●	●	-
17"	Horizontal 1	Outer dimensions	-	-	-	■	■	-
		Installation dimensions	-	-	-	▲	▲	-
19"	Horizontal 1	Outer dimensions	-	-	-	■	■	-
		Installation dimensions	-	-	-	▲	-	-
21.3"	Horizontal 1	Outer dimensions	-	-	-	■	-	-
		Installation dimensions	-	-	-	▲	-	-

Table 228: Overview of device compatibility

6.2 Compatibility details

6.2.1 Example

The dimensions (all in mm) shown in this image apply to the other figures below.

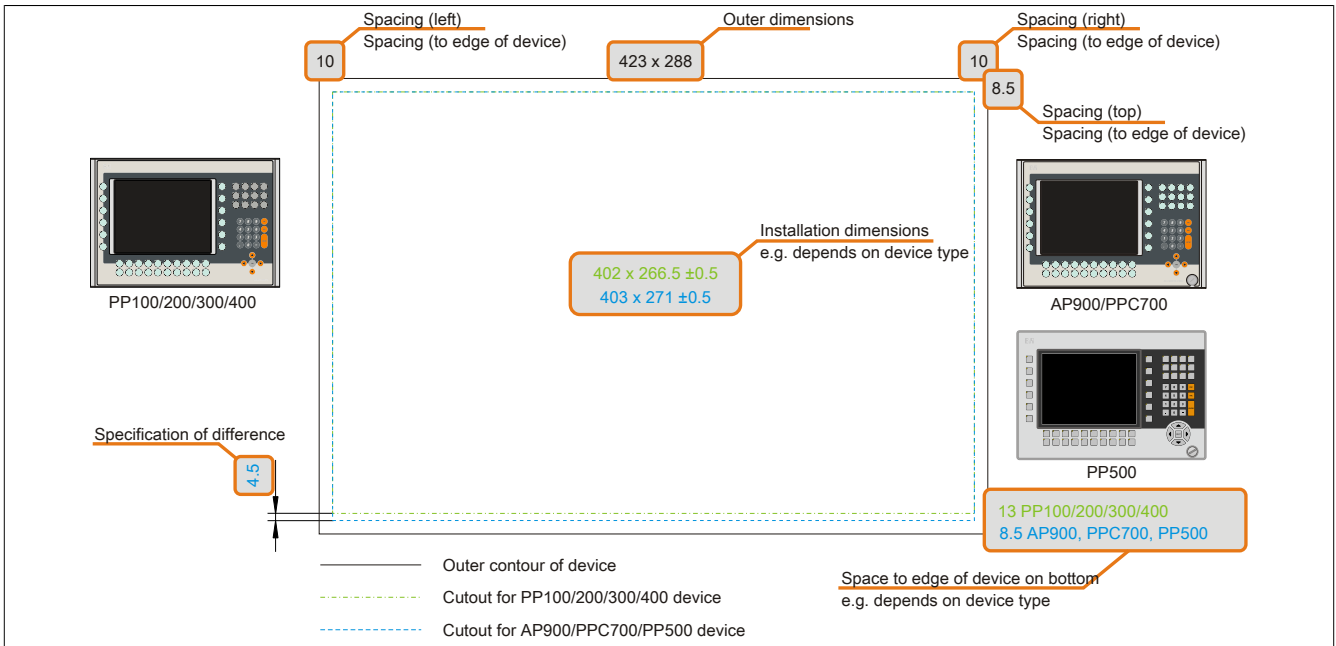

Figure 199: Overview of compatibility figures

6.2.2 5.7" devices

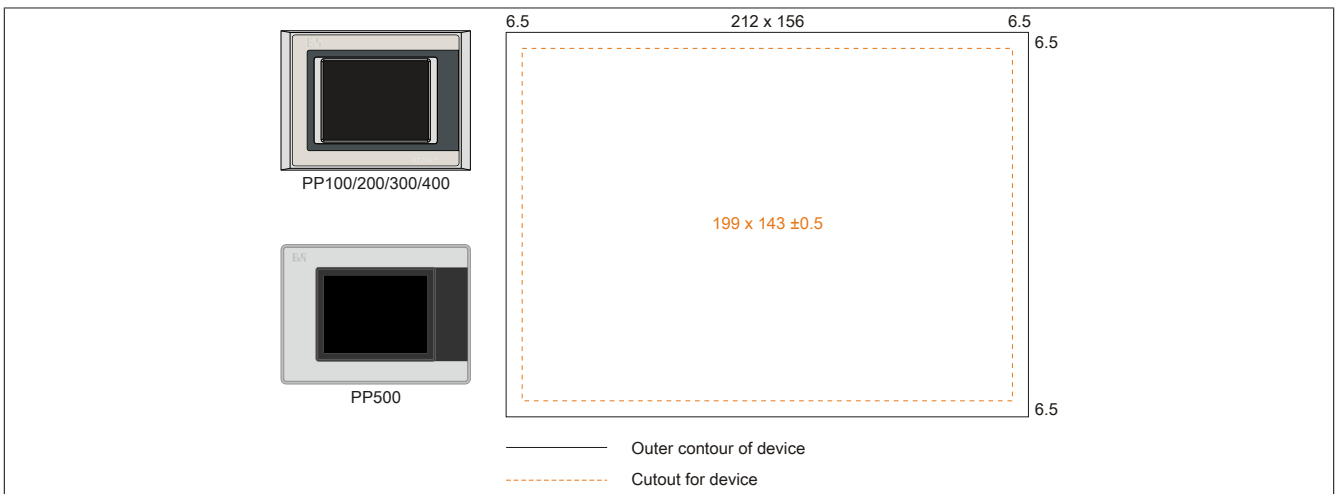

Figure 200: Mounting compatibility - 5.7" device - Horizontal1

5.7" Power Panel 500 devices and Power Panel 100/200/300/400 devices are 100% mounting compatible in the Horizontal1 format.

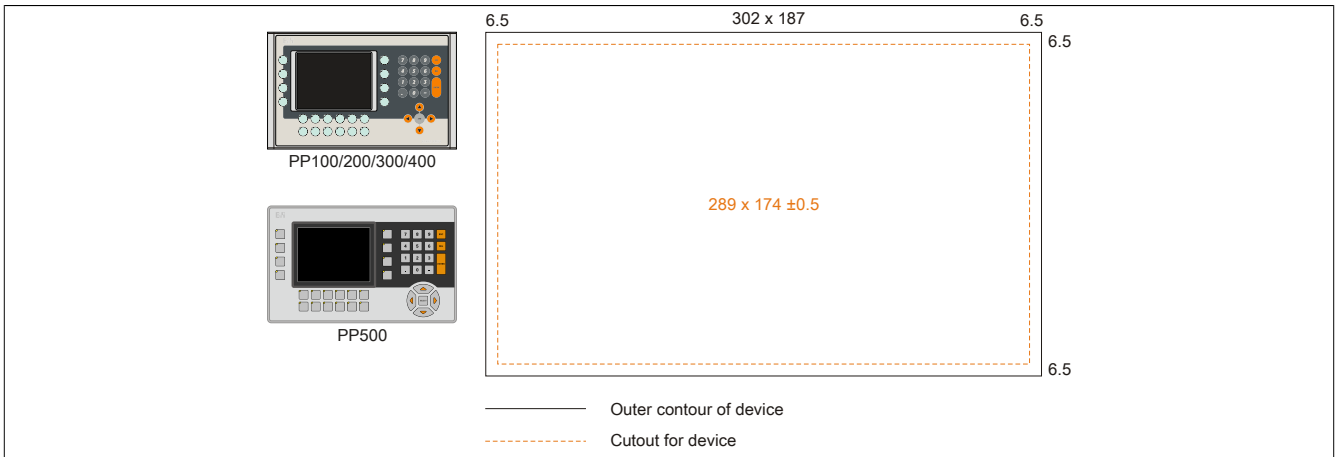

Figure 201: Mounting compatibility - 5.7" device - Horizontal2

5.7" Power Panel 500 devices and Power Panel 100/200/300/400 devices are 100% mounting compatible in the Horizontal2 format.

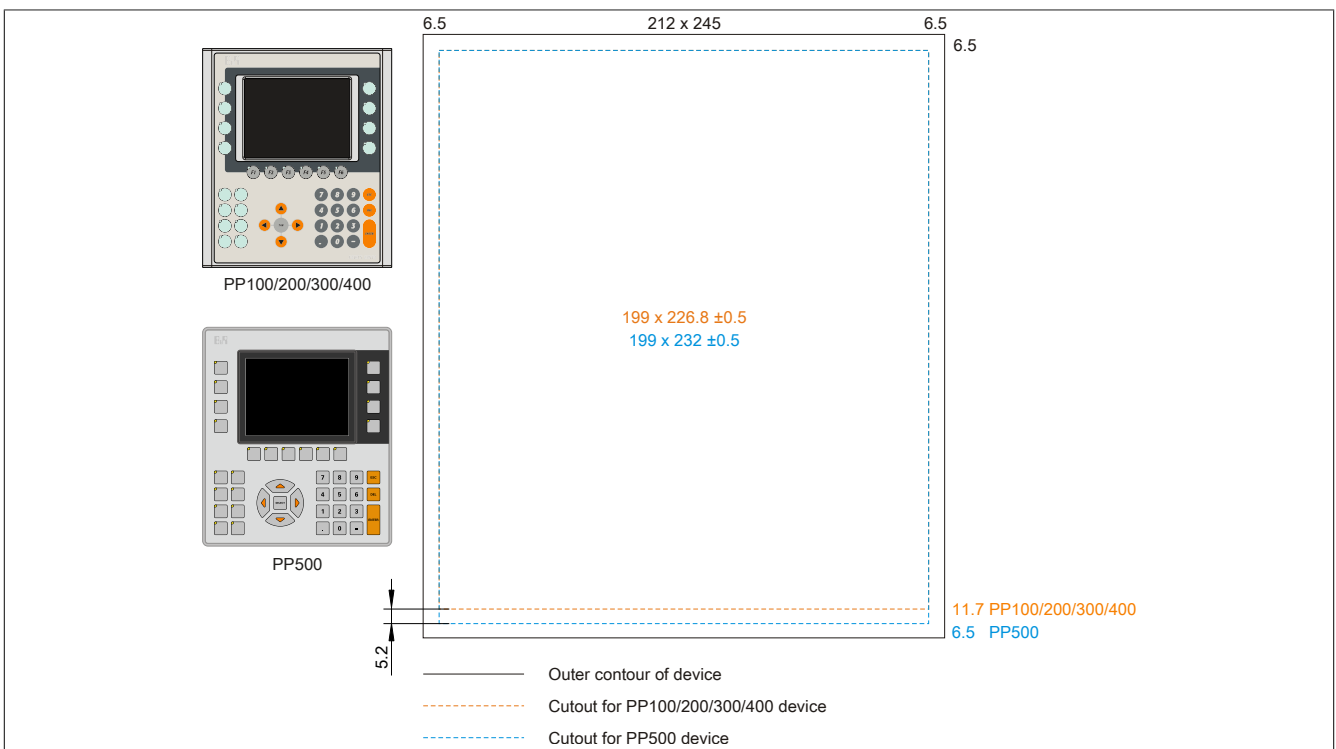

Figure 202: Mounting compatibility - 5.7" device - Vertical1

5.7" Power Panel 500 devices are not 100% mounting compatible with Power Panel 100/200/300/400 devices in the Vertical1 format. Power Panel 500 devices require a cutout that is 5.2 mm higher (bottom edge).

The larger cutout can be used for all devices under certain conditions:

- When mounting, make sure that the PP100/200/300/400 devices are placed and mounted as close to the center of the cutout as possible. Failure to do so can prevent the retaining clips from holding firmly, which means that a firm seal is no longer guaranteed with the gasket (IP65).

6.2.3 10.4" devices

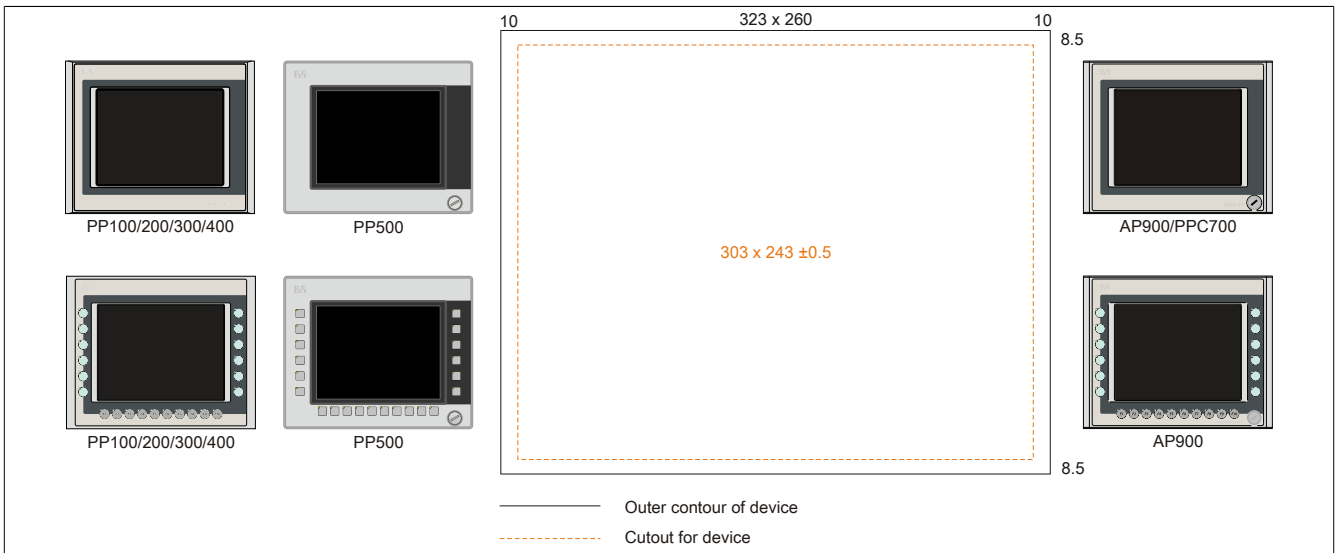

Figure 203: Mounting compatibility - 10.4" device - Horizontal1

10.4" Power Panel 500 devices and Power Panel 100/200/300/400 devices are 100% mounting compatible in the Horizontal1 format.

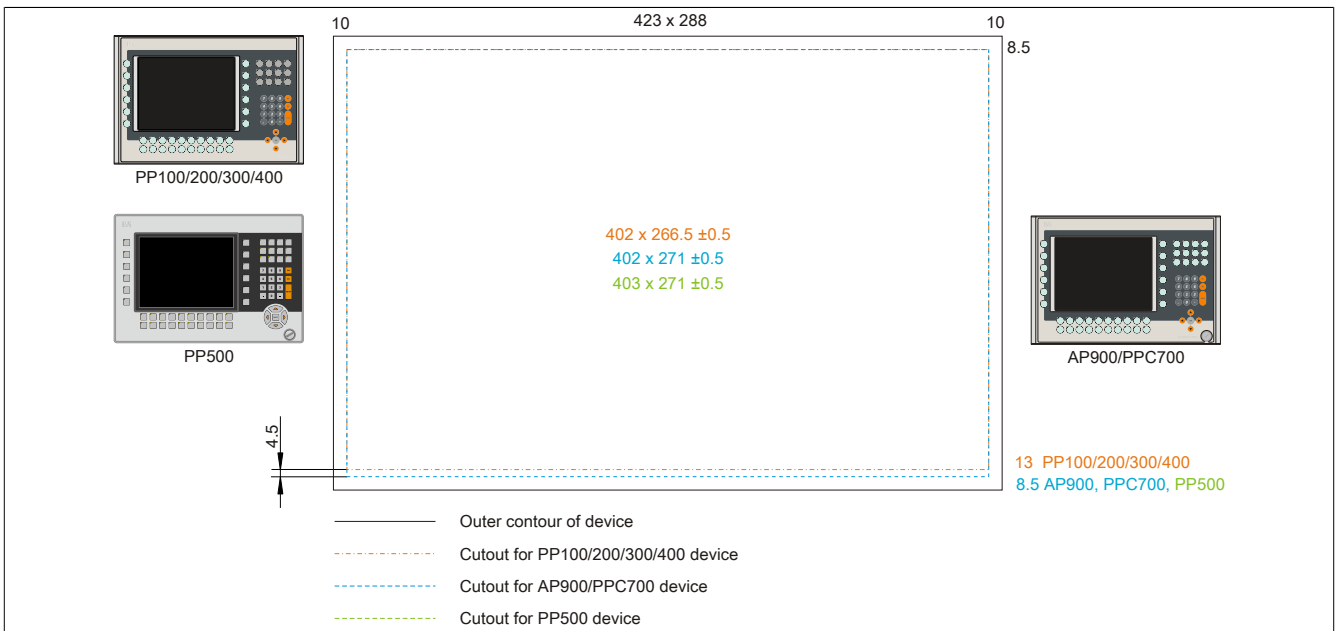

Figure 204: Mounting compatibility - 10.4" device - Horizontal2

10.4" Power Panel 500, Automation Panel 900 and Panel PC 700 devices are not 100% mounting compatible with Power Panel 100/200/300/400 devices in the Horizontal2 format. The Power Panel 500, Automation Panel 900 and Panel PC 700 devices require a cutout that is 4.5 mm higher (bottom edge).

The larger cutout can be used for all devices under certain conditions:

- When mounting, make sure that the PP100/200/300/400 devices are placed and mounted as close to the center of the cutout as possible. Failure to do so can prevent the retaining clips from holding firmly, which means that a firm seal is no longer guaranteed with the gasket (IP65).

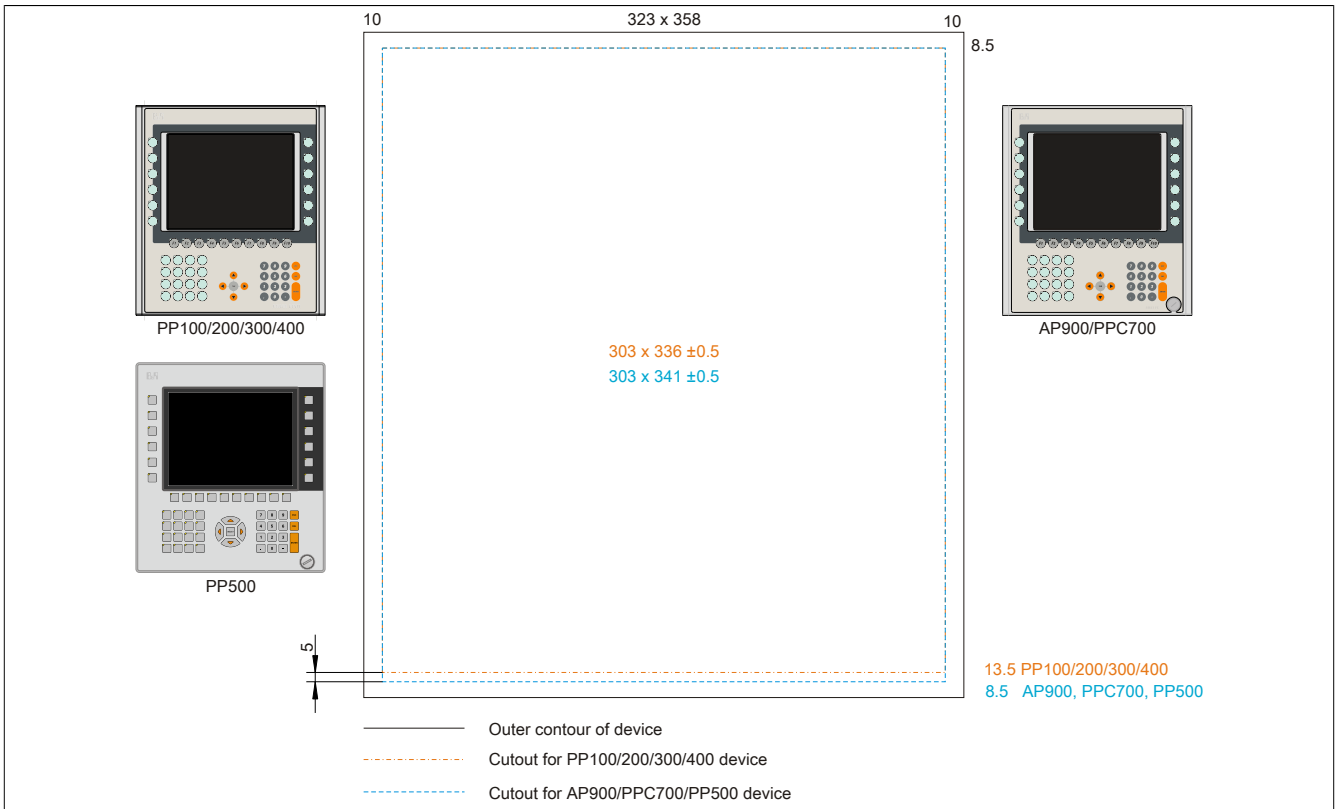

Figure 205: Mounting compatibility - 10.4" device - Vertical1

10.4" Power Panel 500, Automation Panel 900 and Panel PC 700 devices are not 100% mounting compatible with Power Panel 100/200/300/400 devices in Vertical1 format. The Power Panel 500, Automation Panel 900 and Panel PC 700 devices require a cutout that is 5 mm higher (bottom edge).

The larger cutout can be used for all devices under certain conditions:

- When mounting, make sure that the PP100/200/300/400 devices are placed and mounted as close to the center of the cutout as possible. Failure to do so can prevent the retaining clips from holding firmly, which means that a firm seal is no longer guaranteed with the gasket (IP65).

6.2.4 12.1" devices

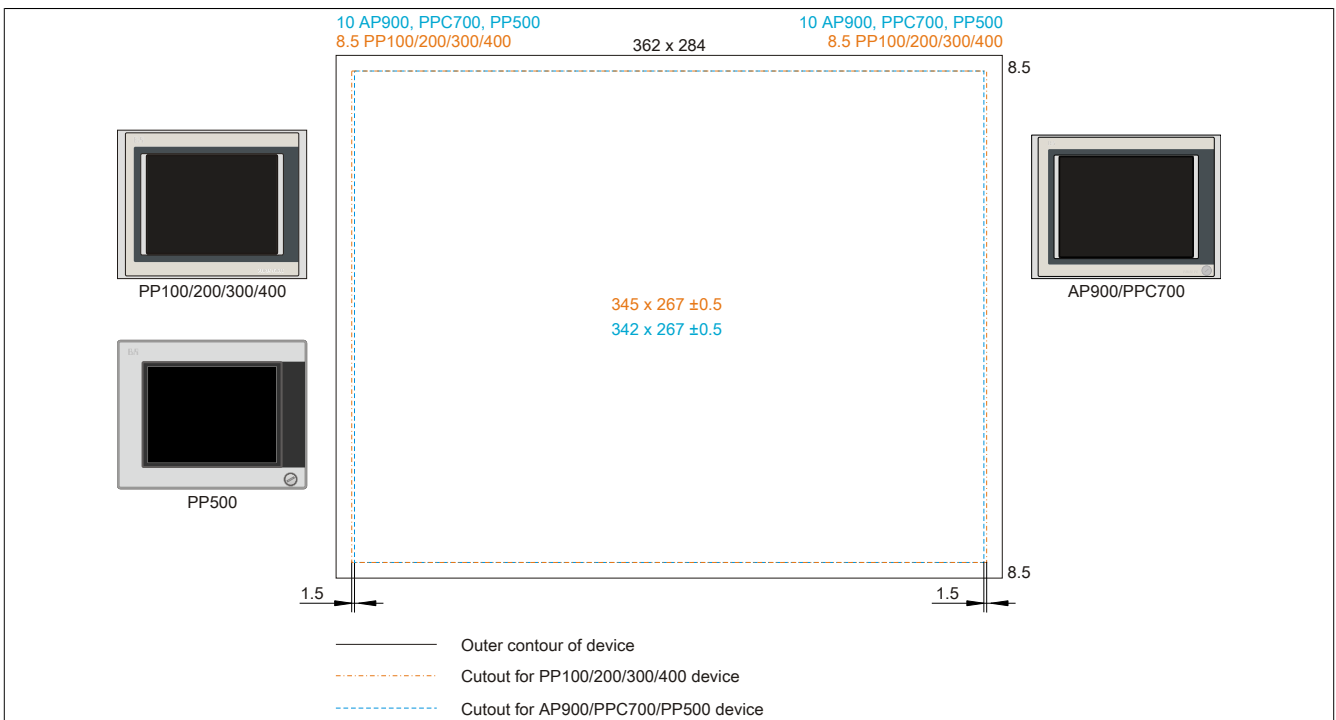

Figure 206: Mounting compatibility - 12.1" device - Horizontal1

12.1" Power Panel 500, Automation Panel 900 and Panel PC 700 devices are not 100% mounting compatible with Power Panel 100/200/300/400 devices in Horizontal1 format. The Power Panel 300/400 and Power Panel 100/200 devices require a cut that is 1.5 mm wider (left and right).

The larger cutout can be used for all devices under certain conditions:

- When mounting, make sure that the PP500, AP900 and PPC700 devices are mounted as close to the center of the cutout as possible.

6.2.5 15" devices

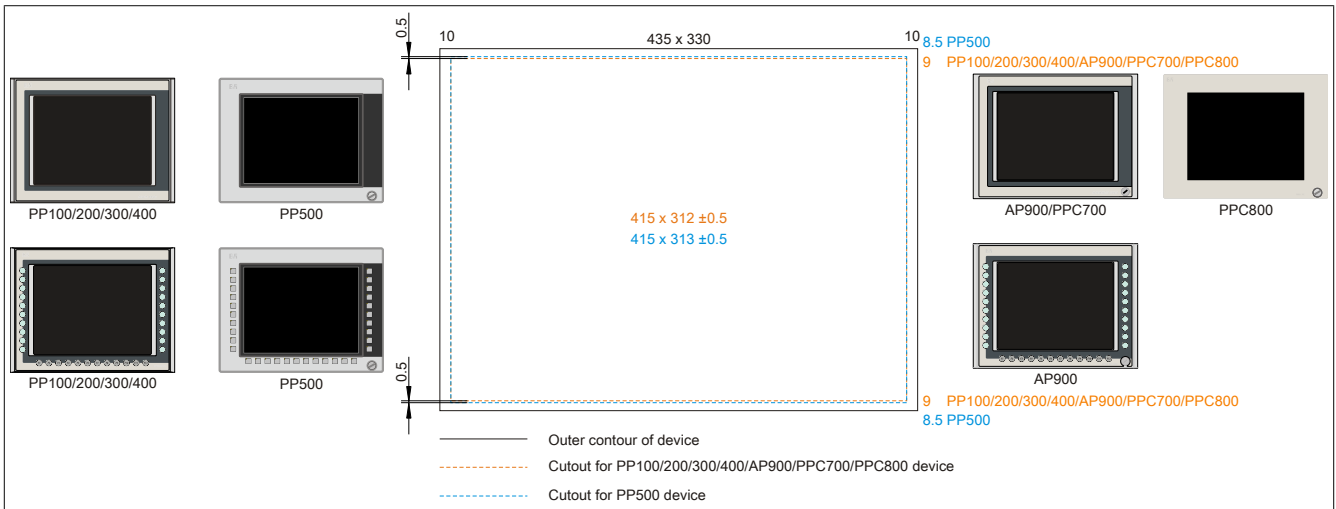

Figure 207: Mounting compatibility - 15" device - Horizontal1

15" Power Panel 500 devices are not 100% mounting compatible with Power Panel 100/200/300/400, Automation Panel 900, Panel PC 700 and Panel PC 800 devices in the Vertical1 format. The Power Panel 500 devices require a cutout that is 0.5 mm higher (top and bottom edge).

The larger cutout can be used for all devices under certain conditions:

- When mounting, make sure that the PP100/200, PP300/400, AP900, PPC700 and PPC800 devices are placed and mounted as close to the center of the cutout as possible. Failure to do so can prevent the retaining clips from holding firmly, which means that a firm seal is no longer guaranteed with the gasket (IP65).

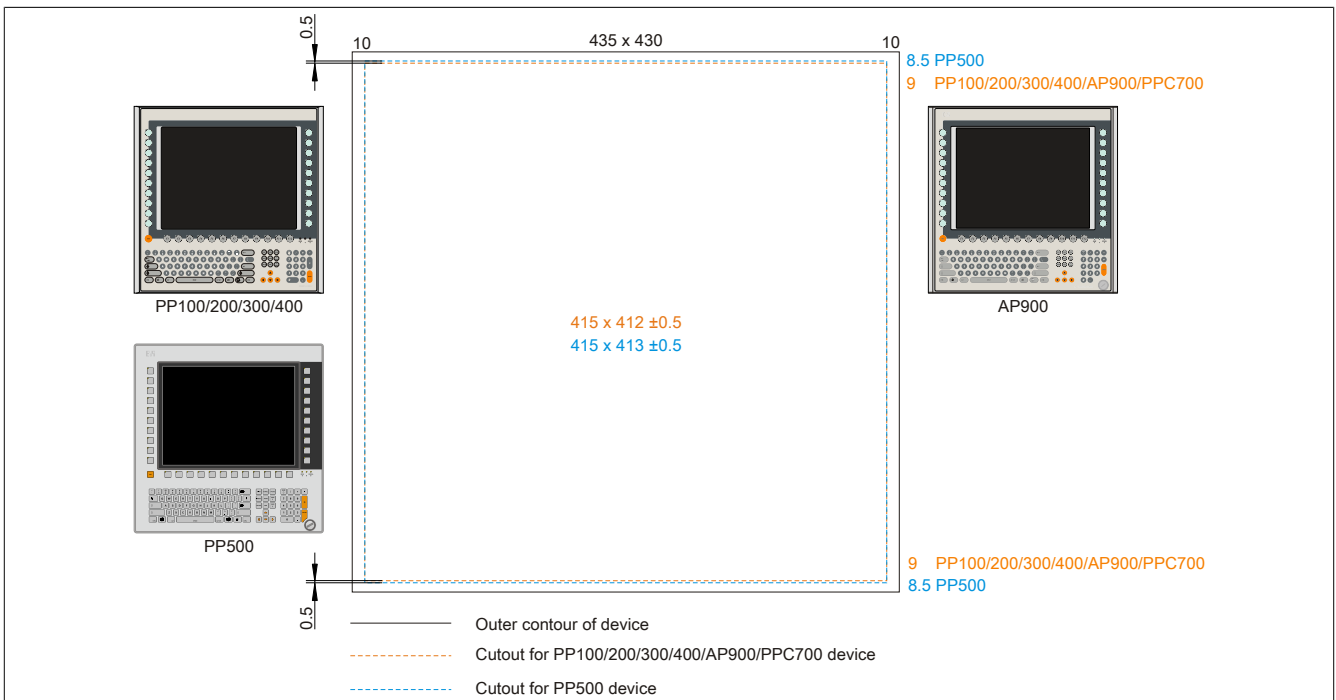

Figure 208: Mounting compatibility - 15" device - Vertical1

15" Power Panel 500 devices are not 100% mounting compatible with Power Panel 100/200/300/400, Automation Panel 900 and Panel PC 700 devices in the Vertical1 format. The Power Panel 500 devices require a cutout that is 0.5 mm higher (top and bottom edge).

The larger cutout can be used for all devices under certain conditions:

- When mounting, make sure that the PP100/200, PP300/400, AP900 and PPC700 devices are mounted as close to the center of the cutout as possible. Failure to do so can prevent the retaining clips from holding firmly, which means that a firm seal is no longer guaranteed with the gasket (IP65).

6.2.6 17" devices

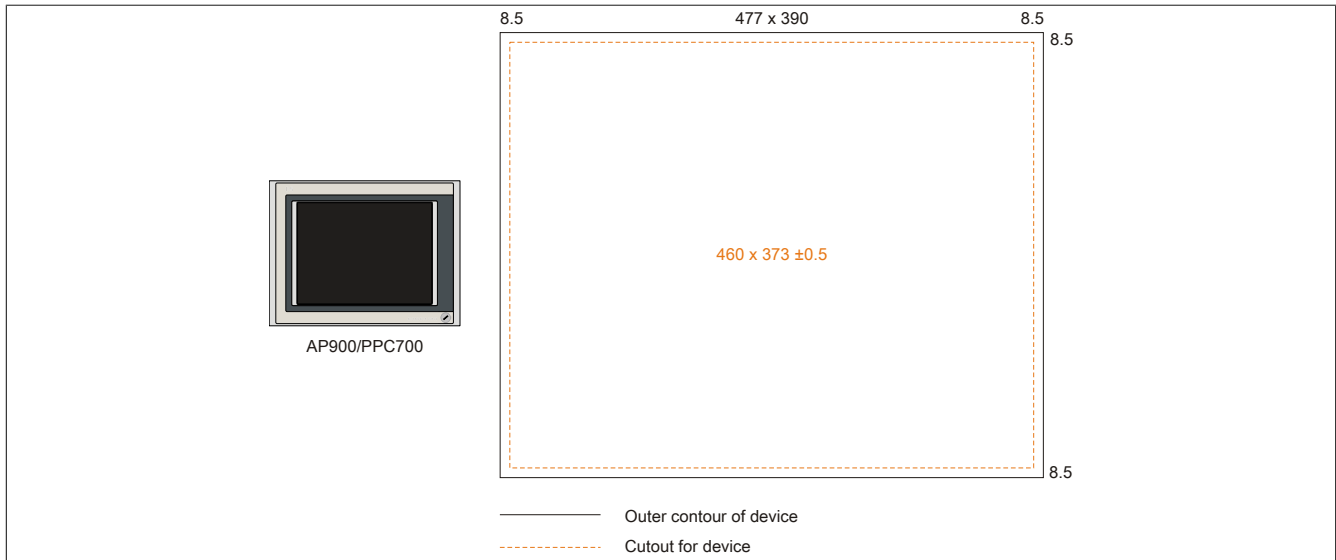

Figure 209: Mounting compatibility - 17" device - Horizontal1

17" Automation Panel 900 devices are 100% mounting compatible with Panel PC 700 devices in the Horizontal1 format.

6.2.7 19" devices

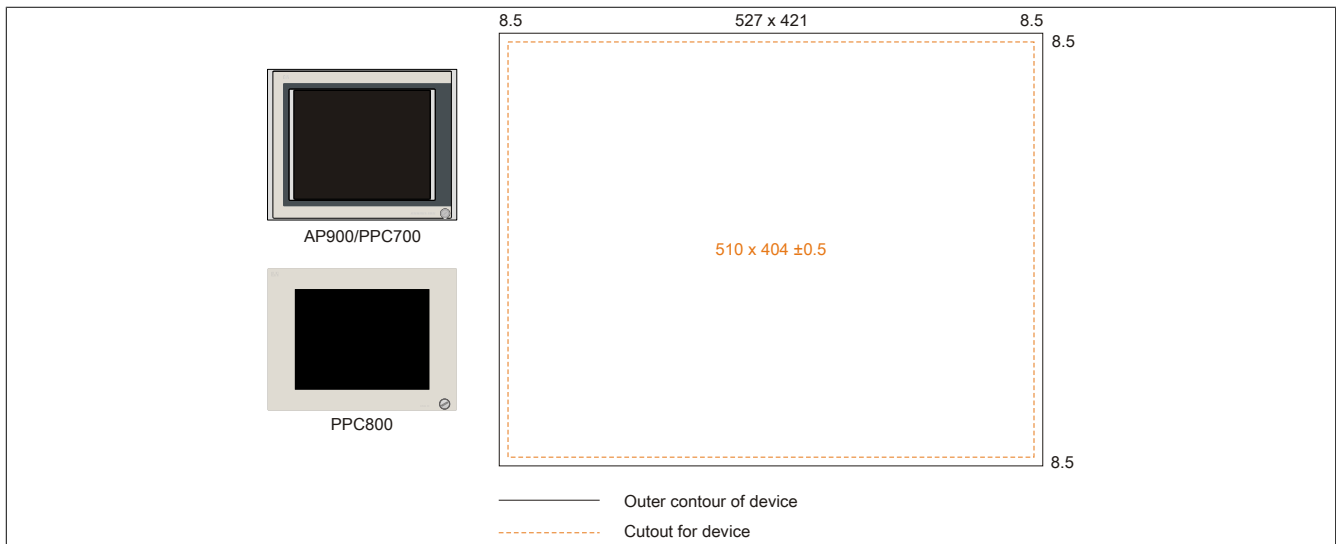

Figure 210: Mounting compatibility - 19" device - Horizontal1

19" Automation Panel 900, Panel PC 700 and Panel PC 800 are 100% mounting compatible in the Horizontal1 format.

6.2.8 21.3" devices

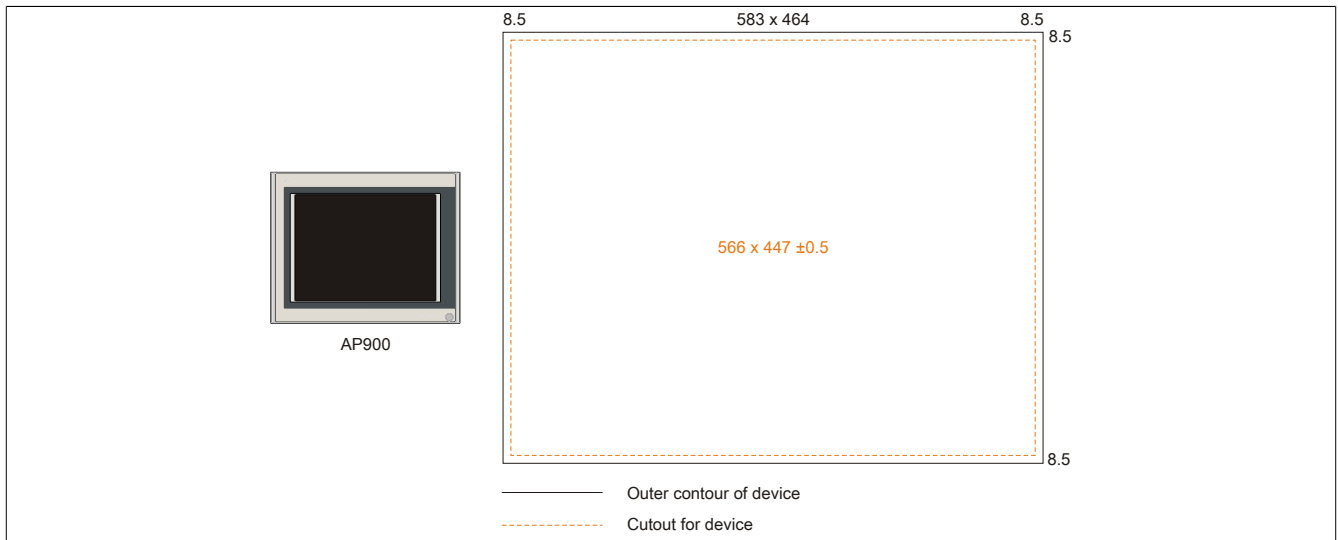

Figure 211: Mounting compatibility - 21.1" device - Horizontal1

7 Glossary

Address	An address is a character string for identifying a memory location or a memory area, where data is stored and can be retrieved. It is also a symbol (e.g. with numerical controllers) for identifying a function unit for which subsequent geometrical or technological data are determined by the symbol.
Algorithms	<p>According to DIN 19226: Algorithms are a finite series of well-defined regulations. The desired output quantities are created from permitted system input quantities. It describes how something is to be done. A procedure must at least satisfy the following requirements to be valid as an algorithm in a mathematical context.</p> <p><i>Discreteness:</i> An algorithm is made up of a finite series of steps.</p> <p><i>Determinacy:</i> Under the same start conditions, it always creates the same end result.</p> <p><i>Clearness:</i> The series of steps is clearly defined.</p> <p><i>Finiteness:</i> It ends after a finite number of steps.</p> <p>From a quantity theory perspective, an algorithm is clearly defined by a set of sizes [input, intermediate and output sizes], a set of elementary operations and also by a regulation, which specifies when and in what sequence certain operations should be carried out. From a functional perspective, it transfers a set of input sizes into a set of output sizes. It can be represented in text form in a natural or artificial formal language or using graphic representations [graph, program flow chart, structured chart, Petri Nets etc.].</p>
Analog Signal	A signal, whose information parameters can accept any number of values, within specific technical limits. Theoretically, they can have an infinitely high resolution. However, in practice it is limited to a range of only 1 to 104. In addition, long-term storage and allocation causes many size problems. Therefore, digital signals are predominantly used in modern automation technology.
ANSI	American National Standards Institute > this organization promotes and manages American industrial standards.
APC	Abbreviation for »Automation PC«
Application software	Software, which is not used for operation by the computer itself, but rather when a computer is used to process a concrete application problem. It sets up the system software and uses this for fulfilling individual tasks. Application software can be accommodated in standard software used by a large number of customers in a wide range of industries. Common examples are Word, Excel, PowerPoint, Paint, Matlab etc. Industrial software tailored to the respective problems of a certain industry and individual software created for solving the particular problems of an individual user.
Automation	According to Brockhaus: The application of technical means, using specific programs that (either partially or totally) do not require human intervention to perform operations.
Automation Runtime	A uniform runtime system for all B&R automation components.
Failure	Failure according to IEC 61508: A function unit loses the ability to perform a required function. In regards to safety-oriented systems, a distinction is made between dangerous and safe failures. This depends on whether the status of the system failure is considered dangerous or safe. The cause of the failure may be load related or age-related, and therefore a random failure, or related to a flaw inherent in the system. In this case, it is known as a systematic failure.

Figure 1:	Configuration - Base system.....	21
Figure 2:	Accessory and software configuration.....	22
Figure 3:	Temperature sensor locations.....	25
Figure 4:	Supply voltage block diagram.....	27
Figure 5:	Block diagram with bus unit 5AC803.BX01-00.....	30
Figure 6:	Block diagram with bus unit 5AC803.BX01-01.....	31
Figure 7:	Block diagram with bus unit 5AC803.BX02-00.....	32
Figure 8:	Block diagram with bus unit 5AC803.BX02-01.....	33
Figure 9:	Serial number sticker (back).....	34
Figure 10:	Example of serial number search.....	34
Figure 11:	Ground connection.....	35
Figure 12:	5PC820.1505-00 - Front view.....	48
Figure 13:	5PC820.1505-00 - Rear view.....	48
Figure 14:	5PC820.1505 - Dimensions.....	51
Figure 15:	5PC820.1505-00 - Cutout installation.....	51
Figure 16:	5PC820.1906-00 - Front view.....	54
Figure 17:	5PC820.1906-00 - Rear view.....	54
Figure 18:	5PC820.1906-00 - Dimensions.....	57
Figure 19:	5PC820.1906-00 - Cutout installation.....	57
Figure 20:	5AC803.SX01-00, 5AC803.SX02-00 - Slots.....	62
Figure 21:	5AC803.SX01-00 - Dimensions.....	63
Figure 22:	5AC803.SX02-00 - Dimensions.....	64
Figure 23:	Standard half-size PCI card - Dimensions.....	64
Figure 24:	Standard half-size PCIe card - Dimensions.....	65
Figure 25:	1-slot bus units.....	67
Figure 26:	2-slot bus units.....	67
Figure 27:	PCI Express compact plug-in cards - Dimensions.....	70
Figure 28:	POWERLINK card - 2-port node number switch.....	76
Figure 29:	Integrating the POWERLINK plug-in card in Automation Studio.....	76
Figure 30:	5AC801.HDDI-00 - Temperature humidity diagram.....	78
Figure 31:	5AC801.HDDI-03 - Temperature humidity diagram.....	80
Figure 32:	5AC801.HDDI-04 - Temperature humidity diagram.....	82
Figure 33:	5AC801.SSDI-00 - Temperature/Humidity diagram.....	85
Figure 34:	5AC801.SSDI-00 - ATTO disk benchmark v2.34 - cyclic read.....	86
Figure 35:	5AC801.SSDI-00 - ATTO disk benchmark v2.34 - cyclic write.....	86
Figure 36:	5AC801.SSDI-01 - Temperature humidity diagram.....	88
Figure 37:	5AC801.SSDI-02 - Temperature humidity diagram.....	90
Figure 38:	5AC801.SSDI-03 ≤ Rev. C0 - Temperature/Humidity diagram.....	92
Figure 39:	5AC801.SSDI-03 ≥ Rev. D0 - Temperature/Humidity diagram.....	93
Figure 40:	5AC801.SSDI-04 ≤ Rev. C0 - Temperature/Humidity diagram.....	95
Figure 41:	5AC801.SSDI-04 ≥ Rev. D0 - Temperature/Humidity diagram.....	96
Figure 42:	5AC801.SSDI-05 - Temperature humidity diagram.....	98
Figure 43:	5MMSSD.0060-00 - Temperature humidity diagram.....	100
Figure 44:	5MMSSD.0060-01 ≤ Rev. C0 - Temperature/Humidity diagram.....	102
Figure 45:	5MMSSD.0060-01 ≥ Rev. D0 - Temperature/Humidity diagram.....	103
Figure 46:	5MMSSD.0128-01 ≤ Rev. C0 - Temperature/Humidity diagram.....	105
Figure 47:	5MMSSD.0128-01 ≥ Rev. D0 - Temperature/Humidity diagram.....	106
Figure 48:	5MMSSD.0180-00 - Temperature humidity diagram.....	108
Figure 49:	5MMSSD.0256-00 - Temperature/Humidity diagram.....	110
Figure 50:	5AC801.HDDS-00 - Temperature humidity diagram.....	113
Figure 51:	5AC801.DVDS-00 - Temperature humidity diagram.....	115
Figure 52:	5AC801.DVRS-00 - Temperature humidity diagram.....	118
Figure 53:	PCI SATA RAID controller.....	119
Figure 54:	5ACPCI.RAIC-05 - Temperature humidity diagram.....	121
Figure 55:	PCI SATA RAID controller.....	122
Figure 56:	5ACPCI.RAIC-06 - Temperature humidity diagram.....	124
Figure 57:	5MMHDD.0250-00 - Temperature humidity diagram.....	126

Figure 58:	5MMHDD.0500-00 - Temperature humidity diagram.....	128
Figure 59:	5AC803.FA01-00 - Fan kit.....	129
Figure 60:	5AC803.FA02-00 - Fan kit.....	130
Figure 61:	5AC803.FA03-00 - Fan kit.....	132
Figure 62:	Clamping blocks.....	134
Figure 63:	Mounting orientation 0° and +/- 45°.....	136
Figure 64:	Mounting orientation with 5AC801.DVRS-00.....	137
Figure 65:	Mounting orientation with 5AC801.DVDS-00.....	138
Figure 66:	Spacing for air circulation.....	139
Figure 67:	Flex radius - Cable connection.....	140
Figure 68:	Symbol for functional ground.....	141
Figure 69:	Grounding concept.....	141
Figure 70:	Settings for Passmark BurnInTest Pro V4 and a 2-slot APC810 with DVD.....	143
Figure 71:	Test overview of a 2-slot APC810 with DVD.....	144
Figure 72:	One office TFT via RGB.....	146
Figure 73:	Local connection of USB peripheral devices on the PPC800.....	148
Figure 74:	Open the RAID Configuration Utility.....	149
Figure 75:	RAID Configuration Utility - Menu.....	149
Figure 76:	RAID Configuration Utility - Menu.....	150
Figure 77:	RAID Configuration Utility - Create RAID set - Striped.....	150
Figure 78:	RAID Configuration Utility - Create RAID set - Mirrored.....	151
Figure 79:	RAID Configuration Utility - Delete RAID set.....	151
Figure 80:	RAID Configuration Utility - Rebuild mirrored set.....	152
Figure 81:	RAID Configuration Utility - Resolve conflicts.....	152
Figure 82:	RAID Configuration Utility - Low level format.....	153
Figure 83:	Boot screen.....	156
Figure 84:	NM10 Main - Übersicht.....	158
Figure 85:	NM10 Advanced - Übersicht.....	159
Figure 86:	NM10 Advanced - Graphics Configuration.....	160
Figure 87:	NM10 Advanced - Baseboard/Panel Features.....	161
Figure 88:	NM10 Advanced - Baseboard/Panel Features - Panel Control.....	162
Figure 89:	NM10 Advanced - Baseboard/Panel Features - Panel Control - Panel #x.....	162
Figure 90:	NM10 Advanced - Baseboard/Panel Features - Baseboard Monitor.....	163
Figure 91:	NM10 Advanced - Baseboard/Panel Features - Super I/O Configuration.....	164
Figure 92:	NM10 Advanced - Hardware monitoring.....	165
Figure 93:	NM10 Advanced - PCI Configuration.....	166
Figure 94:	NM10 Advanced - PCI Configuration - PIRQ Routing & IRQ Reservation.....	167
Figure 95:	NM10 Advanced - PCI Express Configuration.....	168
Figure 96:	NM10 Advanced - PCI Express Configuration - PCI Express Root Port 0.....	169
Figure 97:	NM10 Advanced - PCI Express Configuration - PCI Express Root Port x.....	171
Figure 98:	NM10 Advanced - PCI Express Configuration - PCI Express Settings.....	173
Figure 99:	NM10 Advanced - RTC Wake Settings.....	174
Figure 100:	NM10 Advanced - ACPI Settings.....	175
Figure 101:	NM10 Advanced - CPU Configuration.....	176
Figure 102:	NM10 Advanced - CPU Configuration - CPU Information.....	177
Figure 103:	NM10 Advanced - Memory Configuration.....	178
Figure 104:	NM10 Advanced - Memory Configuration - Memory Information.....	179
Figure 105:	NM10 Advanced - Chipset Configuration.....	179
Figure 106:	NM10 Advanced - IDE configuration.....	180
Figure 107:	NM10 Advanced - USB Configuration.....	181
Figure 108:	NM10 Advanced - Serial Port Console Redirection.....	182
Figure 109:	NM10 Console Redirection Settings (COMA).....	183
Figure 110:	NM10 Console Redirection Settings (EMS).....	184
Figure 111:	NM10 Boot - Übersicht.....	185
Figure 112:	NM10 Boot - Boot Device Priority.....	185
Figure 113:	NM10 Boot - Boot Configuration.....	186
Figure 114:	NM10 Security - Übersicht.....	187

Figure 115:	NM10 Save & Exit - Übersicht.....	189
Figure 116:	PCI and PCIe routing with enabled APIC for NM10 CPU boards.....	196
Figure 117:	Software version.....	197
Figure 118:	Creating a bootable diskette in Windows XP - Step 1.....	201
Figure 119:	Creating a bootable diskette in Windows XP - Step 2.....	201
Figure 120:	Creating a bootable diskette in Windows XP - Step 3.....	201
Figure 121:	Creating a bootable diskette in Windows XP - Step 4.....	202
Figure 122:	Creating a bootable diskette in Windows XP - Step 5.....	202
Figure 123:	Creating a USB flash drive for B&R upgrade files.....	203
Figure 124:	Creating a CompactFlash card for B&R upgrade files.....	204
Figure 125:	ADI Control Center screenshots - Examples.....	216
Figure 126:	ADI Control Center - SDL Equalizer settings.....	218
Figure 127:	ADI Control Center - UPS settings.....	219
Figure 128:	ADI Control Center - UPS monitor.....	220
Figure 129:	ADI Control Center - UPS battery settings.....	221
Figure 130:	ADI Control Center - UPS settings.....	222
Figure 131:	ADI Control Center - Advanced UPS settings.....	224
Figure 132:	ADI Development Kit Screenshots (Version 3.70).....	226
Figure 133:	ADI .NET SDK screenshots (version 2.10).....	228
Figure 134:	B&R Key Editor screenshots (version 3.50).....	230
Figure 135:	UPS principle.....	240
Figure 136:	5AC600. UPSI-00 Add-on UPS module - Installation materials.....	242
Figure 137:	Deep discharge cycles.....	244
Figure 138:	5PC600. UPSB-00 - Dimensions.....	245
Figure 139:	5PC600. UPSB-00 - Drilling template.....	245
Figure 140:	Block diagram of the complete system.....	248
Figure 141:	5ACPCI. ETH1-01 - PCI 10/100 Ethernet card.....	250
Figure 142:	5ACPCI. ETH1-01 - Dimensions.....	252
Figure 143:	5ACPCI. ETH3-01 - PCI 10/100 Ethernet card.....	253
Figure 144:	5ACPCI. ETH3-01 - Dimensions.....	255
Figure 145:	5CFCRD. xxx-06 - Temperature/Humidity diagram for CompactFlash cards.....	262
Figure 146:	Type I CompactFlash card - Dimensions.....	262
Figure 147:	ATTO Disk Benchmark v2.34 read comparison - 5CFCRD. xxx-04 and 5CFCRD. xxx-06.....	263
Figure 148:	ATTO Disk Benchmark v2.34 write comparison - 5CFCRD. xxx-04 and 5CFCRD. xxx-06.....	263
Figure 149:	5CFCRD. xxx-03 - Temperature/Humidity diagram for CompactFlash cards.....	266
Figure 150:	Type I CompactFlash card - Dimensions.....	266
Figure 151:	5MMUSB. 2048-00 - Temperature/Humidity diagram.....	269
Figure 152:	5MMUSB. xxx-01 - Temperature/Humidity diagram.....	271
Figure 153:	5MD900. USB2-02 - Interfaces.....	272
Figure 154:	5MD900. USB2-02 - Dimensions.....	274
Figure 155:	USB media drive with front cover - Dimensions.....	274
Figure 156:	USB media drive with front cover - Installation cutout.....	275
Figure 157:	5MD900. USB2-02 - Mounting orientation	275
Figure 158:	5A5003. 03 - Dimensions.....	276
Figure 159:	Front cover mounting and installation depth.....	277
Figure 160:	USB media drive with front cover - Installation cutout.....	277
Figure 161:	5CAUSB. 00xx-00 USB cables - Pinout.....	281
Figure 162:	9A0014. xx RS232 cables - Pinout	283
Figure 163:	Removing the battery.....	286
Figure 164:	Battery handling.....	286
Figure 165:	Battery polarity.....	286
Figure 166:	CompactFlash + ejector.....	288
Figure 167:	Loosening the quick release screws.....	289
Figure 168:	Inserting the compact SATA drive.....	289
Figure 169:	Loosening the quick release screws.....	290
Figure 170:	Installing the slide-in drive.....	290
Figure 171:	Loosening the quick release screws.....	291

Figure 172:	Installing the slide-in compact adapter.....	291
Figure 173:	Inserting the slide-in compact drive.....	292
Figure 174:	Removing the fan kit cover.....	293
Figure 175:	Inserting the fan kit.....	293
Figure 176:	Securing the dust filter with the filter clasp.....	293
Figure 177:	5AC600. UPSI-00 Add-on UPS module - Installation materials.....	295
Figure 178:	Removing the UPS module cover.....	295
Figure 179:	Installing the UPS module.....	295
Figure 180:	Attaching the connection cable.....	296
Figure 181:	Connector locking mechanism.....	296
Figure 182:	Removing the cover for the battery unit.....	297
Figure 183:	Disconnecting the cable.....	297
Figure 184:	Connecting the fuse.....	298
Figure 185:	Securing the fuse.....	298
Figure 186:	Removing the screws.....	299
Figure 187:	Installing the bus unit.....	299
Figure 188:	Removing the screws.....	300
Figure 189:	Installing the 5AC803.BC01-00 adapter.....	300
Figure 190:	Installing the 5AC803.BC02-00 adapter.....	301
Figure 191:	Removing the PCIec module cover.....	302
Figure 192:	Inserting the PCIec plug-in card.....	302
Figure 193:	Installing the side cover on a PPC800 without an expansion.....	303
Figure 194:	Installing the side cover on a PPC800 with an expansion (1-slot expansion shown in image).....	303
Figure 195:	Screw layout on the back side of the 5ACPCI.RAIC-03 SATA RAID controller.....	304
Figure 196:	Replacing the hard disk.....	305
Figure 197:	MTCX controller location.....	306
Figure 198:	Connector location for external devices.....	308
Figure 199:	5-wire AMT touch screen - Temperature/Humidity diagram.....	309
Figure 200:	Overview of compatibility figures.....	314
Figure 201:	Mounting compatibility - 5.7" device - Horizontal1.....	314
Figure 202:	Mounting compatibility - 5.7" device - Horizontal2.....	315
Figure 203:	Mounting compatibility - 5.7" device - Vertical1.....	315
Figure 204:	Mounting compatibility - 10.4" device - Horizontal1.....	316
Figure 205:	Mounting compatibility - 10.4" device - Horizontal2.....	316
Figure 206:	Mounting compatibility - 10.4" device - Vertical1.....	317
Figure 207:	Mounting compatibility - 12.1" device - Horizontal1.....	317
Figure 208:	Mounting compatibility - 15" device - Horizontal1.....	318
Figure 209:	Mounting compatibility - 15" device - Vertical1.....	318
Figure 210:	Mounting compatibility - 17" device - Horizontal1.....	319
Figure 211:	Mounting compatibility - 19" device - Horizontal1.....	319
Figure 212:	Mounting compatibility - 21.1" device - Horizontal1.....	320

Table 1:	Manual history.....	12
Table 2:	Environmentally friendly separation of materials.....	15
Table 3:	Description of the safety notices used in this documentation.....	15
Table 4:	Range of nominal sizes.....	15
Table 5:	Ambient temperatures.....	24
Table 6:	Temperature sensor locations.....	25
Table 7:	Overview of humidity specifications for individual components.....	26
Table 8:	Power calculation for 15" PPC800.....	28
Table 9:	Power calculation for 19" PPC800.....	29
Table 10:	24 VDC power supply interface.....	35
Table 11:	Monitor/Panel interface - RGB.....	36
Table 12:	Pinbelegung DVI-Anschluss.....	36
Table 13:	COM1 - Pinout.....	37
Table 14:	Ethernet interface (ETH1).....	38
Table 15:	Ethernet-Schnittstelle (ETH2).....	38
Table 16:	USB1-, USB2-, USB3-, USB4-Schnittstellen.....	39
Table 17:	USB5-Schnittstelle.....	39
Table 18:	CompactFlash slot (CF1).....	40
Table 19:	CompactFlash slot (CF2).....	40
Table 20:	MIC, Line IN, Line OUT.....	41
Table 21:	Add-on UPS slot.....	41
Table 22:	Power button.....	42
Table 23:	Reset button.....	42
Table 24:	LED status indicators.....	43
Table 25:	CMOS profile switch.....	43
Table 26:	Battery.....	44
Table 27:	Battery status.....	44
Table 28:	Slide-in compact slot.....	45
Table 29:	PCIec slot.....	45
Table 30:	5PC820.1505-00 - Order data.....	46
Table 31:	5PC820.1505-00, 5PC820.1505-00 - Technical data.....	48
Table 32:	5PC820.1906-00 - Order data.....	52
Table 33:	5PC820.1906-00, 5PC820.1906-00 - Technical data.....	54
Table 34:	5PC800.CCAX-00 - Order data.....	58
Table 35:	5PC800.CCAX-00 - Technical data.....	58
Table 36:	5AC803.HS00-04 - Order data.....	60
Table 37:	5AC803.HS00-04 - Technical data.....	60
Table 38:	5MMDDR.2048-02, 5MMDDR.4096-02 - Order data.....	61
Table 39:	5MMDDR.2048-02, 5MMDDR.4096-02 - Technical data.....	61
Table 40:	5AC803.SX01-00, 5AC803.SX02-00 - Order data.....	62
Table 41:	5AC803.SX01-00, 5AC803.SX02-00 - Technical data.....	62
Table 42:	Slide-in slot 1.....	66
Table 43:	5AC803.BX01-00, 5AC803.BX01-01, 5AC803.BX02-00, 5AC803.BX02-01 - Order data.....	67
Table 44:	5AC803.BX01-00, 5AC803.BX01-01, 5AC803.BX02-00, 5AC803.BX02-01 - Technical data.....	67
Table 45:	5AC803.BC01-00 - Order data.....	69
Table 46:	5AC803.BC02-00 - Order data.....	69
Table 47:	5ACPCC.ETH0-00 - Order data.....	71
Table 48:	5ACPCC.ETH0-00 - Technical data.....	71
Table 49:	5ACPCC.ETH0-00 - Ethernet interface.....	72
Table 50:	5ACPCC.MPL0-00 - Order data.....	73
Table 51:	5ACPCC.MPL0-00 - Technical data.....	73
Table 52:	5ACPCC.MPL0-00 - POWERLINK interface.....	74
Table 53:	Status/Error LED - Ethernet mode.....	74
Table 54:	Status/Error LED - POWERLINK V1 operating mode.....	74
Table 55:	Status/Error LED - POWERLINK - Error.....	74
Table 56:	Status/Error LED - POWERLINK - Status.....	75
Table 57:	System stop error codes.....	76

Table 58:	POWERLINK station number (x1, x16).....	76
Table 59:	5AC801.HDDI-00 - Order data.....	77
Table 60:	5AC801.HDDI-00 - Technical data.....	77
Table 61:	5AC801.HDDI-03 - Order data.....	79
Table 62:	5AC801.HDDI-03 - Technical data.....	79
Table 63:	5AC801.HDDI-04 - Order data.....	81
Table 64:	5AC801.HDDI-04 - Technical data.....	81
Table 65:	5AC801.SSDI-00 - Order data.....	83
Table 66:	5AC801.SSDI-00 - Technical data.....	83
Table 67:	5AC801.SSDI-01 - Order data.....	87
Table 68:	5AC801.SSDI-01 - Technical data.....	87
Table 69:	5AC801.SSDI-02 - Order data.....	89
Table 70:	5AC801.SSDI-02 - Technical data.....	89
Table 71:	5AC801.SSDI-03 - Order data.....	91
Table 72:	5AC801.SSDI-03, 5AC801.SSDI-03 - Technical data.....	91
Table 73:	5AC801.SSDI-04 - Order data.....	94
Table 74:	5AC801.SSDI-04, 5AC801.SSDI-04 - Technical data.....	94
Table 75:	5AC801.SSDI-05 - Order data.....	97
Table 76:	5AC801.SSDI-05 - Technical data.....	97
Table 77:	5MMSSD.0060-00 - Order data.....	99
Table 78:	5MMSSD.0060-00 - Technical data.....	99
Table 79:	5MMSSD.0060-01 - Order data.....	101
Table 80:	5MMSSD.0060-01, 5MMSSD.0060-01 - Technical data.....	101
Table 81:	5MMSSD.0128-01 - Order data.....	104
Table 82:	5MMSSD.0128-01, 5MMSSD.0128-01 - Technical data.....	104
Table 83:	5MMSSD.0180-00 - Order data.....	107
Table 84:	5MMSSD.0180-00 - Technical data.....	107
Table 85:	5MMSSD.0256-00 - Order data.....	109
Table 86:	5MMSSD.0256-00 - Technical data.....	109
Table 87:	5AC801.ADAS-00 - Order data.....	111
Table 88:	5AC801.ADAS-00 - Technical data.....	111
Table 89:	5AC801.HDDS-00 - Order data.....	112
Table 90:	5AC801.HDDS-00 - Technical data.....	112
Table 91:	5AC801.DVDS-00 - Order data.....	114
Table 92:	5AC801.DVDS-00 - Technical data.....	114
Table 93:	5AC801.DVRS-00 - Order data.....	116
Table 94:	5AC801.DVRS-00 - Technical data.....	116
Table 95:	5ACPCI.RAIC-05 - Order data.....	119
Table 96:	5ACPCI.RAIC-05 - Technical data.....	120
Table 97:	5ACPCI.RAIC-06 - Order data.....	122
Table 98:	5ACPCI.RAIC-06 - Technical data.....	123
Table 99:	5MMHDD.0250-00 - Order data.....	125
Table 100:	5MMHDD.0250-00 - Technical data.....	125
Table 101:	5MMHDD.0500-00 - Order data.....	127
Table 102:	5MMHDD.0500-00 - Technical data.....	127
Table 103:	5AC803.FA01-00 - Order data.....	129
Table 104:	5AC803.FA01-00 - Technical data.....	129
Table 105:	5AC803.FA02-00 - Order data.....	130
Table 106:	5AC803.FA02-00 - Technical data.....	130
Table 107:	5AC803.FA03-00 - Order data.....	132
Table 108:	5AC803.FA03-00 - Technical data.....	132
Table 109:	Evaluation example using a 2-slot APC810.....	145
Table 110:	BIOS-relevant keys in the RAID Configuration Utility.....	149
Table 111:	BIOS-relevant keys for POST.....	157
Table 112:	BIOS-relevant keys.....	157
Table 113:	NM10 Main - Configuration options.....	158
Table 114:	NM10 Advanced - Overview.....	159

Table 115:	NM10 Advanced - Graphics configuration - Configuration options.....	160
Table 116:	NM10 Advanced - Baseboard/Panel features - Configuration options.....	161
Table 117:	NM10 Advanced - Baseboard/Panel features - Panel control - Configuration options.....	162
Table 118:	NM10 Advanced - Baseboard/Panel features - Panel control - Panel #x - Configuration options	163
Table 119:	NM10 Advanced - Baseboard/Panel features - Baseboard monitor.....	163
Table 120:	NM10 Advanced - Baseboard/Panel features - Super I/O configuration - Configuration options.	164
Table 121:	NM10 Advanced - Baseboard/Panel features - Baseboard monitor.....	165
Table 122:	NM10 Advanced - PCI configuration - Configuration options.....	166
Table 123:	NM10 Advanced - PCI configuration - PIRQ routing & IRQ reservation - Configuration options.	167
Table 124:	NM10 Advanced - PCI Express configuration - Overview.....	168
Table 125:	NM10 Advanced - PCI Express configuration - PCI Express root port 0 - Configuration options.	169
Table 126:	NM10 Advanced - PCI Express configuration - PCI Express root port x - Configuration options.	171
Table 127:	NM10 Advanced - PCI Express configuration - PCI Express settings - Configuration options..	173
Table 128:	NM10 Advanced - RTC wake settings - Configuration options.....	174
Table 129:	NM10 Advanced - ACPI settings - Configuration options.....	175
Table 130:	NM10 Advanced - CPU configuration - Configuration options.....	176
Table 131:	NM10 Advanced - CPU configuration - Configuration options.....	177
Table 132:	NM10 Advanced - Memory configuration - Configuration options.....	178
Table 133:	NM10 Advanced - Memory configuration - Memory information.....	179
Table 134:	NM10 Advanced - Chipset configuration - Configuration options.....	180
Table 135:	NM10 Advanced - IDE configuration - Configuration options.....	180
Table 136:	NM10 Advanced - USB configuration - Configuration options.....	181
Table 137:	NM10 Advanced - Serial port console redirection - Configuration options.....	182
Table 138:	NM10 Advanced - Serial port console redirection - Console redirection settings (COMA) - Configuration options.....	183
Table 139:	NM10 Advanced - Serial port console redirection - Console redirection settings (EMS) - Configuration options.....	184
Table 140:	NM10 Boot - Overview.....	185
Table 141:	Boot - Boot device priority - Configuration options.....	186
Table 142:	Boot - Boot configuration - Configuration options.....	186
Table 143:	NM10 Security menu - Configuration options.....	188
Table 144:	NM10 Save & Exit menu - Configuration options.....	189
Table 145:	Profile overview.....	190
Table 146:	NM10 Main - Profile settings.....	190
Table 147:	NM10 Advanced - Graphics configuration - Profile settings.....	190
Table 148:	NM10 Advanced - Baseboard/Panel features - Profile settings.....	190
Table 149:	NM10 Advanced - Hardware monitoring - Profile settings.....	191
Table 150:	NM10 Advanced - PCI configuration - Profile settings.....	191
Table 151:	NM10 Advanced - PCI Express - Profile settings.....	191
Table 152:	NM10 Advanced - RTC wake - Profile settings.....	192
Table 153:	NM10 Advanced - ACPI settings - Profile settings.....	192
Table 154:	NM10 Advanced - CPU configuration - Profile settings.....	193
Table 155:	NM10 Advanced - Memory configuration - Profile settings.....	193
Table 156:	NM10 Advanced - Chipset configuration - Profile settings	193
Table 157:	NM10 Advanced - IDE configuration - Profile settings.....	193
Table 158:	NM10 Advanced - USB configuration - Profile settings.....	193
Table 159:	NM10 Advanced - Serial port console redirection - Profile settings.....	194
Table 160:	NM10 Boot - Overview of profile settings.....	194
Table 161:	NM10 Security - Profile settings.....	194
Table 162:	RAM address assignment.....	195
Table 163:	I/O address assignment.....	195
Table 164:	IRQ interrupt assignments in PIC mode.....	195
Table 165:	IRQ interrupt assignments in APIC mode.....	196
Table 166:	9S0000.01-010, 9S0000.01-020 - Order data.....	205
Table 167:	Tested resolutions and color depths for RGB signals.....	205
Table 168:	5SWWXP.0600-GER, 5SWWXP.0600-ENG, 5SWWXP.0600-MUL - Order data.....	206
Table 169:	5SWWI7.1100-GER, 5SWWI7.1100-ENG, 5SWWI7.1300-MUL - Order data.....	208

Table 170:	5SWWXP.0739-ENG - Order data.....	210
Table 171:	Device functions in Windows Embedded Standard 2009.....	210
Table 172:	5SWWI7.1539-ENG, 5SWWI7.1739-MUL - Order data.....	212
Table 173:	Device functions in Windows Embedded Standard 7.....	212
Table 174:	0TG1000.01, 1TG4600.10-5 - Order data.....	214
Table 175:	0AC201.91, 4A0006.00-000 - Order data.....	234
Table 176:	0AC201.91, 4A0006.00-000 - Technical data.....	234
Table 177:	0TB103.9, 0TB103.91 - Order data.....	236
Table 178:	0TB103.9, 0TB103.91 - Technical data.....	236
Table 179:	5AC900.1000-00 - Order data.....	237
Table 180:	5AC900.1201-00 - Order data.....	238
Table 181:	5AC900.1201-01 - Order data.....	238
Table 182:	5AC900.BLOC-00 - Order data.....	239
Table 183:	5AC600.UPSI-00 - Order data.....	241
Table 184:	5AC600.UPSI-00 - Technical data.....	241
Table 185:	5AC600.UPSB-00 - Order data.....	243
Table 186:	5AC600.UPSB-00, 5AC600.UPSB-00 - Technical data.....	243
Table 187:	5CAUPS.0005-00, 5CAUPS.0030-00 - Order data.....	246
Table 188:	5CAUPS.0005-00, 5CAUPS.0030-00 - Technical data.....	246
Table 189:	5AC600.UPSF-00 - Order data.....	247
Table 190:	5AC600.UPSF-01 - Order data.....	247
Table 191:	9A0100.11, 9A0100.12, 9A0100.13, 9A0100.14, 9A0100.15, 9A0100.16, 9A0100.17 - Order data.....	248
Table 192:	5ACPCI.ETH1-01 - Order data.....	250
Table 193:	5ACPCI.ETH1-01 - Technical data.....	250
Table 194:	5ACPCI.ETH1-01 - Technical data.....	251
Table 195:	5ACPCI.ETH3-01 - Order data.....	253
Table 196:	5ACPCI.ETH3-01 - Technical data.....	253
Table 197:	5ACPCI.ETH3-01 - Technical data.....	254
Table 198:	5CFCRD.0512-06, 5CFCRD.1024-06, 5CFCRD.2048-06, 5CFCRD.4096-06, 5CFCRD.8192-06, 5CFCRD.016G-06, 5CFCRD.032G-06 - Order data.....	258
Table 199:	5CFCRD.0512-06, 5CFCRD.1024-06, 5CFCRD.2048-06, 5CFCRD.4096-06, 5CFCRD.8192-06, 5CFCRD.016G-06, 5CFCRD.032G-06 - Order data.....	258
Table 200:	5CFCRD.0512-06, 5CFCRD.1024-06, 5CFCRD.2048-06, 5CFCRD.4096-06, 5CFCRD.8192-06, 5CFCRD.016G-06, 5CFCRD.032G-06 - Technical data.....	259
Table 201:	5CFCRD.0512-06, 5CFCRD.1024-06, 5CFCRD.2048-06, 5CFCRD.4096-06, 5CFCRD.8192-06, 5CFCRD.016G-06, 5CFCRD.032G-06 - Technical data.....	260
Table 202:	5CFCRD.0064-03, 5CFCRD.0128-03, 5CFCRD.0256-03, 5CFCRD.0512-03, 5CFCRD.1024-03, 5CFCRD.2048-03, 5CFCRD.4096-03, 5CFCRD.8192-03 - Order data.....	264
Table 203:	5CFCRD.0064-03, 5CFCRD.0128-03, 5CFCRD.0256-03, 5CFCRD.0512-03, 5CFCRD.1024-03, 5CFCRD.2048-03, 5CFCRD.4096-03, 5CFCRD.8192-03 - Technical data.....	264
Table 204:	5MMUSB.2048-00 - Order data.....	268
Table 205:	5MMUSB.2048-00 - Technical data.....	268
Table 206:	5MMUSB.2048-01, 5MMUSB.4096-01 - Order data.....	270
Table 207:	5MMUSB.2048-01, 5MMUSB.4096-01 - Technical data.....	270
Table 208:	5MD900.USB2-02 - Order data.....	272
Table 209:	5MD900.USB2-02 - Technical data.....	272
Table 210:	5MD900.USB2-02 - Contents of delivery.....	275
Table 211:	5A5003.03 - Order data.....	276
Table 212:	5A5003.03 - Technical data.....	276
Table 213:	5A5003.03 - Contents of delivery.....	276
Table 214:	5SWHMI.0000-00 - Order data.....	278
Table 215:	5CAUSB.0018-00, 5CAUSB.0050-00 - Order data.....	281
Table 216:	5CAUSB.0018-00, 5CAUSB.0050-00 - Technical data.....	281
Table 217:	9A0014.02, 9A0014.05, 9A0014.10 - Order data.....	282
Table 218:	9A0014.02, 9A0014.05, 9A0014.10 - Technical data.....	282
Table 219:	5CAMSC.0001-00 - Order data.....	284
Table 220:	5CAMSC.0001-00 - Technical data.....	284

Table 221:	Battery status.....	285
Table 222:	Overview of required replacement SATA HDD for PCI SATA HDD RAID controller.....	304
Table 223:	Temperature limits of the fan (MTCX PX32 V1.01).....	307
Table 224:	Connector on the mainboard - Pinout.....	308
Table 225:	5-wire AMT touch screen - Technical data.....	309
Table 226:	Chemical resistance of the panel overlay.....	311
Table 227:	Product abbreviations.....	313
Table 228:	Overview of device compatibility.....	313

0AC201.91.....	234
0TB103.9.....	236
0TB103.91.....	236
0TG1000.01.....	214
1TG4600.10-5.....	214
4A0006.00-000.....	234
5A5003.03.....	276
5AC600.UPSB-00.....	243
5AC600.UPSF-00.....	247
5AC600.UPSF-01.....	247
5AC600.UPSI-00.....	241
5AC801.ADAS-00.....	111
5AC801.DVDS-00.....	114
5AC801.DVRS-00.....	116
5AC801.HDDI-00.....	77
5AC801.HDDI-03.....	79
5AC801.HDDI-04.....	81
5AC801.HDDS-00.....	112
5AC801.SSDI-00.....	83
5AC801.SSDI-01.....	87
5AC801.SSDI-02.....	89
5AC801.SSDI-03.....	91
5AC801.SSDI-04.....	94
5AC801.SSDI-05.....	97
5AC803.BC01-00.....	69
5AC803.BC02-00.....	69
5AC803.BX01-00.....	67
5AC803.BX01-01.....	67
5AC803.BX02-00.....	67
5AC803.BX02-01.....	67
5AC803.FA01-00.....	129
5AC803.FA02-00.....	130
5AC803.FA03-00.....	132
5AC803.HS00-04.....	60
5AC803.SX01-00.....	62
5AC803.SX02-00.....	62
5AC900.1000-00.....	237
5AC900.1201-00.....	238
5AC900.1201-01.....	238
5AC900.BLOC-00.....	239
5ACPCC.ETH0-00.....	71
5ACPCC.MPL0-00.....	73
5ACPCI.ETH1-01.....	250
5ACPCI.ETH3-01.....	253
5ACPCI.RAIC-05.....	119
5ACPCI.RAIC-06.....	122
5CAMSC.0001-00.....	284
5CAUPS.0005-00.....	246
5CAUPS.0030-00.....	246
5CAUSB.0018-00.....	281
5CAUSB.0050-00.....	281
5CFCRD.0064-03.....	264
5CFCRD.0128-03.....	264
5CFCRD.016G-06.....	258
5CFCRD.0256-03.....	264
5CFCRD.032G-06.....	258
5CFCRD.0512-03.....	264
5CFCRD.0512-06.....	258
5CFCRD.1024-03.....	264
5CFCRD.1024-06.....	258
5CFCRD.2048-03.....	264
5CFCRD.2048-06.....	258

5CFCRD.4096-03.....	264
5CFCRD.4096-06.....	258
5CFCRD.8192-03.....	264
5CFCRD.8192-06.....	258
5MD900.USB2-02.....	272
5MMDDR.2048-02.....	61
5MMDDR.4096-02.....	61
5MMHDD.0250-00.....	125
5MMHDD.0500-00.....	127
5MMSSD.0060-00.....	99
5MMSSD.0060-01.....	101
5MMSSD.0128-01.....	104
5MMSSD.0180-00.....	107
5MMSSD.0256-00.....	109
5MMUSB.2048-00.....	268
5MMUSB.2048-01.....	270
5MMUSB.4096-01.....	270
5PC800.CCAX-00.....	58
5PC820.1505-00.....	46
5PC820.1906-00.....	52
5SWHMI.0000-00.....	278
5SWWI7.1100-ENG.....	208
5SWWI7.1100-GER.....	208
5SWWI7.1300-MUL.....	208
5SWWI7.1539-ENG.....	212
5SWWI7.1739-MUL.....	212
5SWWXP.0600-ENG.....	206
5SWWXP.0600-GER.....	206
5SWWXP.0600-MUL.....	206
5SWWXP.0739-ENG.....	210
9A0014.02.....	282
9A0014.05.....	282
9A0014.10.....	282
9A0100.11.....	248
9A0100.12.....	248
9A0100.13.....	248
9A0100.14.....	248
9A0100.15.....	248
9A0100.16.....	248
9A0100.17.....	248
9S0000.01-010.....	205
9S0000.01-020.....	205

A

Abbreviation.....	313
Accessories.....	234
ACPI.....	195, 196
Adapters.....	69
add-on UPS module.....	241
Add-on UPS slot.....	41
ADI.....	216
.NET SDK.....	228
Development Kit.....	226
SDL Equalizer settings.....	218
air circulation.....	139, 139
Ambient temperature	
Minimum.....	25
ARwin.....	214
Automation Runtime.....	214
Automation Runtime Windows.....	214

B

B&R Automation Device Interface.....	216
B&R Control Center.....	216
B&R Embedded OS Installer.....	204
B&R Key Editor.....	230
Backlight.....	154
Battery.....	44
BIOS	
Advanced.....	159
Boot.....	185
Main.....	158
Save & Exit.....	189
BIOS Setup keys.....	157
BIOS upgrade.....	197
bus units.....	64, 67

C

Cable connections.....	140
Cables.....	281
RS232.....	282
USB.....	281
Card slot.....	45
CE mark.....	232
Certifications.....	233
certifications	
GOST-R.....	233
CF1.....	40
CF2.....	40
Chemical resistance.....	311
Clamping blocks.....	239
Cleaning.....	287, 309
climate-controlled chamber.....	145
CMOS profile switch.....	43
COM1.....	37
CompactFlash.....	40
CompactFlash cards.....	256
CompactFlash slot.....	40
Complete system.....	23
Connecting an external device.....	308
Control Center.....	142, 216
Creating reports.....	216

Cutout - PPC800 15".....	51
Cutout - PPC800 19".....	57
D	
dead/stuck pixels.....	154
defective pixels.....	154
deflect disturbances.....	141
Device interfaces and slots.....	35
Dimensions	
5A5003.03.....	276
5MD900.USB2-02.....	274
Dimensions - PPC800 15".....	51
Dimensions - PPC800 19".....	57
Dimension standards.....	15
Disposal.....	15, 15
dongle.....	215
Drives.....	77
Dynamic wear leveling.....	256
E	
Electromagnetic compatibility.....	232
Embedded OS Installer.....	204
EMC directive.....	232
ESD.....	13
Electrical components with a housing.....	13
Electrical components without a housing.....	13
Individual components.....	13
Packaging.....	13
ETH1.....	38
Ethernet.....	38
evaluate the temperature.....	143
Evaluating temperatures.....	142
Evaluating the battery status.....	44, 285
example programs.....	145
Expansions.....	62
External device.....	308
F	
Fan control.....	306
Fan kit.....	129
Firmware upgrade.....	199
Flex radius.....	140
Flex radius specifications.....	140
Functional ground.....	35, 141
G	
General tolerance.....	15
GOST-R.....	233
Gosudarstwenny standard.....	233
ground connection.....	35, 141
Grounding.....	35
Grounding concept.....	141
Guidelines.....	15
H	
HDA sound.....	41

Heat sink.....	60
HMI Drivers & Utilities DVD.....	278
I	
immunity to disturbances.....	141
implementation guide.....	145
Inserts.....	62
Installation	
with clamping blocks.....	134
Installing and replacing adapters.....	300
Installing and replacing bus units.....	299
Installing and replacing fan kits.....	293
Installing and replacing PCIec plug-in cards.....	302
Installing and replacing slide-in compact drives.....	289
Installing and replacing slide-in drives.....	290
Installing the side cover.....	303
Installing the slide-in compact adapter.....	291
Installing the UPS fuse kit.....	297
Installing the UPS module.....	295
Interfaces.....	35
Interrupt assignment.....	195
K	
Key Editor.....	230
L	
LED status indicators.....	43
loopback plug.....	144
Low battery.....	223, 225
Low voltage directive.....	232
M	
Main memory.....	61
Maintenance Controller Extended.....	306
Monitor/Panel interface.....	36
Mounting compatibility.....	313
Mounting orientation.....	136
MS-DOS.....	205
MTCX.....	306
MTCX upgrade.....	43
O	
Operating system	
Windows 7.....	208
Windows Embedded Standard 2009.....	210
Windows Embedded Standard 7.....	212
Windows XP Professional.....	206
P	
Panel overlay.....	311
PCI.....	250
PCIec.....	70
PCIec slot.....	45
plug-in card.....	70, 250
Power button.....	42

Power connectors.....	236
power failure.....	43, 225
POWERLINK	
Card number switch.....	76
Link LED.....	74
Speed LED.....	74
station number.....	76
Status/Error LED.....	74
System stop error codes.....	76
power supply.....	35, 141
PPC800 15"	
Cutout.....	51
Dimensions.....	51
Interfaces.....	48
Technical data.....	48
PPC800 19"	
Cutout.....	57
Dimensions.....	57
Interfaces.....	54
Technical data.....	54
PPC800 interfaces 15".....	48
PPC800 interfaces 19".....	54
Product abbreviations.....	313
Proper ESD	
handling.....	13
R	
Relative humidity.....	26
Replacing a CompactFlash card.....	288
Replacing a PCI SATA RAID hard disk.....	304
Replacing the battery.....	285
Reset button.....	42
Reversed battery polarity.....	220
RGB.....	36
RS232 cables.....	282
S	
Safety guidelines.....	13
Environmental conditions.....	14
Environmentally friendly disposal.....	15
Installation.....	14
Intended use.....	13
Operation.....	14
Policies and procedures.....	13
Protection against electrostatic discharge.....	13
Separation of materials.....	15
Transport and storage.....	14
Screen burn-in.....	154, 154
serial interface.....	37
Serial number sticker.....	34, 34
service life of the display.....	154
Slots.....	35
software versions.....	216
spacing.....	139
Standards and guidelines.....	232
Static wear leveling.....	256
Supply voltage block diagram.....	27

T	
Technical data - PPC800 15".....	48
Technical data - PPC800 19".....	54
Technology Guarding.....	215
Temperature monitoring.....	25, 306
Temperature monitoring - Fan control.....	306
Temperature sensor locations.....	25
temperature testing.....	142
Temperature testing instructions.....	142
Temperature testing procedure.....	142
Touch screen calibration.....	147
U	
Uninterruptible power supply.....	240
Upgrade	
BIOS.....	197
Firmware.....	199
Upgrade information.....	197
UPS.....	240
Changing the battery settings.....	220
Changing the shutdown time.....	223
Changing the UPS shutdown time.....	224
Configuring UPS system settings.....	222
Displaying UPS default values.....	219
Installing the UPS service.....	219
Low battery shutdown.....	225
Overcurrent shutdown.....	225
power failure.....	225
Saving battery settings.....	222
Standard shutdown.....	225
Updating battery settings.....	221
UPS configuration.....	219
UPS configuration.....	219
UPS fuse kit.....	297, 297
USB cables.....	281
USB flash drive.....	268
USB media drive.....	272
user serial ID.....	216
V	
Viewing angles.....	312
W	
WES2009.....	210
WES7.....	212
Windows 7.....	208
Windows Embedded Standard 2009.....	210
Windows Embedded Standard 7.....	212
Windows XP Professional.....	206