

Panel PC 800

User's Manual

Version: **1.31 (March 2015)**
Model no.: **MAPPC800-ENG**

All information contained in this manual is current as of its creation/publication. B&R reserves the right to change the contents of this manual without notice. The information contained herein is believed to be accurate as of the date of publication; however, Bernecker + Rainer Industrie-Elektronik Ges.m.b.H. makes no warranty, expressed or implied, with regard to the products or documentation contained within this manual. In addition, Bernecker + Rainer Industrie-Elektronik Ges.m.b.H. shall not be liable for any incidental or consequential damages in connection with or arising from the furnishing, performance or use of the product(s) in this documentation. Software names, hardware names and trademarks are registered by their respective companies.

Chapter 1: General information

Chapter 2: Technical data

Chapter 3: Installation

Chapter 4: Software

Chapter 5: Standards and certifications

Chapter 6: Accessories

Chapter 7: Maintenance and service

Appendix A

Chapter 1 General information.....	13
1 Manual history.....	13
2 Safety guidelines.....	16
2.1 Intended use.....	16
2.2 Protection against electrostatic discharge.....	16
2.2.1 Packaging.....	16
2.2.2 Guidelines for proper ESD handling.....	16
2.3 Policies and procedures.....	16
2.4 Transport and storage.....	17
2.5 Installation.....	17
2.6 Operation.....	17
2.6.1 Protection against touching electrical parts.....	17
2.6.2 Environmental conditions - Dust, moisture, corrosive gases.....	17
2.6.3 Viruses and dangerous programs.....	17
2.7 Environmentally friendly disposal.....	18
2.7.1 Separation of materials.....	18
3 Organization of safety notices.....	19
4 Guidelines.....	19
5 Overview.....	20
Chapter 2 Technical data.....	24
1 Introduction.....	24
1.1 Features.....	25
1.2 System components / Configuration.....	26
1.2.1 Configuration - Base system.....	26
1.2.2 Configuration - Optional components.....	27
2 Complete system.....	28
2.1 Temperature specifications.....	28
2.1.1 Maximum ambient temperature.....	29
2.1.2 Minimum ambient temperatures.....	31
2.1.3 Temperature monitoring.....	31
2.1.4 Temperature sensor locations.....	31
2.2 Humidity specifications.....	32
2.3 Power management.....	33
2.3.1 Supply voltage block diagram.....	33
2.3.2 Power calculation with 5PC820.1505-00.....	34
2.3.3 Power calculation with 5PC820.1906-00.....	35
2.4 Block diagrams.....	36
2.4.1 Bus unit 5AC803.BX01-00.....	36
2.4.2 Bus unit 5AC803.BX01-01.....	37
2.4.3 Bus unit 5AC803.BX02-00.....	38
2.4.4 Bus unit 5AC803.BX02-01.....	39
2.5 Serial number sticker.....	40
2.6 Device interfaces and slots.....	41
2.6.1 +24 VDC power supply.....	41
2.6.2 Monitor/Panel interface.....	42
2.6.3 COM1 serial interface.....	44
2.6.4 Ethernet 1 interface (ETH1).....	45
2.6.5	45
2.6.6	45
2.6.7 CompactFlash slot 1.....	47
2.6.8 CompactFlash slot 2.....	47
2.6.9 MIC, Line IN, Line OUT.....	48
2.6.10 Add-on UPS slot.....	48
2.6.11 Power button.....	49
2.6.12 Reset button.....	49
2.6.13 LED status indicators.....	50

2.6.14 CMOS profile switch.....	50
2.6.15 Battery.....	51
2.6.16 Slide-in compact slot.....	52
2.6.17 PCIe slot (Card slot).....	52
3 Individual components.....	53
3.1 System units.....	53
3.1.1 5PC820.1505-00.....	53
3.1.2 5PC820.1906-00.....	59
3.2 CPU boards 945GME.....	65
3.2.1 General information.....	65
3.2.2 Order data.....	65
3.2.3 5PC800.B945-0x - Technical data.....	66
3.2.4 5PC800.B945-1x - Technical data.....	66
3.3 Heat sink.....	68
3.3.1 Order data.....	68
3.3.2 Technical data.....	68
3.4 Main memory.....	69
3.4.1 General information.....	69
3.4.2 Order data.....	69
3.4.3 Technical data.....	69
3.5 Expansions.....	70
3.5.1 General information.....	70
3.5.2 Order data.....	70
3.5.3 Inserts.....	70
3.5.4 Technical data.....	70
3.5.5 5AC803.SX01-00 - Dimensions.....	71
3.5.6 5AC803.SX02-00 - Dimensions.....	72
3.5.7 Slot for bus units.....	72
3.5.8 Slide-in slot 1.....	74
3.6 Bus units.....	75
3.6.1 General information.....	75
3.6.2 Order data.....	75
3.6.3 Technical data.....	75
3.7 Adapters.....	77
3.7.1 5AC803.BC01-00.....	77
3.7.2 5AC803.BC02-00.....	77
3.8 PCIe plug-in cards.....	78
3.8.1 General information.....	78
3.8.2 Dimensions.....	78
3.8.3 5ACPCC.ETH0-00.....	79
3.8.4 5ACPCC.MPL0-00.....	81
3.9 Drives.....	85
3.9.1 5AC801.HDDI-00.....	85
3.9.2 5AC801.HDDI-02.....	87
3.9.3 5AC801.HDDI-03.....	89
3.9.4 5AC801.HDDI-04.....	91
3.9.5 5AC801.SSDI-00.....	93
3.9.6 5AC801.SSDI-01.....	97
3.9.7 5AC801.SSDI-02.....	99
3.9.8 5AC801.SSDI-03.....	101
3.9.9 5AC801.SSDI-04.....	104
3.9.10 5AC801.SSDI-05.....	107
3.9.11 5MMSSD.0060-00.....	109
3.9.12 5MMSSD.0060-01.....	111
3.9.13 5MMSSD.0128-01.....	114
3.9.14 5MMSSD.0180-00.....	117
3.9.15 5MMSSD.0256-00.....	119

3.9.16 5AC801.ADAS-00.....	121
3.9.17 5AC801.HDDS-00.....	122
3.9.18 5AC801.DVDS-00.....	124
3.9.19 5AC801.DVRS-00.....	126
3.9.20 5ACPCI.RAIC-03.....	129
3.9.21 5ACPCI.RAIC-04.....	132
3.9.22 5ACPCI.RAIC-05.....	134
3.9.23 5ACPCI.RAIC-06.....	137
3.9.24 5MMHDD.0250-00.....	140
3.9.25 5MMHDD.0500-00.....	142
3.10 Fan kit.....	144
3.10.1 5AC803.FA01-00.....	144
3.10.2 5AC803.FA02-00.....	145
3.10.3 5AC803.FA03-00.....	147
Chapter 3 Installation.....	149
1 Installation.....	149
1.1 Important installation information.....	149
1.2 Installation with clamping blocks.....	149
1.3 Mounting orientation.....	151
1.3.1 Mounting orientation 0° and +/- 45°.....	151
1.3.2 Mounting orientation with 5AC801.DVRS-00.....	152
1.3.3 Mounting orientation with 5AC801.DVDS-00.....	153
1.4 Spacing for air circulation.....	154
2 Cable connections.....	155
3 Grounding concept.....	156
4 General instructions for performing temperature testing.....	157
4.1 Procedure.....	157
4.2 Evaluating temperatures in Windows operating systems.....	157
4.2.1 Evaluating with the B&R Control Center.....	157
4.2.2 Evaluating with the BurnInTest tool from Passmark.....	158
4.3 Evaluating temperatures in operating systems other than Windows.....	160
4.4 Evaluating the measurement results.....	160
5 Connection examples.....	161
5.1 Selecting display units.....	161
5.2 One Automation Panel 900 system via onboard DVI.....	162
5.2.1 Base system requirements.....	162
5.2.2 Link modules.....	162
5.2.3 Cables.....	162
5.2.4 Possible Automation Panel devices, resolutions and segment lengths.....	163
5.2.5 BIOS settings.....	163
5.3 One Automation Panel 900 system via onboard SDL.....	164
5.3.1 Base system requirements.....	164
5.3.2 Link modules.....	164
5.3.3 Cables.....	164
5.3.4 Settings in BIOS.....	165
5.4 One Automation Panel 800 system via onboard SDL.....	166
5.4.1 Base system requirements.....	166
5.4.2 Cables.....	166
5.4.3 Settings in BIOS.....	167
5.5 One AP900 and one AP800 via onboard SDL.....	168
5.5.1 Base system requirements.....	168
5.5.2 Link modules.....	168
5.5.3 Cables.....	168
5.5.4 Settings in BIOS.....	169
5.6 Four Automation Panel 900 systems via onboard SDL.....	170
5.6.1 Base system requirements.....	170

5.6.2 Link modules.....	170
5.6.3 Cables.....	170
5.6.4 Settings in BIOS.....	171
6 Touch screen calibration.....	172
6.1 Windows XP Professional.....	172
6.2 Windows XP Embedded.....	172
6.3 Windows Embedded Standard 2009.....	172
6.4 Windows 7 Professional / Ultimate.....	172
6.5 Windows Embedded Standard 7 Embedded / Premium.....	172
6.6 Windows CE.....	172
6.7 Automation Runtime / Visual Components.....	172
7 Connecting peripheral USB devices.....	173
7.1 Locally on the PPC800.....	173
7.2 Remote connection to Automation Panel 900 via DVI.....	174
7.3 Remote connection to Automation Panel 800 / 900 via SDL.....	175
8 Configuring a SATA RAID set.....	176
8.1 Create RAID set.....	177
8.2 Create RAID set - Striped.....	177
8.3 Create RAID set - Mirrored.....	178
8.4 Delete RAID set.....	178
8.5 Rebuild mirrored set.....	179
8.6 Resolve conflicts.....	179
8.7 Low level format.....	180
9 Tips for extending the service life of the display.....	181
9.1 Backlight.....	181
9.1.1 How can the service life of the backlight be extended?.....	181
9.2 Screen burn-in.....	181
9.2.1 What causes screen burn-in?.....	181
9.2.2 How can screen burn-in be avoided?.....	181
10 Pixel errors.....	181
11 Known problems/issues.....	182
Chapter 4 Software.....	183
1 BIOS options.....	183
1.1 General information.....	183
1.2 BIOS Setup and boot procedure.....	183
1.2.1 BIOS Setup keys.....	185
1.3 Main.....	186
1.4 Advanced.....	187
1.4.1 ACPI configuration.....	188
1.4.2 PCI configuration.....	189
1.4.3 Graphics configuration.....	194
1.4.4 CPU configuration.....	196
1.4.5 Chipset configuration.....	197
1.4.6 I/O interface configuration.....	198
1.4.7 Clock configuration.....	198
1.4.8 IDE configuration.....	199
1.4.9 USB configuration.....	204
1.4.10 Keyboard/Mouse configuration.....	205
1.4.11 Remote access configuration.....	206
1.4.12 CPU board monitor.....	207
1.4.13 Baseboard/Panel features.....	208
1.5 Boot.....	212
1.6 Security.....	213
1.7 Hard disk security user password.....	214
1.8 Hard disk security master password.....	215
1.9 Power.....	215

1.10	Exit.....	217
1.11	BIOS default settings.....	218
1.11.1	Main.....	218
1.11.2	Advanced.....	218
1.11.3	Boot.....	222
1.11.4	Security.....	222
1.11.5	Power.....	222
1.12	BIOS error signals (beep codes).....	223
1.13	Allocation of resources.....	224
1.13.1	RAM address assignment.....	224
1.13.2	I/O address assignments.....	224
1.13.3	Interrupt assignments in PIC mode.....	224
1.13.4	Interrupt assignments in APIC mode.....	225
2	Upgrade information.....	226
2.1	BIOS upgrade.....	226
2.1.1	Important information.....	226
2.1.2	Procedure with MS-DOS.....	227
2.2	Firmware upgrade.....	229
2.2.1	Procedure.....	229
2.2.2	Possible upgrade problems and software dependencies (for V1.02).....	230
2.3	Creating an MS-DOS boot diskette in Windows XP.....	231
2.4	Creating a bootable USB flash drive for B&R upgrade files.....	233
2.4.1	Requirements.....	233
2.4.2	Procedure.....	233
2.4.3	How to access MS-DOS.....	233
2.5	Creating a bootable CompactFlash card for B&R upgrade files.....	234
2.5.1	Requirements.....	234
2.5.2	Procedure.....	234
2.5.3	How to access MS-DOS.....	234
3	Microsoft DOS.....	235
3.1	Order data.....	235
3.2	Known problems.....	235
4	Windows XP Professional.....	236
4.1	General information.....	236
4.2	Order data.....	236
4.3	Overview.....	236
4.4	Installation.....	237
4.4.1	Installation on a PCI SATA RAID controller - 5ACPCI.RAIC-03, 5ACPCI.RAIC-05, 5ACPCI.RAIC-06.....	237
4.5	Drivers.....	237
5	Windows 7.....	238
5.1	General information.....	238
5.2	Order data.....	238
5.3	Overview.....	238
5.4	Installation.....	239
5.4.1	Installation on a PCI SATA RAID controller - 5ACPCI.RAIC-03, 5ACPCI.RAIC-05, 5ACPCI.RAIC-06.....	240
5.5	Special considerations, limitations.....	240
5.6	Drivers.....	240
6	Windows XP Embedded.....	241
6.1	General information.....	241
6.2	Order data.....	241
6.3	Overview.....	241
6.4	Features with FP2007 (Feature Pack 2007).....	241
6.5	Installation.....	242
6.6	Drivers.....	242
6.6.1	Touch screen driver.....	242
7	Windows Embedded Standard 2009.....	243

7.1 General information.....	243
7.2 Order data.....	243
7.3 Overview.....	243
7.4 Features with WES2009 (Windows Embedded Standard 2009).....	243
7.5 Installation.....	244
7.6 Drivers.....	244
7.6.1 Touch screen driver.....	244
7.7 Supported display resolutions.....	244
8 Windows Embedded Standard 7.....	245
8.1 General information.....	245
8.2 Order data.....	245
8.3 Overview.....	246
8.4 Features with WES7 (Windows Embedded Standard 7).....	246
8.5 Installation.....	246
8.6 Drivers.....	247
8.6.1 Touch screen driver.....	247
8.7 Supported display resolutions.....	247
9 Windows CE.....	248
9.1 General information.....	248
9.2 Order data.....	248
9.3 Overview.....	248
9.4 Windows CE 6.0 features.....	248
9.5 Requirements.....	249
9.6 Installation.....	249
9.7 B&R Embedded OS Installer.....	249
10 Automation Runtime.....	250
10.1 General information.....	250
10.2 Order data.....	250
10.3 Automation Runtime Windows (ARwin).....	250
10.4 Automation Runtime Embedded (ARemb).....	251
10.5 Technology Guarding.....	251
11 B&R Automation Device Interface (ADI) - Control Center.....	252
11.1 Functions.....	252
11.2 Installation.....	253
11.3 SDL Equalizer settings.....	254
11.4 UPS configuration.....	255
11.4.1 Installing the UPS service for the B&R add-on UPS.....	255
11.4.2 Displaying UPS default values.....	255
11.4.3 Changing UPS battery settings.....	256
11.4.4 Updating UPS battery settings.....	257
11.4.5 Saving UPS battery settings.....	258
11.4.6 Configuring UPS system settings.....	258
11.4.7 Changing additional UPS settings.....	259
11.4.8 Procedure following power failure.....	261
12 B&R Automation Device Interface (ADI) Development Kit.....	262
13 B&R Automation Device Interface (ADI) .NET SDK.....	264
14 B&R Key Editor.....	266
Chapter 5 Standards and certifications.....	268
1 Standards and guidelines.....	268
1.1 CE mark.....	268
1.2 EMC directive.....	268
1.3 Low voltage directive.....	268
2 Certifications.....	269
2.1 UL certification.....	269
2.2 GOST-R.....	269

Chapter 6 Accessories.....	270
1 Replacement CMOS batteries.....	270
1.1 0AC201.91 / 4A0006.00-000.....	270
1.1.1 General information.....	270
1.1.2 Order data.....	270
1.1.3 Technical data.....	270
2 Power connectors.....	272
2.1 0TB103.9x.....	272
2.1.1 General information.....	272
2.1.2 Order data.....	272
2.1.3 Technical data.....	272
3 DVI/Monitor adapter.....	273
3.1 5AC900.1000-00.....	273
3.2 General information.....	273
3.3 Order data.....	273
4 USB interface cover.....	274
4.1 5AC900.1201-00.....	274
4.1.1 General information.....	274
4.1.2 Order data.....	274
4.2 5AC900.1201-01.....	274
4.2.1 General information.....	274
4.2.2 Order data.....	274
5 Clamping blocks.....	275
5.1 5AC900.BLOC-00.....	275
5.1.1 General information.....	275
5.1.2 Order data.....	275
6 Uninterruptible power supply.....	276
6.1 Features.....	276
6.2 Requirements.....	276
6.3 5AC600.UPSI-00.....	277
6.3.1 General information.....	277
6.3.2 Order data.....	277
6.3.3 Technical data.....	277
6.3.4 Installation.....	277
6.4 5AC600.UPSB-00.....	279
6.4.1 General information.....	279
6.4.2 Order data.....	279
6.4.3 Technical data.....	279
6.4.4 Service life.....	280
6.4.5 Deep discharge cycles.....	280
6.4.6 Dimensions.....	281
6.4.7 Drilling template.....	281
6.4.8 Installation instructions.....	281
6.5 5CAUPS.00xx-00.....	282
6.5.1 General information.....	282
6.5.2 Order data.....	282
6.5.3 Technical data.....	282
6.6 5AC600.UPSF-00.....	283
6.6.1 General information.....	283
6.6.2 Order data.....	283
6.7 5AC600.UPSF-01.....	283
6.7.1 General information.....	283
6.7.2 Order data.....	283
7 External UPS.....	284
7.1 General information.....	284
7.2 Order data.....	284
8 PCI plug-in cards.....	286

8.1 5ACPCI.ETH1-01.....	286
8.1.1 General information.....	286
8.1.2 Order data.....	286
8.1.3 Technical data.....	286
8.1.4 Driver support.....	287
8.1.5 Dimensions.....	288
8.2 5ACPCI.ETH3-01.....	289
8.2.1 General information.....	289
8.2.2 Order data.....	289
8.2.3 Technical data.....	289
8.2.4 Driver support.....	290
8.2.5 Dimensions.....	291
9 CompactFlash cards.....	292
9.1 General information.....	292
9.2 General information.....	292
9.2.1 Flash technology.....	292
9.2.2 Wear leveling.....	292
9.2.3 ECC error correction.....	292
9.2.4 S.M.A.R.T. support.....	292
9.2.5 Maximum reliability.....	293
9.3 5CFCRD.xxxx-06.....	294
9.3.1 General information.....	294
9.3.2 Order data.....	294
9.3.3 Technical data.....	295
9.3.4 Temperature/Humidity diagram.....	298
9.3.5 Dimensions.....	298
9.3.6 Benchmark.....	299
9.4 5CFCRD.xxxx-04.....	300
9.4.1 General information.....	300
9.4.2 Order data.....	300
9.4.3 Technical data.....	300
9.4.4 Temperature/Humidity diagram.....	302
9.4.5 Dimensions.....	302
9.4.6 Benchmark.....	303
9.5 5CFCRD.xxxx-03.....	304
9.5.1 General information.....	304
9.5.2 Order data.....	304
9.5.3 Technical data.....	304
9.5.4 Temperature/Humidity diagram.....	306
9.5.5 Dimensions.....	306
9.6 Known problems/issues.....	307
10 USB flash drives.....	308
10.1 5MMUSB.2048-00.....	308
10.1.1 General information.....	308
10.1.2 Order data.....	308
10.1.3 Technical data.....	308
10.1.4 Temperature/Humidity diagram.....	309
10.2 5MMUSB.xxxx-01.....	310
10.2.1 General information.....	310
10.2.2 Order data.....	310
10.2.3 Technical data.....	310
10.2.4 Temperature/Humidity diagram.....	311
11 USB media drive.....	312
11.1 5MD900.USB2-02.....	312
11.1.1 General information.....	312
11.1.2 Order data.....	312
11.1.3 Interfaces.....	312

11.1.4	Technical data.....	312
11.1.5	Dimensions.....	314
11.1.6	Dimensions with front cover.....	314
11.1.7	Cutout installation.....	315
11.1.8	Contents of delivery.....	315
11.1.9	Installation.....	315
11.2	5A5003.03.....	316
11.2.1	General information.....	316
11.2.2	Order data.....	316
11.2.3	Technical data.....	316
11.2.4	Dimensions.....	316
11.2.5	Contents of delivery.....	316
11.2.6	Installation.....	317
12	HMI Drivers & Utilities DVD.....	318
12.1	5SWHMI.0000-00.....	318
12.1.1	General information.....	318
12.1.2	Order data.....	318
12.1.3	Contents (V2.20).....	318
13	Cables.....	321
13.1	DVI cables.....	321
13.1.1	5CADVI.0xxx-00.....	321
13.2	SDL cables.....	324
13.2.1	5CASDL.0xxx-00.....	324
13.3	SDL cables with 45° male connector.....	327
13.3.1	5CASDL.0xxx-01.....	327
13.4	SDL flex cables.....	330
13.4.1	5CASDL.0xxx-03.....	330
13.5	SDL flex cables with extender.....	333
13.5.1	5CASDL.0xx0-13.....	333
13.6	USB cables.....	337
13.6.1	5CAUSB.00xx-00.....	337
13.7	RS232 cables.....	338
13.7.1	9A0014.xx.....	338
13.8	Internal supply cable.....	340
13.8.1	5CAMSC.0001-00.....	340
Chapter 7 Maintenance and service.....		341
1	Replacing the battery.....	341
1.1	Evaluating the battery status.....	341
1.2	Procedure.....	341
2	Cleaning.....	343
3	Replacing a CompactFlash card.....	344
4	Installing and replacing slide-in compact drives.....	345
4.1	Procedure.....	345
5	Installing and replacing slide-in drives.....	346
5.1	Procedure.....	346
6	Installing the slide-in compact adapter.....	347
6.1	Procedure.....	347
7	Installing and replacing fan kits.....	349
7.1	Procedure.....	349
8	Installing the UPS module.....	351
8.1	Installation guidelines.....	351
9	Installing the UPS fuse kit on the battery unit.....	353
9.1	Procedure.....	353
10	Installing and replacing bus units.....	355
10.1	Procedure.....	355
11	Installing and replacing adapters.....	356

11.1 Procedure for the 5AC803.BC01-00 adapter.....	356
11.2 Procedure for the 5AC803.BC02-00 adapter.....	357
12 Installing and replacing PCIec plug-in cards.....	358
12.1 Procedure.....	358
13 Installing the side cover.....	359
13.1 PPC800 without expansion.....	359
13.2 PPC800 with an expansion.....	359
14 Replacing a PCI SATA RAID hard disk in a RAID 1 set.....	360
14.1 Procedure.....	360
Appendix A	362
1 Maintenance Controller Extended (MTCX).....	362
1.1 Temperature monitoring - Fan control.....	362
2 Connecting an external device to the mainboard.....	364
3 5-wire AMT touch screen.....	365
3.1 Technical data.....	365
3.2 Temperature/Humidity diagram.....	365
3.3 Cleaning.....	365
4 Panel overlay.....	367
5 Viewing angles.....	368
6 Mounting compatibility.....	369
6.1 Compatibility overview.....	369
6.2 Compatibility details.....	370
6.2.1 Example.....	370
6.2.2 5.7" devices.....	370
6.2.3 10.4" devices.....	372
6.2.4 12.1" devices.....	373
6.2.5 15" devices.....	374
6.2.6 17" devices.....	375
6.2.7 19" devices.....	375
6.2.8 21.3" devices.....	376
7 Glossary.....	377

Chapter 1 • General information

1 Manual history

Version	Date	Change
0.10 Preliminary	10-Nov-09	<ul style="list-style-type: none"> • First version
1.00	10-May-10	<ul style="list-style-type: none"> • Corrected dimension diagrams for PPC800 system units. • Updated section "Temperature sensor locations" on page 31. • Updated section 11 "Known problems/issues" on page 182 with additional information. • Updated section 2.2 "Firmware upgrade" on page 229. • Updated section 2.1 "Temperature specifications" on page 28. • Updated section 2.2 "Humidity specifications" on page 32. • Updated section 2.3 "Power management" on page 33. • Updated section 2.4 "Block diagrams" on page 36. • Updated section 10 "Automation Runtime" on page 250. • Updated section 2.5 "Serial number sticker" on page 40. • Updated section 3.10 "Fan kit" on page 144. • Updated section 1.1 "Temperature monitoring - Fan control" on page 362. • Updated section 11 "B&R Automation Device Interface (ADI) - Control Center" on page 252. • Updated section 6 "Touch screen calibration" on page 172. • Updated section 7 "Connecting peripheral USB devices" on page 173. • Updated section 1.4 "Spacing for air circulation" on page 154. • Updated section 1.3 "Mounting orientation" on page 151. • Updated section 7 "Windows Embedded Standard 2009" on page 243. • Updated section 5 "Connection examples" on page 161. • 5 "Standards and certifications" on page 268 updated. • Added 1A4300.LZ1U dongle, see section "B&R Automation Runtime USB dongle". • Updated technical data for system units 5PC820.1505-00 and 5PC820.1906-00. • Revised technical data in sections 13.2 "SDL cables" on page 324, 13.3 "SDL cables with 45° male connector" on page 327, 13.4 "SDL flex cables" on page 330 and 13.5 "SDL flex cables with extender" on page 333. • Updated warning regarding replacement of batteries in section 1.1 "0AC201.91 / 4A0006.00-000" on page 270 and 1 "Replacing the battery" on page 341. • Updated figures for expansions, options and bus units. • Updated CPU boards 5PC800.B945-05, 5PC800.B945-10, 5PC800.B945-11, 5PC800.B945-12, 5PC800.B945-13 and 5PC800.B945-14. • Modified description of +24 VDC supply voltage on page 41. Updated USB interface covers (with anti-loss strap) 5AC900.1200-01, 5AC900.1200-02 and 5AC900.1200-03 in 6 "Accessories". • Updated PCI SATA RAID controller 5ACPCI.RAIC-03 and replacement PCI SATA RAID HDD 5ACPCI.RAIC-04. • Updated section 8 "Configuring a SATA RAID set" on page 176.
1.01	04-Feb-11	<ul style="list-style-type: none"> • Changed name "AR010" to "ARwin". • Changed section name "B&R Automation Studio 3.0 USB dongle" to "B&R Automation Runtime USB dongle". • Updated model numbers 9A0003.02U, 1A4600.10, 1A4600.10-2, 1A4600.10-3 and 1A4600.10-4. • Removed model number 1A4300.LZ1U. • Updated B&R USB flash drive 5MMUSB.2048-01, see USB flash drives. • "5AC801.HDDI-03" on page 89 updated. • "5ACPCI.RAIC-05" on page 134 updated. • "5MMHDD.0250-00" on page 140 updated. • Revised "Configuration - Optional components" on page 27. • Added 5AC801.HDDI-03, 5ACPCI.RAIC-05 and 5MMHDD.0250-00 to the figures for ambient temperature and table "Overview of humidity specifications for individual components" on page 32.
1.02	20-May-11	<ul style="list-style-type: none"> • Corrected model numbers in "1-slot bus units" on page 75, "2-slot bus units" on page 75 and Figure 31 "Options" on page 88. • Updated sections "Windows 7" on page 238, "Windows Embedded Standard 7" on page 245, "Windows CE" on page 248, "B&R Automation Device Interface (ADI) .NET SDK" on page 264. • Updated SRAM information for "5ACPCC.MPL0-00" on page 81. • Updated BIOS version (1.15 -> 1.17). • Revised sections "Automation Runtime" on page 250, "B&R Automation Device Interface (ADI) - Control Center" on page 252, "B&R Automation Device Interface (ADI) Development Kit" on page 262, "B&R Key Editor" on page 266 and "HMI Drivers & Utilities DVD" on page 318. • Corrected service life of the battery. • Corrected chipset information for "CPU boards 945GME" on page 65. • Revised "Configuration - Optional components" on page 27. • Updated information about "Pixel errors" on page 181.

Table 1: Manual history

Version	Date	Change
1.03	25-Jul-11	<ul style="list-style-type: none"> Updated USB5 in heading ("" on page 45). Corrected short description of 5AC801.HDDI-02 and 5AC801.HDDI-03 in Table 31 "Slide-in compact slot" on page 52. Updated table entry "Typical charge duration when battery low" in table Table 220 "5AC600.UPSB-00, 5AC600.UPSB-00 - Technical data" on page 279. Revised sections "B&R Automation Device Interface (ADI) - Control Center" on page 252, "B&R Automation Device Interface (ADI) Development Kit" on page 262 and "B&R Automation Device Interface (ADI) .NET SDK" on page 264. Revised section "Windows XP Professional" on page 236. Updated "Information:" regarding installation in section "Windows 7" on page 238. Corrected information on "Windows XP mode" in section "Features with WES7 (Windows Embedded Standard 7)" on page 246. Revised reference to external UPS 24 VDC in section "Uninterruptible power supply" on page 276. Updated sections "Installing the side cover" on page 359, "5CAMSC.0001-00" on page 340 and "Connecting an external device to the mainboard" on page 364. "Leistungskalkulation PPC800 15"" on page and "Leistungskalkulation PPC800 19"" on page revised. Updated section "Replacing a CompactFlash card" on page 344.
1.04	29-Sep-11	<ul style="list-style-type: none"> Corrected temperatures during operation without fans for CPU boards 5PC800.B945-10 and 5PC800.B945-11 to 35°C and for CPU boards 5PC800.B945-12 and 5PC800.B945-13 to 45°C, see "Ambient temperature for CPU boards 5PC800.B945-1x and 5PC800.B945-05" on page 30.
1.05	21-Oct-11	<ul style="list-style-type: none"> Revised section "Card number switch" on page 84 for POWERLINK plug-in card 5ACPC.C.MPL0-00.
1.10	24-Apr-12	<ul style="list-style-type: none"> Revised section 9 "CompactFlash cards" on page 292. Moved section "B&R Automation Device Interface (ADI) Development Kit" to 4 "Software". Moved section "Temperature sensor locations" to 2 "Technical data". Updated figure indicating how to change the battery (see Figure 192 "Removing the battery" on page 342). Updated section "Connection examples" on page 161. Updated sections in 7 "Maintenance and service": "Installing the UPS module" on page 351, "Installing and replacing fan kits" on page 349, "5AC900.BLOC-00" on page 275, "Installing and replacing adapters" on page 356, "Installing and replacing bus units" on page 355, "Procedure" on page 358, "Installing and replacing slide-in drives" on page 346, 347, "Procedure" on page 345, "Replacing a PCI SATA RAID hard disk in a RAID 1 set" on page 360. Updated chapter "Standards and certifications" on page 268. Updated section "Cleaning" on page 343. Updated section 3 "5-wire AMT touch screen" on page 365 in A "Appendix A". Added new CompactFlash cards 5CF.CRD.xxxx-06 in 6 "Accessories". Discontinued CompactFlash cards 5CF.CRD.xxxx-04. Updated BIOS version (1.13 -> 1.18). Updated information about the Automation Device Interface and B&R Key Editor. Revised entire manual according to current formatting standards.
1.11	13-Jul-12	<ul style="list-style-type: none"> Updated section "Cable lengths and resolutions for SDL transmission" on page 43. "Option" renamed to "Adapter".
1.12	06-Sep-12	<ul style="list-style-type: none"> Corrected Table 10 "Power calculation for 19" PPC800" on page 35 (Backlight display 15" changed to Backlight display 19").
1.15	04-Feb-13	<ul style="list-style-type: none"> Updated section "General instructions for performing temperature testing" on page 157. Updated Windows 7 Service Pack 1 (see "Windows 7" on page 238). Updated Windows Embedded Standard 7 Service Pack 1 (see "Windows Embedded Standard 7" on page 245). Added SSD drives "5AC801.SSDI-01" on page 97 and "5AC801.SSDI-02" on page 99. Updated "B&R Automation Device Interface (ADI) - Control Center" on page 252. Updated "B&R Automation Device Interface (ADI) Development Kit" on page 262 to version 3.40. Updated "B&R Automation Device Interface (ADI) .NET SDK" on page 264 to version 1.80. Updated "B&R Key Editor" on page 266 to version 3.30. Modified "Configuration - Optional components" on page 27. Updated technical data for CPU boards, see "CPU boards 945GME" on page 65. CompactFlash card 5CF.CRD.032G-06 updated, see "5CF.CRD.xxxx-06" on page 294. Updated USB media drive, see "5MD900.USB2-02" on page 312.
1.16	13-Mar-13	<ul style="list-style-type: none"> Updated the following drives: "5AC801.HDDI-04" on page 91, "5ACPCI.RAIC-06" on page 137"5MMHDD.0500-00" on page 142. Revised general information for drives "5ACPCI.RAIC-05" on page 134 and "5MMHDD.0250-00" on page 140. Updated order data for system units "5PC820.1505-00" on page 53 and "5PC820.1906-00" on page 59.
1.17	18-Mar-13	<ul style="list-style-type: none"> Revised section "Windows Embedded Standard 7" on page 245. Added new CompactFlash cards (8 GB) in 6 "Accessories".
1.18	15-May-13	<ul style="list-style-type: none"> Updated add-on fuse kit "5AC600.UPSF-00" on page 283 and replacement fuses "5AC600.UPSF-01" on page 283 for the UPS battery unit. Added drive "5AC801.SSDI-03" on page 101. Updated replacement SSDs "5MMSSD.0060-00" on page 109, "5MMSSD.0060-01" on page 111 and "5MMSSD.0180-00" on page 117. Updated technical data for HDD "5AC801.HDDI-04" on page 91. Modified the ambient temperature tables in section "Temperature specifications" on page 28

Table 1: Manual history

Version	Date	Change
1.20	20-Aug-13	<ul style="list-style-type: none"> Updated B&R USB flash drive 5MMUSB.4096-01, see "USB flash drives" on page 308. Updated slide-in compact drive "5AC801.SSDI-04" on page 104. Updated replacement SSD "5MMSSD.0128-01" on page 114. Updated tightening torque of locating screws in section "Cables" on page 321. Updated sections "B&R Automation Device Interface (ADI) Development Kit" on page 262 and "B&R Automation Device Interface (ADI) .NET SDK" on page 264.
1.25	17-Feb-14	<ul style="list-style-type: none"> Revised description "Installing the UPS module" on page 351. Updated slide-in compact drive "5AC801.SSDI-05" on page 107. Updated replacement SSD "5MMSSD.0256-00" on page 119. Updated technical data and temperature / relative humidity diagrams for the "5AC801.SSDI-04" on page 104 and "5MMSSD.0128-01" on page 114 SSDs. Added information about the discontinuation of support for the "Windows XP Professional" on page 236 operating system. Updated "B&R Automation Device Interface (ADI) - Control Center" on page 252. Updated "B&R Automation Device Interface (ADI) Development Kit" on page 262. Updated "B&R Automation Device Interface (ADI) .NET SDK" on page 264. Updated "B&R Key Editor" on page 266 to version 3.40. Updated "Cable lengths" and "Resolutions" sections, see "Cable lengths and resolutions for SDL transmission" on page 43 and "Cable lengths and resolutions for DVI transmission" on page 43. Updated GOST-R certification information in the technical data. Updated section "GOST-R" on page 269. Updated section "Connection examples" on page 161. Updated section "Known problems/issues" on page 182.
1.30	2014-12-02	<ul style="list-style-type: none"> Corrected the technical data for ambient temperature and humidity for the following drives: "5AC801.SSDI-03" on page 101, "5AC801.SSDI-04" on page 104, "5AC801.SSDI-05" on page 107, "5MMSSD.0060-01" on page 111, "5MMSSD.0128-01" on page 114, "5MMSSD.0256-00" on page 119. Updated the new revisions of 5CFCRD.xxxx-06 CompactFlash cards, see "5CFCRD.xxxx-06" on page 294. Updated technical data for system units "5PC820.1505-00" on page 53 and "5PC820.1906-00" on page 59.
1.31	2015-03-20	<ul style="list-style-type: none"> Updated section "Maximum ambient temperature" on page 29. Revised pinout of monitor/panel interface, see "Monitor/Panel interface" on page 42. Updated order data for system units "5PC820.1505-00" on page 53 "5PC820.1906-00" on page 59. Updated technical data for system units "5PC820.1505-00" on page 53 and "5PC820.1906-00" on page 59. Updated section "Automation Runtime" on page 250.

Table 1: Manual history

2 Safety guidelines

2.1 Intended use

Programmable logic controllers (PLCs), operating/monitoring devices (industrial PCs, Power Panels, Mobile Panels, etc.) and B&R uninterruptible power supplies have been designed, developed and manufactured for conventional use in industrial environments. They were not designed, developed and manufactured for any use involving serious risks or hazards that could lead to death, injury, serious physical damage or loss of any kind without the implementation of exceptionally stringent safety precautions. In particular, such risks and hazards include the use of these devices to monitor nuclear reactions in nuclear power plants, their use in flight control or flight safety systems as well as in the control of mass transportation systems, medical life support systems or weapons systems.

2.2 Protection against electrostatic discharge

Electrical components that can be damaged by electrostatic discharge (ESD) must be handled accordingly.

2.2.1 Packaging

- **Electrical components with a housing**
...do not require special ESD packaging but must be handled properly (see "Electrical components with a housing").
- **Electrical components without a housing**
...are protected by ESD-suitable packaging.

2.2.2 Guidelines for proper ESD handling

Electrical components with a housing

- Do not touch the connector contacts on connected cables.
- Do not touch the contact tips on circuit boards.

Electrical components without a housing

The following applies in addition to the points listed under "Electrical components with a housing":

- Any persons handling electrical components or devices with installed electrical components must be grounded.
- Components are only permitted to be touched on their narrow sides or front plate.
- Components should always be stored in a suitable medium (ESD packaging, conductive foam, etc.). Metallic surfaces are not suitable storage surfaces!
- Components should not be subjected to electrostatic discharge (e.g. through the use of charged plastics).
- Ensure a minimum distance of 10 cm from monitors and TV sets.
- Measuring instruments and equipment must be grounded.
- Probes on potential-free measuring instruments must be discharged on sufficiently grounded surfaces before taking measurements.

Individual components

- ESD protective measures for individual components are thoroughly integrated at B&R (conductive floors, footwear, arm bands, etc.).
- These increased ESD protective measures for individual components are not necessary for customers handling B&R products.

2.3 Policies and procedures

Electronic devices are never completely failsafe. If the programmable control system, operating/monitoring device or uninterruptible power supply fails, the user is responsible for ensuring that other connected devices, e.g. motors, are brought to a secure state.

When using programmable logic controllers or operating/monitoring devices as control systems together with a soft PLC (e.g. B&R Automation Runtime or comparable product) or slot PLC (e.g. B&R LS251 or comparable product), safety precautions relevant to industrial control systems (e.g. the provision of safety devices such as emergency stop circuits, etc.) must be observed in accordance with applicable national and international regulations. The same applies for all other devices connected to the system, such as drives.

All tasks such as the installation, commissioning and servicing of devices are only permitted to be carried out by qualified personnel. Qualified personnel are those familiar with the transport, mounting, installation, commissioning and operation of devices who also have the appropriate qualifications (e.g. IEC 60364). National accident prevention regulations must be observed.

The safety notices, connection descriptions (type plate and documentation) and limit values listed in the technical data are to be read carefully before installation and commissioning and must be observed.

2.4 Transport and storage

During transport and storage, devices must be protected against undue stress (mechanical loads, temperature, moisture, corrosive atmospheres, etc.).

2.5 Installation

- These devices are not ready for use upon delivery and must be installed and wired according to the specifications in this documentation in order for the EMC limit values to apply.
- Installation must be performed according to this documentation using suitable equipment and tools.
- Devices are only permitted to be installed by qualified personnel without voltage applied. Before installation, voltage to the control cabinet must be switched off and prevented from being switched on again.
- General safety guidelines and national accident prevention regulations must be observed.
- Electrical installation must be carried out in accordance with applicable guidelines (e.g. line cross sections, fuses, protective ground connections).

2.6 Operation

2.6.1 Protection against touching electrical parts

To operate programmable logic controllers, operating and monitoring devices, and uninterruptible power supplies, certain components must carry dangerous voltage levels. Touching one of these parts can result in a life-threatening electric shock. This could lead to death, severe injury or damage to equipment.

Before turning on the programmable logic controller, operating/monitoring devices or uninterruptible power supply, the housing must be properly grounded (PE rail). Ground connections must be established even when testing or operating operating/monitoring devices or the uninterruptible power supply for a short time!

Before turning the device on, all parts that carry voltage must be securely covered. During operation, all covers must remain closed.

2.6.2 Environmental conditions - Dust, moisture, corrosive gases

The use of operating/monitoring devices (e.g. industrial PCs, Power Panels, Mobile Panels, etc.) and uninterruptible power supplies in very dusty environments should be avoided. Dust collection on the devices can affect functionality and may prevent sufficient cooling, especially in systems with active cooling systems (fans).

The presence of corrosive gases can also lead to malfunctions. When combined with high temperature and humidity, corrosive gases – e.g. with sulfur, nitrogen and chlorine components – can induce chemical reactions that can damage electronic components very quickly. Signs of the presence of corrosive gases are blackened copper surfaces and cable ends on existing equipment.

For operation in dusty or moist conditions, correctly installed (e.g. cutout installations) operating/monitoring devices like the Automation Panel or Power Panel are protected on the front. The back of all devices must be protected from dust and moisture and cleaned at suitable intervals.

2.6.3 Viruses and dangerous programs

This system is subject to potential risk each time data is exchanged or software is installed from a data medium (e.g. diskette, CD-ROM, USB flash drive, etc.), a network connection or the Internet. The user is responsible for assessing these dangers, implementing preventive measures such as virus protection programs, firewalls, etc. and making sure that software is only obtained from trusted sources.

2.7 Environmentally friendly disposal

All B&R programmable controllers, operating/monitoring devices and uninterruptible power supplies are designed to inflict as little harm as possible on the environment.

2.7.1 Separation of materials

It is necessary to separate different materials so the device can undergo an environmentally friendly recycling process.

Component	Disposal
Programmable logic controllers Operating/Monitoring devices Uninterruptible power supply Batteries and rechargeable batteries Cables	Electronics recycling
Cardboard box / Paper packaging	Cardboard box / Paper recycling
Plastic packaging	Plastic recycling

Table 2: Environmentally friendly separation of materials

Disposal must comply with applicable legal regulations.

3 Organization of safety notices

Safety notices in this manual are organized as follows:

Safety notice	Description
Danger!	Disregarding these safety guidelines and notices can be life-threatening.
Warning!	Disregarding these safety guidelines and notices can result in severe injury or substantial damage to equipment.
Caution!	Disregarding these safety guidelines and notices can result in injury or damage to equipment.
Information:	This information is important for preventing errors.

Table 3: Description of the safety notices used in this documentation

4 Guidelines

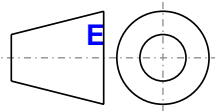

European dimension standards apply to all dimension diagrams in this document.

All dimensions are specified in mm.

Range of nominal sizes	General tolerance according to DIN ISO 2768 (medium)
Up to 6 mm	±0.1 mm
For 6 to 30 mm	±0.2 mm
For 30 to 120 mm	±0.3 mm
For 120 to 400 mm	±0.5 mm
For 400 to 1000 mm	±0.8 mm

Table 4: Range of nominal sizes

5 Overview

Product ID	Short description	on page
	24 VDC UPS modules	
9A0100.11	UPS 24 VDC, 24 VDC input, 24 VDC output, serial interface	284
	Accessories	
5AC900.1201-00	USB interface cover M20 IP65 flat	274
5AC900.1201-01	USB interface cover M20 IP65 curved	274
5AC900.BLOC-00	Terminal block with brackets, 10 pcs.; replacement part	275
5ACPCI.ETH1-01	PCI Ethernet card 1x 10/100	286
5ACPCI.ETH3-01	PCI Ethernet card 3x 10/100	289
5CAMSC.0001-00	Internal supply cable	340
	Adapter	
5AC803.BC01-00	1 compact PCI Express PPC800 adapter	77
5AC803.BC02-00	1 compact slide-in PPC800 adapter	77
	Automation Runtime	
0TG1000.01	Technology Guard	250
1TG4600.10-5	Automation Runtime Windows, TG license	250
1TG4601.06-5	Automation Runtime Embedded, TG license	250
	Batteries	
0AC201.91	Lithium batteries 4 pcs., 3 V / 950 mAh button cell We hereby state that the lithium cells contained in this shipment qualify as "partly regulated". Handle with care. If the package is damaged, inspect the cells, repack intact cells and protect the cells against short circuit. For emergency information, call RENATA SA at +41 61 319 28 27.	270
4A0006.00-000	Lithium battery, 3 V / 950 mAh, button cell	270
	Battery units	
9A0100.12	UPS battery unit type A, 24 V, 7 Ah, incl. battery cage	284
9A0100.14	UPS battery unit type B, 24 V, 2.2 Ah, incl. battery cage	284
9A0100.16	UPS battery unit type C, 24 V, 4.5 Ah, incl. battery cage	284
	Bus units	
5AC803.BX01-00	PPC800 bus; 1 PCI, 1 slide-in slot	75
5AC803.BX01-01	PPC800 bus; 1 PCI Express, 1 slide-in slot	75
5AC803.BX02-00	PPC800 bus; 2 PCI, 1 slide-in slot	75
5AC803.BX02-01	PPC800 bus; 1 PCI, 1 PCI Express, 1 slide-in slot	75
	CPU boards	
5PC800.B945-00	Intel Core Duo L2400 CPU board, 1.66 GHz, dual core, 667 MHz FSB, 2 MB L2 cache; 945GME chipset; 2 slots for SO-DIMM DDR2 modules (max. total of 3 GB), Realtek RTL8111B Ethernet controller	65
5PC800.B945-01	Intel Core2 Duo L7400 CPU board, 1.5 GHz, dual core, 667 MHz FSB, 4 MB L2 cache; 945GME chipset; 2 slots for SO-DIMM DDR2 modules (max. total of 3 GB), Realtek RTL8111B Ethernet controller	65
5PC800.B945-02	Intel Core2 Duo U7500 CPU board, 1.06 GHz, dual core, 533 MHz FSB, 2 MB L2 cache; 945GME chipset; 2 slots for SO-DIMM DDR2 modules (max. total of 3 GB), Realtek RTL8111B Ethernet controller	65
5PC800.B945-03	Intel Celeron M 423 CPU board, 1.06 GHz, single core, 533 MHz FSB, 1 MB L2 cache; 945GME chipset; 2 slots for SO-DIMM DDR2 modules (max. total of 3 GB), Realtek RTL8111B Ethernet controller	65
5PC800.B945-04	Intel Core2 Duo T7400 CPU board, 2.16 GHz, dual core, 667 MHz FSB, 4 MB L2 cache; 945GME chipset; 2 slots for SO-DIMM DDR2 modules (max. total of 3 GB), Realtek RTL8111B Ethernet controller	65
5PC800.B945-05	Intel Atom N270 CPU board, 1.6 GHz, single core, 533 MHz FSB, 512 kB L2 cache; 945GME chipset; 2 slots for SO-DIMM DDR2 modules (max. total of 3 GB), Realtek RTL8111C Ethernet controller	65
5PC800.B945-10	Intel Core Duo L2400 CPU board, 1.66 GHz, dual core, 667 MHz FSB, 2 MB L2 cache; 945GME chipset; 2 slots for SO-DIMM DDR2 modules (max. total of 3 GB), Realtek RTL8111C Ethernet controller	65
5PC800.B945-11	Intel Core2 Duo L7400 CPU board, 1.5 GHz, dual core, 667 MHz FSB, 4 MB L2 cache; 945GME chipset; 2 slots for SO-DIMM DDR2 modules (max. total of 3 GB), Realtek RTL8111C Ethernet controller	65
5PC800.B945-12	Intel Core2 Duo U7500 CPU board, 1.06 GHz, dual core, 533 MHz FSB, 2 MB L2 cache; 945GME chipset; 2 slots for SO-DIMM DDR2 modules (max. total of 3 GB), Realtek RTL8111C Ethernet controller	65
5PC800.B945-13	Intel Celeron M 423 CPU board, 1.06 GHz, single core, 533 MHz FSB, 1 MB L2 cache; 945GME chipset; 2 slots for SO-DIMM DDR2 modules (max. total of 3 GB), Realtek RTL8111C Ethernet controller	65
5PC800.B945-14	Intel Core2 Duo T7400 CPU board, 2.16 GHz, dual core, 667 MHz FSB, 4 MB L2 cache; 945GME chipset; 2 slots for SO-DIMM DDR2 modules (max. total of 3 GB), Realtek RTL8111C Ethernet controller	65
	CompactFlash	
5CFCRD.016G-06	CompactFlash 16 GB B&R (SLC) ≤ Rev. D0	294
5CFCRD.032G-06	CompactFlash 32 GB B&R (SLC) ≤ Rev. C0	294
5CFCRD.0512-06	CompactFlash 512 MB B&R (SLC) ≤ Rev. E0	294
5CFCRD.1024-06	CompactFlash 1 GB B&R (SLC) ≤ Rev. E0	294
5CFCRD.2048-06	CompactFlash 2 GB B&R (SLC) ≤ Rev. E0	294
5CFCRD.4096-06	CompactFlash 4 GB B&R (SLC) ≤ Rev. E0	294
5CFCRD.8192-06	CompactFlash 8 GB B&R (SLC) ≤ Rev. E0	294
	CompactFlash-cards	
5CFCRD.0064-03	CompactFlash 64 MB Western Digital (SLC)	304
5CFCRD.0128-03	CompactFlash 128 MB Western Digital (SLC)	304
5CFCRD.016G-04	CompactFlash 16 GB B&R (SLC)	300
5CFCRD.0256-03	CompactFlash 256 MB Western Digital (SLC)	304
5CFCRD.0512-03	CompactFlash 512 MB Western Digital (SLC)	304
5CFCRD.0512-04	CompactFlash 512 MB B&R (SLC)	300
5CFCRD.1024-03	CompactFlash 1 GB Western Digital (SLC)	304
5CFCRD.1024-04	CompactFlash 1 GB B&R (SLC)	300
5CFCRD.2048-03	CompactFlash 2 GB Western Digital (SLC)	304
5CFCRD.2048-04	CompactFlash 2 GB B&R (SLC)	300
5CFCRD.4096-03	CompactFlash 4 GB Western Digital (SLC)	304
5CFCRD.4096-04	CompactFlash 4 GB B&R (SLC)	300

Product ID	Short description	on page
5CFCRD.8192-03	CompactFlash 8 GB Western Digital (SLC)	304
5CFCRD.8192-04	CompactFlash 8 GB B&R (SLC)	300
	DVI cables	
5CADVI.0018-00	DVI-D cable - 1.8 m	321
5CADVI.0050-00	DVI-D cable - 5 m	321
5CADVI.0100-00	DVI-D cable - 10 m	321
	Drives	
5AC801.ADAS-00	SATA hard disk adapter for operating a slide-in compact hard disk in a slide-in slot	121
5AC801.DVDS-00	DVD-ROM SATA slide-in drive	124
5AC801.DVRS-00	DVD-R/RW DVD+R/RW SATA slide-in drive	126
5AC801.HDDI-00	40 GB SATA slide-in compact hard disk; 24/7 operation with extended temperature range. Note: please see the manual for information about using this hard disk	85
5AC801.HDDI-02	160 GB SATA hard disk, slide-in compact, 24/7 operation with extended temperature range. Note: please see the manual for information about using this hard disk	87
5AC801.HDDI-03	250 GB slide-in compact SATA hard disk, 24/7 operation. Note: please see the manual for information about using this hard disk	89
5AC801.HDDI-04	500 GB SATA hard disk, slide-in compact, 24/7 operation Note: please see the manual for information about using this hard disk	91
5AC801.HDDS-00	40 GB SATA slide-in hard disk; 24/7 operation with extended temperature range. Note: please see the manual for information about using this hard disk	122
5AC801.SSDI-00	32 GB SATA SSD (SLC), slide-in compact	93
5AC801.SSDI-01	60 GB SATA slide-in compact SSD (MLC)	97
5AC801.SSDI-02	180 GB SATA slide-in compact SSD (MLC)	99
5AC801.SSDI-03	60 GB SATA slide-in compact SSD (MLC)	101
5AC801.SSDI-04	128 GB SATA SSD (MLC), slide-in compact	104
5AC801.SSDI-05	256 GB SATA slide-in compact SSD (MLC)	107
5ACPCI.RAIC-03	PCI RAID system SATA 2x 160 GB; note: Please see the manual for information about using this hard disk.	129
5ACPCI.RAIC-04	160 GB SATA hard disk, replacement part for 5ACPCI.RAIC-03; note: Please see the manual for information about using this hard disk.	132
5ACPCI.RAIC-05	PCI RAID system SATA 2x 250 GB; Note: please see the manual for information about using this hard disk	134
5ACPCI.RAIC-06	PCI RAID System 2x 500 GB - SATA	137
5MMHDD.0250-00	250 GB SATA hard disk; replacement for 5AC801.HDDI-03 and 5ACPCI.RAIC-05; note: please see the manual for information about using this hard disk	140
5MMHDD.0500-00	500 GB hard disk - SATA	142
5MMSSD.0060-00	60 GB SSD MLC - Intel - SATA	109
5MMSSD.0060-01	60 GB SSD MLC - Intel - SATA	111
5MMSSD.0128-01	128 GB SSD MLC - Toshiba - SATA	114
5MMSSD.0180-00	180 GB SSD MLC - Intel - SATA	117
5MMSSD.0256-00	256 GB SSD MLC - Slide-in compact - Toshiba - SATA	119
	Expansions	
5AC803.SX01-00	PPC800 expansion; 1 PCI/PCI Express and 1 slide-in slot (bus 5AC803.BX01-00 or 5AC803.BX01-01 required)	70
5AC803.SX02-00	PPC800 expansion; 2 PCI/PCI Express and 1 slide-in slot (bus 5AC803.BX02-00 or 5AC803.BX02-01 required)	70
	Fan kits	
5AC803.FA01-00	PPC800 fan kit for system units without an expansion	144
5AC803.FA02-00	PPC800 fan kit for system units with expansion 5AC803.SX01-00	145
5AC803.FA03-00	PPC800 fan kit for system units with expansion 5AC803.SX02-00	147
	Interface cards	
5ACPCC.ETH0-00	PCleC Ethernet card 1x 10/100/1000 For APC820 and PPC800.	79
5ACPCC.MPL0-00	PCleC POWERLINK card, 2 POWERLINK interfaces, 512 kB SRAM; for APC820 and PPC800.	81
	Kühlkörper	
5AC803.HS00-00	PPC800 heat sink for CPU boards with L2400, L7400, U7500 or Celeron M 423 dual-core processor	68
5AC803.HS00-01	PPC800 heat sink for CPU boards with T7400, T9400 or P8400 dual-core processor	68
5AC803.HS00-02	PPC800 heat sink for CPU board with Atom processor N270	68
	MS-DOS	
9S0000.01-010	OEM Microsoft MS-DOS 6.22, German floppy disks, only supplied together with a new PC	235
9S0000.01-020	OEM Microsoft MS-DOS 6.22, English floppy disks, only supplied together with a new PC	235
	Main memory	
5MMDDR.0512-01	SO-DIMM DDR2 RAM 512 MB PC2-5300	69
5MMDDR.1024-01	SO-DIMM DDR2 RAM 1024 MB PC2-5300	69
5MMDDR.2048-01	SO-DIMM DDR2 RAM 2048 MB PC2-5300	69
	Miscellaneous	
5AC900.1000-00	DVI (male connector) to CRT (female connector) adapter. For connecting a standard monitor to a DVI-I interface.	273
	Other	
5SWHMI.0000-00	HMI Drivers & Utilities DVD	318
	RS232 cables	
9A0014.02	RS232 extension cable for remote operation of a display unit with touch screen, 1.8 m	338
9A0014.05	RS232 extension cable for remote operation of a display unit with touch screen, 5 m	338
9A0014.10	RS232 extension cable for remote operation of a display unit with touch screen, 10 m	338
	Replacement batteries	
9A0100.13	UPS batteries type A (replacement part), 2x 12 V, 7 Ah, for battery unit 9A0100.12	284
9A0100.15	UPS batteries type B (replacement part), 2x 12 V, 2.2 Ah, for battery unit 9A0100.14	284
9A0100.17	UPS batteries type C (replacement part), 2x 12 V, 4.5 Ah, for battery unit 9A0100.16	284
	SDL cables	
5CASDL.0018-00	SDL cable - 1.8 m	324
5CASDL.0050-00	SDL cable - 5 m.	324

Product ID	Short description	on page
5CASDL.0100-00	SDL cable, 10 m	324
5CASDL.0150-00	SDL cable, 15 m	324
5CASDL.0200-00	SDL cable, 20 m	324
5CASDL.0250-00	SDL cable, 25 m	324
5CASDL.0300-00	SDL cable, 30 m	324
SDL cables with 45° connectors		
5CASDL.0018-01	SDL cable - 45° connector - 1.8 m	327
5CASDL.0050-01	SDL cable with 45° male connector, 5 m	327
5CASDL.0100-01	SDL cable with 45° male connector, 10 m	327
5CASDL.0150-01	SDL cable with 45° male connector, 15 m	327
SDL flex cables		
5CASDL.0018-03	SDL flex cable - 1.8 m	330
5CASDL.0050-03	SDL flex cable, 5 m	330
5CASDL.0100-03	SDL flex cable, 10 m	330
5CASDL.0150-03	SDL flex cable, 15 m	330
5CASDL.0200-03	SDL flex cable, 20 m	330
5CASDL.0250-03	SDL flex cable, 25 m	330
5CASDL.0300-03	SDL flex cable, 30 m	330
5CASDL.0300-13	SDL flex cable with extender, 30 m	333
5CASDL.0400-13	SDL flex cable with extender, 40 m	333
5CASDL.0430-13	SDL flex cable with extender, 43 m	333
Systemeinheiten		
5PC820.1505-00	Panel PC 820 15" XGA TFT display with touch screen (resistive); connections for 1x RS232, 5x USB 2.0, Smart Display Link/DVI/Monitor, 2x Ethernet 10/100/1000, HDA sound, add-on UPS slot, expandable with 1 or 2 PCI / PCI Express slots, optional CompactPCI Express and slide-in compact slot; IP65 protection (front); order 24 VDC connector for supply voltage separately (screw clamp: 0TB103.9; cage clamp: 0TB103.91)	53
5PC820.1906-00	Panel PC 820 19" SXGA color TFT display with touch screen (resistive); connections for 1x RS232, 5x USB 2.0, Smart Display Link/DVI/Monitor, 2x Ethernet 10/100/1000, HDA sound, add-on UPS slot, expandable with 1 or 2 PCI / PCI Express slots, optional CompactPCI Express and slide-in compact slot; IP65 protection (front); order 24 VDC connector for supply voltage separately (screw clamp: 0TB103.9; cage clamp: 0TB103.91)	59
Terminal blocks		
0TB103.9	Connector 24 VDC - 3-pin female - Screw clamps 3.31 mm ²	272
0TB103.91	Connector 24 VDC - 3-pin female - Cage clamps 3.31 mm ²	272
USB accessories		
5A5003.03	Front cover for drives - 5A5003.02 - 5MD900.USB2	316
5MD900.USB2-02	USB 2.0 drive combination - DVD-R/RW, DVD+R/RW - CompactFlash slot	312
5MMUSB.2048-00	USB 2.0 flash drive, 2048 MB	308
5MMUSB.2048-01	USB 2.0 flash drive, 2048 MB, B&R	310
5MMUSB.4096-01	USB 2.0 flash drive, 4096 MB, B&R	310
USB cables		
5CAUSB.0018-00	USB 2.0 connection cable type A - type B, 1.8 m	337
5CAUSB.0050-00	USB 2.0 connection cable type A - type B, 5 m	337
Uninterruptible power supplies		
5AC600.UPSB-00	Battery unit 5 Ah; for APC620, APC810 or PPC800 UPS	279
5AC600.UPSF-00	UPS fuse kit for battery unit 5AC600.UPSB-00 up to revision D0.	283
5AC600.UPSF-01	UPS fuse, 5 pcs.	283
5AC600.UPSI-00	UPS module for APC620, APC810, PPC800; for system units 5PC600.SX01-00 (beginning with rev. H0), 5PC600.SX02-00 (beginning with rev. G0), 5PC600.SX02-01 (beginning with rev. H0), 5PC600.SX05-00 (beginning with rev. F0), 5PC600.SX05-01 (beginning with rev. F0), 5PC600.SF03-00 (beginning with rev. A0), 5PC810.SX*, 5PC820.1505-00, 5PC820.1906-00. Order cable (5CAUPS.0005-00 or 5CAUPS.0030-00) and battery unit (5AC600.UPSB-00) separately.	277
5CAUPS.0005-00	UPS cable 0.5 m; for UPS 5AC600.UPSI-00	282
5CAUPS.0030-00	UPS cable 3 m - For 5AC600.IUPS-00	282
Windows 7 Professional/Ultimate		
5SWWI7.0100-ENG	Windows 7 Professional - 32-bit - English - DVD	238
5SWWI7.0100-GER	Windows 7 Professional - 32-bit - German - DVD	238
5SWWI7.0200-ENG	Windows 7 Professional - 64-bit - English - DVD	238
5SWWI7.0200-GER	Windows 7 Professional - 64-bit - German - DVD	238
5SWWI7.0300-MUL	Windows 7 Professional - 32-bit - Multilingual - DVD	238
5SWWI7.0400-MUL	Windows 7 Ultimate - 64-bit - Multilingual - DVD	238
5SWWI7.1100-ENG	Windows 7 Professional SP1 - 32-bit - English - DVD	238
5SWWI7.1100-GER	Windows 7 Professional SP1 - 32-bit - German - DVD	238
5SWWI7.1200-ENG	Windows 7 Professional SP1 - 64-bit - English - DVD	238
5SWWI7.1200-GER	Windows 7 Professional SP1 - 64-bit - German - DVD	238
5SWWI7.1300-MUL	Windows 7 Ultimate SP1 - 32-bit - Multilingual - DVD	238
5SWWI7.1400-MUL	Windows 7 Ultimate SP1 - 64-bit - Multilingual - DVD	238
Windows CE 6.0		
5SWWCE.0827-ENG	Microsoft OEM Windows CE 6.0 Professional, English; for PPC800 with 945GME chipset; order CompactFlash separately (at least 128 MB)	248
Windows Embedded Standard 2009		
5SWWXP.0727-ENG	Microsoft OEM Windows Embedded Standard 2009, English; for PPC800 with 945GME chipset; order CompactFlash separately (at least 1 GB)	243
Windows Embedded Standard 7		
5SWWI7.0527-ENG	Microsoft OEM Windows Embedded Standard 7 32-bit, English; for PPC800 with 945GME chipset; order CompactFlash separately (at least 8 GB)	245

Product ID	Short description	on page
5SWWI7.0627-ENG	Microsoft OEM Windows Embedded Standard 7 64-bit, English; for PPC800 with 945GME chipset; order CompactFlash separately (at least 16 GB)	245
5SWWI7.0727-MUL	Microsoft OEM Windows Embedded Standard 7 Premium 32-bit, multilingual; for PPC800 with 945GME chipset; order CompactFlash separately (at least 8 GB)	245
5SWWI7.0827-MUL	Microsoft OEM Windows Embedded Standard 7 Premium 64-bit, multilingual; for PPC800 with 945GME chipset; order CompactFlash separately (at least 16 GB)	245
5SWWI7.1527-ENG	Microsoft OEM Windows Embedded Standard 7 32-bit, Service Pack 1, English; for PPC800 with 945GME chipset; order CompactFlash separately (at least 16 GB)	245
5SWWI7.1627-ENG	Microsoft OEM Windows Embedded Standard 7 64-bit, Service Pack 1, English; for PPC800 with 945GME chipset; order CompactFlash separately (at least 16 GB)	245
5SWWI7.1727-MUL	Microsoft OEM Windows Embedded Standard 7 Premium 32-bit, Service Pack 1, multilingual; for PPC800 with 945GME chipset; order CompactFlash separately (at least 16 GB)	245
5SWWI7.1827-MUL	Microsoft OEM Windows Embedded Standard 7 Premium 64-bit, Service Pack 1, multilingual; for PPC800 with 945GME chipset; order CompactFlash separately (at least 16 GB)	245
Windows XP Embedded		
5SWWXP.0427-ENG	Microsoft OEM Windows XP Embedded Feature Pack 2007, English; for PPC800 with 945GME chipset; order CompactFlash separately (at least 512 MB)	241
Windows XP Professional		
5SWWXP.0500-ENG	Microsoft OEM Windows XP Professional Service Pack 2c, CD, English. Only available with a new device.	236
5SWWXP.0500-GER	Microsoft OEM Windows XP Professional Service Pack 2c, CD, German. Only available with a new device.	236
5SWWXP.0500-MUL	Microsoft OEM Windows XP Professional Service Pack 2c, CD, multilingual. Only available with a new device.	236
5SWWXP.0600-ENG	Windows XP Professional SP3 - English - CD	236
5SWWXP.0600-GER	Windows XP Professional SP3 - German - CD	236
5SWWXP.0600-MUL	Windows XP Professional SP3 - Multilingual - CD	236

Chapter 2 • Technical data

1 Introduction

The Panel PC 800 covers an extremely wide performance range – relying on efficient Intel Atom N270 processors and Core2 Duo processors for applications with exceptionally high performance requirements. Brilliant 15" XGA and 19" SXGA touch screen displays provide a simple and intuitive user interface. Flexibility was raised to a completely new level when designing the PPC800. This makes it possible to add several different options to the cost-effective base device. This includes up to two PCI and PCI Express slots, modular drives, additional interfaces and an integrated UPS. The chipset, processor and other components are connected directly to the heat sink using heat conductive materials. This makes it possible to operate not only Atom processors, but also certain dual-core processors without a fan at all.



1.1 Features

- 15" and 19" diagonals
- Latest processor technology – Core Duo, Core 2 Duo, Celeron M and Atom N270
- Up to 3 GB main memory (dual-channel memory support)
- 2 CompactFlash slots (type I)
- Upgrade expansions with 1 or 2 slots for PCI / PCI Express (PCIe) cards and a slide-in drive slot
- 1 optional PCIec (PCI Express compact) card slot (can be upgraded with an adapter)
- 1 optional slide-in compact slot (can be upgraded with an adapter)
- 5x USB 2.0
- 2x Ethernet 10/100/1000 Mbit interfaces
- 1x RS232 interface, modem-compatible
- 24 VDC supply voltage
- BIOS (AMI)
- Real-time clock (RTC, battery-backed)
- Easy slide-in drive replacement (SATA hot plugging)
- HDA sound
- Add-on UPS slot

1.2 System components / Configuration

The PPC800 system can be assembled to meet individual requirements and operating conditions.

The following components are absolutely essential for operation:

- System unit
- CPU board
- Heat sink (depends on the CPU board)
- Main memory
- Drive (mass storage device such as CompactFlash card or hard disk) for the operating system
- Software

1.2.1 Configuration - Base system





Configuration - Base system			
System unit	Select 1		
			
	5PC820.1505-00		
	5PC820.1906-00		
CPU board - Heat sink - Main memory			
CPU board	Select 1		
	5PC800.B945-00 / -10 5PC800.B945-01 / -11 5PC800.B945-02 / -12 5PC800.B945-03 / -13	5PC800.B945-04 / -14	5PC800.B945-05
Heat sink	Select 1		
	5AC803.HS00-00	5AC803.HS00-01	5AC803.HS00-02
Main memory	Select 1 or 2 (max. 3 GB can be used)		
	5MMDDR.0512-01 - 512 MB 5MMDDR.1024-01 - 1 GB 5MMDDR.2048-01 - 2 GB		

Figure 1: Configuration - Base system

1.2.2 Configuration - Optional components

Configuration - Optional components			
Configuration of a system unit with adapter			
Adapters ¹⁾	Select one or both		
	5AC803.BC01-00 ↓	5AC803.BC02-00 ↓	
	PCIec plug-in cards, Select 1	Slide-in compact drives, select 1	
	5ACPC.C.ETH0-00 (PCIec Ethernet card 10/100/1000) 5ACPC.C.MPL0-00 (PCIec POWERLINK MN 2-port)	5AC801.HDDI-00 (40 GB) 5AC801.HDDI-04 (500 GB) 5AC801.SSDI-03 (60 GB) 5AC801.SSDI-04 (128 GB) 5AC801.SSDI-05 (256 GB)	
Configuration of a system unit with expansion			
Expansion	No expansion	1x PCI/PCIe + 1x slide-in slot	2x PCI/PCIe + 1x slide-in slot
	/	5AC803.SX01-00	5AC803.SX02-00
Bus units		Select 1	Select 1
	/	5AC803.BX01-00 5AC803.BX01-01	5AC803.BX02-00 5AC803.BX02-01
Fan kit ²⁾	Select 1	Select 1	Select 1
	5AC803.FA01-00	5AC803.FA01-00	5AC803.FA01-00
Slide-idrives		Select 1	
	/	5AC801.HDDS-00 (40 GB) 5AC801.DVDS-00 (DVD drive) 5AC801.DVRS-00 (DVD writer) 5AC801.ADAS-00 (adapter)	
RAID system		Select 1	
	/	5ACPCI.RAIC-06 (2x 500 GByte, occupies 1 PCI slot) 5MMHDD.0500-00 (SATA-HDD replacement 500 GByte)	
CompactFlash	Select 1		
	5CFCRD.0512-06, 5CFCRD.1024-06, 5CFCRD.2048-06, 5CFCRD.4096-06, 5CFCRD.8192-06, 5CFCRD.016G-06, 5CFCRD.032G-06	5CFCRD.0064-03, 5CFCRD.0128-03, 5CFCRD.0256-03, 5CFCRD.0512-03, 5CFCRD.1024-03, 5CFCRD.2048-03, 5CFCRD.4096-03, 5CFCRD.8192-03	
UPS battery	Select 1		
	5AC600.UPSI-00 (add-on UPS module) 5AC600.UPSB-00 (UPS battery unit) Connection cable: 5CAUPS.0005-00 (0.5 meters) or 5CAUPS.0030-00 (3 meters)		
Power connectors	Select 1		
	0TB103.9 (screw clamps) 0TB103.91 (cage clamps)		
Software	Select 1		
	Windows XP 5SXXXP.0500-ENG 5SXXXP.0500-GER 5SXXXP.0500-MUL 5SXXXP.0600-ENG 5SXXXP.0600-GER 5SXXXP.0600-MUL Windows 7 5SXXW7.1100-ENG 5SXXW7.1100-GER 5SXXW7.1200-ENG 5SXXW7.1200-GER 5SXXW7.1300-MUL 5SXXW7.1400-MUL	Windows Embedded Standard 2009 5SXXWP.0727-ENG Windows XP Embedded 5SXXWP.0427-ENG Windows CE 5SXXWCE.0827-ENG Windows Embedded Standard 7 5SXXW7.1527-ENG 5SXXW7.1627-ENG 5SXXW7.1727-MUL 5SXXW7.1827-MUL	Automation Runtime 1TG4600.10-5 1TG4601.06-5 0TG1000.01 Microsoft DOS 9S0000.01-010 9S0000.01-020

1) If both adapters are used, then a PCIec plug-in card and a slide-in compact drive can be used in a single device.
 2) A fan kit may be necessary for certain system configurations.

Figure 2: Configuration - Optional components

2 Complete system

2.1 Temperature specifications

CPU boards can be combined with various other components such as drives, main memory, additional plug-in cards, etc. depending on the system unit and fan kit. The many different configurations possible result in varying maximum ambient temperatures, which can be seen in the following tables in this section.

Information:

The maximum specified ambient temperatures for operation with and without a fan kit have been determined under worst-case conditions. Experience has shown that higher ambient temperatures can be reached in typical applications, e.g. those in Microsoft Windows. Testing and evaluation must be performed on-site by the user (temperatures can be read in BIOS or with the B&R Control Center).

Information regarding worst-case conditions

- Thermal Analysis Tool (TAT V3.8) from Intel for simulating a 100% processor load
- BurnInTest tool (BurnInTest V4.0 Pro from Passmark Software) for simulating a 100% load on the interface via loop back adapters (serial interfaces, slide-in drives, USB ports, audio outputs)
- Maximum system expansion and power consumption

What must be considered when determining the maximum ambient temperature?

- Operating the complete system with or without fan kit

2.1.1 Maximum ambient temperature

Information:

Only specified mounting orientations are permitted. See chapter "Installation", section "Mounting orientation" on page 151.

2.1.1.1 Ambient temperature for CPU boards 5PC800.B945-0x

All temperature values in degrees Celsius (°C) at 500 m above sea level.

The maximum ambient temperature is typically derated by 1°C per 1000 meters (starting at 500 meters above sea level).

		Operation without a fan kit					Operation with a fan kit					Temperature limits	Location of sensor(s)
		ETH1: Up to 100 Mbit operation ETH2: Up to 100 Mbit operation					ETH1: Up to 100 Mbit operation ETH2: Up to 1 Gbit operation						
Maximum ambient temperature		5PC800.B945-00	5PC800.B945-01	5PC800.B945-02	5PC800.B945-03	5PC800.B945-04	5PC800.B945-00	5PC800.B945-01	5PC800.B945-02	5PC800.B945-03	5PC800.B945-04		
What else can also be operated at the max. ambient temperature, or are there any limits?		30	30	35	35	/	45	45	50	50	35		
Slide-in compact drives	Onboard CompactFlash ¹⁾	✓	✓	✓	✓		✓	✓	✓	✓	✓	80	Board power
	5AC801.HDDI-00	✓	✓	✓	✓		✓	✓	✓	✓	✓	80	
	5AC801.HDDI-02	✓	✓	✓	✓		✓	✓	✓	✓	✓	80	
	5AC801.HDDI-03	✓	✓	✓	✓		✓	✓	✓	✓	✓	60	
	5AC801.HDDI-04	✓	✓	✓	✓		✓	✓	✓	✓	✓	60	
	5AC801.SSDI-00	✓	✓	✓	✓		✓	✓	✓	✓	✓	70	
	5AC801.SSDI-01	✓	✓	✓	✓		✓	✓	✓	✓	✓	70	
	5AC801.SSDI-02	✓	✓	✓	✓		✓	✓	✓	✓	✓	70	
	5AC801.SSDI-03 ≤ Rev. C0	✓	✓	✓	✓		✓	✓	✓	✓	✓	70	
	5AC801.SSDI-03 ≥ Rev. D0	✓	✓	✓	✓		✓	✓	✓	✓	✓	80	
	5AC801.SSDI-04 ≤ Rev. C0	✓	✓	✓	✓		✓	✓	✓	✓	✓	70	
5AC801.SSDI-04 ≥ Rev. D0	✓	✓	✓	✓		✓	✓	✓	✓	✓	80		
5AC801.SSDI-05	✓	✓	✓	✓		✓	✓	✓	✓	✓	80		
Slide-in drives	5AC801.HDDS-00	✓	✓	✓	✓		✓	✓	✓	✓	✓	80	Slide-in drive 1
	5AC801.DVDS-00	✓	✓	✓	✓		✓	✓	✓	✓	✓	50	
	5AC801.DVRS-00	✓	✓	✓	✓		✓	✓	✓	✓	✓	50	
Main memory	5MMDDR.0512-01	✓	✓	✓	✓		✓	✓	✓	✓	✓	-	-
	5MMDDR.1024-01	✓	✓	✓	✓		✓	✓	✓	✓	✓	-	
	5MMDDR.2048-01	✓	✓	✓	✓		✓	✓	✓	✓	✓	-	
System units	5PC820.1505-00	✓	✓	✓	✓		✓	✓	✓	✓	✓	80	Power supply
	5PC820.1906-00	✓	✓	✓	✓		✓	✓	✓	✓	✓	80	
Additional plug-in cards PCIe card slot	5ACPCC.ETH0-00	✓	✓	✓	✓		✓	✓	✓	✓	✓	-	Additional plug-in cards
	5ACPCC.MPL0-00	✓	✓	✓	✓		✓	✓	✓	✓	✓	-	
	5ACPCI.RAIC-03 (24 hours / standard)	✓	✓	✓	✓		✓	✓	✓	✓	✓	-	
	5ACPCI.RAIC-04 (24 hours / standard)	✓	✓	✓	✓		✓	✓	✓	✓	✓	-	
	5ACPCI.RAIC-05 (24 hours / standard)	✓	✓	✓	✓		✓	✓	✓	✓	✓	-	
	5ACPCI.RAIC-06 (24 hours / standard)	✓	✓	✓	✓		✓	✓	✓	✓	✓	-	

1) Only possible with a CompactFlash card from B&R that is compatible with the device.

Table 5: Ambient temperatures

2.1.1.2 Ambient temperature for CPU boards 5PC800.B945-1x and 5PC800.B945-05

Information:

Only specified mounting orientations are permitted. See chapter "Installation", section "Mounting orientation" on page 151.

All temperature values in degrees Celsius (°C) at 500 m above sea level.

The maximum ambient temperature is typically derated by 1°C per 1000 meters (starting at 500 meters above sea level).

		Operation without a fan kit					Operation with a fan kit					Temperature limits	Location of sensor(s)		
		ETH1: Up to 1 Gbit operation ETH2: Up to 1 Gbit operation					ETH1: Up to 1 Gbit operation ETH2: Up to 1 Gbit operation								
Maximum ambient temperature		5PC800.B945-10	5PC800.B945-11	5PC800.B945-12	5PC800.B945-13	5PC800.B945-14	5PC800.B945-05	5PC800.B945-10	5PC800.B945-11	5PC800.B945-12	5PC800.B945-13	5PC800.B945-14	5PC800.B945-05		
What else can also be operated at the max. ambient temperature, or are there any limits?		35	35	45	45	/	55	45	45	55	55	45 ¹⁾	60		
Slide-in compact drives	Onboard CompactFlash ²⁾	✓	✓	✓	✓		✓	✓	✓	✓	✓	✓	✓	80	Board power
	5AC801.HDDI-00	✓	✓	✓	✓		✓	✓	✓	✓	✓	✓	✓	80	
	5AC801.HDDI-02	✓	✓	✓	✓		✓	✓	✓	✓	✓	✓	✓	80	
	5AC801.HDDI-03	✓	✓	✓	✓		45	✓	✓	50	50	✓	50	60	
	5AC801.HDDI-04	✓	✓	✓	✓		45	✓	✓	50	50	✓	50	60	
	5AC801.SSDI-00	✓	✓	✓	✓		✓	✓	✓	✓	✓	✓	✓	70	
	5AC801.SSDI-01	✓	✓	✓	✓		✓	✓	✓	✓	✓	✓	✓	70	
	5AC801.SSDI-02	✓	✓	✓	✓		✓	✓	✓	✓	✓	✓	✓	70	
	5AC801.SSDI-03 ≤ Rev. C0	✓	✓	✓	✓		✓	✓	✓	✓	✓	✓	✓	70	
	5AC801.SSDI-03 ≥ Rev. D0	✓	✓	✓	✓		✓	✓	✓	✓	✓	✓	✓	80	
	5AC801.SSDI-04 ≤ Rev. C0	✓	✓	✓	✓		✓	✓	✓	✓	✓	✓	✓	70	
	5AC801.SSDI-04 ≥ Rev. D0	✓	✓	✓	✓		✓	✓	✓	✓	✓	✓	✓	80	
5AC801.SSDI-05	✓	✓	✓	✓		✓	✓	✓	✓	✓	✓	✓	80		
Slide-in drives	5AC801.HDDS-00	✓	✓	✓	✓		✓	✓	✓	✓	✓	✓	✓	80	Slide-in drive 1
	5AC801.DVDS-00	✓	✓	✓	✓		50	✓	✓	50	50	✓	50	50	
	5AC801.DVRS-00	✓	✓	✓	✓		50	✓	✓	50	50	✓	50	50	
Main memory	5MMDDR.0512-01	✓	✓	✓	✓		✓	✓	✓	✓	✓	✓	✓	-	-
	5MMDDR.1024-01	✓	✓	✓	✓		✓	✓	✓	✓	✓	✓	✓	-	
	5MMDDR.2048-01	✓	✓	✓	✓		✓	✓	✓	✓	✓	✓	✓	-	
System units	5PC820.1505-00	✓	✓	✓	✓		✓	✓	✓	✓	✓	✓	✓	80	Power supply
	5PC820.1906-00	30	30	35	35		45	✓	✓	50	50	✓	50	80	
Additional plug-in cards PClec card slot	5ACPC.C.ETH0-00	✓	✓	✓	✓		✓	✓	✓	✓	✓	✓	✓	-	Additional plug-in cards
	5ACPC.C.MPL0-00	✓	✓	✓	✓		✓	✓	✓	✓	✓	✓	✓	-	
	5ACPC.I.RAIC-03 (24 hours / standard)	✓	✓	✓	✓		✓	✓	✓	✓	✓	✓	✓	-	
	5ACPC.I.RAIC-04 (24 hours / standard)	✓	✓	✓	✓		✓	✓	✓	✓	✓	✓	✓	-	
	5ACPC.I.RAIC-05 (24 hours / standard)	✓	✓	✓	✓		45	✓	✓	50	50	✓	50	-	
5ACPC.I.RAIC-06 (24 hours / standard)	✓	✓	✓	✓		45	✓	✓	50	50	✓	50	-		

1) The specified temperature applies only to the CPU board 5PC800.B945-14 with heat sink 5AC803.HS00-01 Rev > A5. If a heat sink with a lower revision number is used, then the maximum ambient temperature of CPU board 5PC800.B954-04 should be used.
 2) Only possible with a CompactFlash card from B&R that is compatible with the device.

Table 6: Ambient temperatures

2.1.1.3 How is the maximum ambient temperature determined?

1. The CPU board is selected (i.e. operation with or without a fan kit).
2. The "Maximum ambient temperature" row shows the maximum ambient temperature for the complete system, including the respective CPU board.

Information:

Maximum temperature data is for operation at 500 meters. The maximum ambient temperature is typically derated by 1°C per 1000 meters (starting at 500 meters above sea level).

3. Incorporating additional drives (slide-in), main memory, additional plug-in cards, etc. can change the temperature limits of a PPC800 system.

If there is a "✓" next to the component, it can be used at the maximum ambient temperature of the complete system without problems.

If there is a specific temperature, for example "50", next to the component, then the ambient temperature of the complete PPC800 system cannot exceed this temperature.

2.1.2 Minimum ambient temperatures

For systems containing one of the following components, the minimum ambient temperature is +5°C: 5AC801.DVDS-00, 5AC801.DVRS-00. If none of these components are used, then the minimum ambient temperature is 0°C.

2.1.3 Temperature monitoring

Sensors monitor temperature values at various places in the PPC800 (board I/O, board ETH2, board power, power supply, slide-in drive 1, IF slot). The location of these temperature sensors is illustrated in "Temperature sensor locations" on page 31. The value listed in the table represents the defined maximum temperature for this measurement point. An alarm is not triggered if this temperature is exceeded. The temperatures¹⁾ can be read in BIOS (Advanced - Baseboard/Panel features - Baseboard monitor) or in approved Microsoft Windows operating systems using the B&R Control Center.

In addition, the hard disks for PPC800 systems available from B&R are equipped with S.M.A.R.T, or Self-Monitoring, Analysis, and Reporting Technology. This makes it possible to read various parameters, e.g. temperature, using software (such as HDD Thermometer, a freeware program) on approved Microsoft operating systems (except Windows CE).

2.1.4 Temperature sensor locations

Sensors monitor temperature values at many different locations in the PPC800. These temperatures can be read in BIOS (Advanced - Baseboard/Panel features - Baseboard monitor) or in approved Microsoft operating systems using the B&R Control Center²⁾.

For applications that don't use Windows, the temperatures can be evaluated using the B&R implementation guide. In addition to the implementation guide, there are also programs available in MS-DOS.

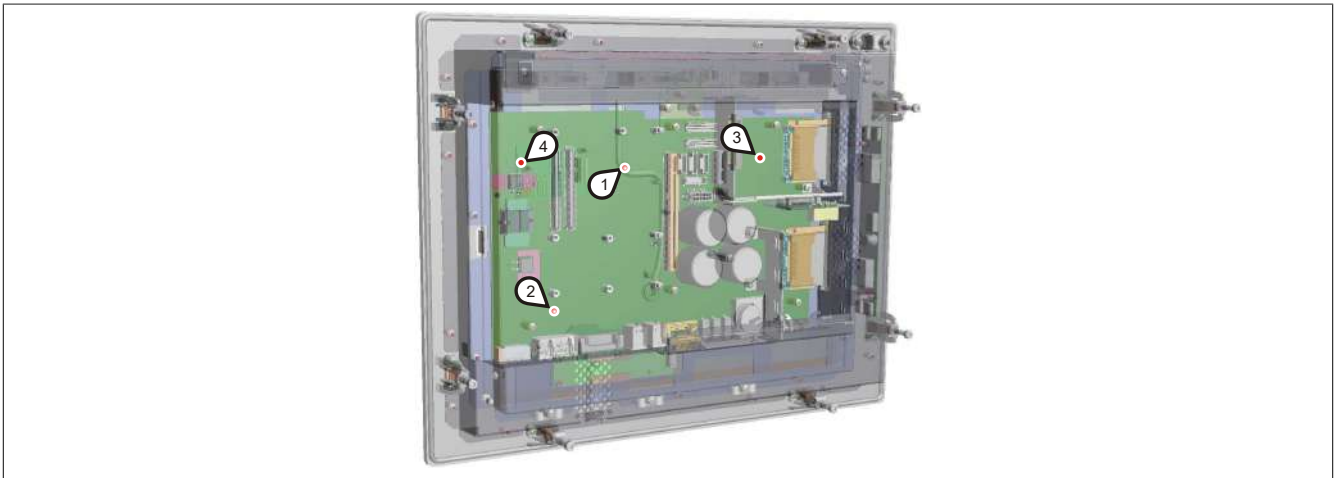

Figure 3: Temperature sensor locations

Position	Measurement point for	Measurement	Max. specified
1	Board I/O	Board temperature in the I/O area (sensor on the mainboard)	80°C
2	Board ETH2	Baseboard temperature near the ETH2 controller (sensor on the mainboard)	80°C
3	Board power	Board power supply temperature (sensor on the mainboard)	80°C
4	Power supply	Power supply temperature	80°C
-	Slide-in drive 1	Slide-in drive temperature (sensor integrated in the slide-in slot).	Depends on the slide-in drive being used
-	IF slot	PClec slot temperature; the sensor is located directly on the plug-in card.	Depends on the plug-in card being used

Table 7: Temperature sensor locations

¹⁾ The temperature measured approximates the immediate ambient temperature but may also be influenced by neighboring components.

²⁾ The ADI driver containing the B&R Control Center is available in the Downloads section of the B&R website (www.br-automation.com).

2.2 Humidity specifications

The following table lists the minimum and maximum relative humidity values for the individual components that are relevant for the humidity limitations of a complete system. The lowest and highest common values are always used when establishing these limits.

Component		Operation	Storage / Transport
945GME COM Express CPU boards		10 to 90%	5 to 95%
Main memory for CPU boards		10 to 90%	5 to 95%
Slide-in compact drives	5AC801.HDDI-00	5 to 90%	5 to 95%
	5AC801.HDDI-02	8 to 80%	5 to 95%
	5AC801.HDDI-03	5 to 95%	5 to 95%
	5AC801.HDDI-04	5 to 95%	5 to 95%
	5AC801.SSDI-00	5 to 95%	5 to 95%
	5AC801.SSDI-01	5 to 95%	5 to 95%
	5AC801.SSDI-02	5 to 95%	5 to 95%
	5AC801.SSDI-03 ≤ Rev. C0	8 to 90%	8 to 95%
	5AC801.SSDI-03 ≥ Rev. D0	5 to 90%	5 to 95%
	5AC801.SSDI-04 ≤ Rev. C0	8 to 90%	8 to 95%
	5AC801.SSDI-04 ≥ Rev. D0	5 to 90%	5 to 95%
Slide-in drives	5AC801.HDDS-00	5 to 90%	5 to 90%
	5AC801.DVDS-00	8 to 90%	5 to 95%
	5AC801.DVRS-00	8 to 90%	5 to 95%
Additional plug-in cards	5ACPCI.RAIC-03 (24 hours / standard)	8 to 90%	5 to 95%
	5ACPCI.RAIC-04 (24 hours / standard)	8 to 90%	5 to 95%
	5ACPCI.RAIC-05 (24 hours / standard)	5 to 95%	5 to 95%
	5ACPCI.RAIC-06 (24 hours / standard)	5 to 95%	5 to 95%
	5MMHDD.0250-00 (24 hours / standard)	5 to 95%	5 to 95%
	5MMHDD.0500-00 (24 hours / standard)	5 to 95%	5 to 95%
Accessories	5CFCRD.xxxx-06 CompactFlash cards	85%	85%
	5CFCRD.xxxx-04 CompactFlash cards	85%	85%
	5CFCRD.xxxx-03 CompactFlash cards	8 to 95%	8 to 95%
	5MMUSB.2048-00 flash drive	10 to 90%	5 to 90%
	5MMUSB.xxxx-01 flash drive	85%	85%
	5MD900.USB2-01 USB media drive	20 to 80%	5 to 90% / 5 to 95%
	5MD900.USB2-02 USB media drive	20 to 80%	5 to 90% / 5 to 95%

Table 8: Overview of humidity specifications for individual components

The specifications listed correspond to the relative humidity at an ambient temperature of 30°C. More detailed information about specific temperature-dependent humidity values can be found in the technical data for the individual components.

2.3 Power management

2.3.1 Supply voltage block diagram

The following block diagram illustrates the simplified structure of the PPC800 supply voltage.

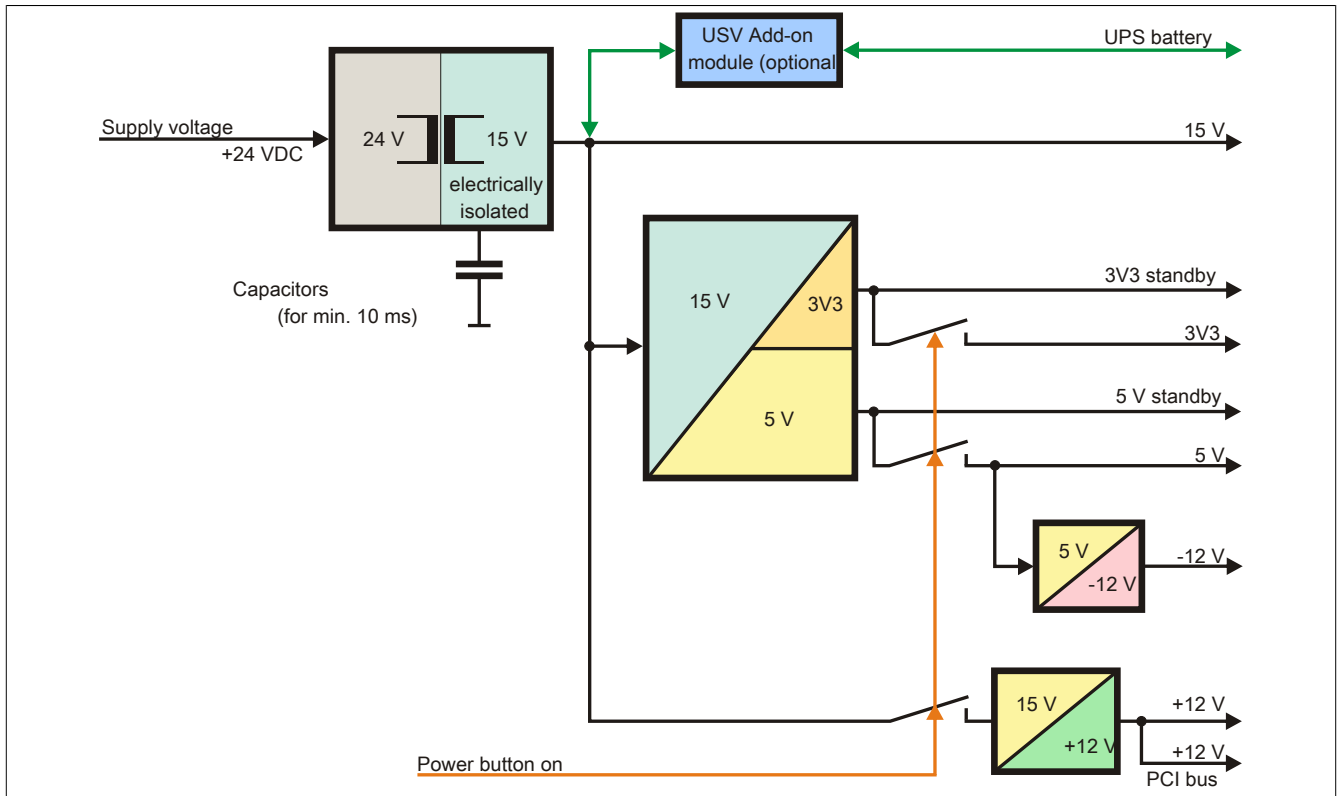

Figure 4: Supply voltage block diagram

Description

15 V is generated from the supply voltage using a DC-to-DC converter. This electrically isolated 15 V supplies additional DC-to-DC converters that generate the remaining voltage.

After the system is turned on (e.g. using the power button), the 3V3 and 5 V voltages are applied to the bus. At the 5 V output, another DC-to-DC converter generates -12 V and applies this to the bus. An additional DC-to-DC converter generates +12 V.

The optional add-on UPS (with battery unit) is supplied with 15 V and provides an uninterrupted power supply of the 15 V bus during a power failure.

2.3.2 Power calculation with 5PC820.1505-00

Information:		CPU board						Current system
		5PC800.B945-00 5PC800.B945-10	5PC800.B945-01 5PC800.B945-11	5PC800.B945-02 5PC800.B945-12	5PC800.B945-03 5PC800.B945-13	5PC800.B945-04 5PC800.B945-14	5PC800.B945-05	Enter values in this column
All values in watts The values for the suppliers are maximum values. The values for the consumers are average maximum values, but not peak values.		Total power supply power (maximum)						130
		Add-on UPS module, optional	7.5	7.5	7.5	7.5	7.5	7.5
		Backlight display 15"	14	14	14	14	14	
		Maximum possible at +12V						75
+12 V	CPU board, permanent consumer		26	30	18	14	43	11
	512 MB RAM, max. 2 with 1.5 W each							
	1024 MB RAM, max. 2 with 2.5 W each							
	2048 MB RAM, max. 2 with 3 W each							
	Fan kit, optional		2.4	2.4	2.4	2.4	2.4	2.4
	External consumers, optional (via mainboard)		10	10	10	10	10	10
	Power consumption of the PCIe card, optional, max. 4 W ²⁾							
	PCI card limit, optional (max. 3 W without fan kit, max. 6 W with fan kit) ¹⁾							
	PCIe x1 card limit, optional (max. 3 W without fan kit, max. 20 W with fan kit) ¹⁾							
			Consumers +12 V ∑					
		Maximum possible at +5V						65
+5 V	System unit, permanent consumers		4	4	4	4	4	4
	Hard disk (slide-in compact)		4	4	4	4	4	4
	Slide-in drive (hard disk, DVD-ROM, etc.)		4	4	4	4	4	4
	USB peripherals USB1 and USB3 with 2.5 W each							
	USB peripherals USB2, USB4 and USB5 with 5 W each							
	External consumers, optional (via mainboard)		5	5	5	5	5	5
	Power consumption of the PCIe card, optional, max. 4 W ²⁾							
	PCI card limit, optional (max. 3 W without fan kit, max. 20 W with fan kit) ¹⁾							
		Maximum possible at -12V						1.2
-12 V	PCI card limit, optional (max. 1.2 W with or without fan kit) ¹⁾							
			Consumers -12 V ∑					
		Consumers +5 V ∑						
		Maximum possible at 3V3						40
3V3	System unit, permanent consumers		9	9	9	9	9	9
	CompactFlash, 1 W each							
	Power consumption of the PCIe card, optional, max. 4 W ²⁾							
	PCI card limit, optional (max. 3 W without fan kit, max. 15 W with fan kit) ¹⁾							
	PCIe x1 card limit, optional (max. 3 W without fan kit, max. 10 W with fan kit) ¹⁾							
		Consumers 3V3 ∑						
		Consumers ∑						

1) The total performance of one PCI/PCIe card per PCI slot (= sum of the power consumption for each voltage range) may not exceed the limits stated for operation with or without a fan kit.

2) The total performance of one PCIe card per PCIe slot (= sum of the power consumption for each voltage area) may not exceed the limits stated for operation with or without a fan kit.

Table 9: Power calculation for 15" PPC800

Information:

The PCIe card must not consume more than a total of 4 W (12 V / 5 V / 3V3)!

2.3.3 Power calculation with 5PC820.1906-00

Information:		CPU board						Current system
		5PC800.B945-00 5PC800.B945-10	5PC800.B945-01 5PC800.B945-11	5PC800.B945-02 5PC800.B945-12	5PC800.B945-03 5PC800.B945-13	5PC800.B945-04 5PC800.B945-14	5PC800.B945-05	Enter values in this column
All values in watts The values for the suppliers are maximum values. The values for the consumers are average maximum values, but not peak values.		Total power supply power (maximum)						130
		Add-on UPS module, optional	7.5	7.5	7.5	7.5	7.5	7.5
		Backlight display 19"	32	32	32	32	32	
		Maximum possible at +12V						75
+12 V	CPU board, permanent consumer		26	30	18	14	43	11
	512 MB RAM, max. 2 with 1.5 W each							
	1024 MB RAM, max. 2 with 2.5 W each							
	2048 MB RAM, max. 2 with 3 W each							
	Fan kit, optional		2.4	2.4	2.4	2.4	2.4	2.4
	External consumers, optional (via mainboard)		10	10	10	10	10	10
	Power consumption of the PCIe card, optional, max. 4 W ²⁾							
	PCI card limit, optional (max. 3 W without fan kit, max. 6 W with fan kit) ¹⁾							
	PCIe x1 card limit, optional (max. 3 W without fan kit, max. 20 W with fan kit) ¹⁾							
			Consumers +12 V ∑					
		Maximum possible at +5V						65
+5 V	System unit, permanent consumers		12	12	12	12	12	12
	Hard disk (slide-in compact)		4	4	4	4	4	4
	Slide-in drive (hard disk, DVD-ROM, etc.)		4	4	4	4	4	4
	USB peripherals USB1 and USB3 with 2.5 W each							
	USB peripherals USB2, USB4 and USB5 with 5 W each							
	External consumers, optional (via mainboard)		5	5	5	5	5	5
	Power consumption of the PCIe card, optional, max. 4 W ²⁾							
	PCI card limit, optional (max. 3 W without fan kit, max. 20 W with fan kit) ¹⁾							
		Maximum possible at -12V						1.2
-12 V	PCI card limit, optional (max. 1.2 W with or without fan kit) ¹⁾							
			Consumers -12 V ∑					
		Consumers +5 V ∑						
		Maximum possible at 3V3						40
3V3	System unit, permanent consumers		9	9	9	9	9	9
	CompactFlash, 1 W each							
	Power consumption of the PCIe card, optional, max. 4 W ²⁾							
	PCI card limit, optional (max. 3 W without fan kit, max. 15 W with fan kit) ¹⁾							
	PCIe x1 card limit, optional (max. 3 W without fan kit, max. 10 W with fan kit) ¹⁾							
		Consumers 3V3 ∑						
		Consumers ∑						

1) The total performance of one PCI/PCIe card per PCI slot (= sum of the power consumption for each voltage range) may not exceed the limits stated for operation with or without a fan kit.

2) The total performance of one PCIe card per PCIe slot (= sum of the power consumption for each voltage area) may not exceed the limits stated for operation with or without a fan kit.

Table 10: Power calculation for 19" PPC800

Information:

The PCIe card must not consume more than a total of 4 W (12 V / 5 V / 3V3)!

2.4 Block diagrams

The following block diagrams illustrate the simplified structure of the system units with a 945GME CPU board (5PC820.1505 / 5PC820.1906-00) in relation to the various bus units.

2.4.1 Bus unit 5AC803.BX01-00

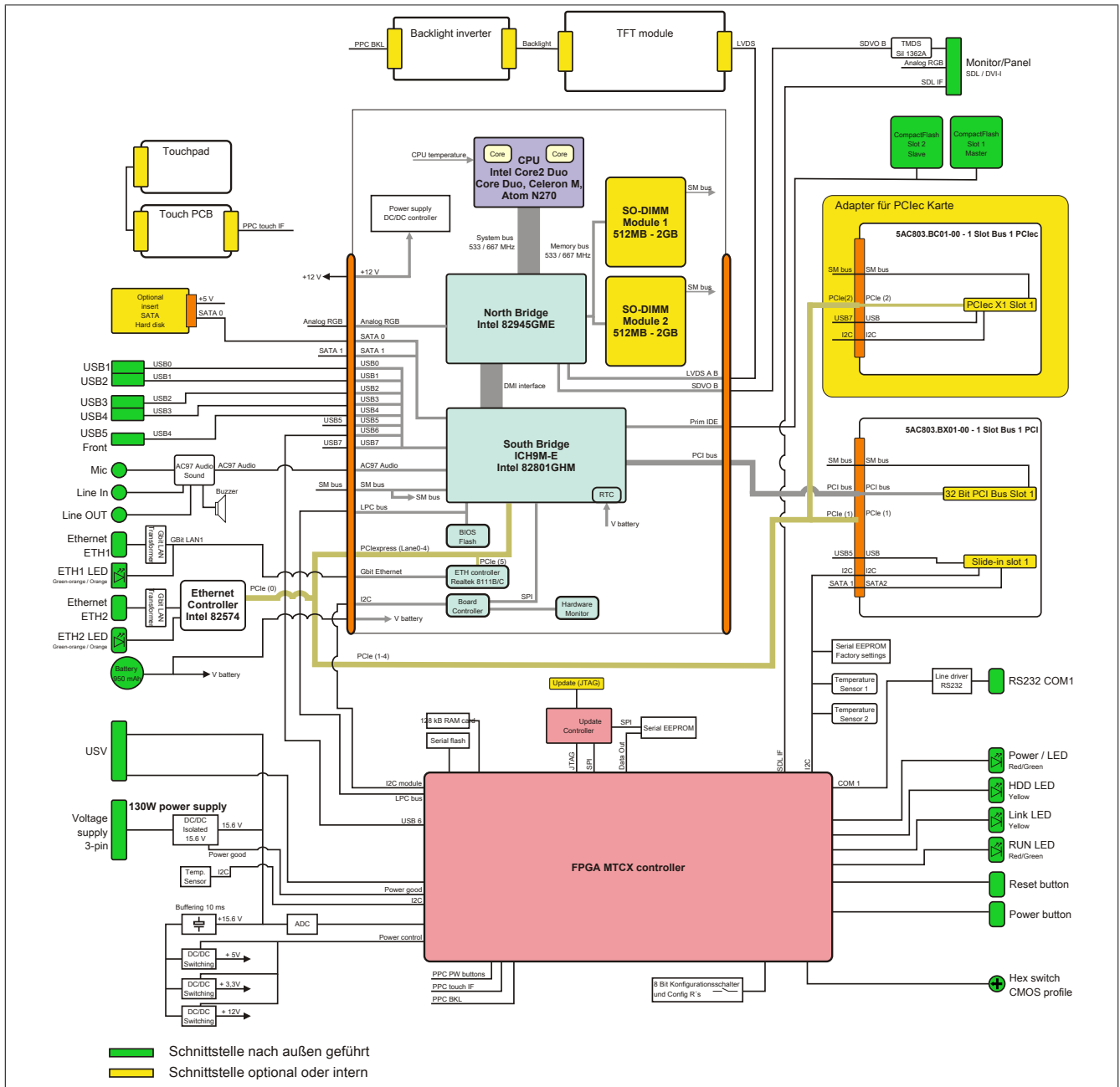

Figure 5: Block diagram with bus unit 5AC803.BX01-00

2.4.2 Bus unit 5AC803.BX01-01

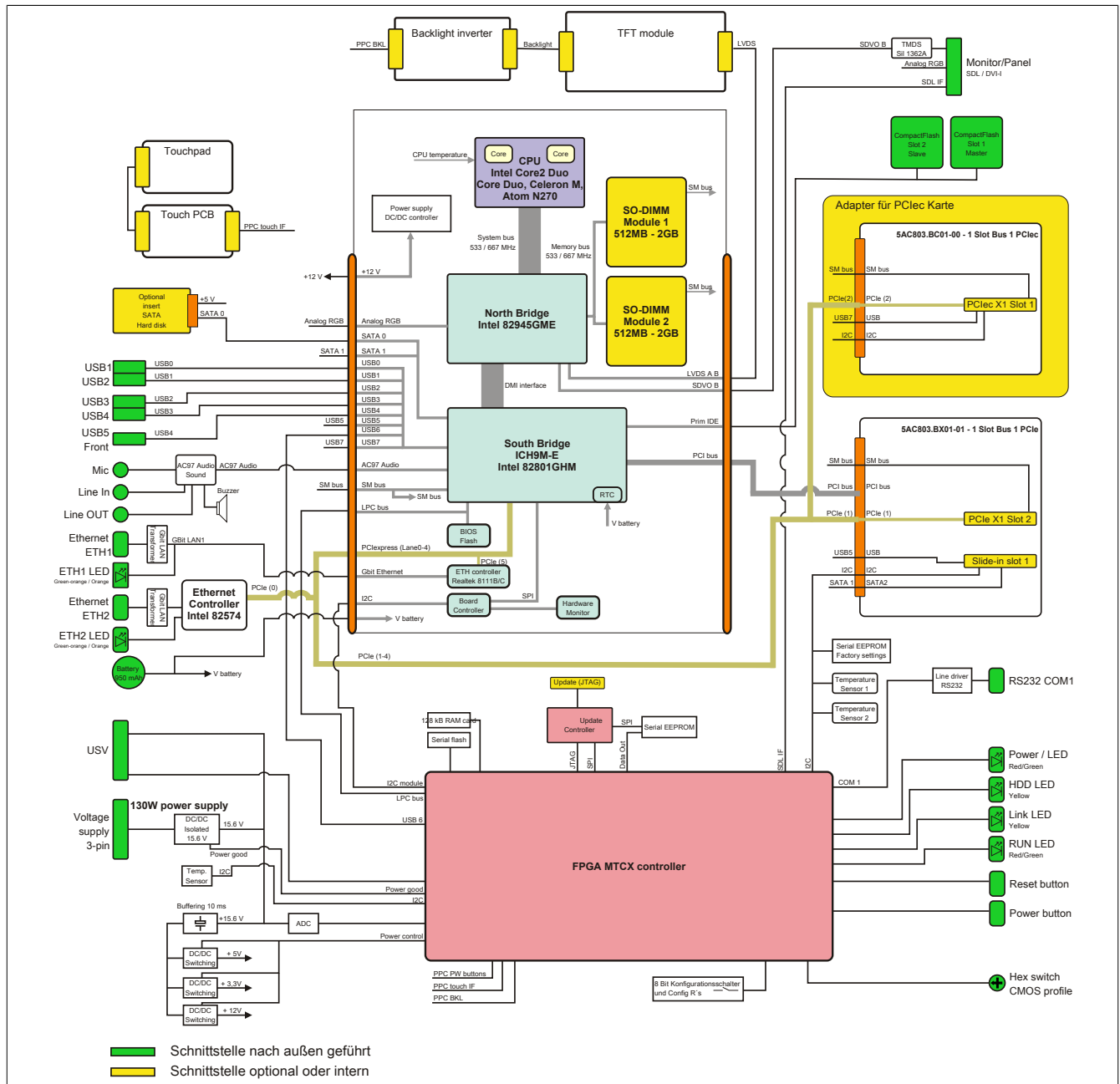

Figure 6: Block diagram with bus unit 5AC803.BX01-01

2.4.3 Bus unit 5AC803.BX02-00

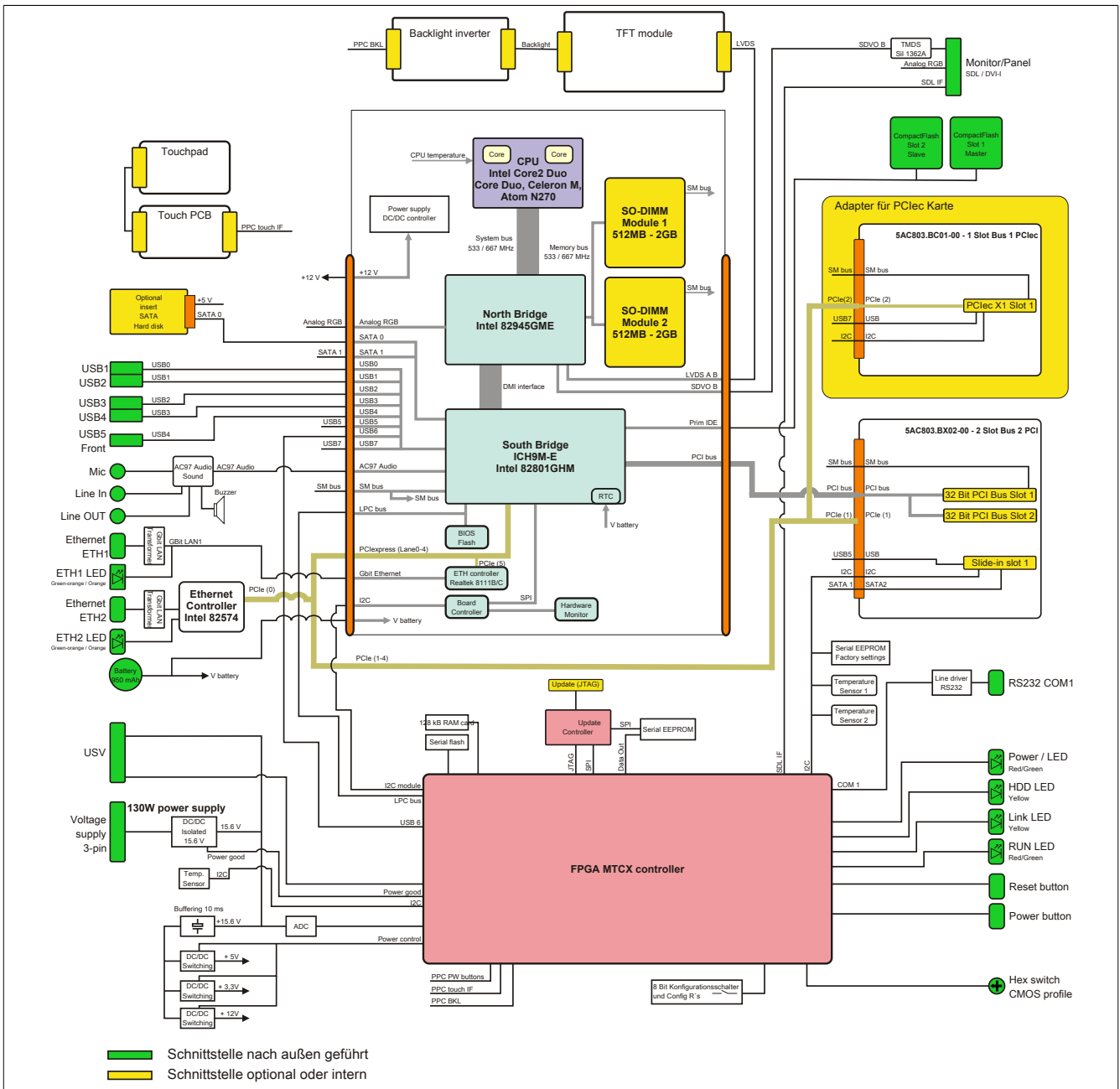

Figure 7: Block diagram with bus unit 5AC803.BX02-00

2.4.4 Bus unit 5AC803.BX02-01

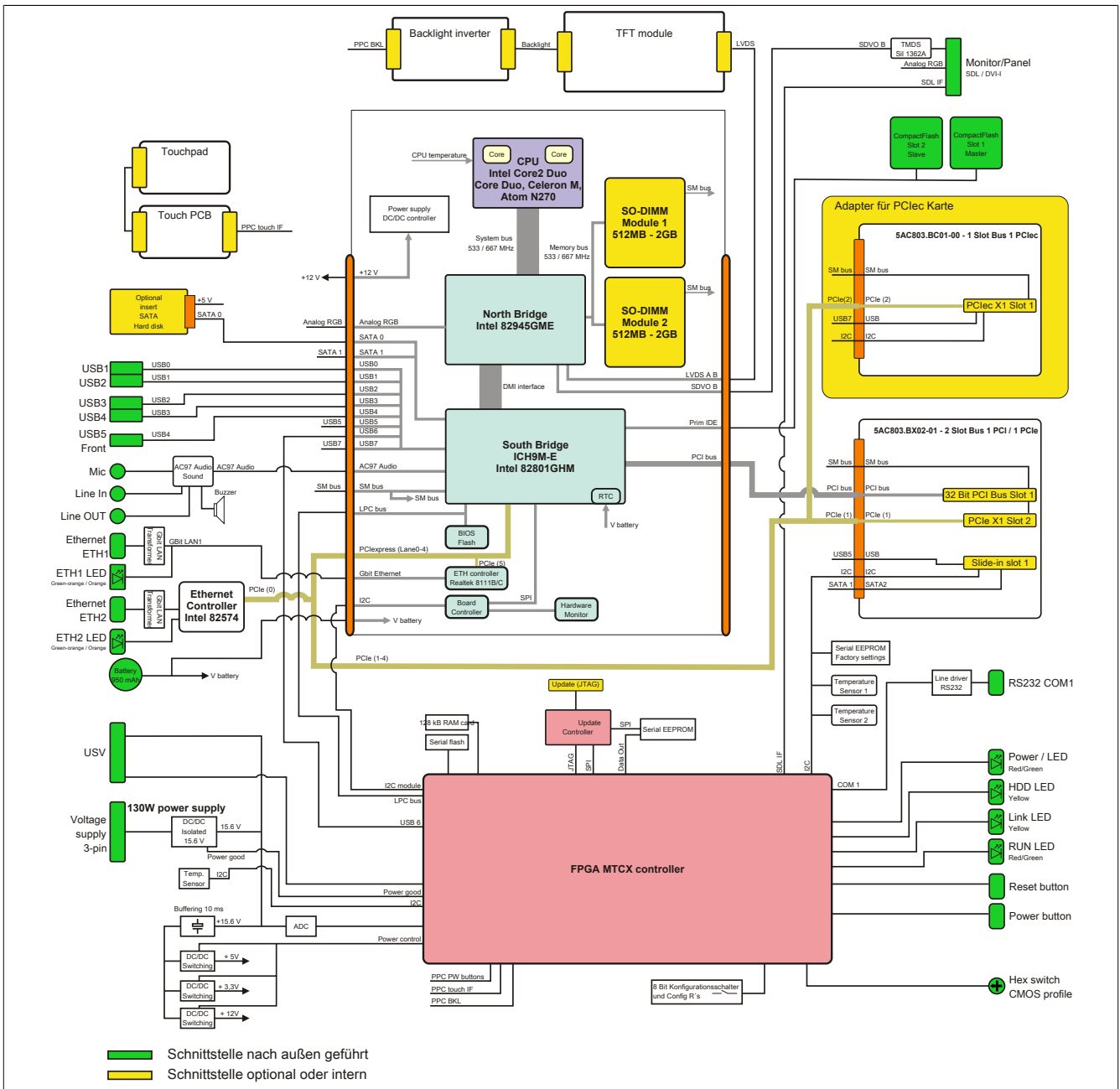

Figure 8: Block diagram with bus unit 5AC803.BX02-01

2.5 Serial number sticker

A unique serial number sticker with a barcode (Code 128) is affixed to each B&R device for identification purposes. This serial number represents all of the individual components built into the system (model number, name, revision, serial number, delivery date and duration of warranty).



Figure 9: Serial number sticker (back)

This information can also be found on the B&R website by entering the serial number of the complete system in the search field tab (after selecting the "Serial number" option) at the top of the website (www.br-automation.com). The search provides a detailed list of installed components.

A screenshot of the B&R website's search interface. The search bar contains the serial number "AF210168454". The "Serialnummer" tab is selected. The search results show a list of installed components.

Serial number entered h z.B.: AF210168454

wecheln auf den Tab „Serialnummer“

SERIAL	MATERIAL	REVISION	LIEFERUNG	GEWAHRLEISTUNGSENDE
B15B0168428	5PCB220198.001-00	C0	*NV	*N/A
AF210168454	5PC820.1505-00	A2	*NV	*N/A
A3CA0168483	5PC800.B945-00	C0	*NV	*N/A
A3E50168807	5MMD0R.0512-01	B0	*NV	*N/A
AF270168430	5AC803.SX01-00	A0	*NV	*N/A
AF290168515	5AC803.BX01-00	A5	*NV	*N/A
AF2E0168475	5AC803.BC02-00	A5	*NV	*N/A
AF2D0168456	5AC803.BC01-00	A5	*NV	*N/A
AF300168466	5AC803.FA02-00	A0	*NV	*N/A
AF230168467	5AC803.HS00-00	A5	*NV	*N/A

List of installed components shown after searching for a serial nu

Figure 10: Example of serial number search

2.6 Device interfaces and slots

2.6.1 +24 VDC power supply

The 3-pin male connector required for the power supply interface is not included in delivery. It can be ordered from B&R using model number 0TB103.9 (screw clamp) or 0TB103.91 (cage clamp).

The pinout is listed in the following table and printed on the PPC800 housing. The supply voltage is protected internally by a soldered fuse (15 A, fast-acting) to prevent damage to the device in the event of an overload (fuse replacement necessary) or if the voltage supply is connected incorrectly (reverse polarity protection - fuse replacement not necessary). The device must be returned to B&R for repairs if the fuse is blown in the event of an error.

Power supply	
Protected against reverse polarity	
Pin	Description
1	+
2	Functional ground
3	-
Model number	Short description
Terminal blocks	
0TB103.9	Male connector 24 V 5.08 3-pin screw clamps
0TB103.91	Male connector 24 V 5.08 3-pin cage clamps

Buchse, 3-polig, male

+24 VDC power supply



Table 11: 24 VDC power supply interface

2.6.1.1 Grounding

Caution!

Functional ground (pin 2 of power supply and ground connection) must be kept as short as possible and connected to the largest possible wire cross section at the central grounding point (e.g. the control cabinet or system).

The ground connection is located at the top right on the back of the PPC800 system.

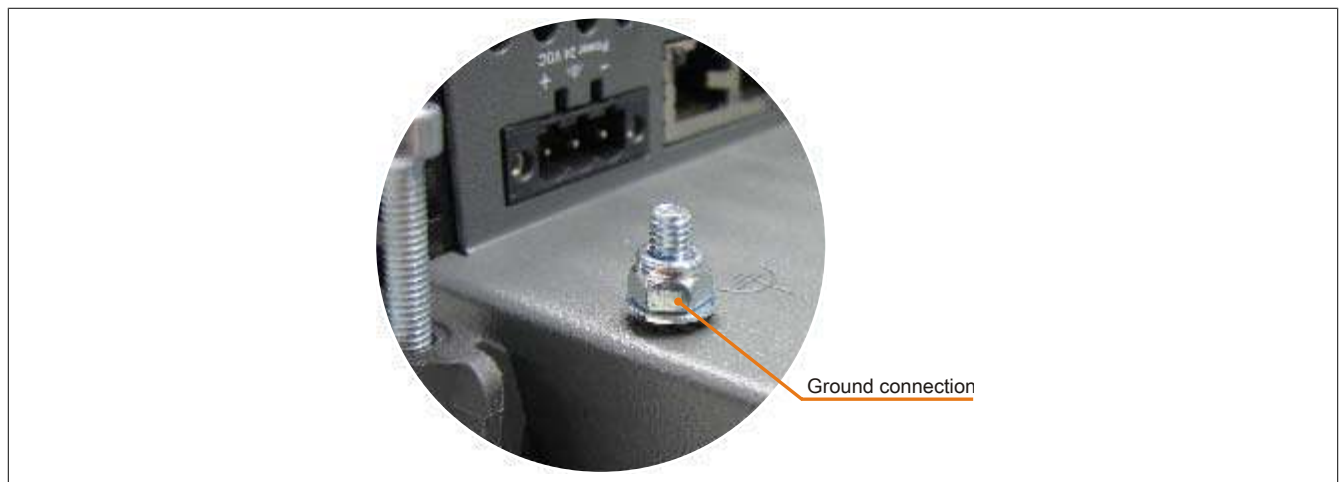

Figure 11: Ground connection

The M4 self-locking nut must be used, for example, to fasten a copper strip to a central grounding point in the control cabinet or system where the PPC800 is installed. The largest possible conductor cross section should be used (at least 2.5 mm²).

2.6.2 Monitor/Panel interface

Monitor/Panel interface - SDL (Smart Display Link) / DVI	
The following is an overview of the video signals available on the monitor/panel output. For details, see the technical data for the CPU board being used.	
CPU board	Video signals with all system unit variants
5PC800.B945-00 / -10	SDL, DVI, RGB
5PC800.B945-01 / -11	SDL, DVI, RGB
5PC800.B945-02 / -12	SDL, DVI, RGB
5PC800.B945-03 / -13	SDL, DVI, RGB
5PC800.B945-04 / -14	SDL, DVI, RGB
5PC800.B945-05	SDL, DVI, RGB

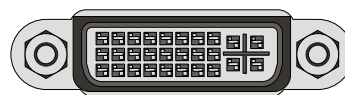

Table 12: Monitor/Panel interface - SDL, DVI, RGB

Information:

Hot-plugging of display devices on the monitor/panel interface is not supported. The male monitor/panel connector is specified for 100 connection cycles.

Information:

The RGB interface uses an analog signal; the line length depends on the resolution and prevailing environmental conditions. This interface is therefore only recommended for service purposes.

2.6.2.1 Pinout

Pin	Assignment	Description	Pin	Assignment	Description
1	TMDS data 2-	DVI lane 2 (negative)	16	HPD	Hot plug detect
2	TMDS data 2+	DVI lane 2 (positive)	17	TMDS data 0-	DVI lane 0 (negative)
3	TMDS data 2/4 SHIELD	Shield for data pair 2 and 4	18	TMDS data 0+	DVI lane 0 (positive)
4	SDL-	SDL lane (negative)	19	TMDS Data 0/ XUSB1 SHIELD	Shield for data pair 0 and USB1
5	SDL+	SDL lane (positive)	20	XUSB1-	USB lane 1 (negative)
6	DDC clock	DDC-based control signal (clock)	21	XUSB1+	USB lane 1 (positive)
7	DDC data	DDC-based control signal (data)	22	TMDS clock shield	Shield for clock pair
8	ANALOG VERT SYNC	Analog vertical synchronization	23	TMDS clock+	DVI clock (positive)
9	TMDS data 1-	DVI lane 1 (negative)	24	TMDS clock -	DVI clock (negative)
10	TMDS DATA 1+	DVI lane 1 (negative) HDMI clock (positive)	C1	ANALOG RED	Analog red
11	TMDS DATA 1/ XUSB0 SHIELD	Shield for data pair 1 and USB0	C2	ANALOG GREEN	Analog green
12	XUSB0-	USB lane 0 (negative)	C3	ANALOG BLUE	Analog blue
13	XUSB0+	USB lane 0 (positive)	C4	ANALOG HORZ SYNC	Analog horizontal synchronization
14	+5 V power ¹⁾	+5 V power supply	C5	ANALOG GND	Analog ground (return for R, G and B signals)
15	Ground (return for +5 V, HSync and VSync)	Ground			

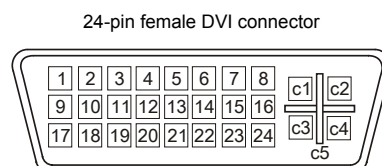

Table 13: DVI interface - Pinout

1) Protected internally by a multifuse.

2.6.2.2 USB communication in SDL and DVI mode

Information:

The USB transfer rate is limited to USB 1.1 in SDL mode.

In DVI mode, the maximum USB transfer rate is determined by the USB interface and USB hub on the display device.

2.6.2.3 Cable lengths and resolutions for SDL transmission

The following table lists the relationship between segment lengths and maximum resolution depending on the SDL cable being used:

SDL cable Segment length [m]	Resolution						
	VGA 640 x 480	SVGA 800 x 600	XGA 1024 x 768	HD 1366 x 768	SXGA 1280 x 1024	UXGA 1600 x 1200	FHD 1920 x 1080
1.8	5CASDL.0018-00	5CASDL.0018-00	5CASDL.0018-00	5CASDL.0018-00	5CASDL.0018-00	5CASDL.0018-00	5CASDL.0018-00
	5CASDL.0018-01	5CASDL.0018-01	5CASDL.0018-01	5CASDL.0018-01	5CASDL.0018-01	5CASDL.0018-01	5CASDL.0018-01
	5CASDL.0018-03	5CASDL.0018-03	5CASDL.0018-03	5CASDL.0018-03	5CASDL.0018-03	5CASDL.0018-03	5CASDL.0018-03
5	5CASDL.0050-00	5CASDL.0050-00	5CASDL.0050-00	5CASDL.0050-00	5CASDL.0050-00	5CASDL.0050-00	5CASDL.0050-00
	5CASDL.0050-01	5CASDL.0050-01	5CASDL.0050-01	5CASDL.0050-01	5CASDL.0050-01	5CASDL.0050-01	5CASDL.0050-01
	5CASDL.0050-03	5CASDL.0050-03	5CASDL.0050-03	5CASDL.0050-03	5CASDL.0050-03	5CASDL.0050-03	5CASDL.0050-03
10	5CASDL.0100-00	5CASDL.0100-00	5CASDL.0100-00	5CASDL.0100-00	5CASDL.0100-00	5CASDL.0100-00	5CASDL.0100-00
	5CASDL.0100-01	5CASDL.0100-01	5CASDL.0100-01	5CASDL.0100-01	5CASDL.0100-01	5CASDL.0100-01	5CASDL.0100-01
	5CASDL.0100-03	5CASDL.0100-03	5CASDL.0100-03	5CASDL.0100-03	5CASDL.0100-03	5CASDL.0100-03	5CASDL.0100-03
15	5CASDL.0150-00	5CASDL.0150-00	5CASDL.0150-00	5CASDL.0150-00	5CASDL.0150-00	-	-
	5CASDL.0150-01	5CASDL.0150-01	5CASDL.0150-01	5CASDL.0150-01	5CASDL.0150-01	-	-
	5CASDL.0150-03	5CASDL.0150-03	5CASDL.0150-03	5CASDL.0150-03	5CASDL.0150-03	-	5CASDL.0150-03
20	5CASDL.0200-00	5CASDL.0200-00	5CASDL.0200-00	5CASDL.0200-00	5CASDL.0200-00	-	-
	5CASDL.0200-03	5CASDL.0200-03	5CASDL.0200-03	5CASDL.0200-03	5CASDL.0200-03	-	5CASDL.0200-03
25	5CASDL.0250-00	5CASDL.0250-00	5CASDL.0250-00	5CASDL.0250-00	-	-	-
	5CASDL.0250-03	5CASDL.0250-03	5CASDL.0250-03	5CASDL.0250-03	-	-	-
30	5CASDL.0300-00	5CASDL.0300-00	-	-	-	-	-
	5CASDL.0300-03	5CASDL.0300-03	5CASDL.0300-13	5CASDL.0300-13	5CASDL.0300-13	-	5CASDL.0300-13
40	5CASDL.0400-13	5CASDL.0400-13	5CASDL.0400-13	5CASDL.0400-13	5CASDL.0400-13	-	5CASDL.0400-13

Table 14: Cable lengths and resolutions for SDL transmission

2.6.2.4 Cable lengths and resolutions for DVI transmission

The following table lists the relationship between segment lengths and maximum resolution depending on the SDL cable being used:

DVI cables Segment length [m]	Resolution						
	VGA 640 x 480	SVGA 800 x 600	XGA 1024 x 768	HD 1366 x 768	SXGA 1280 x 1024	UXGA 1600 x 1200	FHD 1920 x 1080
1.8	5CADVI.0018-00	5CADVI.0018-00	5CADVI.0018-00	5CADVI.0018-00	5CADVI.0018-00	5CADVI.0018-00	5CADVI.0018-00
5	5CADVI.0050-00	5CADVI.0050-00	5CADVI.0050-00	5CADVI.0050-00	5CADVI.0050-00	5CADVI.0050-00	5CADVI.0050-00

Table 15: Cable lengths and resolutions for DVI transmission

The maximum cable length for DVI transfer is limited to 5 m due to the USB specification.

2.6.3 COM1 serial interface

COM1 serial interface ¹⁾	
RS232	
Type	RS232, modem-capable, not electrically isolated
UART	16550-compatible, 16-byte FIFO
Transfer rate	Max. 115 kbaud
Cable length	Max. 15 meters
Pin	Assignment
1	DCD
2	RXD
3	TXD
4	DTR
5	GND
6	DSR
7	RTS
8	CTS
9	RI

DSUB-Buchse, 9-polig, male

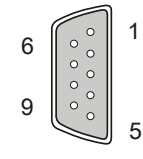

Table 16: COM1 - Pinout

1) The interfaces, etc. available on the device or module have been numbered as such for easy identification. This numbering may differ from that used by the particular operating system.

2.6.4 Ethernet 1 interface (ETH1)

This Ethernet controller is integrated in the CPU board and connected to external devices via the system unit.

Ethernet 1 interface (ETH1 ¹⁾)		
Controller	Realtek RTL8111B/C ²⁾	
Cabling	S/STP (Cat 5e)	
Transfer rate	10/100/1000 Mbit/s ³⁾	
Cable length	Max. 100 m (min. Cat 5e)	
Speed LED	On	Off
Green	100 Mbit/s	10 Mbit/s ⁴⁾
Orange	1000 Mbit/s	-
Link LED	On	Off
Orange	Link (Ethernet network connection available)	Activity (blinking) (data transfer in progress)

Female RJ45 connector

1

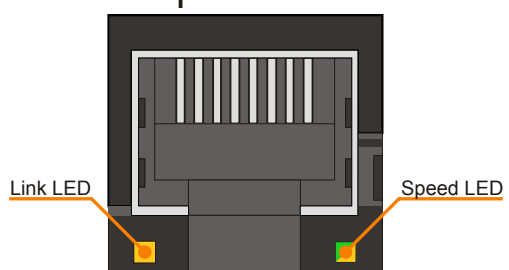

Table 17: Ethernet interface (ETH1)

- 1) The interfaces, etc. available on the device or module have been numbered as such for easy identification. This numbering may differ from that used by the particular operating system.
- 2) The Realtek 8111B is integrated in CPU boards 5PC800.B945-00, -01, -02, -03 and -04.
The Realtek 8111C is integrated in CPU boards 5PC800.B945-05 and 5PC800.B945-10, -11, -12, -13 and -14.
- 3) Switching takes place automatically.
- 4) The 10 Mbit/s transfer speed / connection only exists if the Link LED is also lit at the same time.

Driver support

A special driver is required in order to operate the Realtek RTL8111B/C Ethernet controller. Drivers for approved operating systems are available in the Downloads section of the B&R website (www.br-automation.com).

Information:

Required drivers can only be downloaded from the B&R website, not from manufacturer websites.

Dieser Ethernet-Controller ist im Basisboard integriert und wird über die Systemeinheit nach außen geführt.

1)		
Controller	Intel 82574	
Cabling	S/STP (Cat 5e)	
Transfer rate	10/100/1000 Mbit/s ²⁾	
Cable length	Max. 100 m (min. Cat 5e)	
Speed LED	On	Off
Green	100 Mbit/s	10 Mbit/s ³⁾
Orange	1000 Mbit/s	-
Link LED	On	Off
Orange	Link (Ethernet network connection available)	Activity (blinking) (data transfer in progress)

RJ45-Buchse, female

1

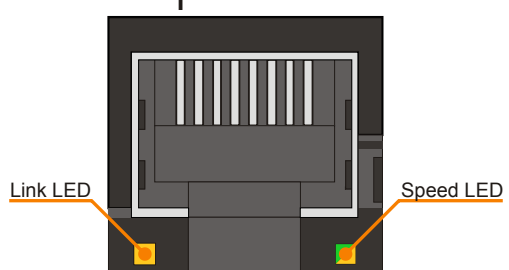

Table 18: Ethernet-Schnittstelle (ETH2)

- 1) The interfaces, etc. available on the device or module have been numbered as such for easy identification. This numbering may differ from that used by the particular operating system.
- 2) Switching takes place automatically.
- 3) The 10 Mbit/s transfer speed / connection only exists if the Link LED is also lit at the same time.

Driver support

A special driver is required in order to operate the Intel 82574 Ethernet controller. Drivers for approved operating systems are available in the Downloads section of the B&R website (www.br-automation.com).

Information:

Required drivers can only be downloaded from the B&R website, not from manufacturer websites.

The PPC800 features a USB 2.0 (Universal Serial Bus) host controller with multiple USB ports, 5 of which are accessible externally for the user.

Warning!

Peripheral USB devices can be connected to the USB interfaces on this device. Due to the vast number of USB devices available on the market, B&R cannot guarantee their performance. All USB devices provided by B&R are guaranteed to function properly.

Caution!

Because this interface is designed according to general PC specifications, extreme care should be exercised with regard to EMC, cable routing, etc.

USB1,2,3,4

Universal Serial Bus (USB1, USB2, USB3, USB4 ¹⁾)	
Type	USB 2.0
Design	Type A
Transfer rate	Low speed (1.5 Mbit/s), full speed (12 Mbit/s), high speed (480 Mbit/s)
Current load ²⁾ USB1, USB3 USB2, USB4	Max. 1 A Max. 500 mA
Cable length	Max. 5 m (without hub)

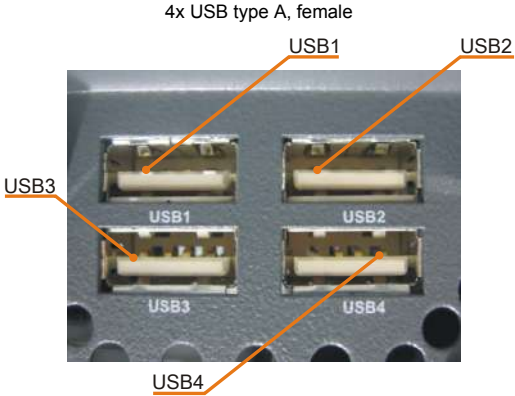

Table 19: USB1-, USB2-, USB3-, USB4-Schnittstellen

- 1) The interfaces, etc. available on the device or module have been numbered as such for easy identification. This numbering may differ from that used by the particular operating system.
- 2) Each USB port is protected by a maintenance-free "USB current limiting circuit breaker" (max. 500 mA or 1 A).

USB5

Universal Serial Bus (USB5) ¹⁾	
Type	USB 2.0
Design	Type A
Transfer rate	Low speed (1.5 Mbit/s), full speed (12 Mbit/s), high speed (480 Mbit/s)
Current load ²⁾ USB5	Max. 1 A
Cable length	Max. 5 m (without hub)

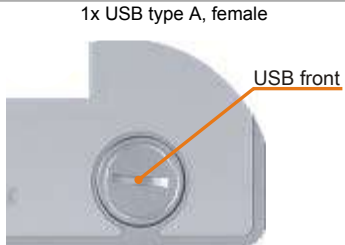

Table 20: USB5-Schnittstelle

- 1) The interfaces, etc. available on the device or module have been numbered as such for easy identification. This numbering may differ from that used by the particular operating system.
- 2) Each USB port is protected by a maintenance-free "USB current-limiting circuit breaker" (max. 1 A).

2.6.7 CompactFlash slot 1

This CompactFlash slot is a standard component of a PPC800 system and internally connected with the chipset via IDE PATA. Type I CompactFlash cards are supported.

CompactFlash slot (CF1)	
Connection	PATA master
CompactFlash Type	Type I
Model number	Short description
CompactFlash	
5CFCRD.0512-06	CompactFlash 512 MB B&R
5CFCRD.1024-06	CompactFlash 1024 MB B&R
5CFCRD.2048-06	CompactFlash 2048 MB B&R
5CFCRD.4096-06	CompactFlash 4096 MB B&R
5CFCRD.8192-06	CompactFlash 8192 MB B&R
5CFCRD.016G-06	CompactFlash 16 GB B&R
5CFCRD.032G-06	CompactFlash 32 GB B&R
5CFCRD.0064-03	CompactFlash 64 MB WD
5CFCRD.0128-03	CompactFlash 128 MB WD
5CFCRD.0256-03	CompactFlash 256 MB WD
5CFCRD.0512-03	CompactFlash 512 MB WD
5CFCRD.1024-03	CompactFlash 1024 MB WD
5CFCRD.2048-03	CompactFlash 2048 MB WD
5CFCRD.4096-03	CompactFlash 4096 MB WD
5CFCRD.8192-03	CompactFlash 8192 MB WD



Table 21: CompactFlash slot (CF1)

Warning!

An- und Abstecken der CompactFlash-Karte darf nur in spannungslosem Zustand erfolgen!

2.6.8 CompactFlash slot 2

This CompactFlash slot is a standard component of a PPC800 system and internally connected with the chipset via IDE PATA. Type I CompactFlash cards are supported.

CompactFlash slot (CF2)	
Connection	PATA slave
CompactFlash Type	Type I
Model number	Short description
CompactFlash	
5CFCRD.0512-06	CompactFlash 512 MB B&R
5CFCRD.1024-06	CompactFlash 1024 MB B&R
5CFCRD.2048-06	CompactFlash 2048 MB B&R
5CFCRD.4096-06	CompactFlash 4096 MB B&R
5CFCRD.8192-06	CompactFlash 8192 MB B&R
5CFCRD.016G-06	CompactFlash 16 GB B&R
5CFCRD.032G-06	CompactFlash 32 GB B&R
5CFCRD.0064-03	CompactFlash 64 MB WD
5CFCRD.0128-03	CompactFlash 128 MB WD
5CFCRD.0256-03	CompactFlash 256 MB WD
5CFCRD.0512-03	CompactFlash 512 MB WD
5CFCRD.1024-03	CompactFlash 1024 MB WD
5CFCRD.2048-03	CompactFlash 2048 MB WD
5CFCRD.4096-03	CompactFlash 4096 MB WD
5CFCRD.8192-03	CompactFlash 8192 MB WD



Table 22: CompactFlash slot (CF2)

Warning!

An- und Abstecken der CompactFlash-Karte darf nur in spannungslosem Zustand erfolgen!

2.6.9 MIC, Line IN, Line OUT

All PPC800 systems include an HDA-compatible sound chip with access to the MIC, Line IN and Line OUT channels from the outside.

MIC, Line IN, Line OUT		3.5 mm jack, female
Controller	Realtek ALC 662	
MIC	Connection of a mono microphone with a 3.5 mm jack	
Line IN	Stereo Line IN signal supplied via a 3.5 mm jack	
Line OUT	Connection of a stereo playback device (e.g. amplifier) via a 3.5 mm jack	

Table 23: MIC, Line IN, Line OUT

Driver support

A special driver is required in order to operate the audio controller. Drivers for approved operating systems are available in the Downloads section of the B&R website (www.br-automation.com).

Information:

Required drivers can only be downloaded from the B&R website, not from manufacturer websites.

2.6.10 Add-on UPS slot

An optional Automation PC add-on UPS module can be installed in this slot.

Add-on UPS slot		
Pinout with installed add-on UPS module		
1	+	
2	+	
3	-	
4	-	
5	NTC (for battery temperature measurement)	
6	NTC (for battery temperature measurement)	
Model number	Short description	
Uninterruptible power supply		
5AC600.UPSI-00	Add-on UPS module	
5AC600.UPSB-00	Battery unit 5 Ah	
5CAUPS.0005-00	UPS cable 0.5 m	
5CAUPS.0030-00	UPS cable 3 m	

Table 24: Add-on UPS slot

For additional information about the UPS module, see "Accessories" on page 270.

2.6.11 Power button

Auf Grund der vollen ATX-Netzteilunterstützung besitzt der Power Taster verschiedenste Funktionalitäten.

Power button	
<p>Der Power Taster verhält sich wie z.B. der Netzschalter bei aktuellen Desktop PCs mit ATX-Netzteil:</p> <p>Pressing the power button does not reset the MTCX processor.</p>	

Table 25: Power button

2.6.12 Reset button

Reset button	
<p>Pushing the reset button triggers a hardware and PCI reset. The PPC800 is restarted (cold restart).</p> <p>Pressing the reset button does not reset the MTCX processor.</p>	

Table 26: Reset button

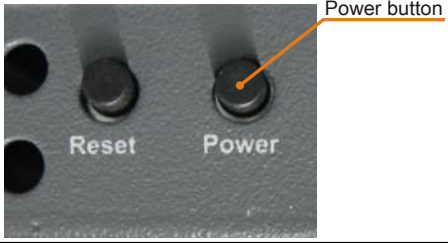
Warning!

A system reset can result in lost data!

2.6.13 LED status indicators

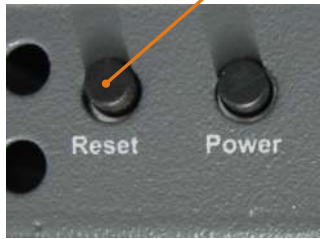
LED status indicators are located on the back of the system unit.

LED status indicators			
LED	Color	Status	Description
Power	Green	On	Supply voltage OK
	Red	On	System in standby mode (S5: Soft-off mode, S4: Hibernation mode suspend-to-disk or S3: Suspend-to-RAM)
	Orange ¹⁾	On	Supply voltage not OK, system operating on battery power
	Red/Green	Blinking	Service function for MTCX upgrade: A red/green blinking power LED indicates a faulty or incomplete MTCX upgrade. The MTCX runs using the firmware version installed when delivered. This could be caused by a power failure during an MTCX upgrade. An MTCX upgrade must be performed again.
HDD	Yellow	On	Indicates IDE drive access (CF, HDD, CD, etc.)
Link	Yellow	On	Indicates an active SDL connection on the monitor/panel interface
		Blinking	Indicates that an active SDL connection has been interrupted by a loss of power to the display unit
Run	Green	On	Application running
		Off	Application not running

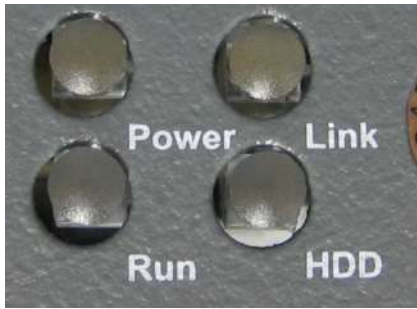

Table 27: LED status indicators

1) Only lit when an add-on UPS module is installed.

2.6.14 CMOS profile switch

CMOS profile switch	
Different BIOS default value profiles can be specified using the 16-position CMOS profile switch.	
Switch position	Description
0	Profile 0: Reserved for default profile
1	Profile 1: Optimized for system units 5PC810.SX01-00, 5PC810.SX02-00 and 5PC810.SX03-00
2	Profile 2: Optimized for system unit 5PC810.SX05-00
3	Profile 3: Optimized for system units 5PC820.SX01-00 and 5PC820.SX01-01
4	Profile 4: Reserved
5	Profile 5: Optimized for system units 5PC820.1505-00 and 5PC820.1906-00



Table 28: CMOS profile switch

Information:

The factory default switch position represents the optimal BIOS default values for this system and should therefore not be changed.

The position of the CMOS profile switch is displayed in BIOS Setup and in the B&R ADI Control Center.

2.6.15 Battery

The lithium battery (3 V, 950 mAh) buffers the internal real-time clock (RTC) and individually stored BIOS settings. It is located behind the black cover on the front of the device. The battery's buffer lifespan is at least 2½ years (at 50°C, 8.5 µA for the components being supplied and a self-discharge of 40%). The battery has a limited service life and should be replaced regularly (after the specified service life at the latest).

Battery	
Battery Type	Renata 950 mAh
Removable	Yes, accessible from the outside
Service life	2½ years ¹⁾
Model number	Short description
	Batteries
0AC201.91	Lithium batteries, 4 pcs., 3 V / 950 mAh, button cell
4A0006.00-000	Lithium battery, 1 pc., 3 V / 950 mAh, button cell

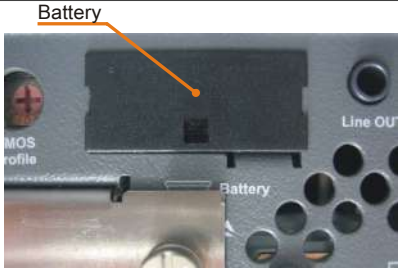

Table 29: Battery

1) At 50°C, 8.5 µA of the supplied components and a self-discharge of 40%.

Evaluating the battery status

The status of the battery is determined immediately after the device is started and subsequently checked by the system every 24 hours. During this measurement, the battery is subjected to a brief load (approximately 1 second) and then evaluated. Once determined, the battery status is displayed in BIOS (Advanced - OEM features - System board features - Voltage values) and in the B&R Control Center (ADI driver); it can also be read in a customer application using the ADI library.

Battery status	Function
N/A	The hardware or firmware being used is too old and does not support reading the battery status.
GOOD	Data buffering is intact.
BAD	From the point when battery capacity is recognized as insufficient (BAD), data buffering is intact for approximately another 500 hours.

Table 30: Battery status

From the point when battery capacity is recognized as insufficient, data buffering is intact for approximately another 500 hours. When replacing the battery, data is buffered for approximately 10 minutes by a gold leaf capacitor.

2.6.16 Slide-in compact slot

The internal connection between the slide-in compact slot and the chipset is made via SATA I.

Slide-in compact slot	
Connection	SATA I
Model number	Short description
	Adapters
5AC803.BC02-00	PPC800 1 slide-in compact adapter
	Drives
5AC801.HDDI-00	40 GB slide-in compact SATA hard disk, 24/7 operation with extended temperature range. Note: Please see the manual for information about using this hard disk.
5AC801.HDDI-02	160 GB SATA hard disk, slide-in compact, 24/7 operation with extended temperature range. Note: Please see the manual for information about using this hard disk.
5AC801.HDDI-03	250 GB slide-in compact SATA hard disk; 24/7 operation. Note: Please see the manual for information about using this hard disk.
5AC801.HDDI-04	500 GB slide-in compact SATA hard disk; 24/7 operation. Note: Please see the manual for information about using this hard disk.
5AC801.SSDI-00	32 GB SATA SSD (SLC), slide-in compact
5AC801.SSDI-01	60 GB SATA SSD (MLC), slide-in compact
5AC801.SSDI-02	180 GB SATA SSD (MLC), slide-in compact
5AC801.SSDI-03	60 GB SATA SSD (MLC), slide-in compact
5AC801.SSDI-04	128 GB SATA SSD (MLC), slide-in compact
5AC801.SSDI-05	256 GB SATA SSD (MLC), slide-in compact



Table 31: Slide-in compact slot

Information:

The adapter 5AC803.BC02-00 is required for the use of slide-in compact drives.

Information:

The SATA I interface allows disks to be replaced during operation (hot plugging). In order to take advantage of this capability, this feature must be supported by the operating system.

2.6.17 PCIe slot (Card slot)

PCIec slot	
Model number	Short description
	Adapters
5AC803.BC01-00	PPC800 1 PCI Express compact adapter
	Plug-in cards
5ACPCC.ETH0-00	Compact PCIe Ethernet card 1x 10/100/1000
5ACPCC.MPL0-00	PCIec POWERLINK card, 2 POWERLINK interfaces, 512 kB SRAM



Table 32: PCIe slot

Information:

The adapter 5AC803.BC01-00 is required to use PCIe plug-in cards.

Information:

Only B&R PCIe cards that have been specially designed for the Automation PC 820 and Panel PC 800 can be used.

For more information, see "PCIec plug-in cards" on page 78.

3 Individual components

3.1 System units

3.1.1 5PC820.1505-00

3.1.1.1 General information

- 15" TFT XGA color display
- Analog resistive touch screen
- Robust design
- Compact installation depth
- Fanless operation
- 1 optional PCI Express compact slot
- 1 optional slide-in compact slot
- Optional PCI and PCIe slots and optional slide-in drives, optional expansions available

3.1.1.2 Order data

Model number	Short description	Figure
System units		
5PC820.1505-00	Panel PC 820 15" XGA TFT display with touch screen (resistive); connections for 1x RS232, 5x USB 2.0, Smart Display Link/DVI/Monitor, 2x Ethernet 10/100/1000, HDA sound, add-on UPS slot, expandable with 1 or 2 PCI / PCI Express slots, optional CompactPCI Express and slide-in compact slot; IP65 protection (front); order 24 VDC connector for supply voltage separately (screw clamp: 0TB103.9; cage clamp: 0TB103.91)	
Required accessories		
CPU boards		
5PC800.B945-05	Intel Atom N270 CPU board, 1.6 GHz, single core, 533 MHz FSB, 512 kB L2 cache; 945GME chipset; 2 slots for SO-DIMM DDR2 modules (max. total of 3 GB), Realtek RTL8111C Ethernet controller	
5PC800.B945-10	Intel Core Duo L2400 CPU board, 1.66 GHz, dual core, 667 MHz FSB, 2 MB L2 cache; 945GME chipset; 2 slots for SO-DIMM DDR2 modules (max. total of 3 GB), Realtek RTL8111C Ethernet controller	
5PC800.B945-11	Intel Core2 Duo L7400 CPU board, 1.5 GHz, dual core, 667 MHz FSB, 2 MB L2 cache; 945GME chipset; 4 slots for SO-DIMM DDR2 modules (max. total of 3 GB), Realtek RTL8111C Ethernet controller	
5PC800.B945-12	Intel Core2 Duo U7500 CPU board, 1.06 GHz, dual core, 533 MHz FSB, 2 MB L2 cache; 945GME chipset; 2 slots for SO-DIMM DDR2 modules (max. total of 3 GB), Realtek RTL8111C Ethernet controller	
5PC800.B945-13	Intel Celeron M 423 CPU board, 1.06 GHz, single core, 533 MHz FSB, 1 MB L2 cache; 945GME chipset; 2 slots for SO-DIMM DDR2 modules (max. total of 3 GB), Realtek RTL8111C Ethernet controller	
5PC800.B945-14	Intel Core2 Duo T7400 CPU board, 2.16 GHz, dual core, 667 MHz FSB, 2 MB L2 cache; 945GME chipset; 4 slots for SO-DIMM DDR2 modules (max. total of 3 GB), Realtek RTL8111C Ethernet controller	
Terminal blocks		
0TB103.9	Connector, 24 VDC, 3-pin female, 3.31 mm ² screw clamp, protected against vibration by the screw flange	
0TB103.91	Connector, 24 VDC, 3-pin female, 3.31 mm ² cage clamp, protected against vibration by the screw flange	
Main memory		
5MMDDR.0512-01	SO-DIMM DDR2 RAM 512 MB PC2-5300	
5MMDDR.1024-01	SO-DIMM DDR2 RAM 1024 MB PC2-5300	
5MMDDR.2048-01	SO-DIMM DDR2 RAM 2048 MB PC2-5300	
Heat sink		
5AC803.HS00-00	PPC800 heat sink for CPU boards with L2400, L7400, U7500 or Celeron M 423 dual-core processor	
5AC803.HS00-01	PPC800 heat sink for CPU boards with T7400, T9400 or P8400 dual-core processor	
5AC803.HS00-02	PPC800 heat sink for CPU board with Atom processor N270	
Fan kit		
5AC803.FA01-00	PPC800 fan kit for system units without an expansion	
Optional accessories		
Adapters		

Table 33: 5PC820.1505-00 - Order data

Model number	Short description	Figure
5AC803.BC01-00	1 compact PCI Express PPC800 adapter	
5AC803.BC02-00	1 compact slide-in PPC800 adapter	
	Bus units	
5AC803.BX01-00	PPC800 bus; 1 PCI, 1 slide-in slot	
5AC803.BX01-01	PPC800 bus; 1 PCI Express, 1 slide-in slot	
5AC803.BX02-00	PPC800 bus; 2 PCI, 1 slide-in slot	
5AC803.BX02-01	PPC800 bus; 1 PCI, 1 PCI Express, 1 slide-in slot	
	Plug-in cards	
5ACPCC.ETH0-00	PCIe Ethernet card 1x 10/100/1000 For APC820 and PPC800.	
5ACPCC.MPL0-00	PCIe POWERLINK card, 2 POWERLINK interfaces, 512 kB SRAM; for APC820 and PPC800.	
	Expansions	
5AC803.SX01-00	PPC800 expansion; 1 PCI/PCI Express and 1 slide-in slot (bus 5AC803.BX01-00 or 5AC803.BX01-01 required)	
5AC803.SX02-00	PPC800 expansion; 2 PCI/PCI Express and 1 slide-in slot (bus 5AC803.BX02-00 or 5AC803.BX02-01 required)	
	Drives	
5AC801.ADAS-00	SATA hard disk adapter for operating a slide-in compact hard disk in a slide-in slot	
5AC801.DVDS-00	DVD-ROM SATA slide-in drive	
5AC801.DVRS-00	DVD-R/RW DVD+R/RW SATA drive, slide-in	
5AC801.HDDI-00	40 GB slide-in compact SATA hard disk, 24/7 operation with extended temperature range. Note: Please see the manual for information about using this hard disk.	
5AC801.HDDI-04	500 GB slide-in compact SATA hard disk; 24/7 operation. Note: Please see the manual for information about using this hard disk.	
5AC801.HDDS-00	40 GB slide-in SATA hard disk; 24/7 operation with extended temperature range. Note: Please see the manual for information about using this hard disk.	
5AC801.SSDI-03	60 GB SATA SSD (MLC), slide-in compact	
5AC801.SSDI-04	128 GB SATA SSD (MLC), slide-in compact	
5AC801.SSDI-05	256 GB SATA SSD (MLC), slide-in compact	
	Fan kit	
5AC803.FA02-00	PPC800 fan kit for system units with expansion 5AC803.SX01-00	
5AC803.FA03-00	PPC800 fan kit for system units with expansion 5AC803.SX02-00	
	Uninterruptible power supply	
5AC600.UPSI-00	UPS module for APC620, APC810, PPC800; for system units 5PC600.SX01-00 (starting with Rev. H0), 5PC600.SX02-00 (starting with Rev. G0), 5PC600.SX02-01 (starting with Rev. H0), 5PC600.SX05-00 (starting with Rev. F0), 5PC600.SX05-01 (starting with Rev. F0), 5PC600.SF03-00 (starting with Rev. A0), 5PC810.SX*. 5PC820.1505-00, 5PC820.1906-00. Order cable (5CAUPS.0005-00 or 5CAUPS.0030-00) and battery unit (5AC600.UPSB-00) separately	

Table 33: 5PC820.1505-00 - Order data

3.1.1.3 Interfaces

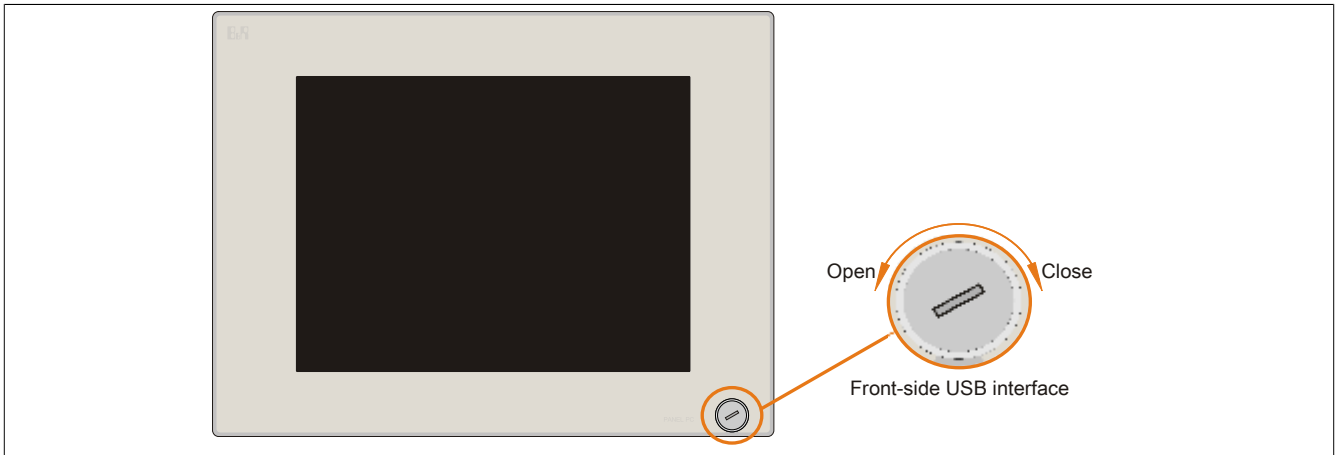

Figure 12: 5PC820.1505-00 - Front view

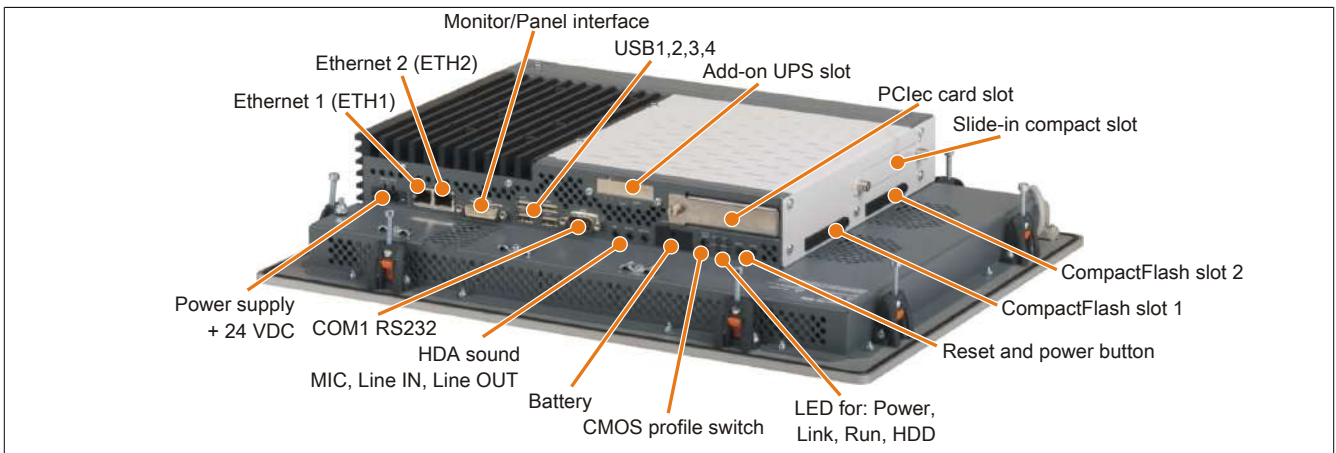

Figure 13: 5PC820.1505-00 - Rear view

Warning!

Do not remove the fastening screws from the heat sink since this component is connected to the processor and chipset via a thermal coupling. If this connection is interrupted, the B&R Industrial PC must be sent back to the factory for repair. Removing the fastening screws (protected by a seal) voids all warranty.

During operation, surface temperatures of the heat sink may reach 70°C ("hot surface" warning).

3.1.1.4 Technical data

Product ID	5PC820.1505-00	
Revision	C0	F0
General information		
LEDs	Power, HDD, Link, Run	
B&R ID code	0xAF21	
Battery		
Type	Renata 950 mAh	
Service life	2½ years	
Removable	Yes, accessible from the outside	
Execution	Lithium ion	
Power button	Yes	
Reset button	Yes	
Buzzer	Yes	
Certification		
CE	Yes	
cULus	Yes	
GOST-R	Yes	
Controller		
Boot loader	BIOS	

Table 34: 5PC820.1505-00, 5PC820.1505-00 - Technical data

Technical data • Individual components

Product ID		5PC820.1505-00	
Power failure logic			
Controller		MTCX ¹⁾	
Buffer time		10 ms	
Graphics			
Controller		Depends on the CPU board being used	
Memory			
Type		Depends on the CPU board being used	
Memory size		Depends on the CPU board being used	
Interfaces			
COM1			
Type		RS232, modem-capable, not electrically isolated	
Execution		9-pin male DSUB connector	
UART		16550-compatible, 16-byte FIFO	
Max. baud rate		115 kbit/s	
CompactFlash slot 1			
Type		Type I	
CompactFlash slot 2			
Type		Type I	
USB			
Quantity		5	
Type		USB 2.0	
Execution		Type A	
Transfer rate		Low speed (1.5 Mbit/s), full speed (12 Mbit/s), high speed (480 Mbit/s)	
Current load		Max. 500 mA or 1 A per connection	
Ethernet			
Quantity		2	
Execution		Shielded RJ45 port	
Transfer rate		10/100/1000 Mbit/s	
Audio			
Type		HDA sound	
Inputs		Microphone, Line IN	
Outputs		Line OUT	
Display			
Type		Color TFT	
Display size		15" (381 mm)	
Colors		16 million	
Resolution		XGA, 1024 x 768 pixels	
Contrast		550:1	800:1
Viewing angles			
Horizontal		Direction R = 60° / Direction L = 60°	Direction R = 80° / Direction L = 80°
Vertical		Direction U = 45° / Direction D = 55°	Direction U = 80° / Direction D = 80°
Backlight			
Type		CCFL	LED
Brightness		250 cd/m ²	350 cd/m ²
Half-brightness time ²⁾		50,000 h	
Touch screen ³⁾			
Type		AMT	
Technology		Analog, resistive	
Controller		Elo, serial, 12-bit	
Transmittance		81% ±3%	
Inserts			
PCI slots			
Quantity		1 or 2 (optional) ⁴⁾	
PCIe slots			
Quantity		1 ⁵⁾	
PCIec slots			
Quantity		Optional ⁶⁾	
Slide-in drives		Depends on the component (on the expansion and bus unit being used)	
Slide-in compact drives		Optional ⁷⁾	
Add-on UPS slot		Yes	
Insert for fan kit		Yes	
Electrical characteristics			
Nominal voltage		24 VDC ±25%	
Nominal current		6 A	
Starting current		Typ. 10 A, max. 50 A for <300 μs	
Power consumption		Depends on the component	
Electrical isolation		Yes	
Operating conditions			
Height of drop		1 m on industrial surfaces (in original packaging)	
EN 60529 protection		Back: IP20 Front: IP65, dust and sprayed water protection	

Table 34: 5PC820.1505-00, 5PC820.1505-00 - Technical data

Product ID	5PC820.1505-00
Environmental conditions	
Temperature	
Operation	Depends on the component
Storage	-20 to 60°C
Transport	-20 to 60°C
Relative humidity	
Operation	10 to 85%, non-condensing
Storage	T ≤ 40°C: 5 to 90%, non-condensing T > 40°C: <90%, non-condensing
Transport	T ≤ 40°C: 5 to 90%, non-condensing T > 40°C: <90%, non-condensing
Vibration	
Operation (continuous)	2 to 9 Hz: 1.75 mm amplitude / 9 to 150 Hz: 0.5 g
Operation (occasional)	2 to 9 Hz: 3.5 mm amplitude / 9 to 150 Hz: 1 g
Storage	2 to 8 Hz: 7.5 mm amplitude / 8 to 200 Hz: 2 g / 200 to 500 Hz: 4 g
Transport	2 to 8 Hz: 7.5 mm amplitude / 8 to 200 Hz: 2 g / 200 to 500 Hz: 4 g
Shock	
Operation	15 g, 11 ms
Storage	30 g, 15 ms
Transport	30 g, 15 ms
Mechanical characteristics	
Housing	
Material	Metal
Front	
Frame	Naturally anodized aluminum
Design	Gray
Panel overlay	
Material	Polyester
Light background	Similar to Pantone 427CV
Gasket	Flat gasket around display front
Dimensions	
Width	435 mm
Height	330 mm
Depth	Depends on the component
Weight	5500 g (depends on the component)

Table 34: 5PC820.1505-00, 5PC820.1505-00 - Technical data

- 1) Maintenance Controller Extended.
- 2) At an ambient temperature of 25°C. Reducing the brightness by 50% can result in an approximately 50% increase in the half-brightness time.
- 3) Touch screen drivers for approved operating systems are available in the Downloads section of the B&R website.
- 4) The PCI slots available depend on the expansion and bus unit being used.
- 5) The PCIe slots available depend on the expansion and bus unit being used.
- 6) Optional with PCIe adapter 5AC803.BC01-00.
- 7) Optional with slide-in compact adapter 5AC803.BC02-00.

3.1.1.5 Dimensions

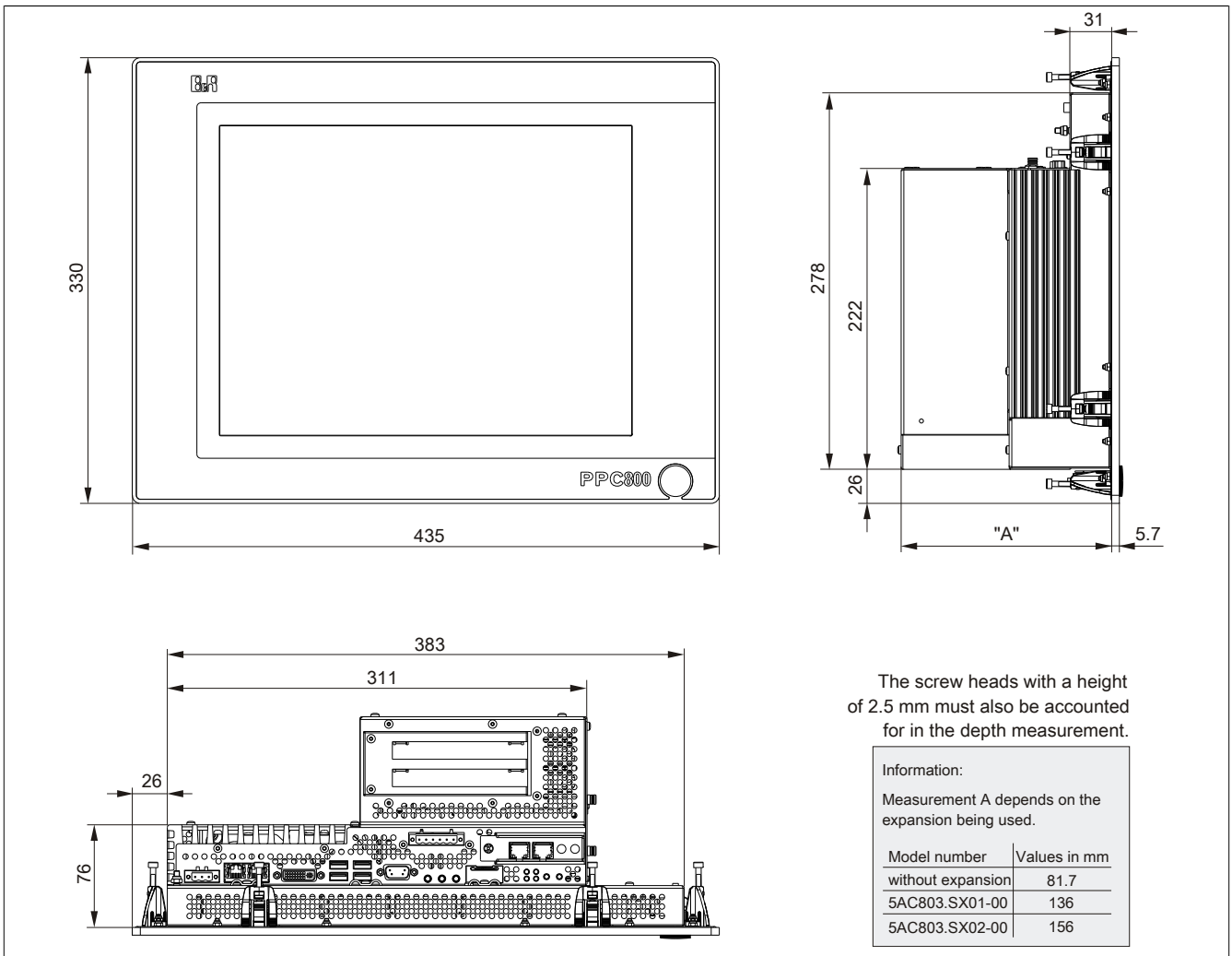

Figure 14: 5PC820.1505 - Dimensions

3.1.1.6 Cutout

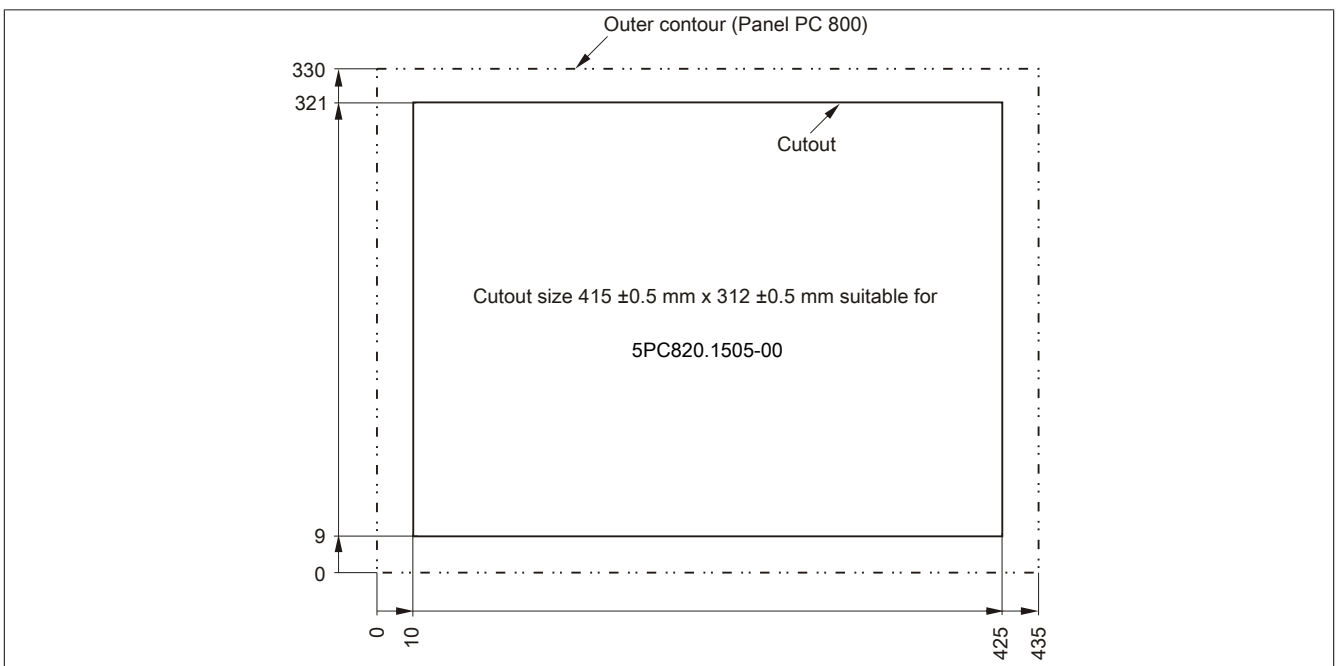

Figure 15: 5PC820.1505-00 - Cutout installation

3.1.2 5PC820.1906-00

3.1.2.1 General information

- 19" TFT SXGA color display
- Analog resistive touch screen
- Robust design
- Compact installation depth
- Fanless operation
- 1 optional PCI Express compact slot
- 1 optional slide-in compact slot
- Optional PCI and PCIe slots and optional slide-in drives, optional expansions available

3.1.2.2 Order data

Model number	Short description	Figure
	System units	
5PC820.1906-00	Panel PC 820 19" SXGA color TFT display with touch screen (resistive); connections for 1x RS232, 5x USB 2.0, Smart Display Link/DVI/Monitor, 2x Ethernet 10/100/1000, HDA sound, add-on UPS slot, expandable with 1 or 2 PCI / PCI Express slots, optional CompactPCI Express and slide-in compact slot; IP65 protection (front); order 24 VDC connector for supply voltage separately (screw clamp: 0TB103.9; cage clamp: 0TB103.91)	
	Required accessories	
	CPU boards	
5PC800.B945-05	Intel Atom N270 CPU board, 1.6 GHz, single core, 533 MHz FSB, 512 kB L2 cache; 945GME chipset; 2 slots for SO-DIMM DDR2 modules (max. total of 3 GB), Realtek RTL8111C Ethernet controller	
5PC800.B945-10	Intel Core Duo L2400 CPU board, 1.66 GHz, dual core, 667 MHz FSB, 2 MB L2 cache; 945GME chipset; 2 slots for SO-DIMM DDR2 modules (max. total of 3 GB), Realtek RTL8111C Ethernet controller	
5PC800.B945-11	Intel Core2 Duo L7400 CPU board, 1.5 GHz, dual core, 667 MHz FSB, 2 MB L2 cache; 945GME chipset; 4 slots for SO-DIMM DDR2 modules (max. total of 3 GB), Realtek RTL8111C Ethernet controller	
5PC800.B945-12	Intel Core2 Duo U7500 CPU board, 1.06 GHz, dual core, 533 MHz FSB, 2 MB L2 cache; 945GME chipset; 2 slots for SO-DIMM DDR2 modules (max. total of 3 GB), Realtek RTL8111C Ethernet controller	
5PC800.B945-13	Intel Celeron M 423 CPU board, 1.06 GHz, single core, 533 MHz FSB, 1 MB L2 cache; 945GME chipset; 2 slots for SO-DIMM DDR2 modules (max. total of 3 GB), Realtek RTL8111C Ethernet controller	
5PC800.B945-14	Intel Core2 Duo T7400 CPU board, 2.16 GHz, dual core, 667 MHz FSB, 2 MB L2 cache; 945GME chipset; 4 slots for SO-DIMM DDR2 modules (max. total of 3 GB), Realtek RTL8111C Ethernet controller	
	Terminal blocks	
0TB103.9	Connector, 24 VDC, 3-pin female, 3.31 mm ² screw clamp, protected against vibration by the screw flange	
0TB103.91	Connector, 24 VDC, 3-pin female, 3.31 mm ² cage clamp, protected against vibration by the screw flange	
	Main memory	
5MMDDR.0512-01	SO-DIMM DDR2 RAM 512 MB PC2-5300	
5MMDDR.1024-01	SO-DIMM DDR2 RAM 1024 MB PC2-5300	
5MMDDR.2048-01	SO-DIMM DDR2 RAM 2048 MB PC2-5300	
	Heat sink	
5AC803.HS00-00	PPC800 heat sink for CPU boards with L2400, L7400, U7500 or Celeron M 423 dual-core processor	
5AC803.HS00-01	PPC800 heat sink for CPU boards with T7400, T9400 or P8400 dual-core processor	
5AC803.HS00-02	PPC800 heat sink for CPU board with Atom processor N270	
	Fan kit	
5AC803.FA01-00	PPC800 fan kit for system units without an expansion	
	Optional accessories	
	Adapters	
5AC803.BC01-00	1 compact PCI Express PPC800 adapter	
5AC803.BC02-00	1 compact slide-in PPC800 adapter	
	Bus units	
5AC803.BX01-00	PPC800 bus; 1 PCI, 1 slide-in slot	
5AC803.BX01-01	PPC800 bus; 1 PCI Express, 1 slide-in slot	

Table 35: 5PC820.1906-00 - Order data

Model number	Short description	Figure
5AC803.BX02-00	PPC800 bus; 2 PCI, 1 slide-in slot	
5AC803.BX02-01	PPC800 bus; 1 PCI, 1 PCI Express, 1 slide-in slot	
	Plug-in cards	
5ACPCC.ETH0-00	PCIe Ethernet card 1x 10/100/1000 For APC820 and PPC800.	
5ACPCC.MPL0-00	PCIe POWERLINK card, 2 POWERLINK interfaces, 512 kB SRAM; for APC820 and PPC800.	
	Expansions	
5AC803.SX01-00	PPC800 expansion; 1 PCI/PCI Express and 1 slide-in slot (bus 5AC803.BX01-00 or 5AC803.BX01-01 required)	
5AC803.SX02-00	PPC800 expansion; 2 PCI/PCI Express and 1 slide-in slot (bus 5AC803.BX02-00 or 5AC803.BX02-01 required)	
	Drives	
5AC801.ADAS-00	SATA hard disk adapter for operating a slide-in compact hard disk in a slide-in slot	
5AC801.DVDS-00	DVD-ROM SATA slide-in drive	
5AC801.DVRS-00	DVD-R/RW DVD+R/RW SATA drive, slide-in	
5AC801.HDDI-00	40 GB slide-in compact SATA hard disk, 24/7 operation with extended temperature range. Note: Please see the manual for information about using this hard disk.	
5AC801.HDDI-04	500 GB slide-in compact SATA hard disk; 24/7 operation. Note: Please see the manual for information about using this hard disk.	
5AC801.HDDS-00	40 GB slide-in SATA hard disk; 24/7 operation with extended temperature range. Note: Please see the manual for information about using this hard disk.	
5AC801.SSDI-03	60 GB SATA SSD (MLC), slide-in compact	
5AC801.SSDI-04	128 GB SATA SSD (MLC), slide-in compact	
5AC801.SSDI-05	256 GB SATA SSD (MLC), slide-in compact	
	Fan kit	
5AC803.FA02-00	PPC800 fan kit for system units with expansion 5AC803.SX01-00	
5AC803.FA03-00	PPC800 fan kit for system units with expansion 5AC803.SX02-00	
	Uninterruptible power supply	
5AC600.UPSI-00	UPS module for APC620, APC810, PPC800; for system units 5PC600.SX01-00 (starting with Rev. H0), 5PC600.SX02-00 (starting with Rev. G0), 5PC600.SX02-01 (starting with Rev. H0), 5PC600.SX05-00 (starting with Rev. F0), 5PC600.SX05-01 (starting with Rev. F0), 5PC600.SF03-00 (starting with Rev. A0), 5PC810.SX*. 5PC820.1505-00, 5PC820.1906-00. Order cable (5CAUPS.0005-00 or 5CAUPS.0030-00) and battery unit (5AC600.UPSB-00) separately	

Table 35: 5PC820.1906-00 - Order data

3.1.2.3 Interfaces

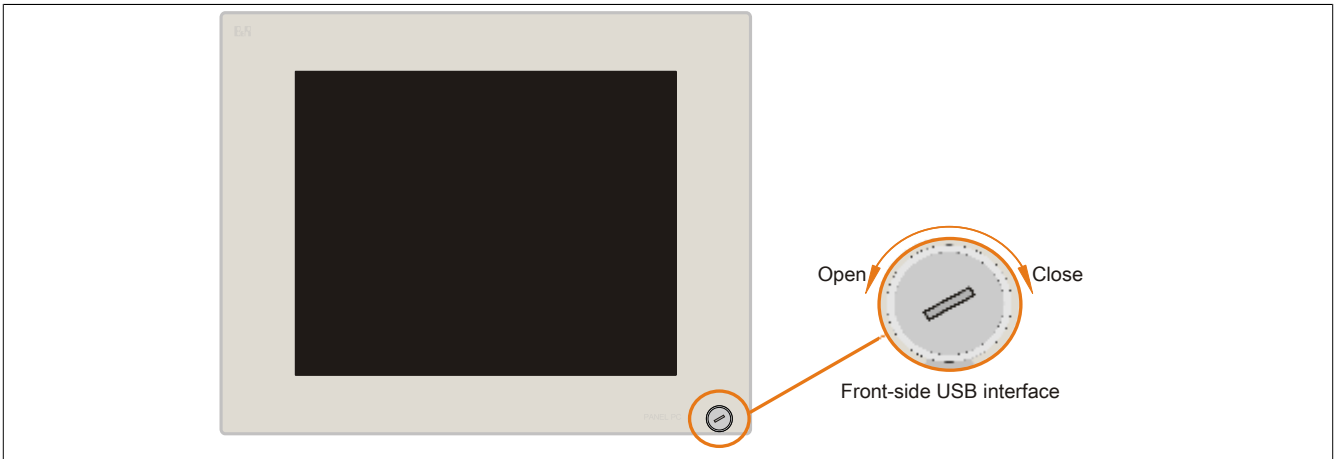

Figure 16: 5PC820.1906-00 - Front view

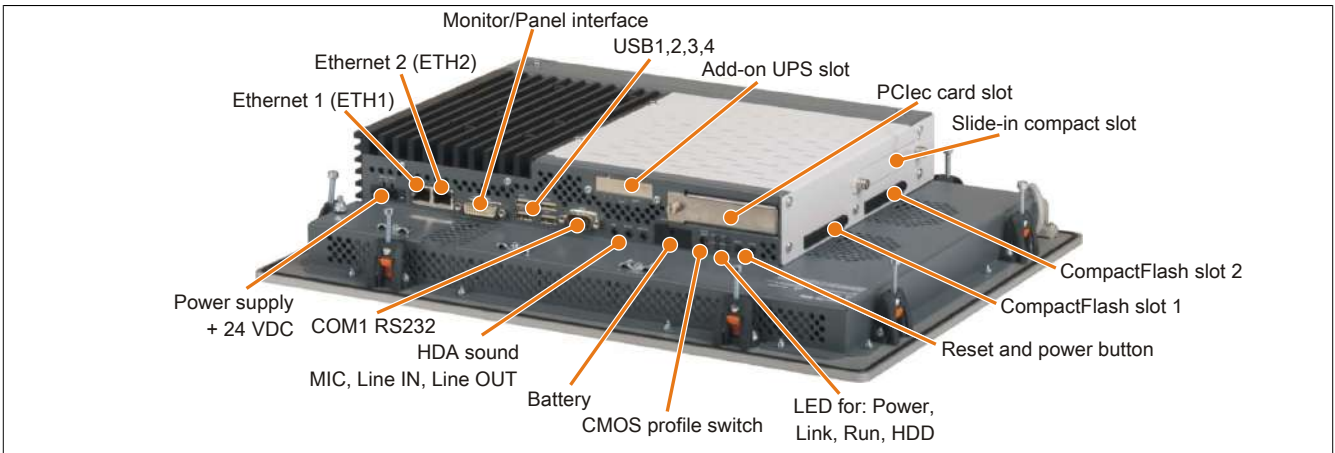

Figure 17: 5PC820.1906-00 - Rear view

Warning!

Do not remove the fastening screws from the heat sink since this component is connected to the processor and chipset via a thermal coupling. If this connection is interrupted, the B&R Industrial PC must be sent back to the factory for repair. Removing the fastening screws (protected by a seal) voids all warranty.

During operation, surface temperatures of the heat sink may reach 70°C ("hot surface" warning).

3.1.2.4 Technical data

Product ID	5PC820.1906-00	
Revision	C0	F0
General information		
LEDs	Power, HDD, Link, Run	
B&R ID code	0xAF22	
Battery		
Type	Renata 950 mAh	
Service life	2½ years	
Removable	Yes, accessible from the outside	
Execution	Lithium ion	
Power button	Yes	
Reset button	Yes	
Buzzer	Yes	
Certification		
CE	Yes	
cULus	Yes	
GOST-R	Yes	
Controller		
Boot loader	BIOS	

Table 36: 5PC820.1906-00, 5PC820.1906-00 - Technical data

Technical data • Individual components

Product ID		5PC820.1906-00	
Power failure logic			
Controller		MTCX ¹⁾	
Buffer time		10 ms	
Graphics			
Controller		Depends on the CPU board being used	
Memory			
Type		Depends on the CPU board being used	
Memory size		Depends on the CPU board being used	
Interfaces			
COM1			
Type		RS232, modem-capable, not electrically isolated	
Execution		9-pin male DSUB connector	
UART		16550-compatible, 16-byte FIFO	
Max. baud rate		115 kbit/s	
CompactFlash slot 1			
Type		Type I	
CompactFlash slot 2			
Type		Type I	
USB			
Quantity		5	
Type		USB 2.0	
Execution		Type A	
Transfer rate		Low speed (1.5 Mbit/s), full speed (12 Mbit/s), high speed (480 Mbit/s)	
Current load		Max. 500 mA or 1 A per connection	
Ethernet			
Quantity		2	
Execution		Shielded RJ45 port	
Transfer rate		10/100/1000 Mbit/s	
Audio			
Type		HDA sound	
Inputs		Microphone, Line IN	
Outputs		Line OUT	
Display			
Type		Color TFT	
Display size		19" (480 mm)	
Colors		16 million	
Resolution		SXGA, 1280 x 1024 pixels	
Contrast		900:1	1000:1
Viewing angles			
Horizontal		Direction R = 85° / Direction L = 85°	Direction R = 89° / Direction L = 89°
Vertical		Direction U = 85° / Direction D = 85°	Direction U = 89° / Direction D = 89°
Backlight			
Type		CCFL	LED
Brightness		300 cd/m ²	
Half-brightness time ²⁾		50,000 h	
Touch screen ³⁾			
Type		AMT	
Technology		Analog, resistive	
Controller		Elo, serial, 12-bit	
Transmittance		81% ±3%	
Inserts			
PCI slots			
Quantity		1 or 2 (optional) ⁴⁾	
PCIe slots			
Quantity		1 ⁵⁾	
PCIec slots			
Quantity		Optional ⁶⁾	
Slide-in drives		Depends on the component (on the expansion and bus unit being used)	
Slide-in compact drives		Optional ⁷⁾	
Add-on UPS slot		Yes	
Insert for fan kit		Yes	
Electrical characteristics			
Nominal voltage		24 VDC ±25%	
Nominal current		6 A	
Starting current		Typ. 10 A, max. 50 A for <300 μs	
Power consumption		Depends on the component	
Electrical isolation		Yes	
Operating conditions			
Height of drop		1 m on industrial surfaces (in original packaging)	
EN 60529 protection		Back: IP20 Front: IP65, dust and sprayed water protection	

Table 36: 5PC820.1906-00, 5PC820.1906-00 - Technical data

Product ID	5PC820.1906-00
Environmental conditions	
Temperature	
Operation	Depends on the component
Storage	-20 to 60°C
Transport	-20 to 60°C
Relative humidity	
Operation	10 to 85%, non-condensing
Storage	T ≤ 40°C: 5 to 90%, non-condensing T > 40°C: <90%, non-condensing
Transport	T ≤ 40°C: 5 to 90%, non-condensing T > 40°C: <90%, non-condensing
Vibration	
Operation (continuous)	2 to 9 Hz: 1.75 mm amplitude / 9 to 150 Hz: 0.5 g
Operation (occasional)	2 to 9 Hz: 3.5 mm amplitude / 9 to 150 Hz: 1 g
Storage	2 to 8 Hz: 7.5 mm amplitude / 8 to 200 Hz: 2 g / 200 to 500 Hz: 4 g
Transport	2 to 8 Hz: 7.5 mm amplitude / 8 to 200 Hz: 2 g / 200 to 500 Hz: 4 g
Shock	
Operation	15 g, 11 ms
Storage	30 g, 15 ms
Transport	30 g, 15 ms
Mechanical characteristics	
Housing	
Material	Metal
Front	
Frame	Naturally anodized aluminum
Design	Gray
Panel overlay	
Material	Polyester
Light background	Similar to Pantone 427CV
Gasket	Flat gasket around display front
Dimensions	
Width	527 mm
Height	421 mm
Depth	Depends on the component
Weight	10000 g (depends on the component)

Table 36: 5PC820.1906-00, 5PC820.1906-00 - Technical data

- 1) Maintenance Controller Extended.
- 2) At an ambient temperature of 25°C. Reducing the brightness by 50% can result in an approximately 50% increase in the half-brightness time.
- 3) Touch screen drivers for approved operating systems are available in the Downloads section of the B&R website.
- 4) The PCI slots available depend on the expansion and bus unit being used.
- 5) The PCIe slots available depend on the expansion and bus unit being used.
- 6) Optional with PCIe adapter 5AC803.BC01-00.
- 7) Optional with slide-in compact adapter 5AC803.BC02-00.

3.1.2.5 Dimensions

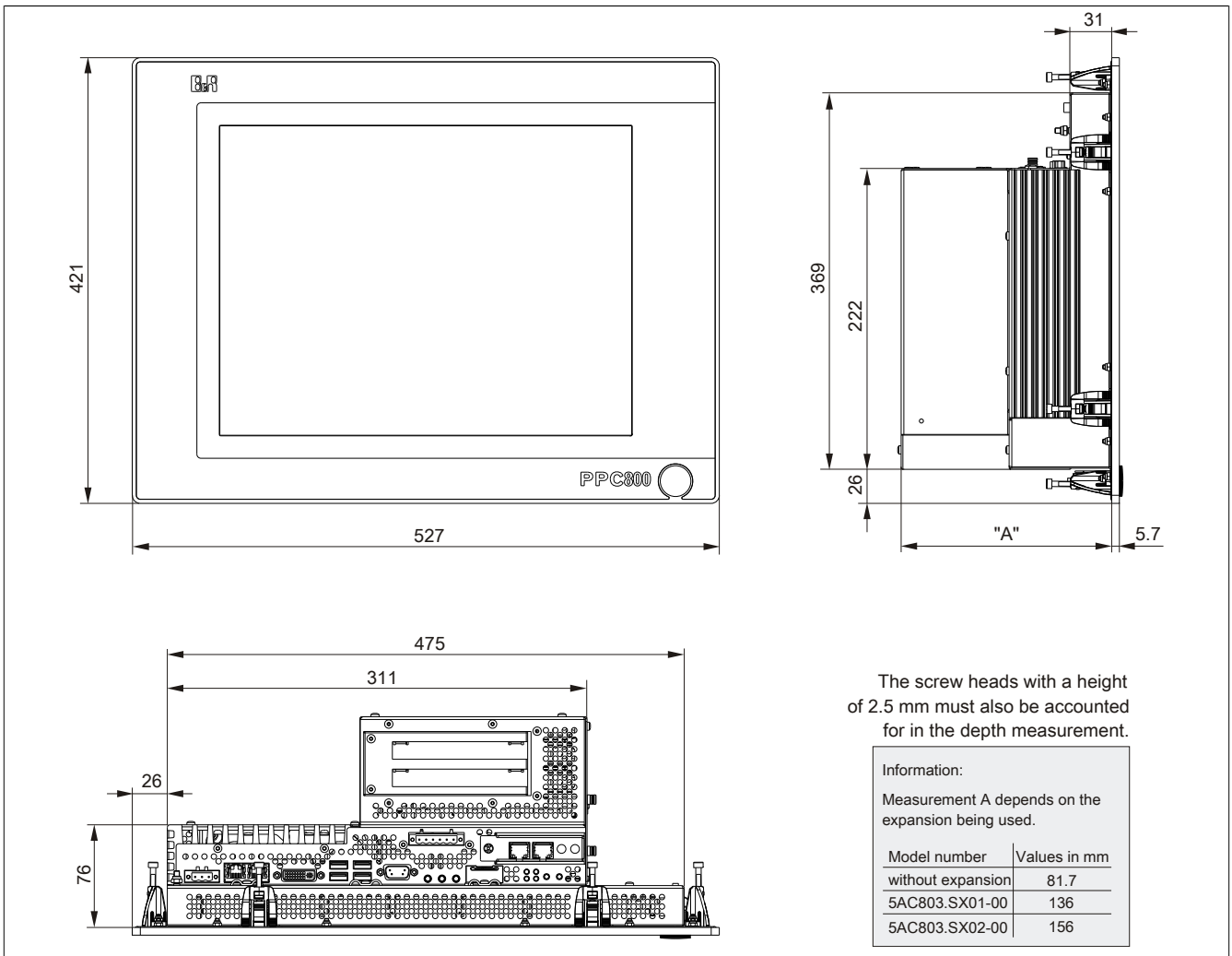

Figure 18: 5PC820.1906-00 - Dimensions

3.1.2.6 Cutout

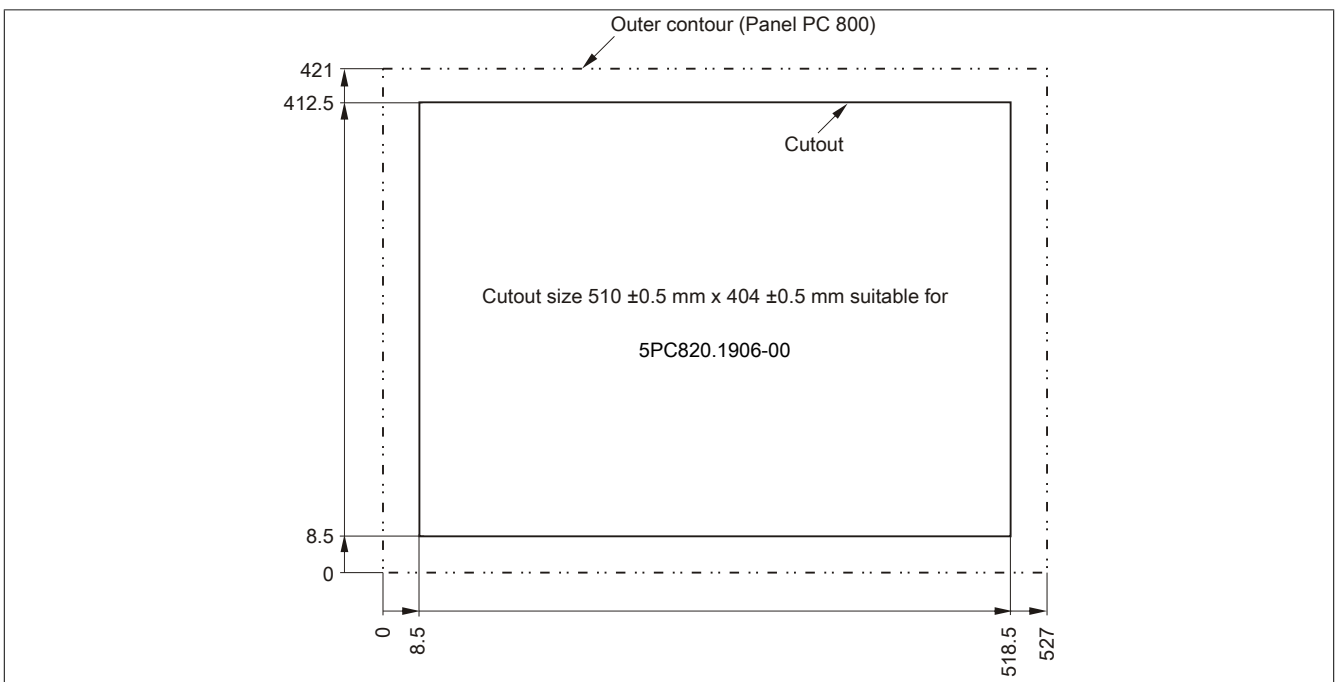

Figure 19: 5PC820.1906-00 - Cutout installation

3.2 CPU boards 945GME

3.2.1 General information

- AMI BIOS
- Intel® 945GME chipset
- 2x DDR2 memory slot
- Dual-channel memory
- Intel® GMA 950
- Gigabit Ethernet

3.2.2 Order data

Model number	Short description	Figure
CPU boards		
5PC800.B945-00	Intel Core Duo L2400 CPU board, 1.66 GHz, dual core, 667 MHz FSB, 2 MB L2 cache; 945GME chipset; 2 slots for SO-DIMM DDR2 modules (max. total of 3 GB), Realtek RTL8111B Ethernet controller	
5PC800.B945-01	Intel Core2 Duo L7400 CPU board, 1.5 GHz, dual core, 667 MHz FSB, 4 MB L2 cache; 945GME chipset; 2 slots for SO-DIMM DDR2 modules (max. total of 3 GB), Realtek RTL8111B Ethernet controller	
5PC800.B945-02	Intel Core2 Duo U7500 CPU board, 1.06 GHz, dual core, 533 MHz FSB, 2 MB L2 cache; 945GME chipset; 2 slots for SO-DIMM DDR2 modules (max. total of 3 GB), Realtek RTL8111B Ethernet controller	
5PC800.B945-03	Intel Celeron M 423 CPU board, 1.06 GHz, single core, 533 MHz FSB, 1 MB L2 cache; 945GME chipset; 2 slots for SO-DIMM DDR2 modules (max. total of 3 GB), Realtek RTL8111B Ethernet controller	
5PC800.B945-04	Intel Core2 Duo T7400 CPU board, 2.16 GHz, dual core, 667 MHz FSB, 4 MB L2 cache; 945GME chipset; 2 slots for SO-DIMM DDR2 modules (max. total of 3 GB), Realtek RTL8111B Ethernet controller	
5PC800.B945-05	Intel Atom N270 CPU board, 1.6 GHz, single core, 533 MHz FSB, 512 kB L2 cache; 945GME chipset; 2 slots for SO-DIMM DDR2 modules (max. total of 3 GB), Realtek RTL8111C Ethernet controller	
Required accessories		
Main memory		
5MMDDR.0512-01	SO-DIMM DDR2 RAM 512 MB PC2-5300	
5MMDDR.1024-01	SO-DIMM DDR2 RAM 1024 MB PC2-5300	
5MMDDR.2048-01	SO-DIMM DDR2 RAM 2048 MB PC2-5300	

Table 37: 5PC800.B945-00, 5PC800.B945-01, 5PC800.B945-02, 5PC800.B945-03, 5PC800.B945-04, 5PC800.B945-05 - Order data

Model number	Short description	Figure
CPU boards		
5PC800.B945-10	Intel Core Duo L2400 CPU board, 1.66 GHz, dual core, 667 MHz FSB, 2 MB L2 cache; 945GME chipset; 2 slots for SO-DIMM DDR2 modules (max. total of 3 GB), Realtek RTL8111C Ethernet controller	
5PC800.B945-11	Intel Core2 Duo L7400 CPU board, 1.5 GHz, dual core, 667 MHz FSB, 4 MB L2 cache; 945GME chipset; 2 slots for SO-DIMM DDR2 modules (max. total of 3 GB), Realtek RTL8111C Ethernet controller	
5PC800.B945-12	Intel Core2 Duo U7500 CPU board, 1.06 GHz, dual core, 533 MHz FSB, 2 MB L2 cache; 945GME chipset; 2 slots for SO-DIMM DDR2 modules (max. total of 3 GB), Realtek RTL8111C Ethernet controller	
5PC800.B945-13	Intel Celeron M 423 CPU board, 1.06 GHz, single core, 533 MHz FSB, 1 MB L2 cache; 945GME chipset; 2 slots for SO-DIMM DDR2 modules (max. total of 3 GB), Realtek RTL8111C Ethernet controller	
5PC800.B945-14	Intel Core2 Duo T7400 CPU board, 2.16 GHz, dual core, 667 MHz FSB, 4 MB L2 cache; 945GME chipset; 2 slots for SO-DIMM DDR2 modules (max. total of 3 GB), Realtek RTL8111C Ethernet controller	
Required accessories		
Main memory		
5MMDDR.0512-01	SO-DIMM DDR2 RAM 512 MB PC2-5300	
5MMDDR.1024-01	SO-DIMM DDR2 RAM 1024 MB PC2-5300	
5MMDDR.2048-01	SO-DIMM DDR2 RAM 2048 MB PC2-5300	

Table 38: 5PC800.B945-10, 5PC800.B945-11, 5PC800.B945-12, 5PC800.B945-13, 5PC800.B945-14 - Order data

3.2.3 5PC800.B945-0x - Technical data

Product ID	5PC800.B945-00	5PC800.B945-01	5PC800.B945-02	5PC800.B945-03	5PC800.B945-04	5PC800.B945-05
General information						
Certification	Yes					
CE	-	-	-	-	-	Yes
cULus	-	-	-	Yes	-	Yes
GOST-R	-	-	-	-	-	Yes
GL	-	-	-	-	-	Yes ¹⁾
Controller						
Boot loader	Embedded AMI BIOS					
Processor						
Type	Intel® Core™ Duo L2400	Intel® Core™2 Duo L7400	Intel® Core™2 Duo U7500	Intel® Celeron® M 423,	Intel® Core™2 Duo T7400	Intel® Atom™ N270
Clock frequency	1660 MHz	1500 MHz	1060 MHz	1060 MHz	2160 MHz	1660 MHz
Number of cores	2	2	2	1	2	1
Architectures	65 nm	65 nm	65 nm	65 nm	65 nm	45 nm
L1 cache	32 kB	32 kB	32 kB	32 kB	32 kB	24 kB
L2 cache	2 MB	4 MB	2 MB	1 MB	4 MB	512 kB
External bus	667 MHz	667 MHz	533 MHz	533 MHz	667 MHz	533 MHz
Intel® 64 Architecture	No	Yes	Yes	No	Yes	No
Intel® Virtualization Technology (VT-x)	Yes	Yes	Yes	No	Yes	No
Enhanced Intel SpeedStep® Technology	Yes	Yes	Yes	No	Yes	Yes
Chipset						
Intel® 945GME Intel® 82801 GHM (ICH7M-DH)						
Real-time clock						
Precision	At 25°C: typ. 12 ppm (1 seconds) per day					
Battery backed	Yes					
Memory slot						
Type	DDR2					
Memory size	Max. 3 GB					
Graphics						
Controller	Intel® Graphics Media Accelerator 950					
Memory	Up to 224 MB ²⁾					
Color depth	Max. 32-bit					
Resolution	2x Intel-compliant SDVO ports, 1920 x 1080					
DVI	400 MHz RAMDAC, resolutions up to 2048 x 1536 @ 75 Hz (QXGA) and 1920 x 1080 @ 85 Hz (HDTV)					
RGB						
Mass memory management						
2x SATA, 1x IDE						
Power management						
ACPI 2.0, S3 Support (suspend to RAM)						

Table 39: 5PC800.B945-00, 5PC800.B945-01, 5PC800.B945-02, 5PC800.B945-03, 5PC800.B945-04, 5PC800.B945-05 - Technical data

- 1) Yes, although applies only if all components installed within the complete system have this certification
 2) Allocated in main memory.

3.2.4 5PC800.B945-1x - Technical data

Product ID	5PC800.B945-10	5PC800.B945-11	5PC800.B945-12	5PC800.B945-13	5PC800.B945-14
General information					
Certification	Yes				
CE	Yes				
cULus	Yes				
GOST-R	Yes				
Controller					
Boot loader	Embedded AMI BIOS				
Processor					
Type	Intel® Core™ Duo L2400	Intel® Core™2 Duo L7400	Intel® Core™2 Duo U7500	Intel® Celeron® M 423,	Intel® Core™2 Duo T7400
Clock frequency	1660 MHz	1500 MHz	1060 MHz	1060 MHz	2160 MHz
Number of cores	2	2	2	1	2
Architectures			65 nm		
L1 cache			32 kB		
L2 cache	2 MB	4 MB	2 MB	1 MB	4 MB
External bus	667 MHz	667 MHz	533 MHz	533 MHz	667 MHz
Intel® 64 Architecture	No	Yes	Yes	No	Yes
Intel® Virtualization Technology (VT-x)	Yes	Yes	Yes	No	Yes
Enhanced Intel SpeedStep® Technology	Yes	Yes	Yes	No	Yes
Chipset					
Intel® 945GME Intel® 82801 GHM (ICH7M-DH)					

Table 40: 5PC800.B945-10, 5PC800.B945-11, 5PC800.B945-12, 5PC800.B945-13, 5PC800.B945-14 - Technical data

Product ID	5PC800.B945-10	5PC800.B945-11	5PC800.B945-12	5PC800.B945-13	5PC800.B945-14
Real-time clock Precision Battery backed	At 25°C: typ. 12 ppm (1 seconds) per day Yes				
Memory slot Type Memory size	DDR2 Max. 3 GB				
Graphics Controller Memory Color depth Resolution DVI RGB	Intel® Graphics Media Accelerator 950 Up to 224 MB ¹⁾ Max. 32-bit 2x Intel-compliant SDVO ports, 1920 x 1080 400 MHz RAMDAC, resolutions up to 2048 x 1536 @ 75 Hz (QXGA) and 1920 x 1080 @ 85 Hz (HDTV)				
Mass memory management	2x SATA, 1x IDE				
Power management	ACPI 2.0, S3 Support (suspend to RAM)				

Table 40: 5PC800.B945-10, 5PC800.B945-11, 5PC800.B945-12, 5PC800.B945-13, 5PC800.B945-14 - Technical data

1) Allocated in main memory.

3.3 Heat sink

3.3.1 Order data

Model number	Short description	Figure
	Heat sinks	
5AC803.HS00-00	PPC800 heat sink for CPU boards with L2400, L7400, U7500 or Celeron M 423 dual-core processor	
5AC803.HS00-01	PPC800 heat sink for CPU boards with T7400, T9400 or P8400 dual-core processor	
5AC803.HS00-02	PPC800 heat sink for CPU board with Atom processor N270	
	Required accessories	
	CPU boards	
5PC800.B945-00	Intel Core Duo L2400 CPU board, 1.66 GHz, dual core, 667 MHz FSB, 2 MB L2 cache; 945GME chipset; 2 slots for SO-DIMM DDR2 modules (max. total of 3 GB), Realtek RTL8111B Ethernet controller	
5PC800.B945-01	Intel Core2 Duo L7400 CPU board, 1.5 GHz, dual core, 667 MHz FSB, 2 MB L2 cache; 945GME chipset; 4 slots for SO-DIMM DDR2 modules (max. total of 3 GB), Realtek RTL8111B Ethernet controller	
5PC800.B945-02	Intel Core2 Duo U7500 CPU board, 1.06 GHz, dual core, 533 MHz FSB, 2 MB L2 cache; 945GME chipset; 2 slots for SO-DIMM DDR2 modules (max. total of 3 GB), Realtek RTL8111B Ethernet controller	
5PC800.B945-03	Intel Celeron M 423 CPU board, 1.06 GHz, single core, 533 MHz FSB, 1 MB L2 cache; 945GME chipset; 2 slots for SO-DIMM DDR2 modules (max. total of 3 GB), Realtek RTL8111B Ethernet controller	
5PC800.B945-04	Intel Core2 Duo T7400 CPU board, 2.16 GHz, dual core, 667 MHz FSB, 2 MB L2 cache; 945GME chipset; 4 slots for SO-DIMM DDR2 modules (max. total of 3 GB), Realtek RTL8111B Ethernet controller	
5PC800.B945-05	Intel Atom N270 CPU board, 1.6 GHz, single core, 533 MHz FSB, 512 kB L2 cache; 945GME chipset; 2 slots for SO-DIMM DDR2 modules (max. total of 3 GB), Realtek RTL8111C Ethernet controller	
5PC800.B945-10	Intel Core Duo L2400 CPU board, 1.66 GHz, dual core, 667 MHz FSB, 2 MB L2 cache; 945GME chipset; 2 slots for SO-DIMM DDR2 modules (max. total of 3 GB), Realtek RTL8111C Ethernet controller	
5PC800.B945-11	Intel Core2 Duo L7400 CPU board, 1.5 GHz, dual core, 667 MHz FSB, 2 MB L2 cache; 945GME chipset; 4 slots for SO-DIMM DDR2 modules (max. total of 3 GB), Realtek RTL8111C Ethernet controller	
5PC800.B945-12	Intel Core2 Duo U7500 CPU board, 1.06 GHz, dual core, 533 MHz FSB, 2 MB L2 cache; 945GME chipset; 2 slots for SO-DIMM DDR2 modules (max. total of 3 GB), Realtek RTL8111C Ethernet controller	
5PC800.B945-13	Intel Celeron M 423 CPU board, 1.06 GHz, single core, 533 MHz FSB, 1 MB L2 cache; 945GME chipset; 2 slots for SO-DIMM DDR2 modules (max. total of 3 GB), Realtek RTL8111C Ethernet controller	
5PC800.B945-14	Intel Core2 Duo T7400 CPU board, 2.16 GHz, dual core, 667 MHz FSB, 2 MB L2 cache; 945GME chipset; 4 slots for SO-DIMM DDR2 modules (max. total of 3 GB), Realtek RTL8111C Ethernet controller	

Table 41: 5AC803.HS00-00, 5AC803.HS00-01, 5AC803.HS00-02 - Order data

3.3.2 Technical data

Product ID	5AC803.HS00-00	5AC803.HS00-01	5AC803.HS00-02
General information			
Ideal for CPU boards	5PC800.B945-00 5PC800.B945-01 5PC800.B945-02 5PC800.B945-03	5PC800.B945-04 5PC800.B945-14	5PC800.B945-05
Suitable for the following system units		5PC820.1505-00 5PC820.1906-00	
Certification CE		Yes	
Mechanical characteristics			
Materials	Aluminum, black-coated with copper heat pipes		
Dimensions			
Width	143 mm		
Height	183.5 mm		
Depth	60 mm		
Weight	1200 g		

Table 42: 5AC803.HS00-00, 5AC803.HS00-01, 5AC803.HS00-02 - Technical data

3.4 Main memory

3.4.1 General information

These 200-pin DDR2 main memory modules operate at 677 MHz and are available in sizes of 512 MB, 1 GB and 2 GB.

If two RAM modules with the same size (e.g. 1 GB) are inserted, then dual-channel memory technology is supported. This technology is not supported if two modules of different sizes (e.g. 1 GB and 2 GB) are inserted.

If two 2 GB modules are inserted, only 3 GB of main memory can be used.

3.4.2 Order data

Model number	Short description	Figure
	Main memory	
5MMDDR.0512-01	SO-DIMM DDR2 RAM 512 MB PC2-5300	
5MMDDR.1024-01	SO-DIMM DDR2 RAM 1024 MB PC2-5300	
5MMDDR.2048-01	SO-DIMM DDR2 RAM 2048 MB PC2-5300	

Table 43: 5MMDDR.0512-01, 5MMDDR.1024-01, 5MMDDR.2048-01 - Order data

3.4.3 Technical data

Product ID	5MMDDR.0512-01	5MMDDR.1024-01	5MMDDR.2048-01
General information			
Certification			
CE		Yes	
cULus		Yes	
GOST-R		Yes	
GL		Yes ¹⁾	
Controller			
Memory			
Type		SO-DIMM DDR2 SDRAM	
Memory size	512 MB	1 GB	2 GB
Construction		200-pin	
Organization	64M x 64-bit	128M x 64-bit	256M x 64-bit
Speed		DDR2-667 (PC2-5300)	

Table 44: 5MMDDR.0512-01, 5MMDDR.1024-01, 5MMDDR.2048-01 - Technical data

1) Yes, although applies only if all components installed within the complete system have this certification

Information:

A main memory module can only be replaced at B&R.

3.5 Expansions

3.5.1 General information

This is an optional expansion for the PPC800 and has inserts for up to 2 PCI/PCIe slots (only in connection with a bus unit) and a slide-in drive.

3.5.2 Order data

Model number	Short description	Figure
	Expansions	
5AC803.SX01-00	PPC800 expansion; 1 PCI/PCI Express and 1 slide-in slot (bus 5AC803.BX01-00 or 5AC803.BX01-01 required)	
5AC803.SX02-00	PPC800 expansion; 2 PCI/PCI Express and 1 slide-in slot (bus 5AC803.BX02-00 or 5AC803.BX02-01 required)	
	Required accessories	
	Bus units	
5AC803.BX01-00	PPC800 bus; 1 PCI, 1 slide-in slot	
5AC803.BX01-01	PPC800 bus; 1 PCI Express, 1 slide-in slot	
5AC803.BX02-00	PPC800 bus; 2 PCI, 1 slide-in slot	
5AC803.BX02-01	PPC800 bus; 1 PCI, 1 PCI Express, 1 slide-in slot	
	Fan kits	
5AC803.FA02-00	PPC800 fan kit for system units with expansion 5AC803.SX01-00	
5AC803.FA03-00	PPC800 fan kit for system units with expansion 5AC803.SX02-00	
	Optional accessories	
	Drives	
5AC801.ADAS-00	SATA hard disk adapter for operating a slide-in compact hard disk in a slide-in slot	
5AC801.DVDS-00	DVD-ROM SATA slide-in drive	
5AC801.DVRS-00	DVD-R/RW DVD+R/RW SATA slide-in drive	
5AC801.HDDS-00	40 GB SATA slide-in hard disk; 24/7 operation with extended temperature range. Note: please see the manual for information about using this hard disk	
5ACPCI.RAIC-05	PCI RAID system SATA 2x 250 GB; Note: please see the manual for information about using this hard disk	
5ACPCI.RAIC-06	PCI RAID System 2x 500 GB - SATA	

Table 45: 5AC803.SX01-00, 5AC803.SX02-00 - Order data

3.5.3 Inserts

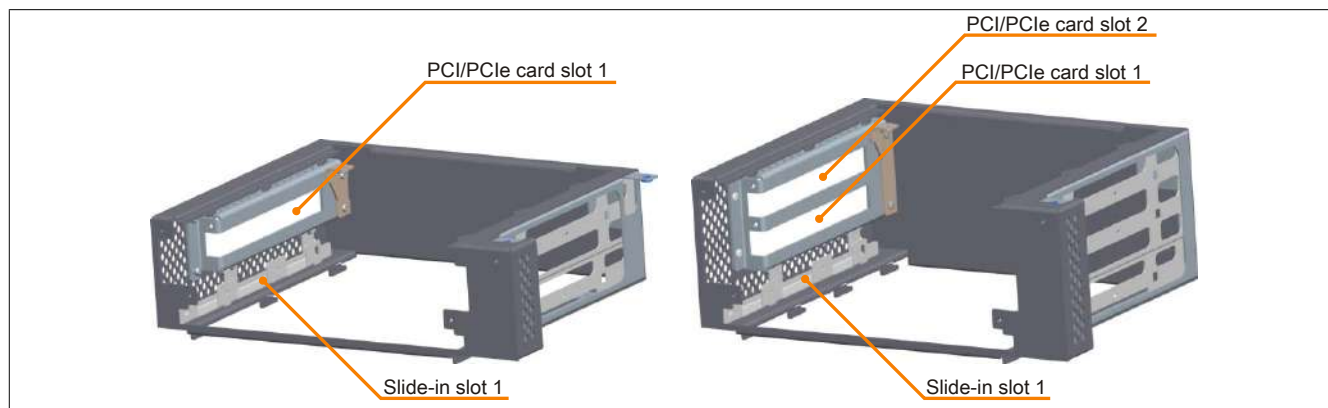

Figure 20: 5AC803.SX01-00, 5AC803.SX02-00 - Slots

3.5.4 Technical data

Product ID	5AC803.SX01-00	5AC803.SX02-00
General information		
Certification		
CE		Yes
GOST-R		Yes
Inserts		
PCI / PCIe slots		
Quantity	1	2
Slide-in drives		1

Table 46: 5AC803.SX01-00, 5AC803.SX02-00 - Technical data

Product ID	5AC803.SX01-00	5AC803.SX02-00
Mechanical characteristics		
Dimensions		
Width		167 mm
Height		222 mm
Depth	60 mm	80 mm
Weight	Approx. 1000 g	

Table 46: 5AC803.SX01-00, 5AC803.SX02-00 - Technical data

3.5.5 5AC803.SX01-00 - Dimensions

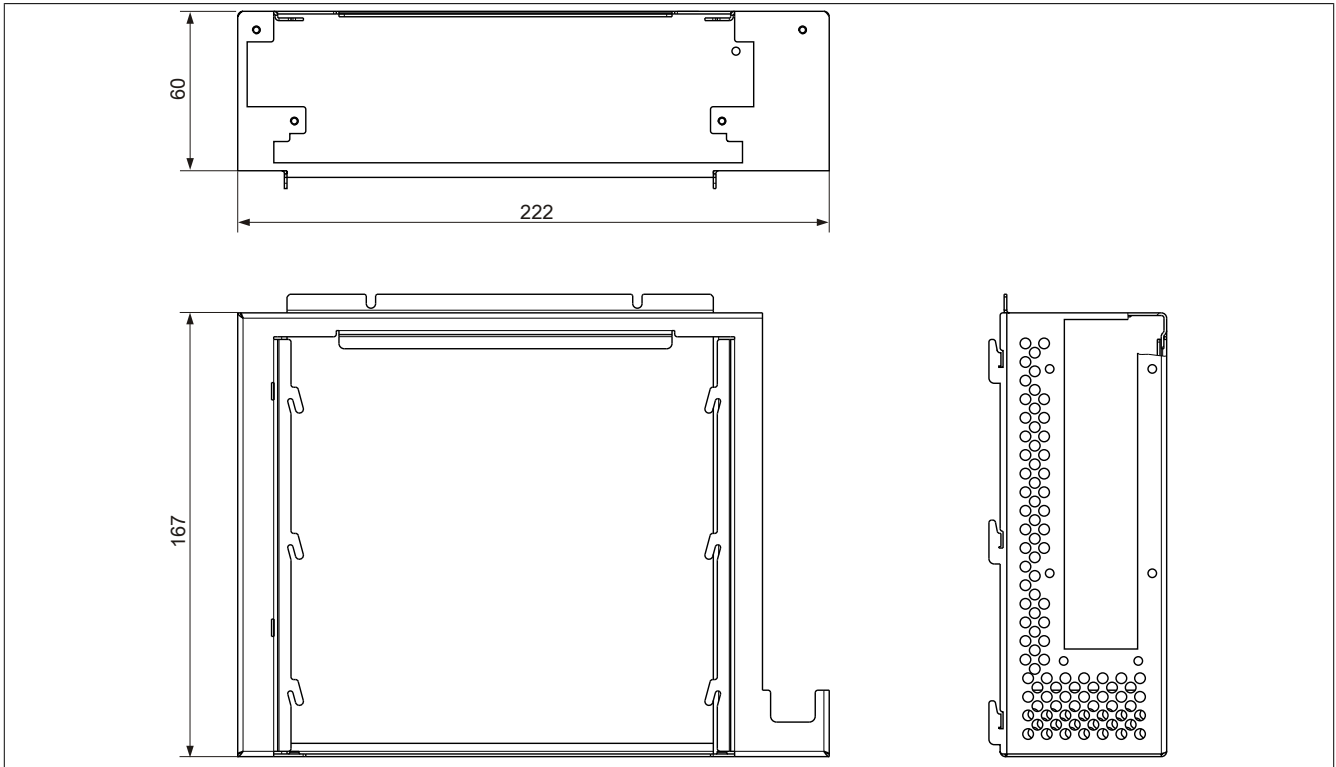

Figure 21: 5AC803.SX01-00 - Dimensions

3.5.6 5AC803.SX02-00 - Dimensions

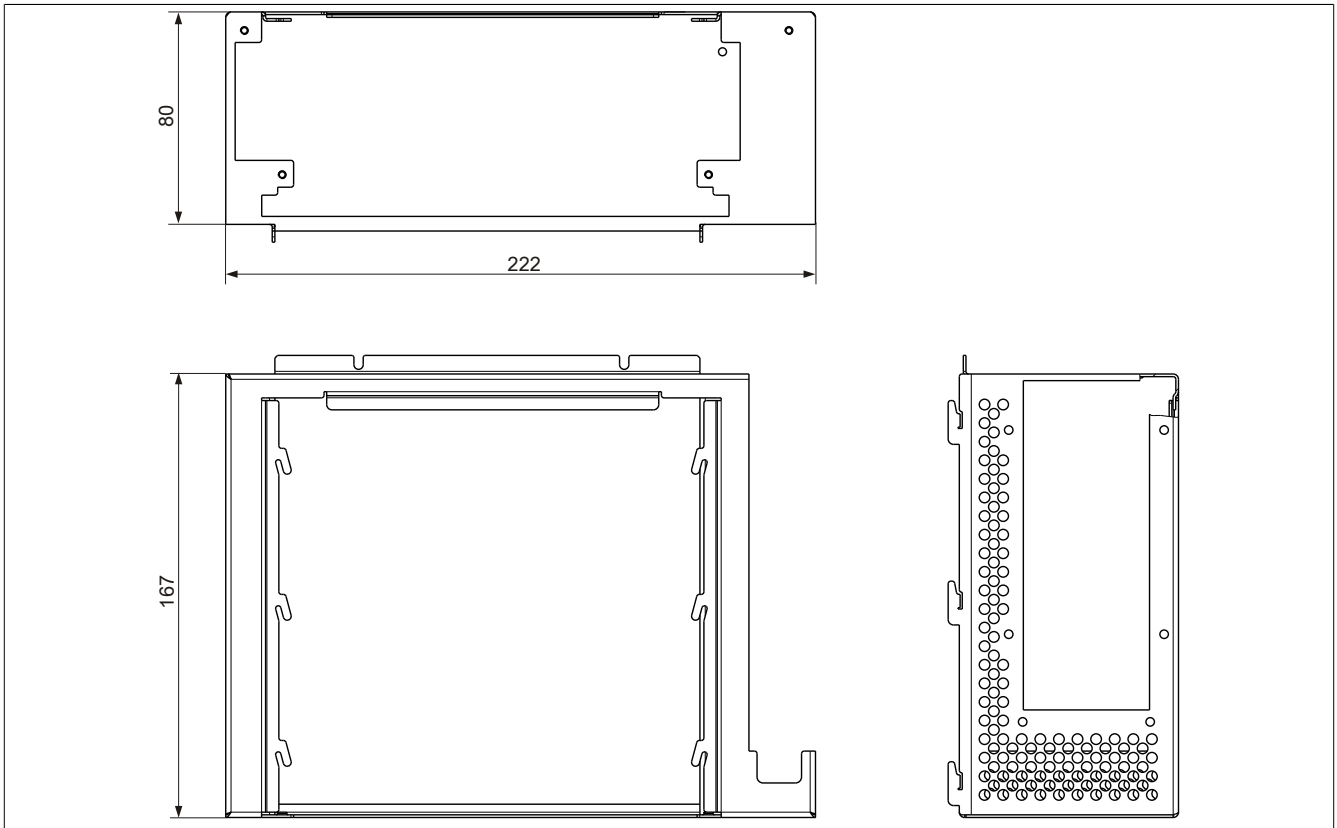

Figure 22: 5AC803.SX02-00 - Dimensions

3.5.7 Slot for bus units

3.5.7.1 Card slot (PCI / PCIe)

Standard PCI 2.2 half-size cards or PCI Express (PCIe) half-size cards can be installed depending on the type of bus unit. They cannot exceed the following dimensions.



Figure 23: Standard half-size PCI card - Dimensions

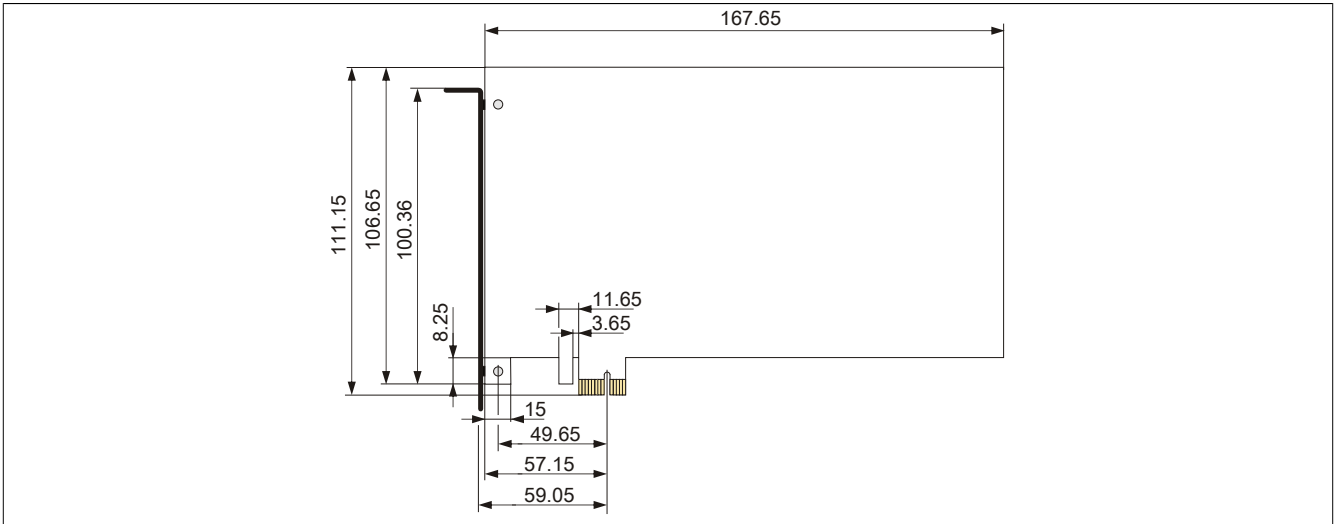

Figure 24: Standard half-size PCIe card - Dimensions

3.5.8 Slide-in slot 1

The internal connection between slide-in slot 1 and the chipset is made via SATA I and USB.

Slide-in slot 1	
Connection	SATA I and USB
Model number	Short description
	Drives
5AC801.ADAS-00	APC810 and PPC800 slide-in compact adapter
5AC801.HDDS-00	APC810 and PPC800 slide-in HDD EE25
5AC801.DVRS-00	APC810 and PPC800 slide-in DVD-R/RW
5AC801.DVDS-00	APC810 and PPC800 slide-in DVD-ROM



Table 47: Slide-in slot 1

Information:

The SATA I interface allows disks to be replaced during operation (hot plugging). In order to take advantage of this capability, this feature must be supported by the operating system.

3.6 Bus units

3.6.1 General information

Bus units are compatible with expansions with 1 or 2 card slots and provide support for PCI and/or PCI Express.

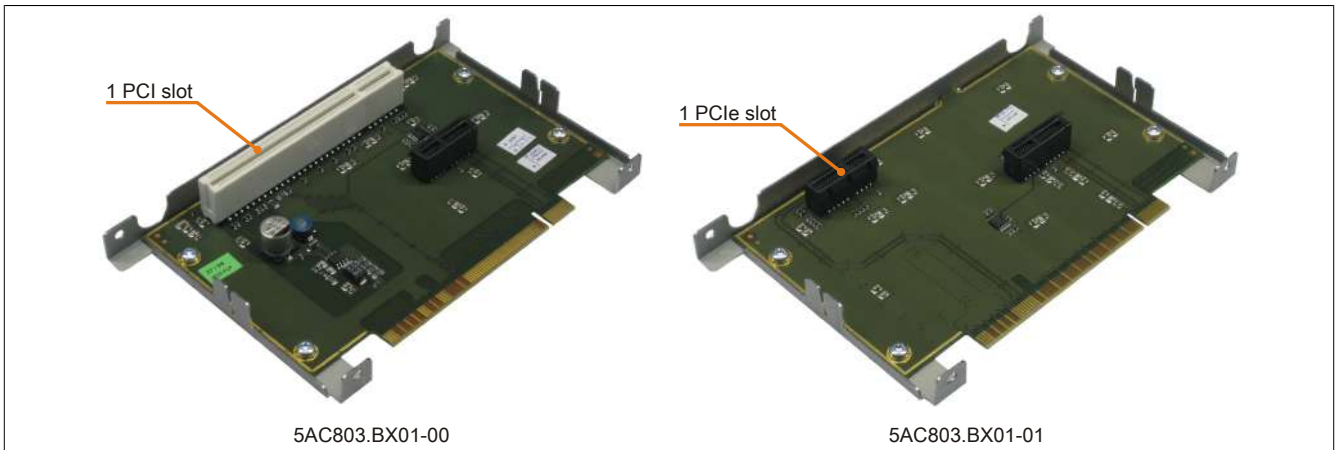

Figure 25: 1-slot bus units

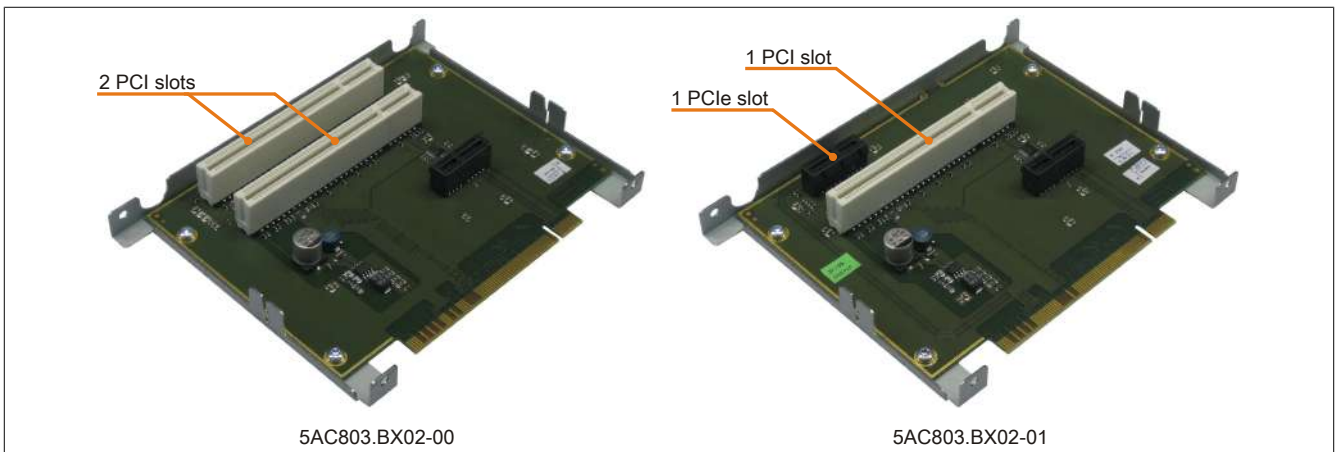

Figure 26: 2-slot bus units

3.6.2 Order data

Model number	Short description	Figure
Bus units		
5AC803.BX01-00	PPC800 bus; 1 PCI, 1 slide-in slot	
5AC803.BX01-01	PPC800 bus; 1 PCI Express, 1 slide-in slot	
5AC803.BX02-00	PPC800 bus; 2 PCI, 1 slide-in slot	
5AC803.BX02-01	PPC800 bus; 1 PCI, 1 PCI Express, 1 slide-in slot	

Table 48: 5AC803.BX01-00, 5AC803.BX01-01, 5AC803.BX02-00, 5AC803.BX02-01 - Order data

3.6.3 Technical data

Product ID	5AC803.BX01-00	5AC803.BX01-01	5AC803.BX02-00	5AC803.BX02-01
General information				
Certification				
CE				Yes
GOST-R				Yes

Table 49: 5AC803.BX01-00, 5AC803.BX01-01, 5AC803.BX02-00, 5AC803.BX02-01 - Technical data

Product ID	5AC803.BX01-00	5AC803.BX01-01	5AC803.BX02-00	5AC803.BX02-01
Inserts				
PCI slots				
Quantity	1	-	2	1
Type	32-bit	-	32-bit	32-bit
Execution	PCI half-size	-	PCI half-size	PCI half-size
Standard	2.2	-	2.2	2.2
Bus speed	33 MHz	-	33 MHz	33 MHz
PCIe slots				
Quantity	-	1	-	1
Execution	-	PCIe half-size	-	PCIe half-size
Standard	-	1.0 a	-	1.0 a
Bus speed	-	x1 (250 MB/s)	-	x1 (250 MB/s)

Table 49: 5AC803.BX01-00, 5AC803.BX01-01, 5AC803.BX02-00, 5AC803.BX02-01 - Technical data

3.7 Adapters

3.7.1 5AC803.BC01-00

3.7.1.1 General information

This adapter can be used to operate a PCI Express compact plug-in card in PPC800 system units.

3.7.1.2 Order data

Model number	Short description	Figure
	Adapter	
5AC803.BC01-00	1 compact PCI Express PPC800 adapter	
	Required accessories	
	Interface cards	
5ACPCC.ETH0-00	PCIec Ethernet card 1x 10/100/1000 For APC820 and PPC800.	
5ACPCC.MPL0-00	PCIec POWERLINK card, 2 POWERLINK interfaces, 512 kB SRAM; for APC820 and PPC800.	

Table 50: 5AC803.BC01-00 - Order data

3.7.2 5AC803.BC02-00

3.7.2.1 General information

This adapter can be used to operate a slide-in compact drive in PPC800 system units.

3.7.2.2 Order data

Model number	Short description	Figure
	Adapter	
5AC803.BC02-00	1 compact slide-in PPC800 adapter	
	Required accessories	
	Drives	
5AC801.HDDI-00	40 GB SATA slide-in compact hard disk; 24/7 operation with extended temperature range. Note: please see the manual for information about using this hard disk	
5AC801.HDDI-04	500 GB SATA hard disk, slide-in compact, 24/7 operation Note: please see the manual for information about using this hard disk	
5AC801.SSDI-00	32 GB SATA SSD (SLC), slide-in compact	
5AC801.SSDI-03	60 GB SATA slide-in compact SSD (MLC)	
5AC801.SSDI-04	128 GB SATA SSD (MLC), slide-in compact	

Table 51: 5AC803.BC02-00 - Order data

3.8 PClec plug-in cards

3.8.1 General information

PClec plug-in cards are equipped with a sensor that monitors the card's temperature. This is read out in BIOS and in the ADI.

3.8.2 Dimensions

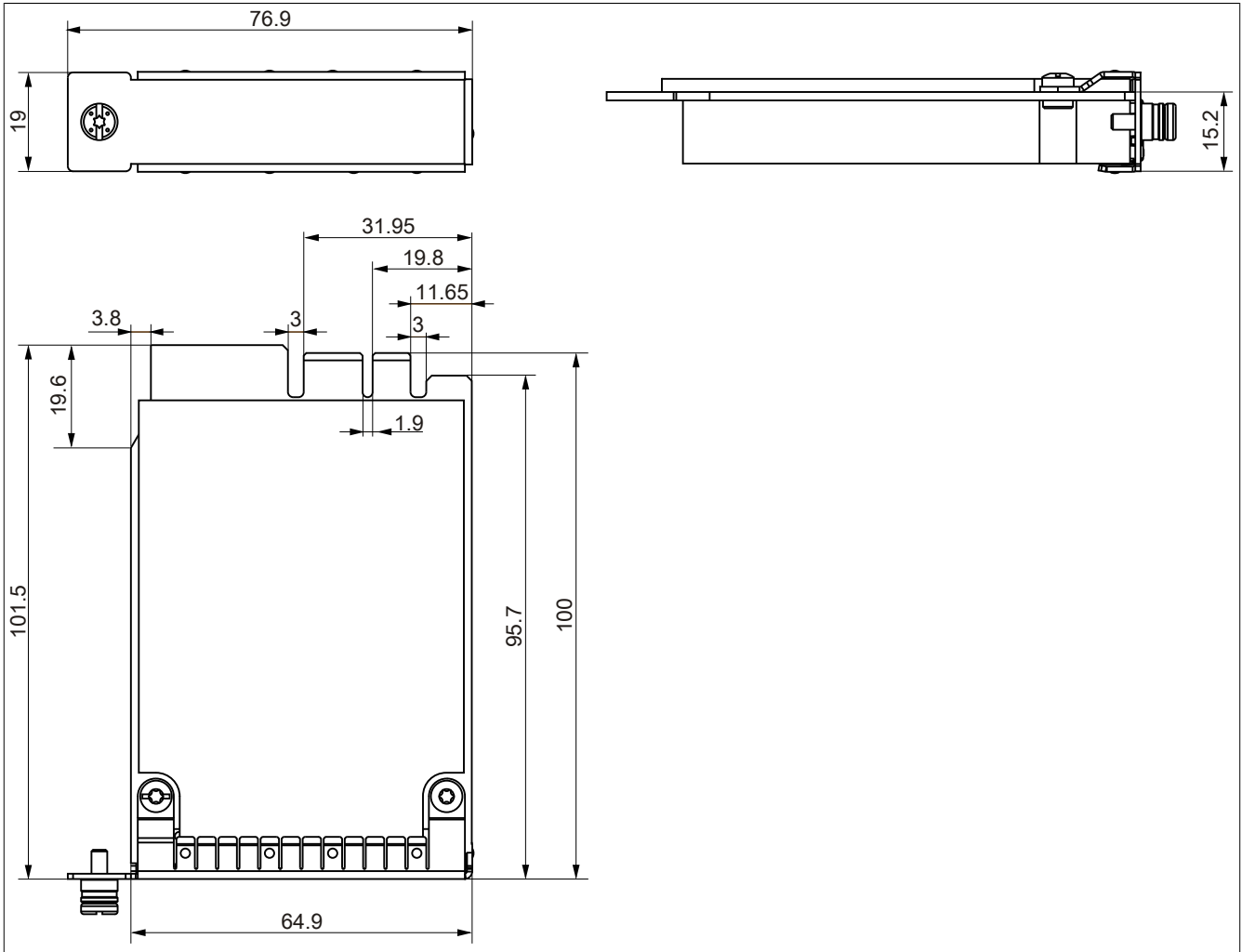

Figure 27: PCI Express compact plug-in cards - Dimensions

Information:

Only B&R PClec cards that have been specially designed for the Automation PC 820 and Panel PC 800 can be used.

3.8.3 5ACPCC.ETH0-00

3.8.3.1 General information

This PCI Express compact Ethernet card has a 10/100/1000 Mbit/s network connection and can be used as an additional network interface in a PCI Express compact slot.

- PCIe Ethernet card
- 1 network connection (10/100/1000 Mbit/s)

When used in a PPC800

Information:

The adapter 5AC803.BC01-00 is required to use PCIe plug-in cards.

3.8.3.2 Order data

Model number	Short description	Figure
	Interface cards	
5ACPCC.ETH0-00	PCIe Ethernet card 1x 10/100/1000 For APC820 and PPC800.	

Table 52: 5ACPCC.ETH0-00 - Order data

3.8.3.3 Technical data

Product ID	5ACPCC.ETH0-00
General information	
B&R ID code	0xAB25
Diagnostics Data transfer	Yes, using status LED
Certification CE GOST-R	Yes Yes
Interfaces	
Ethernet Quantity Controller Design Transfer rate Cable length	1 Intel 82574 Shielded RJ45 port 10/100/1000 Mbit/s Max. 100 m between two stations (segment length)
Mechanical characteristics	
Slot	PCIe module

Table 53: 5ACPCC.ETH0-00 - Technical data

3.8.3.3.1 Ethernet interface

Information:

The following characteristics, features and limit values only apply to this individual component and can deviate from those specified for the complete system. For the complete system in which this individual component is used, refer to the data given specifically for that device.

Ethernet interface (ETH ¹⁾)		
Controller	Intel 82574	
Cabling	S/STP (Cat 5e)	
Transfer rate	10/100/1000 Mbit/s ²⁾	
Cable length	Max. 100 m (min. Cat 5e)	
Speed LED	On	Off
Green	100 Mbit/s	10 Mbit/s ³⁾
Orange	1000 Mbit/s	-
Link LED	On	Off
Orange	Link (Ethernet network connection available)	Activity (blinking - data transfer in progress)

Female RJ45 connector

1

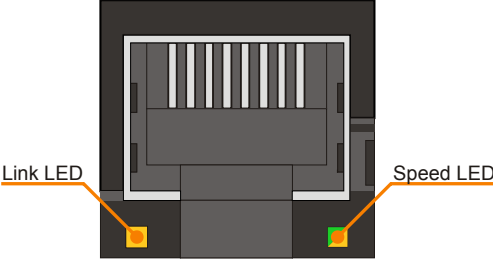

Table 54: 5ACPCC.ETH0-00 - Ethernet interface

- 1) The interfaces, etc. available on the device or module have been numbered as such for easy identification. This numbering may differ from that used by the particular operating system.
- 2) Switching takes place automatically.
- 3) The 10 Mbit/s transfer speed / connection is only present if the IF slot Link LED is also lit at the same time.

Driver support

A special driver is required in order to operate the Intel 82574 Ethernet controller. Drivers for approved operating systems are available in the Downloads section of the B&R website (www.br-automation.com).

Information:

Required drivers can only be downloaded from the B&R website, not from manufacturer websites.

3.8.4 5ACPCC.MPL0-00

3.8.4.1 General information

This PCI Express compact POWERLINK card is equipped with two POWERLINK interfaces, two station number switches and a card number switch for differentiating between modules. This PCI Express compact POWERLINK card can be used as an additional POWERLINK interface in a PCI Express compact slot.

- PClec POWERLINK card
- 2 POWERLINK interfaces
- 2 station number switches
- Card number switch

When used in a PPC800

Information:

The adapter 5AC803.BC01-00 is required to use PClec plug-in cards.

3.8.4.2 Order data

Model number	Short description	Figure
5ACPCC.MPL0-00	Interface cards PClec POWERLINK card, 2 POWERLINK interfaces, 512 kB SRAM; for APC820 and PPC800.	

Table 55: 5ACPCC.MPL0-00 - Order data

3.8.4.3 Technical data

Product ID	5ACPCC.MPL0-00
General information	
B&R ID code	0xAB27
Diagnostics Data transfer	Yes, using status LED
Certification CE GOST-R	Yes Yes
Controller	
SRAM Size Remanent variables in power failure mode	512 kB 128 kB (e.g. for Automation Runtime, see AS help documentation)
Interfaces	
POWERLINK Quantity Transmission Design Transfer rate Node switches Cable length	2 100 Base-T (ANSI/IEEE 802.3) Internal 2x hub, 2x shielded RJ45 port 100 Mbit/s 2 Max. 100 m between two stations (segment length)
Mechanical characteristics	
Slot	PClec module

Table 56: 5ACPCC.MPL0-00 - Technical data

3.8.4.3.1 POWERLINK interface

Information:

The following characteristics, features and limit values only apply to this individual component and can deviate from those specified for the complete system. For the complete system in which this individual component is used, refer to the data given specifically for that device.

POWERLINK card 2 connections		
Cabling	S/STP (Cat 5e)	
Cable length	Max. 100 m (min. Cat 5e)	
Speed LED	On	Off
Green/Red	See Status/Error LED.	
Link LED	On	Off
Yellow	Link (POWERLINK network connection available)	Activity (blinking - data transfer in progress)

Female RJ45 connector

1

Table 57: 5ACPCC.MPL0-00 - POWERLINK interface

3.8.4.3.2 Status/Error LED

The Status/Error LED is a green and red dual LED. The LED status can have different meanings depending on the operating mode.

Ethernet mode

In this mode, the interface is operated as an Ethernet interface.

Green - Status	Description
On	Interface being operated as an Ethernet interface

Table 58: Status/Error LED - Ethernet mode

POWERLINK V1

LED status indicators		Status of the POWERLINK station
Green	Red	
On	Off	The POWERLINK station is running with no errors.
Off	On	A fatal system error has occurred. The error type can be read using the PLC logbook. An irreparable problem has occurred. The system cannot properly carry out its tasks. This state can only be changed by resetting the module.
Blinking alternately		The POWERLINK managing node has failed. This error code can only occur when operated as a controlled node.
Off	Blinking	System failure. The red blinking LED signals a certain type of error using a blink code (see section "System stop error codes" on page 84).

Table 59: Status/Error LED - POWERLINK V1 operating mode

POWERLINK

Red - Error	Description
On	<p>The interface is in an error state (failed Ethernet frames, increased number of collisions on the network, etc.). If an error occurs in the following states, then the green LED blinks over the red LED:</p> <ul style="list-style-type: none"> BASIC_ETHERNET PRE_OPERATIONAL_1 PRE_OPERATIONAL_2 READY_TO_OPERATE

Table 60: Status/Error LED - POWERLINK - Error

Green - Status	Description
Off NOT_ACTIVE	<p>Mode The interface is in NOT_ACTIVE mode or:</p> <ul style="list-style-type: none"> • Switched off • Starting up • Not configured correctly in Automation Studio • Defective <p>Managing node (MN) The bus is being monitored for POWERLINK frames. If a frame is not received within the configured time window (timeout), the interface switches immediately to PRE_OPERATIONAL_1 mode (single flash). If POWERLINK communication is detected before the time expires, however, then the MN will not be started.</p> <p>Controlled node (CN) The bus is being monitored for POWERLINK frames. If a corresponding frame is not received within the defined time frame (timeout), then the module switches immediately to BASIC_ETHERNET mode (flickering). If POWERLINK communication is detected before this time expires, however, the interface switches immediately to PRE_OPERATIONAL_1 mode (single flash).</p>
Green flickering (approx. 10 Hz) BASIC_ETHERNET	<p>Mode The interface is in BASIC_ETHERNET mode and being operated as an Ethernet TCP/IP interface.</p> <p>Managing node (MN) This state can only be exited by resetting the interface.</p> <p>Controlled node (CN) If POWERLINK communication is detected while in this state, the interface switches to the PRE_OPERATIONAL_1 state (single flash).</p>
Single flash (approx. 1 Hz) PRE_OPERATIONAL_1	<p>Mode The interface is in PRE_OPERATIONAL_1 mode.</p> <p>Managing node (MN) The MN starts "reduced cycle" operation. Cyclic communication is not yet taking place.</p> <p>Controlled node (CN) The module can be configured by the MN in this state. The CN waits until it receives an SoC frame and then switches to the PRE_OPERATIONAL_2 state (double flash). An LED lit red in this state indicates failure of the MN.</p>
Double flash (approx. 1 Hz) PRE_OPERATIONAL_2	<p>Mode The interface is in the PRE_OPERATIONAL_2 state.</p> <p>Managing node (MN) The MN begins cyclic communication (cyclic input data is not yet being evaluated). The CNs are configured in this state.</p> <p>Controlled node (CN) The interface can be configured by the MN in this state. A command then switches the state to READY_TO_OPERATE (triple flash). An LED lit red in this mode indicates failure of the MN.</p>
Triple flash (approx. 1 Hz) READY_TO_OPERATE	<p>Mode The interface is in the READY_TO_OPERATE state.</p> <p>Managing node (MN) Cyclic and asynchronous communication is taking place. Any received PDO data is ignored.</p> <p>Controlled node (CN) The configuration of the module is completed. Normal cyclic and asynchronous communication is taking place. The PDO data being sent corresponds to the PDO mapping. Cyclic data is not yet being evaluated, however. An LED lit red in this mode indicates failure of the MN.</p>
On OPERATIONAL	<p>Mode The interface is in OPERATIONAL mode. PDO mapping is active and cyclic data is being evaluated.</p>
Blinking (approx. 2.5 Hz) STOPPED	<p>Mode The interface is in STOPPED mode.</p> <p>Managing node (MN) This status is not possible for the MN.</p> <p>Controlled node (CN) No output data is being produced, and no input data is being received. It is only possible to enter or leave this mode after the MN has given the appropriate command.</p>

Table 61: Status/Error LED - POWERLINK - Status

System stop error codes

Incorrect configuration or defective hardware can cause a system stop error.

The error code is indicated by the red Error LED using four switch-on phases. Each switch-on phase has a duration of either 150 ms or 600 ms. The error code is repeated every 2 seconds.

Error description	Error code indicated by red Status LED
RAM error: The interface is defective and must be replaced.	• • • - Pause • • • - Pause
Hardware error: The interface or a system component is defective and must be replaced.	- • • - Pause - • • - Pause

Table 62: System stop error codes

Key	•	...150 ms
	-	...600 ms
	Pause	2 second delay

3.8.4.3.3 POWERLINK station number

POWERLINK station number (x1, x16)		
Both of these hex switches (x16, x1) are used to configure the POWERLINK station number. Station numbers between #00 and #FD are permitted.		
Switch position		
x1	x16	Description
0	0	Operation as managing node
1 ... D	0 ... F	station number Operation as controlled node
E	F	Reserved
F	F	Reserved

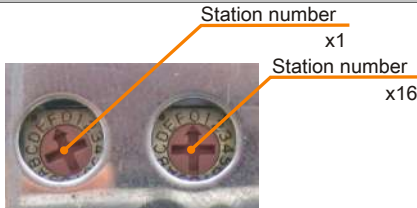

Table 63: POWERLINK station number (x1, x16)

3.8.4.3.4 Card number switch

The one-digit card number (\$1 – \$F) is configured using the card number switch. This number is used to identify the module.

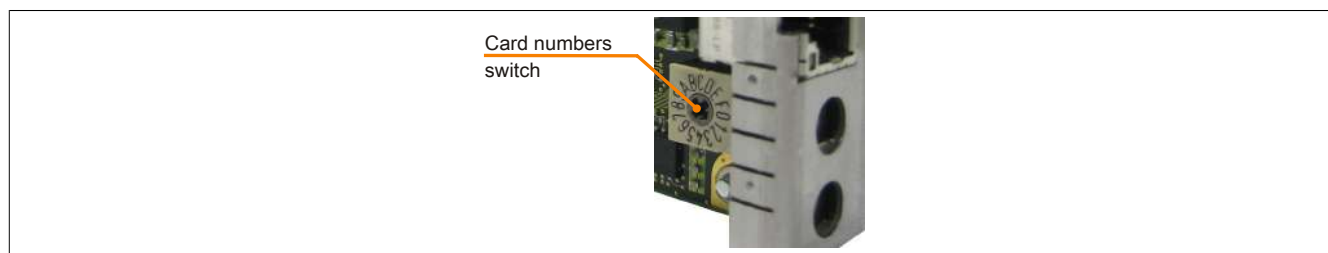

Figure 28: POWERLINK card - 2-port node number switch

If the card is operated with Automation Runtime, then the card number switch must match the slot number in Automation Studio.



Figure 29: Integrating the POWERLINK plug-in card in Automation Studio

3.8.4.3.5 SRAM

The 2-port 5ACPCC.MPL0-00 POWERLINK card has 512 kB SRAM.

3.9 Drives

3.9.1 5AC801.HDDI-00

3.9.1.1 General information

This 40 GB slide-in compact hard disk is specified for 24-hour operation, features an extended temperature range and can be used in APC810 and PPC800 system units.

When used in a PPC800

Information:

The adapter 5AC803.BC02-00 is required for the use of slide-in compact drives.

When inserted in the slide-in compact slot, the slide-in compact drive is accessed internally via SATA.

3.9.1.2 Order data

Model number	Short description	Figure
5AC801.HDDI-00	Drives 40 GB SATA slide-in compact hard disk; 24/7 operation with extended temperature range. Note: please see the manual for information about using this hard disk	

Table 64: 5AC801.HDDI-00 - Order data

3.9.1.3 Technical data

Information:

The following characteristics, features and limit values only apply to this individual component and can deviate from those specified for the complete system. For the complete system in which this individual component is used, refer to the data given specifically for that device.

Product ID	5AC801.HDDI-00
General information	
Certification	
CE	Yes
cULus	Yes
GOST-R	Yes
GL	Yes ¹⁾
Hard disk drive	
Capacity	40 GB
Number of heads	1
Number of sectors	78,140,160
Bytes per sector	512
Cache	8 MB
Speed	5400 rpm ±1%
Startup time	Typ. 3 s (from 0 rpm to read access)
MTBF	750,000 POH ²⁾
S.M.A.R.T. support	Yes
Interface	SATA
Access time	5.6 ms
Data transfer rate	
Internal	Max. 450 Mbit/s
To/From host	Max. 150 MB/s (Ultra DMA mode 5)

Table 65: 5AC801.HDDI-00 - Technical data

Product ID	5AC801.HDDI-00
Positioning time	
Minimum (track to track)	1 ms
Nominal (read only)	12.5 ms
Maximum (read only)	23 ms
Environmental conditions	
Temperature ³⁾	
Operation ⁴⁾	-30 to 85°C
24-hour operation ⁵⁾	-30 to 85°C
Storage	-40 to 95°C
Transport	-40 to 95°C
Relative humidity ⁶⁾	
Operation	5 to 90%, non-condensing
Storage	5 to 95%, non-condensing
Transport	5 to 95%, non-condensing
Vibration	
Operation	5 to 500 Hz: 2 g; no unrecoverable errors
Storage	5 to 500 Hz: 5 g; no unrecoverable errors
Transport	5 to 500 Hz: 5 g; no unrecoverable errors
Shock	
Operation	300 g and 2 ms duration; no unrecoverable errors 150 g and 11 ms duration; no unrecoverable errors
Storage	800 g and 2 ms duration; no unrecoverable errors
Transport	400 g and 0.5 ms duration; no unrecoverable errors 800 g and 2 ms duration; no unrecoverable errors 400 g and 0.5 ms duration; no unrecoverable errors
Altitude	
Operation	-300 to 5000 m
Storage	-300 to 12192 m
Mechanical characteristics	
Installation	Fixed ⁷⁾
Dimensions	
Width	13 mm
Height	98 mm
Depth	105 mm
Weight	134 g
Manufacturer information	
Manufacturer	Seagate
Manufacturer's product ID	ST940817SM

Table 65: 5AC801.HDDI-00 - Technical data

- 1) Yes, although applies only if all components installed within the complete system have this certification
- 2) With 8760 POH (power-on hours) per year and 70°C surface temperature.
- 3) Temperature values at an elevation of 305 meters. The temperature specification must be reduced linearly by 1°C every 305 meters. The temperature increase and decrease can be a maximum of 20°C per hour.
- 4) Standard operation refers to 333 POH (power-on hours) per month.
- 5) 24-hour operation refers to 732 POH (power-on hours) per month.
- 6) Humidity gradient: Maximum 15% per hour.
- 7) Slide-in compact installation.

3.9.1.4 Temperature humidity diagram

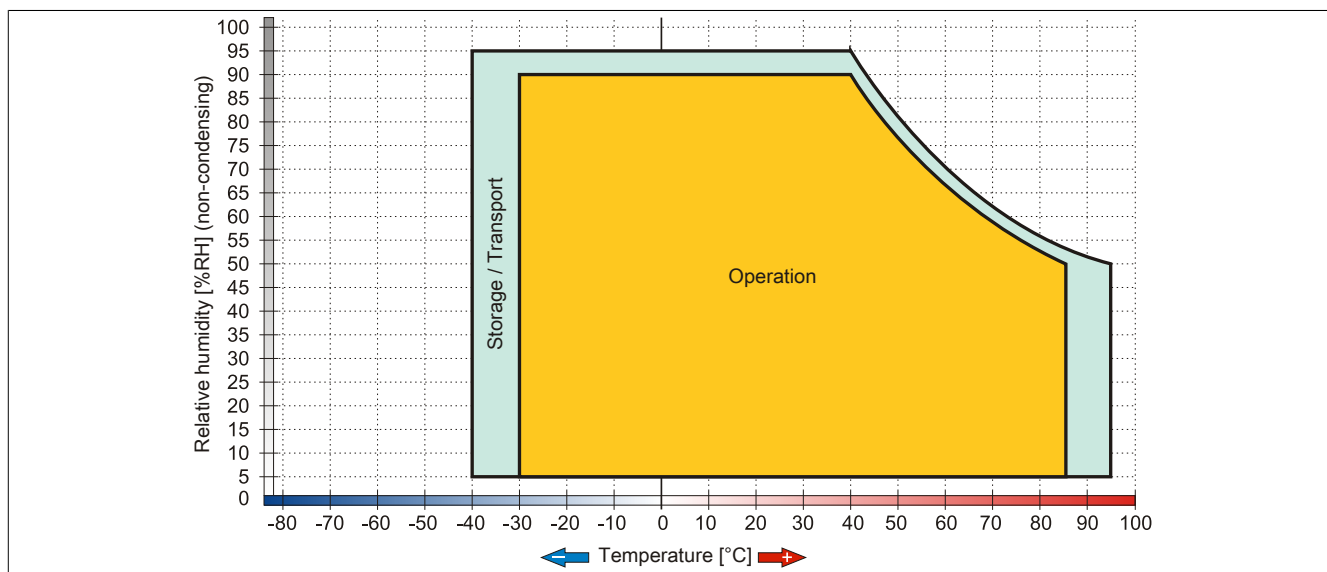

Figure 30: 5AC801.HDDI-00 - Temperature humidity diagram

3.9.2 5AC801.HDDI-02

3.9.2.1 General information

This 160 GB slide-in compact hard disk is specified for 24-hour operation, features an extended temperature range and can be used in APC810 and PPC800 system units.

When used in a PPC800

Information:

The adapter 5AC803.BC02-00 is required for the use of slide-in compact drives.

When inserted in the slide-in compact slot, the slide-in compact drive is accessed internally via SATA.

3.9.2.2 Order data

Model number	Short description	Figure
	Drives	
5AC801.HDDI-02	160 GB SATA hard disk, slide-in compact, 24/7 operation with extended temperature range. Note: please see the manual for information about using this hard disk	

Table 66: 5AC801.HDDI-02 - Order data

3.9.2.3 Technical data

Information:

The following characteristics, features and limit values only apply to this individual component and can deviate from those specified for the complete system. For the complete system in which this individual component is used, refer to the data given specifically for that device.

Product ID	5AC801.HDDI-02
General information	
Certification	
CE	Yes
cULus	Yes
GL	Yes ¹⁾
Hard disk drive	
Capacity	160 GB
Number of heads	3
Number of sectors	312,581,808
Bytes per sector	512
Cache	8 MB
Speed	5400 rpm \pm 1%
Startup time	Typ. 4 s (from 0 rpm to read access)
MTBF	300,000 POH ²⁾
S.M.A.R.T. support	Yes
Interface	SATA
Access time	12 ms
Data transfer rate	
Internal	Max. 84.6 Mbit/s
To/From host	Max. 150 MB/s (Ultra DMA mode 5)
Positioning time	
Minimum (track to track)	1.5 ms
Nominal (read only)	12 ms
Maximum (read only)	22 ms

Table 67: 5AC801.HDDI-02 - Technical data

Product ID	5AC801.HDDI-02
Environmental conditions	
Temperature ³⁾	
Operation	-15 to 80°C
24-hour operation ⁴⁾	-15 to 80°C
Storage	-40 to 95°C
Transport	-40 to 95°C
Relative humidity ⁵⁾	
Operation	8 to 90%, non-condensing ⁶⁾
Storage	5 to 95%, non-condensing ⁷⁾
Transport	5 to 95%, non-condensing ⁷⁾
Vibration	
Operation	5 to 500 Hz: 1 g; no unrecoverable errors
Storage	5 to 500 Hz: 5 g, no damage
Transport	5 to 500 Hz: 5 g, no damage
Shock	
Operation	325 g and 2 ms duration; no unrecoverable errors
Storage	900 g, 1 ms; no damage
Transport	120 g, 11 ms; no damage
Transport	900 g, 1 ms; no damage
Transport	120 g, 11 ms; no damage
Altitude	
Operation	-300 to 3000 m
Storage	-300 to 12192 m
Mechanical characteristics	
Installation	Fixed ⁸⁾
Dimensions	
Width	13 mm
Height	98 mm
Depth	105 mm
Weight	135 g
Manufacturer information	
Manufacturer	Fujitsu
Manufacturer's product ID	MHY2160BH-ESW

Table 67: 5AC801.HDDI-02 - Technical data

- 1) Yes, although applies only if all components installed within the complete system have this certification
- 2) With 8760 POH (power-on hours) per year and 70°C surface temperature.
- 3) Standard operation refers to 333 POH (power-on hours) per month.
- 4) 24-hour operation refers to 732 POH (power-on hours) per month.
- 5) Humidity gradient: Maximum 15% per hour.
- 6) Maximum humidity at 29°C.
- 7) Maximum humidity at 40°C.
- 8) Slide-in compact installation.

3.9.2.4 Temperature humidity diagram

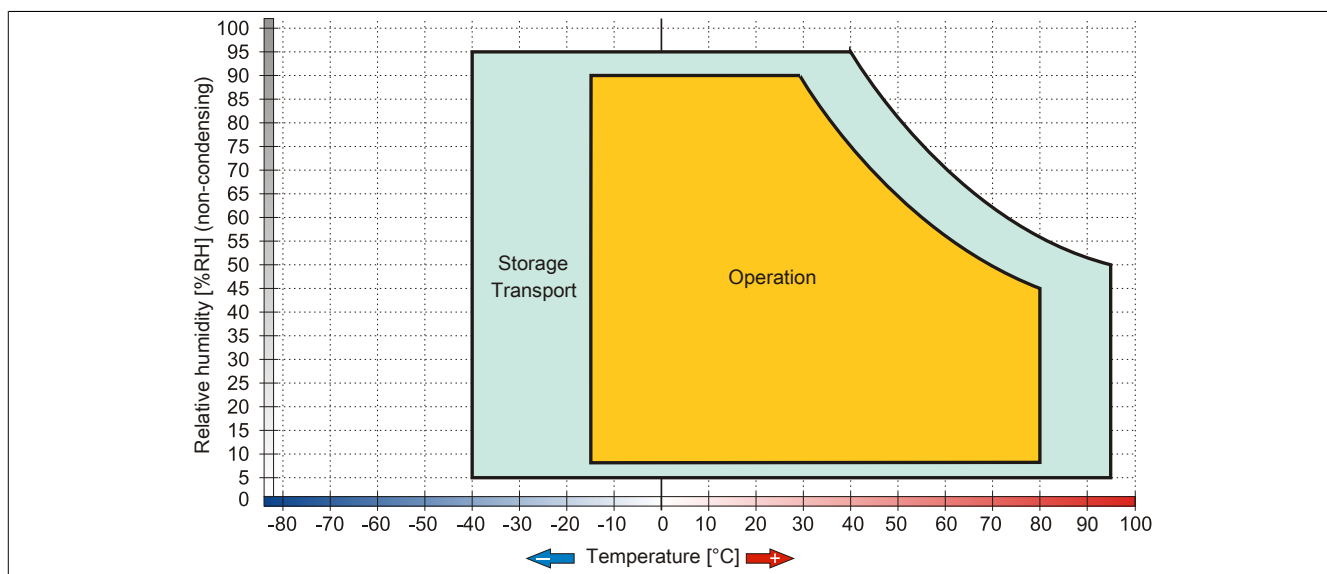

Figure 31: 5AC801.HDDI-02 - Temperature humidity diagram

3.9.3 5AC801.HDDI-03

3.9.3.1 General information

This 250 GB slide-in compact hard disk is specified for 24-hour operation and can be used in APC810 and PPC800 system units.

When used in a PPC800

Information:

The adapter 5AC803.BC02-00 is required for the use of slide-in compact drives.

When inserted in the slide-in compact slot, the slide-in compact drive is accessed internally via SATA.

3.9.3.2 Order data

Model number	Short description	Figure
	Drives	
5AC801.HDDI-03	250 GB slide-in compact SATA hard disk, 24/7 operation. Note: please see the manual for information about using this hard disk	
	Optional accessories	
	Drives	
5MMHDD.0250-00	250 GB SATA hard disk; replacement for 5AC801.HDDI-03 and 5ACPCI.RAIC-05; note: please see the manual for information about using this hard disk	

Table 68: 5AC801.HDDI-03 - Order data

3.9.3.3 Technical data

Information:

The following characteristics, features and limit values only apply to this individual component and can deviate from those specified for the complete system. For the complete system in which this individual component is used, refer to the data given specifically for that device.

Product ID	5AC801.HDDI-03
General information	
Certification	
CE	Yes
cULus	Yes
cULus HazLoc Class 1 Division 2	Yes ¹⁾
ATEX Zone 22	Yes ¹⁾
GOST-R	Yes
GL	Yes ¹⁾
Hard disk drive	
Capacity	250 GB
Number of heads	1
Number of sectors	488,397,168
Bytes per sector	512
Cache	8 MB
Speed	5400 rpm ±0.2%
Startup time	Typ. 3.6 s (from 0 rpm to read access)
MTBF	550,000 POH ²⁾
S.M.A.R.T. support	Yes
Interface	SATA
Access time	5.56 ms
Supported transfer modes	SATA 1.0, Serial ATA Revision 2.6 PIO mode 0-4, multiword DMA mode 0-2, UDMA mode 0-6
Data transfer rate	
Internal	Max. 1175 Mbit/s
To/From host	Max. 150 MB/s (SATA I), max. 300 MB/s (SATA II)

Table 69: 5AC801.HDDI-03 - Technical data

Product ID	5AC801.HDDI-03
Positioning time	
Minimum (track to track)	1 ms
Nominal (read only)	14 ms
Maximum (read only)	30 ms
Environmental conditions	
Temperature ³⁾	
Operation ⁴⁾	0 to 60°C
24-hour operation ⁵⁾	0 to 60°C
Storage	-40 to 70°C
Transport	-40 to 70°C
Relative humidity ⁶⁾	
Operation	5 to 95%, non-condensing
Storage	5 to 95%, non-condensing
Transport	5 to 95%, non-condensing
Vibration	
Operation	5 to 500 Hz: 0.5 g; no unrecoverable errors
Storage	5 to 500 Hz: 5 g; no unrecoverable errors
Transport	5 to 500 Hz: 5 g; no unrecoverable errors
Shock	
Operation	350 g and 2 ms duration; no unrecoverable errors
Storage	800 g and 2 ms duration; no unrecoverable errors
Transport	1000 g and 1 ms duration; no unrecoverable errors
Transport	600 g and 0.5 ms duration; no unrecoverable errors
Transport	800 g and 2 ms duration; no unrecoverable errors
Transport	1000 g and 1 ms duration; no unrecoverable errors
Transport	600 g and 0.5 ms duration; no unrecoverable errors
Altitude	
Operation	-300 to 3048 m
Storage	-300 to 12192 m
Mechanical characteristics	
Installation	Fixed ⁷⁾
Dimensions	
Width	13 mm
Height	98 mm
Depth	105 mm
Weight	134 g
Manufacturer information	
Manufacturer	Seagate
Manufacturer's product ID	ST9250315AS

Table 69: 5AC801.HDDI-03 - Technical data

- 1) Yes, although applies only if all components installed within the complete system have this certification
- 2) With 8760 POH (power-on hours) per year and 25°C surface temperature.
- 3) Temperature values at an elevation of 305 meters. The temperature specification must be reduced linearly by 1°C every 305 meters. The temperature increase and decrease can be a maximum of 20°C per hour.
- 4) Standard operation refers to 333 POH (power-on hours) per month.
- 5) 24-hour operation refers to 732 POH (power-on hours) per month.
- 6) Humidity gradient: Maximum 30% per hour.
- 7) Slide-in compact installation.

3.9.3.4 Temperature humidity diagram

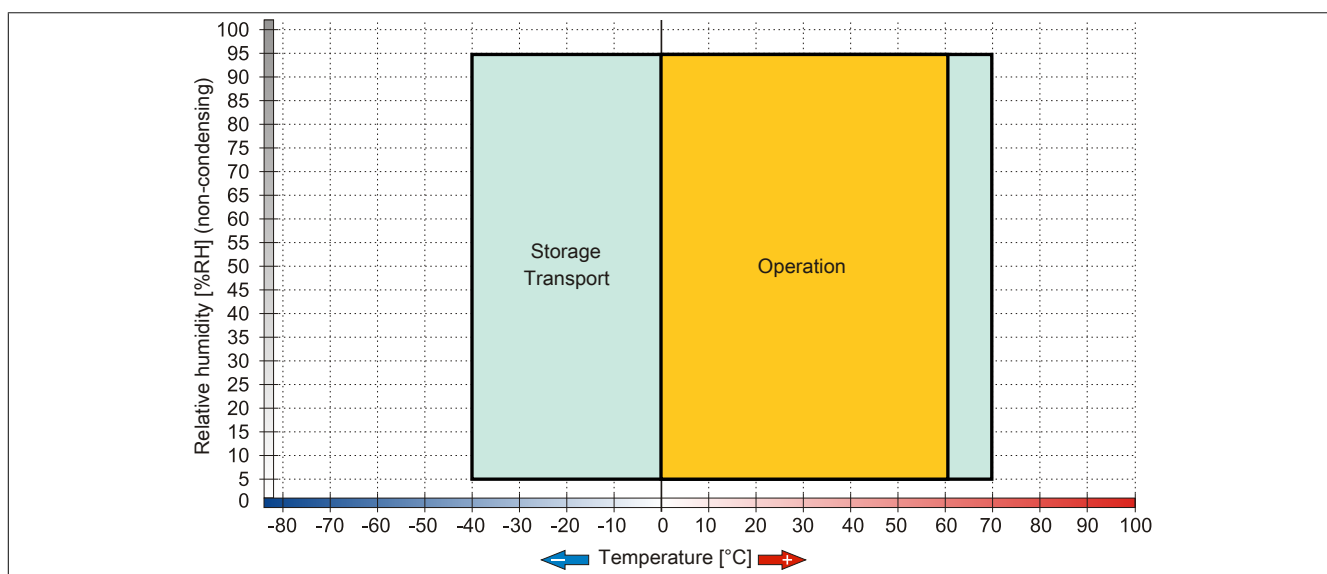

Figure 32: 5AC801.HDDI-03 - Temperature humidity diagram

3.9.4 5AC801.HDDI-04

3.9.4.1 General information

This 500 GB slide-in compact hard disk is specified for 24-hour operation and can be used in APC810 and PPC800 system units.

- 500 GB hard disk
- Slide-in compact
- Specified for 24-hour operation
- S.M.A.R.T. support

When used in a PPC800

Information:

The adapter 5AC803.BC02-00 is required for the use of slide-in compact drives.

When inserted in the slide-in compact slot, the slide-in compact drive is accessed internally via SATA.

3.9.4.2 Order data

Model number	Short description	Figure
	Drives	
5AC801.HDDI-04	500 GB SATA hard disk, slide-in compact, 24/7 operation Note: please see the manual for information about using this hard disk	
	Optional accessories	
	Drives	
5MMHDD.0500-00	500 GB hard disk - SATA	

Table 70: 5AC801.HDDI-04 - Order data

3.9.4.3 Technical data

Information:

The following characteristics, features and limit values only apply to this accessory and can deviate from those specified for the complete system. The data specifications for the complete system take precedence over those of individual components.

Product ID	5AC801.HDDI-04
General information	
Certification	
CE	Yes
cULus	Yes
GOST-R	Yes
GL	Yes ¹⁾
Hard disk drive	
Capacity	500 GB
Number of heads	2
Number of sectors	976,773,168
Bytes per sector	512 (logical) / 4096 (physical)
Cache	16 MB
Speed	5400 rpm ±0.2%
Startup time	Typ. 3.5 s (from 0 rpm to read access)
Service life	5 years
MTBF	1,000,000 POH ²⁾
S.M.A.R.T. support	Yes
Interface	SATA
Access time	5.5 ms
Supported transfer modes	SATA II
Data transfer rate	
Internal	Max. 147 MB/s
To/From host	Max. 150 MB/s (SATA I), max. 300 MB/s (SATA II)
Positioning time	
Nominal (read only)	11 ms
Maximum (read only)	21 ms

Table 71: 5AC801.HDDI-04 - Technical data

Product ID	5AC801.HDDI-04
Environmental conditions	
Temperature ³⁾	
Operation ⁴⁾	0 to 60°C
24-hour operation ⁵⁾	0 to 60°C
Storage	-40 to 70°C
Transport	-40 to 70°C
Relative humidity ⁶⁾	
Operation	5 to 95%, non-condensing
Storage	5 to 95%, non-condensing
Transport	5 to 95%, non-condensing
Vibration	
Operation (continuous)	5 to 500 Hz: 0.25 g; no unrecoverable errors
Operation (occasional)	5 to 500 Hz: 0.5 g; no unrecoverable errors
Storage	10 to 500 Hz: 5 g; no unrecoverable errors
Transport	10 to 500 Hz: 5 g; no unrecoverable errors
Shock	
Operation	400 g and 2 ms duration; no unrecoverable errors
Storage	1000 g and 2 ms duration; no unrecoverable errors
Transport	1000 g and 2 ms duration; no unrecoverable errors
Altitude	
Operation	-305 to 3048 m
Storage	-305 to 12192 m
Mechanical characteristics	
Installation	Fixed ⁷⁾
Dimensions	
Width	13 mm
Height	98 mm
Depth	105 mm
Weight	134 g
Manufacturer information	
Manufacturer	Western Digital
Manufacturer's product ID	WD5000LUCT

Table 71: 5AC801.HDDI-04 - Technical data

- 1) Yes, although applies only if all components installed within the complete system have this certification
- 2) With 8760 POH (power-on hours) per year and 25°C surface temperature.
- 3) Temperature values at an elevation of 305 meters. The temperature specification must be reduced linearly by 1°C every 305 meters. The temperature increase and decrease can be a maximum of 20°C per hour.
- 4) Standard operation refers to 333 POH (power-on hours) per month.
- 5) 24-hour operation refers to 732 POH (power-on hours) per month.
- 6) Humidity gradient: Maximum 20% per hour.
- 7) Slide-in compact installation.

3.9.4.4 Temperature humidity diagram

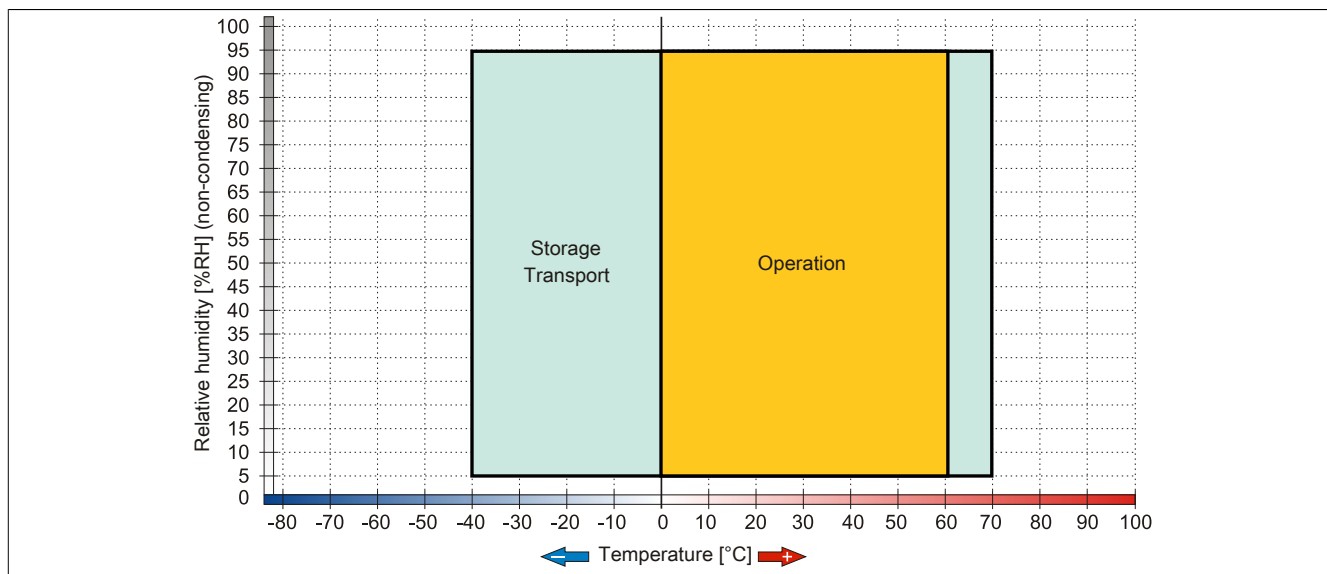

Figure 33: 5AC801.HDDI-04 - Temperature humidity diagram

3.9.5 5AC801.SSDI-00

3.9.5.1 General information

This 32 GB slide-in compact SSD (solid-state drive) is based on single-level cell (SLC) technology and can be used in APC810 and PPC800 system units.

When used in a PPC800

Information:

The adapter 5AC803.BC02-00 is required for the use of slide-in compact drives.

When inserted in the slide-in compact slot, the slide-in compact drive is accessed internally via SATA.

3.9.5.2 Order data

Model number	Short description	Figure
	Drives	
5AC801.SSDI-00	32 GB SATA SSD (SLC), slide-in compact	

Table 72: 5AC801.SSDI-00 - Order data

3.9.5.3 Technical data

Caution!

A sudden power failure may result in data loss! In very rare cases, the mass storage device may also become damaged.

To prevent damage and loss of data, the use of a UPS is recommended.

Information:

The following characteristics, features and limit values only apply to this individual component and can deviate from those specified for the complete system. For the complete system in which this individual component is used, refer to the data given specifically for that device.

Product ID	5AC801.SSDI-00
General information	
Certification	
CE	Yes
cULus	Yes
GOST-R	Yes
GL	Yes ¹⁾
Solid state drive	
Capacity	32 GB
Data reliability	<1 unrecoverable error in 10 ¹⁵ bit read accesses
MTBF	2,000,000 hours
Power on/off cycles	50,000
S.M.A.R.T. support	Yes
Interface	SATA
Maintenance	None
Continuous reading	Max. 250 MB/s
Continuous writing	Max. 170 MB/s

Table 73: 5AC801.SSDI-00 - Technical data

Product ID	5AC801.SSDI-00
IOPS ²⁾	
4k read	35,000
4k write	3,300
Endurance	
SLC flash	Yes
Guaranteed data volume	
Guaranteed	700 TB
Results for 5 years	350 GB/day
Wear leveling	Static
Error correction coding (ECC)	Yes
Compatibility	SATA revision 2.6 compliant, compatible with SATA 1.5 Gbit/s and 3 Gbit/s interface rates ATA/ATAPI-7 SSD Enhanced SMART ATA feature set Native Command Queuing (NCQ)
Environmental conditions	
Temperature	
Operation	0 to 70°C
Storage	-55 to 95°C
Transport	-55 to 95°C
Relative humidity	
Operation	5 to 95%, non-condensing
Storage	5 to 95%, non-condensing
Transport	5 to 95%, non-condensing
Vibration	
Operation	7 to 800 Hz: 2.17 g
Storage	10 to 500 Hz: 3.13 g
Transport	10 to 500 Hz: 3.13 g
Shock	
Operation	1000 g, 0.5 ms
Storage	1000 g, 0.5 ms
Transport	1000 g, 0.5 ms
Altitude	
Operation	-300 to 12192 m
Storage	-300 to 12192 m
Transport	-300 to 12192 m
Mechanical characteristics	
Installation	Fixed ³⁾
Dimensions	
Width	13 mm
Height	98 mm
Depth	105 mm
Weight	118 g
Manufacturer information	
Manufacturer	Intel
Manufacturer's product ID	SSDSA2SH032G1

Table 73: 5AC801.SSDI-00 - Technical data

- 1) Yes, although applies only if all components installed within the complete system have this certification
- 2) IOPS: Random read and write input/output operations per second.
- 3) Slide-in compact installation.

3.9.5.4 Temperature/Humidity diagram

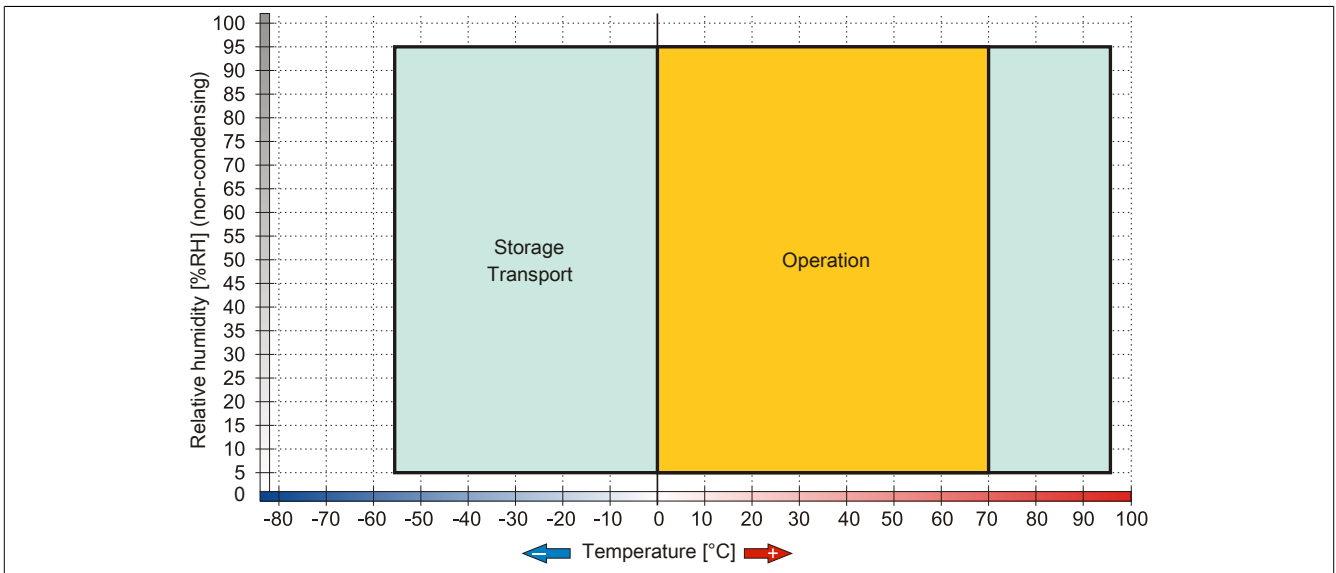

Figure 34: 5AC801.SSDI-00 - Temperature/Humidity diagram

3.9.5.5 Benchmark

The following two benchmarks show a comparison of the Intel solid-state drive (5AC801.SSDI-00) and the Seagate hard disk (5AC801.HDDI-00) for cyclic reading and writing.

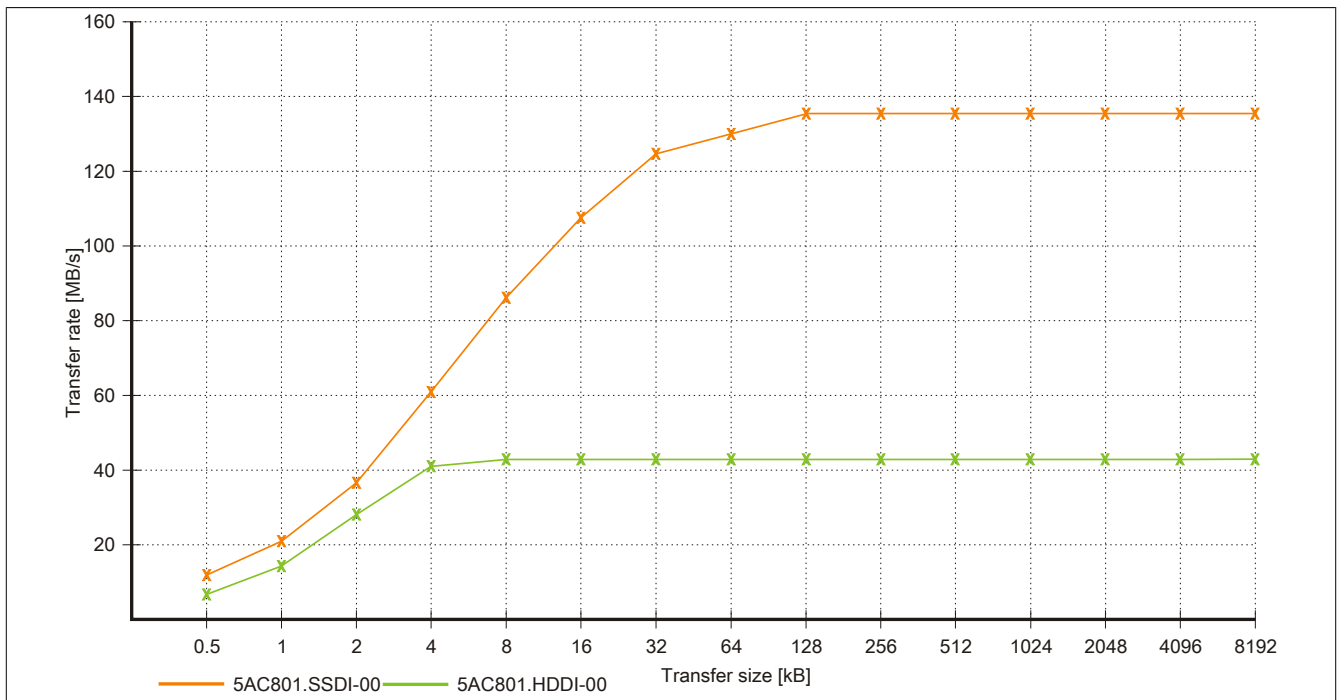

Figure 35: 5AC801.SSDI-00 - ATTO disk benchmark v2.34 - cyclic read

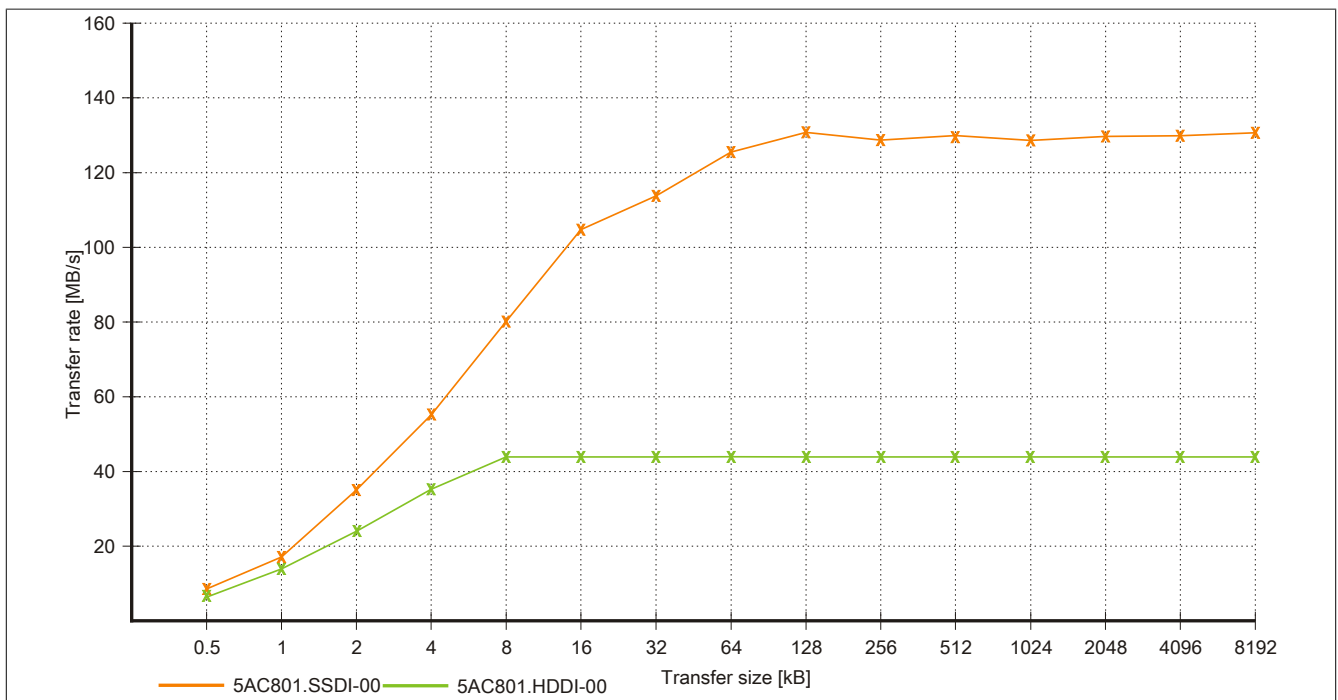

Figure 36: 5AC801.SSDI-00 - ATTO disk benchmark v2.34 - cyclic write

3.9.6 5AC801.SSDI-01

3.9.6.1 General information

This 60 GB slide-in compact SSD (solid-state drive) is based on multi-level cell (MLC) technology and can be used in APC810 and PPC800 system units.

When used in a PPC800

Information:

The adapter 5AC803.BC02-00 is required for the use of slide-in compact drives.

When inserted in the slide-in compact slot, the slide-in compact drive is accessed internally via SATA.

3.9.6.2 Order data

Model number	Short description	Figure
	Drives	
5AC801.SSDI-01	60 GB SATA slide-in compact SSD (MLC)	
	Optional accessories	
	Drives	
5MMSSD.0060-00	60 GB SSD MLC - Intel - SATA	

Table 74: 5AC801.SSDI-01 - Order data

3.9.6.3 Technical data

Caution!

A sudden power failure may result in data loss! In very rare cases, the mass storage device may also become damaged.

To prevent damage and loss of data, the use of a UPS is recommended.

Information:

The following characteristics, features and limit values only apply to this accessory and can deviate from those specified for the complete system. The data specifications for the complete system take precedence over those of individual components.

Product ID	5AC801.SSDI-01
General information	
Certification	
CE	Yes
cULus	Yes
GOST-R	Yes
GL	Yes ¹⁾
Solid-state drive	
Capacity	60 GB
Data reliability	<1 unrecoverable error in 10 ¹⁶ bit read accesses
MTBF	1,200,000 hours
S.M.A.R.T. support	Yes
Interface	SATA
Maintenance	None
Sequential read	Max. 550 MB/s with SATA 6 Gbit/s Max. 280 MB/s with SATA 3 Gbit/s
Sequential write	Max. 475 MB/s with SATA 6 Gbit/s Max. 245 MB/s with SATA 3 Gbit/s

Table 75: 5AC801.SSDI-01 - Technical data

Product ID	5AC801.SSDI-01
IOPS ²⁾	
4k read	15,000
4k write	
Typical	23,000
Maximum	80,000
Endurance	
MLC flash	Yes
Compatibility	SATA 3.0 compliant ACS-2 SSD Enhanced SMART ATA feature set Native Command Queuing (NCQ)
Environmental conditions	
Temperature	
Operation	0 to 70°C
Storage	-55 to 95°C
Transport	-55 to 95°C
Relative humidity	
Operation	5 to 95%, non-condensing
Storage	5 to 95%, non-condensing
Transport	5 to 95%, non-condensing
Vibration	
Operation	5 to 700 Hz: 2.17 g
Storage	5 to 800 Hz: 3.13 g
Transport	5 to 800 Hz: 3.13 g
Shock	
Operation	1500 g, 0.5 ms
Storage	1500 g, 0.5 ms
Transport	1500 g, 0.5 ms
Altitude	
Operation	-300 to 12192 m
Storage	-300 to 12192 m
Transport	-300 to 12192 m
Mechanical characteristics	
Installation	Fixed ³⁾
Dimensions	
Width	13 mm
Height	98 mm
Depth	105 mm
Weight	118 g
Manufacturer information	
Manufacturer	Intel
Manufacturer's product ID	SSDSC2CW060A3

Table 75: 5AC801.SSDI-01 - Technical data

- 1) Yes, although applies only if all components installed within the complete system have this certification
- 2) IOPS: Random read and write input/output operations per second.
- 3) Slide-in compact installation.

3.9.6.4 Temperature humidity diagram

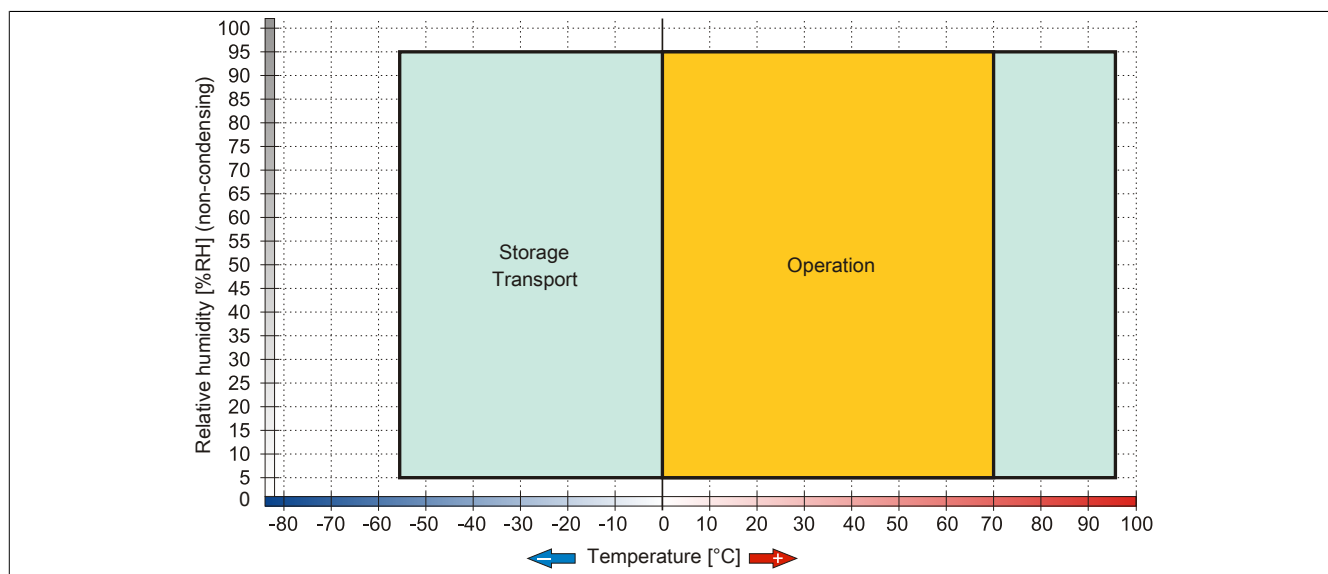

Figure 37: 5AC801.SSDI-01 - Temperature humidity diagram

3.9.7 5AC801.SSDI-02

3.9.7.1 General information

This 180 GB slide-in compact SSD (solid-state drive) is based on multi-level cell (MLC) technology and can be used in APC810 and PPC800 system units.

When used in a PPC800

Information:

The adapter 5AC803.BC02-00 is required for the use of slide-in compact drives.

When inserted in the slide-in compact slot, the slide-in compact drive is accessed internally via SATA.

3.9.7.2 Order data

Model number	Short description	Figure
	Drives	
5AC801.SSDI-02	180 GB SATA slide-in compact SSD (MLC)	
	Optional accessories	
	Drives	
5MMSSD.0180-00	180 GB SSD MLC - Intel - SATA	

Table 76: 5AC801.SSDI-02 - Order data

3.9.7.3 Technical data

Caution!

A sudden power failure may result in data loss! In very rare cases, the mass storage device may also become damaged.

To prevent damage and loss of data, the use of a UPS is recommended.

Information:

The following characteristics, features and limit values only apply to this accessory and can deviate from those specified for the complete system. The data specifications for the complete system take precedence over those of individual components.

Product ID	5AC801.SSDI-02
General information	
Certification	
CE	Yes
cULus	Yes
GOST-R	Yes
GL	Yes ¹⁾
Solid-state drive	
Capacity	180 GB
Data reliability	<1 unrecoverable error in 10 ¹⁶ bit read accesses
MTBF	1,200,000 hours
S.M.A.R.T. support	Yes
Interface	SATA
Maintenance	None
Sequential read	Max. 550 MB/s with SATA 6 Gbit/s Max. 280 MB/s with SATA 3 Gbit/s
Sequential write	Max. 520 MB/s with SATA 6 Gbit/s Max. 260 MB/s with SATA 3 Gbit/s

Table 77: 5AC801.SSDI-02 - Technical data

Product ID	5AC801.SSDI-02
IOPS ²⁾	
4k read	50,000
4k write	
Typical	60,000
Maximum	80,000
Endurance	
MLC flash	Yes
Compatibility	SATA 3.0 compliant ACS-2 SSD Enhanced SMART ATA feature set Native Command Queuing (NCQ)
Environmental conditions	
Temperature	
Operation	0 to 70°C
Storage	-55 to 95°C
Transport	-55 to 95°C
Relative humidity	
Operation	5 to 95%, non-condensing
Storage	5 to 95%, non-condensing
Transport	5 to 95%, non-condensing
Vibration	
Operation	5 to 700 Hz: 2.17 g
Storage	5 to 800 Hz: 3.13 g
Transport	5 to 800 Hz: 3.13 g
Shock	
Operation	1500 g, 0.5 ms
Storage	1500 g, 0.5 ms
Transport	1500 g, 0.5 ms
Altitude	
Operation	-300 to 12192 m
Storage	-300 to 12192 m
Transport	-300 to 12192 m
Mechanical characteristics	
Installation	Fixed ³⁾
Dimensions	
Width	13 mm
Height	98 mm
Depth	105 mm
Weight	118 g
Manufacturer information	
Manufacturer	Intel
Manufacturer's product ID	SSDSC2CW180A3

Table 77: 5AC801.SSDI-02 - Technical data

- 1) Yes, although applies only if all components installed within the complete system have this certification
- 2) IOPS: Random read and write input/output operations per second.
- 3) Slide-in compact installation.

3.9.7.4 Temperature humidity diagram

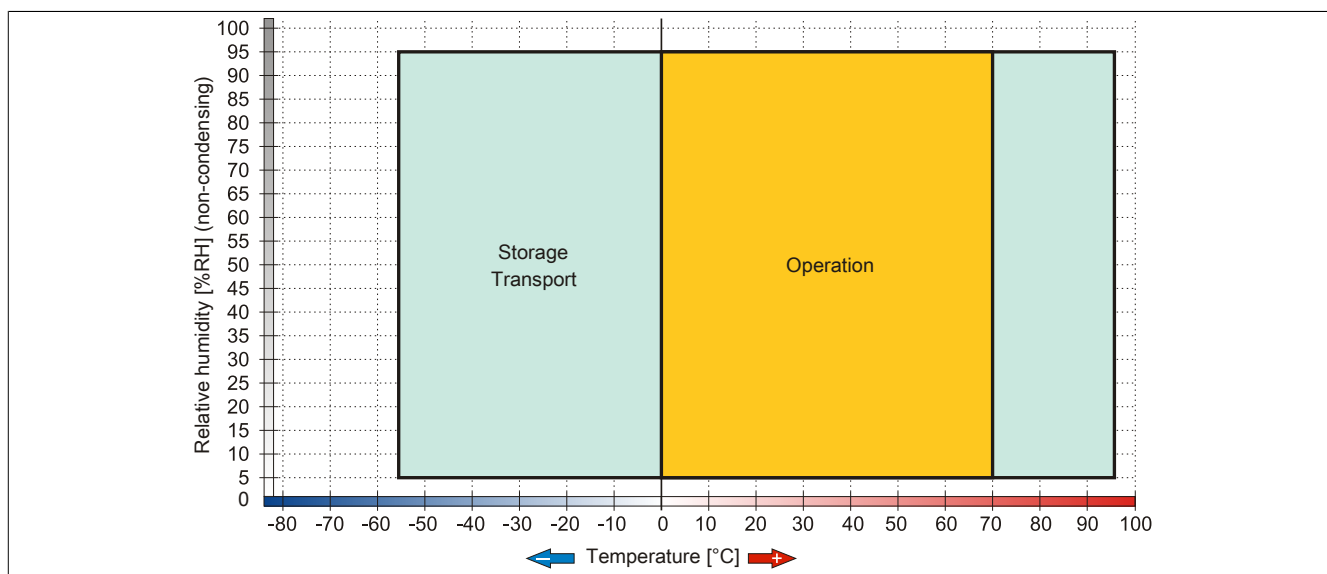

Figure 38: 5AC801.SSDI-02 - Temperature humidity diagram

3.9.8 5AC801.SSDI-03

3.9.8.1 General information

This 60 GB slide-in compact SSD (solid-state drive) is based on multi-level cell (MLC) technology and can be used in APC810 and PPC800 system units.

When used in a PPC800

Information:

The adapter 5AC803.BC02-00 is required for the use of slide-in compact drives.

When inserted in the slide-in compact slot, the slide-in compact drive is accessed internally via SATA.

3.9.8.2 Order data

Model number	Short description	Figure
	Drives	
5AC801.SSDI-03	60 GB SATA slide-in compact SSD (MLC)	
	Optional accessories	
	Drives	
5MMSSD.0060-01	60 GB SSD MLC - Intel - SATA	

Table 78: 5AC801.SSDI-03 - Order data

3.9.8.3 Technical data

Caution!

A sudden power failure may result in data loss! In very rare cases, the mass storage device may also become damaged.

To prevent damage and loss of data, the use of a UPS is recommended.

Information:

The following characteristics, features and limit values only apply to this accessory and can deviate from those specified for the complete system. The data specifications for the complete system take precedence over those of individual components.

Product ID	5AC801.SSDI-03	
Revision	C0	D0
General information		
Certification		
CE		Yes
cULus		Yes
GOST-R		Yes
GL		Yes ¹⁾
Solid-state drive		
Capacity		60 GB
Data reliability		<1 unrecoverable error in 10 ¹⁵ bit read accesses
MTBF		1,500,000 hours
S.M.A.R.T. support		Yes
Interface		SATA
Maintenance		None
Sequential read		Max. 510 MB/s
Sequential write		Max. 430 MB/s
IOPS ²⁾		
4k read		Max. 50,000 (random)
4k write		Max. 25,000 (random)
Endurance		
MLC flash		Yes
Guaranteed data volume		
Guaranteed		35 TBW ³⁾
Compatibility		SATA 3.0 compliant ACS-2 SSD Enhanced SMART ATA feature set Native Command Queuing (NCQ)

Table 79: 5AC801.SSDI-03, 5AC801.SSDI-03 - Technical data

Product ID	5AC801.SSDI-03	
Environmental conditions		
Temperature	0 to 70°C	-30 to 85°C
Operation		
Storage		-40 to 85°C
Transport		-40 to 85°C
Relative humidity		
Operation	8 to 90%, non-condensing	5 to 90%, non-condensing
Storage	8 to 95%, non-condensing	5 to 95%, non-condensing
Transport	8 to 95%, non-condensing	5 to 95%, non-condensing
Vibration		
Operation		10 to 2000 Hz: 20 g
Storage		10 to 2000 Hz: 20 g
Transport		10 to 2000 Hz: 20 g
Shock		
Operation		1500 g, 0.5 ms
Storage		1500 g, 0.5 ms
Transport		1500 g, 0.5 ms
Altitude		
Operation		-300 to 12192 m
Storage		-300 to 12192 m
Transport		-300 to 12192 m
Mechanical characteristics		
Installation		Fixed ⁴⁾
Dimensions		
Width		13 mm
Height		98 mm
Depth		105 mm
Weight		118 g
Manufacturer information		
Manufacturer		Toshiba
Manufacturer's product ID	THNSNH060GBST	THNSNJ060WCST

Table 79: 5AC801.SSDI-03, 5AC801.SSDI-03 - Technical data

- 1) Yes, although applies only if all components installed within the complete system have this certification
- 2) IOPS: Random read and write input/output operations per second.
- 3) TBW: Terabytes written
- 4) Slide-in compact installation.

3.9.8.4 Temperature humidity diagram

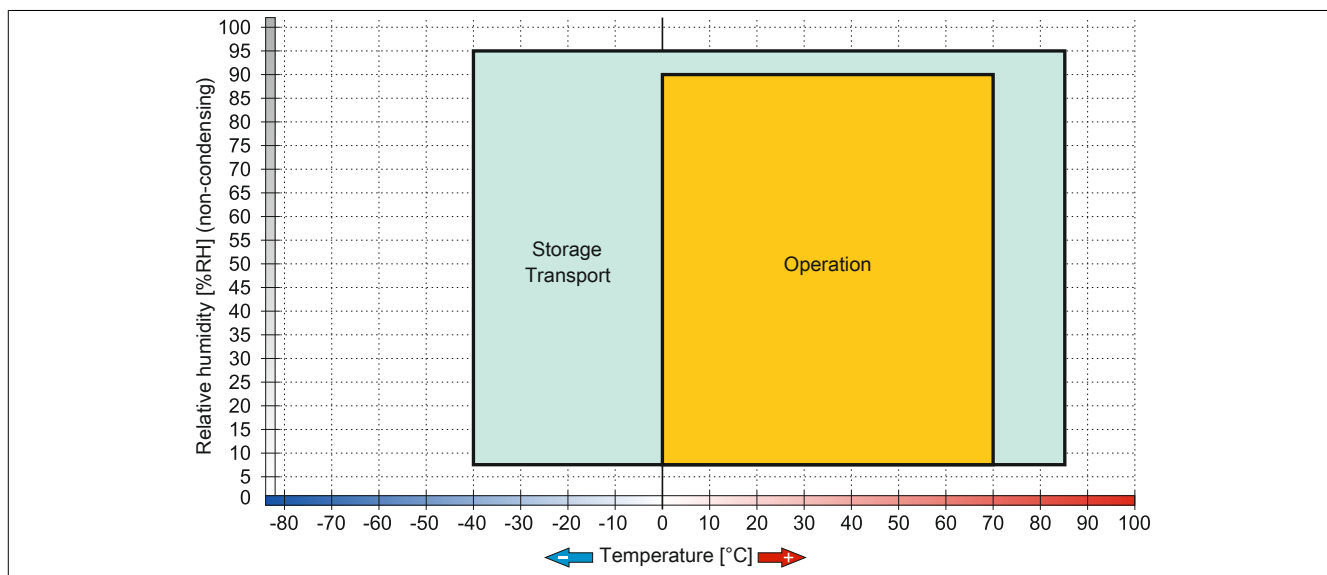

Figure 39: 5AC801.SSDI-03 ≤ Rev. C0 - Temperature/Humidity diagram

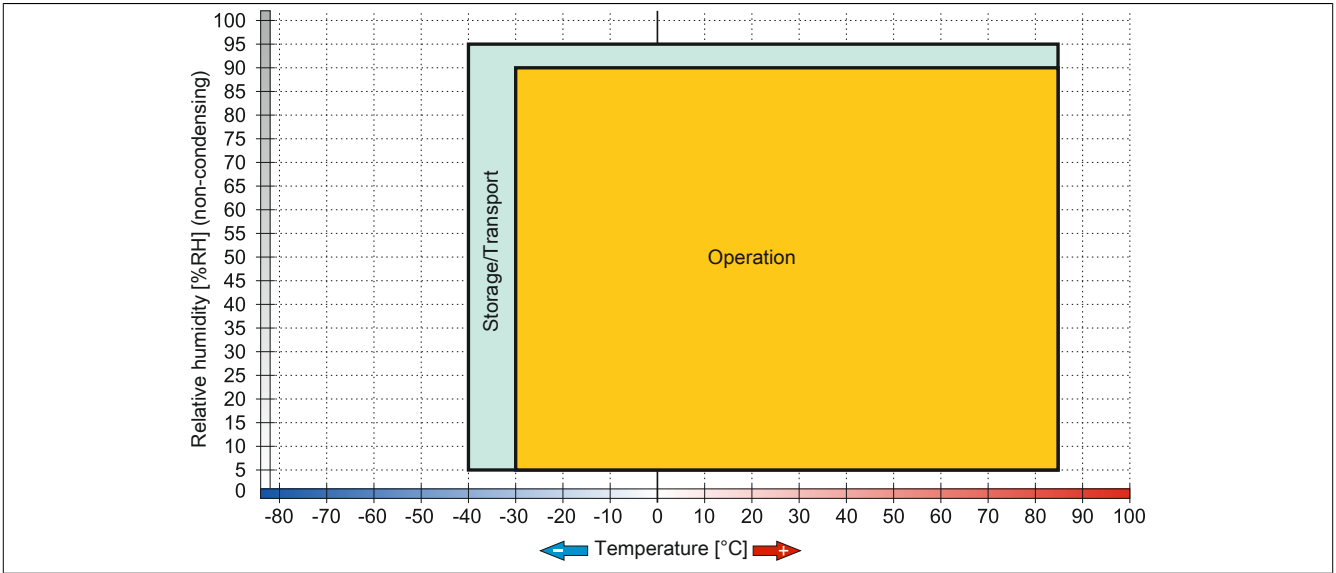

Figure 40: 5AC801.SSDI-03 ≥ Rev. D0 - Temperature/Humidity diagram

3.9.9 5AC801.SSDI-04

3.9.9.1 General information

This 128 GB slide-in compact SSD (solid-state drive) is based on multi-level cell (MLC) technology and can be used in APC810 and PPC800 system units.

When used in a PPC800

Information:

The adapter 5AC803.BC02-00 is required for the use of slide-in compact drives.

When inserted in the slide-in compact slot, the slide-in compact drive is accessed internally via SATA.

3.9.9.2 Order data

Model number	Short description	Figure
	Drives	
5AC801.SSDI-04	128 GB SATA SSD (MLC), slide-in compact	
	Optional accessories	
	Drives	
5MMSSD.0128-01	128 GB SSD MLC - Toshiba - SATA	

Table 80: 5AC801.SSDI-04 - Order data

3.9.9.3 Technical data

Caution!

A sudden power failure may result in data loss! In very rare cases, the mass storage device may also become damaged.

To prevent damage and loss of data, the use of a UPS is recommended.

Information:

The following characteristics, features and limit values only apply to this accessory and can deviate from those specified for the complete system. The data specifications for the complete system take precedence over those of individual components.

Product ID	5AC801.SSDI-04	
Revision	C0	D0
General information		
Certification		
CE		Yes
cULus		Yes
GOST-R		Yes
GL		Yes ¹⁾
Solid-state drive		
Capacity		128 GB
Data reliability		<1 unrecoverable error in 10 ¹⁵ bit read accesses
MTBF		1,500,000 hours
S.M.A.R.T. support		Yes
Interface		SATA
Maintenance		None
Sequential read		Max. 510 MB/s
Sequential write		Max. 450 MB/s

Table 81: 5AC801.SSDI-04, 5AC801.SSDI-04 - Technical data

Product ID		5AC801.SSDI-04	
IOPS ²⁾ 4k read 4k write		Max. 85,000 (random) Max. 35,000 (random)	
Endurance			
MLC flash		Yes	
Guaranteed data volume Guaranteed		74 TBW ³⁾	
Compatibility		SATA 3.0 compliant ACS-2 SSD Enhanced SMART ATA feature set Native Command Queuing (NCQ)	
Environmental conditions			
Temperature Operation Storage Transport	0 to 70°C	-40 to 85°C	-30 to 85°C
Relative humidity Operation Storage Transport	8 to 90%, non-condensing 8 to 95%, non-condensing 8 to 95%, non-condensing		5 to 90%, non-condensing 5 to 95%, non-condensing 5 to 95%, non-condensing
Vibration Operation Storage Transport		10 to 2000 Hz: 20 g 10 to 2000 Hz: 20 g 10 to 2000 Hz: 20 g	
Shock Operation Storage Transport		1500 g, 0.5 ms 1500 g, 0.5 ms 1500 g, 0.5 ms	
Altitude Operation Storage Transport		-300 to 12192 m -300 to 12192 m -300 to 12192 m	
Mechanical characteristics			
Installation		Fixed ⁴⁾	
Dimensions Width Height Depth		13 mm 98 mm 105 mm	
Weight		118 g	
Manufacturer information			
Manufacturer		Toshiba	
Manufacturer's product ID	THNSNH128GBST		THNSNJ128WCST

Table 81: 5AC801.SSDI-04, 5AC801.SSDI-04 - Technical data

- 1) Yes, although applies only if all components installed within the complete system have this certification
- 2) IOPS: Random read and write input/output operations per second.
- 3) TBW: Terabytes written
- 4) Slide-in compact installation.

3.9.9.4 Temperature humidity diagram

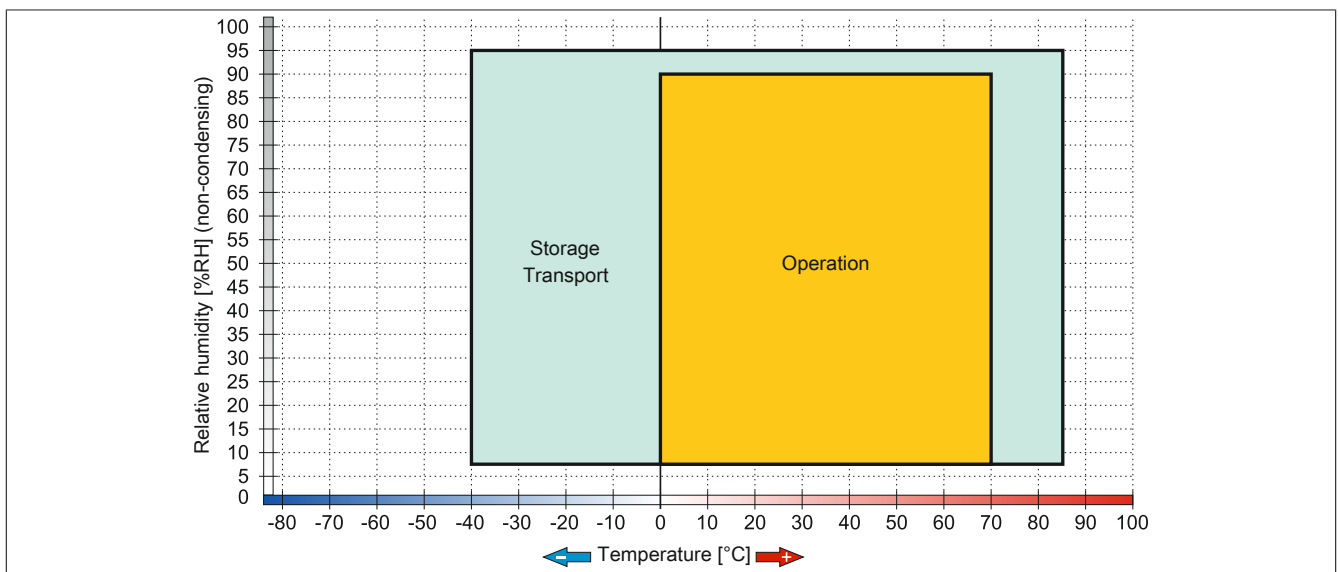

Figure 41: 5AC801.SSDI-04 ≤ Rev. C0 - Temperature/Humidity diagram

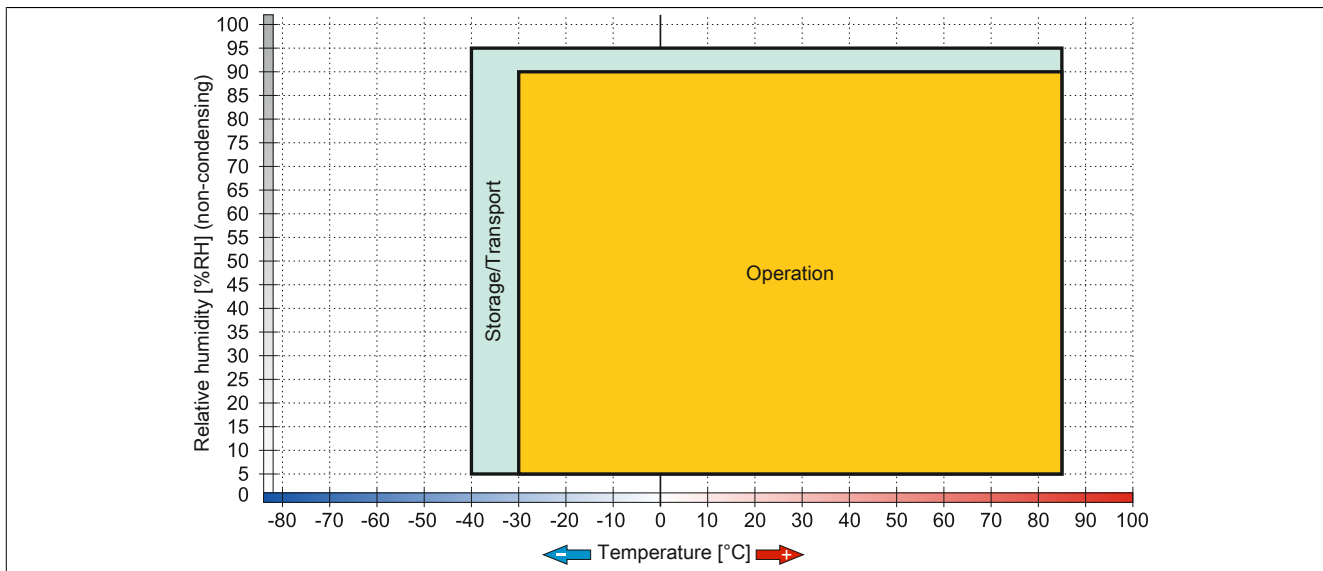

Figure 42: 5AC801.SSDI-04 ≥ Rev. D0 - Temperature/Humidity diagram

3.9.10 5AC801.SSDI-05

3.9.10.1 General information

This 256 GB slide-in compact SSD (solid-state drive) is based on multi-level cell (MLC) technology and can be used in APC810 and PPC800 system units.

When used in a PPC800

Information:

The adapter 5AC803.BC02-00 is required for the use of slide-in compact drives.

When inserted in the slide-in compact slot, the slide-in compact drive is accessed internally via SATA.

3.9.10.2 Order data

Model number	Short description	Figure
	Drives	
5AC801.SSDI-05	256 GB SATA slide-in compact SSD (MLC)	
	Optional accessories	
	Drives	
5MMSSD.0256-00	256 GB SSD MLC - Slide-in compact - Toshiba - SATA	

Table 82: 5AC801.SSDI-05 - Order data

3.9.10.3 Technical data

Caution!

A sudden power failure may result in data loss! In very rare cases, the mass storage device may also become damaged.

To prevent damage and loss of data, the use of a UPS is recommended.

Information:

The following characteristics, features and limit values only apply to this accessory and can deviate from those specified for the complete system. The data specifications for the complete system take precedence over those of individual components.

Product ID	5AC801.SSDI-05
General information	
Certification	
CE	Yes
cULus	Yes
GOST-R	Yes
GL	Yes ¹⁾
Solid-state drive	
Capacity	256 GB
Data reliability	<1 unrecoverable error in 10 ¹⁵ bit read accesses
MTBF	1,500,000 hours
S.M.A.R.T. support	Yes
Interface	SATA
Maintenance	None
Sequential read	Max. 510 MB/s
Sequential write	Max. 460 MB/s
IOPS ²⁾	
4k read	Max. 90,000 (random)
4k write	Max. 35,000 (random)

Table 83: 5AC801.SSDI-05 - Technical data

Product ID	5AC801.SSDI-05
Endurance	
MLC flash	Yes
Guaranteed data volume Guaranteed	148 TBW ³⁾
Compatibility	SATA 3.0 compliant ACS-2 SSD Enhanced SMART ATA feature set Native Command Queuing (NCQ)
Environmental conditions	
Temperature	
Operation	-30 to 85°C
Storage	-40 to 85°C
Transport	-40 to 85°C
Relative humidity	
Operation	5 to 90%, non-condensing
Storage	5 to 95%, non-condensing
Transport	5 to 95%, non-condensing
Vibration	
Operation	10 to 2000 Hz: 20 g
Storage	10 to 2000 Hz: 20 g
Transport	10 to 2000 Hz: 20 g
Shock	
Operation	1500 g, 0.5 ms
Storage	1500 g, 0.5 ms
Transport	1500 g, 0.5 ms
Altitude	
Operation	-300 to 12192 m
Storage	-300 to 12192 m
Transport	-300 to 12192 m
Mechanical characteristics	
Installation	Fixed ⁴⁾
Dimensions	
Width	13 mm
Height	98 mm
Depth	105 mm
Weight	118 g
Manufacturer information	
Manufacturer	Toshiba
Manufacturer's product ID	THNSNJ256WCST

Table 83: 5AC801.SSDI-05 - Technical data

- 1) Yes, although applies only if all components installed within the complete system have this certification
- 2) IOPS: Random read and write input/output operations per second.
- 3) TBW: Terabytes written
- 4) Slide-in compact installation.

3.9.10.4 Temperature humidity diagram

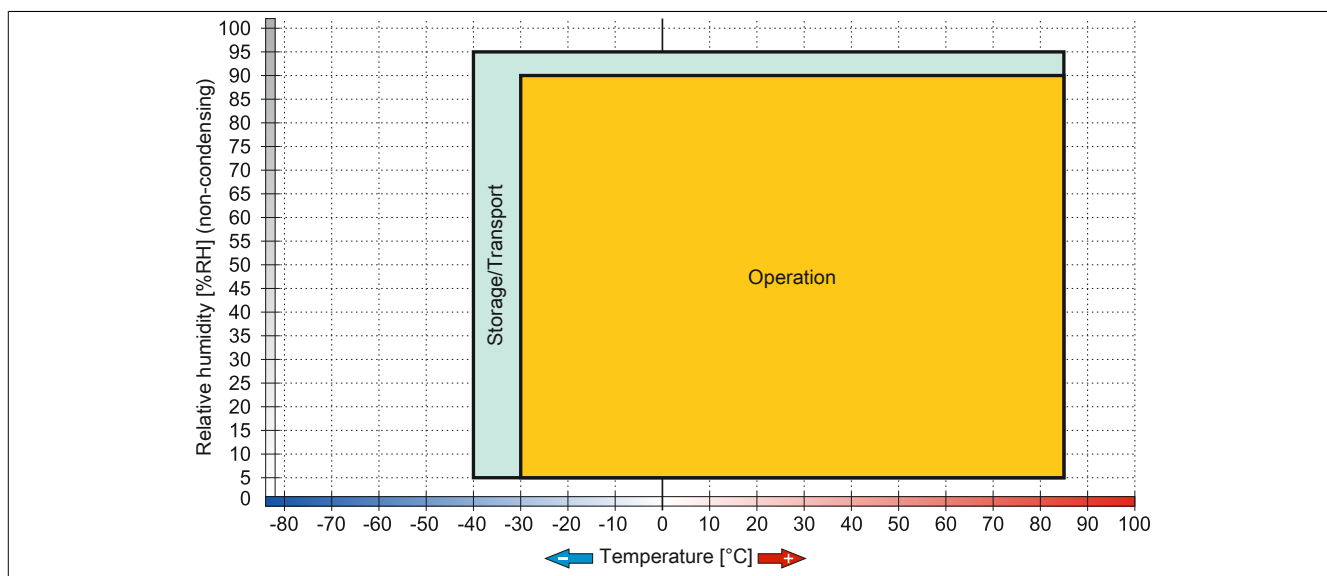

Figure 43: 5AC801.SSDI-05 - Temperature humidity diagram

3.9.11 5MMSSD.0060-00

3.9.11.1 General information

This 60 GB slide-in compact SSD (solid-state drive) is based on multi-level cell (MLC) technology and can be used as a replacement or accessory part.

- Replacement for 5AC801.SSDI-01 or 5AC901.CSSD-01 SSD drives
- Accessory for the APC510 (optional SSD for I/O board)

3.9.11.2 Order data

Model number	Short description	Figure
	Drives	
5MMSSD.0060-00	60 GB SSD MLC - Intel - SATA	

Table 84: 5MMSSD.0060-00 - Order data

3.9.11.3 Technical data

Caution!

A sudden power failure may result in data loss! In very rare cases, the mass storage device may also become damaged.

To prevent damage and loss of data, the use of a UPS is recommended.

Information:

The following characteristics, features and limit values only apply to this accessory and can deviate from those specified for the complete system. The data specifications for the complete system take precedence over those of individual components.

Product ID	5MMSSD.0060-00
General information	
Certification	
CE	Yes
cULus	Yes
cULus HazLoc Class 1 Division 2	Yes ¹⁾
GOST-R	Yes
Solid-state drive	
Capacity	60 GB
Data reliability	<1 unrecoverable error in 10 ¹⁶ bit read accesses
MTBF	1,200,000 hours
S.M.A.R.T. support	Yes
Interface	SATA
Maintenance	None
Sequential read	Max. 550 MB/s with SATA 6 Gbit/s Max. 280 MB/s with SATA 3 Gbit/s
Sequential write	Max. 475 MB/s with SATA 6 Gbit/s Max. 245 MB/s with SATA 3 Gbit/s
IOPS ²⁾	
4k read	15,000
4k write	
Typical	23,000
Maximum	80,000
Endurance	
MLC flash	Yes
Compatibility	SATA 3.0 compliant ACS-2 SSD Enhanced SMART ATA feature set Native Command Queuing (NCQ)

Table 85: 5MMSSD.0060-00 - Technical data

Product ID	5MMSSD.0060-00
Environmental conditions	
Temperature	
Operation	0 to 70°C
Storage	-55 to 95°C
Transport	-55 to 95°C
Relative humidity	
Operation	5 to 95%, non-condensing
Storage	5 to 95%, non-condensing
Transport	5 to 95%, non-condensing
Vibration	
Operation	5 to 700 Hz: 2.17 g
Storage	5 to 800 Hz: 3.13 g
Transport	5 to 800 Hz: 3.13 g
Shock	
Operation	1500 g, 0.5 ms
Storage	1500 g, 0.5 ms
Transport	1500 g, 0.5 ms
Altitude	
Operation	-300 to 12192 m
Storage	-300 to 12192 m
Transport	-300 to 12192 m
Mechanical characteristics	
Dimensions	
Width	9.5 mm
Height	69 mm
Depth	100 mm
Weight	78 g
Manufacturer information	
Manufacturer	Intel
Manufacturer's product ID	SSDSC2CW060A3

Table 85: 5MMSSD.0060-00 - Technical data

- 1) Yes, although applies only if all components installed within the complete system have this certification
- 2) IOPS: Random read and write input/output operations per second.

3.9.11.4 Temperature humidity diagram

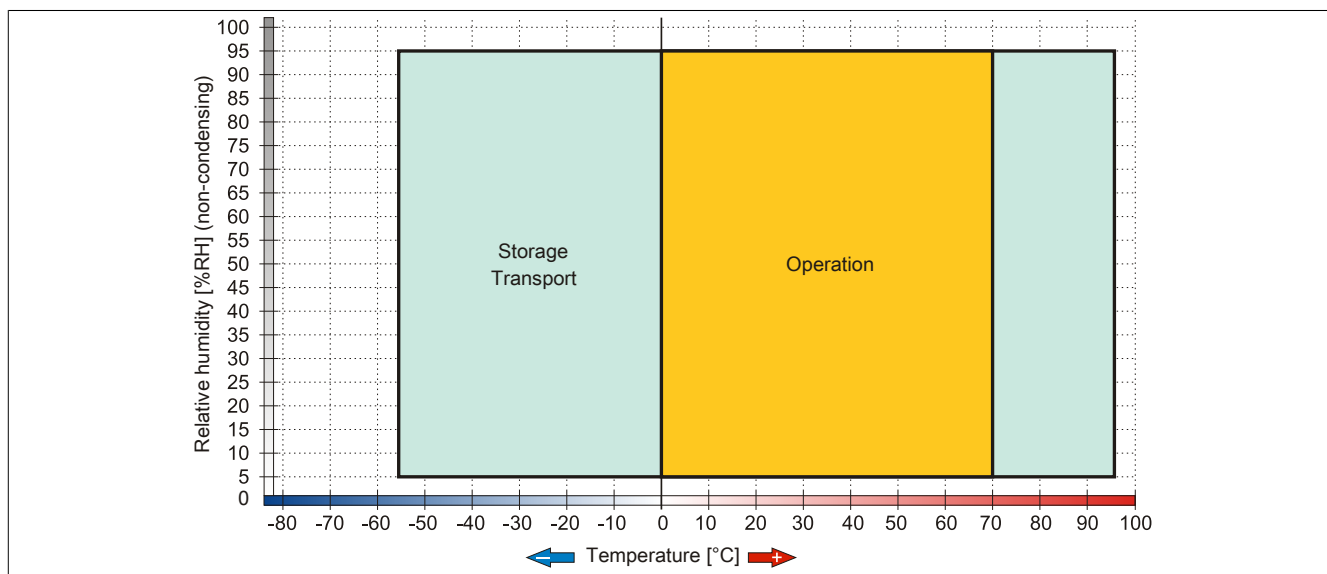

Figure 44: 5MMSSD.0060-00 - Temperature humidity diagram

3.9.12 5MMSSD.0060-01

3.9.12.1 General information

This 60 GB slide-in compact SSD (solid-state drive) is based on multi-level cell (MLC) technology and can be used as a replacement or accessory part.

- Replacement for 5AC801.SSDI-03 or 5AC901.CSSD-03 SSD drives
- Accessory for the APC510 (optional SSD for I/O board)

3.9.12.2 Order data

Model number	Short description	Figure
	Drives	
5MMSSD.0060-01	60 GB SSD MLC - Intel - SATA	

Table 86: 5MMSSD.0060-01 - Order data

3.9.12.3 Technical data

Caution!

A sudden power failure may result in data loss! In very rare cases, the mass storage device may also become damaged.

To prevent damage and loss of data, the use of a UPS is recommended.

Information:

The following characteristics, features and limit values only apply to this accessory and can deviate from those specified for the complete system. The data specifications for the complete system take precedence over those of individual components.

Product ID	5MMSSD.0060-01	
Revision	C0	D0
General information		
Certification		
CE		Yes
cULus		Yes
cULus HazLoc Class 1 Division 2		Yes ¹⁾
GOST-R		Yes
Solid-state drive		
Capacity	60 GB	
Data reliability	<1 unrecoverable error in 10 ¹⁵ bit read accesses	
MTBF	1,500,000 hours	
S.M.A.R.T. support	Yes	
Interface	SATA	
Maintenance	None	
Sequential read	Max. 510 MB/s	
Sequential write	Max. 430 MB/s	
IOPS ²⁾		
4k read		Max. 50,000 (random)
4k write		Max. 25,000 (random)
Endurance		
MLC flash	Yes	
Guaranteed data volume		
Guaranteed	35 TBW ³⁾	
Compatibility	SATA 3.0 compliant ACS-2 SSD Enhanced SMART ATA feature set Native Command Queuing (NCQ)	
Environmental conditions		
Temperature		
Operation	0 to 70°C	-30 to 85°C
Storage		-40 to 85°C
Transport		-40 to 85°C

Table 87: 5MMSSD.0060-01, 5MMSSD.0060-01 - Technical data

Product ID		5MMSSD.0060-01	
Relative humidity			
Operation	8 to 90%, non-condensing		5 to 90%, non-condensing
Storage	8 to 95%, non-condensing		5 to 95%, non-condensing
Transport	8 to 95%, non-condensing		5 to 95%, non-condensing
Vibration			
Operation		10 to 2000 Hz: 20 g	
Storage		10 to 2000 Hz: 20 g	
Transport		10 to 2000 Hz: 20 g	
Shock			
Operation		1500 g, 0.5 ms	
Storage		1500 g, 0.5 ms	
Transport		1500 g, 0.5 ms	
Altitude			
Operation		-300 to 12192 m	
Storage		-300 to 12192 m	
Transport		-300 to 12192 m	
Mechanical characteristics			
Dimensions			
Width	9.5 mm		7 mm
Height		69 mm	
Depth		100 mm	
Weight		78 g	
Manufacturer information			
Manufacturer		Toshiba	
Manufacturer's product ID	THNSNH060GBST		THNSNJ060WCST

Table 87: 5MMSSD.0060-01, 5MMSSD.0060-01 - Technical data

- 1) Yes, although applies only if all components installed within the complete system have this certification.
- 2) IOPS: Random read and write input/output operations per second.
- 3) TBW: Terabytes written.

3.9.12.4 Temperature/Humidity diagram

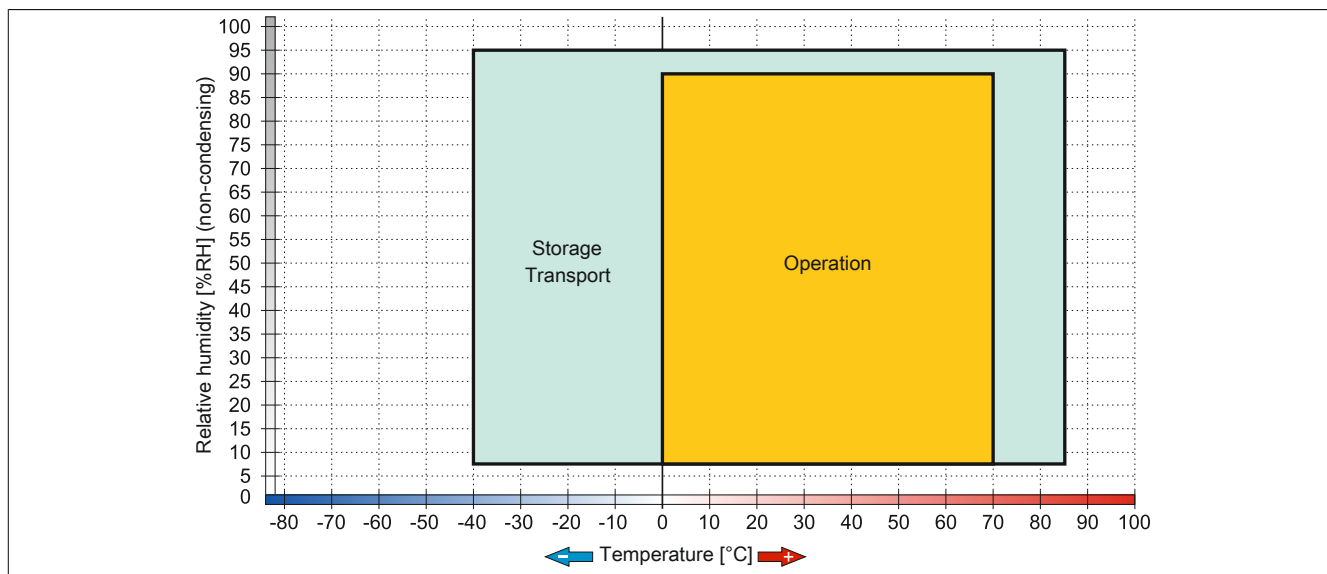

Figure 45: 5MMSSD.0060-01 ≤ Rev. C0 - Temperature/Humidity diagram

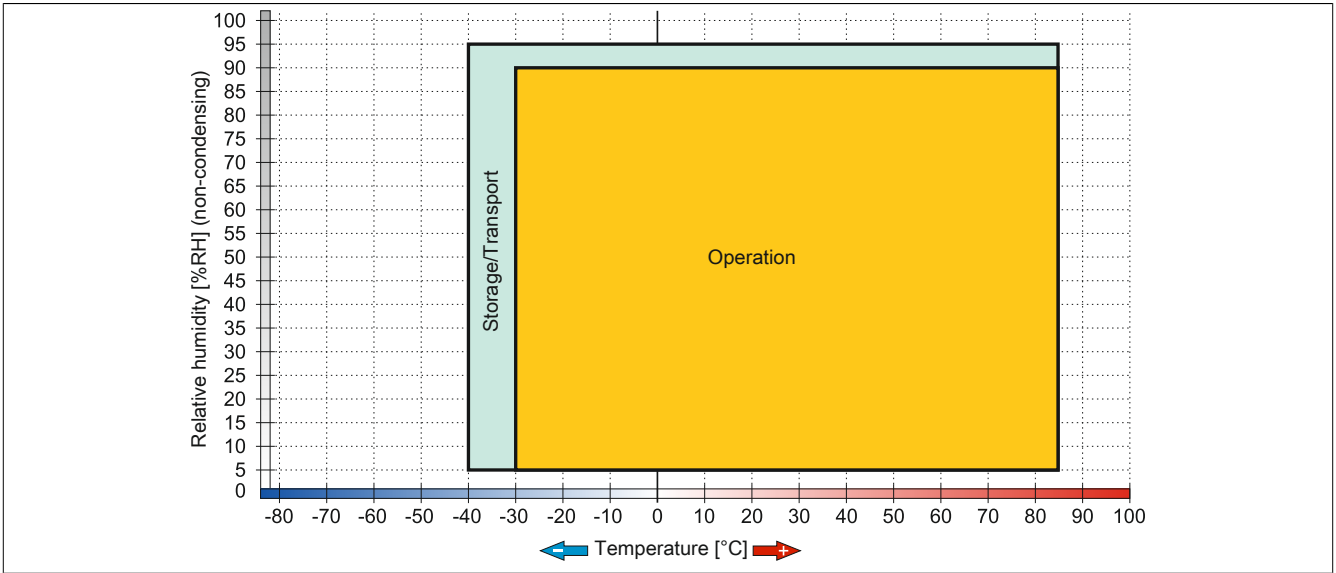

Figure 46: 5MMSSD.0060-01 ≥ Rev. D0 - Temperature/Humidity diagram

3.9.13 5MMSSD.0128-01

3.9.13.1 General information

This 128 GB slide-in compact SSD (solid-state drive) is based on multi-level cell (MLC) technology and can be used as a replacement or accessory part.

- Replacement for 5AC801.SSDI-04 or 5AC901.CSSD-04 SSD drives
- Accessory for the APC510 (optional SSD for I/O board)

3.9.13.2 Order data

Model number	Short description	Figure
	Drives	
5MMSSD.0128-01	128 GB SSD MLC - Toshiba - SATA	

Table 88: 5MMSSD.0128-01 - Order data

3.9.13.3 Technical data

Caution!

A sudden power failure may result in data loss! In very rare cases, the mass storage device may also become damaged.

To prevent damage and loss of data, the use of a UPS is recommended.

Information:

The following characteristics, features and limit values only apply to this accessory and can deviate from those specified for the complete system. The data specifications for the complete system take precedence over those of individual components.

Product ID	5MMSSD.0128-01	
Revision	C0	D0
General information		
Certification		
CE		Yes
cULus		Yes
cULus HazLoc Class 1 Division 2		Yes ¹⁾
GOST-R		Yes
Solid-state drive		
Capacity	128 GB	
Data reliability	<1 unrecoverable error in 10 ¹⁵ bit read accesses	
MTBF	1,500,000 hours	
S.M.A.R.T. support	Yes	
Interface	SATA	
Maintenance	None	
Sequential read	Max. 510 MB/s	
Sequential write	Max. 450 MB/s	
IOPS ²⁾		
4k read	Max. 85,000 (random)	
4k write	Max. 35,000 (random)	
Endurance		
MLC flash	Yes	
Guaranteed data volume		
Guaranteed	74 TBW ³⁾	
Compatibility	SATA 3.0 compliant ACS-2 SSD Enhanced SMART ATA feature set Native Command Queuing (NCQ)	

Table 89: 5MMSSD.0128-01, 5MMSSD.0128-01 - Technical data

Product ID	5MMSSD.0128-01		
Environmental conditions			
Temperature	0 to 70°C		-30 to 85°C
Operation			
Storage			-40 to 85°C
Transport			-40 to 85°C
Relative humidity			
Operation	8 to 90%, non-condensing		5 to 90%, non-condensing
Storage	8 to 95%, non-condensing		5 to 95%, non-condensing
Transport	8 to 95%, non-condensing		5 to 95%, non-condensing
Vibration			
Operation	10 to 2000 Hz: 20 g		
Storage	10 to 2000 Hz: 20 g		
Transport	10 to 2000 Hz: 20 g		
Shock			
Operation	1500 g, 0.5 ms		
Storage	1500 g, 0.5 ms		
Transport	1500 g, 0.5 ms		
Altitude			
Operation	-300 to 12192 m		
Storage	-300 to 12192 m		
Transport	-300 to 12192 m		
Mechanical characteristics			
Dimensions			
Width	9.5 mm		7 mm
Height			69 mm
Depth			100 mm
Weight	78 g		
Manufacturer information			
Manufacturer	Toshiba		
Manufacturer's product ID	THNSNH128GBST		THNSNJ128WCST

Table 89: 5MMSSD.0128-01, 5MMSSD.0128-01 - Technical data

- 1) Yes, although applies only if all components installed within the complete system have this certification.
- 2) IOPS: Random read and write input/output operations per second.
- 3) TBW: Terabytes written.

3.9.13.4 Temperature/Humidity diagram

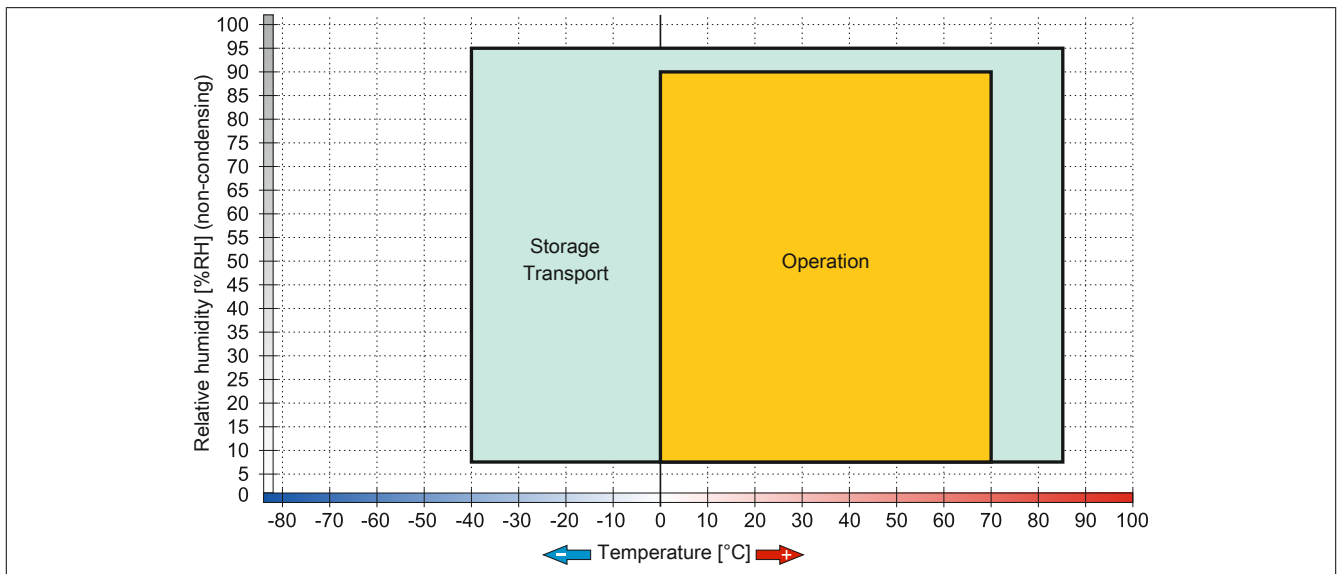

Figure 47: 5MMSSD.0128-01 ≤ Rev. C0 - Temperature/Humidity diagram

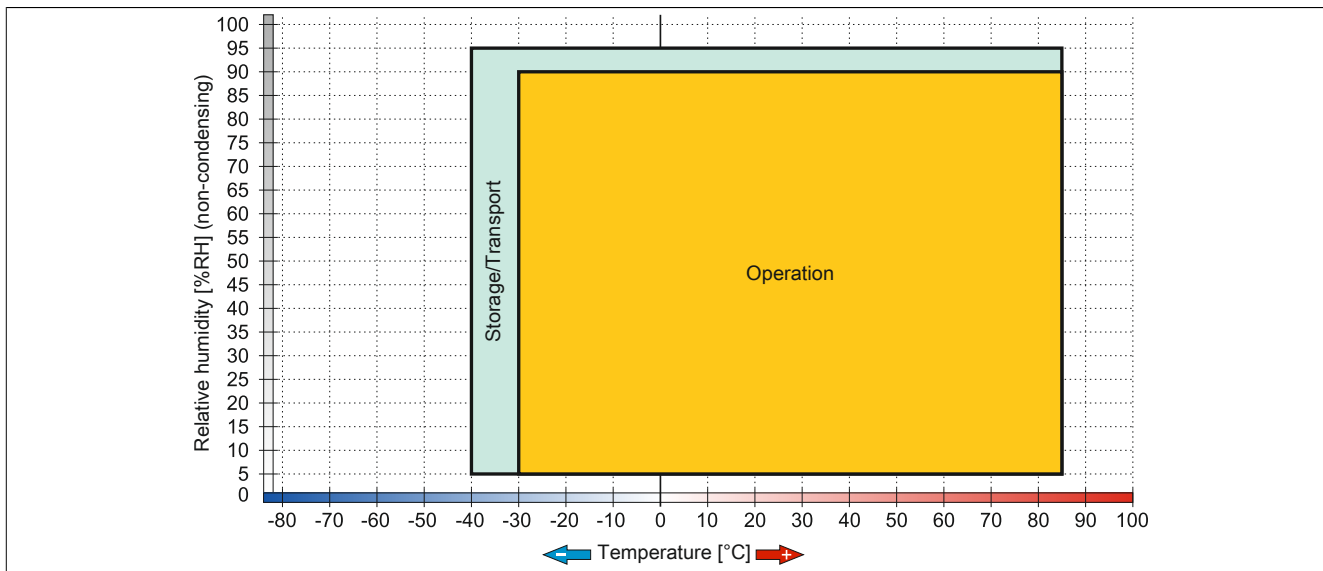

Figure 48: 5MMSSD.0128-01 ≥ Rev. D0 - Temperature/Humidity diagram

3.9.14 5MMSSD.0180-00

3.9.14.1 General information

This 180 GB slide-in compact SSD (solid-state drive) is based on multi-level cell (MLC) technology and can be used as a replacement or accessory part.

- Replacement for 5AC801.SSDI-02 or 5AC901.CSSD-02 SSD drives
- Accessory for the APC510 (optional SSD for I/O board)

3.9.14.2 Order data

Model number	Short description	Figure
	Drives	
5MMSSD.0180-00	180 GB SSD MLC - Intel - SATA	

Table 90: 5MMSSD.0180-00 - Order data

3.9.14.3 Technical data

Caution!

A sudden power failure may result in data loss! In very rare cases, the mass storage device may also become damaged.

To prevent damage and loss of data, the use of a UPS is recommended.

Information:

The following characteristics, features and limit values only apply to this accessory and can deviate from those specified for the complete system. The data specifications for the complete system take precedence over those of individual components.

Product ID	5MMSSD.0180-00
General information	
Certification	
CE	Yes
cULus	Yes
cULus HazLoc Class 1 Division 2	Yes ¹⁾
GOST-R	Yes
Solid-state drive	
Capacity	180 GB
Data reliability	<1 unrecoverable error in 10 ¹⁶ bit read accesses
MTBF	1,200,000 hours
S.M.A.R.T. support	Yes
Interface	SATA
Maintenance	None
Sequential read	Max. 550 MB/s with SATA 6 Gbit/s Max. 280 MB/s with SATA 3 Gbit/s
Sequential write	Max. 520 MB/s with SATA 6 Gbit/s Max. 260 MB/s with SATA 3 Gbit/s
IOPS ²⁾	
4k read	50,000
4k write	
Typical	60,000
Maximum	80,000
Endurance	
MLC flash	Yes
Compatibility	SATA 3.0 compliant ACS-2 SSD Enhanced SMART ATA feature set Native Command Queuing (NCQ)

Table 91: 5MMSSD.0180-00 - Technical data

Product ID	5MMSSD.0180-00
Environmental conditions	
Temperature	
Operation	0 to 70°C
Storage	-55 to 95°C
Transport	-55 to 95°C
Relative humidity	
Operation	5 to 95%, non-condensing
Storage	5 to 95%, non-condensing
Transport	5 to 95%, non-condensing
Vibration	
Operation	5 to 700 Hz: 2.17 g
Storage	5 to 800 Hz: 3.13 g
Transport	5 to 800 Hz: 3.13 g
Shock	
Operation	1500 g, 0.5 ms
Storage	1500 g, 0.5 ms
Transport	1500 g, 0.5 ms
Altitude	
Operation	-300 to 12192 m
Storage	-300 to 12192 m
Transport	-300 to 12192 m
Mechanical characteristics	
Dimensions	
Width	9.5 mm
Height	69 mm
Depth	100 mm
Weight	78 g
Manufacturer information	
Manufacturer	Intel
Manufacturer's product ID	SSDSC2CW180A3

Table 91: 5MMSSD.0180-00 - Technical data

- 1) Yes, although applies only if all components installed within the complete system have this certification
- 2) IOPS: Random read and write input/output operations per second.

3.9.14.4 Temperature humidity diagram

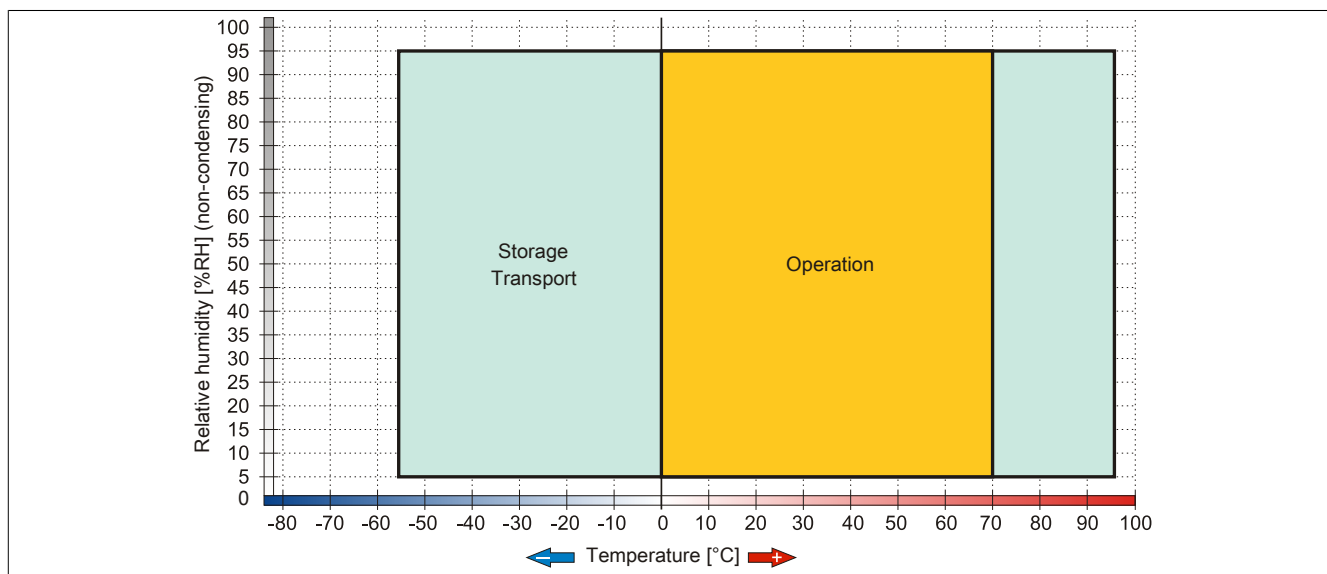

Figure 49: 5MMSSD.0180-00 - Temperature humidity diagram

3.9.15 5MMSSD.0256-00

3.9.15.1 General information

This 256 GB slide-in compact SSD (solid-state drive) is based on multi-level cell (MLC) technology and can be used as a replacement or accessory part.

- Replacement for 5AC801.SSDI-05 or 5AC901.CSSD-05 SSD drives
- Accessory for the APC510 (optional SSD for I/O board)

3.9.15.2 Order data

Model number	Short description	Figure
	Drives	
5MMSSD.0256-00	256 GB SSD MLC - Slide-in compact - Toshiba - SATA	

Table 92: 5MMSSD.0256-00 - Order data

3.9.15.3 Technical data

Caution!

A sudden power failure may result in data loss! In very rare cases, the mass storage device may also become damaged.

To prevent damage and loss of data, the use of a UPS is recommended.

Information:

The following characteristics, features and limit values only apply to this accessory and can deviate from those specified for the complete system. The data specifications for the complete system take precedence over those of individual components.

Product ID	5MMSSD.0256-00
General information	
Certification	
CE	Yes
cULus	Yes
cULus HazLoc Class 1 Division 2	Yes ¹⁾
Solid-state drive	
Capacity	256 GB
Data reliability	<1 unrecoverable error in 10 ¹⁵ bit read accesses
MTBF	1,500,000 hours
S.M.A.R.T. support	Yes
Interface	SATA
Maintenance	None
Sequential read	Max. 510 MB/s
Sequential write	Max. 460 MB/s
IOPS ²⁾	
4k read	Max. 90,000 (random)
4k write	Max. 35,000 (random)
Endurance	
MLC flash	Yes
Guaranteed data volume	
Guaranteed	148 TBW ³⁾
Compatibility	SATA 3.0 compliant ACS-2 SSD Enhanced SMART ATA feature set Native Command Queuing (NCQ)

Table 93: 5MMSSD.0256-00 - Technical data

Product ID	5MMSSD.0256-00
Environmental conditions	
Temperature	
Operation	-30 to 85°C
Storage	-40 to 85°C
Transport	-40 to 85°C
Relative humidity	
Operation	5 to 90%, non-condensing
Storage	5 to 95%, non-condensing
Transport	5 to 95%, non-condensing
Vibration	
Operation	10 to 2000 Hz: 20 g
Storage	10 to 2000 Hz: 20 g
Transport	10 to 2000 Hz: 20 g
Shock	
Operation	1500 g, 0.5 ms
Storage	1500 g, 0.5 ms
Transport	1500 g, 0.5 ms
Altitude	
Operation	-300 to 12192 m
Storage	-300 to 12192 m
Transport	-300 to 12192 m
Mechanical characteristics	
Dimensions	
Width	7 mm
Height	69 mm
Depth	100 mm
Weight	78 g
Manufacturer information	
Manufacturer	Toshiba
Manufacturer's product ID	THNSNJ256WCST

Table 93: 5MMSSD.0256-00 - Technical data

- 1) Yes, although applies only if all components installed within the complete system have this certification.
- 2) IOPS: Random read and write input/output operations per second.
- 3) TBW: Terabytes written.

3.9.15.4 Temperature/Humidity diagram

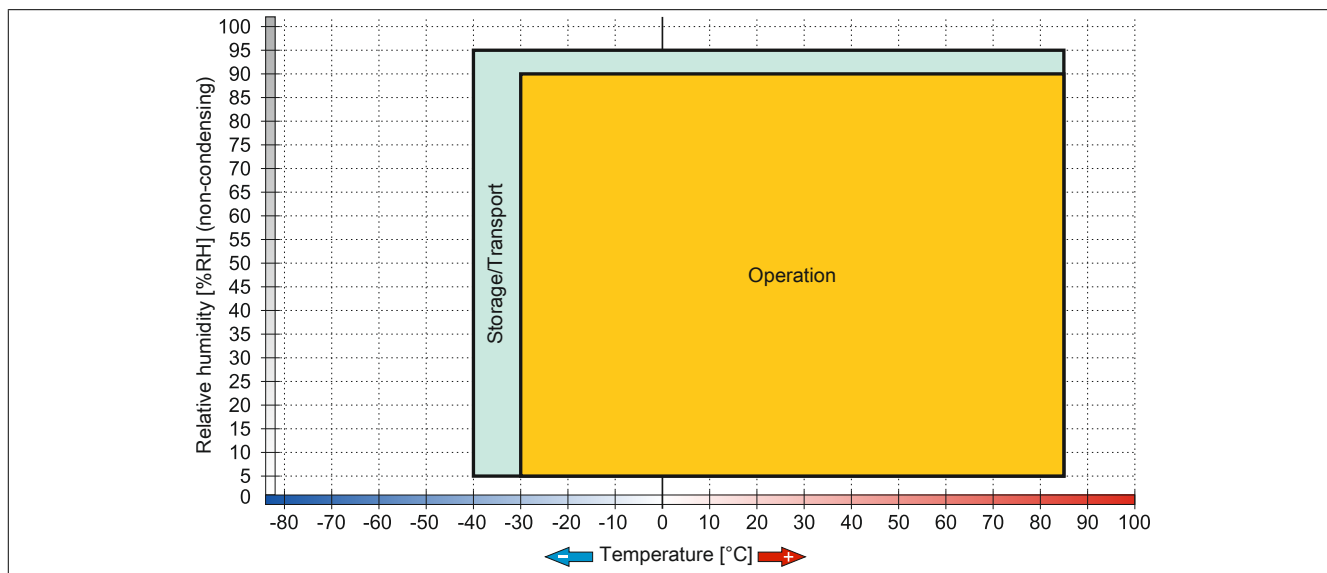

Figure 50: 5MMSSD.0256-00 - Temperature/Humidity diagram

3.9.16 5AC801.ADAS-00

3.9.16.1 General information

The hard disk adapter is a slide-in adapter that allows slide-in compact drives to be installed and operated on a B&R Industrial PC. This adapter can be used in APC810 and PPC800 system units with a slide-in drive slot.

When used in a PPC800

Information:

The expansion 5AC803.SX01-00 or 5AC803.SX02-00 is required in order to use slide-in drives.

3.9.16.2 Order data

Model number	Short description	Figure
	Drives	
5AC801.ADAS-00	SATA hard disk adapter for operating a slide-in compact hard disk in a slide-in slot	

Table 94: 5AC801.ADAS-00 - Order data

3.9.16.3 Technical data

Product ID	5AC801.ADAS-00
General information	
Certification	
CE	Yes
cULus	Yes
GOST-R	Yes
GL	Yes ¹⁾
Mechanical characteristics	
Dimensions	
Width	22 mm
Height	172.5 mm
Depth	150 mm
Weight	328 g

Table 95: 5AC801.ADAS-00 - Technical data

1) Yes, although applies only if all components installed within the complete system have this certification

3.9.17 5AC801.HDDS-00

3.9.17.1 General information

This 40 GB hard disk is specified for 24-hour operation, features an extended temperature range and can be used in APC810 and PPC800 system units with a slide-in drive slot.

Information:

A slide-in drive can be inserted or removed at any time.

When used in a PPC800

Information:

The expansion 5AC803.SX01-00 or 5AC803.SX02-00 is required in order to use slide-in drives.

When inserted in the slide-in slot, the slide-in drive is accessed internally via SATA and USB.

3.9.17.2 Order data

Model number	Short description	Figure
	Drives	
5AC801.HDDS-00	40 GB SATA slide-in hard disk; 24/7 operation with extended temperature range. Note: please see the manual for information about using this hard disk	

Table 96: 5AC801.HDDS-00 - Order data

3.9.17.3 Technical data

Information:

The following characteristics, features and limit values only apply to this individual component and can deviate from those specified for the complete system. For the complete system in which this individual component is used, refer to the data given specifically for that device.

Product ID	5AC801.HDDS-00
General information	
Certification	
CE	Yes
cULus	Yes
GOST-R	Yes
GL	Yes ¹⁾
Hard disk drive	
Capacity	40 GB
Number of heads	1
Number of sectors	78,140,160
Bytes per sector	512
Cache	8 MB
Speed	5400 rpm \pm 1%
Startup time	Typ. 3 s (from 0 rpm to read access)
MTBF	750,000 POH ²⁾
S.M.A.R.T. support	Yes
Interface	SATA
Access time	5.6 ms
Data transfer rate	
Internal	Max. 450 Mbit/s
To/From host	Max. 150 MB/s (Ultra DMA mode 5)

Table 97: 5AC801.HDDS-00 - Technical data

Product ID	5AC801.HDDS-00
Positioning time	
Minimum (track to track)	1 ms
Nominal (read only)	12.5 ms
Maximum (read only)	23 ms
Environmental conditions	
Temperature ³⁾	
Operation ⁴⁾	-30 to 85°C
24-hour operation ⁵⁾	-30 to 85°C
Storage	-40 to 95°C
Transport	-40 to 95°C
Relative humidity ⁶⁾	
Operation	5 to 90%, non-condensing
Storage	5 to 95%, non-condensing
Transport	5 to 95%, non-condensing
Vibration	
Operation	5 to 500 Hz: 2 g; no unrecoverable errors
Storage	5 to 500 Hz: 5 g; no unrecoverable errors
Transport	5 to 500 Hz: 5 g; no unrecoverable errors
Shock	
Operation	300 g and 2 ms duration; no unrecoverable errors 150 g and 11 ms duration; no unrecoverable errors
Storage	800 g and 2 ms duration; no unrecoverable errors
Transport	400 g and 0.5 ms duration; no unrecoverable errors 800 g and 2 ms duration; no unrecoverable errors 400 g and 0.5 ms duration; no unrecoverable errors
Altitude	
Operation	-300 to 5000 m
Storage	-300 to 12192 m
Mechanical characteristics	
Installation	Fixed ⁷⁾
Dimensions	
Width	22 mm
Height	172.5 mm
Depth	150 mm
Weight	387 g
Manufacturer information	
Manufacturer	Seagate
Manufacturer product ID	ST940817SM

Table 97: 5AC801.HDDS-00 - Technical data

- 1) Yes, although applies only if all components installed within the complete system have this certification
- 2) With 8760 POH (power-on hours) per year and 70°C surface temperature.
- 3) Temperature values at an elevation of 305 meters. The temperature specification must be reduced linearly by 1°C every 305 meters. The temperature increase and decrease can be a maximum of 20°C per hour.
- 4) Standard operation refers to 333 POH (power-on hours) per month.
- 5) 24-hour operation refers to 732 POH (power-on hours) per month.
- 6) Humidity gradient: Maximum 15% per hour.
- 7) Slide-in compact installation.

3.9.17.4 Temperature humidity diagram

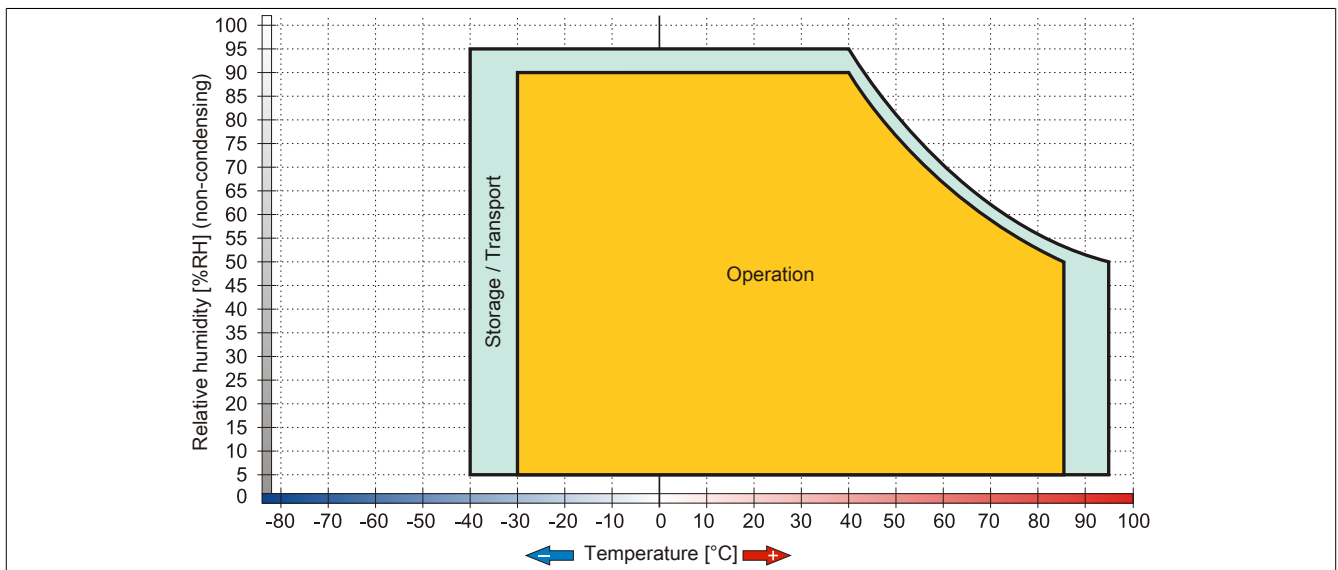

Figure 51: 5AC801.HDDS-00 - Temperature humidity diagram

3.9.18 5AC801.DVDS-00

3.9.18.1 General information

The DVD-ROM slide-in drive can be used in APC810 and PPC800 system units with a slide-in drive slot.

Information:

A slide-in drive can be inserted or removed at any time.

When used in a PPC800

Information:

The expansion 5AC803.SX01-00 or 5AC803.SX02-00 is required in order to use slide-in drives.

When inserted in the slide-in slot, the slide-in drive is accessed internally via SATA and USB.

3.9.18.2 Order data

Model number	Short description	Figure
	Drives	
5AC801.DVDS-00	DVD-ROM SATA slide-in drive	

Table 98: 5AC801.DVDS-00 - Order data

3.9.18.3 Technical data

Information:

The following characteristics, features and limit values only apply to this individual component and can deviate from those specified for the complete system. For the complete system in which this individual component is used, refer to the data given specifically for that device.

Product ID	5AC801.DVDS-00
General information	
Certification	
CE	Yes
cULus	Yes
GOST-R	Yes
GL	Yes ¹⁾
CD / DVD drive	
Data transfer rate	Max. 1.5 Gbit/s
Speed	Max. 5090 rpm \pm 1%
Noise level	Approx. 45 dBA in a distance of 50 cm (full read access)
Compatible formats	CD-DA, CD-ROM mode 1/mode 2 CD-ROM XA mode 2 (form 1, form 2) Photo CD (single/multi-session) Enhanced CD, CD text DVD-ROM, DVD-Video (dual layer), DVD-R (single/multi-border), DVD-R DL (single/multi-border), DVD-RW (single/multi-border), DVD+R (single/multi-session), DVD+R DL (single/multi-session), DVD+RW (single/multi-session), DVD-RAM (4.7 GB, 2.6 GB)
Laser class	Class 1 laser
Service life	60000 POH (power-on hours)
Interface	SATA
Startup time	
CD	Max. 19 seconds (from 0 rpm to read access)
DVD	Max. 19 seconds (from 0 rpm to read access)

Table 99: 5AC801.DVDS-00 - Technical data

Product ID	5AC801.DVDS-00
Access time CD DVD	Average of 130 ms Average of 140 ms
Readable media CD DVD	CD-ROM (12 cm, 8 cm), CD-A CD-R, CD-RW DVD-ROM, DVD-R, DVD-R DL, DVD-RW, DVD+R DVD+R DL, DVD+RW, DVD-RAM
Read speed CD DVD	24x 8x
Environmental conditions	
Temperature ²⁾ Operation Storage Transport	5 to 55°C ³⁾ -20 to 60°C -40 to 65°C
Relative humidity Operation Storage Transport	8 to 80%, non-condensing 5 to 95%, non-condensing 5 to 95%, non-condensing
Vibration Operation Storage Transport	5 to 500 Hz: 0.2 g 5 to 500 Hz: 2 g 5 to 500 Hz: 2 g
Shock Operation Storage Transport	5 g and 11 ms duration 60 g and 11 ms duration 200 g and 2 ms duration 60 g and 11 ms duration 200 g and 2 ms duration
Mechanical characteristics	
Dimensions Width Height Depth	22 mm 172.5 mm 150 mm
Weight	455 g

Table 99: 5AC801.DVDS-00 - Technical data

- 1) Yes, although applies only if all components installed within the complete system have this certification
- 2) Temperature data is for operation at 500 meters. The maximum ambient temperature is typically derated by 1°C per 1000 meters (starting at 500 meters above sea level).
- 3) Drive surface temperature.

3.9.18.4 Temperature humidity diagram

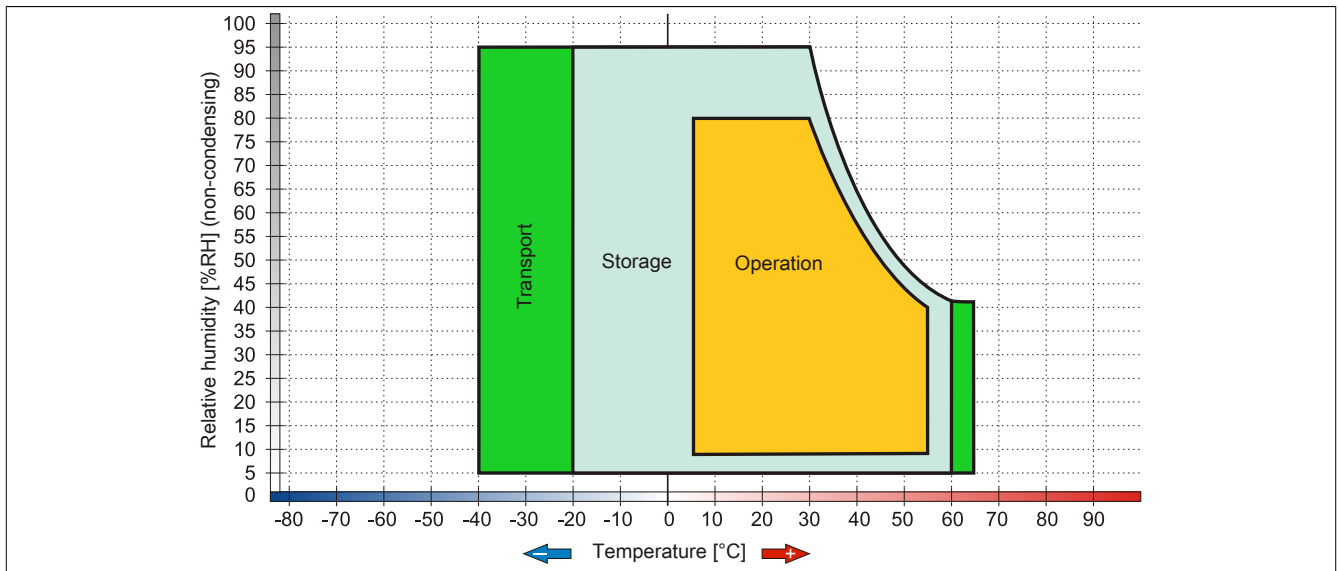

Figure 52: 5AC801.DVDS-00 - Temperature humidity diagram

3.9.18.5 Hot plugging

Hardware revision B0 of the 5AC801.DVDS-00 slide-in DVD-ROM does not offer SATA hot plugging functionality. Hot plugging is possible for other hardware revisions.

3.9.19 5AC801.DVRS-00

3.9.19.1 General information

The DVD-R/RW slide-in drive can be used in APC810 and PPC800 system units with a slide-in drive slot.

Information:

A slide-in drive can be inserted or removed at any time.

When used in a PPC800

Information:

The expansion 5AC803.SX01-00 or 5AC803.SX02-00 is required in order to use slide-in drives.

When inserted in the slide-in slot, the slide-in drive is accessed internally via SATA and USB.

3.9.19.2 Order data

Model number	Short description	Figure
	Drives	
5AC801.DVRS-00	DVD-R/RW DVD+R/RW SATA slide-in drive	
	Optional accessories	
	Other	
5SWUT1.0000-00	OEM Nero CD-RW Software, only available with a CD writer.	

Table 100: 5AC801.DVRS-00 - Order data

3.9.19.3 Technical data

Information:

The following characteristics, features and limit values only apply to this individual component and can deviate from those specified for the complete system. For the complete system in which this individual component is used, refer to the data given specifically for that device.

Product ID	5AC801.DVRS-00
General information	
Certification	
CE	Yes
cULus	Yes
GOST-R	Yes
GL	Yes ¹⁾
CD / DVD drive	
Data buffer capacity	2 MB
Data transfer rate	Max. 33.3 MB/s
Speed	Max. 5160 rpm ±1%
Noise level	Approx. 45 dBA in a distance of 50 cm (full read access)
Compatible formats	CD-DA, CD-ROM mode 1/mode 2 CD-ROM XA mode 2 (form 1, form 2) Photo CD (single-/multi-session), Enhanced CD, CD text DVD-ROM, DVD-R, DVD-R (dual layer), DVD-RW, DVD-Video DVD-RAM (4.7GB, 2.6GB) DVD+R, DVD+R (dual layer), DVD+RW
Laser class	Class 1 laser
Service life	60000 POH (power-on hours)
Interface	SATA
Startup time	
CD	Max. 14 seconds (from 0 rpm to read access)
DVD	Max. 15 seconds (from 0 rpm to read access)

Table 101: 5AC801.DVRS-00 - Technical data

Product ID	5AC801.DVRS-00
Access time CD DVD	On average 140 ms (24x) On average 150 ms (8x)
Readable media CD DVD	CD/CD-ROM (12 cm, 8 cm), CD-R, CD-RW DVD-ROM, DVD-R, DVD-R (dual layer), DVD-RW, DVD-RAM, DVD+R, DVD+R (dual layer), DVD+RW, DVD-RAM
Writable media CD DVD	CD-R, CD-RW DVD-R/RW, DVD-R (dual layer), DVD-RAM (4.7 GB), DVD+R/RW, DVD+R (dual layer)
Read speed CD DVD	24x 8x
Write speed CD-R CD-RW DVD+R DVD+R (dual layer) DVD+RW DVD-R DVD-R (dual layer) DVD-RAM ²⁾ DVD-RW	24x, 16x, 10x and 4x 24x, 16x, 10x and 4x 8x, 4x and 2.4x 6x, 4x and 2.4x 4x and 2x 8x, 4x and 2x 6x, 4x and 2x 5x, 3x and 2x 6x, 4x and 2x
Write methods CD DVD	Disk at once, session at once, packet write, track at once Disk at once, incremental, overwrite, sequential, multi-session
Environmental conditions	
Temperature ³⁾ Operation Storage Transport	5 to 55°C ⁴⁾ -20 to 60°C -40 to 65°C
Relative humidity Operation Storage Transport	8 to 80%, non-condensing 5 to 95%, non-condensing 5 to 95%, non-condensing
Vibration Operation Storage Transport	5 to 500 Hz: 0.2 g 5 to 500 Hz: 2 g 5 to 500 Hz: 2 g
Shock Operation Storage Transport	At max. 5 g and 11 ms duration At max. 60 g and 11 ms duration At max. 200 g and 2 ms duration At max. 60 g and 11 ms duration At max. 200 g and 2 ms duration
Mechanical characteristics	
Dimensions Width Height Depth	22 mm 172.5 mm 150 mm
Weight	400 g

Table 101: 5AC801.DVRS-00 - Technical data

- 1) Yes, although applies only if all components installed within the complete system have this certification
- 2) RAM drivers are not provided by the manufacturer. Support of RAM function by "Nero" burning software (model number 5SWUT1.0000-00) or other burning software packages or drivers from third-party providers.
- 3) Temperature specifications refer to operation at 500 meters. The maximum ambient temperature is typically derated by 1°C per 1000 meters (starting at 500 meters above sea level).
- 4) Drive surface temperature.

3.9.19.4 Temperature humidity diagram

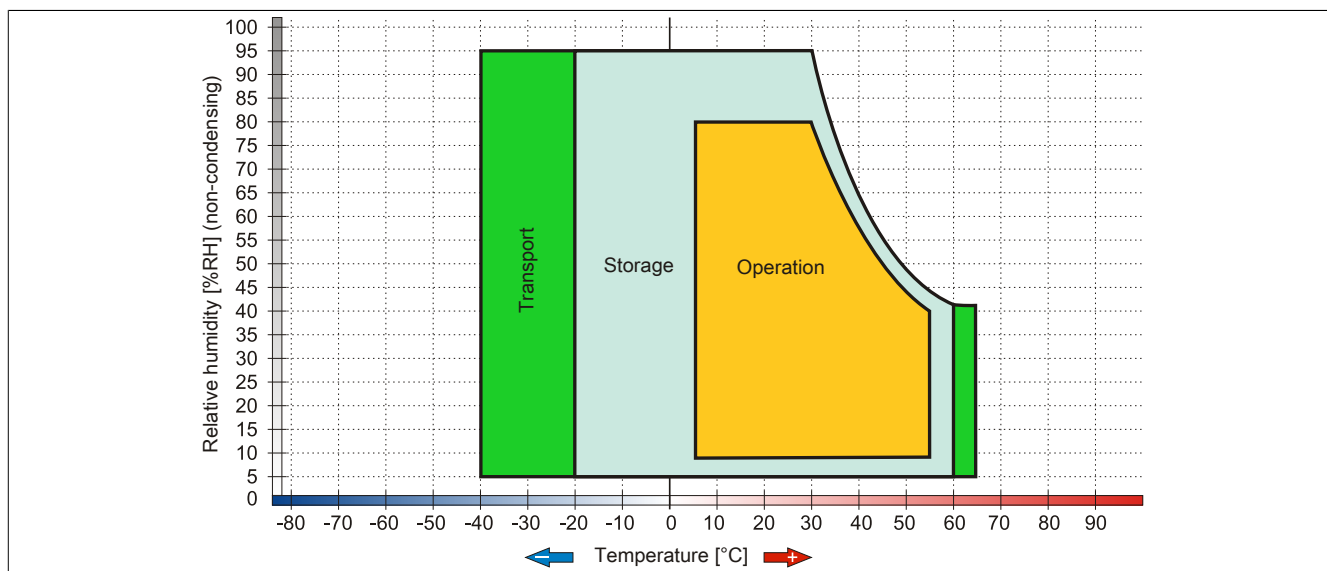

Figure 53: 5AC801.DVRS-00 - Temperature humidity diagram

3.9.20 5ACPCI.RAIC-03

3.9.20.1 General information

This SATA RAID controller supports RAID level 0 and 1 and can be inserted in a PCI slot. The hard disks being used are specified for 24-hour operation and also feature an extended temperature range.

- SATA RAID controller
- RAID level 0 (striped) and 1 (mirrored)
- 2 SATA hard disk drives (suitable for 24-hour operation)
- Only requires 1 PCI slot
- Transfer rates up to 150 MB/s

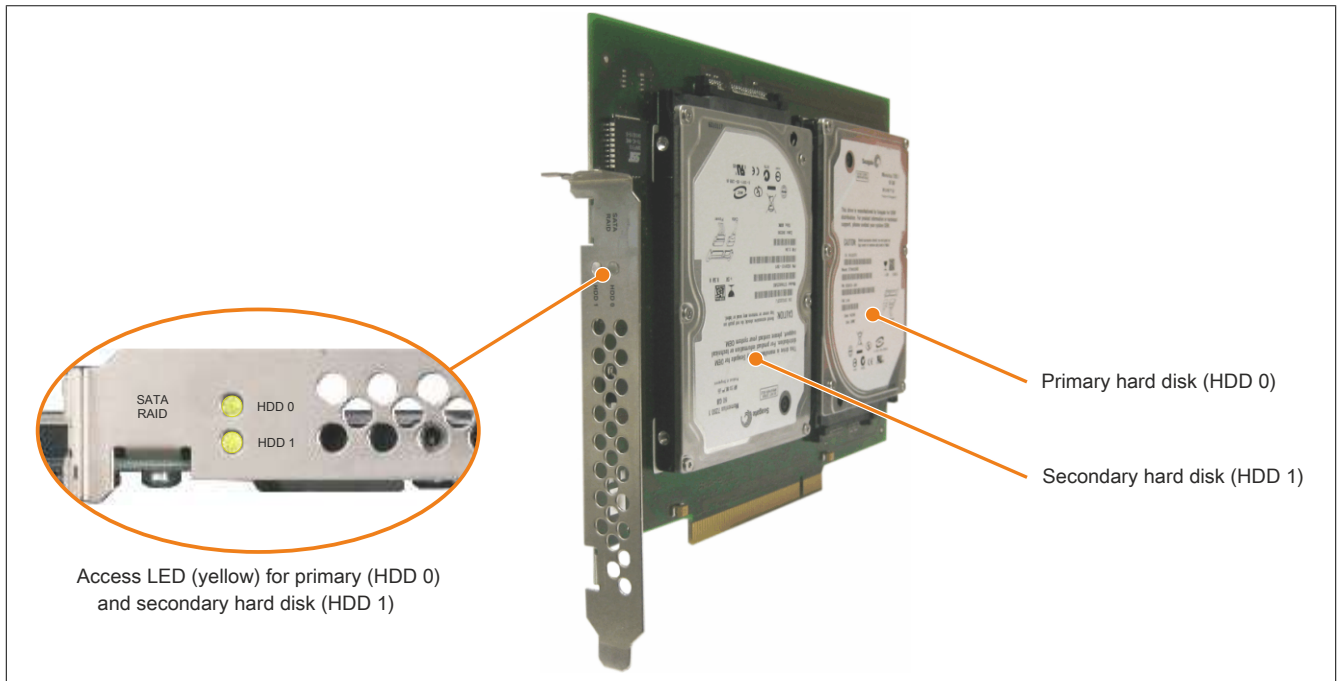

Figure 54: PCI SATA RAID controller

Information:

The PCI SATA RAID controller cannot be used in place of a universal power supply (UPS). If the operating system is not shut down properly, then this will be detected as an error state (with RAID 1 sets) at the next system startup and a complete rebuild is performed. If 160 GB of memory are used, this generally takes approximately 160 minutes (configurable) to complete.

3.9.20.2 Order data

Model number	Short description	Figure
	Drives	
5ACPCI.RAIC-03	PCI RAID system SATA 2x 160 GB; note: Please see the manual for information about using this hard disk.	
	Optional accessories	
	Drives	
5ACPCI.RAIC-04	160 GB SATA hard disk, replacement part for 5ACPCI.RAIC-03; note: Please see the manual for information about using this hard disk.	

Table 102: 5ACPCI.RAIC-03 - Order data

3.9.20.3 Technical data

Information:

The following characteristics, features and limit values only apply to this individual component and can deviate from those specified for the complete system. For the complete system in which this individual component is used, refer to the data given specifically for that device.

Product ID	5ACPCI.RAIC-03
General information	
Number of hard disks	2
Certification CE	Yes
Controller	
Type	Sil 3512 SATA link
Specification	Serial ATA 1.0
Data transfer rate	Max. 1.5 Gbit/s (150 MB/s)
RAID level	Supports RAID 0, 1
BIOS extension ROM requirements	Approx. 32 kB
Hard disk drive	
Capacity	160 GB
Number of heads	3
Number of sectors	312,581,808
Bytes per sector	512
Cache	8 MB
Speed	5400 rpm ±1%
Startup time	Typ. 4 s (from 0 rpm to read access)
Service life	5 years
S.M.A.R.T. support	Yes
Access time	5.56 ms
Supported transfer modes	SATA 1.0, PIO mode 0-4, multiword DMA mode 0-2, UDMA 0-5
Data transfer rate	
Internal	Max. 84.6 Mbit/s
To/From host	Max. 150 MB/s
Positioning time	
Minimum (track to track)	1.5 ms
Nominal (read only)	12 ms
Maximum (read only)	22 ms
Electrical characteristics	
Power consumption	0.3A at 3.3V (PCI bus) 1A at 5V (PCI bus)
Environmental conditions	
Temperature ¹⁾	
Operation ²⁾	-15 to 80°C
24-hour operation ³⁾	-15 to 80°C
Storage	-40 to 95°C
Transport	-40 to 95°C
Relative humidity	
Operation	8 to 90%, non-condensing ⁴⁾
Storage	5 to 95%, non-condensing ⁵⁾
Transport	5 to 95%, non-condensing ⁵⁾
Vibration ⁶⁾	
Operation (continuous)	5 to 500 Hz: max. 0.125 g; duration 1 octave per minute; no unrecoverable errors
Operation (occasional)	5 to 500 Hz: max. 0.25 g; duration 1 octave per minute; no unrecoverable errors
Storage	5 to 500 Hz: max. 5 g; duration 0.5 octaves per minute; no damage
Transport	5 to 500 Hz: max. 5 g; duration 0.5 octaves per minute; no damage
Shock	
Operation	Max. 125 g, 2 ms; no unrecoverable errors
Storage	Max. 400 g, 2 ms; no damage Max. 450 g, 1 ms; no damage Max. 200 g, 0.5 ms; no damage
Transport	Max. 400 g, 2 ms; no damage Max. 450 g, 1 ms; no damage Max. 200 g, 0.5 ms; no damage
Altitude	
Operation	-300 to 3048 m
Storage	-300 to 12192 m
Mechanical characteristics	
Installation ⁷⁾	Fixed
Dimensions	
Width	70 mm
Length	100 mm
Height	9.5 mm

Table 103: 5ACPCI.RAIC-03 - Technical data

Product ID	5ACPCI.RAIC-03
Weight	350 g
Manufacturer information	
Manufacturer	Fujitsu
Manufacturer's product ID	M120-ESW MHY2160BH-ESW

Table 103: 5ACPCI.RAIC-03 - Technical data

- 1) Temperature values at an elevation of 305 meters. The temperature specification must be reduced linearly by 1°C every 305 meters. The temperature increase and decrease can be a maximum of 3°C per minute.
- 2) Standard operation refers to 333 POH (power-on hours) per month.
- 3) 24-hour operation refers to 732 POH (power-on hours) per month.
- 4) Maximum humidity at 29°C.
- 5) Maximum humidity at 40°C.
- 6) Operation in areas prone to vibration and shock can affect performance negatively (reduction of transfer rate).
- 7) Installed in PCI slot.

3.9.20.4 Temperature humidity diagram

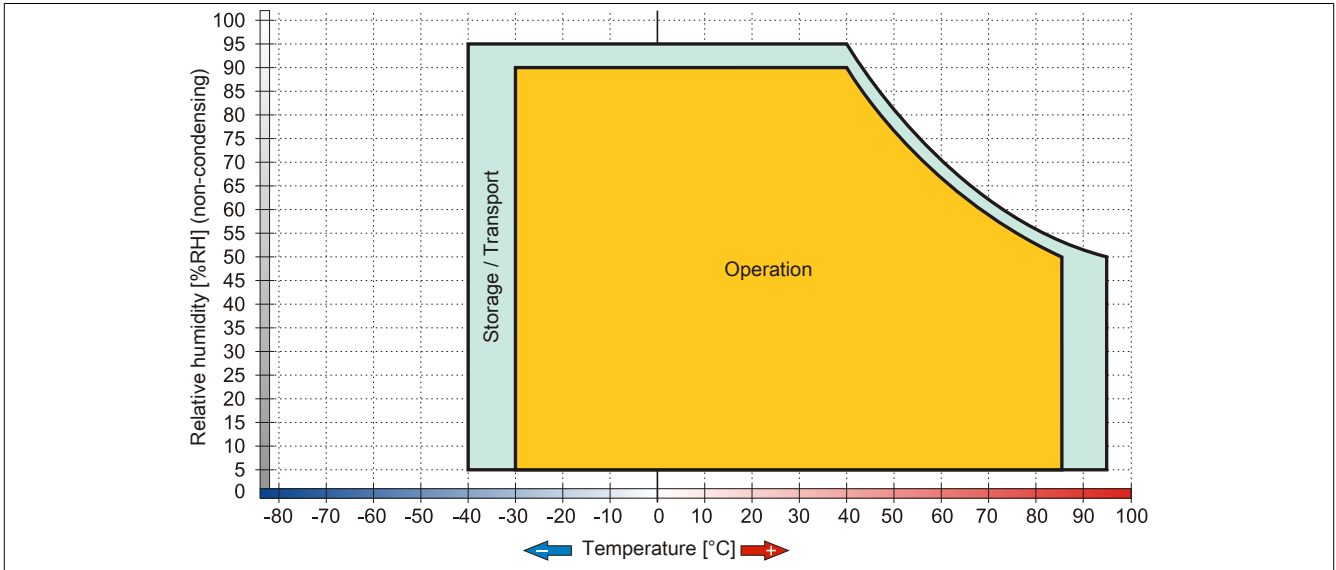

Figure 55: 5ACPCI.RAIC-03 - Temperature humidity diagram

3.9.20.5 Driver support

Special drivers are necessary for operating the PCI SATA RAID controller. Drivers for supported and approved operating systems are available in the Downloads section of the B&R website (www.br-automation.com).

.NET-based SATA Raid™ serial ATA RAID management software can also be found on the B&R website.

Information:

Required drivers can only be downloaded from the B&R website, not from manufacturer websites.

3.9.20.6 Configuration

For information about configuring a SATA RAID set, see 3 "Installation", section 8 "Configuring a SATA RAID set" on page 176.

3.9.20.7 Replacing a HDD

A hard drive can be easily replaced in the event of an error when using the RAID1 (mirroring) configuration without having to reinstall the system. The 160 GB 5ACPCI.RAIC-04 SATA HDD is available as a replacement hard disk.

For instructions on replacing the drive, see 7 "Maintenance and service", section 14 "Replacing a PCI SATA RAID hard disk in a RAID 1 set" on page 360.

3.9.21 5ACPCI.RAIC-04

3.9.21.1 General information

This hard disk can be used as a replacement for a HDD used with the 5ACPCI.RAIC-03 PCI SATA RAID controller.

3.9.21.2 Order data

Model number	Short description	Figure
	Drives	
5ACPCI.RAIC-04	160 GB SATA hard disk, replacement part for 5ACPCI.RAIC-03; note: Please see the manual for information about using this hard disk.	

Table 104: 5ACPCI.RAIC-04 - Order data

3.9.21.3 Technical data

Information:

The following characteristics, features and limit values only apply to this individual component and can deviate from those specified for the complete system. For the complete system in which this individual component is used, refer to the data given specifically for that device.

Product ID	5ACPCI.RAIC-04
General information	
Certification CE	Yes
Hard disk drive	
Capacity	160 GB
Number of heads	3
Number of sectors	312,581,808
Bytes per sector	512
Cache	8 MB
Speed	5400 rpm \pm 1%
Startup time	Typ. 4 s (from 0 rpm to read access)
Service life	5 years
S.M.A.R.T. support	Yes
Access time	5.56 ms
Supported transfer modes	SATA 1.0, PIO mode 0-4, multiword DMA mode 0-2, UDMA 0-5
Data transfer rate	
Internal	Max. 84.6 Mbit/s
To/From host	Max. 150 MB/s
Positioning time	
Minimum (track to track)	1.5 ms
Nominal (read only)	12 ms
Maximum (read only)	22 ms
Electrical characteristics	
Power consumption	0.3A at 3.3V (PCI bus) 1A at 5V (PCI bus)
Environmental conditions	
Temperature ¹⁾	
Operation ²⁾	-15 to 80°C
24-hour operation ³⁾	-15 to 80°C
Storage	-40 to 95°C
Transport	-40 to 95°C
Relative humidity	
Operation	8 to 90%, non-condensing ⁴⁾
Storage	5 to 95%, non-condensing ⁵⁾
Transport	5 to 95%, non-condensing ⁵⁾
Vibration ⁶⁾	
Operation (continuous)	5 to 500 Hz: max. 0.125 g; duration 1 octave per minute; no unrecoverable errors
Operation (occasional)	5 to 500 Hz: max. 0.25 g; duration 1 octave per minute; no unrecoverable errors
Storage	5 to 500 Hz: max. 5 g; duration 0.5 octaves per minute; no damage
Transport	5 to 500 Hz: max. 5 g; duration 0.5 octaves per minute; no damage

Table 105: 5ACPCI.RAIC-04 - Technical data

Product ID	5ACPCI.RAIC-04
Shock	
Operation	Max. 125 g, 2 ms; no unrecoverable errors
Storage	Max. 400 g, 2 ms; no damage Max. 450 g, 1 ms; no damage
Transport	Max. 200 g, 0.5 ms; no damage Max. 400 g, 2 ms; no damage Max. 450 g, 1 ms; no damage Max. 200 g, 0.5 ms; no damage
Altitude	
Operation	-300 to 3048 m
Storage	-300 to 12192 m
Mechanical characteristics	
Dimensions	
Width	70 mm
Length	100 mm
Height	9.5 mm
Weight	350 g
Manufacturer information	
Manufacturer	Fujitsu
Manufacturer product ID	M120-ESW MHY2160BH-ESW

Table 105: 5ACPCI.RAIC-04 - Technical data

- 1) Temperature values at an elevation of 305 meters. The temperature specification must be reduced linearly by 1°C every 305 meters. The temperature increase and decrease can be a maximum of 3°C per minute.
- 2) Standard operation refers to 333 POH (power-on hours) per month.
- 3) 24-hour operation refers to 732 POH (power-on hours) per month.
- 4) Maximum humidity at 29°C.
- 5) Maximum humidity at 40°C.
- 6) Operation in areas prone to vibration and shock can affect performance negatively (reduction of transfer rate).

3.9.21.4 Temperature humidity diagram

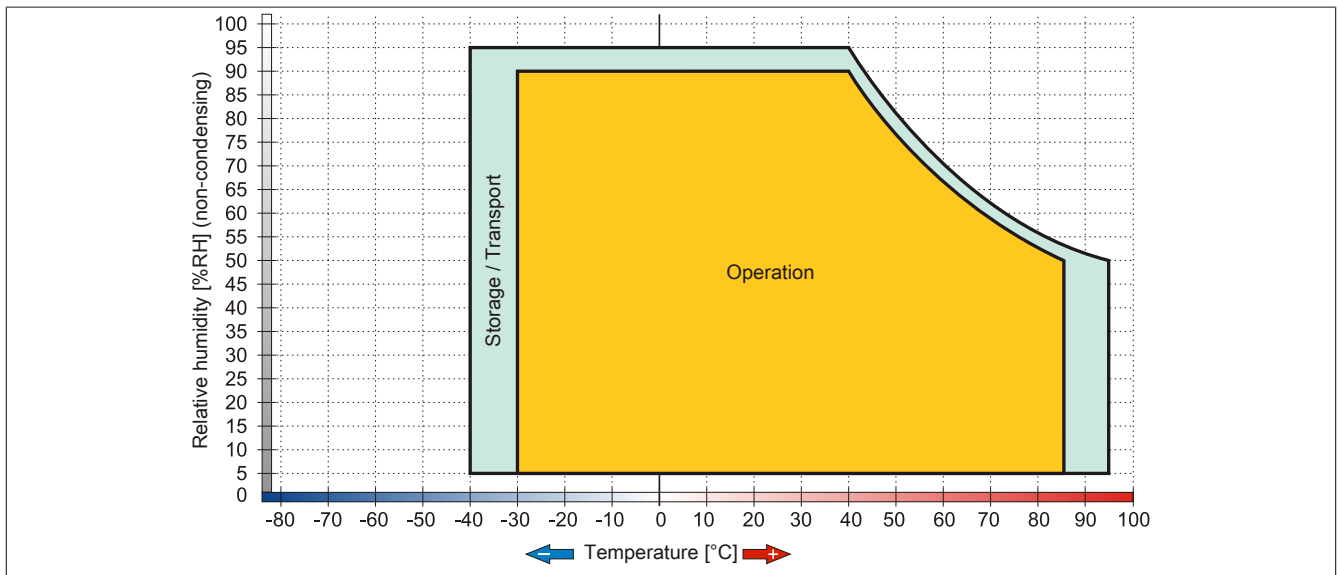

Figure 56: 5ACPCI.RAIC-04 - Temperature humidity diagram

3.9.22 5ACPCI.RAIC-05

3.9.22.1 General information

This SATA RAID controller supports RAID level 0 and 1 and can be inserted in a PCI slot. The 250 GB hard disks that are used are specified for 24-hour operation (24x7).

- SATA RAID controller
- RAID level 0 (striped) and 1 (mirrored)
- 2 SATA hard disk drives (suitable for 24-hour operation)
- Only requires 1 PCI slot
- Transfer rates up to 150 MB/s

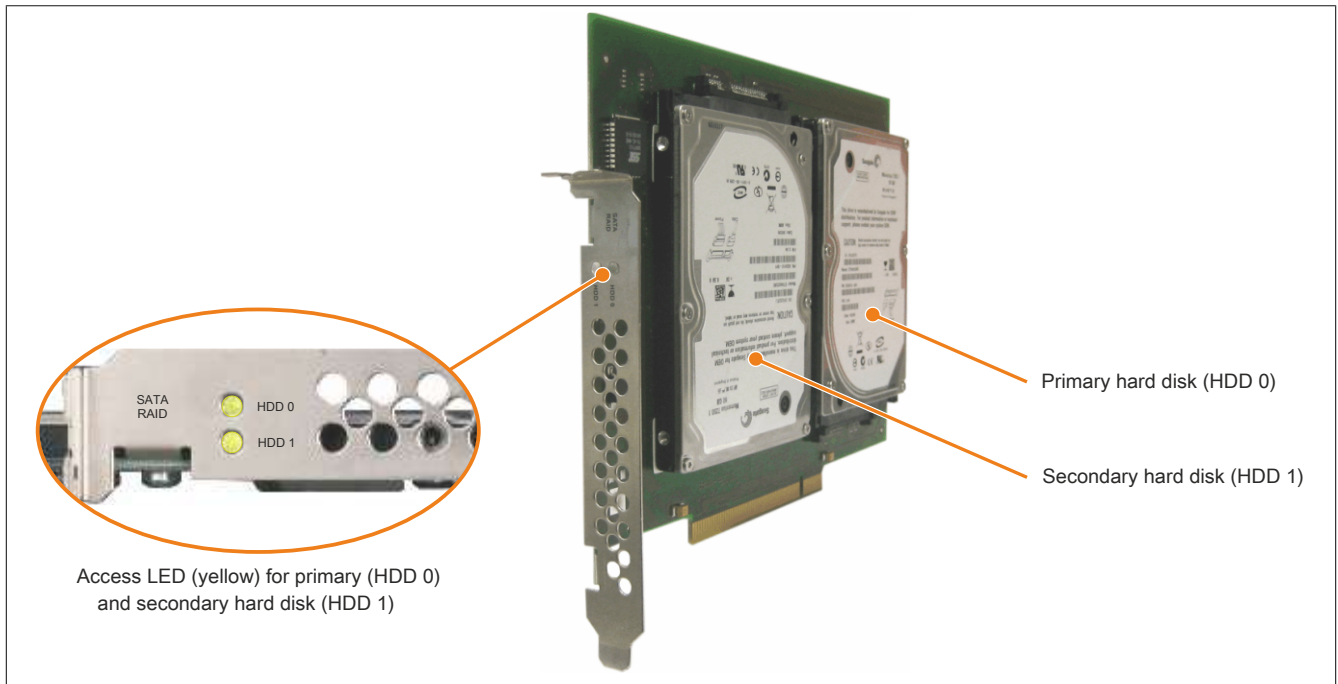

Figure 57: PCI SATA RAID controller

Information:

The PCI SATA RAID controller cannot be used in place of a universal power supply (UPS). If the operating system is not shut down properly, then this will be detected as an error state (with RAID 1 sets) at the next system startup and a complete rebuild is performed. If 250 GB of memory are used, this generally takes approximately 250 minutes (configurable) to complete.

3.9.22.2 Order data

Model number	Short description	Figure
	Drives	
5ACPCI.RAIC-05	PCI RAID system SATA 2x 250 GB; Note: please see the manual for information about using this hard disk	
	Optional accessories	
	Drives	
5MMHDD.0250-00	250 GB SATA hard disk; replacement for 5AC801.HDDI-03 and 5ACPCI.RAIC-05; note: please see the manual for information about using this hard disk	

Table 106: 5ACPCI.RAIC-05 - Order data

3.9.22.3 Technical data

Product ID	5ACPCI.RAIC-05
General information	
Number of hard disks	2
Certification	
CE	Yes
cULus	Yes
cULus HazLoc Class 1 Division 2	Yes ¹⁾
GOST-R	Yes
Controller	
Type	Sil 3512 SATA link
Specification	Serial ATA 1.0
Data transfer rate	Max. 1.5 Gbit/s (150 MB/s)
RAID level	Supports RAID 0, 1
BIOS extension ROM requirements	Approx. 32 kB
Hard disk drive	
Capacity	250 GB
Number of heads	1
Number of sectors	488,397,168
Bytes per sector	512
Cache	8 MB
Speed	5400 rpm ±0.2%
Startup time	Typ. 3.6 s (from 0 rpm to read access)
S.M.A.R.T. support	Yes
Access time	5.56 ms
Supported transfer modes	SATA 1.0, Serial ATA Revision 2.6 PIO mode 0-4, multiword DMA mode 0-2, UDMA mode 0-6
Data transfer rate	
Internal	Max. 1175 Mbit/s
To/From host	Max. 150 MB/s
Positioning time	
Minimum (track to track)	1 ms
Nominal (read only)	14 ms
Maximum (read only)	30 ms
Electrical characteristics	
Power consumption	0.3A at 3.3V (PCI bus) 1A at 5V (PCI bus)
Environmental conditions	
Temperature ²⁾	
Operation ³⁾	0 to 60°C
24-hour operation ⁴⁾	0 to 60°C
Storage	-40 to 70°C
Transport	-40 to 70°C
Relative humidity ⁵⁾	
Operation	5 to 95%, non-condensing
Storage	5 to 95%, non-condensing
Transport	5 to 95%, non-condensing
Vibration ⁶⁾	
Operation (continuous)	5 to 500 Hz: max. 0.125 g; duration 1 octave per minute; no unrecoverable errors
Operation (occasional)	5 to 500 Hz: max. 0.25 g; duration 1 octave per minute; no unrecoverable errors
Storage	5 to 500 Hz: 5 g; duration 0.5 octaves per minute; no damage
Transport	5 to 500 Hz: 5 g; duration 0.5 octaves per minute; no damage
Shock ⁶⁾	
Operation	Max. 125 g, 2 ms; no unrecoverable errors
Storage	Max. 400 g, 2 ms; no damage Max. 500 g, 1 ms; no damage Max. 300 g, 0.5 ms; no damage
Transport	Max. 400 g, 2 ms; no damage Max. 500 g, 1 ms; no damage Max. 300 g, 0.5 ms; no damage
Altitude	
Operation	- 300 to 3048 m
Storage	- 300 to 12192 m
Mechanical characteristics	
Installation	Fixed ⁷⁾
Weight	350 g
Manufacturer information	
Manufacturer	Seagate
Manufacturer's product ID	ST9250315AS

Table 107: 5ACPCI.RAIC-05 - Technical data

- 1) Yes, although applies only if all components installed within the complete system have this certification
- 2) Temperature values at an elevation of 305 meters. The temperature specification must be reduced linearly by 1°C every 305 meters. The temperature increase and decrease can be a maximum of 20°C per hour.
- 3) Standard operation refers to 333 POH (power-on hours) per month.
- 4) 24-hour operation refers to 732 POH (power-on hours) per month.

- 5) Humidity gradient: Maximum 30% per hour.
- 6) Operation in areas prone to vibration and shock can affect performance negatively (reduction of transfer rate).
- 7) Installed in PCI slot.

3.9.22.4 Temperature humidity diagram

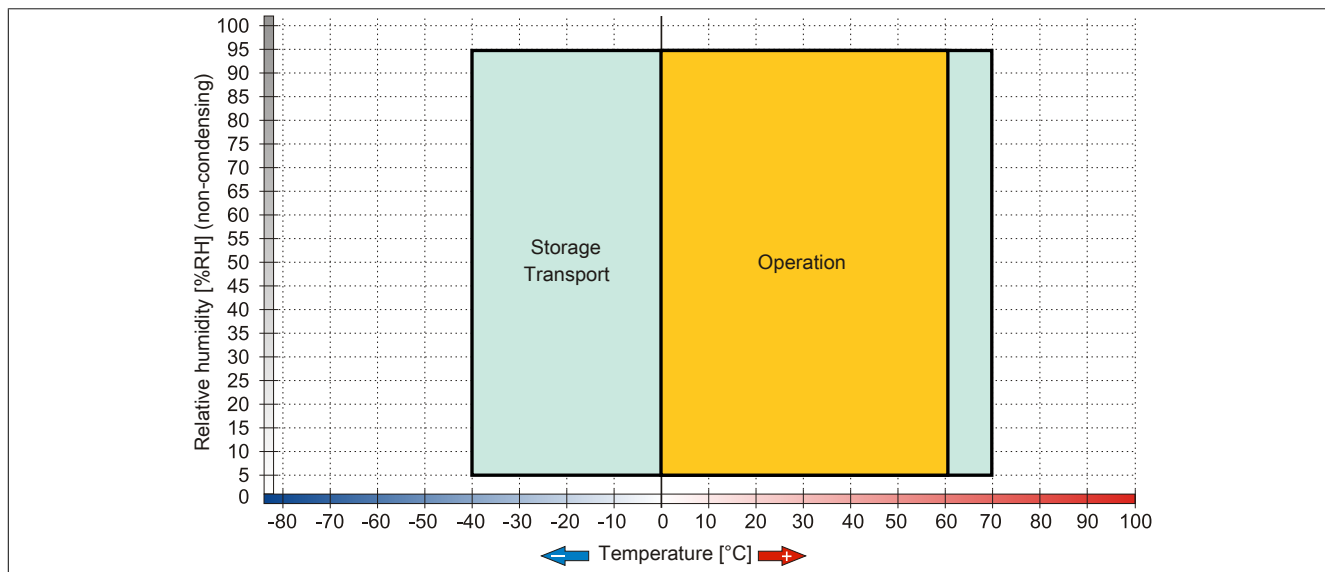

Figure 58: 5ACPCI.RAIC-05 - Temperature humidity diagram

3.9.22.5 Driver support

Special drivers are necessary for operating the PCI SATA RAID controller. Drivers for supported and approved operating systems are available in the Downloads section of the B&R website (www.br-automation.com).

.NET-based SATA Raid™ serial ATA RAID management software can also be found on the B&R website.

Information:

Required drivers can only be downloaded from the B&R website, not from manufacturer websites.

3.9.22.6 Configuration

For information about configuring a SATA RAID set, see 3 "Installation", section 8 "Configuring a SATA RAID set" on page 176.

3.9.22.7 Replacing a HDD

A hard drive can be easily replaced in the event of an error when using the RAID1 (mirroring) configuration without having to reinstall the system. The 250 GB 5MMHDD.0250-00 SATA HDD is available as a replacement hard disk.

For information about performing a replacement, see "Replacing a PCI SATA RAID hard disk in a RAID 1 set" on page 360.

3.9.23 5ACPCI.RAIC-06

3.9.23.1 General information

This SATA RAID controller supports RAID level 0 and 1 and can be inserted in a PCI slot. The 500 GB hard disks that are used are specified for 24-hour operation (24x7).

- SATA RAID controller
- RAID level 0 (striped) and 1 (mirrored)
- 2x 500 GB SATA hard disks (suitable for 24-hour operation)
- Only requires 1 PCI slot
- Transfer rates up to 150 MB/s

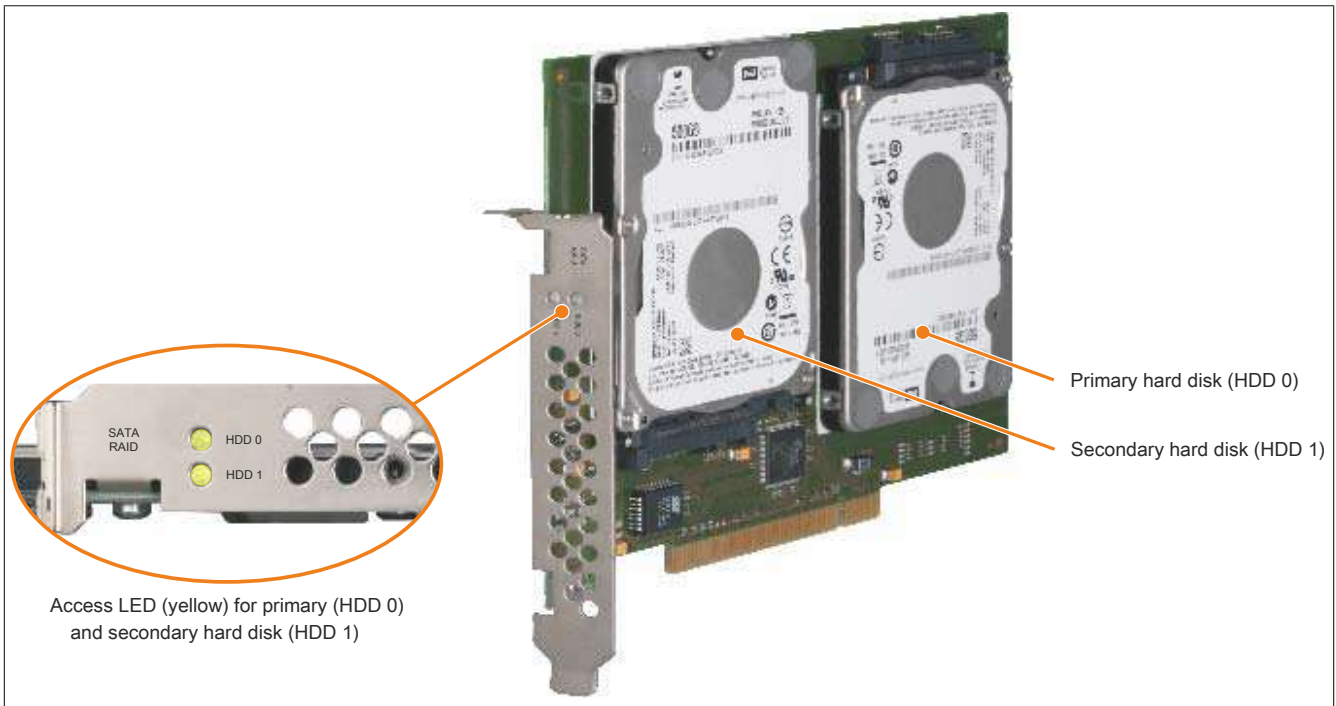

Figure 59: PCI SATA RAID controller

Information:

The PCI SATA RAID controller cannot be used in place of a universal power supply (UPS). If the operating system is not shut down properly, then this will be detected as an error state (with RAID 1 sets) at the next system startup and a complete rebuild is performed. If 500 GB of memory are used, this generally takes approximately 500 minutes (configurable) to complete.

3.9.23.2 Order data

Model number	Short description	Figure
	Drives	
5ACPCI.RAIC-06	PCI RAID System 2x 500 GB - SATA	
	Optional accessories	
	Drives	
5MMHDD.0500-00	500 GB hard disk - SATA	

Table 108: 5ACPCI.RAIC-06 - Order data

3.9.23.3 Technical data

Information:

The following characteristics, features and limit values only apply to this accessory and can deviate from those specified for the complete system. The data specifications for the complete system take precedence over those of individual components.

Product ID	5ACPCI.RAIC-06
General information	
Capacity	2x 500 GB
Number of hard disks	2
Certification	
CE	Yes
cULus	Yes
cULus HazLoc Class 1 Division 2	Yes ¹⁾
GOST-R	Yes
Controller	
Type	SII 3512 SATA link
Specification	Serial ATA 1.0
Data transfer rate	Max. 1.5 Gbit/s (150 MB/s)
RAID level	Supports RAID 0, 1
BIOS extension ROM requirements	Approx. 32 kB
Hard disk drive ²⁾	
Capacity	500 GB
Number of heads	2
Number of sectors	976,773,168
Bytes per sector	512 (logical) / 4096 (physical)
Cache	16 MB
Speed	5400 rpm ±0.2%
Startup time	Typ. 3.5 s (from 0 rpm to read access)
Service life	5 years
MTBF	1,000,000 POH ³⁾
S.M.A.R.T. support	Yes
Interface	SATA
Access time	5.5 ms
Supported transfer modes	SATA II
Data transfer rate	
Internal	Max. 147 MB/s
To/From host	Max. 150 MB/s (SATA I), max. 300 MB/s (SATA II)
Positioning time	
Nominal (read only)	11 ms
Maximum (read only)	21 ms
Environmental conditions	
Temperature ⁴⁾	
Operation ⁵⁾	0 to 60°C
24-hour operation ⁶⁾	0 to 60°C
Storage	-40 to 70°C
Transport	-40 to 70°C
Relative humidity ⁷⁾	
Operation	5 to 95%, non-condensing
Storage	5 to 95%, non-condensing
Transport	5 to 95%, non-condensing
Vibration ⁸⁾	
Operation (continuous)	5 to 500 Hz: 0.125 g; no unrecoverable errors
Operation (occasional)	5 to 500 Hz: 0.25 g; no unrecoverable errors
Storage	10 to 500 Hz: 5 g; no unrecoverable errors
Transport	10 to 500 Hz: 5 g; no unrecoverable errors
Shock	
Operation	200 g and 2 ms duration; no unrecoverable errors
Storage	1000 g and 2 ms duration; no unrecoverable errors
Transport	1000 g and 2 ms duration; no unrecoverable errors
Altitude	
Operation	-305 to 3048 m
Storage	-305 to 12192 m
Mechanical characteristics	
Installation	Fixed ⁹⁾

Table 109: 5ACPCI.RAIC-06 - Technical data

Product ID	5ACPCI.RAIC-06
Weight	350 g
Manufacturer information	
Manufacturer	Western Digital
Manufacturer's product ID	WD5000LUCT

Table 109: 5ACPCI.RAIC-06 - Technical data

- 1) Yes, although applies only if all components installed within the complete system have this certification
- 2) Technical data for a hard disk.
- 3) With 8760 POH (power-on hours) per year and 25°C surface temperature.
- 4) Temperature values at an elevation of 305 meters. The temperature specification must be reduced linearly by 1°C every 305 meters. The temperature increase and decrease can be a maximum of 20°C per hour.
- 5) Standard operation refers to 333 POH (power-on hours) per month.
- 6) 24-hour operation refers to 732 POH (power-on hours) per month.
- 7) Humidity gradient: Maximum 20% per hour.
- 8) Operation in areas prone to vibration and shock can affect performance negatively (reduction of transfer rate).
- 9) Installed in PCI slot.

3.9.23.4 Temperature humidity diagram

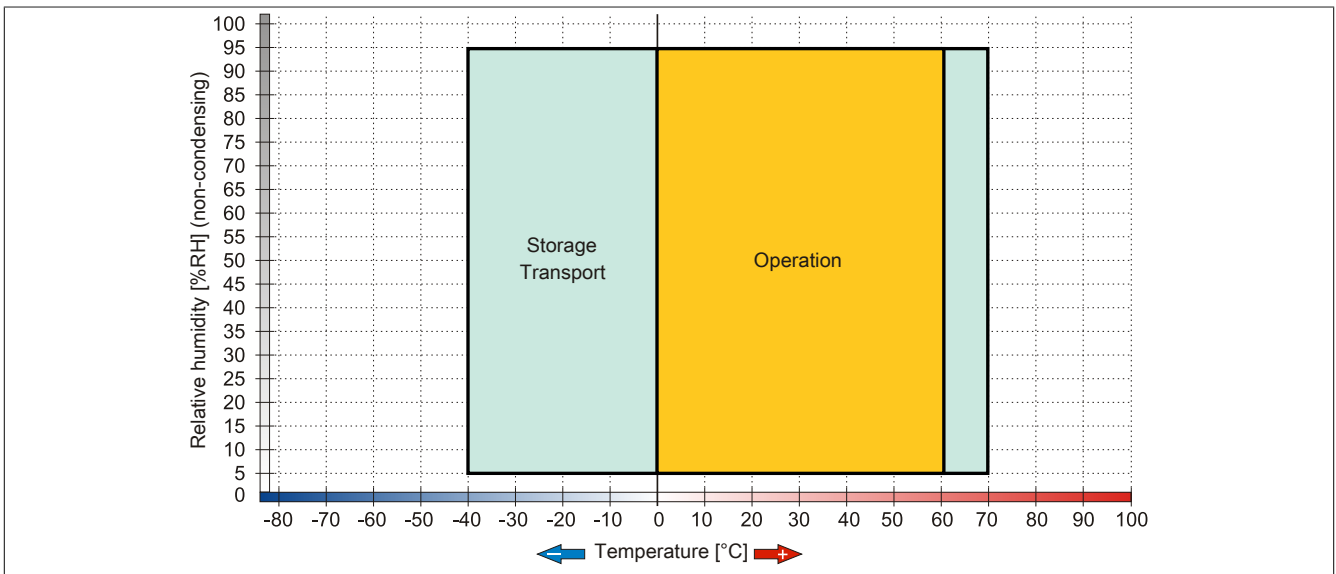

Figure 60: 5ACPCI.RAIC-06 - Temperature humidity diagram

3.9.23.5 Driver support

Special drivers are necessary for operating the PCI SATA RAID controller. Drivers for supported and approved operating systems are available in the Downloads section of the B&R website (www.br-automation.com).

.NET-based SATA Raid™ serial ATA RAID management software can also be found on the B&R website.

Information:

Required drivers can only be downloaded from the B&R website, not from manufacturer websites.

3.9.23.6 Configuration

For information about configuring a SATA RAID set, see 3 "Installation", section 8 "Configuring a SATA RAID set" on page 176.

3.9.23.7 Replacing a HDD

A hard drive can be easily replaced in the event of an error when using the RAID1 (mirroring) configuration without having to reinstall the system. The 500 GB 5MMHDD.0500-00 SATA HDD is available as a replacement hard disk.

For information about performing a replacement, see "Replacing a PCI SATA RAID hard disk in a RAID 1 set" on page 360.

3.9.24 5MMHDD.0250-00

3.9.24.1 General information

This 250 GB hard disk can be used as a replacement part or accessory.

- 250 GB hard disk
- Replacement hard disk for a 5AC801.HDDI-03 hard disk or a 5ACPCI.RAIC-05 RAID controller
- APC510 accessory (optional hard disk for the I/O board)
- Specified for 24-hour operation
- S.M.A.R.T. support

3.9.24.2 Order data

Model number	Short description	Figure
5MMHDD.0250-00	250 GB SATA hard disk; replacement for 5AC801.HDDI-03 and 5ACPCI.RAIC-05; note: please see the manual for information about using this hard disk	

Table 110: 5MMHDD.0250-00 - Order data

3.9.24.3 Technical data

Caution!

A sudden power failure may result in data loss! In very rare cases, the mass storage device may also become damaged.

To prevent damage and loss of data, the use of a UPS is recommended.

Information:

The following characteristics, features and limit values only apply to this individual component and can deviate from those specified for the complete system. For the complete system in which this individual component is used, refer to the data given specifically for that device.

Product ID	5MMHDD.0250-00
General information	
Certification	
CE	Yes
cULus	Yes
cULus HazLoc Class 1 Division 2	Yes ¹⁾
GOST-R	Yes
Hard disk drive	
Capacity	250 GB
Number of heads	1
Number of sectors	488,397,168
Bytes per sector	512
Cache	8 MB
Speed	5400 rpm \pm 0.2%
Startup time	Typ. 3.6 s (from 0 rpm to read access)
MTBF	550,000 POH ²⁾
S.M.A.R.T. support	Yes
Interface	SATA
Access time	5.56 ms
Supported transfer modes	SATA 1.0, Serial ATA Revision 2.6 PIO mode 0-4, multiword DMA mode 0-2, UDMA mode 0-6
Data transfer rate	
Internal	Max. 1175 Mbit/s
To/From host	Max. 150 MB/s (SATA I), max. 300 MB/s (SATA II)
Positioning time	
Minimum (track to track)	1 ms
Nominal (read only)	14 ms
Maximum (read only)	30 ms

Table 111: 5MMHDD.0250-00 - Technical data

Product ID	5MMHDD.0250-00
Environmental conditions	
Temperature ³⁾	
Operation ⁴⁾	0 to 60°C
24-hour operation ⁵⁾	0 to 60°C
Storage	-40 to 70°C
Transport	-40 to 70°C
Relative humidity ⁶⁾	
Operation	5 to 95%, non-condensing
Storage	5 to 95%, non-condensing
Transport	5 to 95%, non-condensing
Vibration	
Operation	5 to 500 Hz: 0.5 g; no unrecoverable errors
Storage	5 to 500 Hz: 5 g; no unrecoverable errors
Transport	5 to 500 Hz: 5 g; no unrecoverable errors
Shock	
Operation	350 g and 2 ms duration; no unrecoverable errors
Storage	800 g and 2 ms duration; no unrecoverable errors
	1000 g and 1 ms duration; no unrecoverable errors
Transport	600 g and 0.5 ms duration; no unrecoverable errors
	800 g and 2 ms duration; no unrecoverable errors
	1000 g and 1 ms duration; no unrecoverable errors
	600 g and 0.5 ms duration; no unrecoverable errors
Altitude	
Operation	-300 to 3048 m
Storage	-300 to 12192 m
Mechanical characteristics	
Dimensions	
Width	9.5 mm
Height	69 mm
Depth	100 mm
Weight	100 g
Manufacturer information	
Manufacturer	Seagate
Manufacturer product ID	ST9250315AS

Table 111: 5MMHDD.0250-00 - Technical data

- 1) Yes, although applies only if all components installed within the complete system have this certification
- 2) With 8760 POH (power-on hours) per year and 25°C surface temperature.
- 3) Temperature values at an elevation of 305 meters. The temperature specification must be reduced linearly by 1°C every 305 meters. The temperature increase and decrease can be a maximum of 20°C per hour.
- 4) Standard operation refers to 333 POH (power-on hours) per month.
- 5) 24-hour operation refers to 732 POH (power-on hours) per month.
- 6) Humidity gradient: Maximum 30% per hour.

3.9.24.4 Temperature humidity diagram

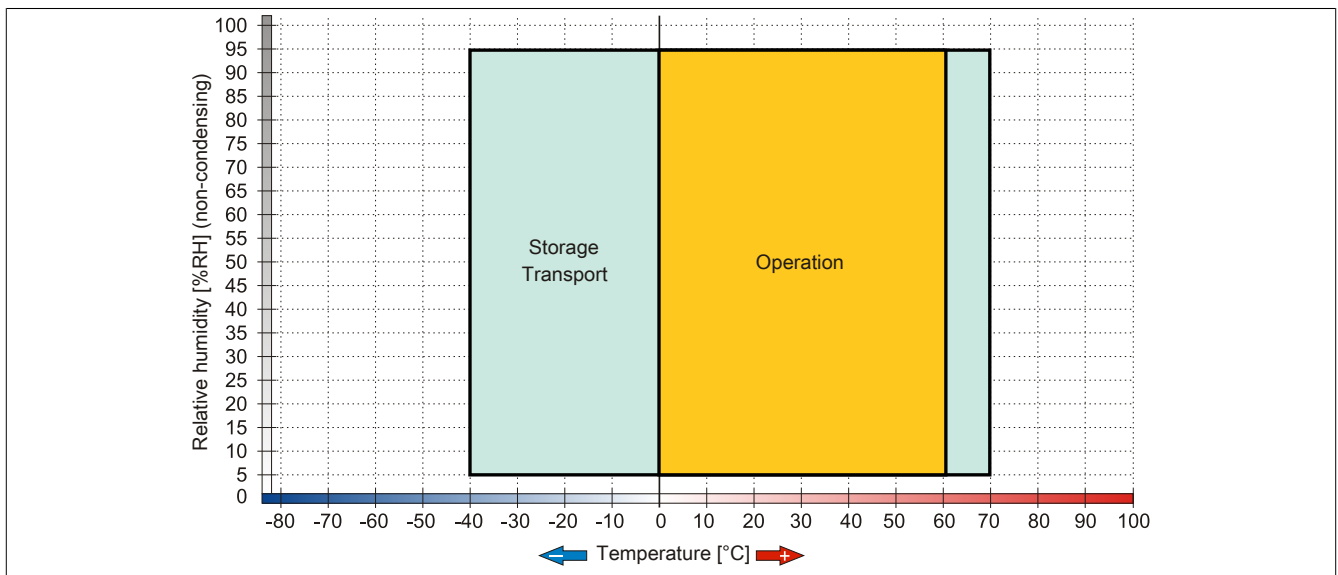

Figure 61: 5MMHDD.0250-00 - Temperature humidity diagram

3.9.25 5MMHDD.0500-00

3.9.25.1 General information

This 500 GB hard disk can be used as a replacement part or accessory.

- 500 GB hard disk
- Replacement hard disk for a 5AC801.HDDI-04 / 5AC901.CHDD-01 hard disk or a 5ACPCI.RAIC-05 RAID controller
- APC510 accessory (optional hard disk for the I/O board)
- Specified for 24-hour operation
- S.M.A.R.T. support

3.9.25.2 Order data

Model number	Short description	Figure
	Drives	
5MMHDD.0500-00	500 GB hard disk - SATA	

Table 112: 5MMHDD.0500-00 - Order data

3.9.25.3 Technical data

Caution!

A sudden power failure may result in data loss! In very rare cases, the mass storage device may also become damaged.

To prevent damage and loss of data, the use of a UPS is recommended.

Information:

The following characteristics, features and limit values only apply to this accessory and can deviate from those specified for the complete system. The data specifications for the complete system take precedence over those of individual components.

Product ID	5MMHDD.0500-00
General information	
Certification	
CE	Yes
cULus	Yes
cULus HazLoc Class 1 Division 2	Yes ¹⁾
GOST-R	Yes
Hard disk drive	
Capacity	500 GB
Number of heads	2
Number of sectors	976,773,168
Bytes per sector	512 (logical) / 4096 (physical)
Cache	16 MB
Speed	5400 rpm ±0.2%
Startup time	Typ. 3.5 s (from 0 rpm to read access)
Service life	5 years
MTBF	1,000,000 POH ²⁾
S.M.A.R.T. support	Yes
Interface	SATA
Access time	5.5 ms
Supported transfer modes	SATA II

Table 113: 5MMHDD.0500-00 - Technical data

Product ID	5MMHDD.0500-00
Data transfer rate Internal To/From host	Max. 147 MB/s Max. 150 MB/s (SATA I), max. 300 MB/s (SATA II)
Positioning time Nominal (read only) Maximum (read only)	11 ms 21 ms
Environmental conditions	
Temperature ³⁾ Operation ⁴⁾ 24-hour operation ⁵⁾ Storage Transport	0 to 60°C 0 to 60°C -40 to 70°C -40 to 70°C
Relative humidity ⁶⁾ Operation Storage Transport	5 to 95%, non-condensing 5 to 95%, non-condensing 5 to 95%, non-condensing
Vibration Operation (continuous) Operation (occasional) Storage Transport	5 to 500 Hz: 0.25 g; no unrecoverable errors 5 to 500 Hz: 0.5 g; no unrecoverable errors 10 to 500 Hz: 5 g; no unrecoverable errors 10 to 500 Hz: 5 g; no unrecoverable errors
Shock Operation Storage Transport	400 g and 2 ms duration; no unrecoverable errors 1000 g and 2 ms duration; no unrecoverable errors 1000 g and 2 ms duration; no unrecoverable errors
Altitude Operation Storage	-305 to 3048 m -305 to 12192 m
Mechanical characteristics	
Dimensions Width Height Depth	7 mm 69 mm 100 mm
Weight	100 g
Manufacturer information	
Manufacturer	Western Digital
Manufacturer's product ID	WD5000LUCT

Table 113: 5MMHDD.0500-00 - Technical data

- 1) Yes, although applies only if all components installed within the complete system have this certification
- 2) With 8760 POH (power-on hours) per year and 25°C surface temperature.
- 3) Temperature values at an elevation of 305 meters. The temperature specification must be reduced linearly by 1°C every 305 meters. The temperature increase and decrease can be a maximum of 20°C per hour.
- 4) Standard operation refers to 333 POH (power-on hours) per month.
- 5) 24-hour operation refers to 732 POH (power-on hours) per month.
- 6) Humidity gradient: Maximum 20% per hour.

3.9.25.4 Temperature humidity diagram

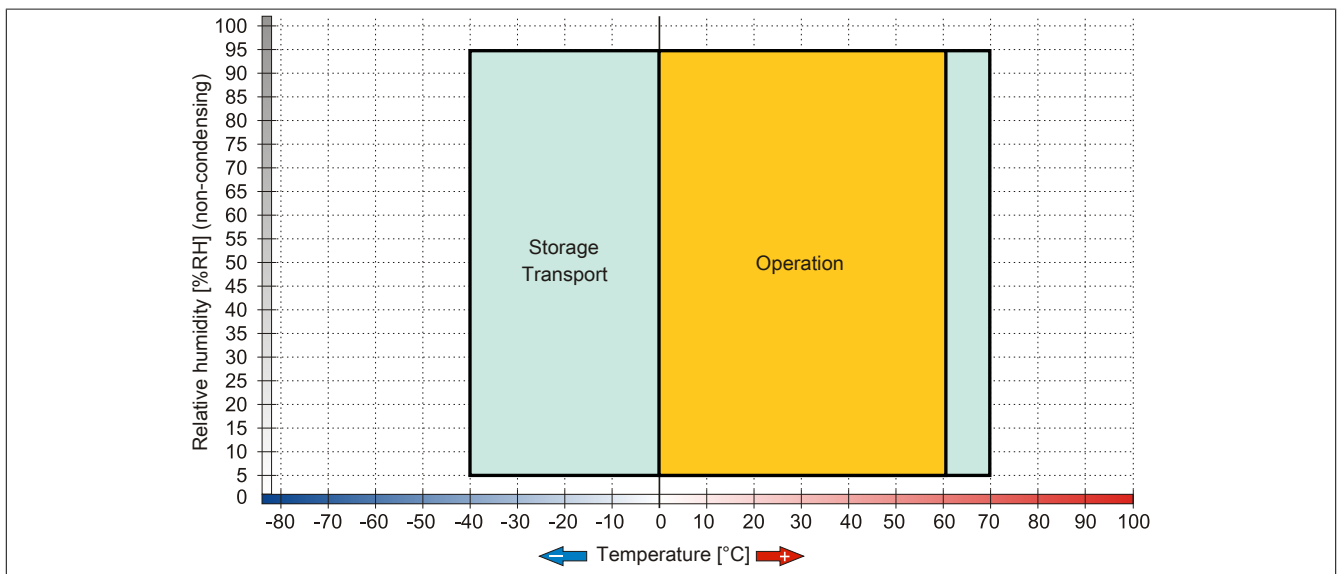

Figure 62: 5MMHDD.0500-00 - Temperature humidity diagram

3.10 Fan kit

Information:

Fans are necessary when using components that must work within certain temperature limits, e.g. DVD combos and PCI cards.

Fan and dust filters are subject to wear and must be checked with appropriate frequency and cleaned or replaced when not functioning properly (e.g. due to dirt and grime).

3.10.1 5AC803.FA01-00

3.10.1.1 General information

This fan kit is an optional addition for PPC800 system units without an expansion.

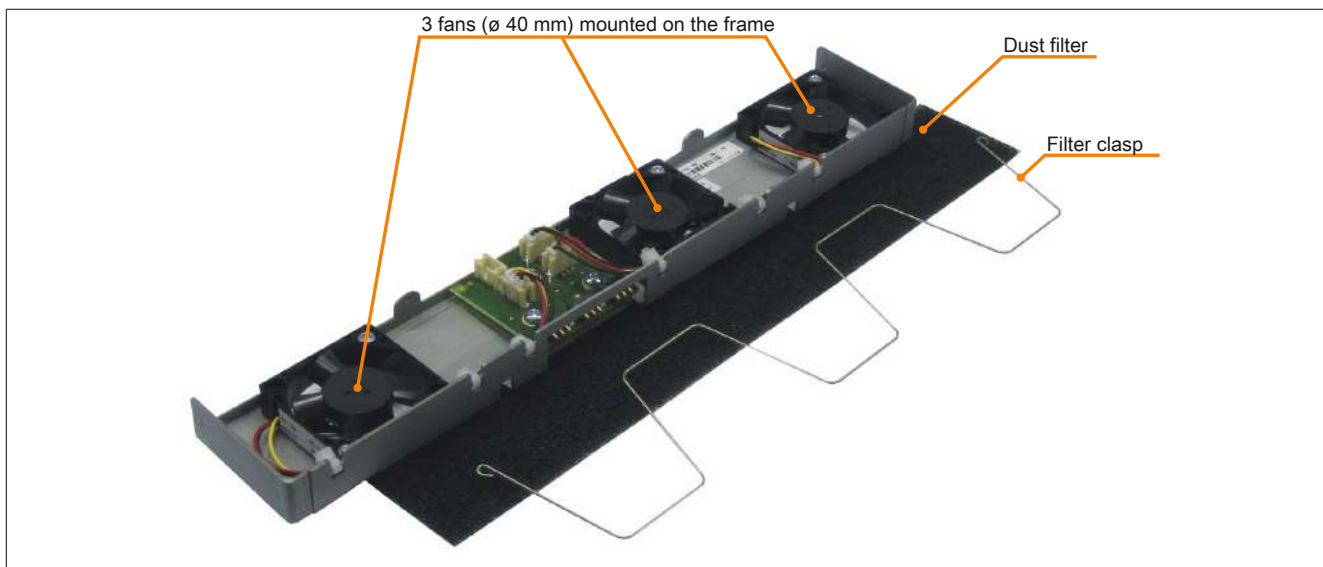

Figure 63: 5AC803.FA01-00 - Fan kit

3.10.1.2 Order data

Model number	Short description	Figure
5AC803.FA01-00	Fan kits PPC800 fan kit for system units without an expansion	

Table 114: 5AC803.FA01-00 - Order data

3.10.1.3 Technical data

Product ID	5AC803.FA01-00
General information	
Number of fans	3
Speed	Max. 6100 rpm
Noise level	21 dB
Service life	29,000 hours at 70°C 95,000 hours at 20°C
Type	Double ball bearings
Certification	
CE	Yes
GOST-R	Yes

Table 115: 5AC803.FA01-00 - Technical data

Product ID	5AC803.FA01-00
Mechanical characteristics	
Dimensions	
Fan	
Width	40 mm
Height	40 mm
Depth	10 mm

Table 115: 5AC803.FA01-00 - Technical data

3.10.2 5AC803.FA02-00

3.10.2.1 General information

This fan kit can be installed as an option on PPC800 system units with the 1-slot expansion.

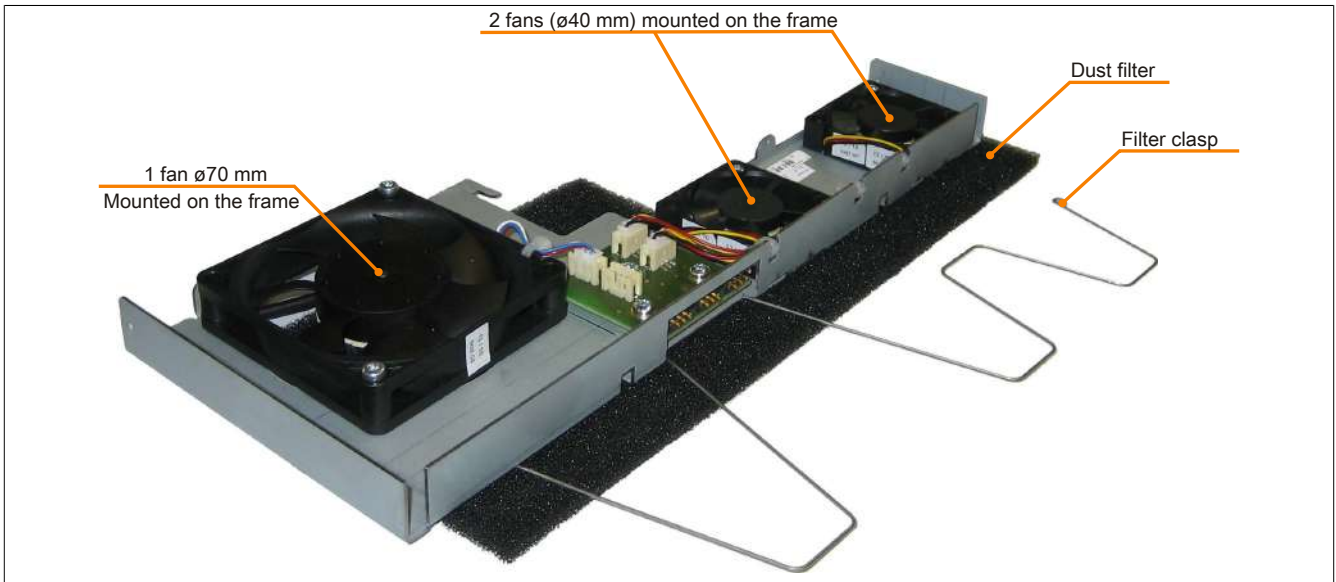

Figure 64: 5AC803.FA02-00 - Fan kit

3.10.2.2 Order data

Model number	Short description	Figure
	Fan kits	
5AC803.FA02-00	PPC800 fan kit for system units with expansion 5AC803.SX01-00	

Table 116: 5AC803.FA02-00 - Order data

3.10.2.3 Technical data

Product ID	5AC803.FA02-00
General information	
Number of fans	3
Speed	Fans 1, 2: max. 6100 rpm Fan 3: 4300 rpm ± 10%
Noise level	Fans 1, 2: 21 dB Fan 3: 5 dB
Service life	Fans 1, 2: 29,000 hours at 70°C, 95,000 hours at 20°C Fan 3: 60,000 hours (at 40°C)
Type	Double ball bearings
Certification	
CE	Yes
GOST-R	Yes

Table 117: 5AC803.FA02-00 - Technical data

Product ID	5AC803.FA02-00
Mechanical characteristics	
Dimensions Fan Width Height Depth	Fans 1, 2: 40 mm Fan 3: 70 mm Fans 1, 2: 40 mm Fan 3: 70 mm Fans 1, 2: 10 mm Fan 3: 15 mm

Table 117: 5AC803.FA02-00 - Technical data

3.10.3 5AC803.FA03-00

3.10.3.1 General information

This fan kit can be installed as an option on PPC800 system units with the 2-slot expansion.

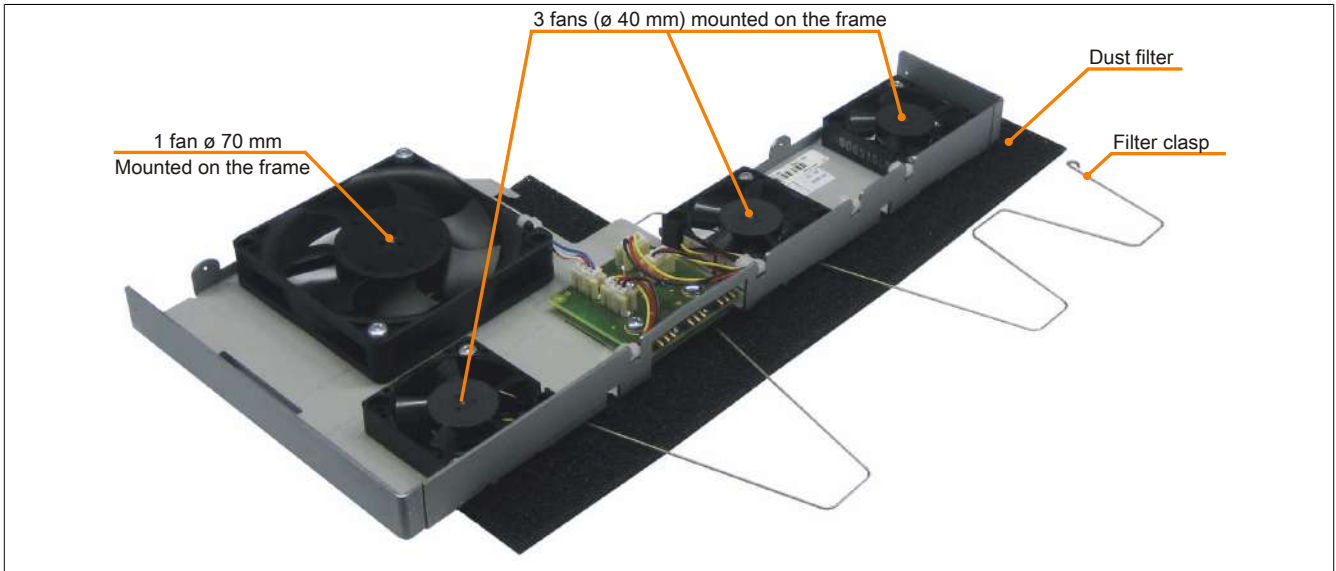

Figure 65: 5AC803.FA03-00 - Fan kit

3.10.3.2 Order data

Model number	Short description	Figure
5AC803.FA03-00	Fan kits PPC800 fan kit for system units with expansion 5AC803.SX02-00	

Table 118: 5AC803.FA03-00 - Order data

3.10.3.3 Technical data

Product ID	5AC803.FA03-00
General information	
Number of fans	4
Speed	Fans 1, 2, 3: max. 6100 rpm Fan 4: 4300 rpm ± 10%
Noise level	Fan 1, 2, 3: 21 dB Fan 4: 5 dB
Service life	Fan 1, 2, 3: 29,000 hours at 70°C, 95,000 hours at 20°C Fan 4: ±60,000 at 40°C
Type	Double ball bearings
Certification	
CE	Yes
GOST-R	Yes

Table 119: 5AC803.FA03-00 - Technical data

Product ID	5AC803.FA03-00
Mechanical characteristics	
Dimensions Fan Width Height Depth	Fan 1, 2, 3: 40 mm Fan 4: 70 mm Fan 1, 2, 3: 40 mm Fan 4: 70 mm Fan 1, 2, 3: 10 mm Fan 4: 15 mm

Table 119: 5AC803.FA03-00 - Technical data

Chapter 3 • Installation

1 Installation

Danger!

- All supplied power must be disconnected before removing device covers or components or installing/removing accessories, hardware or cables.
- The power cable must be disconnected from the device and from the voltage supply.
- All covers, components, accessories, hardware and cables must be installed or connected before the device can be connected to the power supply and turned on.

B&R Industrial PCs are best mounted in a wall cutout using the retaining clips or clamping blocks found on the housing (designs may vary).

1.1 Important installation information

- Environmental conditions must be taken into consideration.
- When installed in an enclosure, enough space must be available for air to circulate sufficiently.
- This device must be installed on a flat, clean and burr-free surface.
- This device is only certified for operation in enclosed rooms.
- This device must not be subjected to direct sunlight.
- Ventilation holes must not be covered.
- This device must be installed using one of the approved mounting orientations.
- The wall or control cabinet must be able to withstand four times the total weight of the device.
- The flex radius of connected cables (DVI, SDL, USB, etc.) must not be exceeded.
- This device must be installed in a position that minimizes glare on the screen.
- This device must be installed in a position and orientation that make viewing as easy as possible for the operator.

1.2 Installation with clamping blocks

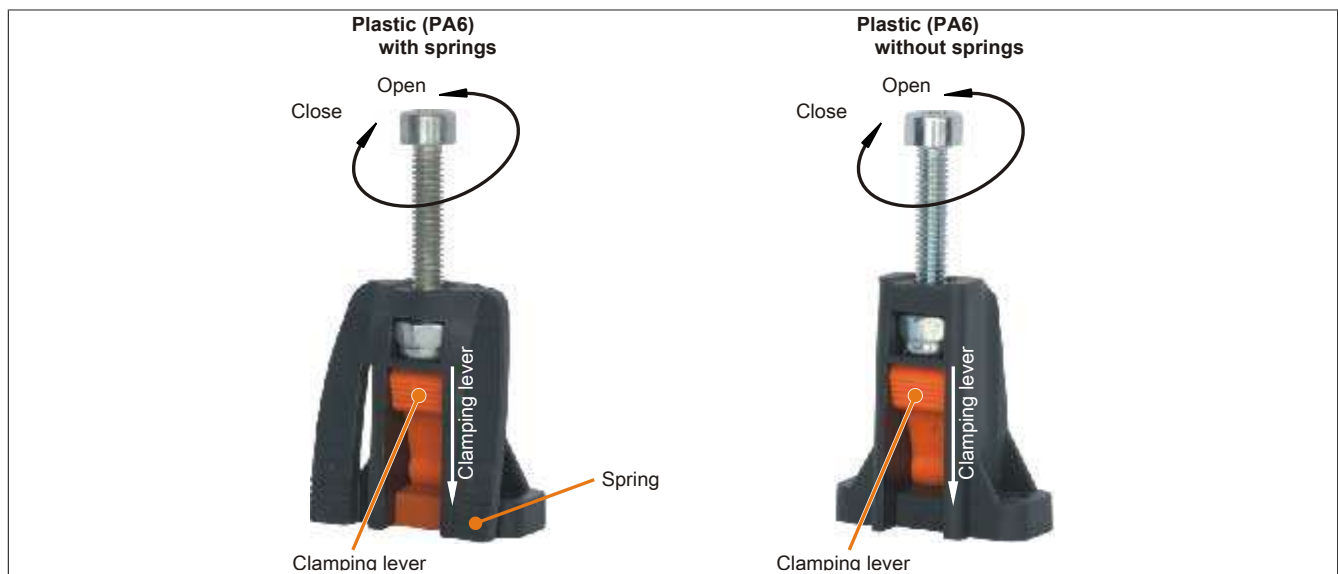

Figure 66: Clamping blocks

Clamping blocks are designed to clamp a maximum thickness of 10 mm and minimum thickness of 2 mm.

A hex key (3 mm) is needed to tighten and loosen the screws. The maximum torque when tightening the clamp is 0.5 Nm.

Devices must be installed on flat, clean and burr-free surface; uneven areas can cause damage to the display when the screws are tightened or intrusion of dust and water.

1.3 Mounting orientation

The PPC800 must be mounted as described in the following sections.

1.3.1 Mounting orientation 0° and +/- 45°

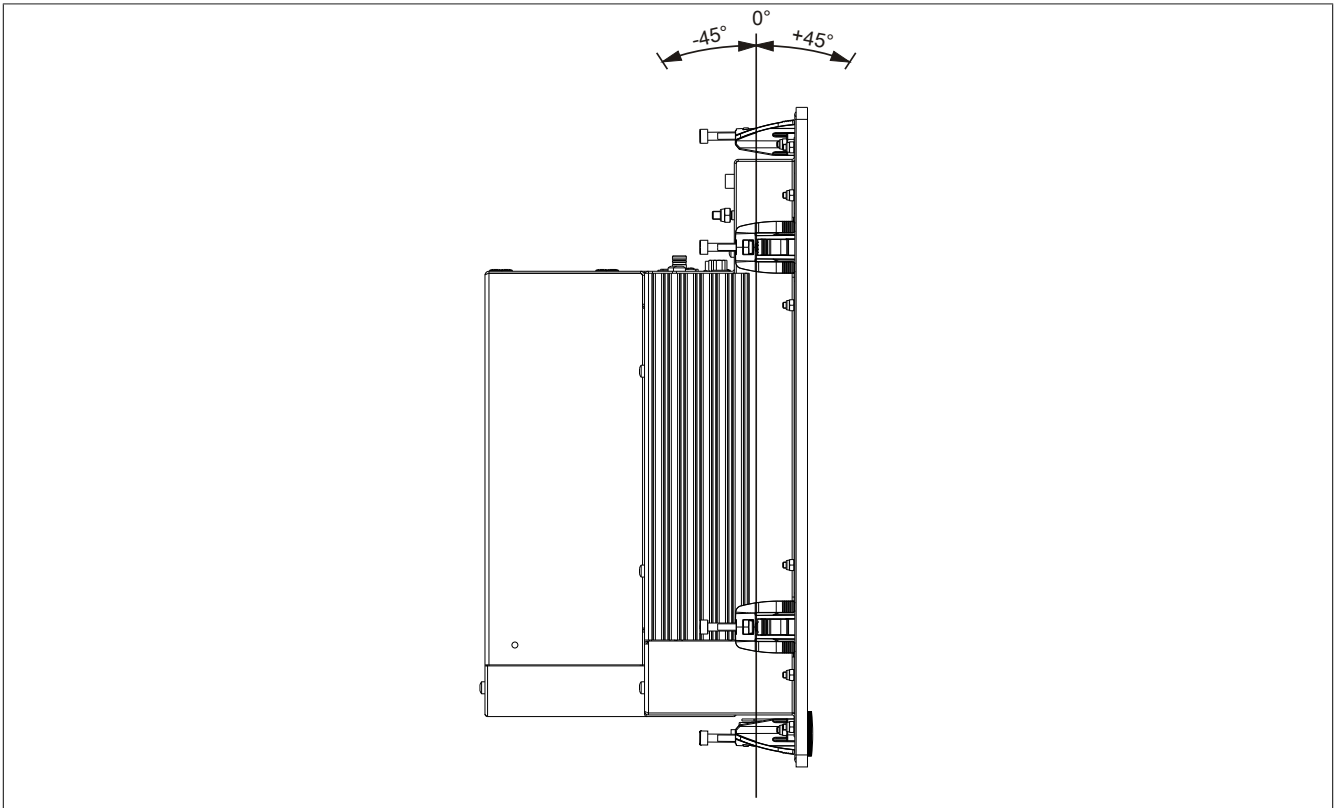

Figure 67: Mounting orientation 0° and +/- 45°

In order to facilitate natural air circulation, devices must be mounted according to the spacing indicated in the section "Spacing for air circulation" on page 154.

1.3.2 Mounting orientation with 5AC801.DVRS-00

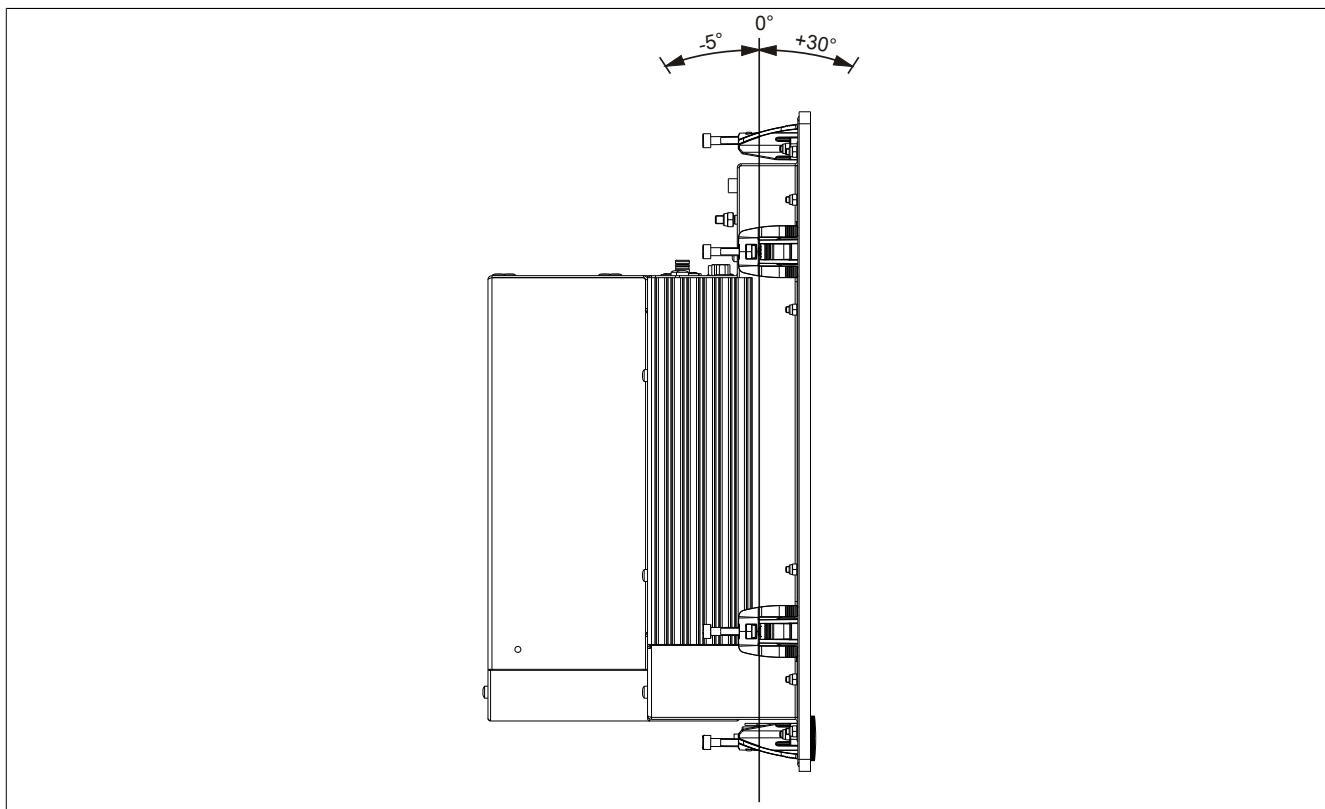

Figure 68: Mounting orientation with 5AC801.DVRS-00

In order to facilitate natural air circulation, devices must be mounted according to the spacing indicated in the section "Spacing for air circulation" on page 154.

1.3.3 Mounting orientation with 5AC801.DVDS-00

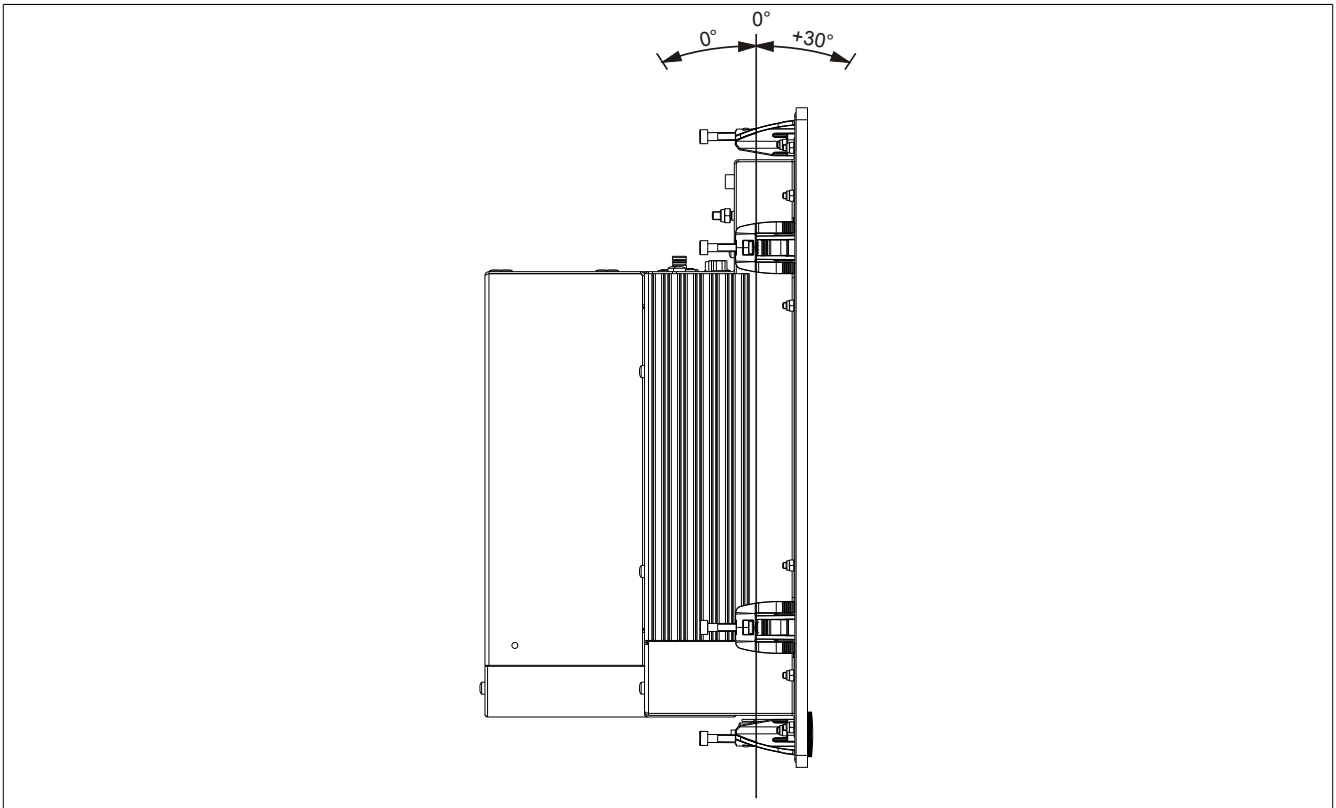

Figure 69: Mounting orientation with 5AC801.DVDS-00

In order to facilitate natural air circulation, devices must be mounted according to the spacing indicated in the section "Spacing for air circulation" on page 154.

1.4 Spacing for air circulation

In order to guarantee sufficient air circulation, allow the specified amount of space above, below, to the side and behind the Panel PC 800 devices. The minimum specified spacing is indicated in the following diagram. This applies to all Panel PC 800 variants.

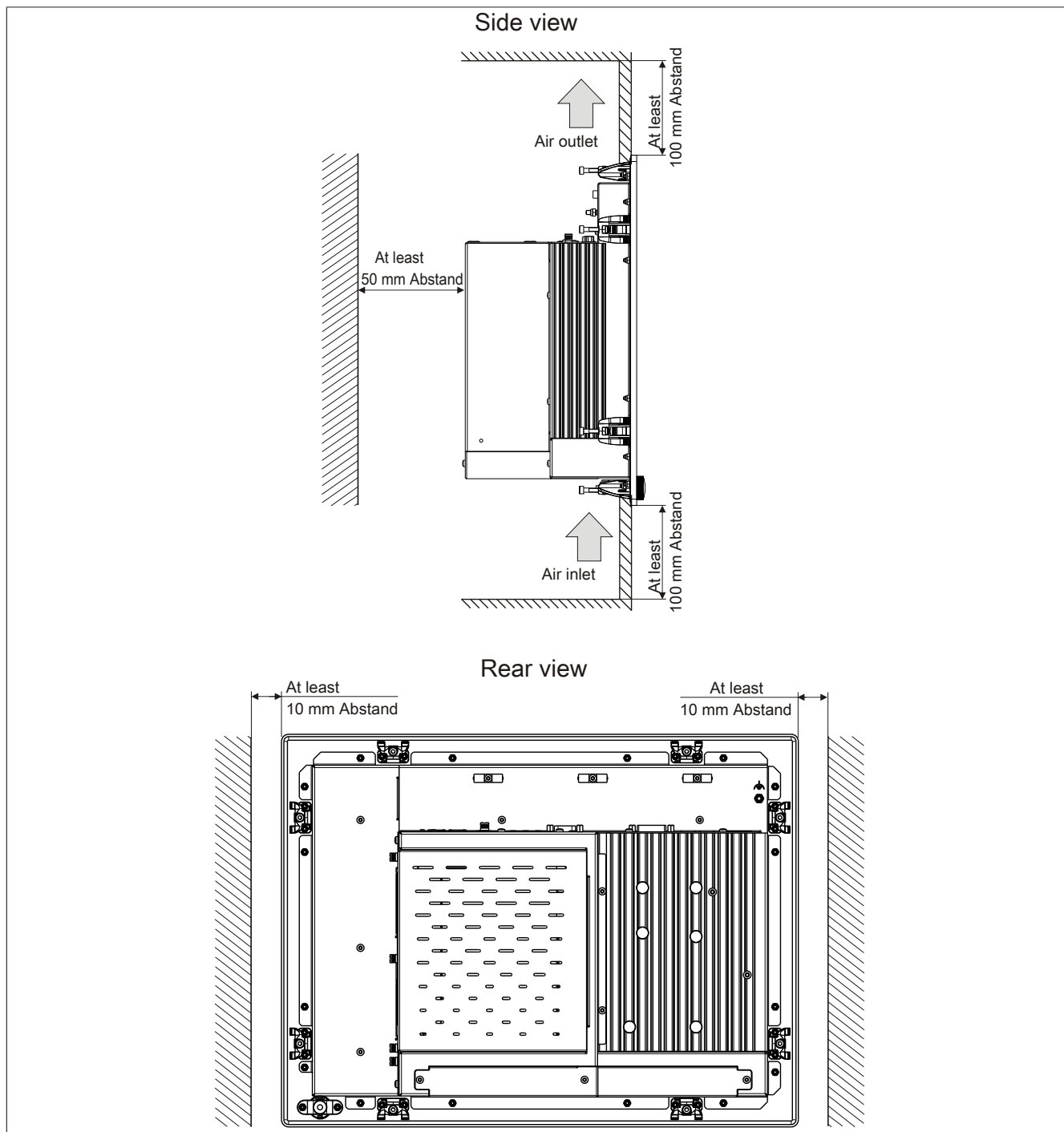

Figure 70: Spacing for air circulation

Information:

The spacing specifications for air circulation are based on the worst-case scenario for operation at the maximum specified ambient temperature (see "Temperature specifications" in the chapter "Technical data").

If the spacing specifications for air circulation cannot be adhered to, then the maximum specified temperatures for the temperature sensors (see "Temperature sensor locations" in the chapter "Technical data") must be monitored by the user and appropriate measures taken if they are exceeded.

2 Cable connections

Flex radius specifications must be taken into account when installing or connecting cables.

Information:

The maximum torque for the locating screws is 0.5 Nm.

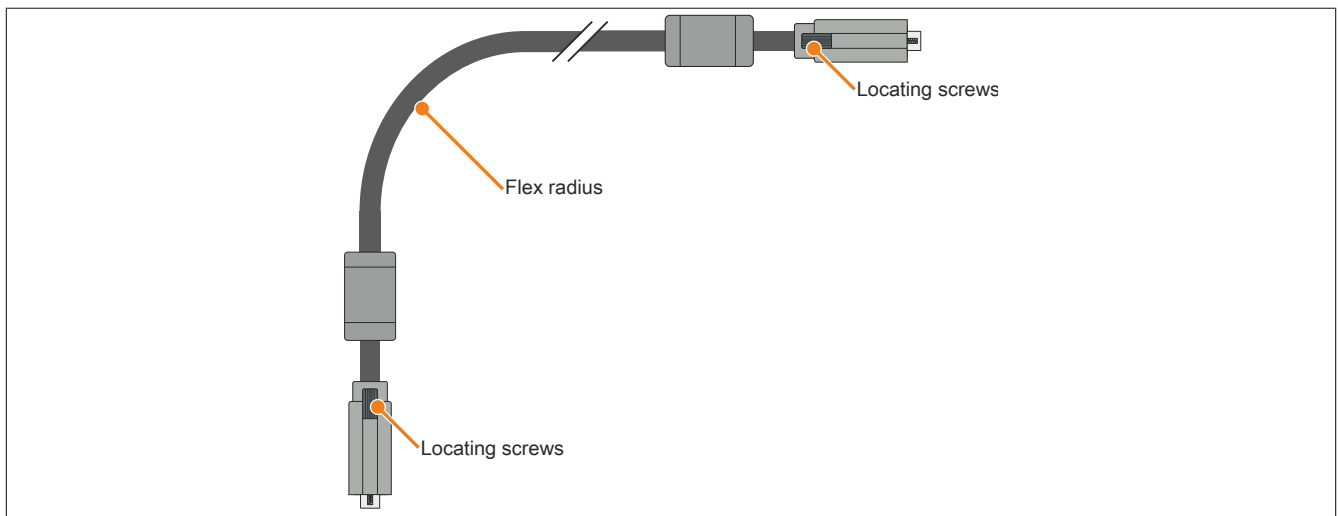

Figure 71: Flex radius - Cable connection

Information:

The specified flex radius is listed in the technical data for the respective cable.

3 Grounding concept

Functional ground is a current path of low impedance between electrical circuits and ground. It is used, for example, to improve immunity to disturbances and not necessarily as a protective measure. It therefore serves only to deflect disturbances, not to provide any kind of protection against electric shock.

This device comes equipped with two functional ground connections:

- Power supply
- Ground connection

To guarantee safe conductance of electric disturbances, the following points must be observed:

- The device must be connected to the central grounding point in the control cabinet using the shortest route possible.
- A cable with a minimum cross section of 2.5 mm^2 per connection should be used. If a cable with wire end sleeves is connected to the 0TB103.9 or 0TB103.91 terminal block, then a cable with maximum 1.5 mm^2 per connection is possible.
- Note the line shielding concept. All data cables connected to the device must be shielded.

Symbol indicating functional ground on the B&R device: 

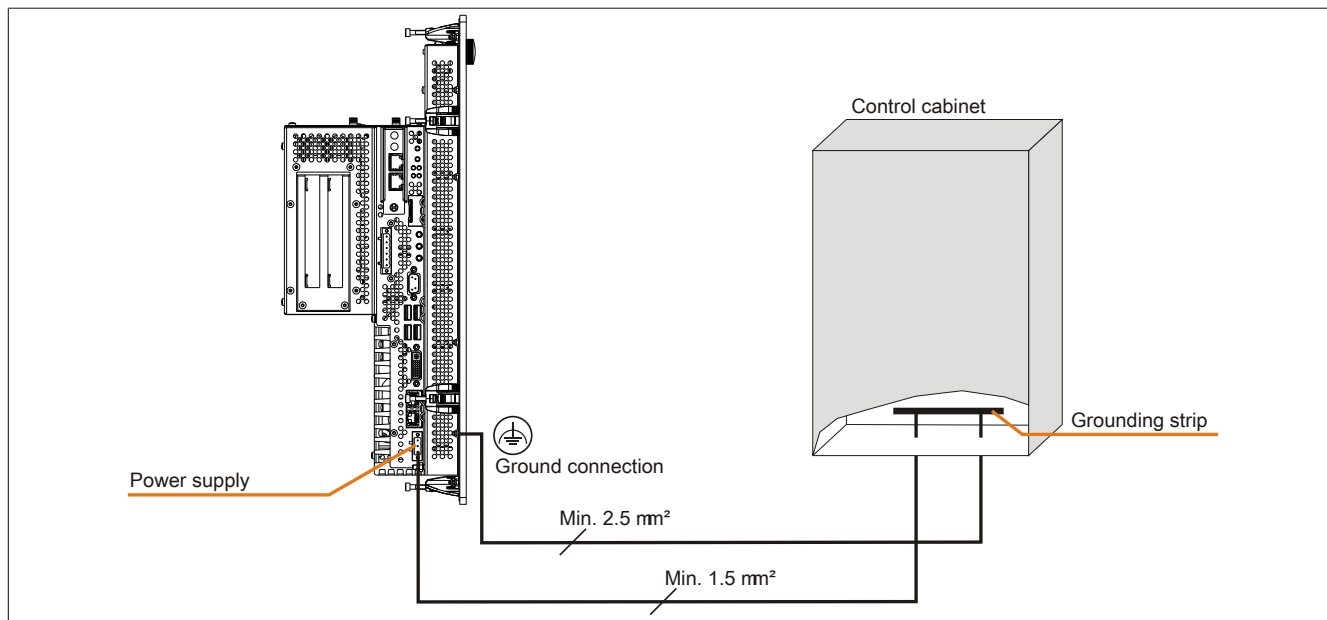

Figure 72: Grounding concept

4 General instructions for performing temperature testing

The purpose of these instructions is to explain general procedures for performing application-specific temperature testing on B&R Industrial PCs and Power Panels. Nevertheless, these instructions are meant to serve only as a guideline.

4.1 Procedure

In order to obtain accurate results, the testing conditions should match the conditions in the field. This means that for the duration of the temperature tests, the target application should be running, the PC should be installed in the control cabinet that will be used, etc.

In addition, a temperature sensor should be installed for the device being tested to provide live monitoring of the ambient temperature. In order to obtain accurate measurements, this sensor should be installed at a distance of 5 to 10 cm from the B&R Industrial PC near the air intake (not near the exhaust).

All B&R Industrial PCs and Power Panels are equipped with internal temperature sensors. These are installed in different locations for each series. The number of sensors and the temperature limits also vary from series to series.

For information about the locations of temperature sensors and the maximum specified values, please see section "Temperature sensor locations" in chapter 2 "Technical data".

To ensure that the thermal situation is evaluated reliably, a minimum of 8 hours is recommended for testing.

4.2 Evaluating temperatures in Windows operating systems

4.2.1 Evaluating with the B&R Control Center

The B&R Control Center can be used to evaluate the temperatures. Temperatures can be viewed on the "Temperatures" property page. The B&R Control Center is available at no cost in the Downloads section of the B&R website (www.br-automation.com). The B&R Control Center uses the B&R Automation Device Interface (ADI).

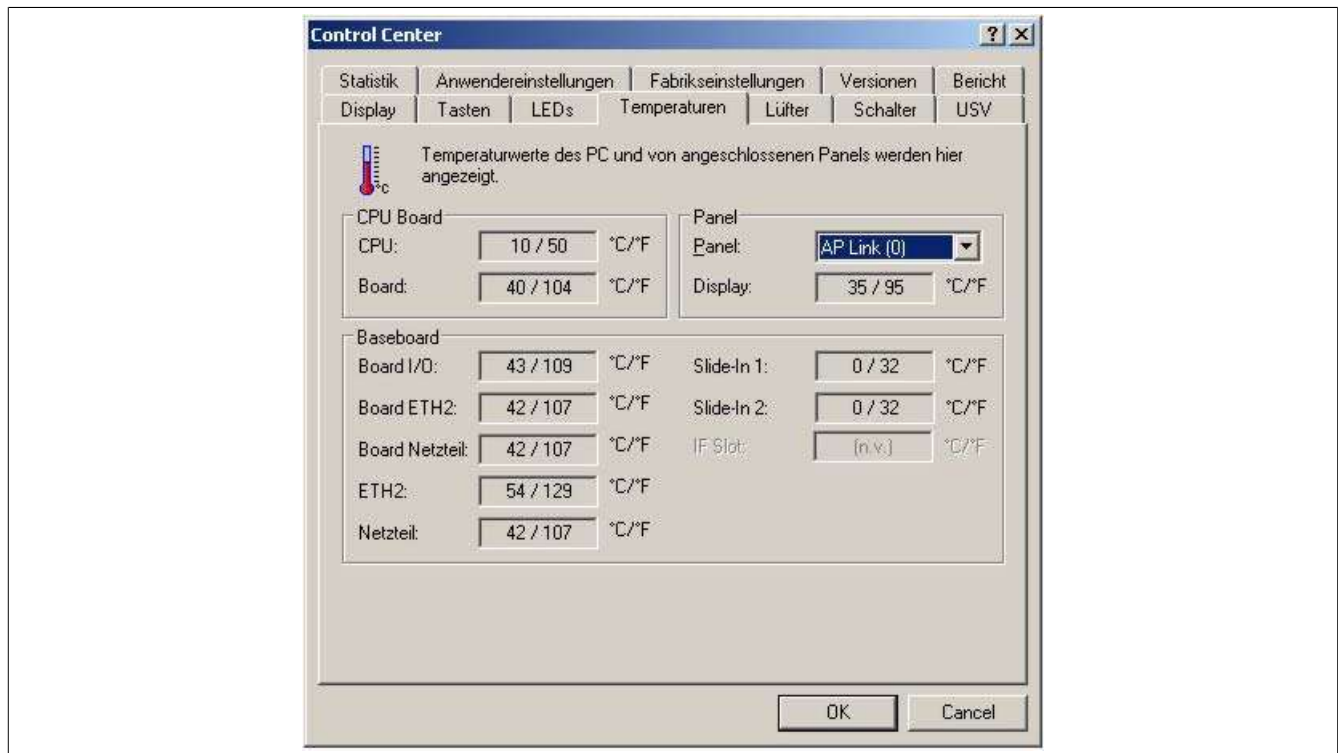

A separate application can be developed if it is necessary to collect historical data.

Information:

Software development kits such as the ADI .NET SDK are available on the B&R website (www.br-automation.com).

4.2.2 Evaluating with the BurnInTest tool from Passmark

If a separate application is not created or used to evaluate the temperature, then B&R recommends using the BurnInTest software tool from Passmark.

Standard and Professional versions of BurnInTest are available. In addition to the software package, there are also various loopback plugs (serial, parallel, USB, etc.) and test CDs/DVDs available. The exact software and loopback plugs used will determine the corresponding load that can be generated on the system and peripheral devices.

Information:

Loopback plugs are also available from Passmark. More information is available at www.passmark.com.

The following screenshots are based on Passmark BurnInTest Pro V4 and a 2-slot APC810 with DVD.

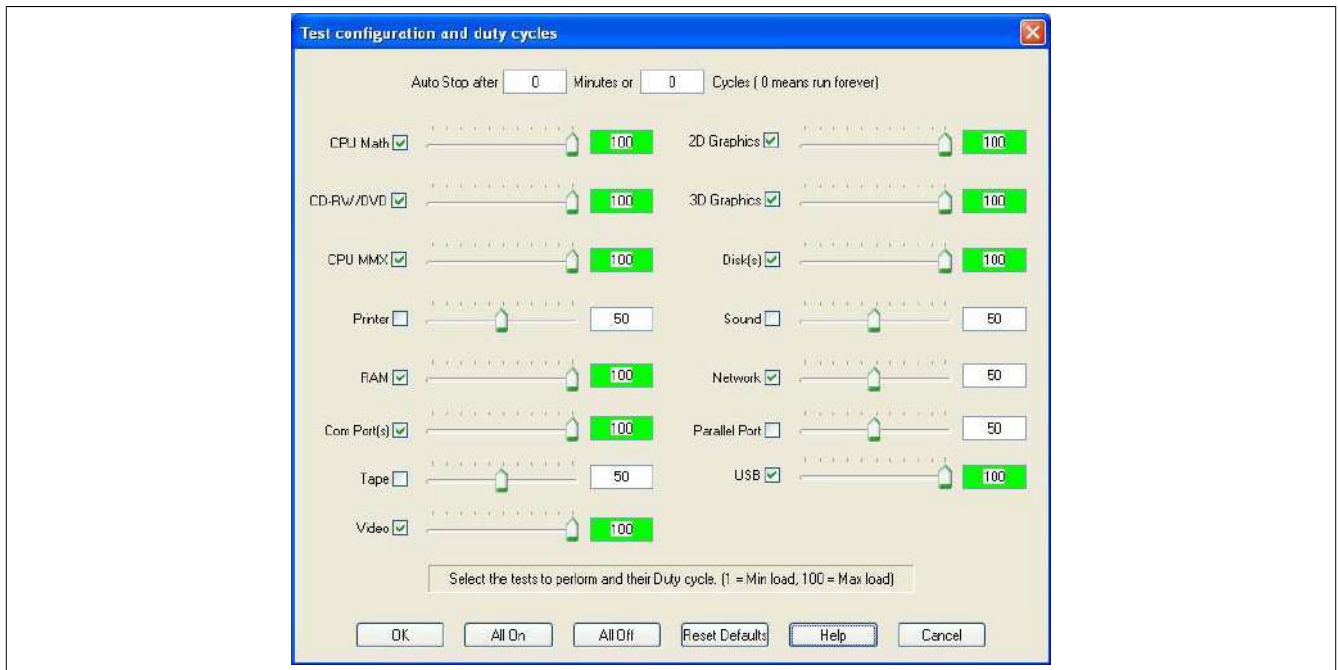

Figure 73: Settings for Passmark BurnInTest Pro V4 and a 2-slot APC810 with DVD

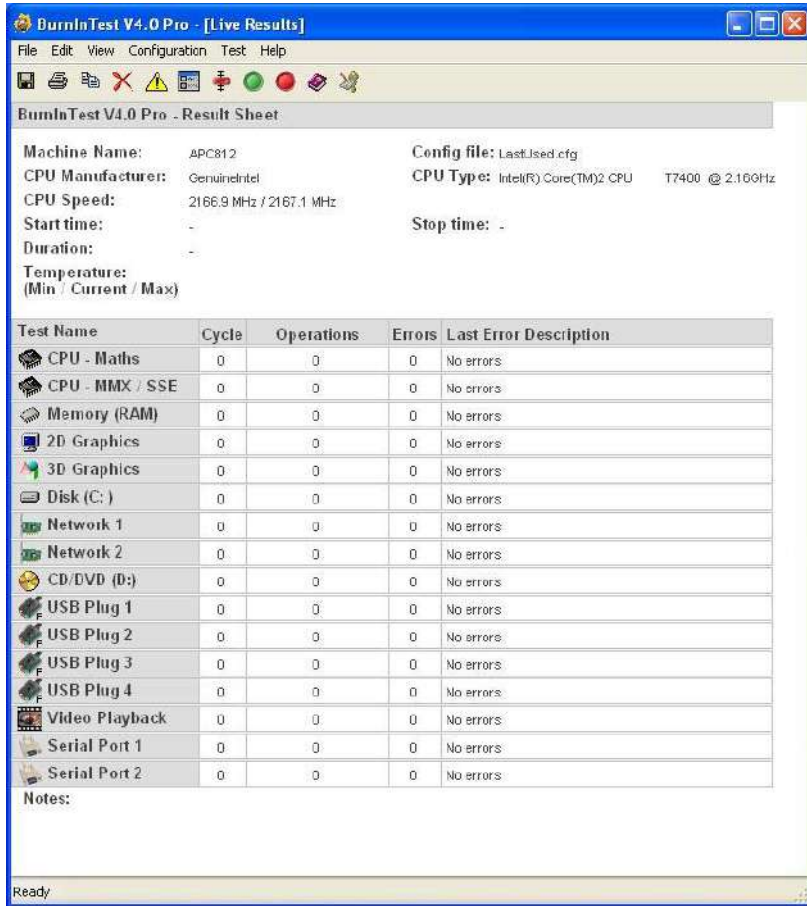

Figure 74: Test overview of a 2-slot APC810 with DVD

The respective test properties may need to be fine-tuned depending on the availability of a loopback plug and DVDs.

Information:

USB flash drives can also be used if a USB loopback plug is not available. The USB flash drives must be detected as formatted drives in Windows. The test USB must then be deselected, and the USB flash drives must be configured as the testing device in the disk properties.



Information:

Serial loopback plugs are relatively easy to create. Simply connect several pins on the serial interface with wires.

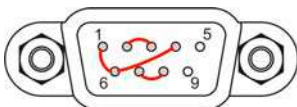

4.3 Evaluating temperatures in operating systems other than Windows

For applications that don't use Windows, temperatures can be evaluated with the help of the B&R implementation guide. In addition to the implementation guide, there are also programs available in MS-DOS.

The implementation guide only describes device-specific functions and not the main functions of the example programs.

If code from the example programs is used, it is important to observe the notes in the implementation guide regarding TODO statements, I/O access functions, etc.

Information:

Example programs and implementation guides for all B&R Industrial PCs and Power Panels are available at no cost from the B&R website (www.br-automation.com).

4.4 Evaluating the measurement results

The maximum temperature value recorded by each sensor must not exceed the temperature limits specified in the user's manuals.

If the temperature tests cannot be performed in a climate-controlled chamber, they can still be performed in an office environment. In this case, however, it is necessary to measure the ambient temperature. Experience at B&R has shown that values measured on passive systems (systems without a fan kit) can be projected linearly based on the ambient temperature. In order to be able to project the temperature values for systems with a fan kit, the fans must be running. It is also important to take values such as speed into consideration.

If the temperature tests are performed in a climate-controlled chamber with fans, the fans will cool the devices and skew the results. Measurement results for passive devices would therefore be unusable in this case. In order to obtain accurate results in climate-controlled chambers with fans, the fans must be turned off and the device must be allowed to run for a sufficient amount of time (several hours) before beginning the test.

Example using a 2-slot APC810

The following example is only valid if the instructions for installation and mounting orientation provided in the user's manual are observed.

Temperature sensor	Measured temperature	Projected temperature	
Ambient temperature	20°C	35°C	45°C
CPU	48°C	63°C	73°C
CPU board	51°C	66°C	76°C
Board I/O	51°C	66°C	76°C
Board ETH2	52°C	67°C	77°C
Board power supply	51°C	66°C	76°C
ETH2	65°C	80°C	90°C
Power supply	51°C	66°C	76°C

Table 120: Evaluation example using a 2-slot APC810

5 Connection examples

The following examples provide an overview of the configuration options for connecting Automation Panel 800 and Automation Panel 900 and/or Automation Panel 800 devices with the PPC800. The following questions will be answered:

- How are Automation Panel 900 devices connected to the monitor/panel output of the PPC800? What needs to be considered?
- How are Automation Panel 800 devices connected to the monitor/panel output of the PPC800? What needs to be considered?
- What are the "display clone" and "extended desktop" modes?
- How many Automation Panel 900 devices can be connected per line?
- How many Automation Panel 900 devices can be connected to an Automation Panel 800 device per line?
- How are the connected devices numbered internally?
- Are there limitations to the segment length? If so, what are they?
- What cables and link modules are needed?
- Do BIOS settings have to be changed for a specific configuration?

5.1 Selecting display units

In order to connect an Automation Panel 800 and an Automation Panel 900 on the same line, the devices must have the same display type. The following table lists the AP900 devices that can be connected on the same line with an AP800 device.

Automation Panel 800	Automation Panel 900
5AP820.1505-00	5AP920.1505-01 5AP951.1505-01 5AP980.1505-01 5AP981.1505-01
5AP880.1505-00	5AP920.1505-01 5AP951.1505-01 5AP980.1505-01 5AP981.1505-01

Table 121: Selecting display units

5.2 One Automation Panel 900 system via onboard DVI

An Automation Panel 900 with max. SXGA resolution is connected to the integrated DVI interface (onboard). As an alternative, an office TFT with a DVI interface or analog monitor (using adapter 5AC900.1000-00) can also be used. A separate cable is used for both the touch screen and USB data. If USB devices are to be operated on the Automation Panel 900, the maximum distance is 5 meters. USB devices can only be connected directly to the Automation Panel (i.e. without a hub).

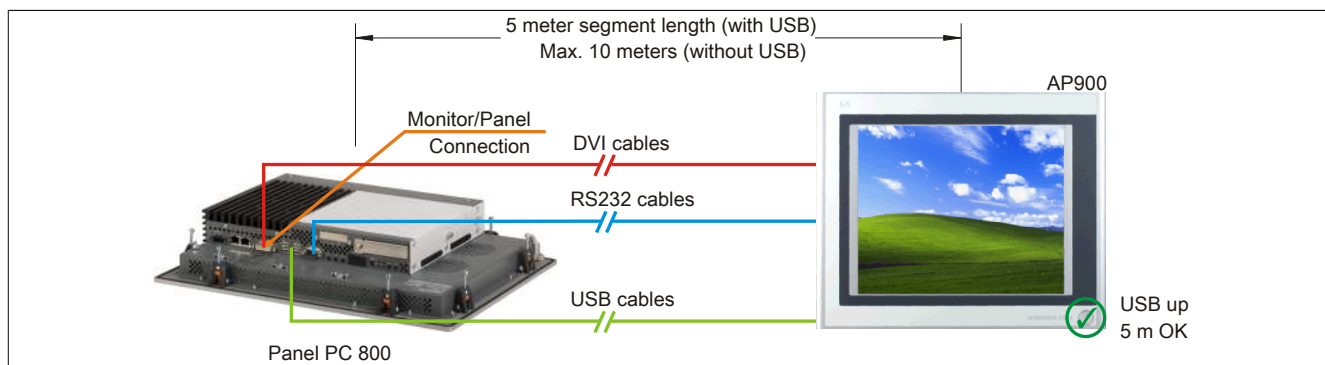

Figure 75: One Automation Panel 900 via DVI

5.2.1 Base system requirements

The following table lists the possible PPC800 system unit and CPU board combinations necessary to implement the configuration shown in the figure above. If a combination results in a limitation of the maximum resolution, this is also indicated (e.g. when connecting a non-B&R Automation Panel 900 device).

CPU board	With system unit		Limitation Resolution
	5PC820.1505-00	5PC820.1906-00	
5PC800.B945-00			Max. SXGA
5PC800.B945-10	✓	✓	Max. SXGA
5PC800.B945-01	✓	✓	Max. SXGA
5PC800.B945-11	✓	✓	Max. SXGA
5PC800.B945-02	✓	✓	Max. SXGA
5PC800.B945-12	✓	✓	Max. SXGA
5PC800.B945-03	✓	✓	Max. SXGA
5PC800.B945-13	✓	✓	Max. SXGA
5PC800.B945-04	✓	✓	Max. SXGA
5PC800.B945-14	✓	✓	Max. SXGA
5PC800.B945-05	✓	✓	Max. SXGA

Table 122: Possible system unit and CPU board combinations

5.2.2 Link modules

Information:

A corresponding Link module must be selected for each device used.

Model number	Description	Note
5DLDVI.1000-01	Automation Panel Link DVI receiver Connections for DVI-D, RS232 and USB 2.0 (Type B); 24 VDC (order screw clamp 0TB103.9 or cage clamp 0TB103.91 separately)	For Automation Panel 900

Table 123: Link modules

5.2.3 Cables

Select one Automation Panel 900 cable each from the 3 required types.

Model number	Description	Length
5CADVI.0018-00	DVI-D cable, 1.8 m	1.8 m ±50 mm
5CADVI.0050-00	DVI-D cable, 5 m	5 m ±80 mm
5CADVI.0100-00	DVI-D cable, 10 m	10 m ±100 mm
9A0014.02	RS232 extension cable for remote operation of a display unit with touch screen, 1.8 m	1.8 m ±50 mm

Table 124: Cables for DVI configurations

Model number	Description	Length
9A0014.05	RS232 extension cable for remote operation of a display unit with touch screen, 5 m	5 m ±80 mm
9A0014.10	RS232 extension cable for remote operation of a display unit with touch screen, 10 m	10 m ±100 mm
5CAUSB.0018-00	USB 2.0 connection cable Type A - Type B, 1.8 m	1.8 m ±30 mm
5CAUSB.0050-00	USB 2.0 connection cable Type A - Type B, 5 m	5 m ±50 mm

Table 124: Cables for DVI configurations

Information:

Detailed technical data about cables can be found in the Automation Panel 900 user's manual. This can be downloaded as a PDF file from the B&R website at www.br-automation.com.

5.2.4 Possible Automation Panel devices, resolutions and segment lengths

The following Automation Panel 900 devices can be used. In rare cases, segment length is limited by the resolution.

Model number	Display size	Resolution	Touch screen	Keys	Max. segment length
5AP920.1043-01	10.4"	VGA	✓	-	5 m / 10 m ¹⁾
5AP920.1214-01	12.1"	SVGA	✓	-	5 m / 10 m ¹⁾
5AP920.1505-01	15.0"	XGA	✓	-	5 m / 10 m ¹⁾
5AP920.1706-01	17.0"	SXGA	✓	-	5 m / 10 m ¹⁾
5AP920.1906-01	19.0"	SXGA	✓	-	5 m / 10 m ¹⁾

Table 125: Possible Automation Panel devices, resolutions and segment lengths

- 1) USB support is not possible on the Automation Panel 900 in these cases since USB is limited to 5 m.

Information:

When transferring data via DVI, it is not possible to read statistical values from Automation Panel 900 devices.

5.2.5 BIOS settings

No special BIOS settings are necessary for operation.

5.3 One Automation Panel 900 system via onboard SDL

An Automation Panel 900 is connected to the integrated SDL interface (onboard) via an SDL cable. USB devices can only be connected directly to the Automation Panel (i.e. without a hub).

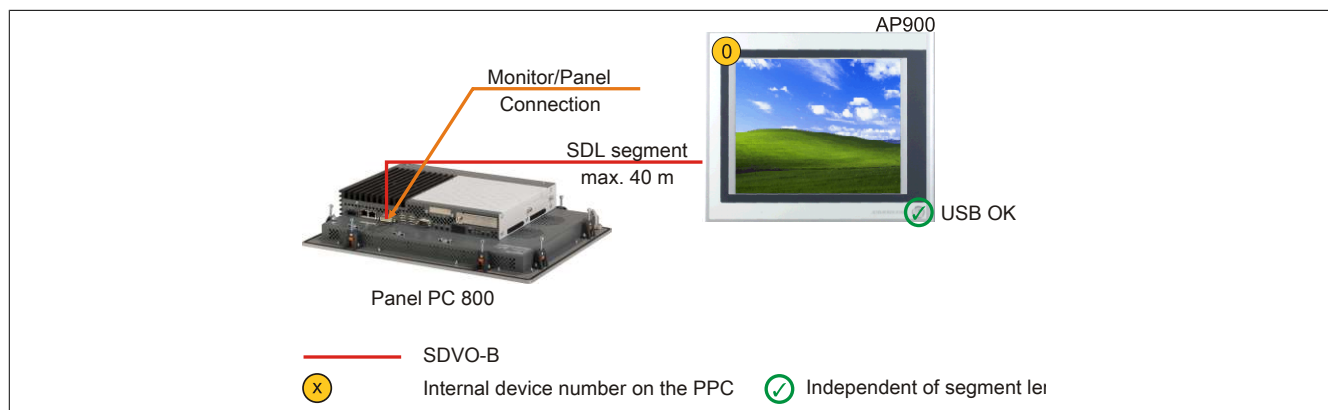

Figure 76: One Automation Panel 900 system via onboard SDL

5.3.1 Base system requirements

The following table lists the possible PPC800 system unit and CPU board combinations necessary to implement the configuration shown in the figure above. If a combination results in a limitation of the maximum resolution, this is also indicated (e.g. when connecting a non-B&R Automation Panel 800 / 900 device).

CPU board	With system unit		Limitation Resolution
	5PC820.1505-00	5PC820.1906-00	
5PC800.B945-00 5PC800.B945-10	✓	✓	Max. UXGA
5PC800.B945-01 5PC800.B945-11	✓	✓	Max. UXGA
5PC800.B945-02 5PC800.B945-12	✓	✓	Max. UXGA
5PC800.B945-03 5PC800.B945-13	✓	✓	Max. UXGA
5PC800.B945-04 5PC800.B945-14	✓	✓	Max. UXGA
5PC800.B945-05	✓	✓	Max. UXGA

Table 126: Possible system unit and CPU board combinations

5.3.2 Link modules

Information:

A corresponding Link module must be selected for each device used.

Model number	Description	Note
5DLSDL.1000-00	Automation Panel Link SDL receiver Connection for SDL In; transmission of display, touch screen, USB 1.1, matrix key and service data; 24 VDC (order screw clamp 0TB103.9 or cage clamp 0TB103.91 separately)	For Automation Panel 900

Table 127: Link modules

5.3.3 Cables

Select an Automation Panel 900 cable from the following table.

Model number	Description	Length
5CASDL.0018-00	SDL cable, 1.8 m	1.8 m ±30 mm
5CASDL.0050-00	SDL cable, 5 m	5 m ±30 mm
5CASDL.0100-00	SDL cable, 10 m	10 m ±50 mm
5CASDL.0150-00	SDL cable, 15 m	15 m ±100 mm
5CASDL.0200-00	SDL cable, 20 m	20 m ±100 mm
5CASDL.0250-00	SDL cable, 25 m	25 m ±100 mm
5CASDL.0300-00	SDL cable, 30 m	30 m ±100 mm
5CASDL.0018-03	SDL flex cable, 1.8 m	1.8 m ±20 mm
5CASDL.0050-03	SDL flex cable, 5 m	5 m ±45 mm

Table 128: Cables for SDL configurations

Model number	Description	Length
5CASDL.0100-03	SDL flex cable, 10 m	10 m ±90 mm
5CASDL.0150-03	SDL flex cable, 15 m	15 m ±135 mm
5CASDL.0200-03	SDL flex cable, 20 m	20 m ±180 mm
5CASDL.0250-03	SDL flex cable, 25 m	25 m ±225 mm
5CASDL.0300-03	SDL flex cable, 30 m	30 m ±270 mm
5CASDL.0300-13	SDL flex cable with extender, 30 m	30 m ±280 mm
5CASDL.0400-13	SDL flex cable with extender, 40 m	40 m ±380 mm
5CASDL.0430-13	SDL flex cable with extender, 43 m	43 m ±410 mm
5CASDL.0018-01	SDL cable with 45° male connector, 1.8 m	1.8 m ±30 mm
5CASDL.0050-01	SDL cable with 45° male connector, 5 m	5 m ±50 mm
5CASDL.0100-01	SDL cable with 45° male connector, 10 m	10 m ±100 mm
5CASDL.0150-01	SDL cable with 45° male connector, 15 m	15 m ±100 mm

Table 128: Cables for SDL configurations

Information:

Detailed technical data about cables can be found in the Automation Panel 900 user's manual. This can be downloaded as a PDF file from the B&R website at www.br-automation.com.

5.3.3.1 Cable lengths and resolutions for SDL transmission

The following table lists the relationship between segment lengths and maximum resolution depending on the SDL cable being used:

SDL cable Segment length [m]	Resolution						
	VGA 640 x 480	SVGA 800 x 600	XGA 1024 x 768	HD 1366 x 768	SXGA 1280 x 1024	UXGA 1600 x 1200	FHD 1920 x 1080
1.8	5CASDL.0018-00	5CASDL.0018-00	5CASDL.0018-00	5CASDL.0018-00	5CASDL.0018-00	5CASDL.0018-00	5CASDL.0018-00
	5CASDL.0018-01	5CASDL.0018-01	5CASDL.0018-01	5CASDL.0018-01	5CASDL.0018-01	5CASDL.0018-01	5CASDL.0018-01
	5CASDL.0018-03	5CASDL.0018-03	5CASDL.0018-03	5CASDL.0018-03	5CASDL.0018-03	5CASDL.0018-03	5CASDL.0018-03
5	5CASDL.0050-00	5CASDL.0050-00	5CASDL.0050-00	5CASDL.0050-00	5CASDL.0050-00	5CASDL.0050-00	5CASDL.0050-00
	5CASDL.0050-01	5CASDL.0050-01	5CASDL.0050-01	5CASDL.0050-01	5CASDL.0050-01	5CASDL.0050-01	5CASDL.0050-01
	5CASDL.0050-03	5CASDL.0050-03	5CASDL.0050-03	5CASDL.0050-03	5CASDL.0050-03	5CASDL.0050-03	5CASDL.0050-03
10	5CASDL.0100-00	5CASDL.0100-00	5CASDL.0100-00	5CASDL.0100-00	5CASDL.0100-00	5CASDL.0100-00	5CASDL.0100-00
	5CASDL.0100-01	5CASDL.0100-01	5CASDL.0100-01	5CASDL.0100-01	5CASDL.0100-01	5CASDL.0100-01	5CASDL.0100-01
	5CASDL.0100-03	5CASDL.0100-03	5CASDL.0100-03	5CASDL.0100-03	5CASDL.0100-03	5CASDL.0100-03	5CASDL.0100-03
15	5CASDL.0150-00	5CASDL.0150-00	5CASDL.0150-00	5CASDL.0150-00	5CASDL.0150-00	-	-
	5CASDL.0150-01	5CASDL.0150-01	5CASDL.0150-01	5CASDL.0150-01	5CASDL.0150-01	-	-
	5CASDL.0150-03	5CASDL.0150-03	5CASDL.0150-03	5CASDL.0150-03	5CASDL.0150-03	-	5CASDL.0150-03
20	5CASDL.0200-00	5CASDL.0200-00	5CASDL.0200-00	5CASDL.0200-00	5CASDL.0200-00	5CASDL.0200-00	5CASDL.0200-00
	5CASDL.0200-03	5CASDL.0200-03	5CASDL.0200-03	5CASDL.0200-03	5CASDL.0200-03	-	5CASDL.0200-03
	5CASDL.0250-00	5CASDL.0250-00	5CASDL.0250-00	5CASDL.0250-00	-	-	-
25	5CASDL.0250-03	5CASDL.0250-03	5CASDL.0250-03	5CASDL.0250-03	-	-	-
	5CASDL.0300-00	5CASDL.0300-00	-	-	-	-	-
	5CASDL.0300-03	5CASDL.0300-03	5CASDL.0300-03	5CASDL.0300-03	5CASDL.0300-03	-	5CASDL.0300-03
30	5CASDL.0300-00	5CASDL.0300-00	-	-	-	-	-
	5CASDL.0300-03	5CASDL.0300-03	5CASDL.0300-03	5CASDL.0300-03	5CASDL.0300-03	-	5CASDL.0300-03
40	5CASDL.0400-13	5CASDL.0400-13	5CASDL.0400-13	5CASDL.0400-13	5CASDL.0400-13	-	5CASDL.0400-13

Table 129: Cable lengths and resolutions for SDL transmission

5.3.4 Settings in BIOS

No special BIOS settings are necessary for operation.

For detailed information, see the user's manual for the B&R Industrial PC being used.

Touch screen functionality

COM C must be enabled in BIOS in order to operate the panel touch screen connected to the monitor/panel interface ("Advanced - Baseboard/Panel features - Legacy devices").

5.4 One Automation Panel 800 system via onboard SDL

An Automation Panel 800 is connected to the integrated SDL interface (onboard) via an SDL cable. USB devices can only be connected directly to the extension keyboard (without a hub).

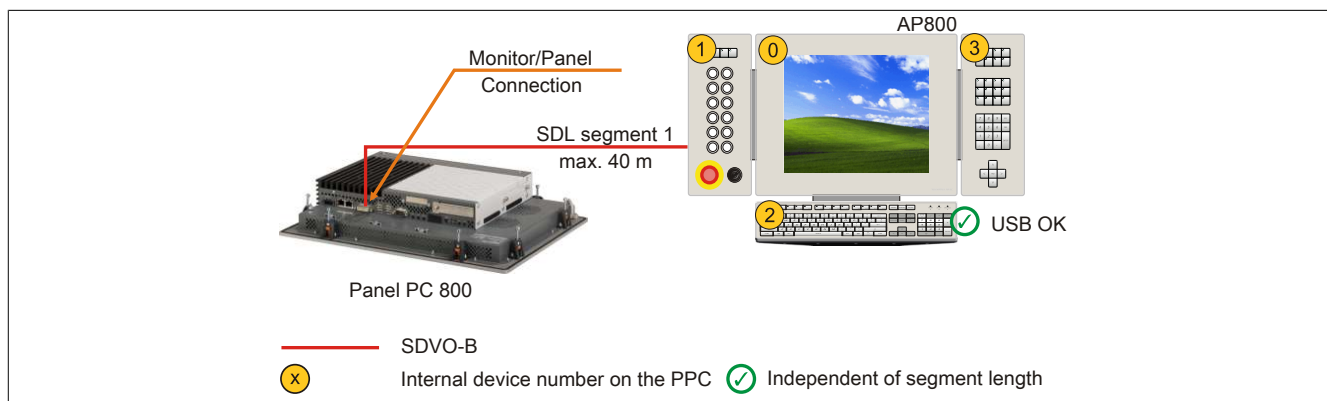

Figure 77: One Automation Panel 800 system via onboard SDL

5.4.1 Base system requirements

The following table lists the possible PPC800 system unit and CPU board combinations necessary to implement the configuration shown in the figure above. If a combination results in a limitation of the maximum resolution, this is also indicated (e.g. when connecting a non-B&R Automation Panel 800 / 900 device).

CPU board	With system unit		Limitation Resolution
	5PC820.1505-00	5PC820.1906-00	
5PC800.B945-00	✓	✓	Max. UXGA
5PC800.B945-10	✓	✓	Max. UXGA
5PC800.B945-01	✓	✓	Max. UXGA
5PC800.B945-11	✓	✓	Max. UXGA
5PC800.B945-02	✓	✓	Max. UXGA
5PC800.B945-12	✓	✓	Max. UXGA
5PC800.B945-03	✓	✓	Max. UXGA
5PC800.B945-13	✓	✓	Max. UXGA
5PC800.B945-04	✓	✓	Max. UXGA
5PC800.B945-14	✓	✓	Max. UXGA
5PC800.B945-05	✓	✓	Max. UXGA

Table 130: Possible system unit and CPU board combinations

5.4.2 Cables

Select an Automation Panel 800 SDL cable from the following table.

Model number	Description	Length
5CASDL.0018-20	SDL flex cable for the Automation Panel 800, 1.8 m	1.8 m ±20 mm
5CASDL.0050-20	SDL flex cable for the Automation Panel 800, 5 m	5 m ±45 mm
5CASDL.0100-20	SDL flex cable for the Automation Panel 800, 10 m	10 m ±90 mm
5CASDL.0150-20	SDL flex cable for the Automation Panel 800, 15 m	15 m ±135 mm
5CASDL.0200-20	SDL flex cable for the Automation Panel 800, 20 m	20 m ±180 mm
5CASDL.0250-20	SDL flex cable for the Automation Panel 800, 25 m	25 m ±230 mm
5CASDL.0300-30	SDL flex cable with extender for the Automation Panel 800, 30 m	30 m ±280 mm
5CASDL.0400-30	SDL flex cable with extender for the Automation Panel 800, 40 m	40 m ±380 mm

Table 131: Cables for SDL configurations

Information:

Detailed technical data about cables can be found in the Automation Panel 800 user's manual. This can be downloaded as a PDF file from the B&R website at www.br-automation.com.

5.4.2.1 Cable lengths and resolutions for SDL transmission

The following table lists the relationship between segment lengths and maximum resolution depending on the SDL cable being used:

Cables Segment length [m]	Resolution
	XGA 1024 x 768
1.8	5CASDL.0018-20
5	5CASDL.0050-20
10	5CASDL.0100-20
15	5CASDL.0150-20
20	5CASDL.0200-20
25	5CASDL.0250-20
30	5CASDL.0300-30
40	5CASDL.0400-30

Table 132: Cable lengths and resolutions for SDL transmission

5.4.3 Settings in BIOS

No special BIOS settings are necessary for operation.

For detailed information, see the user's manual for the B&R Industrial PC being used.

Touch screen functionality

COM C must be enabled in BIOS in order to operate the panel touch screen connected to the monitor/panel interface ("Advanced - Baseboard/Panel features - Legacy devices").

5.5 One AP900 and one AP800 via onboard SDL

An Automation Panel 900 and an Automation Panel 800 are connected to the integrated SDL interface (onboard) via SDL.

USB is supported up to a maximum distance (segment 1 + segment 2) of 30 m on the two displays. Past a distance of 30 m, USB is only available on the first display (front and back) up to 40 m. USB devices can only be connected directly to the Automation Panel 900 or extension keyboard (without a hub).

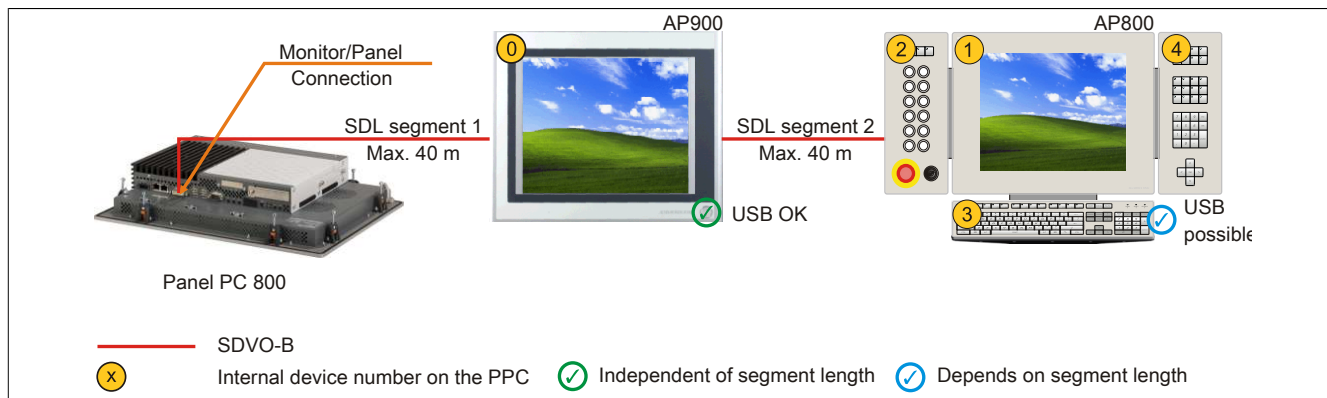

Figure 78: One AP900 and one AP800 via onboard SDL

5.5.1 Base system requirements

The following table lists the possible PPC800 system unit and CPU board combinations necessary to implement the configuration shown in the figure above. If a combination results in a limitation of the maximum resolution, this is also indicated (e.g. when connecting a non-B&R Automation Panel 800 / 900 device).

CPU board	With system unit		Limitation Resolution
	5PC820.1505-00	5PC820.1906-00	
5PC800.B945-00	✓	✓	Max. UXGA
5PC800.B945-10	✓	✓	Max. UXGA
5PC800.B945-01	✓	✓	Max. UXGA
5PC800.B945-11	✓	✓	Max. UXGA
5PC800.B945-02	✓	✓	Max. UXGA
5PC800.B945-12	✓	✓	Max. UXGA
5PC800.B945-03	✓	✓	Max. UXGA
5PC800.B945-13	✓	✓	Max. UXGA
5PC800.B945-04	✓	✓	Max. UXGA
5PC800.B945-14	✓	✓	Max. UXGA
5PC800.B945-05	✓	✓	Max. UXGA

Table 133: Possible system unit and CPU board combinations

5.5.2 Link modules

Information:

A corresponding Link module must be selected for each device used.

Model number	Description	Note
5DLSDL.1000-01	Automation Panel Link SDL transceiver Connections for SDL In and SDL Out; transmission of display, touch screen, USB 1.1, matrix key and service data; 24 VDC (order screw clamp 0TB103.9 or cage clamp 0TB103.91 separately)	For Automation Panel 900

Table 134: Link modules

5.5.3 Cables

For a selection of SDL cables for connecting the AP900 display to an AP900 display, see "Cables" on page 164.

For a selection of SDL cables for connecting the AP800 display to an AP900 display, see "Cables" on page 166.

Information:

For detailed information regarding cables, see the chapter "Accessories".

5.5.4 Settings in BIOS

No special BIOS settings are necessary for operation.

For detailed information, see the user's manual for the B&R Industrial PC being used.

Touch screen functionality

COM C must be enabled in BIOS in order to operate the panel touch screen connected to the monitor/panel interface ("Advanced - Baseboard/Panel features - Legacy devices").

5.6 Four Automation Panel 900 systems via onboard SDL

An Automation Panel 900 is connected to the integrated SDL interface (onboard) via an SDL cable. Up to three other Automation Panels of the same type are connected to this Automation Panel and operated via SDL. All four of the panels show the same content (display clone).

USB is supported up to a maximum distance (SDL segment 1 + SDL segment 2) of 30 m on the first two panels (front and back). Past a distance of 30 m, USB is only available for the first panel (front and back). USB devices can only be connected directly to the Automation Panel (i.e. without a hub).

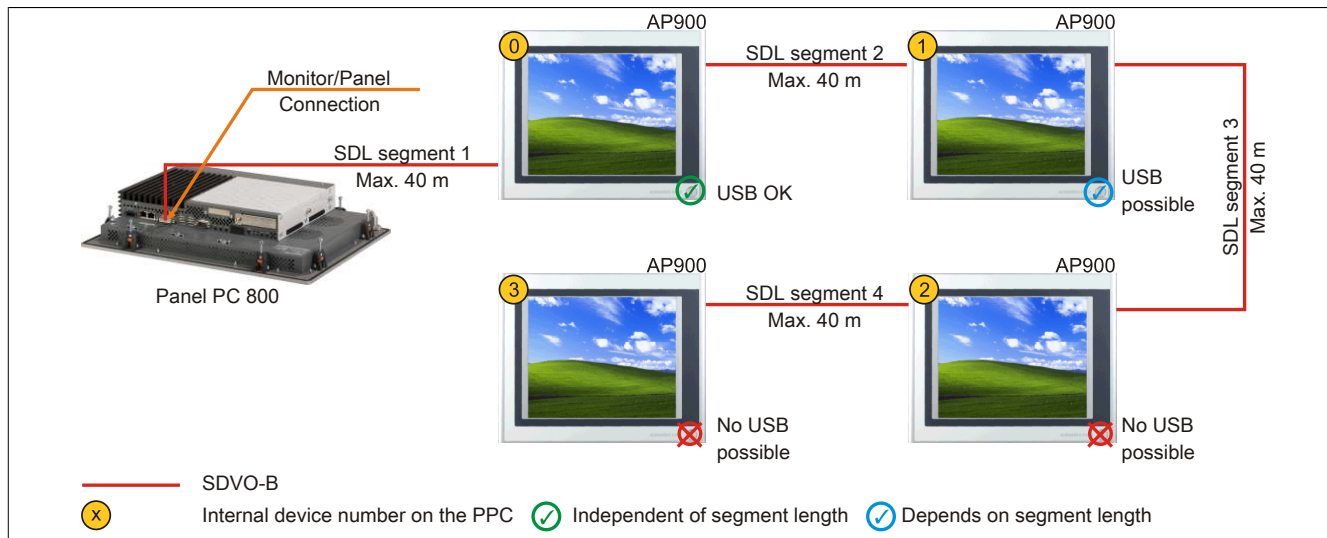

Figure 79: Four Automation Panel 900 systems via onboard SDL

5.6.1 Base system requirements

The following table lists the possible PPC800 system unit and CPU board combinations necessary to implement the configuration shown in the figure above. If a combination results in a limitation of the maximum resolution, this is also indicated (e.g. when connecting a non-B&R Automation Panel 800 / 900 device).

CPU board	With system unit		Limitation Resolution
	5PC820.1505-00	5PC820.1906-00	
5PC800.B945-00 5PC800.B945-10	✓	✓	Max. UXGA
5PC800.B945-01 5PC800.B945-11	✓	✓	Max. UXGA
5PC800.B945-02 5PC800.B945-12	✓	✓	Max. UXGA
5PC800.B945-03 5PC800.B945-13	✓	✓	Max. UXGA
5PC800.B945-04 5PC800.B945-14	✓	✓	Max. UXGA
5PC800.B945-05	✓	✓	Max. UXGA

Table 135: Possible system unit and CPU board combinations

5.6.2 Link modules

Information:

A corresponding Link module must be selected for each device used.

Model number	Description	Note
5DLSDL.1000-00	Automation Panel Link SDL receiver Connection for SDL In; transmission of display, touch screen, USB 1.1, matrix key and service data; 24 VDC (order screw clamp 0TB103.9 or cage clamp 0TB103.91 separately)	For Automation Panel 900
5DLSDL.1000-01	Automation Panel Link SDL transceiver Connections for SDL In and SDL Out; transmission of display, touch screen, USB 1.1, matrix key and service data; 24 VDC (order screw clamp 0TB103.9 or cage clamp 0TB103.91 separately)	For Automation Panel 900

Table 136: Link modules

5.6.3 Cables

Select an Automation Panel 900 cable from the following table.

Model number	Description	Length
5CASDL.0018-00	SDL cable, 1.8 m	1.8 m ±30 mm
5CASDL.0050-00	SDL cable, 5 m	5 m ±30 mm
5CASDL.0100-00	SDL cable, 10 m	10 m ±50 mm
5CASDL.0150-00	SDL cable, 15 m	15 m ±100 mm
5CASDL.0200-00	SDL cable, 20 m	20 m ±100 mm
5CASDL.0250-00	SDL cable, 25 m	25 m ±100 mm
5CASDL.0300-00	SDL cable, 30 m	30 m ±100 mm
5CASDL.0018-03	SDL flex cable, 1.8 m	1.8 m ±20 mm
5CASDL.0050-03	SDL flex cable, 5 m	5 m ±45 mm
5CASDL.0100-03	SDL flex cable, 10 m	10 m ±90 mm
5CASDL.0150-03	SDL flex cable, 15 m	15 m ±135 mm
5CASDL.0200-03	SDL flex cable, 20 m	20 m ±180 mm
5CASDL.0250-03	SDL flex cable, 25 m	25 m ±225 mm
5CASDL.0300-03	SDL flex cable, 30 m	30 m ±270 mm
5CASDL.0300-13	SDL flex cable with extender, 30 m	30 m ±280 mm
5CASDL.0400-13	SDL flex cable with extender, 40 m	40 m ±380 mm
5CASDL.0430-13	SDL flex cable with extender, 43 m	43 m ±410 mm
5CASDL.0018-01	SDL cable with 45° male connector, 1.8 m	1.8 m ±30 mm
5CASDL.0050-01	SDL cable with 45° male connector, 5 m	5 m ±50 mm
5CASDL.0100-01	SDL cable with 45° male connector, 10 m	10 m ±100 mm
5CASDL.0150-01	SDL cable with 45° male connector, 15 m	15 m ±100 mm

Table 137: Cables for SDL configurations

Information:

Detailed technical data about cables can be found in the Automation Panel 900 user's manual. This can be downloaded as a PDF file from the B&R website at www.br-automation.com.

5.6.3.1 Cable lengths and resolutions for SDL transmission

The following table lists the relationship between segment lengths and maximum resolution depending on the SDL cable being used:

SDL cable Segment length [m]	Resolution						
	VGA 640 x 480	SVGA 800 x 600	XGA 1024 x 768	HD 1366 x 768	SXGA 1280 x 1024	UXGA 1600 x 1200	FHD 1920 x 1080
1.8	5CASDL.0018-00	5CASDL.0018-00	5CASDL.0018-00	5CASDL.0018-00	5CASDL.0018-00	5CASDL.0018-00	5CASDL.0018-00
	5CASDL.0018-01	5CASDL.0018-01	5CASDL.0018-01	5CASDL.0018-01	5CASDL.0018-01	5CASDL.0018-01	5CASDL.0018-01
	5CASDL.0018-03	5CASDL.0018-03	5CASDL.0018-03	5CASDL.0018-03	5CASDL.0018-03	5CASDL.0018-03	5CASDL.0018-03
5	5CASDL.0050-00	5CASDL.0050-00	5CASDL.0050-00	5CASDL.0050-00	5CASDL.0050-00	5CASDL.0050-00	5CASDL.0050-00
	5CASDL.0050-01	5CASDL.0050-01	5CASDL.0050-01	5CASDL.0050-01	5CASDL.0050-01	5CASDL.0050-01	5CASDL.0050-01
	5CASDL.0050-03	5CASDL.0050-03	5CASDL.0050-03	5CASDL.0050-03	5CASDL.0050-03	5CASDL.0050-03	5CASDL.0050-03
10	5CASDL.0100-00	5CASDL.0100-00	5CASDL.0100-00	5CASDL.0100-00	5CASDL.0100-00	5CASDL.0100-00	5CASDL.0100-00
	5CASDL.0100-01	5CASDL.0100-01	5CASDL.0100-01	5CASDL.0100-01	5CASDL.0100-01	5CASDL.0100-01	5CASDL.0100-01
	5CASDL.0100-03	5CASDL.0100-03	5CASDL.0100-03	5CASDL.0100-03	5CASDL.0100-03	5CASDL.0100-03	5CASDL.0100-03
15	5CASDL.0150-00	5CASDL.0150-00	5CASDL.0150-00	5CASDL.0150-00	5CASDL.0150-00	-	-
	5CASDL.0150-01	5CASDL.0150-01	5CASDL.0150-01	5CASDL.0150-01	5CASDL.0150-01	-	-
	5CASDL.0150-03	5CASDL.0150-03	5CASDL.0150-03	5CASDL.0150-03	5CASDL.0150-03	-	5CASDL.0150-03
20	5CASDL.0200-00	5CASDL.0200-00	5CASDL.0200-00	5CASDL.0200-00	5CASDL.0200-00	-	-
	5CASDL.0200-03	5CASDL.0200-03	5CASDL.0200-03	5CASDL.0200-03	5CASDL.0200-03	-	5CASDL.0200-03
25	5CASDL.0250-00	5CASDL.0250-00	5CASDL.0250-00	5CASDL.0250-00	-	-	-
	5CASDL.0250-03	5CASDL.0250-03	5CASDL.0250-03	5CASDL.0250-03	-	-	-
30	5CASDL.0300-00	5CASDL.0300-00	-	-	-	-	-
	5CASDL.0300-03	5CASDL.0300-03	5CASDL.0300-13	5CASDL.0300-13	5CASDL.0300-13	-	5CASDL.0300-13
40	5CASDL.0400-13	5CASDL.0400-13	5CASDL.0400-13	5CASDL.0400-13	5CASDL.0400-13	-	5CASDL.0400-13

Table 138: Cable lengths and resolutions for SDL transmission

5.6.4 Settings in BIOS

No special BIOS settings are necessary for operation.

For detailed information, see the user's manual for the B&R Industrial PC being used.

Touch screen functionality

COM C must be enabled in BIOS in order to operate the panel touch screen connected to the monitor/panel interface ("Advanced - Baseboard/Panel features - Legacy devices").

6 Touch screen calibration

B&R touch screen devices are equipped with a touch controller that supports hardware calibration. As a result, devices are pre-calibrated when delivered. This is an advantageous feature when replacing devices of the same model or type since it avoids having to recalibrate the new device. Nevertheless, calibrating the device is still recommended in order to achieve the best results and to better adapt the touch screen to the user's preferences.

Regardless of this, the touch screen will have to be calibrated once during or following the installation of the touch screen driver.

6.1 Windows XP Professional

After installing Windows XP Professional on the device, the touch screen driver must be installed in order to operate the touch screen. The necessary driver is available in the Downloads section of the B&R website (www.br-automation.com).

6.2 Windows XP Embedded

After starting Windows XP Embedded on the device for the first time (first boot agent), the touch screen driver must be installed in order to operate the touch screen. The necessary driver is available in the Downloads section of the B&R website www.br-automation.com.

6.3 Windows Embedded Standard 2009

After starting Windows Embedded Standard 2009 on the Panel PC or Power Panel for the first time (first boot agent), the corresponding touch screen driver is installed automatically.

On all other devices, the touch screen driver must be installed in order to operate the touch screen. The necessary driver is available in the Downloads section of the B&R website (www.br-automation.com).

6.4 Windows 7 Professional / Ultimate

After installing Windows 7 on the device, the touch screen driver must be installed in order to operate the touch screen. The necessary driver is available in the Downloads section of the B&R website (www.br-automation.com).

6.5 Windows Embedded Standard 7 Embedded / Premium

A touch screen driver will be installed automatically if a touch controller is detected during the Windows Embedded Standard 7 installation.

The touch screen driver must be installed manually if a touch controller was not detected during the Windows Embedded Standard 7 setup or if an Automation Panel 800/900/9x3/9xD has been connected after setup. The necessary driver is available in the Downloads section of the B&R website (www.br-automation.com).

6.6 Windows CE

Windows CE starts the touch screen calibration sequence during its first boot in its default configuration (i.e. delivered state).

6.7 Automation Runtime / Visual Components

The touch screen must be calibrated once for the customer application when commissioning the device and project.

7 Connecting peripheral USB devices

Warning!

Peripheral USB devices can be connected to the USB interfaces on this device. Due to the vast number of USB devices available on the market, B&R cannot guarantee their performance. USB devices from B&R are guaranteed to function properly, however.

7.1 Locally on the PPC800

Many different peripheral USB devices can be connected to the 5 USB interfaces on the Panel PC 800. These can each handle a load of up to 1 A. The maximum transfer rate is USB 2.0.

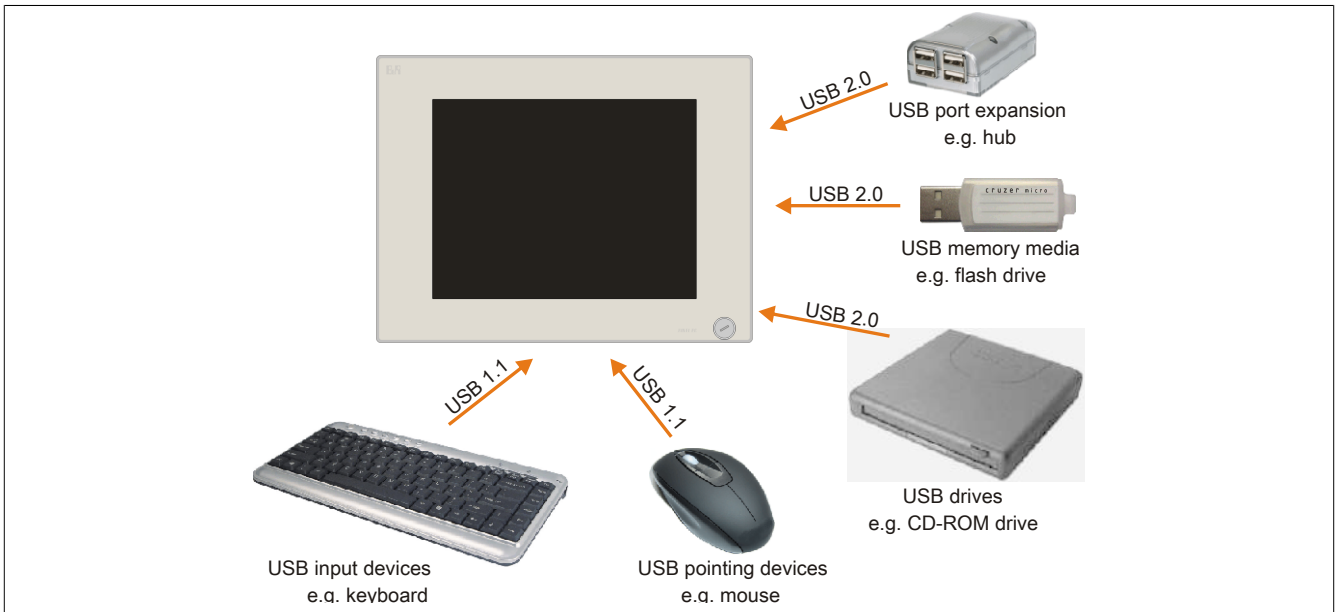

Figure 80: Local connection of USB peripheral devices on the PPC800

7.2 Remote connection to Automation Panel 900 via DVI

Many different peripheral USB devices can be connected to the 2 or 3 USB interfaces on the Automation Panel 900. These can each handle a load of 500 mA. The maximum transfer rate is USB 2.0.

Information:

Only end devices (not hubs) can be connected to the Automation Panel 900.

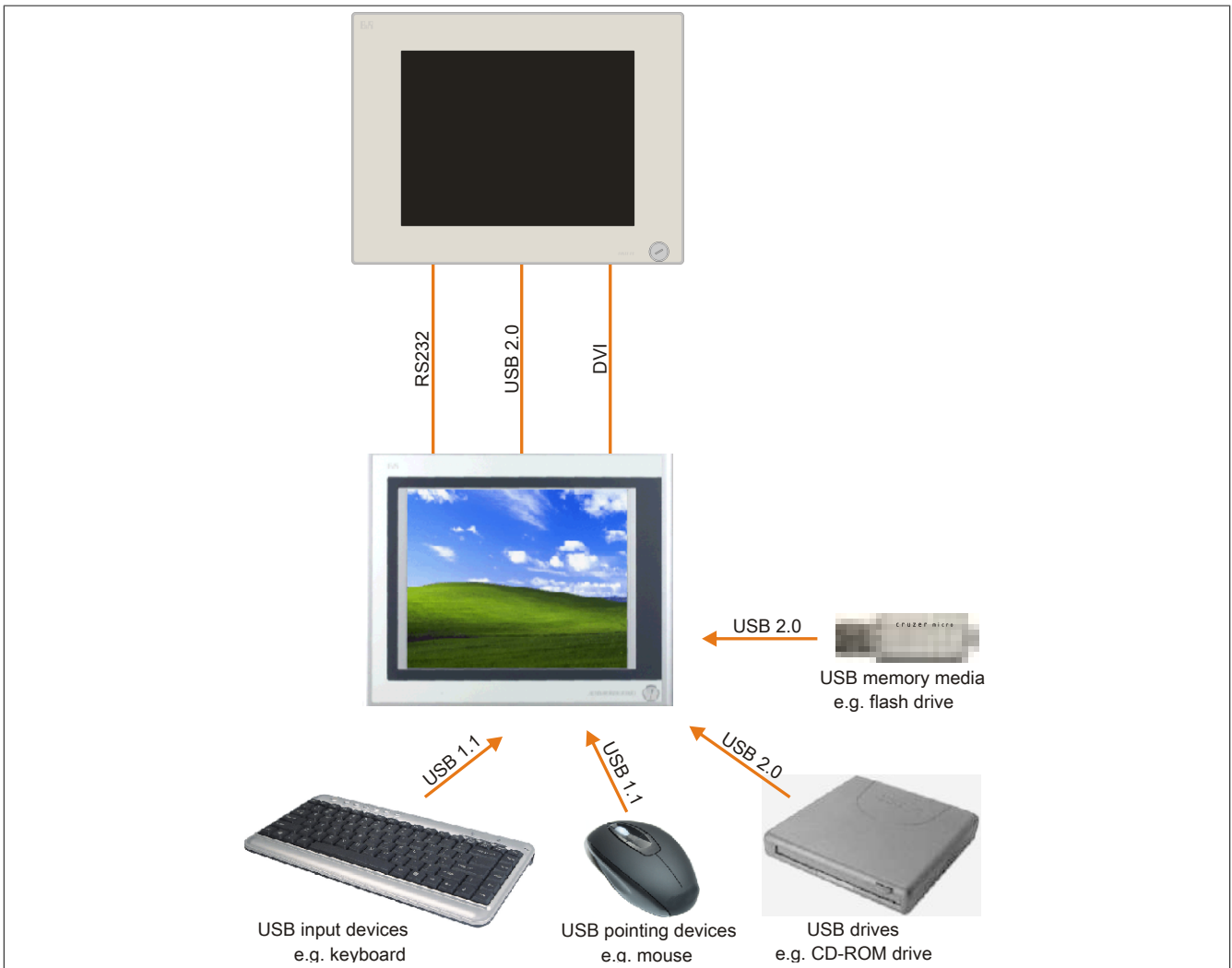

Figure 81: Remote connection of USB peripheral devices on the APC900 via DVI

7.3 Remote connection to Automation Panel 800 / 900 via SDL

Many different peripheral USB devices can be connected to the 2 or 3 USB interfaces on Automation Panel 900 or the USB interfaces on Automation Panel 800 devices. These can each handle a load of 500 mA. The maximum transfer rate is USB 1.1.

Information:

Only end devices (no hubs) can be connected to the Automation Panel 800 / 900.

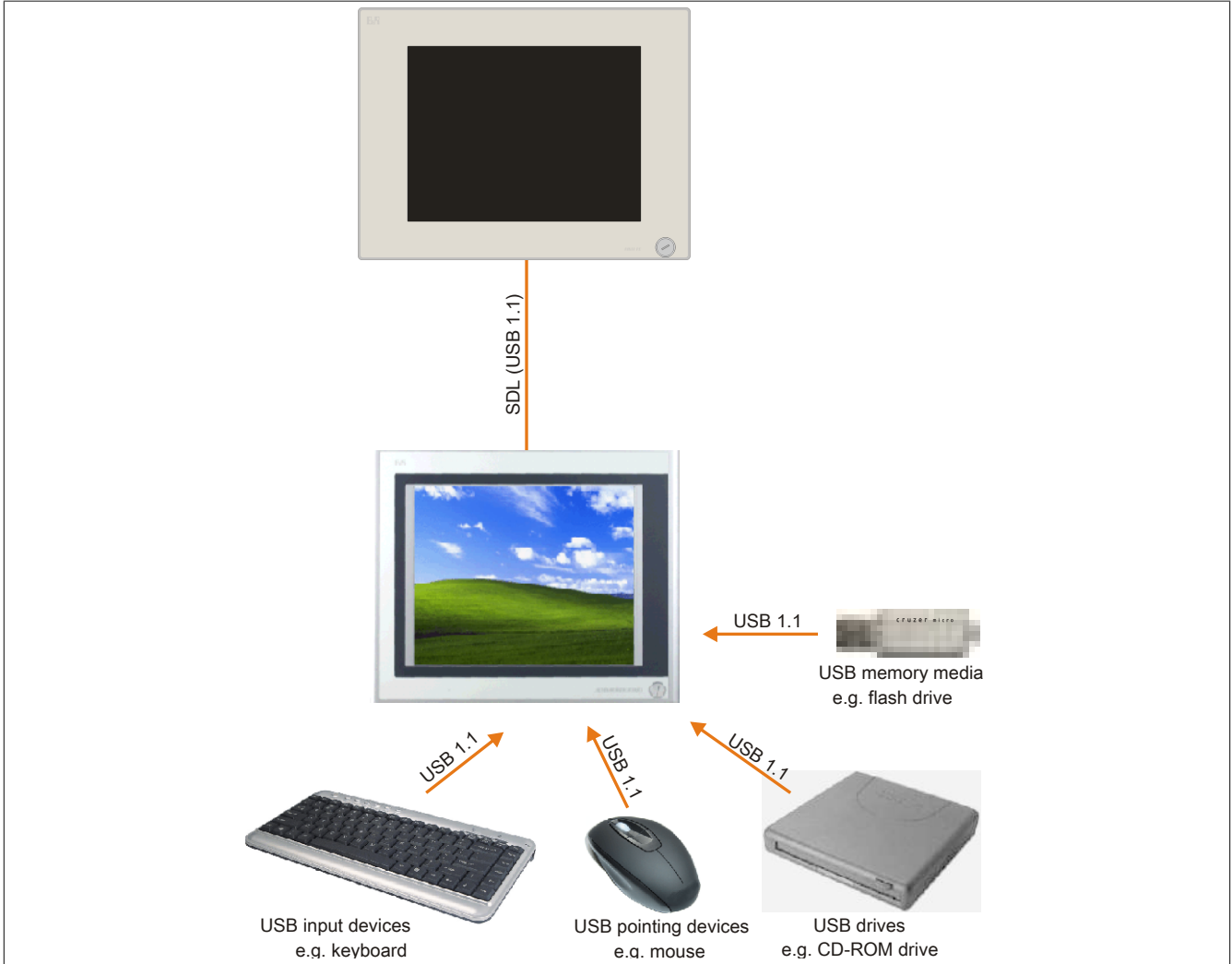

Figure 82: Remote connection of USB peripheral devices on the APC800/900 via SDL

8 Configuring a SATA RAID set

Information:

The following software description is valid for PCI SATA controllers 5ACPCI.RAIC-01, 5ACPCI.RAIC-03, 5ACPCI.RAIC-05 and 5ACPCI.RAIC-06.

The "RAID Configuration Utility" in BIOS must be started in order to make the necessary settings. After POST, pressing <Ctrl+S> or <F4> opens the RAID BIOS.

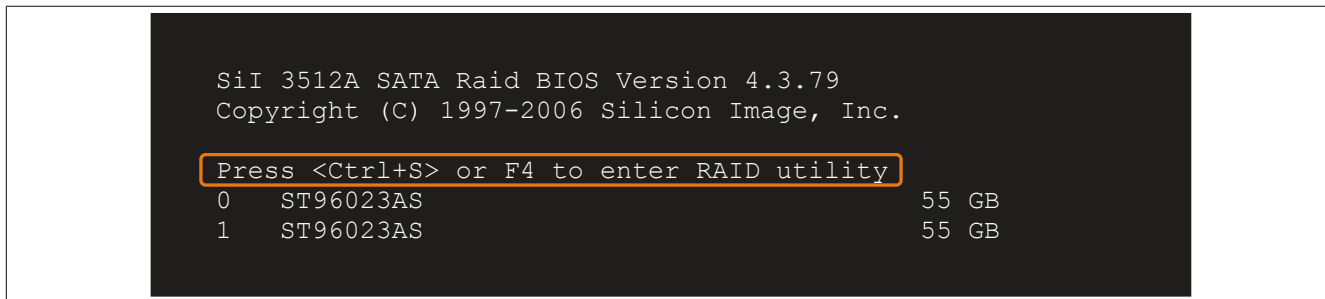

Figure 83: Open the RAID Configuration Utility

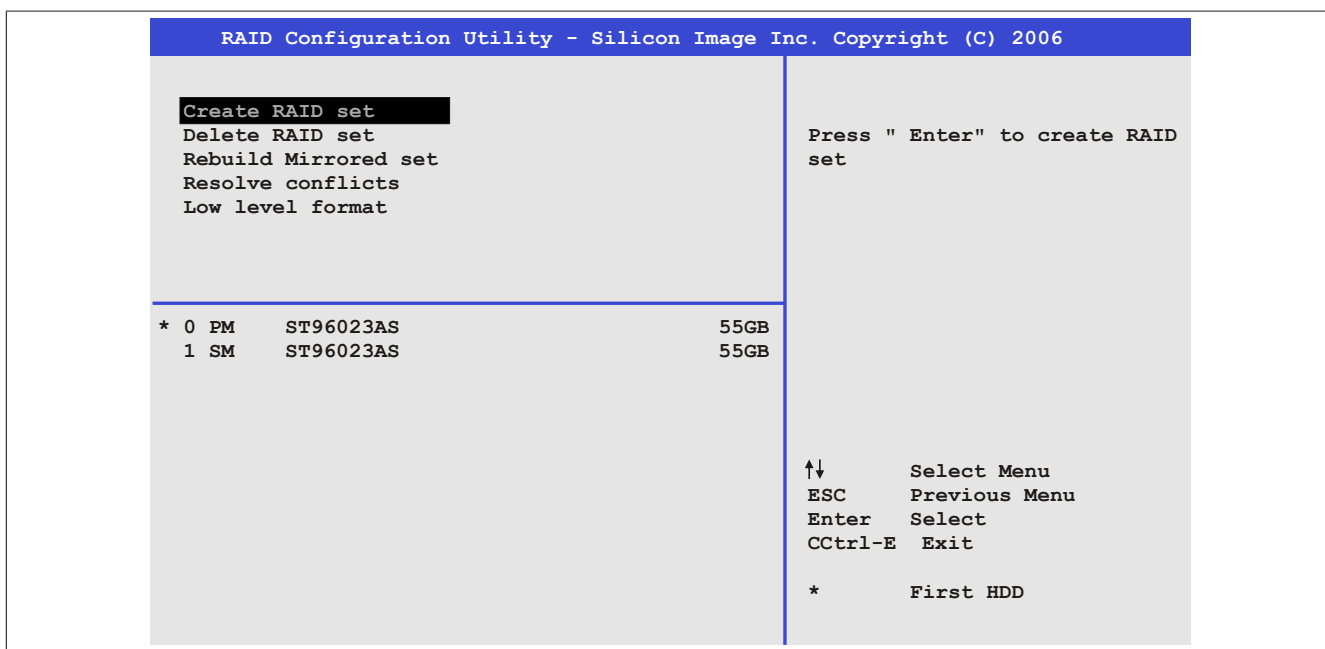

Figure 84: RAID Configuration Utility - Menu

The following keys can be used once inside BIOS Setup:

Key	Function
Cursor ↑	Moves to the previous item
Cursor ↓	Moves to the next item
Enter	Selects an item or opens a submenu
ESC	Returns to the previous menu
Ctrl+E	Saves any changed settings and exits setup

Table 139: BIOS-relevant keys in the RAID Configuration Utility

8.1 Create RAID set

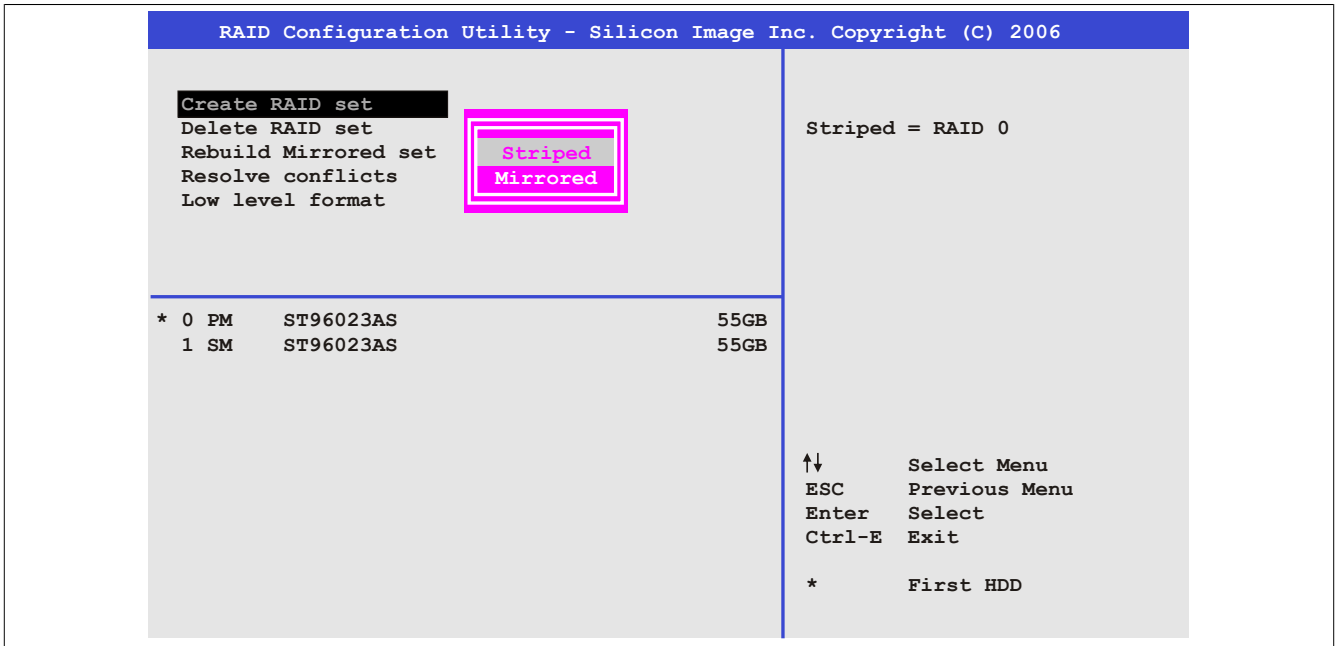

Figure 85: RAID Configuration Utility - Menu

The RAID system can be set up as "Striped" = RAID0 or "Mirrored" = RAID1 using the "Create RAID set" menu option.

8.2 Create RAID set - Striped

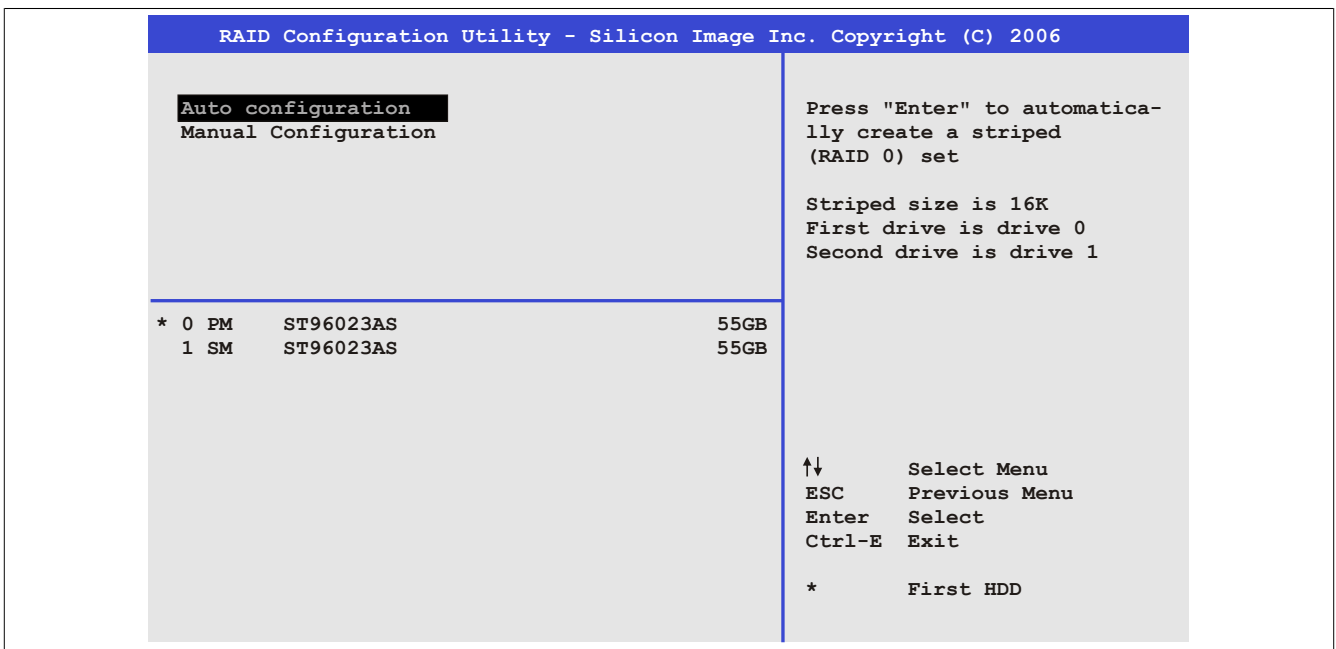

Figure 86: RAID Configuration Utility - Create RAID set - Striped

"Auto configuration"

Auto configuration optimizes all settings.

"Manual configuration"

Allows the first and second HDD to be specified as well as the "Chunk size" (= block size, application-dependent).

8.3 Create RAID set - Mirrored

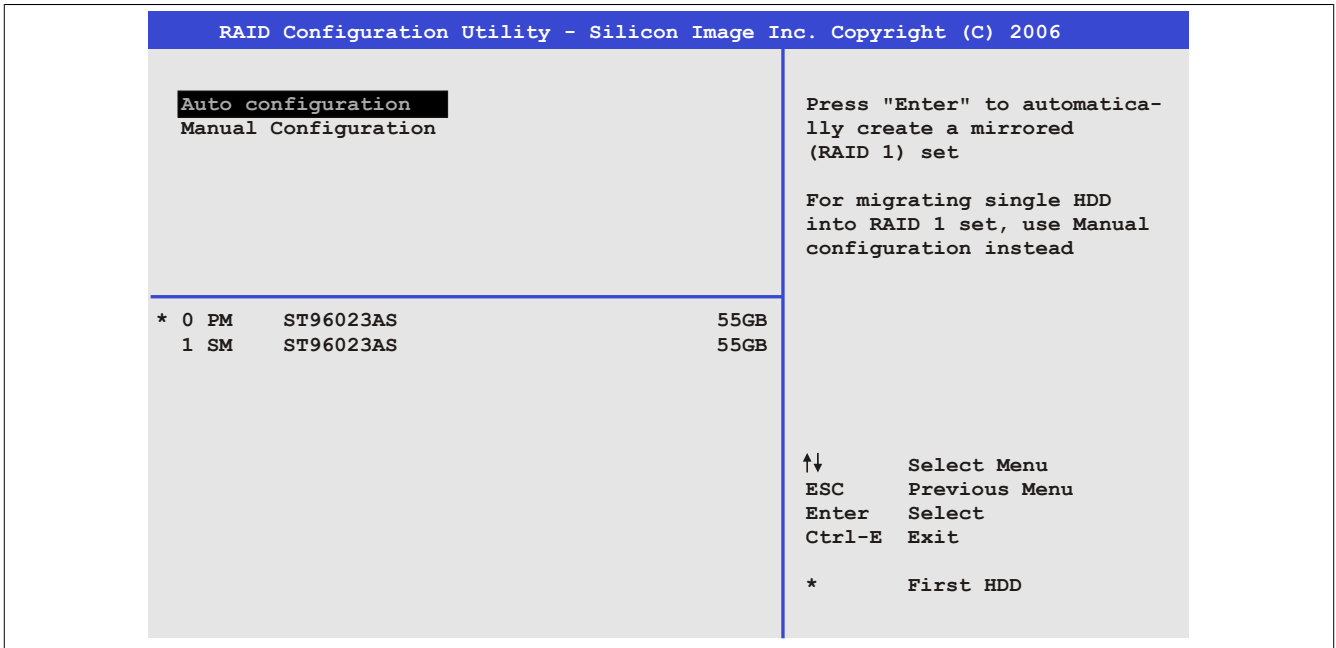

Figure 87: RAID Configuration Utility - Create RAID set - Mirrored

"Auto configuration"

Auto configuration optimizes all settings.

"Manual configuration"

Allows the "Source" and "Target" HDD to be specified as well as whether a rebuild (mirror) should be performed immediately (takes approx. 50 minutes).

8.4 Delete RAID set

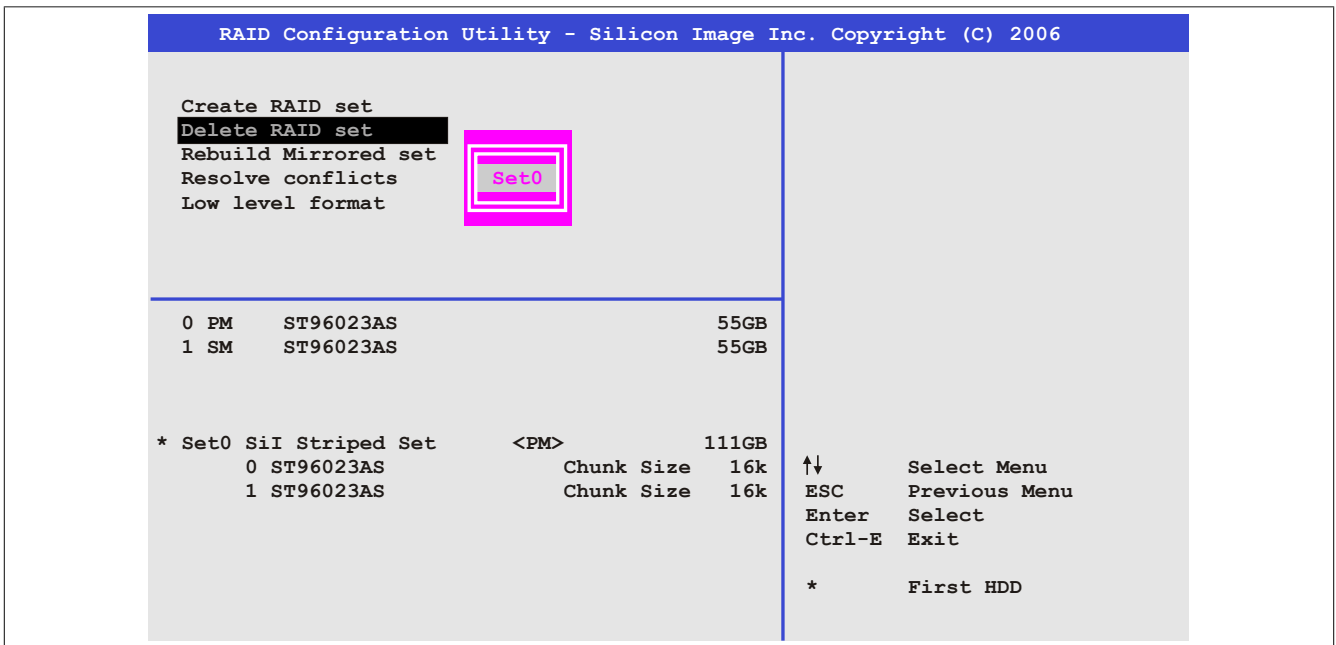

Figure 88: RAID Configuration Utility - Delete RAID set

An existing RAID set can be deleted using the "Delete RAID set" menu option.

8.5 Rebuild mirrored set

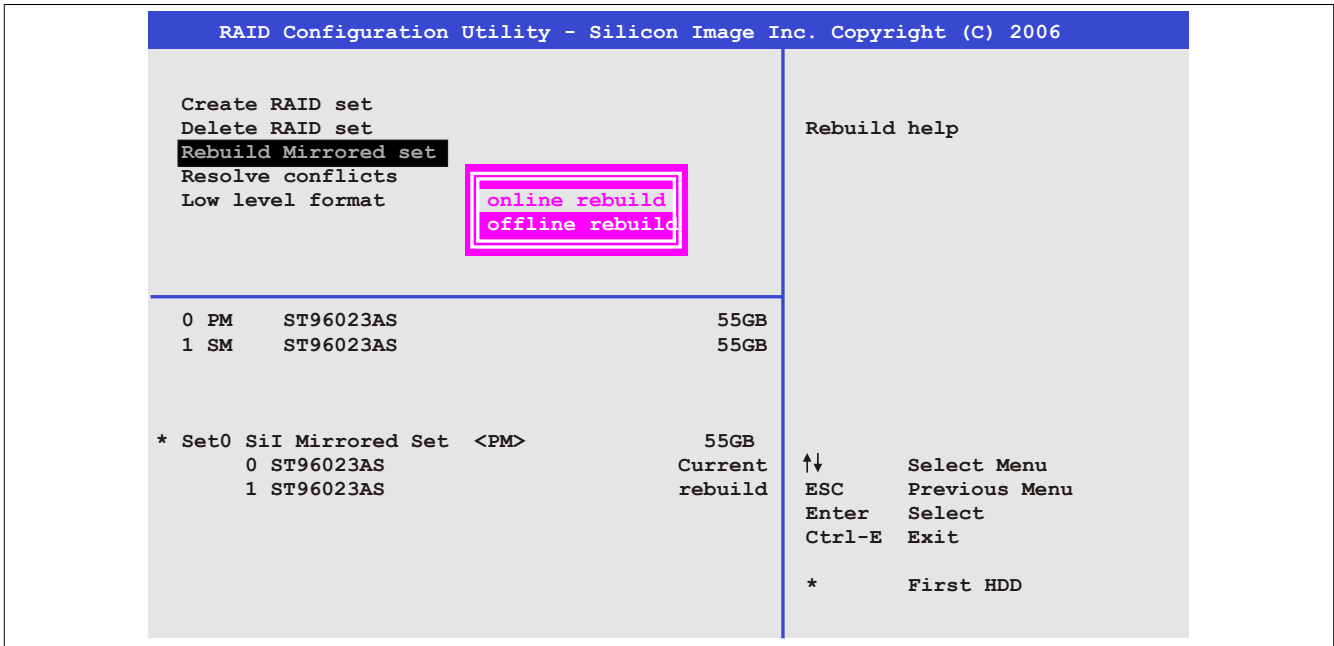

Figure 89: RAID Configuration Utility - Rebuild mirrored set

The "Rebuild mirrored set" menu option can be used to restart a rebuild procedure in a RAID 1 set if an error occurs, if a rebuild procedure was interrupted or if a hard disk was replaced.

If "Online rebuild" is selected, then the rebuild is executed during operation after the system is booted. The installed SATA RAID configuration program may display an event pop-up message: SATA Raid detected a new event before restarting the rebuild. The entire rebuild takes approximately 50 minutes.

If "Offline rebuild" is selected, then a rebuild is performed immediately before the operating system is started (duration depends on the respective memory size).

8.6 Resolve conflicts

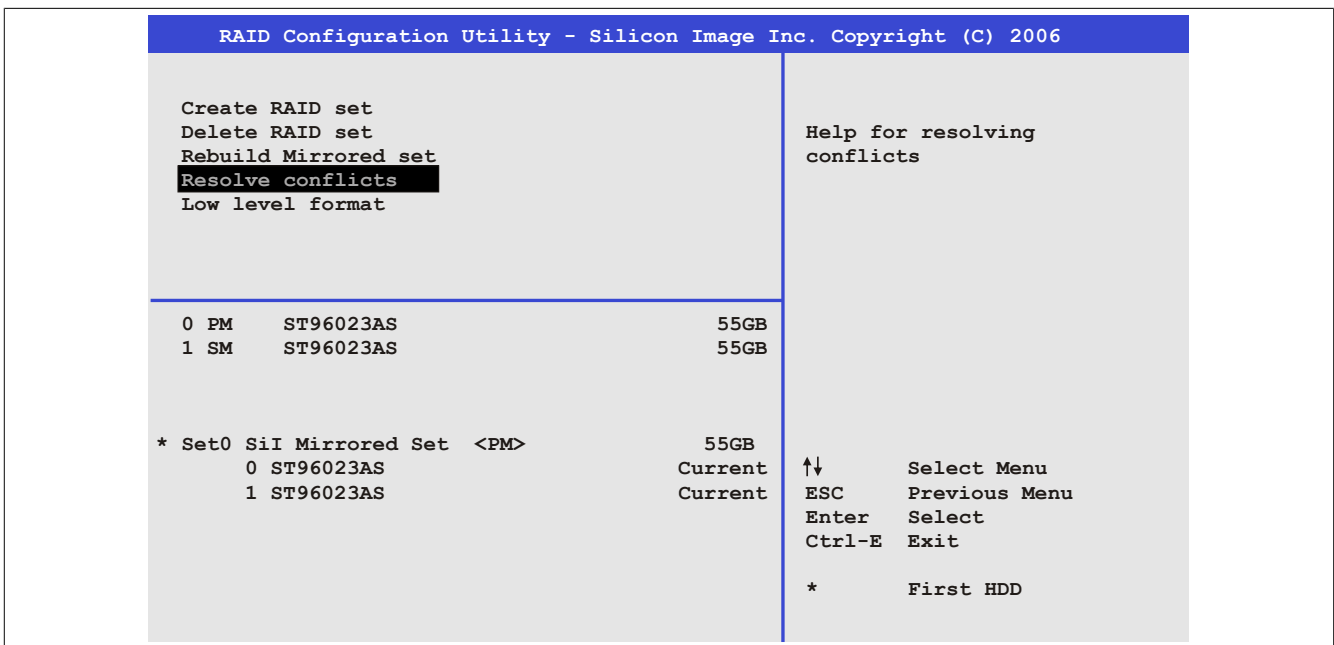

Figure 90: RAID Configuration Utility - Resolve conflicts

Conflicts in a RAID set can be resolved using the "Resolve conflicts" menu option. This function is only available if the status of the hard disk is "Conflict".

8.7 Low level format

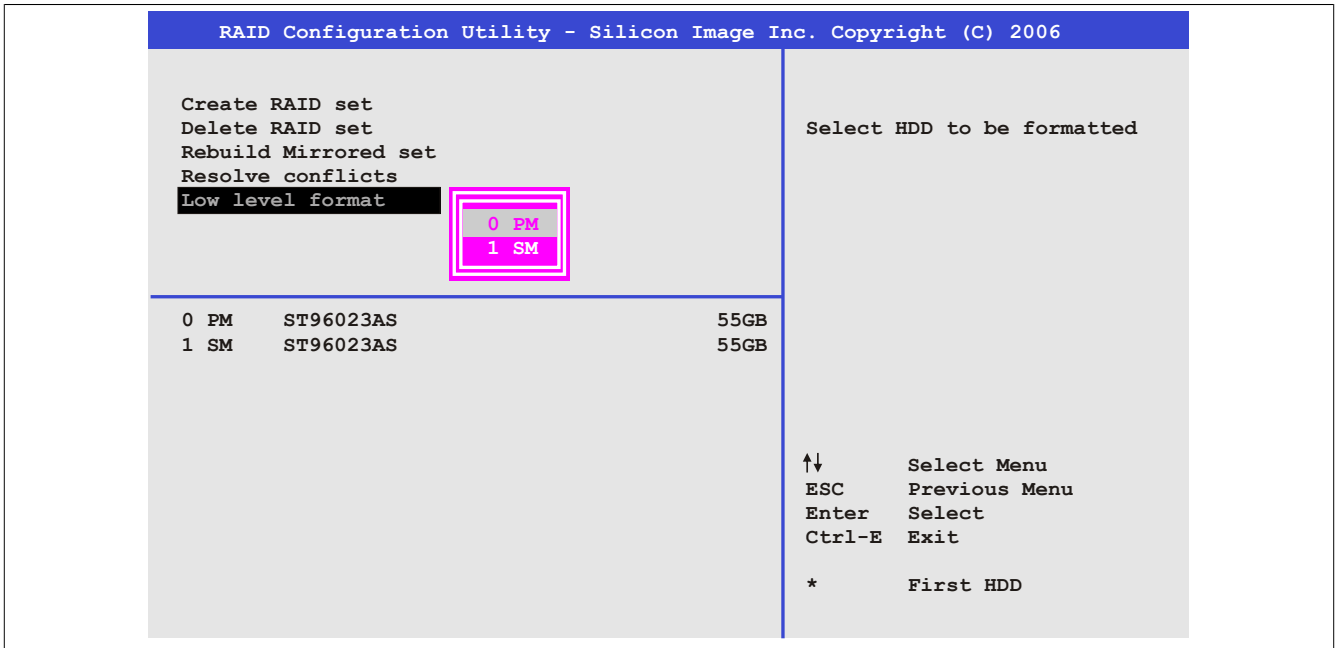

Figure 91: RAID Configuration Utility - Low level format

Individual hard disks can be configured using the "Low level format" menu option. This can only be done if a RAID set is not configured. A low level format of a hard disk takes approx. 40 minutes.

9 Tips for extending the service life of the display

9.1 Backlight

The service life of the backlight is specified by its "half-brightness time". For example, a specified operating time of 50,000 hours means that the display would still retain 50% of its brightness after this time.

9.1.1 How can the service life of the backlight be extended?

- By setting the display brightness to the lowest value that is still comfortable for the eyes
- By using dark images
- By reducing the brightness by 50%, which can result in an approximately 50% increase in the half-brightness time

9.2 Screen burn-in

Screen burn-in refers to the "burning in" of a static image on a display after being displayed for a prolonged period of time. Nevertheless, static images are not the only cause of screen burn-in. Screen burn-in is also referred to as burn-in effect, image retention, memory effect, memory sticking or ghost image.

There are basically two types:

- Area type: This type of screen burn-in is indicated by a dark gray image. The effect will disappear if the display is switched off for a long period of time.
- Line type: This type of screen burn-in can cause lasting damage.

9.2.1 What causes screen burn-in?

- Static images
- No screensaver
- Sharp transitions in contrast (e.g. black/white)
- High ambient temperatures
- Operation outside of specifications

9.2.2 How can screen burn-in be avoided?

- By constantly changing between static and dynamic images
- By avoiding excessive brightness differences between foreground and background elements
- By using colors with similar brightness
- By using complementary colors in follow-up images
- By using a screensaver

10 Pixel errors

Information:

Displays may contain defective pixels (dead/stuck pixels) that result from the manufacturing process. These flaws are not grounds for reclamation or initiating a warranty claim.

11 Known problems/issues

The following issues for the PPC800 devices are known:

- Using two different types of CompactFlash cards can cause problems with Automation PCs and Panel PCs. For example, it is possible that one of the two cards is not detected during system startup. This is caused by different startup speeds. CompactFlash cards with older technology require significantly more time during system startup than CompactFlash cards with newer technology. This behavior occurs near the end of the time frame provided for startup. The problem described can occur because the startup time for the CompactFlash cards fluctuates due to the different components being used. Depending on the CompactFlash cards being used, this error may occur never, sometimes or always.
- During daisy chain operation of multiple AP800/AP900 devices via SDL, it is possible that the touch controller status shows a red "X" in the Control Center applet for the touch screen driver when the touch controller is detected. The functionality of the touch system is not affected by this. This can be avoided by setting a panel locking time of 50 ms. The panel locking time can be configured with the B&R Key Editor.
- HD resolution (1366x768) is not completely supported by VBIOS, which causes display errors after POST. The image flickers and is shifted down a line. BIOS POST and BIOS Setup are still displayed correctly, however. This effect occurs when using operating systems for which no driver is available (e.g. MS-DOS) or before the operating system's graphics driver is started (e.g. Windows XP boot logo). HD resolution is displayed corrected again when Windows XP or Windows 7 is booted properly with an installed graphics driver.

Chapter 4 • Software

1 BIOS options

Information:

The following diagrams, BIOS menu items and their descriptions refer to BIOS version 1.18. It is therefore possible that these diagrams and BIOS descriptions will not correspond with the BIOS version actually installed.

1.1 General information

BIOS is an acronym for "Basic Input/Output System". It is the most basic standardized interface between the user and the system (hardware). The BIOS system used in this B&R Industrial PC was developed by American Megatrends Inc.

The BIOS Setup utility can be used to modify basic system configuration settings. These settings are stored in CMOS and EEPROM memory (as a backup).

CMOS data is buffered by a battery (if present) and remains stored on the B&R Industrial PC even when the power is turned off (no 24 VDC supply).

1.2 BIOS Setup and boot procedure

BIOS is activated immediately when switching on the power supply or pressing the power button on the B&R Industrial PC. The system checks if the setup data from EEPROM memory is "OK". If the data is "OK", then it is transferred to CMOS. If the data is "Not OK", then the CMOS data is checked to see whether it is valid. An error message is output if the CMOS data contains errors, and the boot procedure can be continued by pressing <F1>. To prevent an error message from appearing on each restart, the BIOS Setup utility can be opened by pressing . The settings can then be re-saved.

BIOS reads the system configuration information, checks and configures the system with the Power-On Self-Test (POST).

When these "preliminaries" are finished, BIOS looks for an operating system on the available data storage devices (hard drive, floppy drive, etc.). BIOS then launches the operating system and hands over to it the control of system operations.

To enter BIOS Setup, press the key after the USB controller has been initialized as soon as the following message appears on the screen (during POST): "Press DEL to run SETUP".

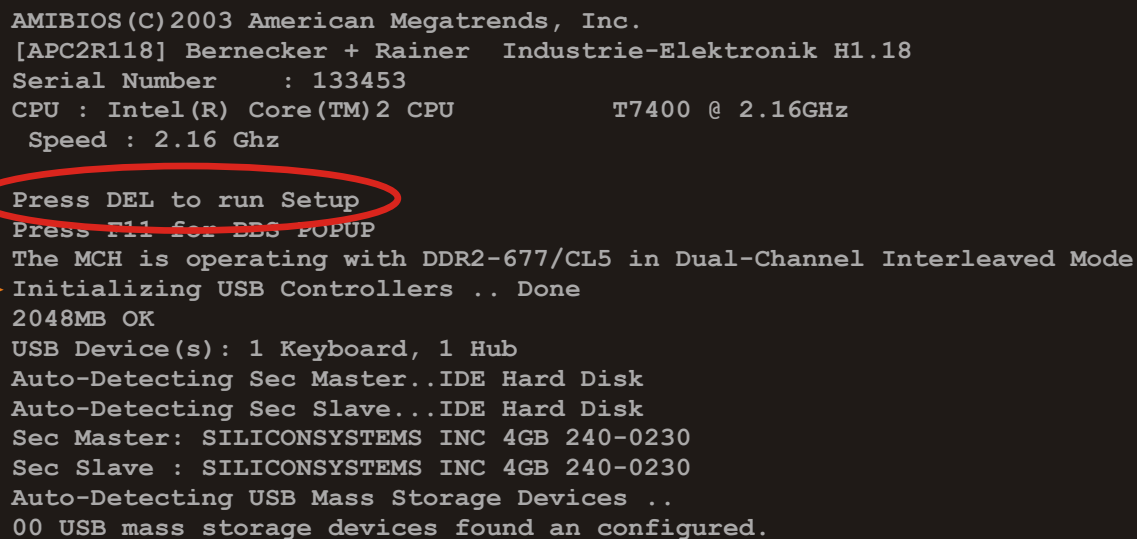
The image shows a BIOS boot screen with white text on a black background. The text includes system information such as the BIOS version, serial number, and CPU details. Two lines of text are circled in red: "Press DEL to run Setup" and "Press F11 for BIOS POPUP". An orange arrow points to the line "Initializing USB Controllers .. Done".

```
AMIBIOS (C) 2003 American Megatrends, Inc.  
[APC2R118] Bernecker + Rainer Industrie-Elektronik H1.18  
Serial Number      : 133453  
CPU : Intel(R) Core(TM)2 CPU           T7400 @ 2.16GHz  
Speed : 2.16 Ghz  
  
Press DEL to run Setup  
Press F11 for BIOS POPUP  
The MCH is operating with DDR2-677/CL5 in Dual-Channel Interleaved Mode  
Initializing USB Controllers .. Done  
2048MB OK  
USB Device(s): 1 Keyboard, 1 Hub  
Auto-Detecting Sec Master..IDE Hard Disk  
Auto-Detecting Sec Slave...IDE Hard Disk  
Sec Master: SILICONSYSTEMS INC 4GB 240-0230  
Sec Slave : SILICONSYSTEMS INC 4GB 240-0230  
Auto-Detecting USB Mass Storage Devices ..  
00 USB mass storage devices found an configured.
```

Figure 92: Boot Screen

1.2.1 BIOS Setup keys

The following keys are enabled during POST:

Information:

Key signals from USB keyboards will only be registered after the USB controller has been initialized.

Keys	Function
Del	Opens the main BIOS Setup screen
F12	Network boot
F11	Opens the boot menu. This lists all bootable devices that are connected to the system. Selecting a device with cursor ↑, cursor ↓ and the pressing <ENTER> will boot from that device.
	
<Pause>	Pauses POST. Pressing any other key resumes POST.

Table 140: BIOS-relevant keys for POST

The following keys can be used once inside BIOS Setup:

Key	Function
F1	Opens general help information
Cursor ↑	Moves to the previous item
Cursor ↓	Moves to the next item
Cursor ←	Moves to the previous item
Cursor →	Moves to the next item
+/-	Changes the setting for the selected function
Enter	Changes to the selected screen
Page ↑	Changes to the previous page
Page ↓	Changes to the next page
Pos 1	Jumps to the first BIOS menu item or object
End	Jumps to the last BIOS menu item or object
F2 / F3	Changes the colors of BIOS Setup
F7	Resets any changes
F9	Loads and configures CMOS default values for all BIOS settings
F10	Saves and exits
ESC	Exits a submenu

Table 141: BIOS-relevant keys

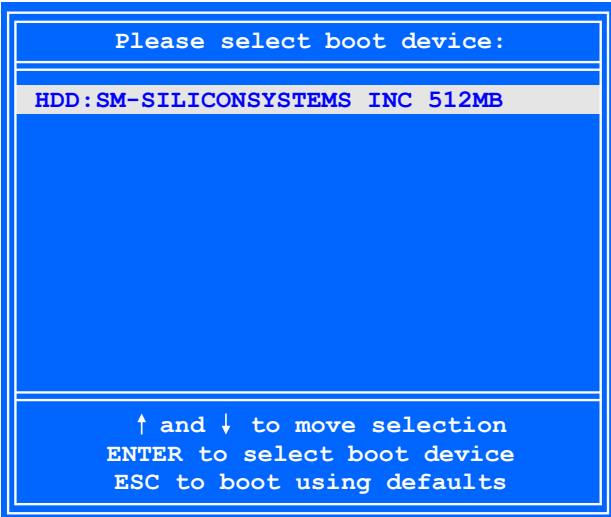
1.3 Main

The main BIOS Setup screen appears immediately after the button is pressed during startup.

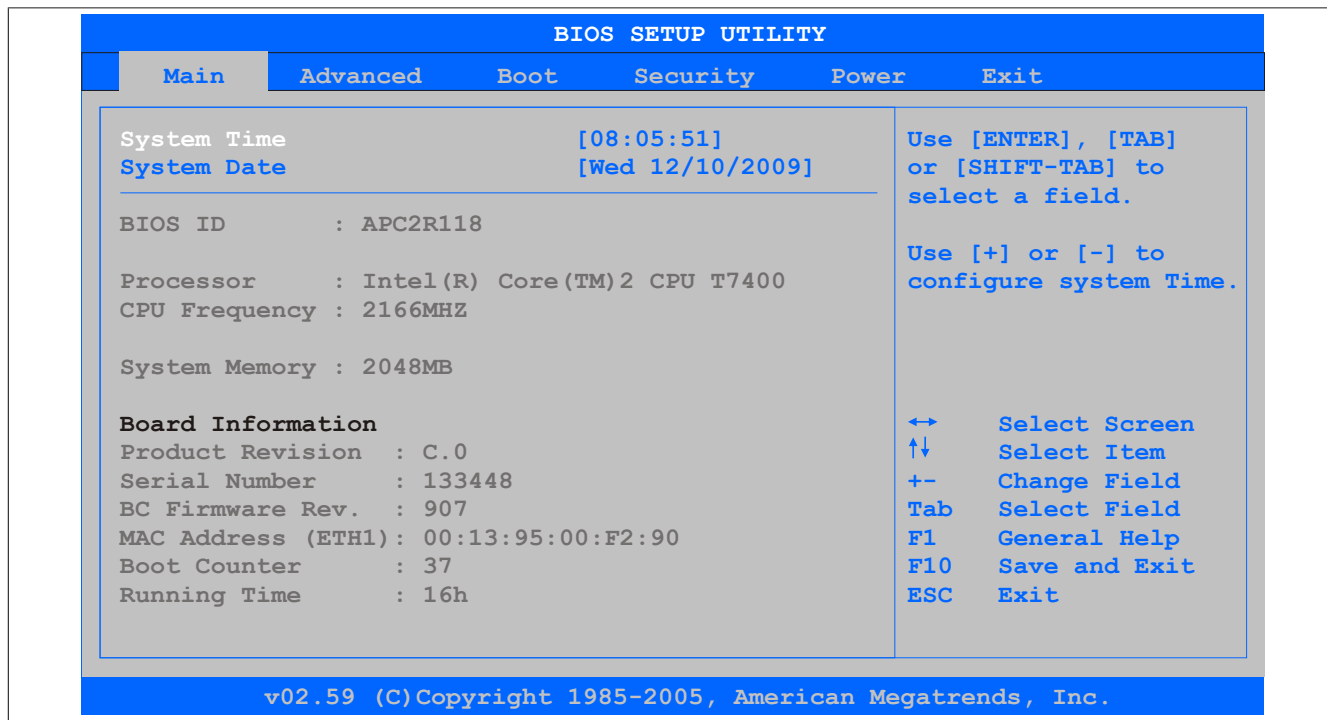

Figure 93: 945GME BIOS Main Menü

BIOS setting	Function	Configuration options	Effect
System time	The currently configured system time setting. This is buffered by the CMOS battery when the system is switched off.	Changes the system time	Sets the system time in the format Hour:Minute:Second (hh:mm:ss)
System date	The currently configured system date. This is buffered by the CMOS battery when the system is switched off.	Changes the system date	Sets the system date in the format Month:Day:Year (mm:dd:yyyy)
BIOS ID	Displays the BIOS version	None	-
Processor	Displays the processor type	None	-
CPU frequency	Displays the processor frequency	None	-
System memory	Displays the system memory size	None	-
Product revision	Displays the hardware revision of the CPU board	None	-
Serial number	Displays the serial number of the CPU board	None	-
BC firmware rev.	Displays the firmware revision of the CPU board controller	None	-
MAC address (ETH1)	Displays the assigned MAC address for the ETH1 interface	None	-
Boot counter	Displays the boot counter; each restart increases the counter by one (max. 16777215)	None	-
Running time	Displays the runtime in hours (max. 65535)	None	-

Table 142: 945GME Main menu - Configuration options

1.4 Advanced

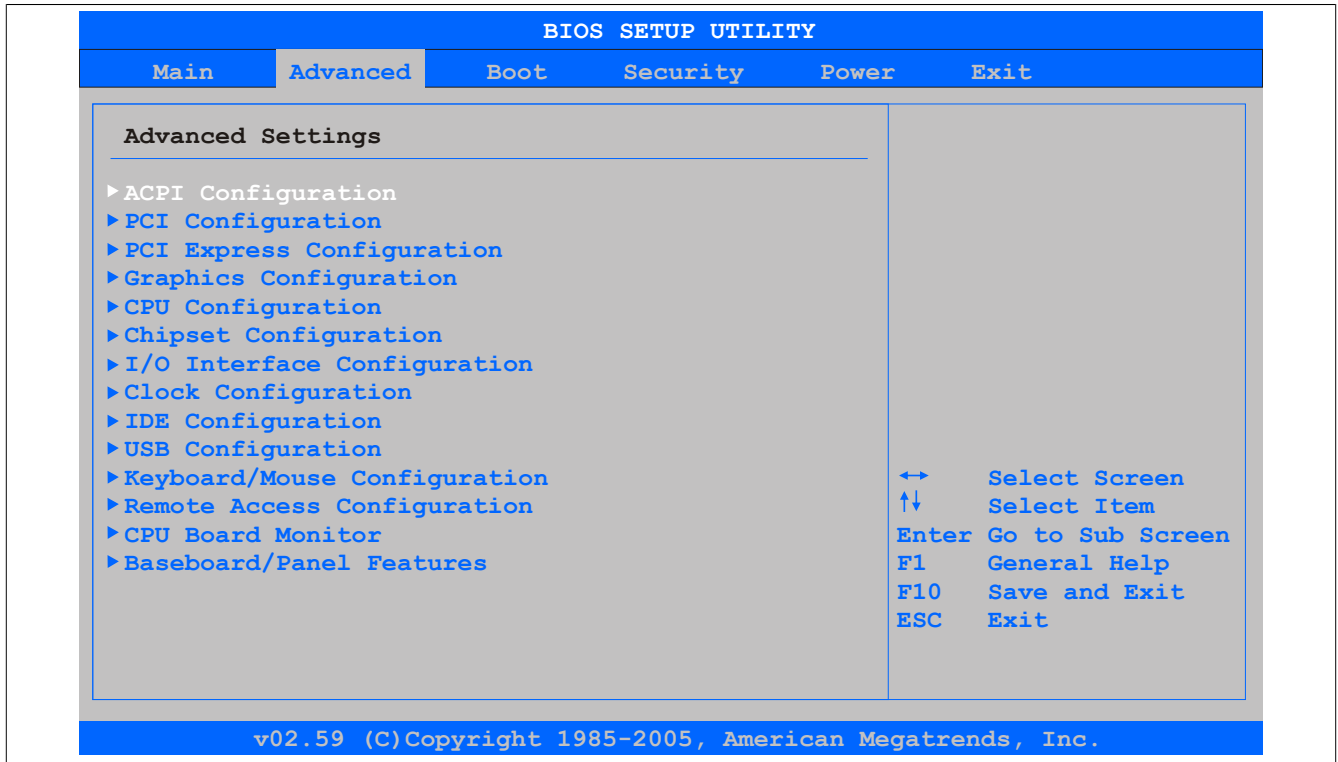

Figure 94: 945GME Advanced Menü

BIOS setting	Function	Configuration options	Effect
ACPI configuration	Configures ACPI devices	Enter	Opens the submenu see "ACPI configuration" on page 188
PCI configuration	Configures PCI devices	Enter	Opens the submenu see "PCI configuration" on page 189
PCI Express configuration	Configures PCI Express settings	Enter	Opens the submenu see "PCI Express configuration" on page 192
Graphics configuration	Configures graphics settings	Enter	Opens the submenu see "Graphics configuration" on page 194
CPU configuration	Configures CPU settings	Enter	Opens the submenu see "CPU configuration" on page 196
Chipset configuration	Configures chipset functions	Enter	Opens the submenu see "Chipset configuration" on page 197
I/O interface configuration	Configures I/O devices	Enter	Opens the submenu see "I/O interface configuration" on page 198
Clock configuration	Configures clock settings	Enter	Opens the submenu see "Clock configuration" on page 198
IDE configuration	Configures IDE functions	Enter	Opens the submenu see "IDE configuration" on page 199
USB configuration	Configures USB settings	Enter	Opens the submenu see "USB configuration" on page 204
Keyboard/Mouse configuration	Configures keyboard/mouse options	Enter	Opens the submenu see "Keyboard/Mouse configuration" on page 205
Remote access configuration	Configures remote access settings	Enter	Opens the submenu see "Remote access configuration" on page 206
CPU board monitor	Displays the current voltages and temperature of the processor in use	Enter	Opens the submenu see "CPU board monitor" on page 207
Baseboard/Panel features	Displays and configures device-specific settings	Enter	Opens the submenu see "Baseboard/Panel features" on page 208

Table 143: 945GME Advanced menu

1.4.1 ACPI configuration

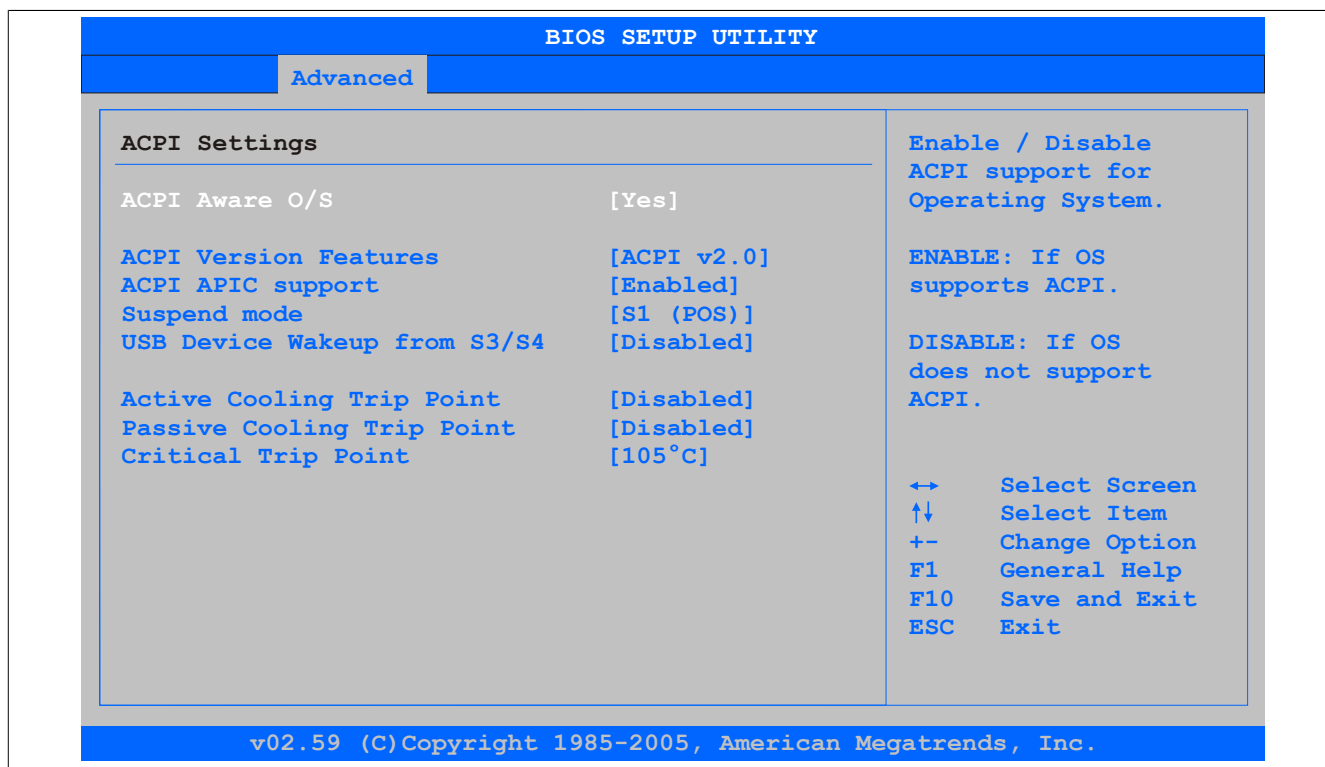

Figure 95: 945GME Advanced ACPI Configuration

BIOS setting	Function	Configuration options	Effect
ACPI aware O/S	This function determines if the operating system supports the ACPI function (Advanced Configuration and Power Interface).	Yes	The operating system supports ACPI.
		No	The operating system does not support ACPI.
ACPI version features	Option for setting the power option specifications to be supported. The ACPI functions must be supported by the drivers and operating systems being used.	ACPI v1.0	Uses ACPI functions in accordance with v1.0
		ACPI v2.0	Uses ACPI functions in accordance with v2.0
		ACPI v3.0	Uses ACPI functions in accordance with v3.0
ACPI APIC support	This option controls the support of the advanced programmable interrupt controller in the processor.	Enabled	Enables this function
		Disabled	Disables the function
Suspend mode	Selects the ACPI status to be used when Suspend mode is enabled	S1 (POS)	Sets S1 as Suspend mode. Only a few functions are disabled and are available again at the touch of a button
		S3 (STR)	Sets S3 as Suspend mode. The current state of the operating system is written to RAM, which is then the only component to receive power.
USB device wakeup from S3/S4	This option makes it possible for activity on a connected USB device to wake the system up from S3/S4 standby mode.	Enabled	Enables this function
		Disabled	Disables this function
Active cooling trip point	This function can be used to switch on an optional CPU fan via the operating system when the CPU reaches the set temperature.	Disabled	Disables this function
		50°C, 60°C, 70°C, 80°C, 90°C	Temperature setting for the active cooling trip point. Configurable in increments of 10 degrees.
Passive cooling trip point	Option for configuring a CPU temperature at which the operating system throttles the CPU speed	Disabled	Disables this function
		50°C, 60°C, 70°C, 80°C, 90°C	Temperature setting for the passive cooling trip point. Configurable in increments of 10 degrees.
Critical trip point	Option for configuring a CPU temperature at which the operating system automatically shuts down	80°C, 85°C, 90°C, 95°C, 100°C, 105°C, 110°C	Temperature setting for the critical trip point. Configurable in increments of 5 degrees.

Table 144: 945GME Advanced - ACPI configuration - Configuration options

1.4.2 PCI configuration

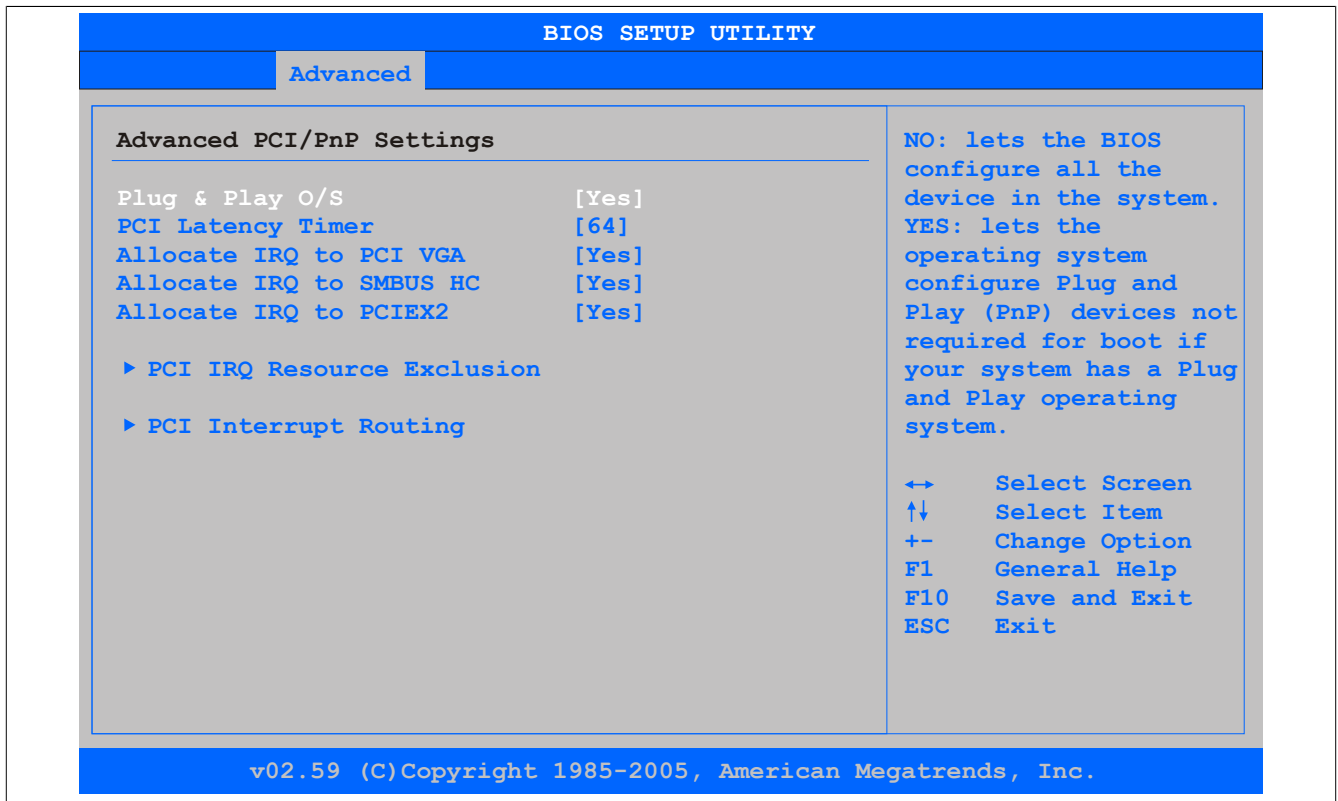

Figure 96: 945GME Advanced PCI Configuration

BIOS setting	Function	Configuration options	Effect
Plug & Play O/S	Informs BIOS if the operating system is capable of handling plug and play	Yes	Resource allocation handled by the operating system
		No	Resource allocation handled by BIOS
PCI latency timer	Option for controlling how long (in PCI ticks) one PCI bus card can continue to use the master after another PCI card has requested access	32, 64, 96, 128, 160, 192, 224, 248	Manually sets the value in PCI ticks
Allocate IRQ to PCI VGA	This function is used to determine if an interrupt is assigned to the PCI VGA.	Yes	Interrupt assigned automatically
		No	Interrupt not assigned
Allocate IRQ to SMBUS HC	This function is used to set whether the SM (system management) bus controller is assigned a PCI interrupt.	Yes	PCI interrupt assigned automatically
		No	Interrupt not assigned
Allocate IRQ to PCIEX2	This function is used to specify whether the PCIEX2 is assigned a PCI interrupt.	Yes	PCI interrupt assigned automatically
		No	Interrupt not assigned
PCI IRQ resource exclusion	Configures the PCI IRQ resource settings for ISA Legacy devices	Enter	Opens the submenu see "PCI IRQ resource exclusion" on page 190
PCI interrupt routing	Configures PCI interrupt routing	Enter	Opens the submenu see "PCI interrupt routing" on page 191

Table 145: 945GME Advanced - PCI configuration - Configuration options

1.4.2.1 PCI IRQ resource exclusion

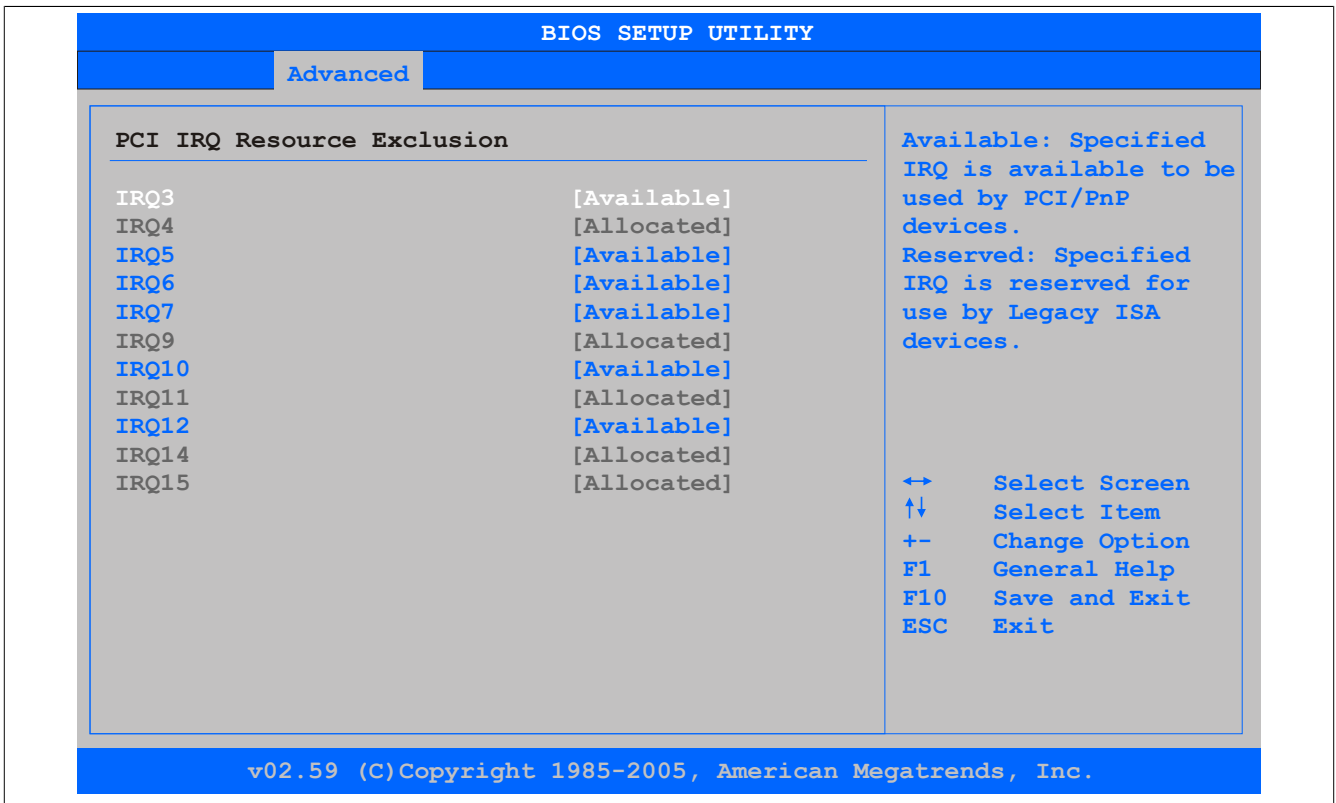

Figure 97: 945GME Advanced PCI IRQ Resource Exclusion

BIOS setting	Function	Configuration options	Effect
IRQx	IRQ interrupt routing for Legacy ISA devices	Allocated	Allocated by the system - cannot be used
		Available	Available - can be used
		Reserved	Reserved - cannot be used

Table 146: 945GME Advanced - PCI IRQ resource exclusion - Configuration options

1.4.2.2 PCI interrupt routing

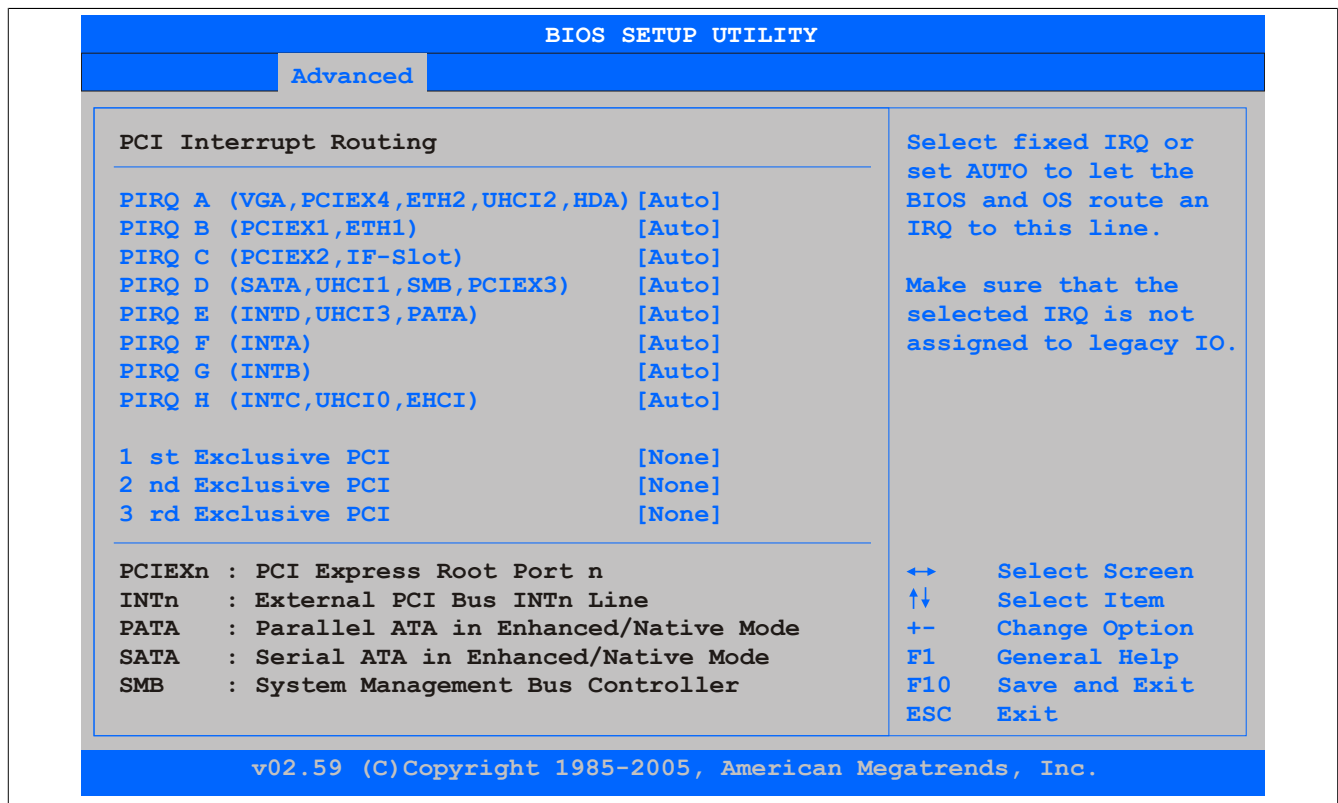

Figure 98: 945GME Advanced PCI Interrupt Routing

BIOS setting	Function	Configuration options	Effect
PIRQ A (VGA, PCIEX4, ETH2, UHCI2, HDA)	Option for configuring PIRQ A	Auto	Automatic assignment by BIOS and the operating system
		5,6,7,9,10,11,12	Manual assignment
PIRQ B (PCIEX1, ETH1)	Option for configuring PIRQ B	Auto	Automatic assignment by BIOS and the operating system
		5,6,7,9,10,11,12	Manual assignment
PIRQ C (PCIEX2, IF slot)	Option for configuring PIRQ C	Auto	Automatic assignment by BIOS and the operating system
		5,6,7,9,10,11,12	Manual assignment
PIRQ D (SATA,UHCI1,SMB, PCIEX3)	Option for configuring PIRQ D	Auto	Automatic assignment by BIOS and the operating system
		5,6,7,9,10,11,12	Manual assignment
PIRQ E (INTD,UHCI3,PATA)	Option for configuring PIRQ E	Auto	Automatic assignment by BIOS and the operating system
		5,6,7,9,10,11,12	Manual assignment
PIRQ F (INTA)	Option for configuring PIRQ F	Auto	Automatic assignment by BIOS and the operating system
		5,6,7,9,10,11,12	Manual assignment
PIRQ G (INTB)	Option for configuring PIRQ G	Auto	Automatic assignment by BIOS and the operating system
		5,6,7,9,10,11,12	Manual assignment
PIRQ H (INTC,UHCI0,EHCI)	Option for configuring PIRQ H	Auto	Automatic assignment by BIOS and the operating system
		5,6,7,9,10,11,12	Manual assignment
1st exclusive PCI	This option is used to determine if the IRQ listed under PIRQ x is handled exclusively (no IRQ sharing). Information: This is only displayed if a PIRQ is configured manually (e.g. 5).	None	No interrupt assigned
		x	Assigns the PIRQ as the 1st exclusive PCI IRQ

Table 147: 945GME Advanced - PCI interrupt routing - Configuration options

BIOS setting	Function	Configuration options	Effect
2nd exclusive PCI	This option is used to determine if the IRQ listed under PIRQ x is handled exclusively (no IRQ sharing). Information: This is only displayed if two PIRQs are configured manually.	None	No interrupt assigned
		x	Assigns the PIRQ as the 2nd exclusive PCI IRQ
3rd exclusive PCI	This option is used to determine if the IRQ listed under PIRQ x is handled exclusively (no IRQ sharing). Information: This is only displayed if three PIRQs are configured manually.	None	No interrupt assigned
		x	Assigns the PIRQ as the 3rd exclusive PCI IRQ

Table 147: 945GME Advanced - PCI interrupt routing - Configuration options

1.4.2.3 PCI Express configuration

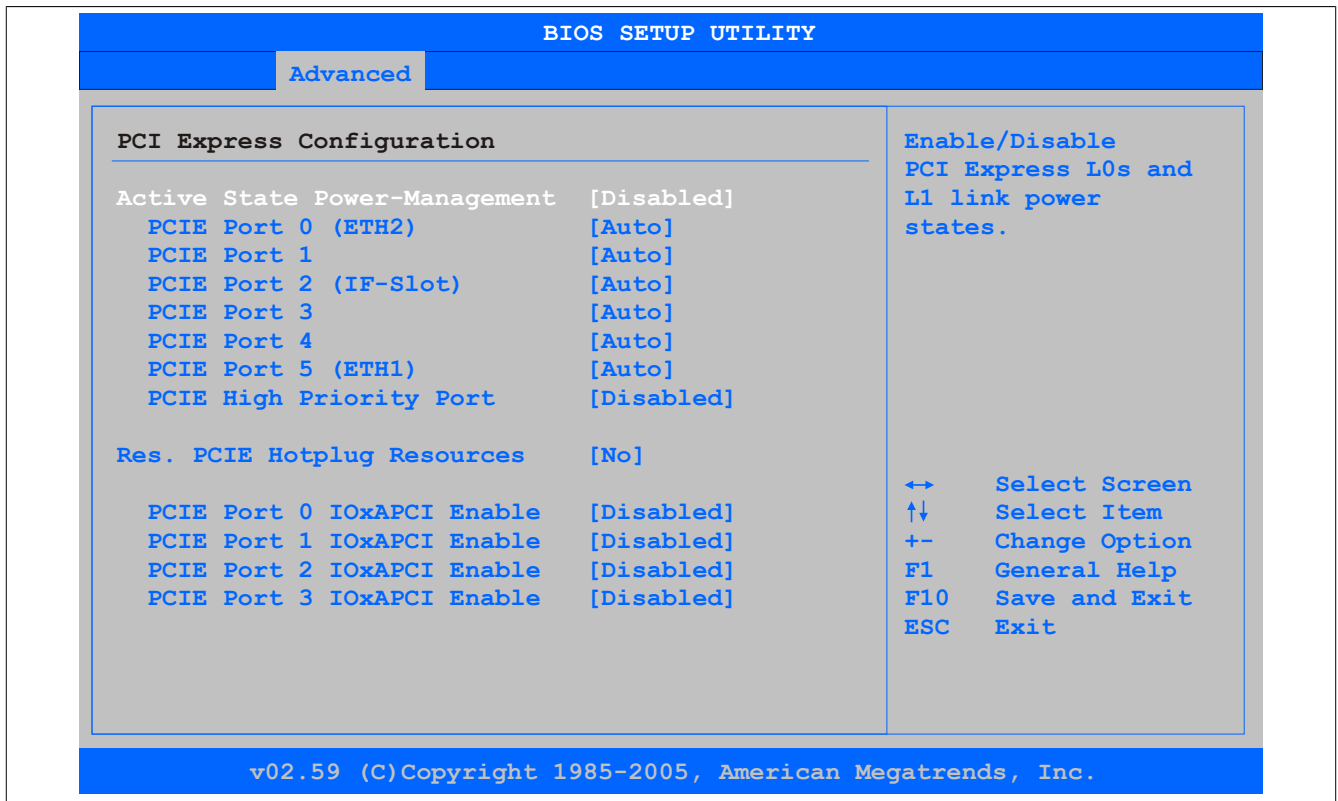

Figure 99: 945GME Advanced PCI Express Configuration

BIOS setting	Function	Configuration options	Effect
Active state power management	Option for configuring a power saving function (L0s/L1) for PCIe slots if they do not require full power	Enabled	Enables this function
		Disabled	Disables this function
PCIE port 0 (ETH2)	This option enables or disables the PCI Express interface function. Information: If no PCI Express devices are being used, this option should be disabled.	Auto	Automatic assignment by BIOS and the operating system
		Enabled	Enables this function
		Disabled	Disables this function
PCIE port 1	This option enables or disables the PCI Express interface function. Information: If no PCI Express devices are being used, this option should be disabled.	Auto	Automatic assignment by BIOS and the operating system
		Enabled	Enables this function
		Disabled	Disables this function
PCIE port 2 (IF slot)	This option enables or disables the PCI Express interface function.	Auto	Automatic assignment by BIOS and the operating system

Table 148: 945GME Advanced - PCI Express configuration - Configuration options

BIOS setting	Function	Configuration options	Effect
	Information: If no PCI Express devices are being used, this option should be disabled.	Enabled	Enables this function
		Disabled	Disables this function
PCIE port 3	This option enables or disables the PCI Express interface function. Information: If no PCI Express devices are being used, this option should be disabled.	Auto	Automatic assignment by BIOS and the operating system
		Enabled	Enables this function
		Disabled	Disables this function
PCIE port 4	This option enables or disables the PCI Express interface function. Information: If no PCI Express devices are being used, this option should be disabled.	Auto	Automatic assignment by BIOS and the operating system
		Enabled	Enables this function
		Disabled	Disables this function
PCIE port 5 (ETH1)	This option enables or disables the PCI Express interface function. Information: If no PCI Express devices are being used, this option should be disabled.	Auto	Automatic assignment by BIOS and the operating system
		Enabled	Enables this function
		Disabled	Disables this function
PCIE high priority port	This option enables or disables the priority port for PCIE.	Disabled	Disables this function
		Port 0	Enables port 0 as the priority port
		Port 1	Enables port 1 as the priority port
		Port 2	Enables port 2 as the priority port
		Port 3	Enables port 3 as the priority port
		ETH2	Enables ETH2 as the priority port
		ETH1	Enables ETH1 as the priority port
Res. PCIE hot plugging resource	This option is used to reserve an I/O and memory resource for an unused PCIE port. A PCIE port must be set to "Enabled" and resources must be reserved in order for ExpressCard hot-plugging to be supported on the respective port.	Yes	Resource reserved
		No	Resource not reserved
PCIE port 0 IOxAPIC enable	This option enables or disables the APIC (Advanced Programmable Interrupt Controller) on PCIE port 0. The IRQ resources available to the system are expanded when APIC mode is enabled.	Enabled	Enables this function
		Disabled	Disables this function
PCIE port 1 IOxAPIC enable	This option enables or disables the APIC (Advanced Programmable Interrupt Controller) on PCIE port 1. The IRQ resources available to the system are expanded when APIC mode is enabled.	Enabled	Enables this function
		Disabled	Disables this function
PCIE port 2 IOxAPIC enable	This option enables or disables the APIC (Advanced Programmable Interrupt Controller) on PCIE port 2. The IRQ resources available to the system are expanded when APIC mode is enabled.	Enabled	Enables this function
		Disabled	Disables this function
PCIE port 3 IOxAPIC enable	This option enables or disables the APIC (Advanced Programmable Interrupt Controller) on PCIE port 3. The IRQ resources available to the system are expanded when APIC mode is enabled.	Enabled	Enables this function
		Disabled	Disables this function

Table 148: 945GME Advanced - PCI Express configuration - Configuration options

1.4.3 Graphics configuration

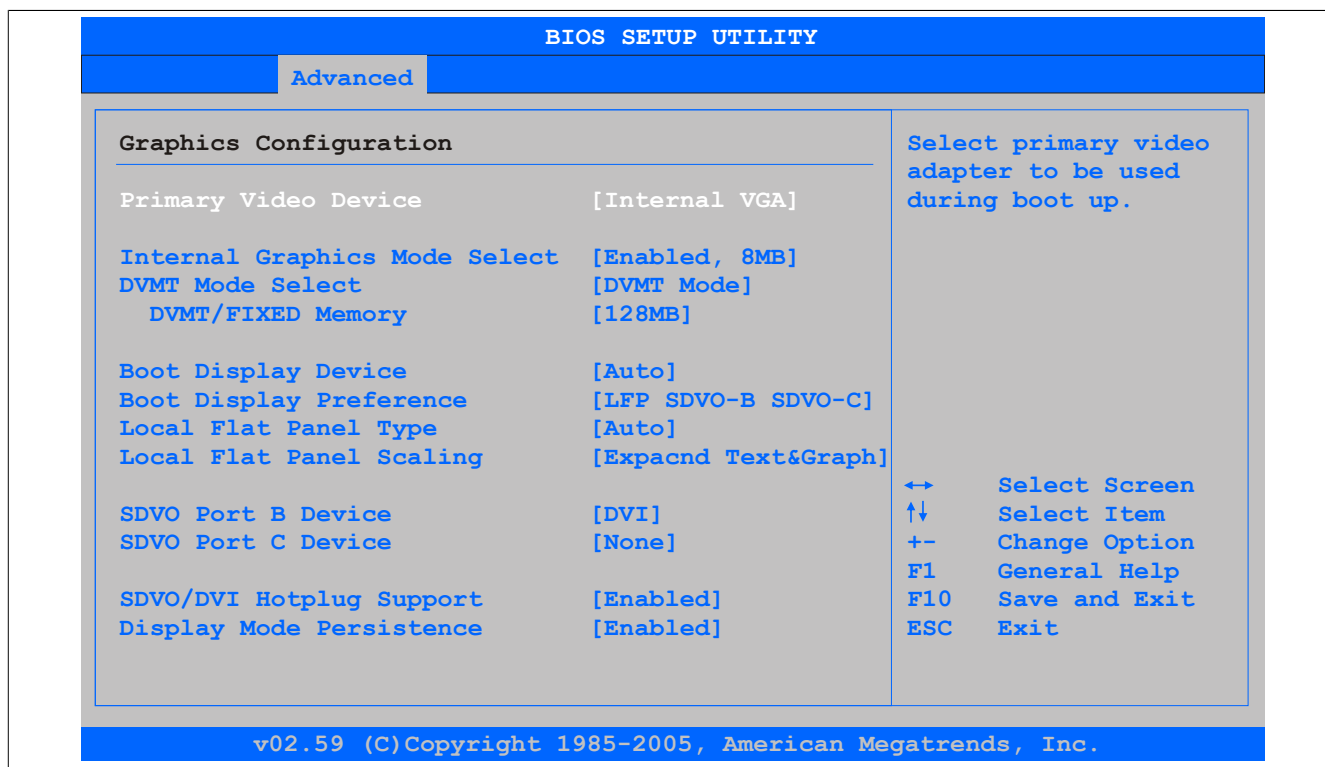

Figure 100: 945GME Advanced Graphics Configuration

BIOS setting	Function	Configuration options	Effect
Primary video device	Option for selecting the primary display device	Internal VGA	Uses the internal graphics chip on the CPU board as the video device (monitor/panel interface)
		PCI / Int. VGA	Uses the graphics chip of a connected graphics card as the display device
Internal graphics mode select	Option for setting the amount of memory used for the internal graphics controller	Disabled	Nothing reserved, disables the graphics controller
		Enabled, 1MB	Provides 1 MB main memory
		Enabled, 8MB	Provides 8 MB main memory
DVMT mode select	Option for determining the DVMT mode (Dynamic Video Memory Technology) of the DVMT graphics driver	Fixed mode	Allocates a fixed amount of memory to the graphics chip, which is then no longer available to the PC
		DVMT mode	Memory consumption controlled dynamically by the DVMT graphics driver. Only the amount of memory that is required is reserved.
		Combo mode	At least 64 MB reserved by the DVMT graphics driver (up to 224 MB possible)
DVMT/FIXED memory	Option for setting the amount of memory used for DVMT mode	64 MB	Allows 64 MB of main memory to be used
		128 MB	Allows 128 MB of main memory to be used
		Maximum DVMT	Allows the remaining available main memory to be used
Boot display device	Determines which video channel should be enabled for a display device during booting	Auto	Automatic selection
		CRT only	Uses only the CRT (Cathode Ray Tube) channel
		SDVO only	Uses only the SDVO (Serial Digital Video Out) channel
		CRT + SDVO	Uses the CRT and SDVO channel
		LFP only	Uses only the LFP (Local Flat Panel) channel
		CRT + LFP	Uses the CRT and LFP channel
Boot display preference	This option determines the order in which the devices on the connected LFP and SDVO channels should be checked and booted.	LFP SDVO-B SDVO-C	Local Flat Panel - Serial Digital Video B output - Serial Video C output
		LFP SDVO-C SDVO-B	Local Flat Panel - Serial Digital Video C output - Serial Video B output
		SDVO-B SDVO-C LFP	Serial Digital Video B output - Serial Digital Video C output - Local Flat Panel
		SDVO-C SDVO-B LFP	Serial Digital Video C output - Serial Digital Video B output - Local Flat Panel
Local flat panel type	This option can be used to set a predefined profile for the LVDS channel.	Auto	Automatic detection and configuration using the EDID data

Table 149: 945GME Advanced - Graphics configuration - Configuration options

BIOS setting	Function	Configuration options	Effect
		VGA 1x18 (002h)	640 x 480
		VGA 1x18 (013h)	640 x 480
		SVGA 1x18 (004h)	800 x 600
		XGA 1x18 (006h)	1024 x 768
		XGA 2x18 (007h)	1024 x 768
		XGA 1x24 (008h)	1024 x 768
		XGA 2x24 (012h)	1024 x 768
		SXGA 2x24 (00Ah)	1280 x 1024
		SXGA 2x24 (018h)	1280 x 1024
		UXGA 2x24 (00Ch)	1600 x 1200
		Customized EDID 1	User-defined profile
		Customized EDID 2	User-defined profile
		Customized EDID 3	User-defined profile
Local flat panel scaling	Determines the screen content should be output depending on the configured local flat panel type	Centering	Centers the screen contents on the display
		Expand text	Expands text across the entire display
		Expand graphics	Expands graphics across the entire display
		Expand text & graphics	Expands text and graphics across the entire display
SDVO port B device	Option for selecting the display device that is connected to SDVO Port B	None	No display device connected
		DVI	Optimizes video signal output for a DVI-compatible display device
		TV	Optimizes video signal output for a TV-compatible display device
		CRT	Optimizes video signal output for a CRT-compatible display device
		LVDS	Optimizes video signal output for a LVDS-compatible display device
		DVI-analog	Optimizes video signal output for an analog DVI-compatible display device
SDVO port C device	Option for selecting the display device that is connected to SDVO Port A	None	No display device connected
		DVI	Optimizes video signal output for a DVI-compatible display device
		TV	Optimizes video signal output for a TV-compatible display device
		CRT	Optimizes video signal output for a CRT-compatible display device
		LVDS	Optimizes video signal output for a LVDS-compatible display device
		DVI-analog	Optimizes video signal output for an analog DVI-compatible display device
SDVO/DVI hot plugging support	If this option is set to enabled, the Windows XP graphics driver supports "hot plugging" and "configuration mode persistence" for DVI monitors connected to a DVI SDVO transmitter. "Hot plugging" support means that when a DVI monitor is connected while the operating system is running, it is detected automatically and activated. "Configuration mode persistence" means that a dual DVI configuration, for example, is automatically restored when both DVI monitors are reconnected, even if only one of them was connected and enabled during a previous boot.	Enabled	Enables "Hot plugging" and "Configuration mode persistence" mode
		Disabled	Disables "Hot plugging" and "Configuration mode persistence" mode
Display mode persistence	"Display mode persistence" means that the operating system can remember and restore past display configurations. For example, a dual DVI configuration is automatically restored when both DVI monitors are reconnected, even if only one of them was connected and enabled during a previous boot.	Enabled	Enables this function
		Disabled	Disables this function

Table 149: 945GME Advanced - Graphics configuration - Configuration options

1.4.4 CPU configuration

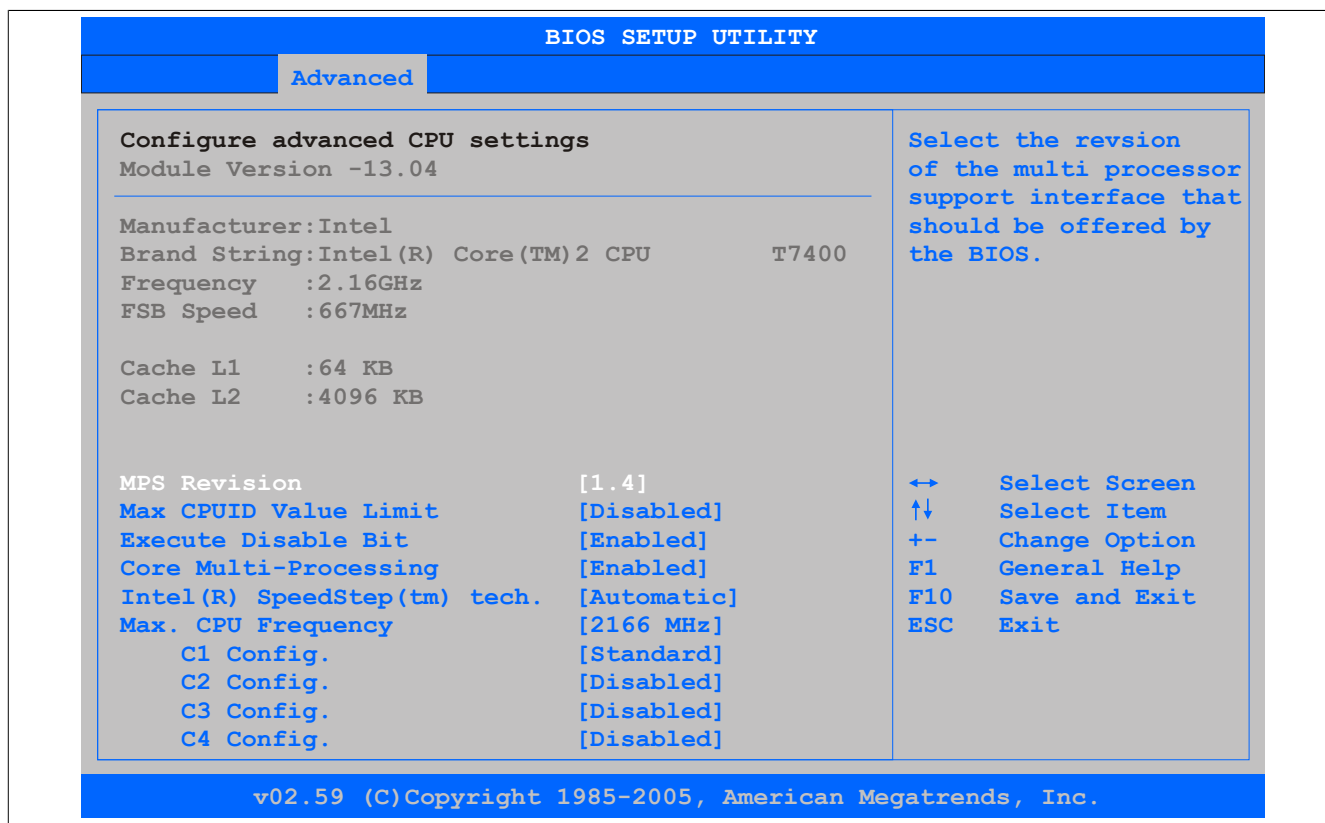

Figure 101: 945GME Advanced CPU Configuration

BIOS setting	Function	Configuration options	Effect
MPS revision	This option supports the use of multiple CPUs (MPS=multi-processor system).	1.1	Sets MPS support to Revision 1.1
		1.4	Sets MPS support to Revision 1.4
Max CPUID value limit	Option for limiting the CPUID input value. This may be necessary for older operating systems.	Enabled	The processor limits the maximum CPUID input value to 03h if necessary if the processor supports a higher value.
		Disabled	The processor returns the current maximum value when the CPUID input value is requested.
Execute disable bit	Option for enabling/disabling hardware support for prevention of data execution	Enabled	Enables this function
		Disabled	Disables this function
Core multi-processing	This option can be used to disable a core when using a dual-core processor.	Enabled	Uses both cores in a dual-core processor
		Disabled	Uses only one core in a dual-core processor
Intel(R) Speedster(tm) tech.	Option for controlling the Intel(R) SpeedStep(TM) technology. The processor clock speed is increased or decreased according to the number of calculations that must be made. As a result, the power consumption depends largely on the processor load.	Automatic	The processor speed is regulated by the operating system.
		Maximum speed	The processor speed is set to a maximum.
		Minimum speed	The processor speed is set to a minimum.
		Disabled	Disables SpeedStep technology
Max. CPU frequency	Option for setting the maximum processor speed if the value "Automatic" or "Maximum speed" is set for the option "Intel(R) SpeedStep(tm) tech."	xxxx MHz	Limits the processor speed to the configured value
C1 config	Power management for the Intel Core Duo processor	Standard	Standard C1 support
		Enhanced	Enhanced C1 support
C2 config	Power management for the Intel Core Duo processor	Standard	Standard C2 support
		Enhanced	Enhanced C2 support
		Disabled	Disables C2 support
C3 config	Power management for the Intel Core Duo processor	Standard	Standard C3 support
		Enhanced	Enhanced C3 support
		Disabled	Disables C3 support
C4 config	Power management for the Intel Core Duo processor	Standard	Standard C4 support
		Enhanced	Enhanced C4 support
		Disabled	Disables C4 support

Table 150: 945GME Advanced - CPU configuration - Configuration options

1.4.5 Chipset configuration

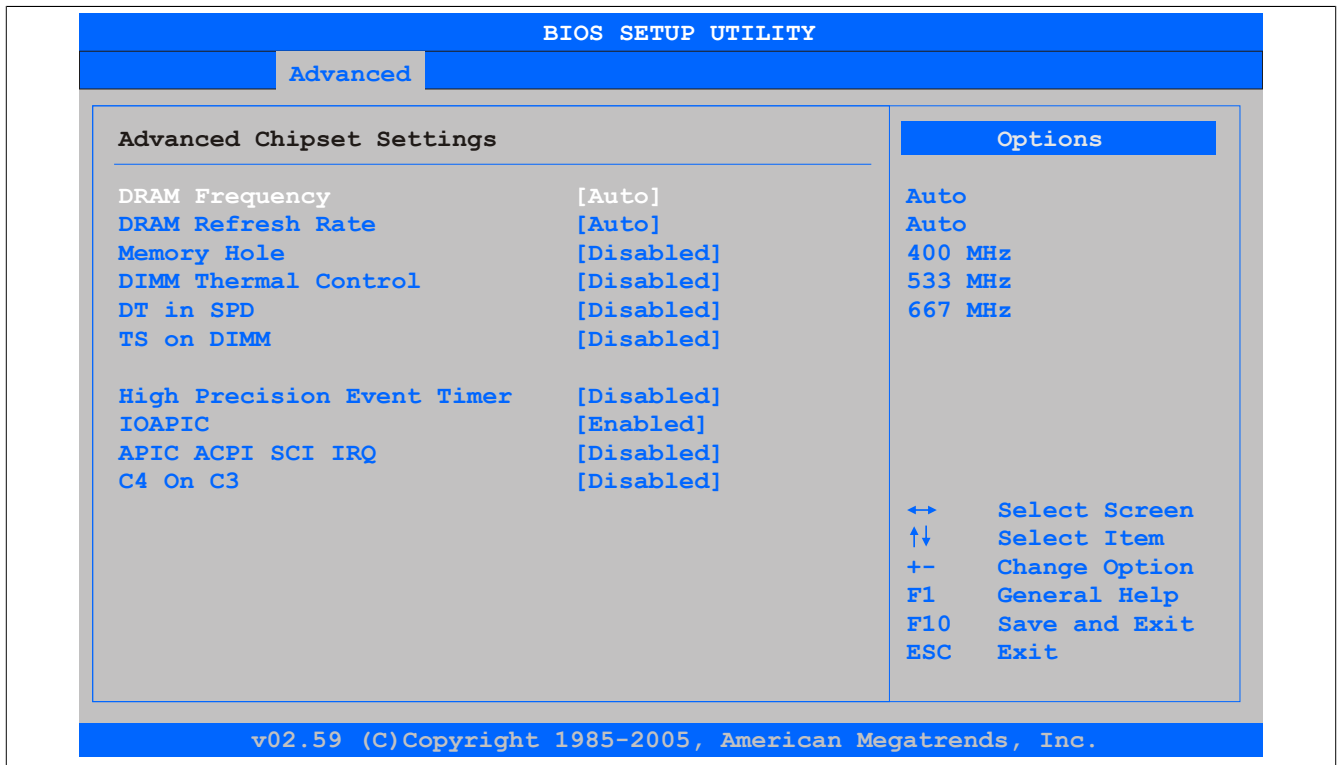

Figure 102: 945GME Advanced Chipset Configuration

BIOS setting	Function	Configuration options	Effect
DRAM frequency	Option for setting the RAM frequency	Auto	BIOS sets the frequency automatically.
		400, 533, 667 MHz	The desired clock frequency is set manually.
DRAM refresh rate	Option for configuring the DRAM refresh rate	Auto	Reads the DRAM refresh rate from the SPD data of the DRAM module
		7.8 μs	The DRAM refresh rate is set manually.
		3.9 μs	The DRAM refresh rate is set manually.
Memory hole	Option for ISA cards with a frame buffer. This does not apply to the PPC800.	Disabled	Disables this function
		15MB-16MB	Reserves the address range
DIMM thermal control	Option for setting the maximum surface temperature of the DIMM module. The module is cooled by limiting the memory bandwidth if the defined surface temperature is reached.	Disabled	Surface temperature not limited
		40°C, 50°C, 60°C, 70°C, 80°C, 85°C, 90°C	Temperature limit value for the limitation
DT in SPD	Option to determine whether the GMCH (graphics and memory controller hub) supports DT (delta temperature) in the SPD (serial presence detect) management algorithm of the DIMM module	Enabled	Enables this function
		Disabled	Disables this function
TS on DIMM	Option to determine whether the GMCH (graphics and memory controller hub) supports the TS (thermal sensor) in the thermal management algorithm of the DIMM module	Enabled	Enables this function
		Disabled	Disables this function
High precision event timer	The HPET is a timer inside the PC. It is able to trigger an interrupt with a high degree of accuracy, which allows other programs to better synchronize a variety of applications.	Enabled	Enables this function. This function is recommended for multimedia applications.
		Disabled	Disables this function
IOAPIC	This option is used to enable or disable the APIC (Advanced Programmable Interrupt Controller).	Enabled	The IRQ resources available to the system are expanded when APIC mode is enabled.
		Disabled	Disables this function
APIC ACPI SCI IRQ	This option is used to modify the SCI IRQ when in APIC (Advanced Programmable Interrupt Controller) mode.	Enabled	Uses IRQ20 for SCI
		Disabled	Disables this function
C4 on C3	Fine-tunes the power saving function on an ACPI operating system	Enabled	Brings the processor to C4 if the operating system is initiated in a C3 state
		Disabled	Disables this function

Table 151: 945GME Advanced - Chipset settings - Configuration options

1.4.6 I/O interface configuration

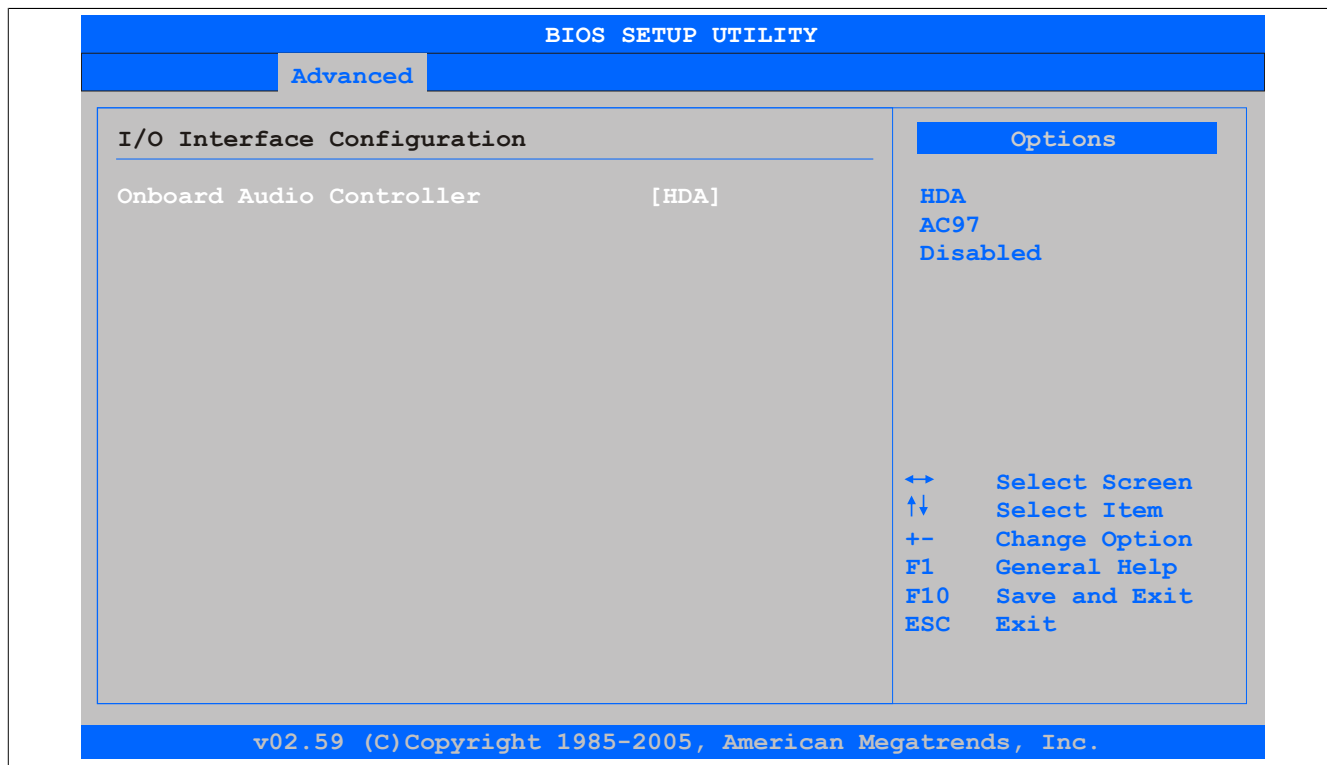

Figure 103: 945GME Advanced I/O Interface Configuration

BIOS setting	Function	Configuration options	Effect
Onboard audio controller	Option for selecting or turning off the audio mode	HDA	Enables High Definition Audio sound
		AC97	Enables AC'97 sound
		Disabled	Disables the audio controller

Table 152: 945GME Advanced - I/O interface configuration - Configuration options

1.4.7 Clock configuration

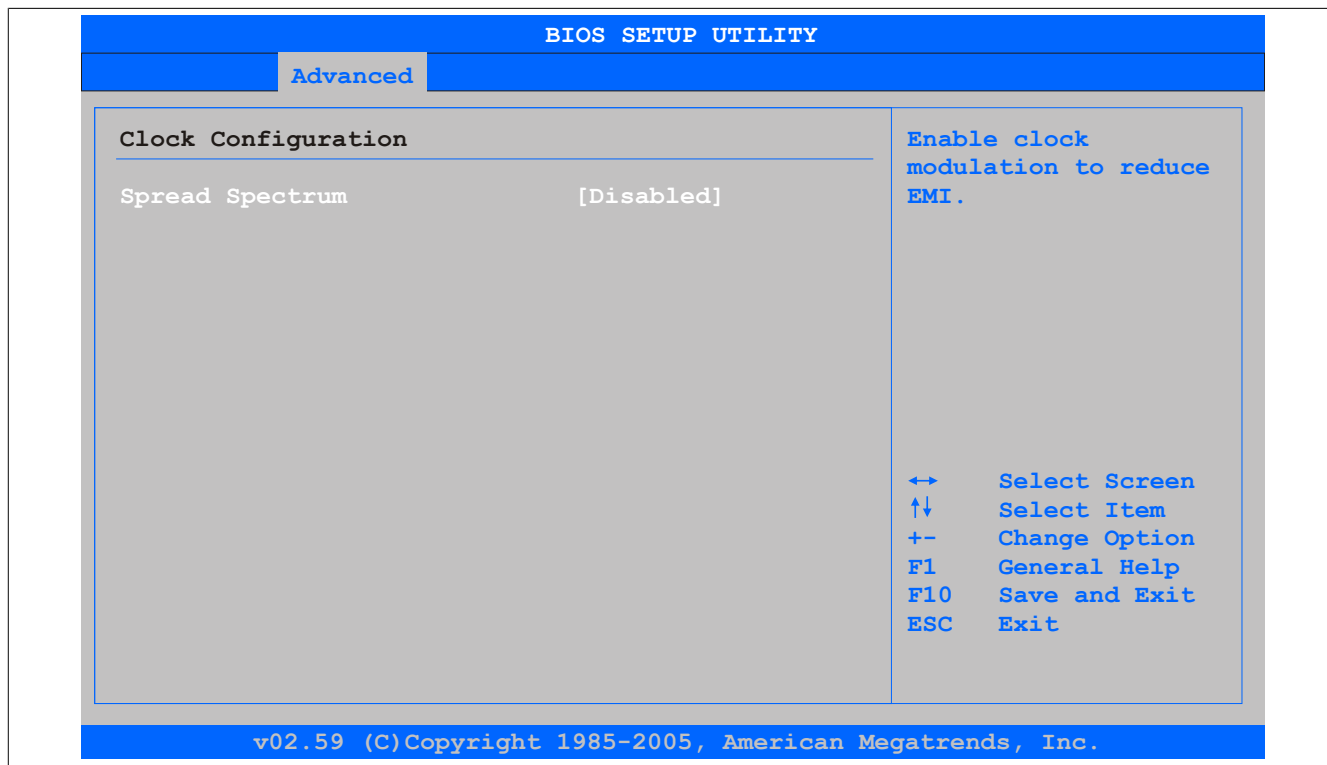

Figure 104: 945GME Advanced Clock Configuration

BIOS setting	Function	Configuration options	Effect
Spread spectrum	This option is used to modulate the cycle frequency to slightly reduce electromagnetic interference.	Enabled	Enables this function
		Disabled	Disables this function

Table 153: 945GME Advanced - Clock configuration - Configuration options

1.4.8 IDE configuration

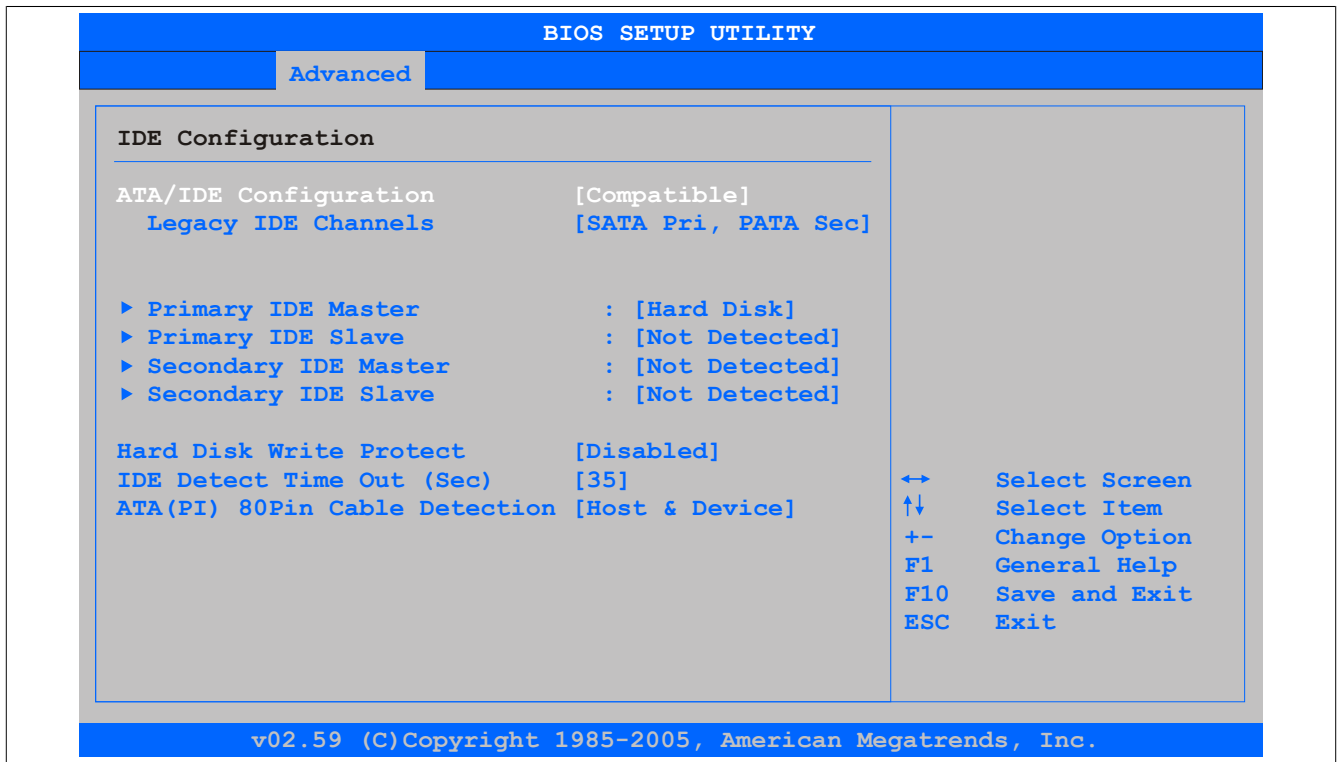

Figure 105: 945GME Advanced IDE Configuration

BIOS setting	Function	Configuration options	Effect
ATA/IDE configuration	Option for configuring the integrated PATA and SATA controllers	Compatible	Both controllers run in Legacy or Compatible mode.
		Disabled	Disables both controllers
		Enhanced	Both controllers run in Enhanced or Native mode.
Legacy IDE channels ¹⁾	Option for configuring the Legacy IDE channels in Compatible mode.	SATA Pri, PATA Sec	Assigns SATA drives as primary and PATA drives as secondary
		SATA only	Uses SATA drives only
		PATA only	Uses PATA drives only
Configure SATA as ²⁾	Allows the serial ATA connections supported by the southbridge to be defined	IDE	Uses the serial ATA hard drive as a parallel ATA physical drive
		RAID	RAID 0, 1, 5, 10 or Intel® Matrix Storage technology can be configured here with the serial ATA hard drive.
		AHCI	The AHCI setting enables the internal memory driver for SATA functions, which increases the storage performance for random read-write access by allowing the drive itself to determine the sequence of commands.
Configure SATA as channels ³⁾	Allows SATA or PATA drives to be configured as primary or secondary devices	Before PATA	Sets the SATA drives as primary devices and PATA as secondary
		Behind PATA	Sets the PATA drives as primary devices and SATA as secondary
AHCI/RAID SATA hot plug ⁴⁾	Allows the configuration of hot plugging support for AHCI/RAID systems	Enabled	Disables hot plugging support
		Disabled	Enables hot plugging support
Primary IDE master	Option for configuring the drive in the system that is connected to the IDE primary master port	Enter	Opens the submenu see "Primary IDE master" on page 200
Primary IDE slave	Option for configuring the drive in the system that is connected to the IDE primary slave port	Enter	Opens the submenu see "Primary IDE slave" on page 201
Secondary IDE master	Option for configuring the drive in the system that is connected to the IDE secondary master port	Enter	Opens the submenu see "Secondary IDE master" on page 202
Secondary IDE slave	Option for configuring the drive in the system that is connected to the IDE secondary slave port	Enter	Opens the submenu see "Secondary IDE slave" on page 203
Hard disk write protect	Option for enabling/disabling write protection for the hard drive	Enabled	Enables this function
		Disabled	Disables this function
IDE detect time out (sec)	Configures the time overrun limit for ATA/ATAPI device detection.	0, 5, 10, 15, 20, 25, 30, 35	Time setting in seconds

BIOS setting	Function	Configuration options	Effect
ATA(PI) 80-pin cable detection	<p>Configures whether an 80-pin cable is connected to the drive, to the controller or to both</p> <p>Information:</p> <p>This option is not available on the PPC800 CPU board. This setting therefore does not apply.</p>	Host & device	Uses both IDE controllers (motherboard, disk drive)
		Host	Uses the IDE controller on the motherboard
		Device	Uses the IDE controller on the disk drive

- 1) These settings are only possible if *ATA/IDE configuration* is set to *Compatible*.
- 2) These settings are only possible if *ATA/IDE configuration* is set to *Enhanced*.
- 3) These settings are only possible if *ATA/IDE Configuration* is set to *Enhanced* and *Configure SATA* as to *IDE*.
- 4) These settings are only possible if *ATA/IDE configuration* is set to *Enhanced* and *Configure SATA* as is set to *RAID* or *AHCI*.

1.4.8.1 Primary IDE master

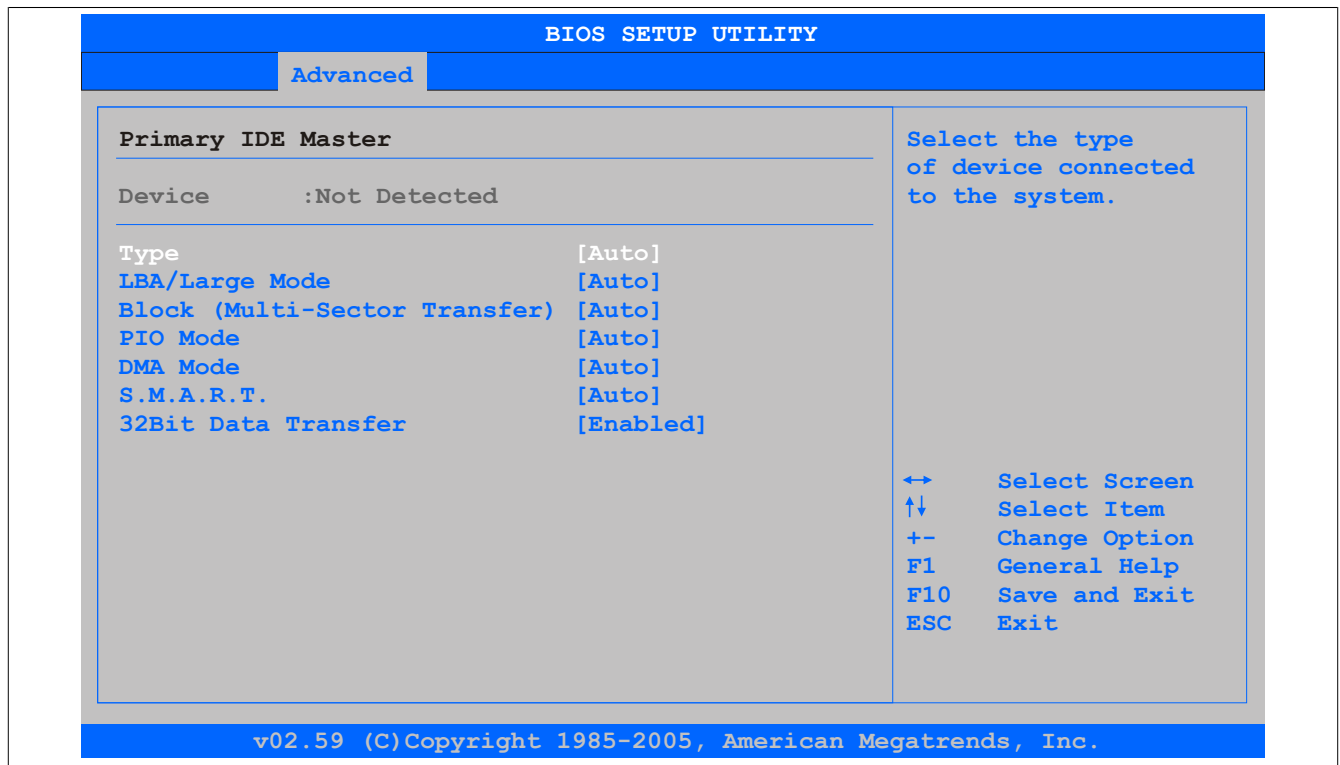

Figure 106: 945GME Primary IDE Master

BIOS setting	Function	Configuration options	Effect
Type	Configures the type of drive connected to the primary master	Not installed	No drive installed
		Auto	Automatically detects the drive and configures the necessary values
		CD/DVD	CD/DVD drive
LBA/Large mode	This option enables IDE logical block addressing / large mode.	ARMD	ARMD drive (zip drive)
		Disabled	Disables this function
Block (multi-sector transfer)	This option enables block mode for IDE hard drives. If this option is enabled, the number of blocks per request is read from the configuration sector of the hard drive.	Auto	Automatically enables this function if supported by the system
		Disabled	Disables this function
PIO mode	PIO mode determines the data rate of the hard drive.	Auto	Configures PIO mode automatically
		0, 1, 2, 3, 4	Configures PIO mode manually
DMA mode	Defines the data transfer rate to and from the primary master drive. DMA mode must be enabled activated in the Windows Device Manager in order to guarantee maximum performance. This is only possible when manually setting up the drive.	Auto	Defines the transfer rate automatically
		Disabled	Defines the transfer rate manually
S.M.A.R.T.	Monitoring function for hard drives (Self-Monitoring, Analysis and Reporting Technology)	Auto	Detected and enabled automatically
		Enabled	Enables this function
		Disabled	Disables this function
32 bit data transfer	Enables 32-bit data transfer	Enabled	Enables this function
		Disabled	Disables this function

Table 154: 945GME Advanced - Primary IDE master - Configuration options

1.4.8.2 Primary IDE slave

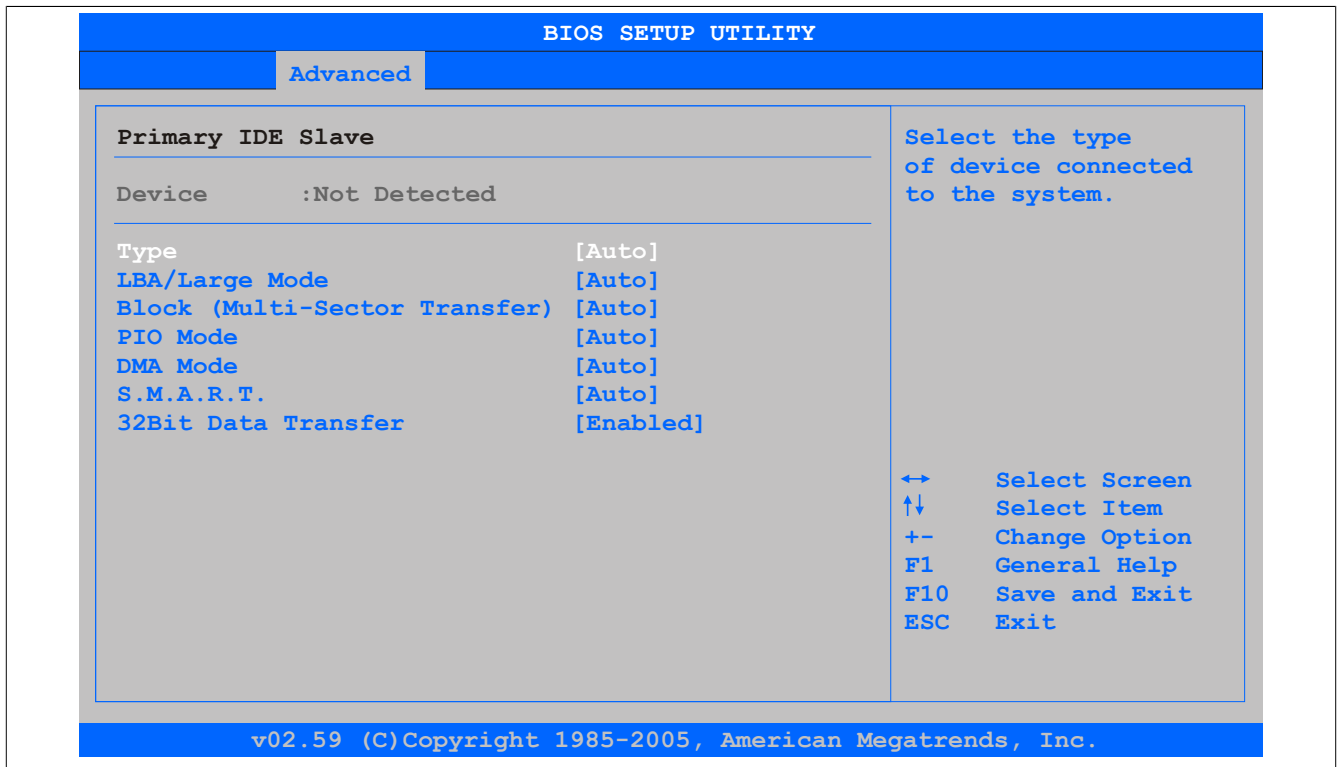

Figure 107: 945GME Primary IDE Slave

BIOS setting	Function	Configuration options	Effect
Type	Configures the type of drive connected to the primary master	Not installed	No drive installed
		Auto	Automatically detects the drive and configures the necessary values
		CD/DVD	CD/DVD drive
		ARMD	ARMD drive (zip drive)
LBA/Large mode	This option enables IDE logical block addressing / large mode.	Disabled	Disables this function
		Auto	Automatically enables this function if supported by the system
Block (multi-sector transfer)	This option enables block mode for IDE hard drives. If this option is enabled, the number of blocks per request is read from the configuration sector of the hard drive.	Disabled	Disables this function
		Auto	Automatically enables this function if supported by the system
PIO mode	PIO mode determines the data rate of the hard drive.	Auto	Configures PIO mode automatically
		0, 1, 2, 3, 4	Configures PIO mode manually
DMA mode	Defines the data transfer rate to and from the primary master drive. DMA mode must be enabled activated in the Windows Device Manager in order to guarantee maximum performance. This is only possible when manually setting up the drive.	Auto	Defines the transfer rate automatically
		Disabled	Defines the transfer rate manually
S.M.A.R.T.	Monitoring function for hard drives (Self-Monitoring, Analysis and Reporting Technology)	Auto	Detected and enabled automatically
		Enabled	Enables this function
		Disabled	Disables this function
32 bit data transfer	Enables 32-bit data transfer	Enabled	Enables this function
		Disabled	Disables this function

Table 155: 945GME Advanced - Primary IDE slave - Configuration options

1.4.8.3 Secondary IDE master

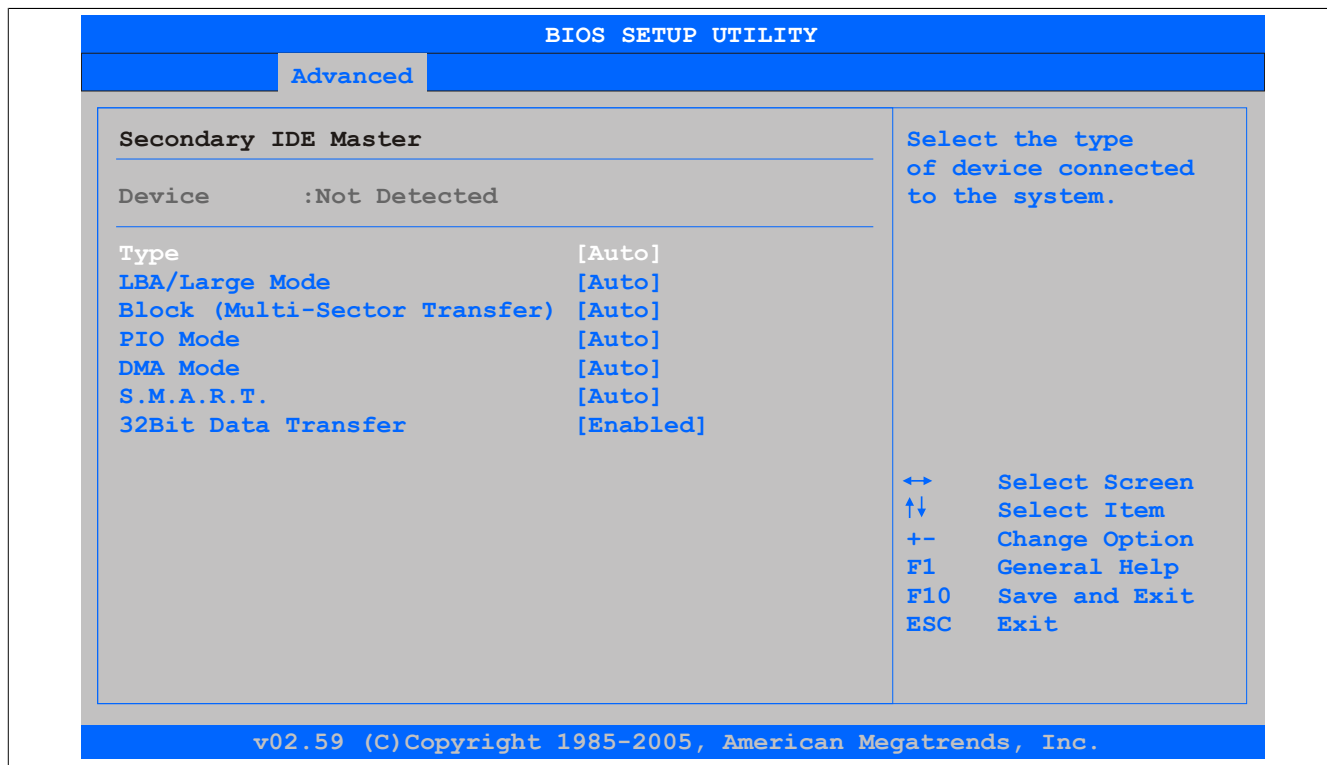

Figure 108: 945GME Secondary IDE Master

BIOS setting	Function	Configuration options	Effect
Type	Configures the type of drive connected to the primary master	Not installed	No drive installed
		Auto	Automatically detects the drive and configures the necessary values
		CD/DVD	CD/DVD drive
		ARMD	ARMD drive (zip drive)
LBA/Large mode	This option enables IDE logical block addressing / large mode.	Disabled	Disables this function
		Auto	Automatically enables this function if supported by the system
Block (multi-sector transfer)	This option enables block mode for IDE hard drives. If this option is enabled, the number of blocks per request is read from the configuration sector of the hard drive.	Disabled	Disables this function
		Auto	Automatically enables this function if supported by the system
PIO mode	PIO mode determines the data rate of the hard drive.	Auto	Configures PIO mode automatically
		0, 1, 2, 3, 4	Configures PIO mode manually
DMA mode	Defines the data transfer rate to and from the primary master drive. DMA mode must be enabled activated in the Windows Device Manager in order to guarantee maximum performance. This is only possible when manually setting up the drive.	Auto	Defines the transfer rate automatically
		Disabled	Defines the transfer rate manually
S.M.A.R.T.	Monitoring function for hard drives (Self-Monitoring, Analysis and Reporting Technology)	Auto	Detected and enabled automatically
		Enabled	Enables this function
		Disabled	Disables this function
32 bit data transfer	Enables 32-bit data transfer	Enabled	Enables this function
		Disabled	Disables this function

Table 156: 945GME Advanced - Secondary IDE master - Configuration options

1.4.8.4 Secondary IDE slave

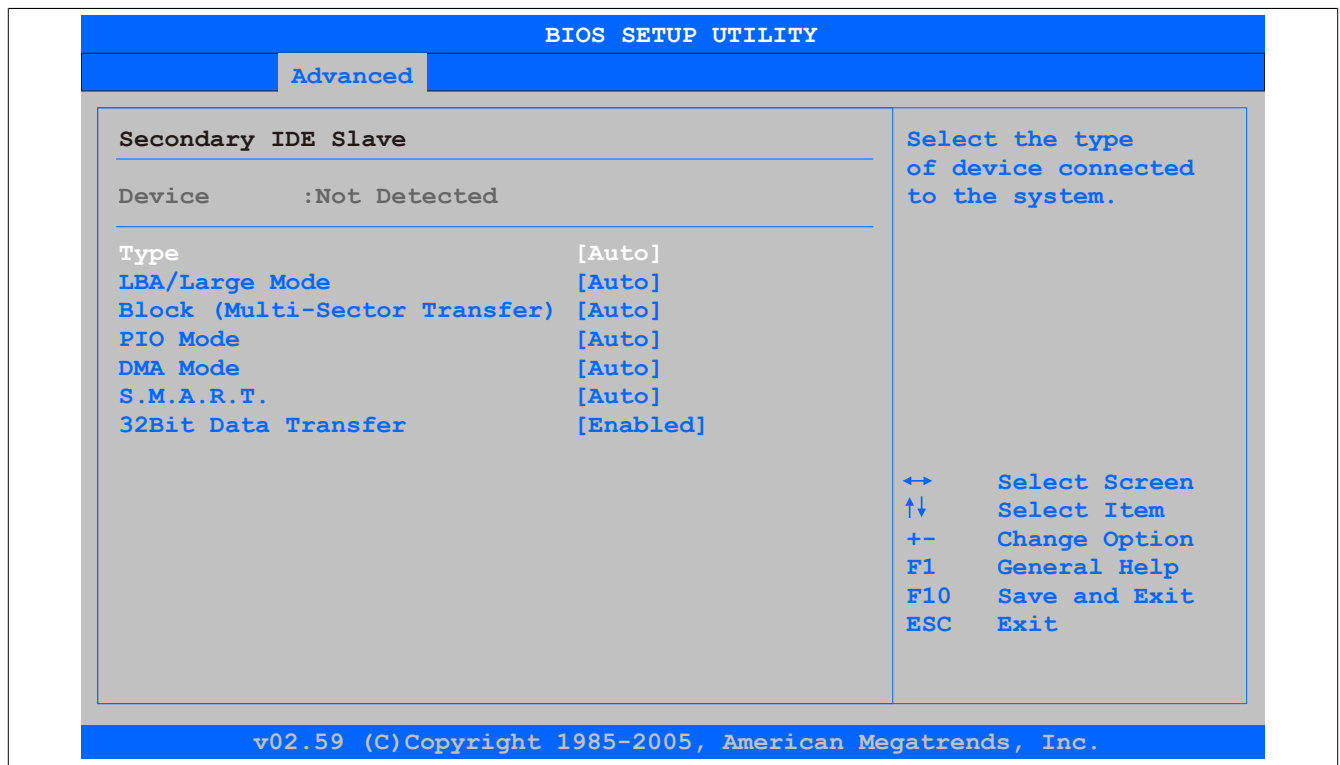

Figure 109: 945GME Secondary IDE Slave

BIOS setting	Function	Configuration options	Effect
Type	Configures the type of drive connected to the primary master	Not installed	No drive installed
		Auto	Automatically detects the drive and configures the necessary values
		CD/DVD	CD/DVD drive
		ARMD	ARMD drive (zip drive)
LBA/Large mode	This option enables IDE logical block addressing / large mode.	Disabled	Disables this function
		Auto	Automatically enables this function if supported by the system
Block (multi-sector transfer)	This option enables block mode for IDE hard drives. If this option is enabled, the number of blocks per request is read from the configuration sector of the hard drive.	Disabled	Disables this function
		Auto	Automatically enables this function if supported by the system
PIO mode	PIO mode determines the data rate of the hard drive.	Auto	Configures PIO mode automatically
		0, 1, 2, 3, 4	Configures PIO mode manually
DMA mode	Defines the data transfer rate to and from the primary master drive. DMA mode must be enabled activated in the Windows Device Manager in order to guarantee maximum performance. This is only possible when manually setting up the drive.	Auto	Defines the transfer rate automatically
		Disabled	Defines the transfer rate manually
S.M.A.R.T.	Monitoring function for hard drives (Self-Monitoring, Analysis and Reporting Technology)	Auto	Detected and enabled automatically
		Enabled	Enables this function
		Disabled	Disables this function
32 bit data transfer	Enables 32-bit data transfer	Enabled	Enables this function
		Disabled	Disables this function

Table 157: 945GME Advanced - Secondary IDE slave - Configuration options

1.4.9 USB configuration

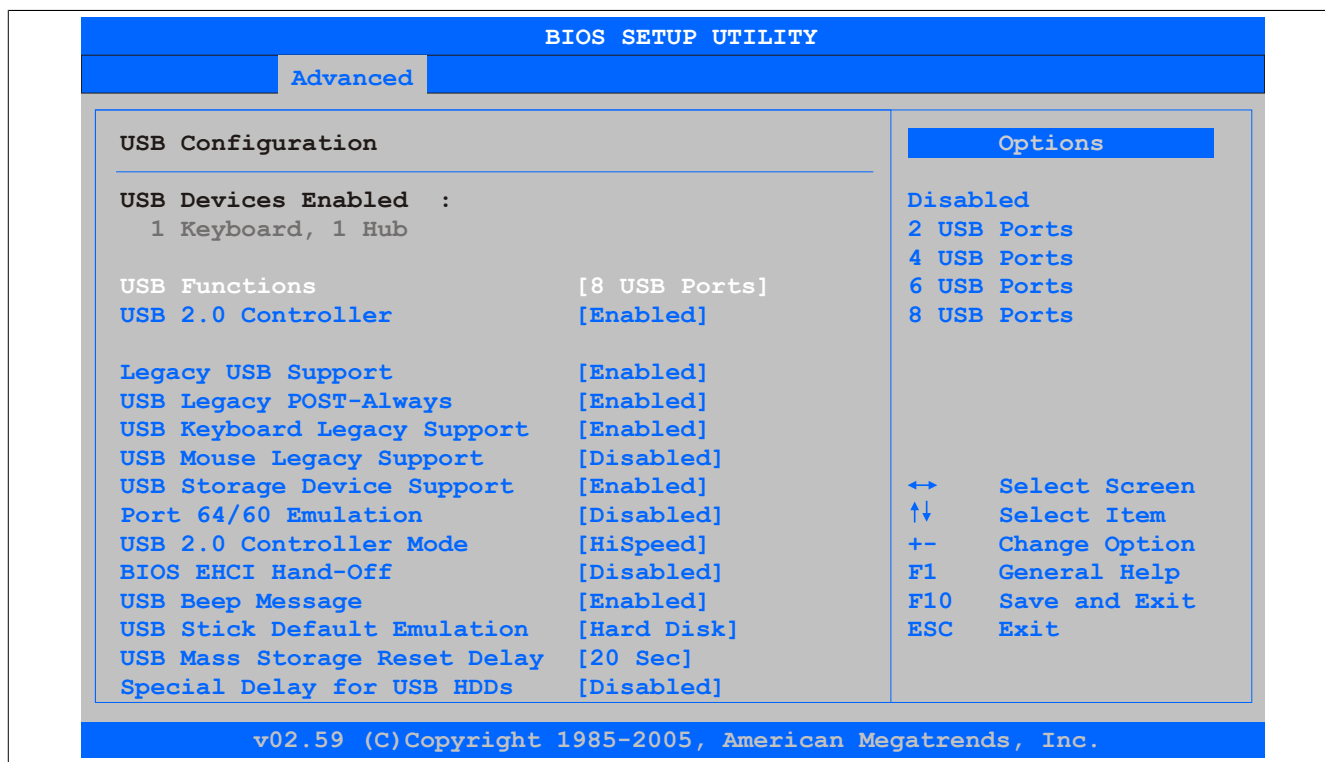

Figure 110: 945GME Advanced USB Configuration

BIOS setting	Function	Configuration options	Effect
USB function	Enables/Disables USB ports USB numbers (USB1, USB3, etc.) are printed on the PPC800 housing.	Disabled	Disables the USB port
		2 USB ports	Enables USB1 and USB3
		4 USB ports	Enables USB1, USB2, USB3 and USB4
		6 USB ports	Enables USB1, USB2, USB3, USB4 and USB5
		8 USB ports	Enables USB1, USB2, USB3, USB4, USB5 and USB on an AP via SDL
USB 2.0 controller	Option for enabling or disabling USB 2.0 mode	Enabled	Uses USB 2.0 for all USB ports
		Disabled	Uses USB 1.1 for all USB ports
Legacy USB support	Enables/Disables Legacy USB support USB ports do not function during startup. USB support is available again after the operating system has started. A USB keyboard is still recognized during POST.	Enabled	Enables this function
		Disabled	Disables this function
		Auto	Automatic enabling
USB Legacy POST-always	Option to enable Legacy USB support during POST (power-on self test) regardless of the setting made for Legacy USB support	Enabled	Allows BIOS Setup to be opened during POST using a USB keyboard
		Disabled	Disables this function
USB keyboard Legacy support	Enables/Disables USB keyboard support	Enabled	Enables this function
		Disabled	Disables this function
USB mouse Legacy support	Enables/Disables USB mouse support	Enabled	Enables this function
		Disabled	Disables this function
USB storage device support	Enables/Disables USB mass storage device support	Enabled	Enables this function
		Disabled	Disables this function
Port 64/60 emulation	Enables/Disables port 64/60 emulation	Enabled	Allows USB keyboard functionality in Windows NT
		Disabled	Allows USB keyboard functionality on all systems except Windows NT
USB 2.0 controller mode	Configures the USB controller	Full speed	12 MBps
		Hi speed	480 MBps
BIOS EHCI hand-off	Allows support for operating systems to be set up without the fully automatic EHCI function	Enabled	Enables this function
		Disabled	Disables this function
USB beep message	Option for emitting a tone each time a USB device is detected by BIOS during POST	Enabled	Enables this function
		Disabled	Disables this function
USB stick default emulation	Configures how a USB device is to be used	Auto	USB devices with less than 530 MB of memory are simulated as floppy disk drives. Devices with larger memory capacity are simulated as hard drives.
		Hard disk drive	An HDD-formatted drive can be used as an FDD (e.g. zip drive) to start the system.

Table 158: 945GME Advanced - USB configuration - Configuration options

BIOS setting	Function	Configuration options	Effect
USB mass storage reset delay	Option for configuring the time that POST waits for USB memory storage devices after the device start command is issued Information: The message "No USB mass storage device detected" is displayed if a USB memory device has not been installed.	10 sec, 20 sec, 30 sec, 40 sec	Sets the value manually
Special delay for USB HDDs	Option for setting a boot delay prior to counting the number of USB 2.0 devices in order to allow more time for USB devices that generally take longer to boot (e.g. USB hard disks) Information: This option should only be used if absolutely necessary; otherwise, it would unnecessarily extend the boot procedure by the configured time.	Disabled 1 sec, 2 sec, 3 sec, 4 sec, 5 sec, 7 sec, 10 sec	Disables this function. Doesn't add a boot delay. Adds a boot delay of 1, 2, 3, 4, 5, 7 or 10 seconds

Table 158: 945GME Advanced - USB configuration - Configuration options

1.4.10 Keyboard/Mouse configuration

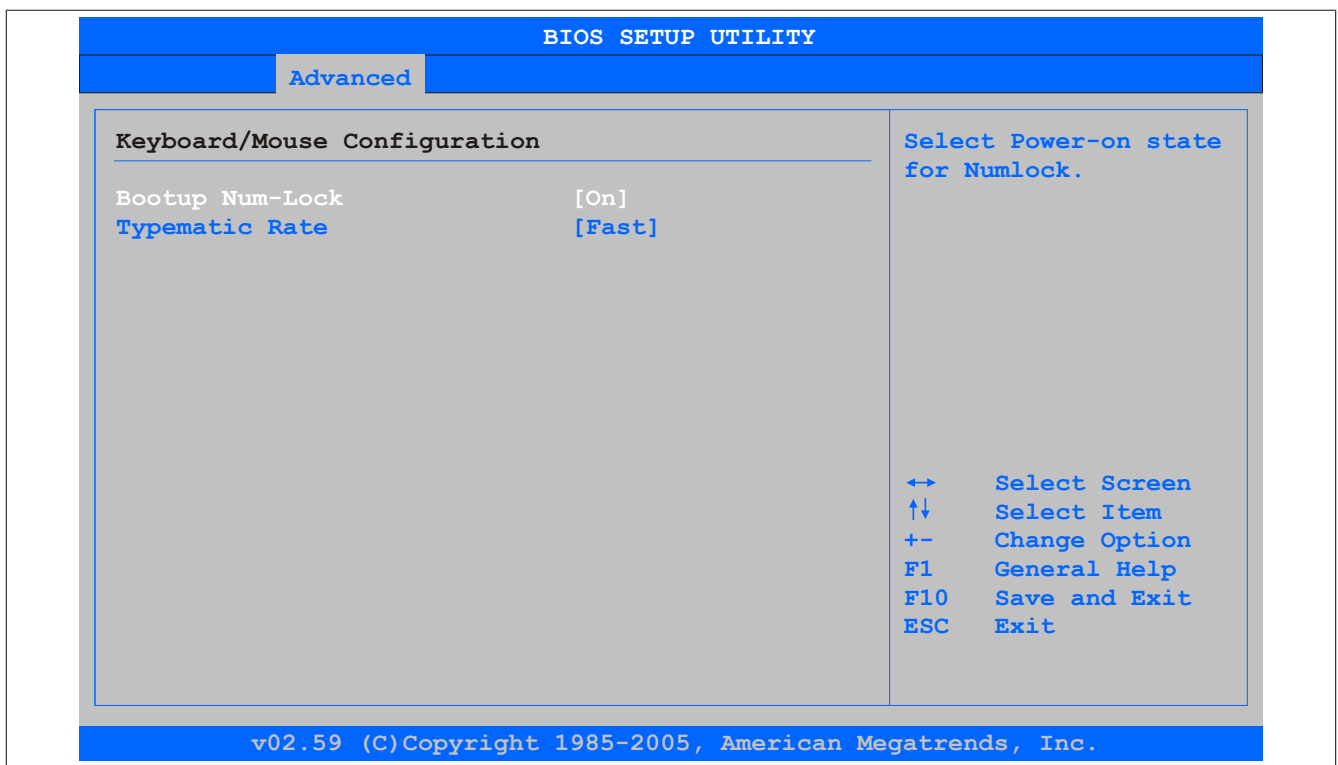

Figure 111: 945GME Advanced Keyboard/Mouse Configuration

BIOS setting	Function	Configuration options	Effect
Bootup Num-lock	Defines the state of the NumLock key on the numeric keypad when booting	Off	Only enables the cursor (movement) functions of the numeric keypad
		On	Enables the numeric keypad
Typematic rate	Configures the key repeat function	Slow	Slow key repeat
		Fast	Fast key repeat

Table 159: 945GME Advanced - Keyboard/Mouse configuration - Configuration options

1.4.11 Remote access configuration

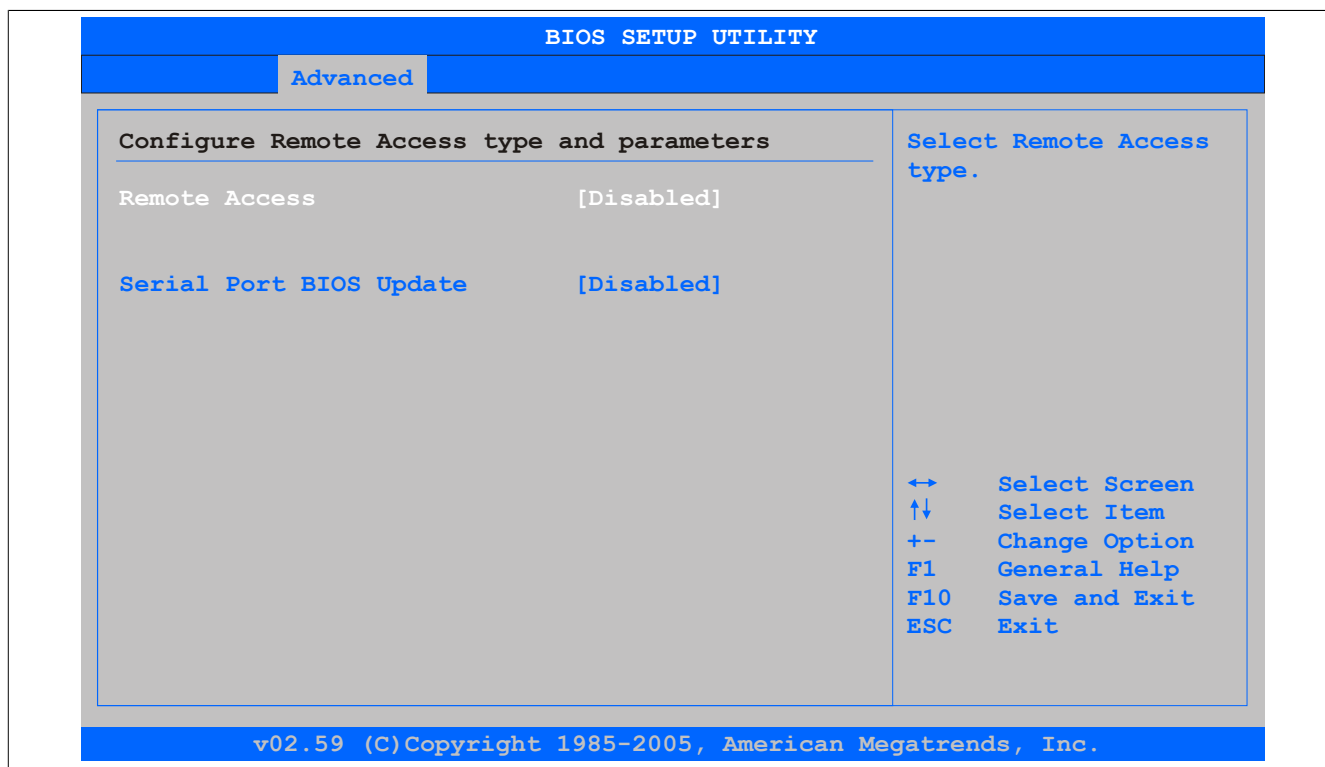

Figure 112: 945GME Advanced Remote Access Configuration

BIOS setting	Function	Configuration options	Effect
Remote access	Enables/Disables the remote access function	Enabled	Enables this function
		Disabled	Disables this function
Serial port number	This option is used to configure the serial interface as long as <i>Remote access</i> is not set to "Disabled".	COM1	Enables the COM1 interface as a remote access interface
		COM2	Enables the COM2 interface as a remote access interface
Base address, IRQ	Displays the logical address and interrupt for the serial port as <i>Remote access</i> is not set to "Disabled".	None	-
Serial port mode	Defines the serial port transfer rate as long as <i>Remote access</i> is not set to "Disabled".	115200 8,n,1 57600 8,n,1 38400 8,n,1 19200 8,n,1 09600 8,n,1	Sets the value manually
Flow control	Determines how the transfer is controlled via the interface Information: The setting must be the same on the terminal and the server.	None	Operates the interface without transfer control
		Hardware	Uses hardware for interface transfer control. This mode must be supported by the cable.
		Software	Uses software for interface transfer control
Redirection After BIOS POST	Configures redirection after startup as long as <i>Remote access</i> is not set to "Disabled"	Disabled	Disables redirection after startup
		Boot loader	Enables redirection during system startup and when charging
		Always	Keeps redirection enabled permanently
Terminal type	Configures the type of connection as long as <i>Remote access</i> is not set to "Disabled".	ANSI, VT100, VT-UTF8	Configures the connection type manually
		Enabled	Enables this function
VT-UTF8 combo key support	This option can be used to enable VT-UTF8 combo key support for ANSI and VT100 interfaces as long as <i>Remote access</i> is not set to "Disabled".	Disabled	Disables this function
		No delay	No delay
Sredir memory display delay	This option can be used to set the memory output delay as long as <i>Remote access</i> is not set to "Disabled" (Sredir -> serial redirection).	Delay 1 sec, Delay 2 sec, Delay 4 sec	Sets the value manually
		Enabled	Enables this function
		Disabled	Disables this function
Serial port BIOS update	Loads updates to the processor via the serial interface during system startup Information: Disabling this option reduced the boot time.	Enabled	Enables this function
		Disabled	Disables this function

Table 160: 945GME Advanced - Remote access configuration - Configuration options

1.4.12 CPU board monitor

Information:

The voltage values (e.g. core voltage, battery voltage) displayed on this BIOS Setup screen represent uncalibrated values for informational purposes. They cannot be used to draw any conclusions about hardware alarms or error conditions. The hardware components used have automatic diagnostic functions that can be applied in the event of error.

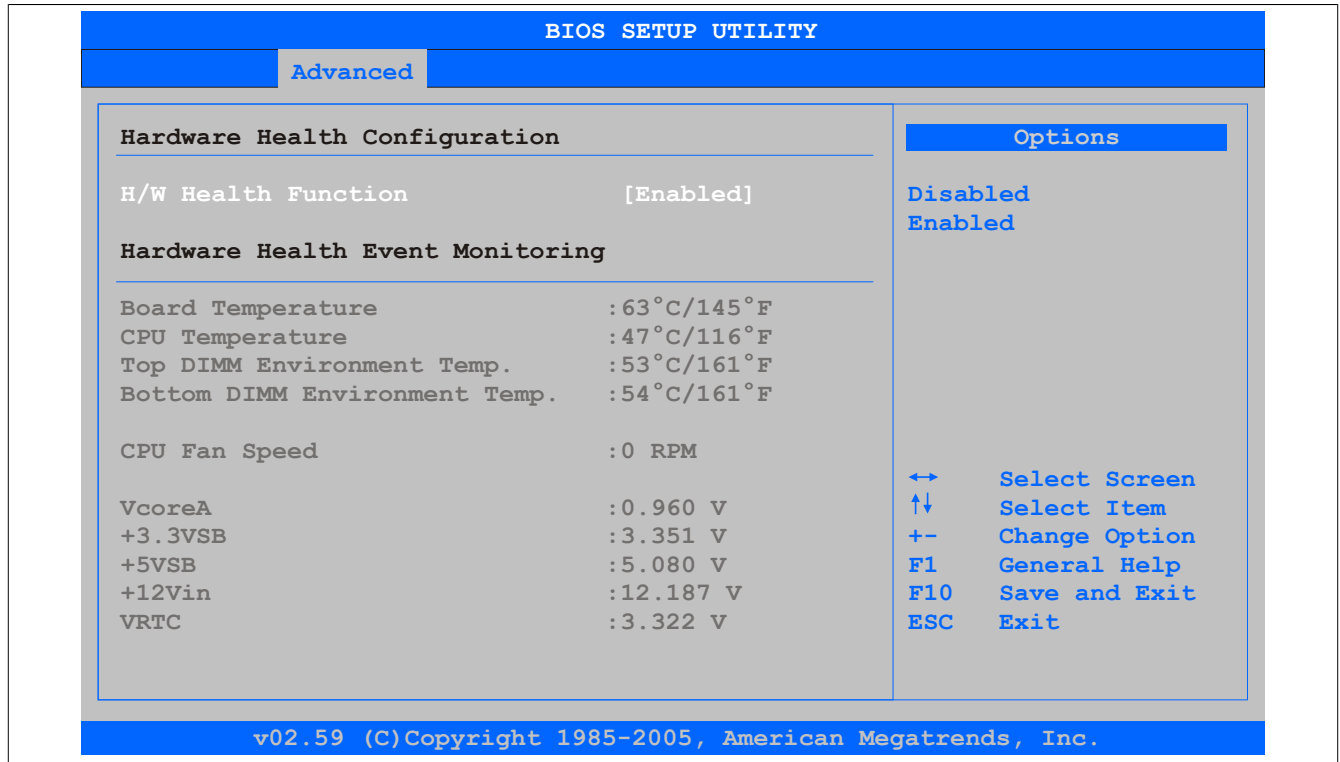

Figure 113: 945GME Advanced CPU Board Monitor

BIOS setting	Function	Configuration options	Effect
H/W health function	Option for displaying all values on this screen	Enabled	Displays all values
		Disabled	Displays no value on this screen
Board temperature	Displays the board temperature in degrees Celsius and Fahrenheit	None	-
CPU temperature	Displays the processor's temperature (in degrees Celsius and Fahrenheit)	None	-
Top DIMM environment temp.	Displays the temperature of the first DRAM module	None	-
Bottom DIMM environment temp.	Displays the temperature of the second DRAM module	None	-
CPU fan speed	Displays the speed of the processor fan	None	-
VcoreA	Displays the processor core voltage A in volts	None	-
+3.3VSB	Displays the current voltage of the 3.3 volt supply	None	-
+5VSB	Displays the current voltage of the 5 volt supply	None	-
+12Vin	Displays the current voltage of the 12 volt supply	None	-
VRTC	Displays the battery voltage in volts	None	-

Table 161: 945GME Advanced - CPU board monitor - Configuration options

1.4.13 Baseboard/Panel features

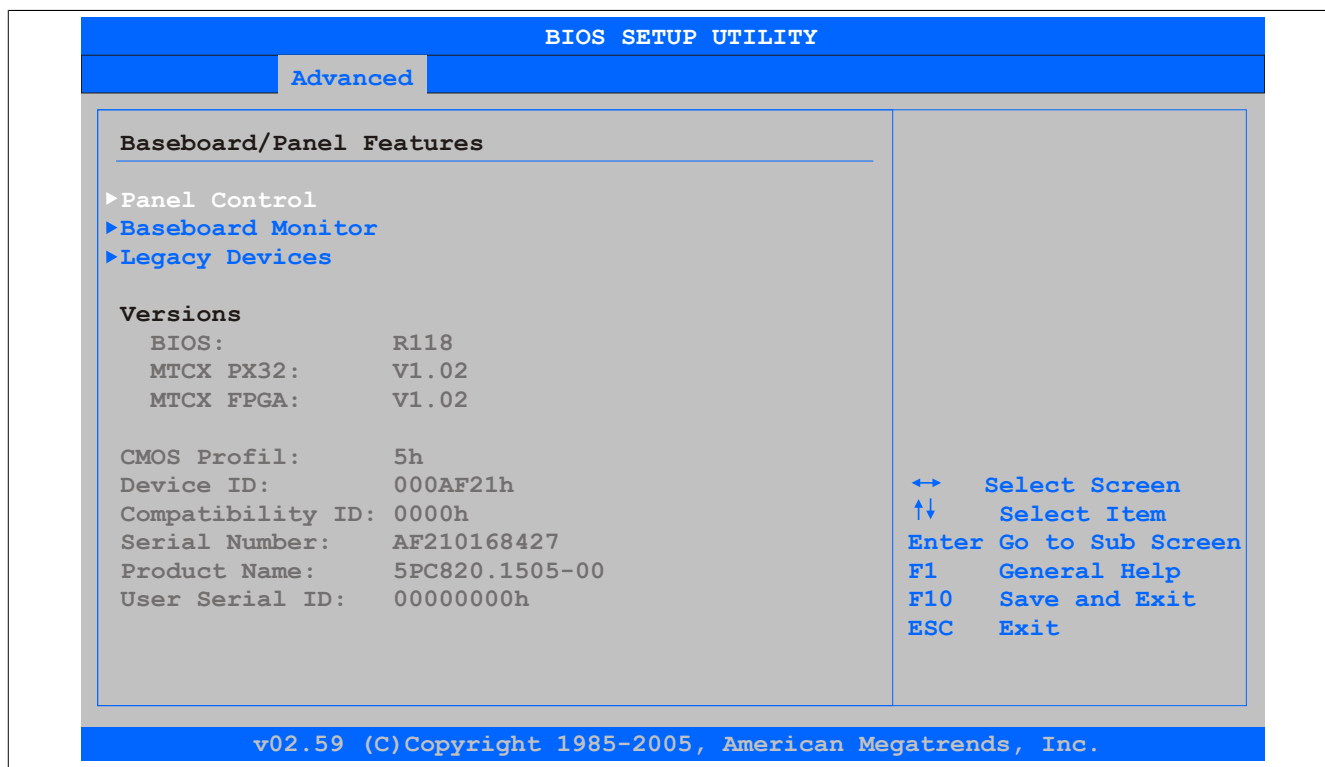

Figure 114: 945GME Advanced Baseboard/Panel Features

BIOS setting	Function	Configuration options	Effect
Panel control	Configures special settings for connected panels (display units)	Enter	Opens the submenu see "Panel control" on page 209
Baseboard monitor	Displays various temperatures and fan speeds	Enter	Opens the submenu see "Baseboard monitor" on page 210
Legacy devices	Configures special settings for interfaces	Enter	Opens the submenu see "Legacy devices" on page 211
BIOS	Displays the BIOS version	None	-
MTCX PX32	Displays the MTCX PX32 firmware version	None	-
MTCX FPGA	Displays the MTCX FPGA firmware version	None	-
CMOS profile	Displays the CMOS profile number	None	-
Device ID	Displays the hexadecimal value of the hardware device ID	None	-
Compatibility ID	Displays the version of the device within the same B&R device ID. This ID is needed for Automation Runtime.	None	-
Serial number	Displays the B&R serial number	None	-
Product name	Displays the B&R model number	None	-
User serial ID	Displays the user serial ID. This 8-digit hexadecimal value can be freely specified by the user (e.g. to give the device a unique ID) and can only be changed using the "B&R Control Center" included with the ADI driver.	None	-

Table 162: 945GME Advanced - Baseboard/Panel features - Configuration options

1.4.13.1 Panel control

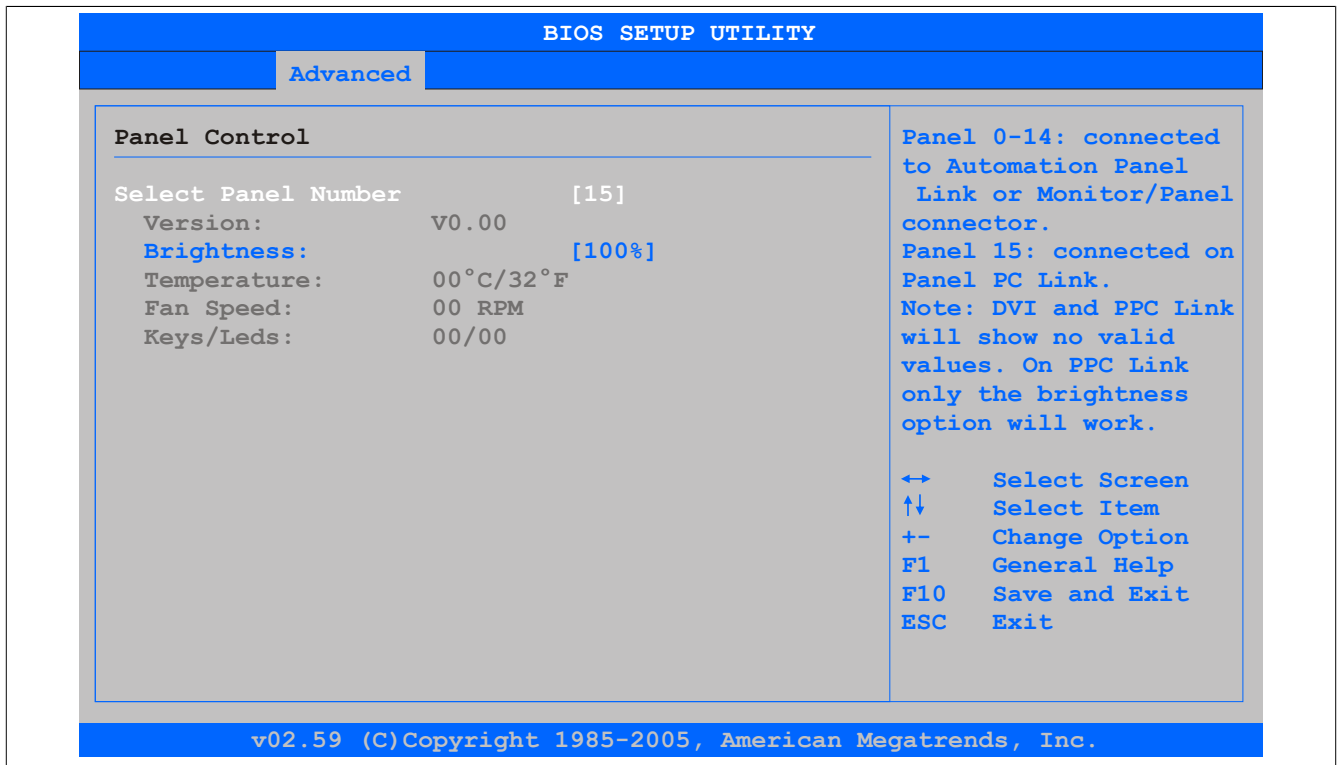

Figure 115: 945GME Panel Control

BIOS setting	Function	Configuration options	Effect
Select panel number	Selects the panel number for which the values should be displayed and/or changed	0...15	Selects panel 0-15
Version	Displays the firmware version of the SDLR controller	None	-
Brightness	Sets the brightness of the selected panel	0%, 10%, 20%, 30%, 40%, 50%, 60%, 70%, 80%, 90%, 100%	Sets the brightness (in %) of the selected panel. Changes are effective immediately.
Temperature	Displays the selected panel's temperature in degrees Celsius and Fahrenheit	None	-
Fan speed	Displays the fan speed for the selected panel	None	-
Keys/LEDs	Displays the available keys and LEDs on the selected panel	None	-

Table 163: 945GME Advanced - Panel control - Configuration options

1.4.13.2 Baseboard monitor

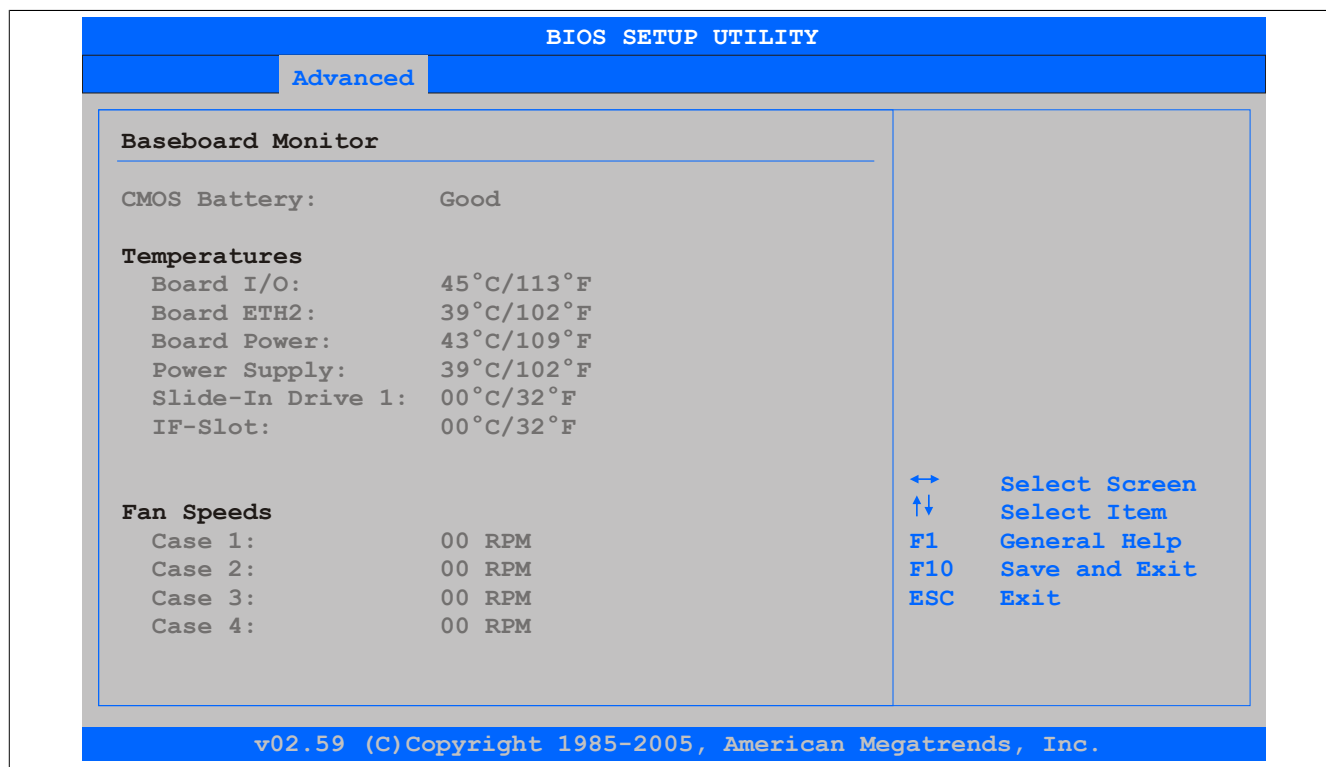

Figure 116: 945GME Baseboard Monitor

BIOS setting	Function	Configuration options	Effect
CMOS battery	Displays the battery status n.a. - Not available Good - Battery OK Bad - Battery not OK	None	-
Board I/O	Displays the temperature in the I/O area in degrees Celsius and Fahrenheit	None	-
Board ETH2	Displays the temperature in the ETH2 controller chip area in degrees Celsius and Fahrenheit	None	-
Board power	Displays the power supply temperature in degrees Celsius and Fahrenheit	None	-
Power supply	Displays the temperature in the power supply in degrees Celsius and Fahrenheit	None	-
Slide-in drive 1	Displays the temperature of slide-in drive 1 in degrees Celsius and Fahrenheit	None	-
IF slot	Displays the temperature of the IF slot in degrees Celsius and Fahrenheit	None	-
Case 1	Displays the speed of housing fan 1	None	-
Case 2	Displays the speed of housing fan 2	None	-
Case 3	Displays the speed of housing fan 3	None	-
Case 4	Displays the speed of housing fan 4	None	-

Table 164: 945GME Advanced - Baseboard monitor - Configuration options

1.4.13.3 Legacy devices

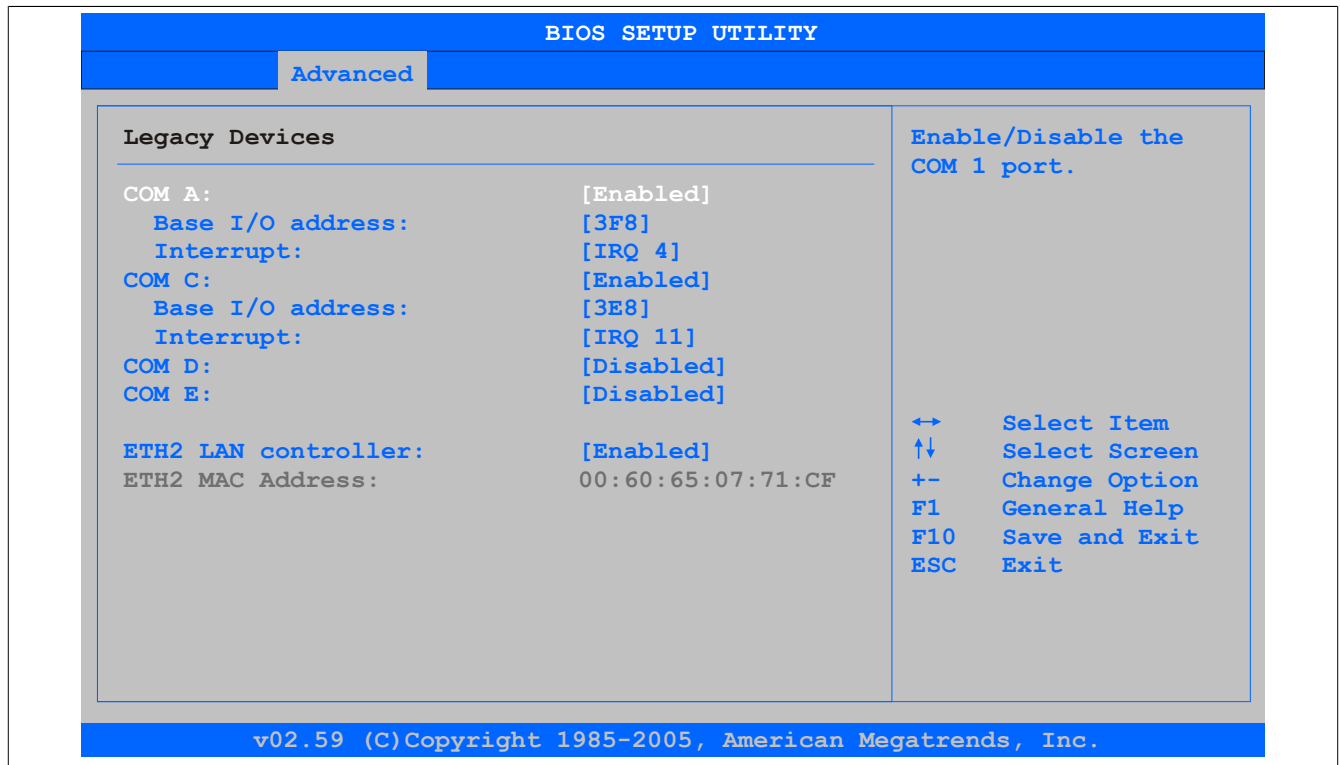

Figure 117: 945GME Legacy Devices

BIOS setting	Function	Configuration options	Effect
COM A	Settings for the COM1 serial interface	Enabled	Enables the interface
		Disabled	Disables the interface
Base I/O address	Selects the base I/O address of the COM port	238, 2E8, 2F8, 328, 338, 3E8, 3F8	Assigns the selected base I/O address
Interrupt	Selects the interrupt for the COM port	IRQ 3, IRQ 4, IRQ 5, IRQ 6, IRQ 7, IRQ 10, IRQ 11, IRQ 12	Assigns the selected interrupt
COM C	Sets the COM port for the touch screen connected to the monitor/panel interface	Enabled	Enables the interface
		Disabled	Disables the interface
Base I/O address	Selects the base I/O address of the COM port	238, 2E8, 2F8, 328, 338, 3E8, 3F8	Assigns the selected base I/O address
Interrupt	Selects the interrupt for the COM port	IRQ 3, IRQ 4, IRQ 5, IRQ 6, IRQ 7, IRQ 10, IRQ 11, IRQ 12	Assigns the selected interrupt
COM D	Sets the COM port for the touch screen connected to the AP Link interface	Enabled	Enables the interface
		Disabled	Disables the interface
Base I/O address	Selects the base I/O address of the COM port	238, 2E8, 2F8, 328, 338, 3E8, 3F8	Assigns the selected base I/O address
Interrupt	Selects the interrupt for the COM port	IRQ 3, IRQ 4, IRQ 5, IRQ 6, IRQ 7, IRQ 10, IRQ 11, IRQ 12	Assigns the selected interrupt
COM E	Configures the COM port of the B&R add-on interface	Enabled	Enables the interface
		Disabled	Disables the interface
Base I/O address	Selects the base I/O address of the COM port	238, 2E8, 2F8, 328, 338, 3E8, 3F8	Assigns the selected base I/O address
Interrupt	Selects the interrupt for the COM port	IRQ 3, IRQ 4, IRQ 5, IRQ 6, IRQ 7, IRQ 10, IRQ 11, IRQ 12	Assigns the selected interrupt
Interrupt	Selects the interrupt for the CAN port	IRQ 10, NMI	Assigns the selected interrupt
ETH2 LAN controller	Option for turning the onboard LAN controller (ETH2) on and off	Enabled	Enables the controller
		Disabled	Disables the controller
ETH2 MAC address	Displays the MAC address of the Ethernet 2 controller	None	-

Table 165: 945GME Advanced - Legacy devices - Configuration options

1.5 Boot

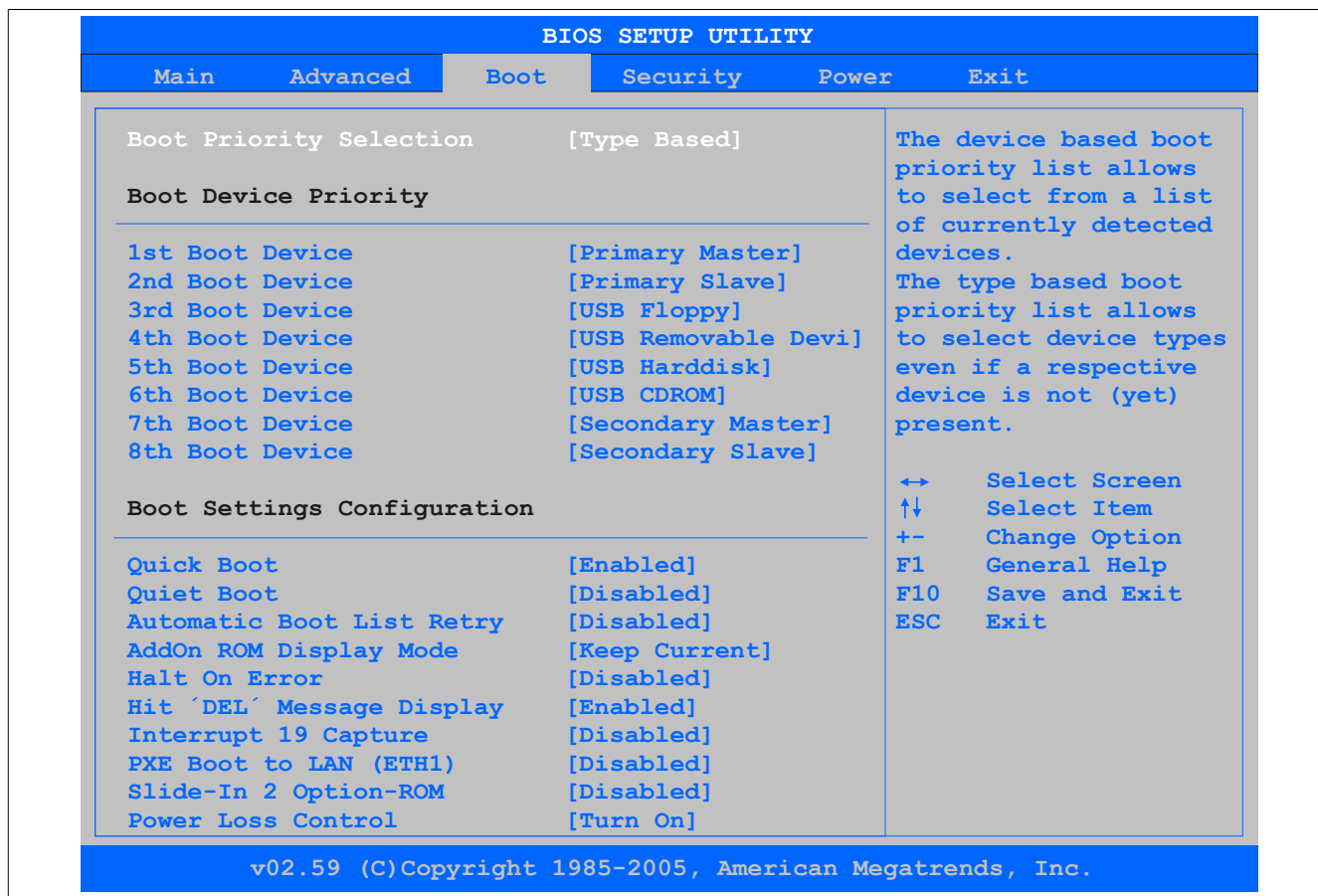

Figure 118: 945GME Boot Menü

BIOS setting	Function	Configuration options	Effect
Boot priority selection	Option for determining the method for how drives should be booted	Device based	Only lists devices that are recognized by the system. The order of devices in this list can be changed. Information: It is only possible to use either "Device based" or "Type based". Using both together is not permitted.
		Type based	The boot sequence of a device type list can be changed. It is also possible to add device types that are not connected to this list. Information: It is only possible to use either "Device based" or "Type based". Using both together is not permitted.
1st boot device	Option for selecting drives to be used for booting	Disabled, Primary master, Primary slave, Secondary master, Secondary slave, Legacy floppy, USB floppy, USB hard disk, USB CDROM, USB removable device, Onboard LAN, External LAN, PCI mass storage, PCI SCSI card, Any PCI BEV device, Third master, Third slave, PCI RAID, Local BEV ROM	Specifies the desired boot sequence
2nd boot device			
3rd boot device			
4th boot device			
5th boot device			
6th boot device			
7th boot device			
8th boot device			
Quick boot	This function reduces the boot time by skipping some POST procedures.	Enabled Disabled	Enables this function Disables this function
Quiet boot	Determines whether the POST message or the OEM logo (default = black background) is displayed	Enabled	Displays the OEM logo instead of the POST message
		Disabled	Displays the POST message
Automatic boot list retry	This option can be used to attempt to restart the operating system automatically if it fails to start the first time.	Enabled	Enables this function
		Disabled	Disables this function

Table 166: 945GME Boot menu - Configuration options

BIOS setting	Function	Configuration options	Effect
Add-on ROM display mode	Sets the display mode for the ROM (during the booting procedure)	Force BIOS	Displays an additional part of BIOS
		Keep current	Displays BIOS information
Halt on error	This option determines the system should resume after a startup error during POST.	Enabled	Pauses the system. The system pauses each time an error occurs.
		Disabled	Does not pause the system. All errors are ignored.
Hit 'DEL' message display	Configures settings for the "Hit 'DEL'" message	Enabled	Displays the message
		Disabled	Does not display the message
	Information: The message is not displayed if "Quiet boot" is enabled.		
Interrupt 19 capture	This function can be used to include BIOS interruptions.	Enabled	Enables this function
		Disabled	Disables this function
PXE boot to LAN (ETH1)	Enables/disables the function to boot from LAN (ETH1)	Enabled	Enables this function
		Disabled	Disables this function
Slide-in 2 optional ROM	Enables/Disables optional ROM for a slide-in 2 drive	Enabled	Enables this function
		Disabled	Disables this function
Power loss control	Specifies whether the system should be on/off following power loss	Remain off	System remains off
		Turn on	System powered on
		Last state	Enables the previous state

Table 166: 945GME Boot menu - Configuration options

1.6 Security

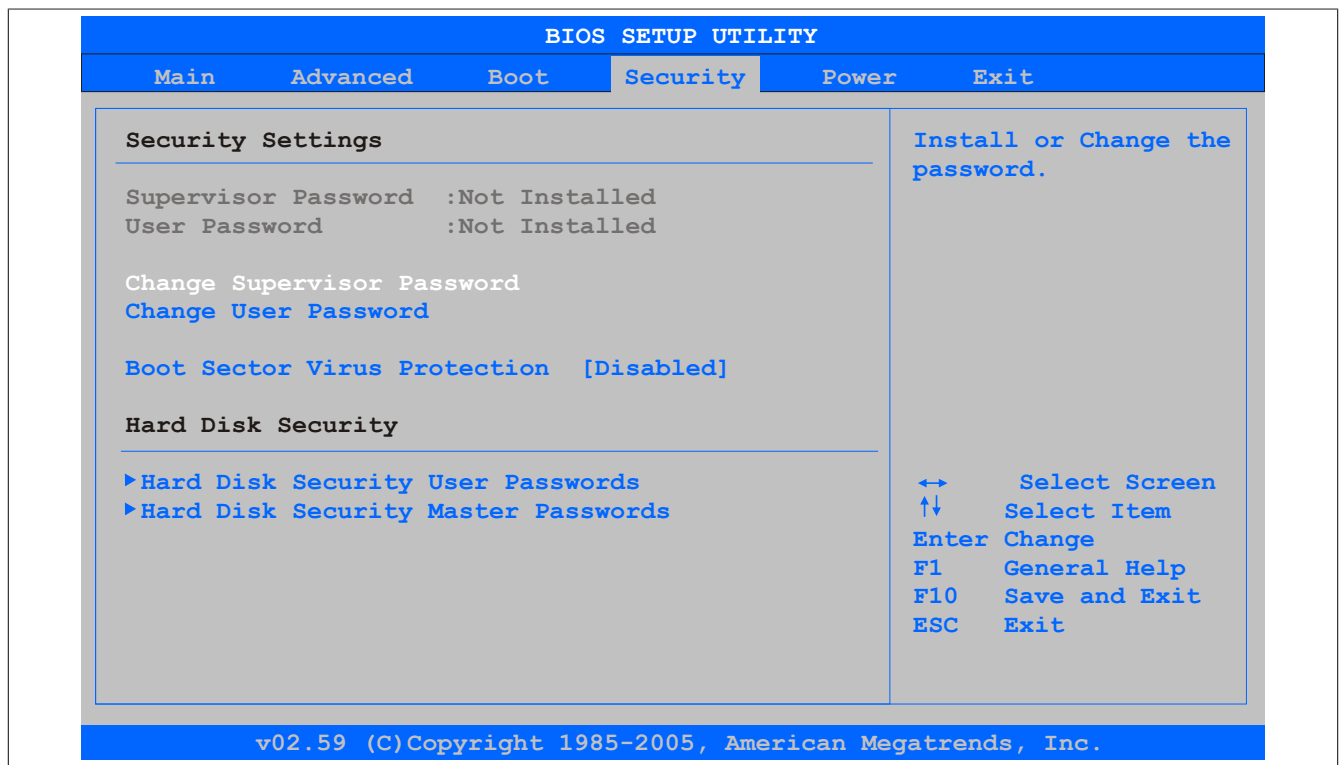

Figure 119: 945GME Security Menü

BIOS setting	Function	Configuration options	Effect
Supervisor password	Displays whether a supervisor password has been set	None	-
User password	Displays whether a user password has been set	None	-
Change supervisor password	Function for entering/changing a supervisor password. A supervisor password is necessary to edit all BIOS settings.	Enter	Password entry
Change user password	Function for entering/changing a user password. The user password allows the user to edit only certain BIOS settings.	Enter	Password entry

Table 167: 945GME Security menu - Configuration options

BIOS setting	Function	Configuration options	Effect
Boot sector virus protection	This option is used to issue a warning when the boot sector is accessed by a program or virus. Information: This option only protects the boot sector, not the entire hard drive.	Enabled	Enables this function
		Disabled	Disables this function
Hard disk security user passwords	Creates the hard disk security user password	Enter	Opens the submenu see "Hard disk security user password" on page 214
Hard disk security master passwords	Creates the hard disk security master password	Enter	Opens the submenu see "Hard disk security master password" on page 215

Table 167: 945GME Security menu - Configuration options

1.7 Hard disk security user password

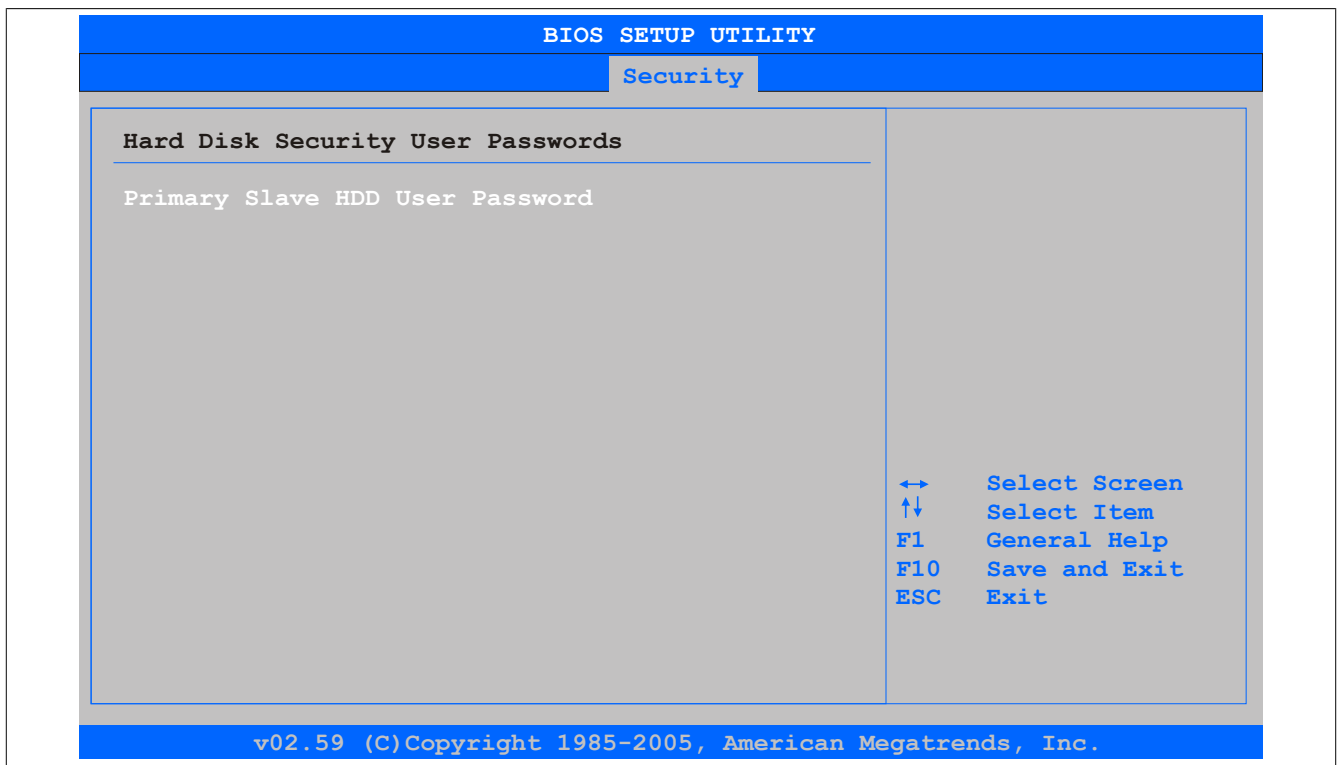

Figure 120: 945GME Hard Disk Security User Password

BIOS setting	Function	Configuration options	Effect
Primary slave HDD user password	This function makes it possible to configure or change the user password for each hard drive without having to reboot the device. The user password allows the user to edit only certain BIOS settings.	Enter	Password entry

Table 168: 945GME Security - Hard disk security user password

1.8 Hard disk security master password

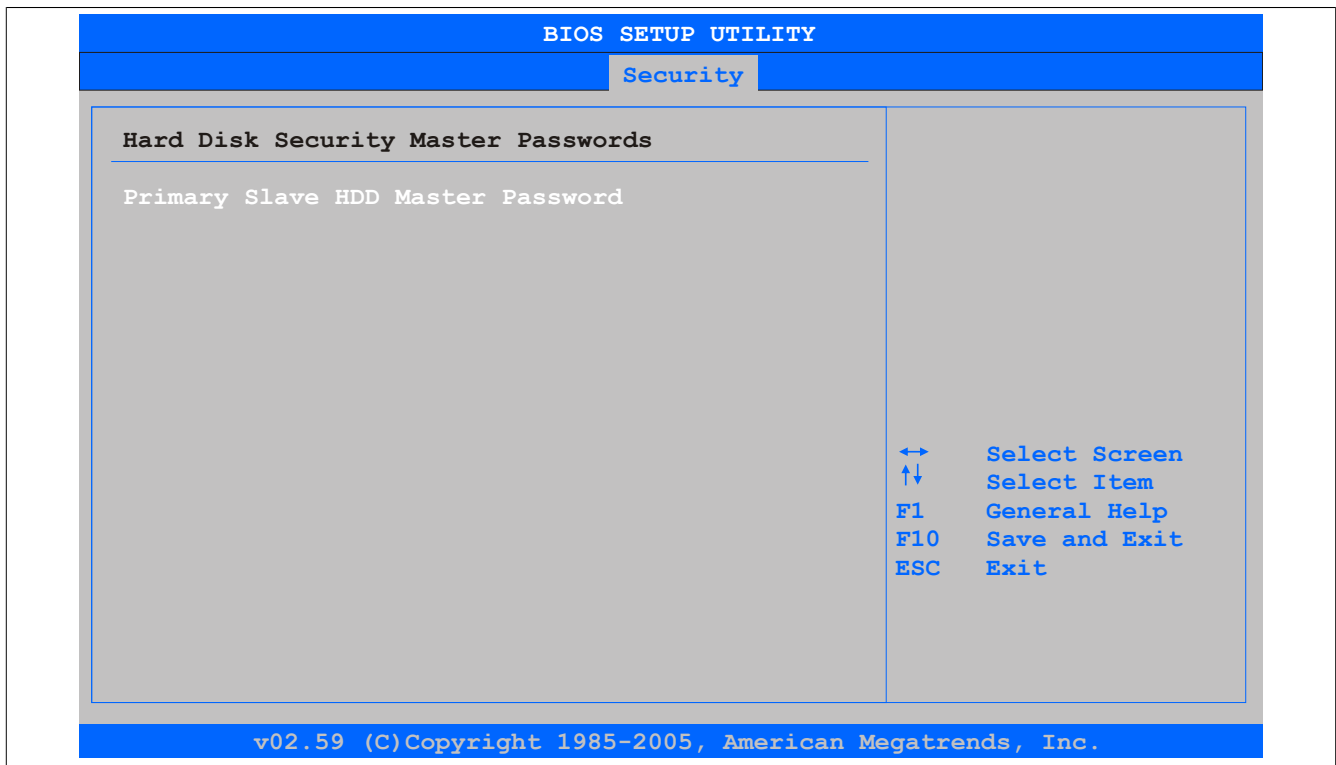

Figure 121: 945GME Hard Disk Security Master Password

BIOS setting	Function	Configuration options	Effect
Primary slave HDD master password	This function makes it possible to configure or change the master password for each hard drive without having to reboot the device.	Enter	Password entry

Table 169: 945GME Security - Hard disk security master password

1.9 Power

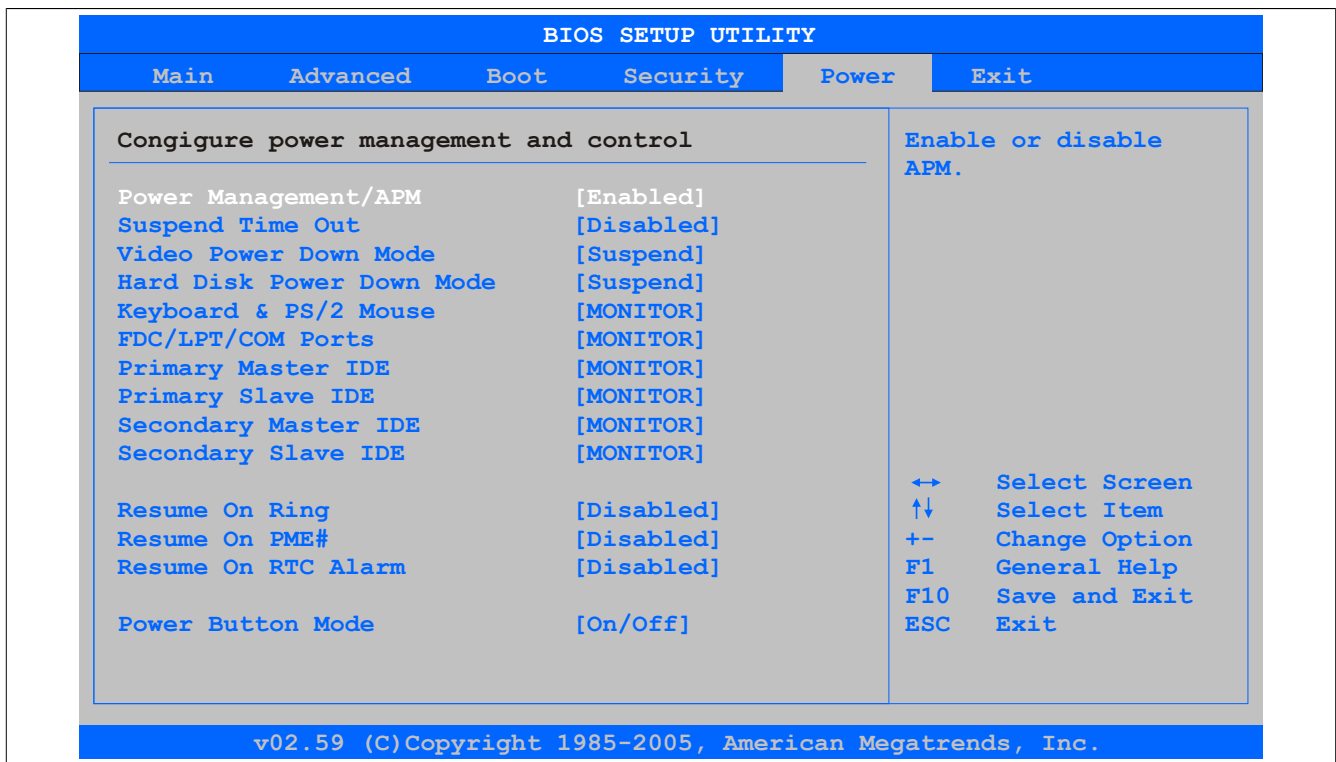

Figure 122: 945GME Power Menü

BIOS setting	Function	Configuration options	Effect
Power Management / APM	This option enables or disables APM functionality. This is advanced plug and play and power management functionality.	Enabled	Enables this function
		Disabled	Disables this function
Suspend time out	This option can be used to configure how long the system must be inactive before entering suspend mode (all components except the CPU are shut down as far as possible).	1 min, 2 min, 4 min, 8 min, 10 min, 20 min, 30 min, 40 min, 50 min, 60 min	Sets the value manually
		Disabled	Disables this function
Video power down mode	This option can be used to set the energy saving mode for the monitor.	Disabled	Does not switch off the monitor
		Standby	Switches the monitor to standby mode
		Suspend	Switches the monitor to suspend mode
Hard disk power down mode	This option is used to set the energy saving mode for the hard drive.	Disabled	Does not switch off the monitor
		Standby	Switches the monitor to standby mode
		Suspend	Switches the monitor to suspend mode
Keyboard & PS/2 mouse	Configures the monitoring of activity during energy saving mode	MONITOR	Returns the system to its normal state from the respective energy saving mode when activity is detected on the keyboard or PS/2 mouse
		IGNORE	Ignores activity
FDC/LPT/COM ports	Configures the monitoring of activity during energy saving mode	MONITOR	Returns the system to its normal state from the respective energy saving mode when activity is detected on the parallel port, serial port 1&2 or the floppy drive port.
		IGNORE	Ignores activity
Primary master IDE	Configures the monitoring of activity during energy saving mode	MONITOR	Returns the system to its normal state from the respective energy saving mode when activity is detected on the IRQ of the respective interface or device
		IGNORE	Ignores activity
Primary slave IDE	Configures the monitoring of activity during energy saving mode	MONITOR	Returns the system to its normal state from the respective energy saving mode when activity is detected on the IRQ of the respective interface or device
		IGNORE	Ignores activity
Secondary master IDE	Configures the monitoring of activity during energy saving mode	MONITOR	Returns the system to its normal state from the respective energy saving mode when activity is detected on the IRQ of the respective interface or device
		IGNORE	Ignores activity
Secondary slave IDE	Configures the monitoring of activity during energy saving mode	MONITOR	Returns the system to its normal state from the respective energy saving mode when activity is detected on the IRQ of the respective interface or device
		IGNORE	Ignores activity
Resume on ring	Returns the PC from energy saving mode when the modem receives an incoming call	Enabled	Enables this function
		Disabled	Disables this function
Resume on PME#	Configures whether the PME wakeup function is enabled or disabled	Enabled	Enables this function
		Disabled	Disables this function
Resume on RTC alarm	This option can be used to enable the alarm and enter the date and time during system startup.	Enabled	Enables this function
		Disabled	Disables this function
Power button mode	This function determines what the power button does.	On/Off	Switches the system on/off
		Suspend	Suppresses this function

Table 170: 945GME Power menu - Configuration options

1.10 Exit

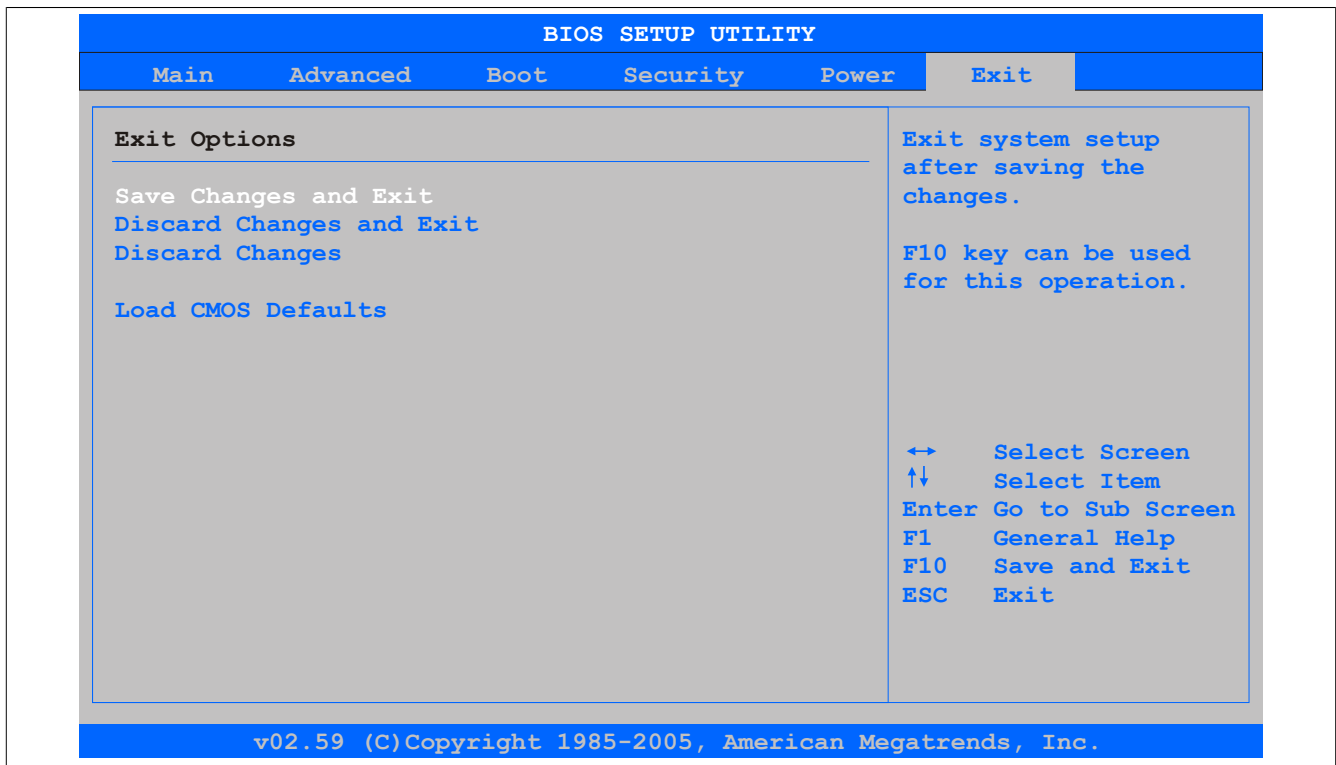

Figure 123: 945GME Exit Menü

BIOS setting	Function	Configuration options	Effect
Save changes and exit	Selecting this option closes BIOS Setup. Any changes made are saved to CMOS after confirmation, and the system is rebooted.	OK / Cancel	
Discard changes and exit	Selecting this option closes BIOS Setup without saving any changes made. The system is then rebooted.	OK / Cancel	
Discard changes	This option can be used to reset any settings that may have been made but have been forgotten in the meantime (provided they have not yet been saved).	OK / Cancel	
Load CMOS defaults	This option loads the CMOS default values defined by the DIP switch settings. These values are loaded for all BIOS settings.	OK / Cancel	

Table 171: 855GME (XTX) Exit menu - Configuration options

1.11 BIOS default settings

The various positions of the CMOS profile hex switch can be used to load predefined BIOS profile settings.

Information:

The factory default switch position represents the optimal BIOS default values for this system and should therefore not be changed.

If the "Load setup defaults" function is selected in the main BIOS Setup screen, or if "Exit" is selected (or <F9> is pressed) in the individual setup screens, the following BIOS settings are the optimized values that will be used.

Profile number	Optimized for	Switch position	Note
Profile 0	Reserved	0	
Profile 1	System unit 5PC810.SX01-00 / 5PC810.SX02-00 / 5PC810.SX03-00	1	The default settings for this profile can be found in the APC810 user's manual. This can be downloaded at no cost from the B&R website.
Profile 2	System unit 5PC810.SX05-00	2	
Profile 3	System unit 5PC820.SX01-00 / 5PC820.SX01-01	3	The default settings for this profile can be found in the APC820 user's manual. This can be downloaded at no cost from the B&R website.
Profile 4	Reserved	4	
Profile 5	System unit 5PC820.1505-00 / 5PC820.1906-00	5	The default settings for this profile can be found in the PPC800 user's manual. This can be downloaded at no cost from the B&R website.

Table 172: Profile overview

The following pages provide an overview of the BIOS default settings for the different CMOS profile switch positions. Settings highlighted in yellow are variations from the BIOS default profile (=profile 0).

1.11.1 Main

Setting/Option	Profile 0	Profile 5	My setting
System time	-	-	
System date	-	-	
BIOS ID	-	-	
Processor	-	-	
CPU frequency	-	-	
System memory	-	-	
Product revision	-	-	
Serial number	-	-	
BC firmware rev.	-	-	
MAC address (ETH1)	-	-	
Boot counter	-	-	
Running time	-	-	

Table 173: 945GME Main - Overview of profile settings

1.11.2 Advanced

1.11.2.1 ACPI configuration

Setting/Option	Profile 0	Profile 5	My setting
ACPI aware O/S	Yes	Yes	
ACPI version features	ACPI v2.0	ACPI v2.0	
ACPI APIC support	Enabled	Enabled	
Suspend mode	S1 (POS)	S1 (POS)	
USB device wakeup from S3/S4	Disabled	Disabled	
Active cooling trip point	Disabled	Disabled	
Passive cooling trip point	Disabled	Disabled	
Critical trip point	105°C	105°C	

Table 174: 945GME Advanced - ACPI configuration - Overview of profile settings

1.11.2.2 PCI configuration

Setting/Option	Profile 0	Profile 5	My setting
Plug & Play O/S	No	Yes	
PCI latency timer	64	64	
Allocate IRQ to PCI VGA	Yes	Yes	
Allocate IRQ to SMBUS HC	Yes	Yes	
Allocate IRQ to PCIEX2	Yes	Yes	
PCI IRQ resource exclusion			

Table 175: 945GME Advanced - PCI configuration - Overview of profile settings

Setting/Option	Profile 0	Profile 5	My setting
IRQ3	Allocated	Available	
IRQ4	Allocated	Allocated	
IRQ5	Available	Available	
IRQ6	Available	Available	
IRQ7	Available	Available	
IRQ9	Allocated	Allocated	
IRQ10	Available	Available	
IRQ11	Allocated	Allocated	
IRQ12	Available	Available	
IRQ14	Allocated	Allocated	
IRQ15	Allocated	Allocated	
PCI interrupt routing			
PIRQ A (VGA, PCIEX4, ETH2, UHCI2, HDA)	Auto	Auto	
PIRQ B (PCIEX1, ETH1)	Auto	Auto	
PIRQ C (PCIEX2, IF slot)	Auto	Auto	
PIRQ D (SATA,UHCI1,SMB, PCIEX3)	Auto	Auto	
PIRQ E (INTD,UHCI3,PATA)	Auto	Auto	
PIRQ F (INTA)	Auto	Auto	
PIRQ G (INTB)	Auto	Auto	
PIRQ H (INTC,UHCI0,EHCI)	Auto	Auto	
1st exclusive PCI	-	-	
2nd exclusive PCI	-	-	
3rd exclusive PCI	-	-	

Table 175: 945GME Advanced - PCI configuration - Overview of profile settings

1.11.2.3 PCI Express configuration

Setting/Option	Profile 0	Profile 5	My setting
Active State Power-Management	Disabled	Disabled	
PCIe port 0 (ETH2)	Auto	Auto	
PCIe port 1	Auto	Auto	
PCIe port 2 (IF slot)	Auto	Auto	
PCIe port 3	Auto	Auto	
PCIe port 4	Auto	Auto	
PCIe port 5 (ETH1)	Auto	Auto	
PCIe high priority port	Disabled	Disabled	
Res. PCIe hot plugging resource	No	No	
PCIe port 0 IOxAPIC enable	Disabled	Disabled	
PCIe port 1 IOxAPIC enable	Disabled	Disabled	
PCIe port 2 IOxAPIC enable	Disabled	Disabled	
PCIe port 3 IOxAPIC enable	Disabled	Disabled	

Table 176: 945GME Advanced - PCI Express configuration - Overview of profile settings

1.11.2.4 Graphics configuration

Setting/Option	Profile 0	Profile 5	My setting
Primary video device	Internal VGA	Internal VGA	
Internal graphics mode select	Enabled, 8MB	Enabled, 8MB	
DVMT mode select	DVMT mode	DVMT mode	
DVMT/FIXED memory	128 MB	128 MB	
Boot display device	Auto	Auto	
Boot display preference	SDVO-B SDVO-C LFP	LFP SDVO-B SDVO-C	
Local flat panel type	Auto	Auto	
Local flat panel scaling	Centering	Expand text & graphics	
SDVO port B device	DVI	DVI	
SDVO port C device	DVI	None	
SDVO/DVI hot plugging support	Enabled	Enabled	
Display mode persistence	Enabled	Enabled	

Table 177: 945GME Advanced - Graphics configuration - Overview of profile settings

1.11.2.5 CPU configuration

Setting/Option	Profile 0	Profile 5	My setting
MPS revision	1.4	1.4	
Max CPUID value limit	Disabled	Disabled	
Execute disable bit	Enabled	Enabled	
Core multi-processing	Enabled	Enabled	
Intel(R) SpeedStep(tm) tech.	Automatic	Automatic	
Max. CPU frequency	xxxx MHz	xxxx MHz	

Table 178: 945GME Advanced - CPU configuration - Overview of profile settings

Setting/Option	Profile 0	Profile 5	My setting
C1 config.	Standard	Standard	
C2 config.	Disabled	Disabled	
C3 config.	Disabled	Disabled	
C4 config.	Disabled	Disabled	

Table 178: 945GME Advanced - CPU configuration - Overview of profile settings

1.11.2.6 Chipset configuration

Setting/Option	Profile 0	Profile 5	My setting
DRAM frequency	Auto	Auto	
DRAM refresh rate	Auto	Auto	
Memory hole	Disabled	Disabled	
DIMM thermal control	Disabled	Disabled	
DT in SPD	Disabled	Disabled	
TS on DIMM	Disabled	Disabled	
High precision event timer	Disabled	Disabled	
IOAPIC	Enabled	Enabled	
APIC ACPI SCI IRQ	Disabled	Disabled	
C4 on C3	Disabled	Disabled	

Table 179: 945GME Advanced - Chipset configuration - Overview of profile settings

1.11.2.7 I/O interface configuration

Setting/Option	Profile 0	Profile 5	My setting
Onboard audio controller	AC97	HDA	

Table 180: 945GME Advanced - I/O interface configuration - Overview of profile settings

1.11.2.8 Clock configuration

Setting/Option	Profile 0	Profile 5	My setting
Spread spectrum	Disabled	Disabled	

Table 181: 945GME Advanced - Clock configuration - Overview of profile settings

1.11.2.9 IDE configuration

Setting/Option	Profile 0	Profile 5	My setting
ATA/IDE configuration	Compatible	Compatible	
Legacy IDE channels	SATA Pri, PATA Sec	SATA Pri, PATA Sec	
Configure SATA as	-	-	
Hard disk write protect	Disabled	Disabled	
IDE detect timeout (sec)	35	35	
ATA(Pi) 80-pin cable detection	Host & device	Host & device	
Primary IDE master			
Type	Auto	Auto	
LBA/Large mode	Auto	Auto	
Block (multi-sector transfer)	Auto	Auto	
PIO mode	Auto	Auto	
DMA mode	Auto	Auto	
S.M.A.R.T.	Auto	Auto	
32Bit data transfer	Enabled	Enabled	
Primary IDE slave			
Type	Auto	Auto	
LBA/Large mode	Auto	Auto	
Block (multi-sector transfer)	Auto	Auto	
PIO mode	Auto	Auto	
DMA mode	Auto	Auto	
S.M.A.R.T.	Auto	Auto	
32Bit data transfer	Enabled	Enabled	
Secondary IDE master			
Type	Auto	Auto	
LBA/Large mode	Auto	Auto	
Block (multi-sector transfer)	Auto	Auto	
PIO mode	Auto	Auto	
DMA mode	Auto	Auto	
S.M.A.R.T.	Auto	Auto	
32Bit data transfer	Enabled	Enabled	
Secondary IDE slave			
Type	Auto	Auto	

Table 182: 945GME Advanced - IDE configuration - Overview of profile settings

Setting/Option	Profile 0	Profile 5	My setting
LBA/Large mode	Auto	Auto	
Block (multi-sector transfer)	Auto	Auto	
PIO mode	Auto	Auto	
DMA mode	Auto	Auto	
S.M.A.R.T.	Auto	Auto	
32Bit data transfer	Enabled	Enabled	

Table 182: 945GME Advanced - IDE configuration - Overview of profile settings

1.11.2.10 USB configuration

Setting/Option	Profile 0	Profile 5	My setting
USB function	8 USB ports	8 USB ports	
USB 2.0 controller	Enabled	Enabled	
Legacy USB support	Enabled	Enabled	
USB Legacy POST-always	Enabled	Enabled	
USB keyboard Legacy support	Enabled	Enabled	
USB mouse Legacy support	Disabled	Disabled	
USB storage device support	Enabled	Enabled	
Port 64/60 emulation	Disabled	Disabled	
USB 2.0 controller mode	HiSpeed	HiSpeed	
BIOS EHCI hand-off	Disabled	Disabled	
USB beep message	Enabled	Enabled	
USB stick default emulation	Hard disk drive	Hard disk drive	
USB mass storage reset delay	20 Sec	20 Sec	

Table 183: 945GME Advanced - USB configuration - Overview of profile settings

1.11.2.11 Keyboard/Mouse configuration

Setting/Option	Profile 0	Profile 5	My setting
Bootup Num-lock	On	On	
Typematic rate	Fast	Fast	

Table 184: 945GME Advanced - Keyboard/Mouse configuration - Overview of profile settings

1.11.2.12 Remote access configuration

Setting/Option	Profile 0	Profile 5	My setting
Remote access	Disabled	Disabled	
Serial port BIOS update	Disabled	Disabled	

1.11.2.13 CPU board monitor

Setting/Option	Profile 0	Profile 5	My setting
H/W health function	Enabled	Enabled	

Table 185: 945GME Advanced - CPU board monitor - Overview of profile settings

1.11.2.14 Baseboard/Panel features

Setting/Option	Profile 0	Profile 5	My setting
Panel control			
Select panel number	-	-	
Version	-	-	
Brightness	100%	100%	
Temperature	-	-	
Fan speed	-	-	
Keys/LEDs	-	-	
Baseboard monitor			
CMOS battery	-	-	
Board I/O	-	-	
Board ETH2	-	-	
Board power	-	-	
Power supply			
Slide-in drive 1	-	-	
IF slot	-	-	
Case 1	-	-	
Case 2	-	-	
Case 3	-	-	
Case 4	-	-	
Legacy devices			

Table 186: 945GME Advanced - Baseboard/Panel features - Overview of profile settings

Setting/Option	Profile 0	Profile 5	My setting
COM A	Enabled	Enabled	
Base I/O address	3F8	3F8	
Interrupt	IRQ4	IRQ4	
COM C	Enabled	Enabled	
Base I/O address	3E8	3E8	
Interrupt	IRQ11	IRQ11	
COM D	Disabled	Disabled	
Base I/O address	-	-	
Interrupt	-	-	
COM E	Disabled	Disabled	
Base I/O address	-	-	
Interrupt	-	-	
Base I/O address	378	378	
ETH2 LAN Controller	Enabled	Enabled	
ETH2 MAC Address	-	-	

Table 186: 945GME Advanced - Baseboard/Panel features - Overview of profile settings

1.11.3 Boot

Setting/Option	Profile 0	Profile 5	My setting
Boot priority selection	Type based	Type based	
1st boot device	Onboard LAN	Primary master	
2nd boot device	Primary master	Primary slave	
3rd boot device	Primary slave	USB floppy	
4th boot device	USB floppy	USB removable device	
5th boot device	USB removable device	USB hard disk	
6th boot device	USB CDROM	USB CDROM	
7th boot device	Secondary master	Secondary master	
8th boot device	Secondary slave	Secondary slave	
Quick boot	Enabled	Enabled	
Quiet boot	Disabled	Disabled	
Automatic boot list retry	Disabled	Disabled	
Add-on ROM display mode	Keep current	Keep current	
Halt on error	Disabled	Disabled	
Hit "DEL" message display	Enabled	Enabled	
Interrupt 19 capture	Disabled	Disabled	
PXE boot to LAN (ETH1)	Enabled	Disabled	
Slide-in 2 optional ROM	Enabled	Disabled	
Power loss control	Turn on	Turn on	

Table 187: 945GME Boot - Overview of profile settings

1.11.4 Security

Setting/Option	Profile 0	Profile 5	My setting
Supervisor password	-	-	
User password	-	-	
Boot sector virus protection	Disabled	Disabled	
Hard disk security user password	-	-	
Hard disk security master password	-	-	

Table 188: 945GME Security - Overview of profile settings

1.11.5 Power

Setting/Option	Profile 0	Profile 5	My setting
Power management/APM	Enabled	Enabled	
Suspend time out	Disabled	Disabled	
Video power down mode	Suspend	Suspend	
Hard disk power down mode	Suspend	Suspend	
Keyboard & PS/2 mouse	MONITOR	MONITOR	
FDC/LPT/COM ports	MONITOR	MONITOR	
Primary master IDE	MONITOR	MONITOR	
Primary slave IDE	MONITOR	MONITOR	
Secondary master IDE	MONITOR	MONITOR	
Secondary slave IDE	MONITOR	MONITOR	
Resume on ring	Disabled	Disabled	
Resume on PME#	Disabled	Disabled	
Resume on RTC alarm	Disabled	Disabled	
Power button mode	On/Off	On/Off	

Table 189: 945GME Power - Overview of profile settings

1.12 BIOS error signals (beep codes)

While the B&R Industrial PC is booting, the following messages and errors can occur with BIOS. These errors are signaled by different beep codes.

Beep code	Description	Necessary user action
1x short	Memory refresh failed	Load BIOS defaults. If the error persists, send the industrial PC to B&R for testing.
2x short	Parity error: POST error (error in one of the hardware testing procedures)	Check that the card has been inserted properly. If the error persists, send the industrial PC to B&R for testing.
3x short	Base 64 kB memory failure: Basic memory error, RAM error within the initial 64 kB	Send the industrial PC to B&R for testing.
4x short	Timer not operational: System timer	Send the industrial PC to B&R for testing.
5x short	Processor error: Defective processor	Send the industrial PC to B&R for testing.
6x short	8042 gate A20 failure: Defective keyboard controller (block 8042/gate A20). The processor cannot switch to protected mode.	Send the industrial PC to B&R for testing.
7x short	Processor exception interrupt error: Virtual mode exception error (CPU generated an interrupt error)	Send the industrial PC to B&R for testing.
8x short	Display memory read/write error: Video memory not accessible, defective graphics card or not installed (not a fatal error)	Check that the graphics card has been inserted correctly, replace if necessary. If the error persists, send the industrial PC to B&R for testing.
9x short	ROM checksum error: ROM BIOS checksum incorrect; defective EPROM, EEPROM or flash ROM component; defective BIOS or incorrectly updated	Send the industrial PC to B&R for testing.
10x short	CMOS shutdown register read/write error: Unable to read/write from/to CMOS	Send the industrial PC to B&R for testing.
11x short	Cache error / external cache bad: Defective L2 cache on the main-board	Send the industrial PC to B&R for testing.

Table 190: 945GME BIOS - POST messages

1.13 Allocation of resources

1.13.1 RAM address assignment

RAM address	Address in hexadecimal	Resource
(TOM - 192 kB) – TOM ¹⁾	N.A.	ACPI reclaim, MPS and NVS area ²⁾
(TOM - 8 MB - 192 kB) – (TOM - 192 kB)	N.A.	VGA frame buffer ³⁾
1024 kB – (TOM - 8 MB - 192 kB)	100000h - N.A.	Extended memory
869 kB – 1024 kB	0E0000h - 0FFFFFFh	Runtime BIOS
832 kB – 869 kB	0D0000h - 0DFFFFh	Upper memory
640 kB – 832 kB	0A0000h - 0CFFFFh	Video memory and BIOS
639 kB – 640 kB	09FC00h - 09FFFFh	Extended BIOS data
0 – 639 kB	000000h - 09FC00h	Conventional memory

Table 191: RAM address assignment

- 1) TOM = Top of memory: max. installed DRAM.
- 2) Only if ACPI Aware OS is set to "YES" in the setup.
- 3) The VGA frame buffer can be reduced to 1 MB in the setup.

1.13.2 I/O address assignments

I/O address	Resource
0000h - 00FFh	Motherboard resources
0170h - 0177h	Secondary IDE channel
01F0h - 01F7h	Primary IDE channel
0238h - 023Fh	COM5
0278h - 027Fh	Hardware security key (LPT2)
02E8h - 02EFh	COM4
0376h - 0376h	Secondary IDE channel command port
0377h - 0377h	Secondary IDE channel status port
0378h - 037Fh	Hardware security key (LPT1)
0384h - 0385h	CAN controller
03B0h - 03DFh	Video system
03E8h - 03EFh	COM3
03F6h - 03F6h	Primary IDE channel command port
03F7h - 03F7h	Primary IDE channel status port
03F8h - 03FFh	COM1
0480h - 04BFh	Motherboard resources
04D0h - 04D1h	Motherboard resources
0800h - 087Fh	Motherboard resources
0CF8h - 0CFBh	PCI config address register
0CFCh - 0CFFh	PCI config data register
0D00h - FFFFh	PCI / PCI Express bus ¹⁾
4100h - 417Fh	MTCX
FF00h - FF07h	IDE bus master register

Table 192: I/O address assignment

- 1) The BIOS assigns the PCI and PCI Express bus I/O resources from FFF0h downward. Devices that are not compatible with PnP/PCI/PCI Express cannot use the I/O resources in this range.

1.13.3 Interrupt assignments in PIC mode

IRQ	0	1	2	3	4	5	6	7	8	9	10	11	12	13	14	15	NMI	NONE
System timer	•																	
Keyboard		•																
IRQ cascade			•															
COM1 (serial port A)				○	•	○	○	○			○	○	○					
ACPI ¹⁾										•								
Real-time clock									•									
Coprocessor (FPU)														•				
Primary IDE channel															•			
Secondary IDE channel																•		
B&R	COM3 (COM C)			○	○	○	○	○			○	•	○					○
	COM5 (COM D)			○	○	○	○	○			○	○	○					•

Table 193: IRQ interrupt assignments in PIC mode

- 1) Advanced Configuration and Power Interface.

- ... Default setting
- ... Optional setting

1.13.4 Interrupt assignments in APIC mode

A total of 23 IRQs are available in APIC (**A**dvanced **P**rogrammable **I**nterrupt **C**ontroller) mode. Enabling this option is only effective if done before the Windows operating system is installed.

IRQ	0	1	2	3	4	5	6	7	8	9	10	11	12	13	14	15	16	17	18	19	20	21	22	23	NMI	NONE
System timer	•																									
Keyboard		•																								
IRQ cascade			•																							
COM1 (serial port A)				○	•	○	○	○			○	○	○													
ACPI ¹⁾										•																
Real-time clock									•																	
Coprocessor (FPU)														•												
Primary IDE channel															•											
Secondary IDE channel																•										
B&R	COM3 (COM C)			○	○	○	○	○			○	•	○													○
	COM5 (COM D)			○	○	○	○	○			○	○	○													•
PIRQ A ²⁾																	•									
PIRQ B ³⁾																			•							
PIRQ C ⁴⁾																				•						
PIRQ D ⁵⁾																					•					
PIRQ E ⁶⁾																						•				
PIRQ F ⁷⁾																							•			
PIRQ G ⁸⁾																								•		
PIRQ H ⁹⁾																									•	

Table 194: IRQ interrupt assignments in APIC mode

- 1) Advanced Configuration and Power Interface.
- 2) PIRQ A: for PCIe; UHCI host controller 2, VGA controller, Intel High Definition Audio controller, PCI Express root port 4
- 3) PIRQ B: for PCIe; PCI Express root port 1, onboard gigabit LAN controller
- 4) PIRQ C: for PCIe; PCI express root port 2
- 5) PIRQ D: for PCIe; UHCI host controller 1, SMBus controller, PCI Express root port 3, Serial ATA controller in enhanced/native mode 3
- 6) PIRQ E: PCI bus INTD, UHCI host controller 3, parallel ATA controller in enhanced/native mode
- 7) PIRQ F: PCI Bus INTA
- 8) PIRQ G: PCI Bus INTB
- 9) PIRQ H: PCI bus INTC, UHCI host controller 0, EHCI host controller

- ... Default setting
- ... Optional setting

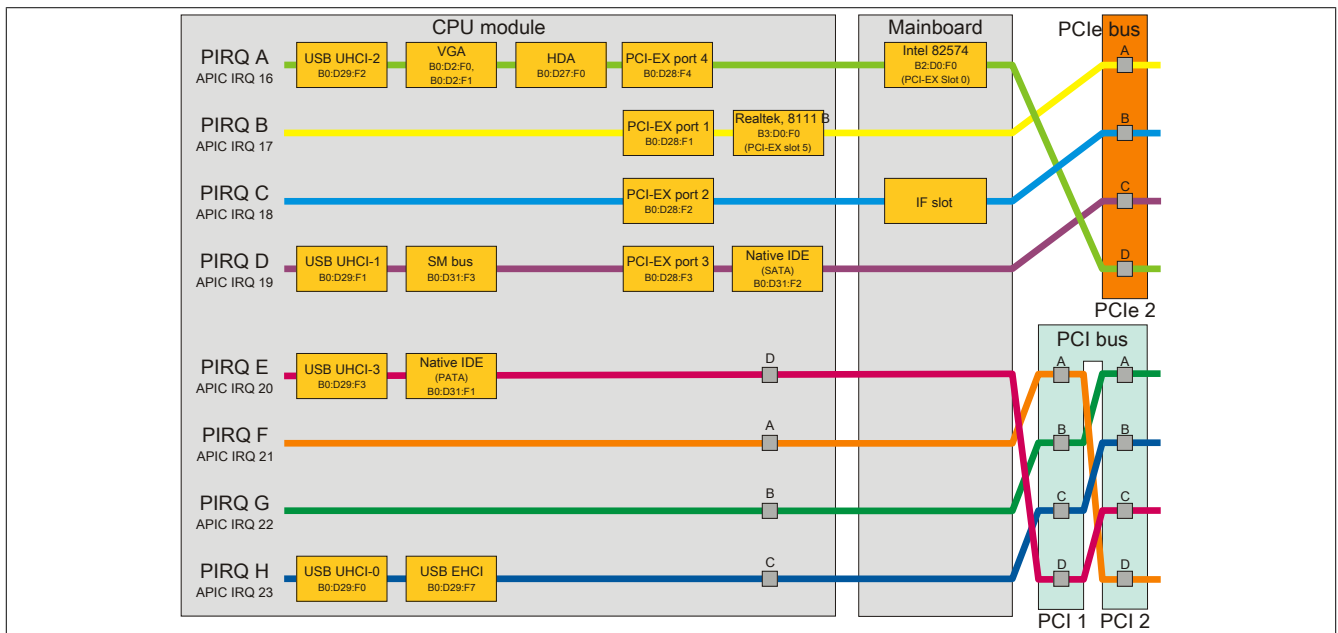

Figure 124: PCI and PCIe routing with enabled APIC for 945GME CPU boards and BIOS versions ≥ 1.15

2 Upgrade information

Warning!

The BIOS and firmware on B&R devices must be kept current. New versions can be downloaded from the B&R website (www.br-automation.com).

2.1 BIOS upgrade

An upgrade may be necessary in order to accomplish the following:

- Updating implemented functions or adding newly implemented functions or components to BIOS Setup (information about changes can be found in the Readme file for the BIOS upgrade).

2.1.1 Important information

Information:

Customized BIOS settings are deleted when upgrading BIOS.

Before starting an upgrade, it helps to determine the various software versions.

2.1.1.1 Which BIOS version and firmware are already installed on the PPC800?

This information can be found on the following BIOS Setup screen:

- After switching on the PPC800, BIOS Setup can be accessed by pressing .
- From the BIOS main menu "Advanced", select "Baseboard/Panel features".

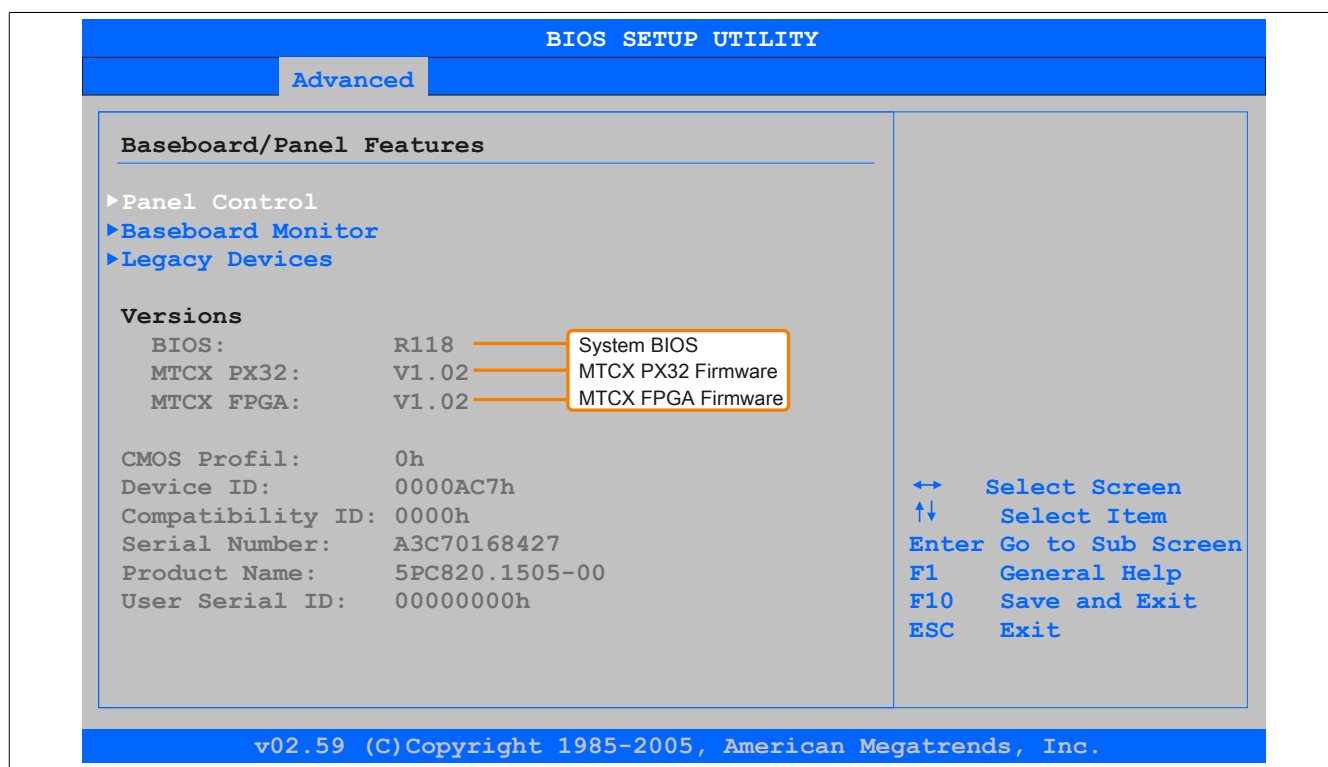

Figure 125: Softwareversion

2.1.1.2 Which firmware is installed on the Automation Panel Link transmitter?

This information can be found on the following BIOS Setup screen:

- After switching on the PPC800, BIOS Setup can be accessed by pressing .
- From the BIOS main menu "Advanced", select "Baseboard/Panel features" and then "Panel control".

Information:

The version can only be displayed when an Automation Panel with an AP Link SDL transmitter (5AC801.SDL0-00) is connected.

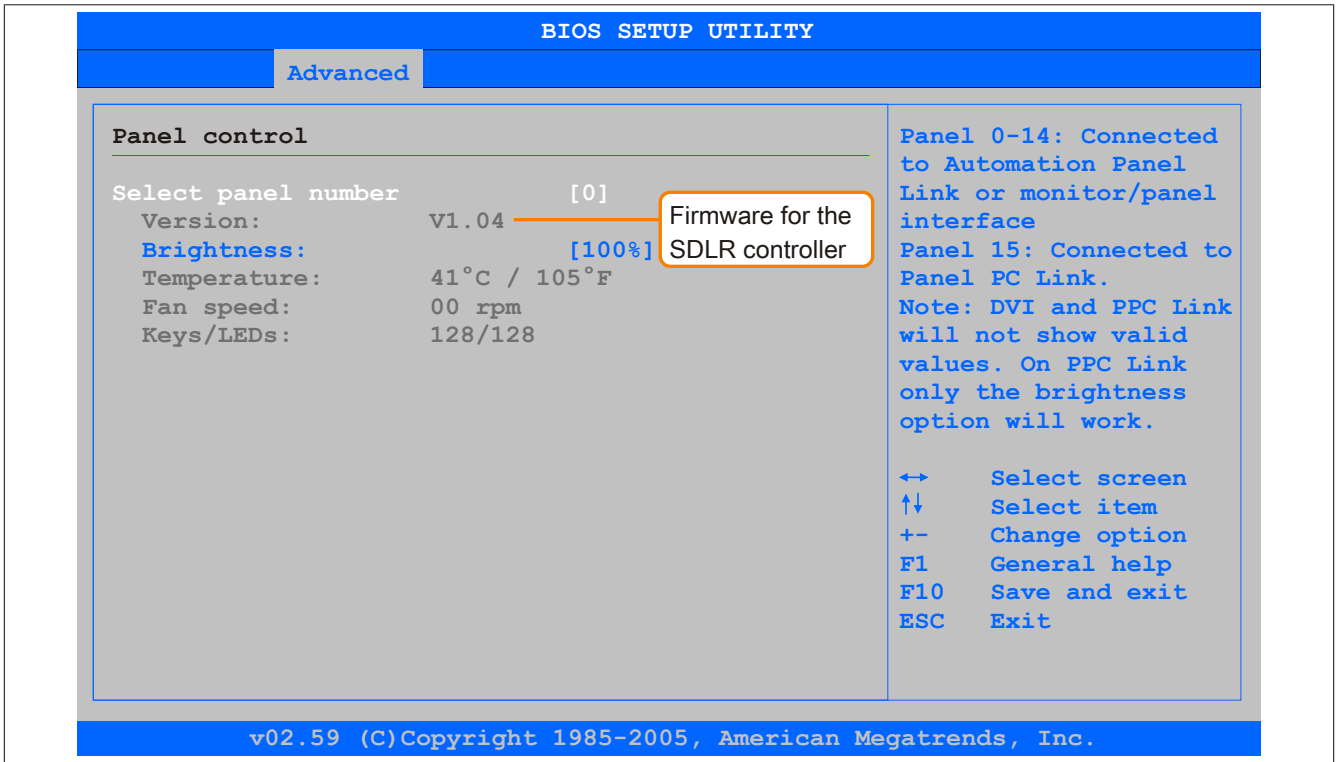

Figure 126: Firmware version of the AP Link SDL transmitter

2.1.2 Procedure with MS-DOS

1. Download the .zip file from the B&R website (www.br-automation.com).
2. Create bootable media.

Information:

In MS-DOS, Win95 and Win98, a blank HD disk can be made bootable by typing "sys a:" or "format a: /s" on the command line.

Information about creating a bootable diskette in Windows XP can be found on page 231.

Information on creating a USB flash drive for a B&R upgrade can be found on page 233.

Information on creating a CompactFlash card for a B&R upgrade can be found on page 234.

3. Copy the contents of the .zip file to the bootable media. If the B&R upgrade was already added when creating the bootable media with the B&R Embedded OS Installer, then this step is not necessary.
4. Connect the bootable media to the B&R device and reboot.
5. The following boot menu will be shown after startup:

```
1. Upgrade AMI BIOS for B945
2. Exit
```

Item 1:

BIOS is automatically upgraded (default after 5 seconds).

Item 2:

Returns to the shell (MS-DOS)

Information:

If a button is not pressed within 5 seconds, then item 1 "Upgrade AMI BIOS for B945" is automatically carried out to update the industrial PC.

6. The system must be rebooted after a successful upgrade.
7. Reboot and press to enter BIOS Setup and load the setup defaults, then select "Save changes and exit".

2.2 Firmware upgrade

The "Firmware upgrade (MTCX, SDLR, UPS)" software makes it possible to update the firmware for multiple controllers (MTCX, SDLR, UPS) depending on the PPC800 system variant.

The latest firmware upgrade is available in the Downloads section of the B&R website (www.br-automation.com).

2.2.1 Procedure

Proceed as follows to carry out a firmware upgrade:

1. Download the .zip file from the B&R website (www.br-automation.com).
2. Create bootable media.

Information:

In MS-DOS, Win95 and Win98, a blank HD disk can be made bootable by typing "sys a:" or "format a: /s" on the command line.

Information about creating a bootable diskette in Windows XP can be found on page 231.

Information on creating a USB flash drive for a B&R upgrade can be found on page 233.

Information on creating a CompactFlash card for a B&R upgrade can be found on page 234.

3. Copy the contents of the .zip file to the bootable media. If the B&R upgrade was already added when creating the bootable media with the B&R Embedded OS Installer, then this step is not necessary.
4. Connect the bootable media to the B&R device and reboot.
5. The following boot menu will be shown after startup:

Information:

The following boot menu options including descriptions are based on Version 1.02 of the PPC800 upgrade (MTCX, SDLR, SDLT, UPSI) disk. In some cases, these descriptions might not match the version you are currently using.

```

1. Upgrade MTCX (PPC800) PX32 and FPGA
2. Upgrade SDLR (AP800/AP900) on Monitor/Panel
2.1. Upgrade SDLR on AP 0 (AP800/AP900)
2.2. Upgrade SDLR on AP 1 (AP800/AP900)
2.3. Upgrade SDLR on AP 2 (AP800/AP900)
2.4. Upgrade SDLR on AP 3 (AP800/AP900)
2.5. Upgrade all SDLR (AP800/AP900)
2.6. Return to Main Menu
3. Upgrade Add-on UPS (Firmware and Battery Settings)
3.1. Upgrade Add-on UPS Firmware (5AC600.UPSI-00)
3.2. Upgrade Battery Settings (5AC600.UPSB-00)
3.3. Return to Main Menu
4. Exit

```

Item 1:

Automatically upgrades the PX32 and FPGA of the MTCX (default after 5 seconds)

Item 2:

Opens Submenu 1 for upgrading the SDLR controller on the monitor/panel interface

2.1 Upgrade SDLR on AP 0 (AP800/AP900)

Automatically updates the SDLR controller on the Automation Panel 0 interface

2.2 Upgrade SDLR on AP 1 (AP800/AP900)

Automatically updates the SDLR controller on the Automation Panel 1 interface

2.3 Upgrade SDLR on AP 2 (AP800/AP900)

Automatically updates the SDLR controller on the Automation Panel 2 interface

2.4 Upgrade SDLR on AP 3 (AP800/AP900)

Automatically updates the SDLR controller on the Automation Panel 3 interface

2.5 Upgrade all SDLR (AP800/AP900)

Automatically updates all SDLR controllers on all Automation Panels on the monitor/panel interface (default selection after 5 sec)

2.6 Return to main menu

Returns to the main menu

Item 3:

Opens Submenu 3 for upgrading the add-on UPS firmware and battery settings

3.1 Upgrade add-on UPS firmware (5AC600.UPSI-00)

Updates the firmware for the add-on UPS

3.2 Upgrade battery settings (5AC600.UPSB-00)

Automatically updates the battery settings for 5AC600.UPSB-00

3.3 Return to main menu

Returns to the main menu

Item 4:

Returns to the shell (MS-DOS)

- The system must be rebooted after a successful upgrade.

2.2.2 Possible upgrade problems and software dependencies (for V1.02)

- The SDLR firmware can only be updated if an Automation Panel with Automation Panel Link transceiver (5DLSDL.1000-01) and Automation Panel Link receiver (5DLSDL.1000-00) is connected.
- Automation Panel Link transceivers (5DLSDL.1000-01) or Automation Panel Link receivers (5DLSDL.1000-00) with a firmware version less than or equal to V00.10 can no longer be combined with Automation Panel Link transceivers (5DLSDL.1000-01) or Automation Panel Link receivers (5DLSDL.1000-00) with a firmware version greater than or equal to V01.04. Daisy chain mode is not possible with this type of a combination.
- If a UPS (e.g. 5AC600.UPSI-00) + battery unit (e.g. 5AC600.UPSB-00) is connected to the system and ready to be operated, then either the battery must be disconnected or the Power button pushed after upgrading the MTCX or SDLT (to put the system in standby mode) before powering the system off and back on. If this is not done, the firmware upgrade will not work since the UPS is buffering the system.

2.3 Creating an MS-DOS boot diskette in Windows XP

1. Insert a blank 1.44 MB HD diskette into the disk drive.
2. Open Windows Explorer.
3. Right-click on the 3½ floppy diskette icon and select "Format".

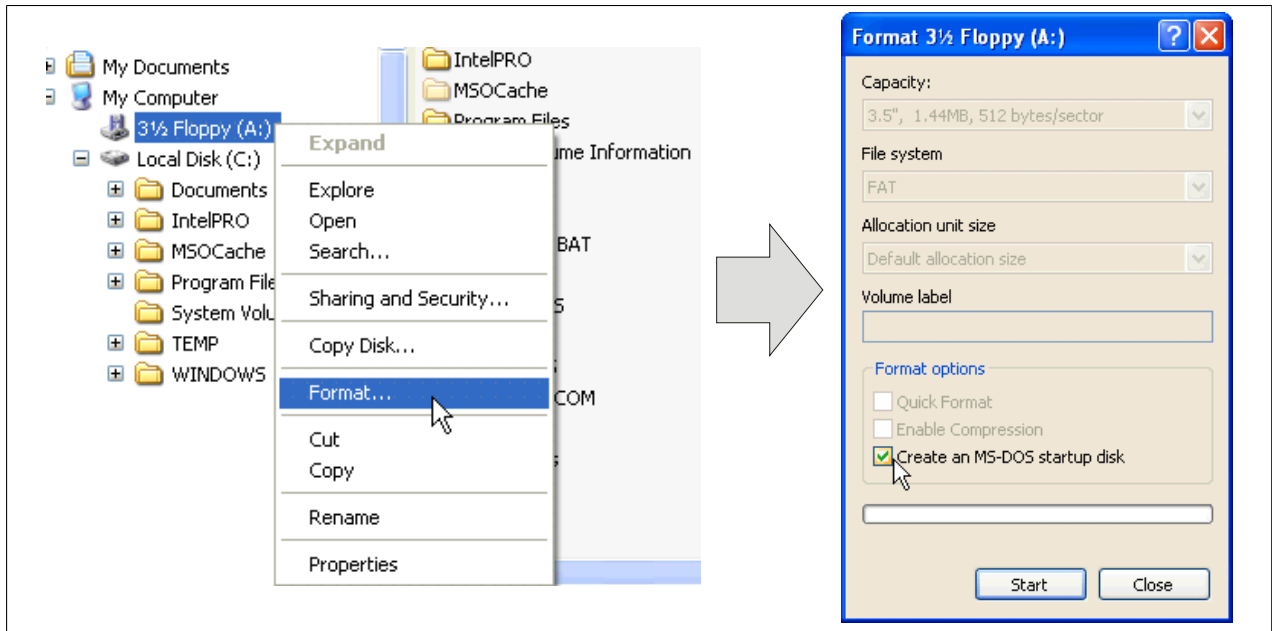

Figure 127: Creating a bootable diskette in Windows XP - Step 1

4. Select the **"Create an MS-DOS startup disk"** option, click on **"Start"** and acknowledge the warning message with "OK".

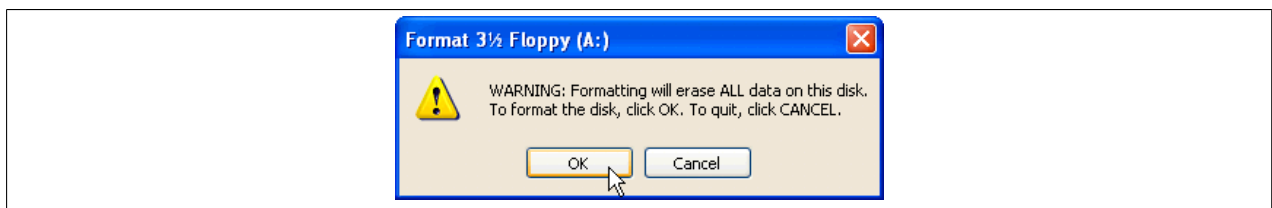

Figure 128: Creating a bootable diskette in Windows XP - Step 2



Figure 129: Creating a bootable diskette in Windows XP - Step 3

After creating the startup disk, some of the files must be deleted because of the size of the update.

To do this, all files (hidden system files, etc.) must be visible on the diskette.

In Windows Explorer, go to the "Tools" menu, select "Folder options" and open the "View" tab. Then deselect the option "Hide protected operating system files (Recommended)" (enabled by default) and enable the option "Show hidden files and folders".

before				after			
Name	Size	Type	Date Modified	Name	Size	Type	Date Modified
DISPLAY.SYS	17 KB	System file	6/8/2000 5:00 PM	AUTOEXEC.BAT	0 KB	MS-DOS Batch File	3/22/2006 10:08 AM
EGA2.CPI	58 KB	CPI File	6/8/2000 5:00 PM	COMMAND.COM	91 KB	MS-DOS Application	6/8/2000 5:00 PM
EGA3.CPI	58 KB	CPI File	6/8/2000 5:00 PM	CONFIG.SYS	0 KB	System file	3/22/2006 10:08 AM
EGA.CPI	58 KB	CPI File	6/8/2000 5:00 PM	DISPLAY.SYS	17 KB	System file	6/8/2000 5:00 PM
KEYB.COM	22 KB	MS-DOS Application	6/8/2000 5:00 PM	EGA2.CPI	58 KB	CPI File	6/8/2000 5:00 PM
KEYBOARD.SYS	34 KB	System file	6/8/2000 5:00 PM	EGA3.CPI	58 KB	CPI File	6/8/2000 5:00 PM
KEYBRD2.SYS	32 KB	System file	6/8/2000 5:00 PM	EGA.CPI	58 KB	CPI File	6/8/2000 5:00 PM
KEYBRD3.SYS	31 KB	System file	6/8/2000 5:00 PM	IO.SYS	114 KB	System file	5/15/2001 6:57 PM
KEYBRD4.SYS	13 KB	System file	6/8/2000 5:00 PM	KEYB.COM	22 KB	MS-DOS Application	6/8/2000 5:00 PM
MODE.COM	29 KB	MS-DOS Application	6/8/2000 5:00 PM	KEYBOARD.SYS	34 KB	System file	6/8/2000 5:00 PM
				KEYBRD2.SYS	32 KB	System file	6/8/2000 5:00 PM
				KEYBRD3.SYS	31 KB	System file	6/8/2000 5:00 PM
				KEYBRD4.SYS	13 KB	System file	6/8/2000 5:00 PM
				MODE.COM	29 KB	MS-DOS Application	6/8/2000 5:00 PM
				MSDOS.SYS	1 KB	System file	4/7/2001 1:40 PM

Figure 130: Creating a bootable diskette in Windows XP - Step 4

Name	Size	Type	Date Modified
AUTOEXEC.BAT	0 KB	MS-DOS Batch File	3/22/2006 10:08 AM
COMMAND.COM	91 KB	MS-DOS Application	6/8/2000 5:00 PM
CONFIG.SYS	0 KB	System file	3/22/2006 10:08 AM
DISPLAY.SYS	17 KB	System file	6/8/2000 5:00 PM
EGA2.CPI	58 KB	CPI File	6/8/2000 5:00 PM
EGA3.CPI	58 KB	CPI File	6/8/2000 5:00 PM
EGA.CPI	58 KB	CPI File	6/8/2000 5:00 PM
IO.SYS	114 KB	System file	5/15/2001 6:57 PM
KEYB.COM	22 KB	MS-DOS Application	6/8/2000 5:00 PM
KEYBOARD.SYS	34 KB	System file	6/8/2000 5:00 PM
KEYBRD2.SYS	32 KB	System file	6/8/2000 5:00 PM
KEYBRD3.SYS	31 KB	System file	6/8/2000 5:00 PM
KEYBRD4.SYS	13 KB	System file	6/8/2000 5:00 PM
MODE.COM	29 KB	MS-DOS Application	6/8/2000 5:00 PM
MSDOS.SYS	1 KB	System file	4/7/2001 1:40 PM

Figure 131: Creating a bootable diskette in Windows XP - Step 5

Now all files (selected) except Command.com, IO.sys and MSDOS.sys can be deleted.

2.4 Creating a bootable USB flash drive for B&R upgrade files

When used in connection with a B&R Industrial PC, it is possible to upgrade (e.g. BIOS) from one of the USB flash drives available from B&R. To do this, the USB flash drive must be prepared accordingly. This is done with the B&R Embedded OS Installer, which can be downloaded at no cost from the B&R website (www.br-automation.com).

2.4.1 Requirements

The following is required to create a bootable USB flash drive:

- B&R USB flash drive
- B&R Industrial PC
- USB media drive
- B&R Embedded OS Installer (V3.00 or higher)

2.4.2 Procedure

1. Connect the USB flash drive to the PC.
2. If the drive list is not refreshed automatically, update the list using the **Drives > Refresh** command.
3. Select the desired USB flash drive in the drive list.
4. Change to the **Action** tab and select **Install a B&R update to a USB flash drive** as the type of action.
5. Enter the path to the MS-DOS operating system files. If the files are part of a .zip archive, then click on the button **From .zip file**. If the files are stored in a directory on the hard drive, then click on the button **From folder**.
6. In the **B&R upgrade** text box, it is also possible to enter the path to the .zip file for the B&R upgrade disk and select the file.
7. Click on the **Start action** button in the toolbar.

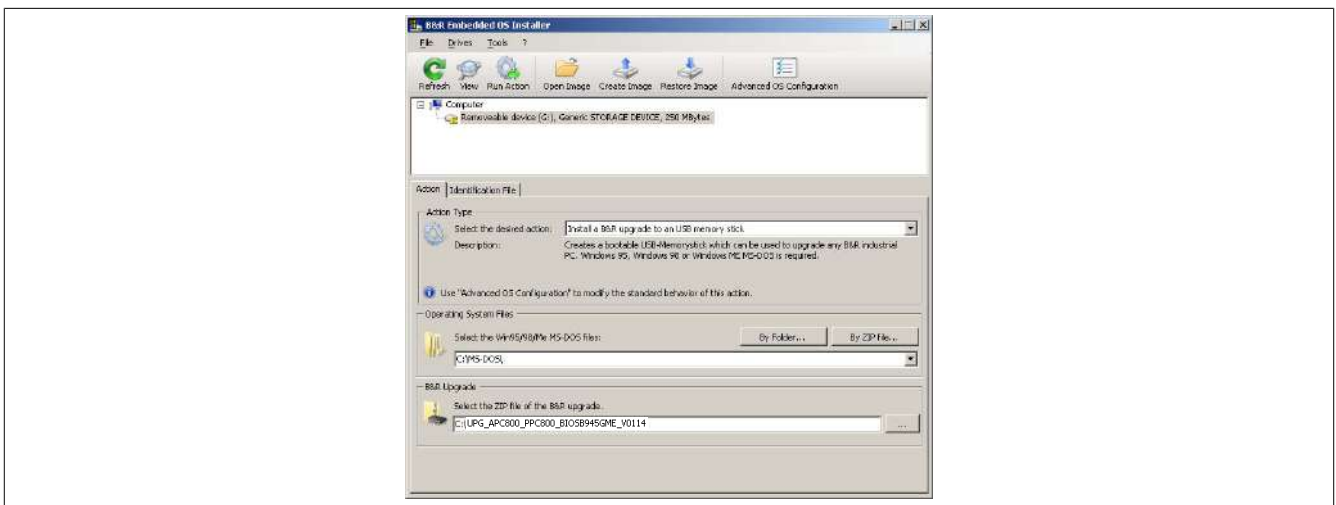

Figure 132: Creating a USB flash drive for B&R upgrade files

2.4.3 How to access MS-DOS

Information about creating an MS-DOS boot diskette can be found in section see "Creating an MS-DOS boot diskette in Windows XP" on page 231. The files from the diskette are then copied to the hard drive.

2.5 Creating a bootable CompactFlash card for B&R upgrade files

When used in connection with a B&R industrial PC, it is possible to upgrade (e.g. upgrade BIOS) from one of the CompactFlash cards available from B&R. To do this, the CompactFlash card must be prepared accordingly. This is done with the B&R Embedded OS Installer, which can be downloaded at no cost from the B&R website (www.br-automation.com).

2.5.1 Requirements

The following peripherals are required for creating a bootable CompactFlash card:

- CompactFlash card
- B&R Industrial PC
- USB media drive
- B&R Embedded OS Installer (at least V3.10)

2.5.2 Procedure

1. Insert the CompactFlash card in the CF slot on the industrial PC.
2. If the drive list is not refreshed automatically, the list can be updated using the command **Drives > Refresh**.
3. Select the desired CompactFlash card from the drive list.
4. Change to the **Action** tab and select **Install a B&R Update to a CompactFlash card** as the type of action.
5. Enter the path to the MS-DOS operating system files. If the files are part of a .zip archive, then click on the button **From .zip file**. If the files are stored in a directory on the hard drive, then click on the button **From folder**.
6. In the **B&R upgrade** text box, it is also possible to enter the path to the .zip file for the B&R upgrade disk and select the file.
7. Click on the **Start action** button in the toolbar.



Figure 133: Creating a CompactFlash card for B&R upgrade files

2.5.3 How to access MS-DOS

Information about creating an MS-DOS boot diskette can be found in section see "Creating an MS-DOS boot diskette in Windows XP" on page 231. The files from the diskette are then copied to the hard drive.

3 Microsoft DOS

3.1 Order data

Model number	Short description	Figure
9S0000.01-010	OEM Microsoft MS-DOS 6.22, German floppy disks, only supplied together with a new PC	
9S0000.01-020	OEM Microsoft MS-DOS 6.22, English floppy disks, only supplied together with a new PC	

Table 195: 9S0000.01-010, 9S0000.01-020 - Order data

3.2 Known problems

Either no drivers are available for the following hardware components or only with limitations:

- HDA sound is not supported.
- USB 2.0: only USB 1.1 rates can be achieved.
- "Graphics engine 2" (for e.g. extended desktop mode) cannot be used.
- Some "ACPI control" functions in BIOS cannot be used.

The following table shows the tested resolutions and color depths on the monitor/panel interface with 945GME CPU boards.

Resolutions for DVI	Color depth		
	8-bit	16-bit	24-bit
640 x 480	✓	✓	✓
800 x 600	✓	✓	✓
1024 x 768	✓	✓	✓
1280 x 1024	✓	✓	✓

Table 196: Tested resolutions and color depths for DVI signals

Resolutions for RGB	Color depth		
	8-bit	16-bit	24-bit
640 x 480	✓	✓	✓
800 x 600	✓	✓	✓
1024 x 768	✓	✓	✓
1280 x 1024	✓	✓	✓
1600 x 1200	✓	✓	✓
1920 x 1440	✓	✓	✓

Table 197: Tested resolutions and color depths for RGB signals

4 Windows XP Professional

4.1 General information

Information:

Discontinuation of support for Windows XP by Microsoft:

After *April 8th, 2014*, Microsoft will no longer be providing any security updates, hotfixes, support (free or paid) or technical resources for Windows XP.

4.2 Order data

Model number	Short description	Figure
	Windows XP Professional	
5SXXXP.0600-GER	Windows XP Professional SP3 - German - CD	
5SXXXP.0600-ENG	Windows XP Professional SP3 - English - CD	
5SXXXP.0600-MUL	Windows XP Professional SP3 - Multilingual - CD	
5SXXXP.0500-GER	Microsoft OEM Windows XP Professional Service Pack 2c, CD, German. Only available with a new device.	
5SXXXP.0500-ENG	Microsoft OEM Windows XP Professional Service Pack 2c, CD, English. Only available with a new device.	
5SXXXP.0500-MUL	Microsoft OEM Windows XP Professional Service Pack 2c, CD, multilingual. Only available with a new device.	

Table 198: 5SXXXP.0600-GER, 5SXXXP.0600-ENG, 5SXXXP.0600-MUL, 5SXXXP.0500-GER, 5SXXXP.0500-ENG, 5SXXXP.0500-MUL - Order data

4.3 Overview

Model number	Edition	Target system	Chipset	Service pack	Language	Minimum hard disk space required	Minimum RAM required
5SXXXP.0600-GER	Professional	APC510 APC511 APC620 APC810 APC820 APC910 PPC700 PPC725 PPC800 PPC900 PP500	945GME GM45 QM77/HM76 NM10 US15W	SP3	German	≤2.1 GB	128 MB
5SXXXP.0600-ENG	Professional	APC510 APC511 APC620 APC810 APC820 APC910 PPC700 PPC725 PPC800 PPC900 PP500	945GME GM45 QM77/HM76 NM10 US15W	SP3	English	≤2.1 GB	128 MB
5SXXXP.0600-MUL	Professional	APC510 APC511 APC620 APC810 APC820 APC910 PPC700 PPC725 PPC800 PPC900 PP500	945GME GM45 QM77/HM76 NM10 US15W	SP3	Multilingual	≤2.1 GB	128 MB
5SXXXP.0500-GER	Professional	APC620 APC810 APC820 PPC700 PPC725 PPC800	945GME GM45	SP2c	German	≤2.1 GB	128 MB
5SXXXP.0500-ENG	Professional	APC620 APC810 APC820 PPC700 PPC725 PPC800	945GME GM45	SP2c	English	≤2.1 GB	128 MB

Model number	Edition	Target system	Chipset	Service pack	Language	Minimum hard disk space required	Minimum RAM required
5SWWXP.0500-MUL	Professional	APC620 APC810 APC820 PPC700 PPC725 PPC800	945GME GM45	SP2c	Multilingual	≤2.1 GB	128 MB

4.4 Installation

B&R preinstalls the required Windows XP Professional version on the desired storage device (e.g. CompactFlash card, etc.). All of the drivers required for operation (graphics, network, etc.) are also installed in this process.

4.4.1 Installation on a PCI SATA RAID controller - 5ACPCI.RAIC-03, 5ACPCI.RAIC-05, 5ACPCI.RAIC-06

The following steps are necessary to install Windows XP Professional on a PCI SATA RAID controller:

1. Download the RAID driver from the B&R website www.br-automation.com and copy the files to a diskette.
2. Connect the media drive (5MD900.USB2-02) to the USB port.
3. Insert the diskette and Windows XP Professional CD in the media drive and boot from the CD.
4. Press the F6 key during installation to install a third-party SCSI or driver.
5. Press the "s" key when asked about installing an additional drive. Insert the diskette into the floppy drive. Press "Enter" and select the driver.
6. Follow the installation instructions.
7. The installer will copy the files to the Windows XP Professional folder and restart the B&R Industrial PC.

Information:

- Not all USB FDD drives are supported by the Windows XP installer (see Microsoft KB 916196).
- Depending on the system, the boot order may have to be changed in BIOS.

4.5 Drivers

Current drivers for all approved operating systems are available in the Downloads section of the B&R website (www.br-automation.com).

Information:

Required drivers can only be downloaded from the B&R website, not from manufacturer websites.

5 Windows 7

5.1 General information

Windows® 7 offers a wealth of innovative features and performance improvements. The 64-bit variants can also exploit the full power of current PC architectures. Faster switching to power saving mode, quicker restores, less memory usage and high-speed detection of USB devices are just a few of the advantages provided by Windows® 7. Both English and German are available in Windows® 7 Professional, while Windows® 7 Ultimate supports up to 35 different languages (up to 36 languages in Service Pack 1). Product activation is not necessary on B&R PCs, which is a huge advantage for simple logistical procedures relating to machine automation.

All of the Windows® operating systems offered by B&R are from the Microsoft Embedded division. This guarantees much longer availability, especially compared to products offered on the consumer market.

5.2 Order data

Model number	Short description	Figure
	Windows 7 Professional/Ultimate	
5SWWI7.0100-GER	Windows 7 Professional - 32-bit - German - DVD	
5SWWI7.1100-GER	Windows 7 Professional SP1 - 32-bit - German - DVD	
5SWWI7.0100-ENG	Windows 7 Professional - 32-bit - English - DVD	
5SWWI7.1100-ENG	Windows 7 Professional SP1 - 32-bit - English - DVD	
5SWWI7.0200-GER	Windows 7 Professional - 64-bit - German - DVD	
5SWWI7.1200-GER	Windows 7 Professional SP1 - 64-bit - German - DVD	
5SWWI7.0200-ENG	Windows 7 Professional - 64-bit - English - DVD	
5SWWI7.1200-ENG	Windows 7 Professional SP1 - 64-bit - English - DVD	
5SWWI7.0300-MUL	Windows 7 Professional - 32-bit - Multilingual - DVD	
5SWWI7.1300-MUL	Windows 7 Ultimate SP1 - 32-bit - Multilingual - DVD	
5SWWI7.0400-MUL	Windows 7 Ultimate - 64-bit - Multilingual - DVD	
5SWWI7.1400-MUL	Windows 7 Ultimate SP1 - 64-bit - Multilingual - DVD	

Table 199: 5SWWI7.0100-GER, 5SWWI7.1100-GER, 5SWWI7.0100-ENG, 5SWWI7.1100-ENG, 5SWWI7.0200-GER, 5SWWI7.1200-GER, 5SWWI7.0200-ENG, 5SWWI7.1200-ENG, 5SWWI7.0300-MUL, 5SWWI7.1300-MUL, 5SWWI7.0400-MUL, 5SWWI7.1400-MUL - Order data

5.3 Overview

Model number	Edition	Target system	Chipset	Service pack	Architecture	Language	Minimum hard disk space required	Minimum RAM required
5SWWI7.0100-GER	Professional	APC510 APC511 APC810 APC910 PPC800 PP500	945GME GM45 QM77/HM76 US15W		32-bit	German	16 GB	1 GB
5SWWI7.1100-GER	Professional	APC510 APC511 APC810 APC910 APC2100 PPC800 PPC900 PPC2100 PP500	945GME GM45 QM77/HM76 NM10 US15W Bay Trail	SP1	32-bit	German	16 GB	1 GB
5SWWI7.0100-ENG	Professional	APC510 APC511 APC810 APC910 PPC800 PP500	945GME GM45 QM77/HM76 US15W		32-bit	English	16 GB	1 GB
5SWWI7.1100-ENG	Professional	APC510 APC511 APC810 APC910 APC2100 PPC800 PPC900 PPC2100 PP500	945GME GM45 QM77/HM76 NM10 US15W Bay Trail	SP1	32-bit	English	16 GB	1 GB
5SWWI7.0200-GER	Professional	APC810 APC910 PPC800	945GME Intel® Core™2 Duo GM45 QM77/HM76		64-bit	German	20 GB	2 GB

Model number	Edition	Target system	Chipset	Service pack	Architecture	Language	Minimum hard disk space required	Minimum RAM required
5SWWI7.1200-GER	Professional	APC810 APC910 APC2100 PPC800 PPC900 PPC2100	945GME Intel® Core™2 Duo GM45 QM77/HM76 Bay Trail	SP1	64-bit	German	20 GB	2 GB
5SWWI7.0200-ENG	Professional	APC810 APC910 PPC800	945GME Intel® Core™2 Duo GM45 QM77/HM76		64-bit	English	20 GB	2 GB
5SWWI7.1200-ENG	Professional	APC810 APC910 APC2100 PPC800 PPC900 PPC2100	945GME Intel® Core™2 Duo GM45 QM77/HM76 Bay Trail	SP1	64-bit	English	20 GB	2 GB
5SWWI7.0300-MUL	Ultimate	APC510 APC511 APC810 APC910 PPC800 PP500	945GME GM45 QM77/HM76 US15W		32-bit	Multilingual	16 GB ¹⁾	1 GB
5SWWI7.1300-MUL	Ultimate	APC510 APC511 APC810 APC910 APC2100 PPC800 PPC900 PPC2100 PP500	945GME GM45 QM77/HM76 NM10 US15W Bay Trail	SP1	32-bit	Multilingual	16 GB ¹⁾	1 GB
5SWWI7.0400-MUL	Ultimate	APC810 APC910 PPC800	945GME Intel® Core™2 Duo GM45 QM77/HM76		64-bit	Multilingual	20 GB ¹⁾	2 GB
5SWWI7.1400-MUL	Ultimate	APC810 APC910 APC2100 PPC800 PPC900 PPC2100	945GME Intel® Core™2 Duo GM45 QM77/HM76 Bay Trail	SP1	64-bit	Multilingual	20 GB ¹⁾	2 GB

1) The memory used by additional language packs is not taken into account in the minimum size of the disk.

5.4 Installation

B&R preinstalls the required Windows 7 version on the desired storage device (e.g. CompactFlash card, etc.). All of the drivers required for operation (graphics, network, etc.) are also installed in this process.

5.4.1 Installation on a PCI SATA RAID controller - 5ACPCI.RAIC-03, 5ACPCI.RAIC-05, 5ACPCI.RAIC-06

The following steps are necessary to install Windows 7 on a PCI SATA RAID controller:

1. Download the RAID driver for Windows 7 from the B&R website at www.br-automation.com and copy the data to a folder on a USB flash drive.
2. Boot using the Windows 7 DVD.
3. Follow the installation steps until a page appears asking "Where do you want to install Windows?".
4. Plug the USB flash drive with the RAID drivers into an available USB port.
5. Click on "Load driver" and navigate to the directory containing the RAID drivers. Then click Next to continue.
6. Remove the USB flash drive.
7. The Windows 7 installation can now be performed as usual.

Information:

Depending on the system, the boot order may have to be changed in BIOS.

5.5 Special considerations, limitations

- Windows 7 does not contain a Beep.sys file, which means that an audible signal is not sounded when pressing a key, for example.
- There is currently no support for the Windows 7 system rating (although this does not apply to PP500, APC2100, APC510, APC511, APC910, PPC2100 or PPC800 devices with an NM10 chipset).

5.6 Drivers

Current drivers for all approved operating systems are available in the Downloads section of the B&R website (www.br-automation.com).

Information:

Required drivers can only be downloaded from the B&R website, not from manufacturer websites.

6 Windows XP Embedded

6.1 General information

Windows XP Embedded is the modular version of the desktop operating system Windows XP Professional. Windows XP Embedded is based on the same binary files as Windows XP Professional and is optimally tailored to the hardware being used. In other words, only the functions and modules required by the respective device are included. Windows XP Embedded is also based on the same reliable code as Windows XP Professional. It provides industry with leading reliability, improvements in security and performance and the latest technology for Web browsing and extensive device support.

6.2 Order data

Model number	Short description	Figure
	Windows XP Embedded	
5SWWXP.0427-ENG	Microsoft OEM Windows XP Embedded Feature Pack 2007, English; for PPC800 with 945GME chipset; order CompactFlash separately (at least 512 MB)	
	Required accessories	
	CompactFlash-cards	
5CFCRD.016G-06	CompactFlash 16 GB B&R (SLC)	
5CFCRD.0512-03	CompactFlash 512 MB Western Digital (SLC)	
5CFCRD.0512-06	CompactFlash 512 MB B&R (SLC)	
5CFCRD.1024-03	CompactFlash 1 GB Western Digital (SLC)	
5CFCRD.1024-06	CompactFlash 1 GB B&R (SLC)	
5CFCRD.2048-03	CompactFlash 2 GB Western Digital (SLC)	
5CFCRD.2048-06	CompactFlash 2 GB B&R (SLC)	
5CFCRD.4096-03	CompactFlash 4 GB Western Digital (SLC)	
5CFCRD.4096-06	CompactFlash 4 GB B&R (SLC)	
5CFCRD.8192-03	CompactFlash 8 GB Western Digital (SLC)	
5CFCRD.8192-06	CompactFlash 8 GB B&R (SLC)	

Table 200: 5SWWXP.0427-ENG - Order data

6.3 Overview

Model number	Target system	Chipset	Language	Minimum disk size	Minimum RAM required
5SWWXP.0427-ENG	PPC800	945GME	English	512 MB	128 MB

6.4 Features with FP2007 (Feature Pack 2007)

The feature list shows the most important device functions in Windows XP Embedded with Feature Pack 2007 (FP2007).

Function	Present
Enhanced Write Filter (EWF)	✓
File Based Write Filter	✓
Administrator accounts	✓
User accounts	Configurable
Explorer shell	✓
Registry filter	✓
Internet Explorer 6.0 + SP2	✓
Internet information service (IIS)	-
Terminal service	✓
Windows Firewall	✓
MSN Explorer	-
Outlook Express	-
Administrative Tools	✓
Remote Desktop	✓
Remote Assistance	-
.NET Framework	-
ASP.NET	-
Codepages / User locales / Keyboards	✓
Disk Management Service	✓
Windows Installer Service	✓
Class Installer	✓
CoDevice Installer	✓
Media Player	-
DirectX	-
Accessories	✓
Number of fonts	89

Table 201: Device functions in Windows XP Embedded with FP2007

6.5 Installation

B&R preinstalls Windows XP Embedded on a suitable CompactFlash card (minimum 512 MB). The system is then automatically configured when it is switched on for the first time. This procedure takes approximately 30 minutes, with the device being rebooted a number of times.

6.6 Drivers

All drivers required for operation are preinstalled along with the operating system. If an older version of the driver is still being used, the latest version can be downloaded and installed from the B&R website (www.br-automation.com). It is important that Enhanced Write Filter (EWF) is disabled for this.

6.6.1 Touch screen driver

The touch screen driver must be manually installed in order to operate Automation Panel 800 or Automation Panel 900 touch screen devices. The driver is available in the Downloads section of the B&R website (www.br-automation.com). Be sure to check that the "Enhanced Write Filter (EWF)" is enabled.

Information:

Required drivers can only be downloaded from the B&R website, not from manufacturer websites.

7 Windows Embedded Standard 2009

7.1 General information

Windows® Embedded Standard 2009 is the modular version of Windows® XP Professional. It is used if XP applications should be executed with a minimal operating system size. Together with CompactFlash memory, Windows® Embedded Standard 2009 makes it possible to use the Microsoft desktop operating system in harsh environmental conditions. In addition to the familiar features included in Windows® XP Professional, Windows® Embedded Standard 2009 has been improved with regard to dependability by adding a write filter for individual memory partitions. By protecting individual partitions such as the boot partition, the PC system can be started without problems even after an unexpected power failure. B&R offers complete images for industrial PCs, Power Panel and Mobile Panel devices to make the transition to Windows® Embedded Standard 2009 as easy as possible. In addition to Windows® Embedded Standard 2009, the standard Windows® XP Professional operating system is also available in English, German and a multilingual version.

Windows® Embedded Standard 2009 is based on the same binary files as Windows® XP Professional with Service Pack 3 and is optimally tailored to the hardware being used. In other words, only the functions and modules required by the respective device are included. Windows® Embedded Standard 2009 is also based on the same reliable code as Windows® XP Professional with SP3. It provides industry with leading reliability, security and performance improvements as well as the latest technology for web browsing and extensive device support.

7.2 Order data

Model number	Short description	Figure
	Windows Embedded Standard 2009	
5SWWXP.0727-ENG	Microsoft OEM Windows Embedded Standard 2009, English; for PPC800 with 945GME chipset; order CompactFlash separately (at least 1 GB)	
	Required accessories	
	CompactFlash-cards	
5CFCRD.016G-06	CompactFlash 16 GB B&R (SLC)	
5CFCRD.032G-06	CompactFlash 32 GB B&R (SLC)	
5CFCRD.1024-06	CompactFlash 1 GB B&R (SLC)	
5CFCRD.2048-06	CompactFlash 2 GB B&R (SLC)	
5CFCRD.4096-06	CompactFlash 4 GB B&R (SLC)	
5CFCRD.8192-06	CompactFlash 8 GB B&R (SLC)	

Table 202: 5SWWXP.0727-ENG - Order data

7.3 Overview

Model number	Target system	Chipset	Language	Minimum disk size	Minimum RAM required
5SWWXP.0727-ENG	PPC800	945GME	English	1 GB	256 MB

7.4 Features with WES2009 (Windows Embedded Standard 2009)

The following list of features shows the most important device functions included in Windows Embedded Standard 2009.

Function	Present
Enhanced Write Filter (EWF)	✓
File-Based Write Filter (FBWF)	✓
Page file	Configurable
Administrator accounts	✓
User accounts	Configurable
Explorer shell	✓
Registry filter	✓
Internet Explorer 7.0	✓
Internet information service (IIS)	-
Terminal service	✓
Windows Firewall	✓
MSN Explorer	-
Outlook Express	-
Administrative Tools	✓
Remote Desktop	✓
Remote Assistance	-
.NET Framework	-
ASP.NET	-
Local network bridge	✓

Table 203: Device functions in Windows Embedded Standard 2009

Function	Present
Codepages / User locales / Keyboards	✓
Disk Management Service	✓
Windows Installer Service	✓
Class Installer	✓
CoDevice Installer	✓
Media Player 6.4	✓
DirectX 9.0c	✓
Accessories	✓
Number of fonts	89

Table 203: Device functions in Windows Embedded Standard 2009

7.5 Installation

Windows Embedded Standard 2009 is already preinstalled on a suitable CompactFlash card by B&R (minimum 1 GB). The system is then automatically configured when it is switched on for the first time. This procedure takes approximately 10 minutes, with the device being rebooted a number of times.

7.6 Drivers

All drivers required for operation are preinstalled along with the operating system. If an older version of a driver is still being used, its latest version can be downloaded and installed from the B&R website (www.br-automation.com). It is important that Enhanced Write Filter (EWF) is disabled for this.

7.6.1 Touch screen driver

In order to operate Automation Panel 800 or Automation Panel 900 touch screen devices, the touch screen driver must be installed manually or the touch screen interface updated in the device manager. The driver is available in the Downloads section of the B&R website (www.br-automation.com). It is important that Enhanced Write Filter (EWF) is enabled for this.

Information:

Required drivers can only be downloaded from the B&R website, not from manufacturer websites.

7.7 Supported display resolutions

In accordance with Microsoft requirements, Windows Embedded Standard 2009 requires SVGA resolution (800 x 600) or higher in order to allow unimpeded operation of the Windows user interface (including system dialog boxes, etc.). A lower resolution can be selected for applications.

8 Windows Embedded Standard 7

8.1 General information

The successor to Windows® XP Embedded is Windows® Embedded Standard 7. As with previous versions, this embedded operating system offers full system support for B&R Industrial PCs. In addition to brand new features that are also included in Windows® 7 Professional, Windows® Embedded Standard 7 includes embedded components such as Enhanced Write Filter, File-Based Write Filter, Registry Filter and USB Boot. Windows® Embedded Standard 7 is available in two different versions. The main difference between them has to do with multilingual support. Windows® Embedded Standard 7 is only available in a single language, whereas Windows® Embedded Standard 7 Premium supports the installation of several languages simultaneously.

With Windows® Embedded Standard 7, Microsoft has made substantial improvements in the area of security. The AppLocker program, available in the premium version, can prevent the execution of unknown or potentially undesired applications that are being installed over a network or from drives that are directly connected. A tiered approach allows the differentiation between scripts (.ps1, .bat, .cmd, .vbs and .js), installation files (.msi, .msp) and libraries (.dll, .ocx). AppLocker can also be configured to record undesired activity and display it in the Event Viewer. Windows® Embedded Standard 7 is available as both a 32-bit and 64-bit version³⁾, which ensures that even the most demanding applications have the level of support they need.

8.2 Order data

Model number	Short description	Figure
	Windows Embedded Standard 7	
5SWWI7.0527-ENG	Microsoft OEM Windows Embedded Standard 7 32-bit, English; for PPC800 with 945GME chipset; order CompactFlash separately (at least 8 GB)	
5SWWI7.1527-ENG	Microsoft OEM Windows Embedded Standard 7 32-bit, Service Pack 1, English; for PPC800 with 945GME chipset; order CompactFlash separately (at least 16 GB)	
5SWWI7.0627-ENG	Microsoft OEM Windows Embedded Standard 7 64-bit, English; for PPC800 with 945GME chipset; order CompactFlash separately (at least 16 GB)	
5SWWI7.1627-ENG	Microsoft OEM Windows Embedded Standard 7 64-bit, Service Pack 1, English; for PPC800 with 945GME chipset; order CompactFlash separately (at least 16 GB)	
5SWWI7.0727-MUL	Microsoft OEM Windows Embedded Standard 7 Premium 32-bit, multilingual; for PPC800 with 945GME chipset; order CompactFlash separately (at least 8 GB)	
5SWWI7.1727-MUL	Microsoft OEM Windows Embedded Standard 7 Premium 32-bit, Service Pack 1, multilingual; for PPC800 with 945GME chipset; order CompactFlash separately (at least 16 GB)	
5SWWI7.0827-MUL	Microsoft OEM Windows Embedded Standard 7 Premium 64-bit, multilingual; for PPC800 with 945GME chipset; order CompactFlash separately (at least 16 GB)	
5SWWI7.1827-MUL	Microsoft OEM Windows Embedded Standard 7 Premium 64-bit, Service Pack 1, multilingual; for PPC800 with 945GME chipset; order CompactFlash separately (at least 16 GB)	
	Required accessories	
	CompactFlash-cards	
5CFCRD.016G-06	CompactFlash 16 GB B&R (SLC)	
5CFCRD.032G-06	CompactFlash 32 GB B&R (SLC)	
5CFCRD.8192-06	CompactFlash 8 GB B&R (SLC)	
	Optional accessories	
	Windows Embedded Standard 7	
5SWWI7.0900-MUL	Windows Embedded Standard 7 - 32-bit - Language Pack - DVD	
5SWWI7.1000-MUL	Windows Embedded Standard 7 - 64-bit - Language Pack - DVD	
5SWWI7.1900-MUL	Windows Embedded Standard 7 SP1 - 32-bit - Language Pack DVD	
5SWWI7.2000-MUL	Windows Embedded Standard 7 SP1 - 64-bit - Language Pack DVD	

Table 204: 5SWWI7.0527-ENG, 5SWWI7.1527-ENG, 5SWWI7.0627-ENG, 5SWWI7.1627-ENG, 5SWWI7.0727-MUL, 5SWWI7.1727-MUL, 5SWWI7.0827-MUL, 5SWWI7.1827-MUL - Order data

³⁾ 64-bit versions are not supported by all systems.

8.3 Overview

Model number	Edition	Target system	Chipset	Service pack	Architecture	Language	Minimum disk size	Minimum RAM required
5SWWI7.0527-ENG	Embedded	PPC800	945GME		32-bit	English	8 GB	1 GB
5SWWI7.1527-ENG	Embedded	PPC800	945GME	SP1	32-bit	English	16 GB	1 GB
5SWWI7.0627-ENG	Embedded	PPC800	945GME Intel® Core™2 Duo		64-bit	English	16 GB	1 GB
5SWWI7.1627-ENG	Embedded	PPC800	945GME Intel® Core™2 Duo	SP1	64-bit	English	16 GB	2 GB
5SWWI7.0727-MUL	Premium	PPC800	945GME		32-bit	Multilingual	8 GB ¹⁾	1 GB
5SWWI7.1727-MUL	Premium	PPC800	945GME	SP1	32-bit	Multilingual	16 GB ¹⁾	1 GB
5SWWI7.0827-MUL	Premium	PPC800	945GME Intel® Core™2 Duo		64-bit	Multilingual	16 GB ¹⁾	1 GB
5SWWI7.1827-MUL	Premium	PPC800	945GME Intel® Core™2 Duo	SP1	64-bit	Multilingual	16 GB ¹⁾	2 GB

1) The memory used by additional language packs is not taken into account in the minimum size of the disk.

8.4 Features with WES7 (Windows Embedded Standard 7)

The following list of features shows the most important device functions included in Windows Embedded Standard 7.

Function	Windows Embedded Standard 7	Windows Embedded Standard 7 Premium
Enhanced Write Filter (EWF)	✓	✓
File-Based Write Filter (FBWF)	✓	✓
Administrator accounts	✓	✓
User accounts	Configurable	Configurable
Windows Explorer shell	✓	✓
Registry filter	✓	✓
Internet Explorer 8.0	✓	✓
Internet Information Service (IIS) 7.0	✓	✓
Anti-malware (Windows Defender)	-	✓
Add-ons (Snipping Tool, Sticky Notes)	-	✓
Windows Firewall	✓	✓
.NET Framework 3.5	✓	✓
32-bit and 64-bit	✓	✓
Remote Desktop Protocol 7.0	✓	✓
File Compression Utility	✓	✓
Windows Installer Service	✓	✓
Windows XP mode	-	-
Media Player 12	✓	✓
DirectX	✓	✓
Multilingual user interface packs in the same image	-	✓
International components and language services	✓	✓
Language pack setup	✓	✓
Windows Update	Configurable	Configurable
Windows PowerShell 2.0	✓	✓
BitLocker	-	✓
AppLocker	-	✓
Tablet PC support	-	✓
Multi-touch support	-	✓
Boot from USB flash drive	✓	✓
Accessories	✓	✓
Page file	Configurable	Configurable
Number of fonts	134	134

Table 205: Device functions in Windows Embedded Standard 7

8.5 Installation

Windows Embedded Standard 7 is already preinstalled on a suitable CompactFlash card by B&R (32-bit: minimum 8 or 16 GB, 64-bit: minimum 16 GB). The system is then automatically configured when it is switched on for the first time. This procedure takes approximately 30 minutes, with the device being rebooted a number of times.

Information:

If Enhanced Write Filter (EWF) should be used, all mass storage devices should be disconnected from the system during installation or SYSPREP (except for the boot drive). It is also possible to disable additional mass storage devices in BIOS.

8.6 Drivers

All drivers required for operation are preinstalled along with the operating system. If an older version of a driver is still being used, its latest version can be downloaded and installed from the B&R website (www.br-automation.com). It is important that Enhanced Write Filter (EWF) is disabled for this.

8.6.1 Touch screen driver

A touch screen driver will be installed automatically if a touch controller is detected during the Windows Embedded Standard 7 installation. If a touch controller is not detected during Windows Embedded Standard 7 installation or a B&R Automation Panel is connected at a later time, then the touch screen driver needs to be installed manually or the additional touch screen interface must be selected in the touch screen settings in the Windows Control Panel. The driver is available in the Downloads section of the B&R website (www.br-automation.com). It is important that both Enhanced Write Filter (EWF) and File Based Write Filter (FBWF) are disabled for this.

Information:

Required drivers can only be downloaded from the B&R website, not from manufacturer websites.

8.7 Supported display resolutions

In accordance with Microsoft requirements, Windows Embedded Standard 7 requires XGA resolution (1024 x 768) or higher in order to allow unimpeded operation of the Windows user interface (including system dialog boxes and apps, etc.). A lower resolution can be selected for applications.

9 Windows CE

9.1 General information

B&R Windows CE is an operating system that is optimally tailored to B&R's devices, i.e. it includes only the functions and modules that are required by each device. This makes this operating system extremely robust and stable. A further advantage of B&R Windows CE compared to other operating systems are the low licensing costs.

9.2 Order data

Model number	Short description	Figure
	Windows CE 6.0	
5SWWCE.0827-ENG	Microsoft OEM Windows CE 6.0 Professional, English; for PPC800 with 945GME chipset; order CompactFlash separately (at least 128 MB)	
	Required accessories	
	CompactFlash-cards	
5CFCRD.0128-03	CompactFlash 128 MB Western Digital (SLC)	
5CFCRD.016G-06	CompactFlash 16 GB B&R (SLC)	
5CFCRD.0256-03	CompactFlash 256 MB Western Digital (SLC)	
5CFCRD.0512-03	CompactFlash 512 MB Western Digital (SLC)	
5CFCRD.0512-06	CompactFlash 512 MB B&R (SLC)	
5CFCRD.1024-03	CompactFlash 1 GB Western Digital (SLC)	
5CFCRD.1024-06	CompactFlash 1 GB B&R (SLC)	
5CFCRD.2048-03	CompactFlash 2 GB Western Digital (SLC)	
5CFCRD.2048-06	CompactFlash 2 GB B&R (SLC)	
5CFCRD.4096-03	CompactFlash 4 GB Western Digital (SLC)	
5CFCRD.4096-06	CompactFlash 4 GB B&R (SLC)	
5CFCRD.8192-03	CompactFlash 8 GB Western Digital (SLC)	
5CFCRD.8192-06	CompactFlash 8 GB B&R (SLC)	

Table 206: 5SWWCE.0827-ENG - Order data

9.3 Overview

Model number	Target system	Chipset	Language	Minimum disk size	Minimum RAM required
5SWWCE.0827-ENG	PPC800	945GME	English	128 MB	128 MB

9.4 Windows CE 6.0 features

Detailed information about Windows CE for B&R devices is available in the Downloads section of the B&R website (www.br-automation.com).

Features	Windows CE 6.0
Supported screen resolutions	VGA (TFT), SVGA (TFT), XGA (TFT)
Chipset	Intel 945GME
Color depth	16-bit or 65,536 colors ¹⁾
Graphics card driver	Intel(R) embedded graphics driver
Main memory	Automatic detection and use of up to 512 MB RAM
Boot time / Startup time	Approx. 25 seconds
Screen rotation	Not supported
Web browser	Internet Explorer
.NET	Compact Framework
Image size	Approx. 38 MB ²⁾ , uncompressed
Custom keys	Supported
PVI	Supported
Automation Device Interface	Supported
Remote Desktop Protocol for thin clients	Supported
B&R VNC Viewer	Supported
B&R Task Manager	Supported
B&R Picture Viewer	Supported
Compatible with zenOn	Yes
Compatible with Wonderware	No
Serial interfaces for any use	3
DirectX	No
Audio ports	"Line OUT" and "Line IN" are supported. "MIC" is not supported.

Table 207: Windows CE 6.0 features

- 1) The color depth depends on the display used.
- 2) The "Compress Windows CE image" function in the B&R Embedded OS Installer can be used to reduce the image size.

9.5 Requirements

The device must fulfill the following criteria to be able run the Windows CE operating system.

- At least 128 MB main memory
- At least one 128 MB CompactFlash card (size should be specified when ordered)

9.6 Installation

Windows CE is usually preinstalled at B&R.

9.7 B&R Embedded OS Installer

The B&R Embedded OS Installer makes it possible to install existing B&R Windows CE images. The 4 files NK.BIN, BLDR, LOGOXRES.BMP and LOGOQVGA.BMP must be available from an already functioning B&R Windows CE installation.

The B&R Embedded OS Installer is available in the Downloads section of the B&R website (www.br-automation.com). Additional information is available in the online help documentation for the B&R Embedded OS Installer.

10 Automation Runtime

10.1 General information

An integral component of Automation Studio is the Automation Runtime real-time operating system. This real-time operating system is the software kernel that allows applications to run on a target system.

- Guaranteed highest possible performance for the hardware being used
- Runs on all B&R target systems
- Makes the application hardware-independent
- Easy portability of applications between B&R target systems
- Deterministic behavior guaranteed by cyclic system
- Configurable jitter tolerance in all task classes
- Supports all major programming languages such as IEC 61131-3 and C
- Extensive function library conforming to IEC 61131-3 as well as the expanded B&R Automation library
- Integrated into Automation NET. Access to all networks and bus systems via function calls or the Automation Studio™ configuration

B&R Automation Runtime is fully embedded in the corresponding target system (the hardware where Automation Runtime is installed). It allows application programs to access I/O systems (e.g. via the fieldbus) and other devices (interfaces, networks, etc.).

10.2 Order data

Model number	Short description	Figure
	Automation Runtime	
0TG1000.01	Technology Guard	
1TG4600.10-5	Automation Runtime Windows, TG license	
1TG4601.06-5	Automation Runtime Embedded, TG license	

Table 208: 0TG1000.01, 1TG4600.10-5, 1TG4601.06-5 - Order data

10.3 Automation Runtime Windows (ARwin)

System requirements

The following software versions (or higher) are required to operate Automation Runtime Windows on a Panel PC 800:

- ARwin upgrade AR 3.06
- Automation Studio V3.0.90
- Technology Guard

Information:

In ARwin 4.06, ADI access is no longer possible from Windows and ARwin at the same time since the ADI interface is blocked by ARwin.

The following components are required in order to be able to access the ADI interface by Windows and ARwin simultaneously:

- ADI driver V 1.8 (or higher)
- ARwin I4.06 (or higher)

10.4 Automation Runtime Embedded (ARemb)

System requirements

The following software versions (or higher) are required to operate Automation Runtime Embedded on a Panel PC 800:

- ARemb upgrade AR A4.00
- Automation Studio V3.0.90
- Visual Components Runtime (VC) V3.35.4
- Technology Guard

10.5 Technology Guarding

Technology Guarding is a licensing approach used to safeguard individual software components. Licenses are stored on a "Technology Guard" (also referred to simply as a dongle), which is connected to an available USB interface on the target system.

The B&R software components Automation Runtime Embedded (ARemb), Automation Runtime Windows (ARwin) and Automation Runtime Embedded Terminal require a license, so a Technology Guard must always be used.

Information:

Licensing with the Technology Guarding wizard is available in Automation Studio 4.1 and Automation Runtime 4.08 and higher. Earlier versions of Automation Runtime do not require a Technology Guard.

Additional information about Technology Guarding can be found in the Automation Studio help system.

11 B&R Automation Device Interface (ADI) - Control Center

The ADI (Automation Device Interface) enables access to specific functions on B&R devices. Settings for devices can be read and configured using the B&R Control Center applet in the Control Panel.

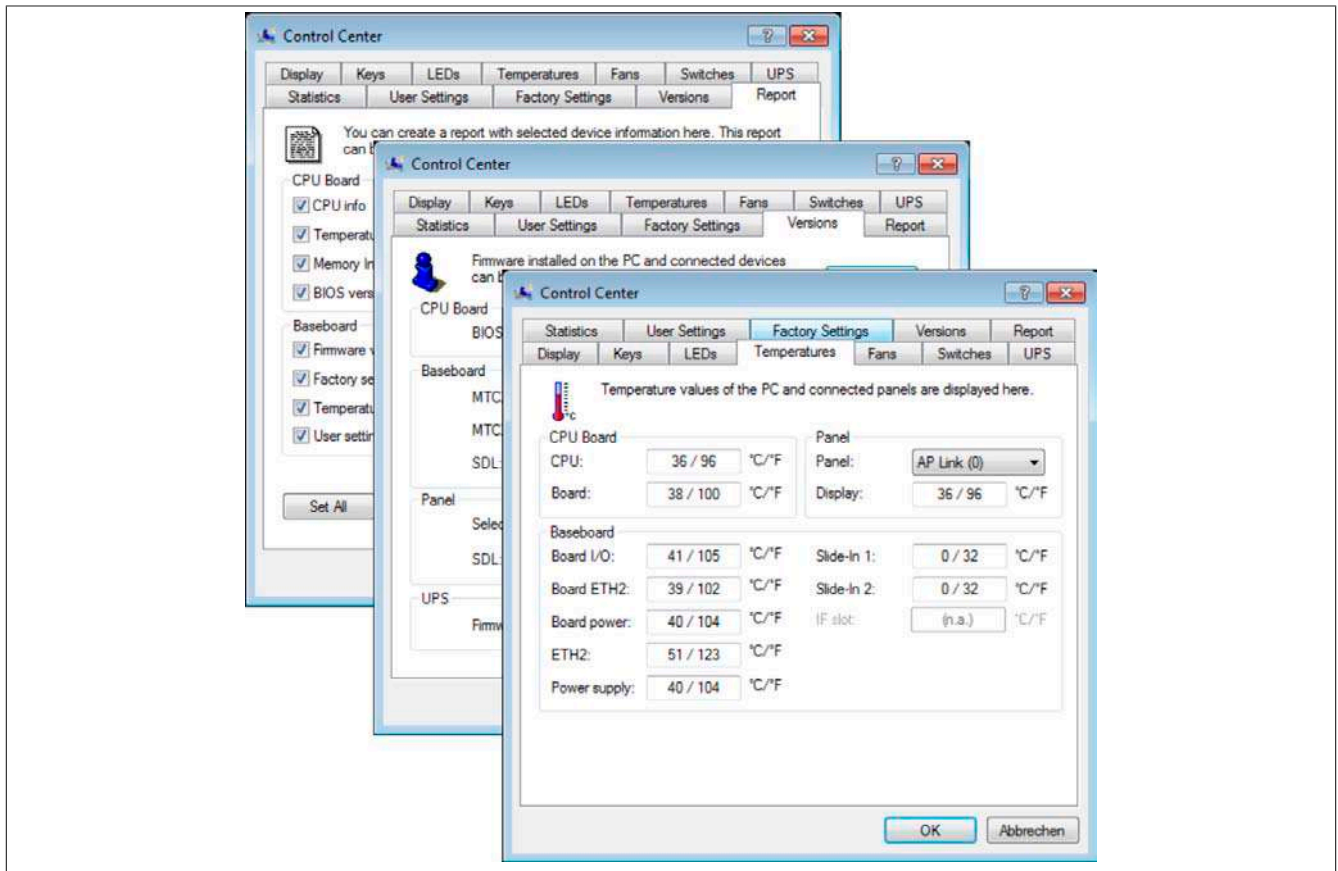

Figure 134: ADI Control Center screenshots - Examples

Information:

The temperature and voltage values (e.g. CPU temperature, core voltage, battery voltage) shown in the corresponding ADI window represent uncalibrated values for informational purposes. They cannot be used to draw any conclusions about hardware alarms or error conditions. The hardware components used have automatic diagnostic functions that can be applied in the event of error.

11.1 Functions

Information:

The functions provided by the Automation Device Interface (ADI) - Control Center vary according to the device series.

- Changing display-specific parameters
- Reading device-specific keys
- Updating the key configuration
- Enabling device-specific LEDs on a membrane keypad or keys
- Reading and calibrating control devices (e.g. key switches, handwheels, joysticks, potentiometers)
- Reading temperatures, fan speeds, statistical data and switch settings
- Reading operating hours (power-on hours)
- Reading user and factory settings
- Reading software versions
- Updating and backing up BIOS and firmware
- Creating reports about the current system (support assistance)
- Setting the SDL equalizer value when adjusting SDL cables
- Changing the user serial ID

Supports the following systems:

- Automation PC 510
- Automation PC 511
- Automation PC 620
- Automation PC 810
- Automation PC 820
- Automation PC 910
- Automation PC 2100
- Panel PC 300
- Panel PC 700
- Panel PC 725
- Panel PC 800
- Panel PC 900
- Panel PC 2100
- Power Panel 100/200
- Power Panel 300/400
- Power Panel 500
- Mobile Panel 40/50
- Mobile Panel 100/200
- Connected Automation Panel 800
- Connected Automation Panel 900

11.2 Installation

A detailed description of the Control Center can be found in the integrated help system. The B&R Automation Device Interface (ADI) driver (also contains Control Center) is available at no charge in the Downloads section of the B&R website (www.br-automation.com).

1. Download and unzip the .zip archive.
2. Close all applications.
3. Run the Setup.exe file (e.g. double-click on it in Explorer).

Information:

The ADI driver is already included in B&R images of embedded operating systems.

If a more current ADI driver version exists (see the Downloads section of the B&R website), it can be installed later. It is important that Enhanced Write Filter (EWF) is disabled for this.

11.3 SDL Equalizer settings

1. Open the **Control Center** in the **Control Panel**.
2. Select the **Display** tab.
3. Click on **Settings**. This opens the following window:

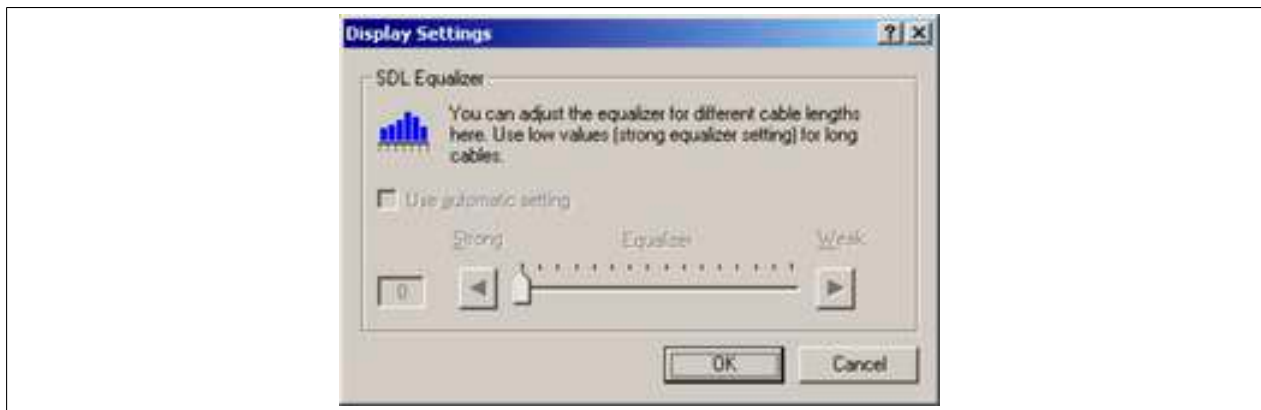

Figure 135: ADI Control Center - SDL Equalizer settings

The settings in this window can be used to configure the SDL Equalizer settings for the display. The equalizer is integrated into Automation Panel devices and adapts the DVI signal to different cable lengths. The equalizer value is automatically calculated based on the cable length. It is possible to set a different equalizer value in order to obtain the best possible display quality (e.g. in the event of low-quality cables or poor DVI signal quality).

The optimal value for the cable length is defined by selecting "Use automatic setting".

The equalizer value can only be changed if the function is supported by Automation Panel 900 (Panel firmware version 1.04 or higher).

11.4 UPS configuration

This window displays the status values for an optionally installed B&R add-on UPS and allows the battery settings for the UPS to be edited, updated and backed up. It is also possible to configure the system settings for the UPS.

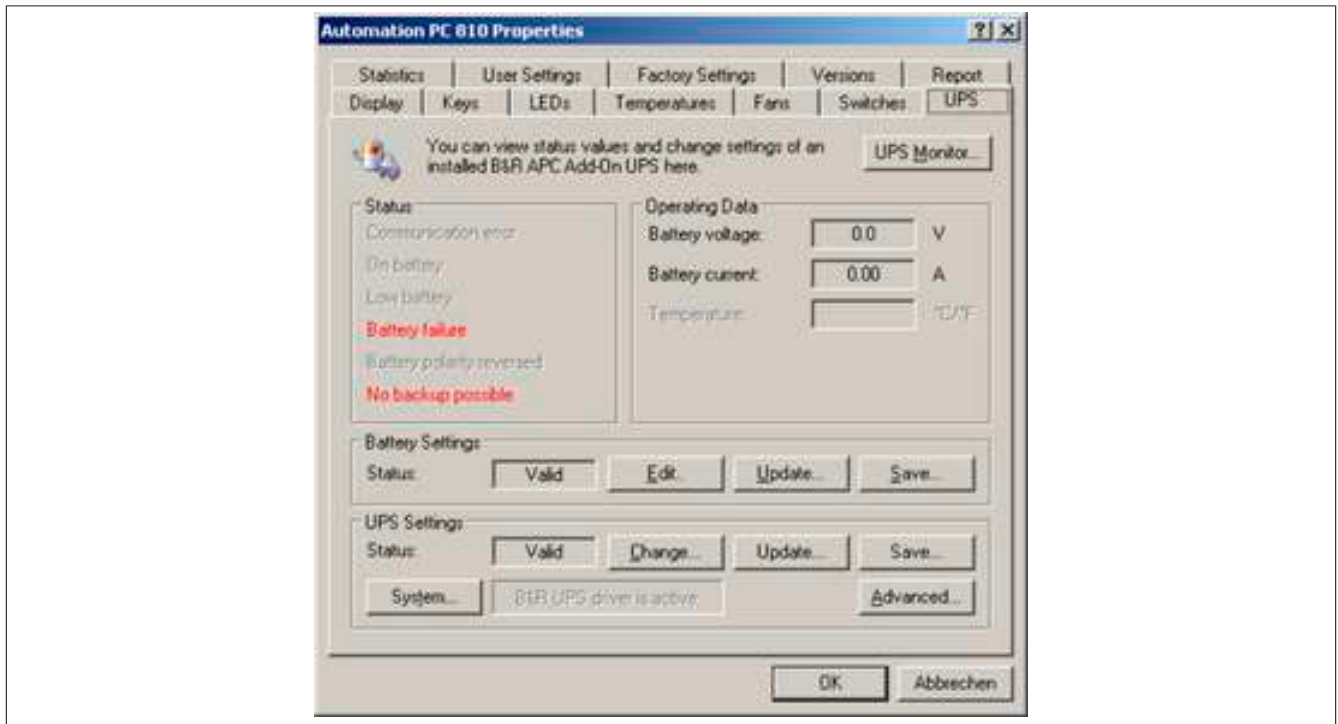

Figure 136: ADI Control Center - UPS settings

Caution!

The installed UPS must be selected and configured in the Power Options section of the Control Panel in order for battery operation to be supported.

Information:

The UPS service is supported in B&R Windows Embedded Version 2.10 and higher.

11.4.1 Installing the UPS service for the B&R add-on UPS

1. Open the **Control Center** in the **Control Panel**.
2. Select the **UPS** tab.
3. Under **UPS settings**, click on **System**. This opens the **Power options** in the Control Panel (**Power options** can also be opened directly from the **Control Panel**).
4. Go to the **UPS** tab and click **Select**.
5. Select "Bernecker + Rainer" as the manufacturer and "APC add-on UPS" as the model and then click **Finish**. The value for the COM connection is only required for a serially connected UPS and is ignored by the APC add-on UPS driver.
6. Click on **Apply** to start the UPS service. The UPS status and details will be displayed after a few seconds.
7. Click **OK**.

The text field next to **System** (on the **UPS** tab in the **Control Center**) also indicates whether the B&R UPS driver is active.

Information:

Administrator rights are required in order to change the energy options or display the UPS status.

11.4.2 Displaying UPS default values

1. Open the **Control Center** in the **Control Panel**.
2. Select the **UPS** tab.

The displayed values are updated automatically.

Information:

The status "Reversed battery polarity" is only displayed if using UPS firmware version 1.08 or higher. With UPS firmware versions 1.07 and older, switching between battery operation and normal operation can lead to a communication error.

3. Select "UPS monitor" to display UPS status changes since the last time the system or UPS driver was started.

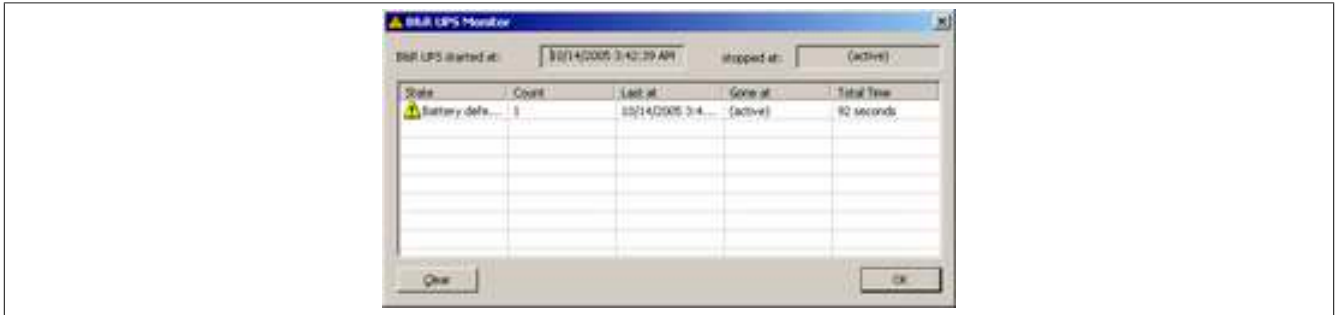

Figure 137: ADI Control Center - UPS monitor

The window is updated automatically when the status changes.

To remove a status from the list, click on **Clear**.

Information:

The current status of the UPS is also displayed on the UPS page in the power options when the UPS service is started in the Windows Control Panel.

Information:

In a German version of Windows XP Professional the battery status is shown as "Low" in the power options even if the battery is OK (Windows error). In an English version, three battery status levels are displayed: unknown, OK and replace. A low battery status is never displayed.

11.4.3 Changing UPS battery settings

1. Open the **Control Center** in the **Control Panel**.
2. Select the **UPS** tab.
3. Under **Battery settings**, click on **Edit**. This opens the "Open" dialog box.
4. Select and **open** the file containing the battery settings.



Figure 138: ADI Control Center - UPS battery settings

This window can be used to change the settings for the UPS battery.

Click **OK** to write the changed settings to the file. The battery settings for the UPS can then be updated with this file.

Information:

To make settings for non-B&R batteries, it is best to make a copy of a file that contains battery settings from B&R under a new name and then adjust the settings in this new file for the battery being used.

Current files with settings for batteries from B&R can be updated using B&R's "Upgrade PPC800 MTCX" software.

Information:

- The current UPS firmware version 1.10 does not use charge end voltage, deep discharge voltage, service life and deep discharge cycles.
- Service life is only included in version 2 (and higher) of the UPS battery settings and only valid for B&R UPS batteries at 25°C ambient temperature.
- Deep discharge cycles are only included in version 3 (and higher) of the UPS battery settings and only valid for UPS batteries from B&R.

Information:

To change the current battery settings on the UPS, they must first be saved to a file.

11.4.4 Updating UPS battery settings

1. Open the **Control Center** in the **Control Panel**.
2. Select the **UPS** tab.
3. Under **Battery settings**, click on **Update**. Clicking on "Open" opens a dialog box.
4. Select and **open** the file containing the battery settings. The "Download" dialog box is opened.

The transfer can be canceled by clicking on **Cancel**. "Cancel" is disabled when writing to flash memory.

Information:

- The UPS cannot be operated while the battery settings are being updated.
- If the transfer is aborted, then the procedure must be repeated until the battery settings have been updated successfully. Otherwise, battery operation will no longer be possible.

Deleting the data in flash memory can take several seconds depending on the memory block being used. The progress indicator is not updated during this time.

Information:

The UPS is automatically restarted after a successful download. This can cause a brief failure in the UPS communication.

11.4.5 Saving UPS battery settings

1. Open the **Control Center** in the **Control Panel**.
2. Select the **UPS** tab.
3. Under "Battery settings", click on **Save**. This opens the "Save as" window.
4. Enter a filename or select an existing file and click on **Save**.

Information:

UPS settings can only be saved with UPS firmware version 1.10 and higher.

The transfer can be aborted by clicking on **Cancel** in the Download dialog box.

11.4.6 Configuring UPS system settings

1. Open the **Control Center** in the **Control Panel**.
2. Select the **UPS** tab.
3. Under **UPS settings**, click on **Change**. This opens the following window:

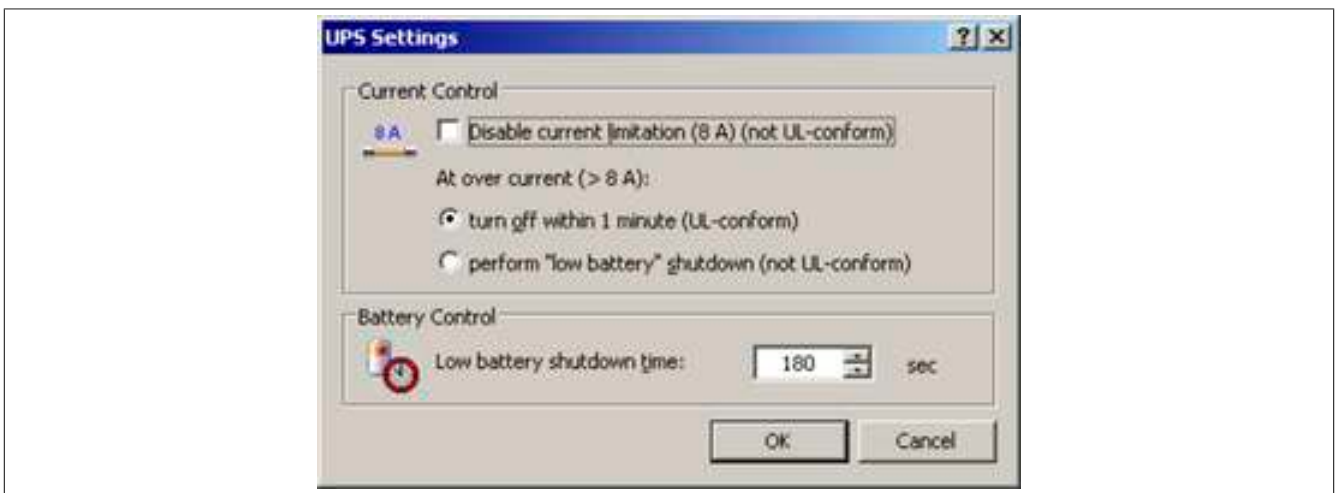

Figure 139: ADI Control Center - UPS settings

Additional information regarding UPS system settings can be found in the Windows help documentation.

Information:

- **UPS settings can only be changed with UPS firmware version 1.10 and higher. If there are no modified settings on the UPS, then the factory or default settings are used.**
- **The UPS is automatically restarted after the UPS settings have been changed. This can cause a brief disruption in communication with the UPS.**
- **Administrator rights are required in order to change the energy options or display the UPS status.**

11.4.6.1 Disabling 8 A current limitation

Information:

It is not UL-compliant to switch off the 8 A current limitation on devices during battery operation!

"Low battery" shutdowns caused by overcurrent >8 A on devices running on the battery are not UL compliant!

Select the checkbox **Disable current limitation (8 A)**.

If current limitation is enabled (checkbox not selected), then the UPS uses battery operation to check whether the UPS battery is discharged with 8 A for longer than 16 seconds. If so, then an overcurrent alarm is sent to the PC.

Information:

Current limitation is only supported with UPS firmware version 1.10 and higher.

Enabling one of the two following options determines how the UPS should perform when an overcurrent alarm occurs:

If **Turn-off within 1 minute** is selected, then the UPS will be switched off within one minute when an overcurrent alarm occurs.

Warning!

The operating system will not be properly shut down if an overcurrent alarm occurs!

If **Perform "low battery" shutdown** is selected, then the UPS will also signal a "Low battery alarm" in addition to the overcurrent alarm and will be switched off after the defined **Low battery shutdown time**. This will allow the operating system to shut down properly when the UPS service is enabled.

11.4.6.2 Changing the shutdown time of the UPS when the battery is low

Enter the **Low battery shutdown time** in seconds. This is the amount of time that the UPS will wait before shutting off the power supply when the battery level is low.

This prevents the UPS battery from becoming too low if the Windows UPS service is not enabled to have the operating system turn off the UPS.

If the UPS service is enabled, then the UPS will be turned off by the operating system in accordance with the **Shutdown time** UPS service in Windows (see "Changing additional UPS settings" on page 259) when the battery level is low. The **Low battery shutdown time** will then be ignored.

Information:

- The low battery shutdown time must be set to at least 60 seconds so that the operating system has enough time to send the shutdown command to the UPS when the battery level is low (normally occurs after approximately 30 seconds).
- The low battery shutdown time can only be set with UPS firmware version 1.10 and higher. UPS firmware version 1.08 always uses a switch-off delay of 180 seconds. UPS firmware versions older than 1.08 do not shut down automatically when the battery level is low.

11.4.7 Changing additional UPS settings

1. Open the **Control Center** in the **Control Panel**.
2. Select the **UPS** tab.
3. Under **UPS settings**, click on **Advanced**. This opens the following window:



Figure 140: ADI Control Center - Advanced UPS settings

Information:

Administrator rights are required in order to display this window.

11.4.7.1 Changing the UPS shutdown time

The **Turn off delay** can be entered under **Windows UPS service** in seconds. This is the length of time that the UPS waits before switching off the power supply. When a critical alarm occurs (e.g. low battery level), the Windows UPS service will send a shutdown command with the turn off delay time to the UPS and shut down the system.

Information:

This time is evaluated by the **Windows UPS Service** but cannot be set in the **UPS system settings** of the power options. This value should only be changed if the system requires longer than the default setting of 180 seconds to shut down.

Caution!

The time entered must be longer than the time required to shut down the operating system.

11.4.7.2 Enabling UPS notifications

Under **B&R UPS driver**, enable the checkbox **Show notifications for UPS status**. Any changes to the UPS status will then trigger a message from the B&R UPS driver.

Information:

Shutting down the system is only reported by the **Windows UPS service**. The **UPS service** also sends other notifications if so enabled in the **UPS system settings** in the power options. These messages are only displayed when the **Windows Messenger service**⁴⁾ is active and the PC is connected to a network. In addition, some conditions of the B&R add-on UPS are not detected by the **Windows UPS Service** and therefore do not trigger messages (e.g. when there are no battery settings on the UPS). Windows services can be found by opening the **Control Panel** and selecting **"Services"** under **"Administrative tools"**.

If the checkbox **Show UPS status with UPS monitor** is also enabled, a new message is not displayed for every change. Instead, only a general message and request to start the B&R UPS monitor are shown. As long as the UPS monitor is active, no new messages will be displayed.

Information:

Regardless of these options, all changes to the **UPS status** are logged in the **Windows event log** (under **"Application"**).

⁴⁾ The Windows Messenger service is supported starting with B&R Windows Embedded version 2.20 and higher.

11.4.8 Procedure following power failure

11.4.8.1 Overcurrent shutdown

If overcurrent >8 A is present during battery operation for a duration of 16 seconds, then an overcurrent shutdown takes place. A switch-off time of one minute is available to the system.

If power returns during this time, then the shutdown process is aborted.

Information:

Overcurrent shutdown has the highest priority.

11.4.8.2 Low battery shutdown

If the LowBatteryFlag is set during power failure, then a "low battery" shutdown is performed to prevent the battery from fully discharging. Once the switch-off time expires (3 minutes by default), the UPS shuts down.

If an "overcurrent" shutdown or "standard" shutdown is detected during the shutdown process, the "low battery" shutdown is replaced by the respective process.

11.4.8.3 Standard shutdown

The standard shutdown is in effect whenever the UPS service is active; the switch-off time is 3 minutes by default.

If power returns during the switch-off time, then the shutdown procedure is aborted.

If power returns during the shutdown process, then the shutdown timer will run until the B&R Industrial PC enters standby mode, at which point the system will be rebooted.

12 B&R Automation Device Interface (ADI) Development Kit

This software can be used to access B&R Automation Device Interface (ADI) functions directly from Windows applications created in one of the following development environments:

- Microsoft Visual C++ 6.0
- Microsoft Visual Basic 6.0
- Microsoft Embedded Visual C++ 4.0
- Microsoft Visual Studio 2008 (or newer)

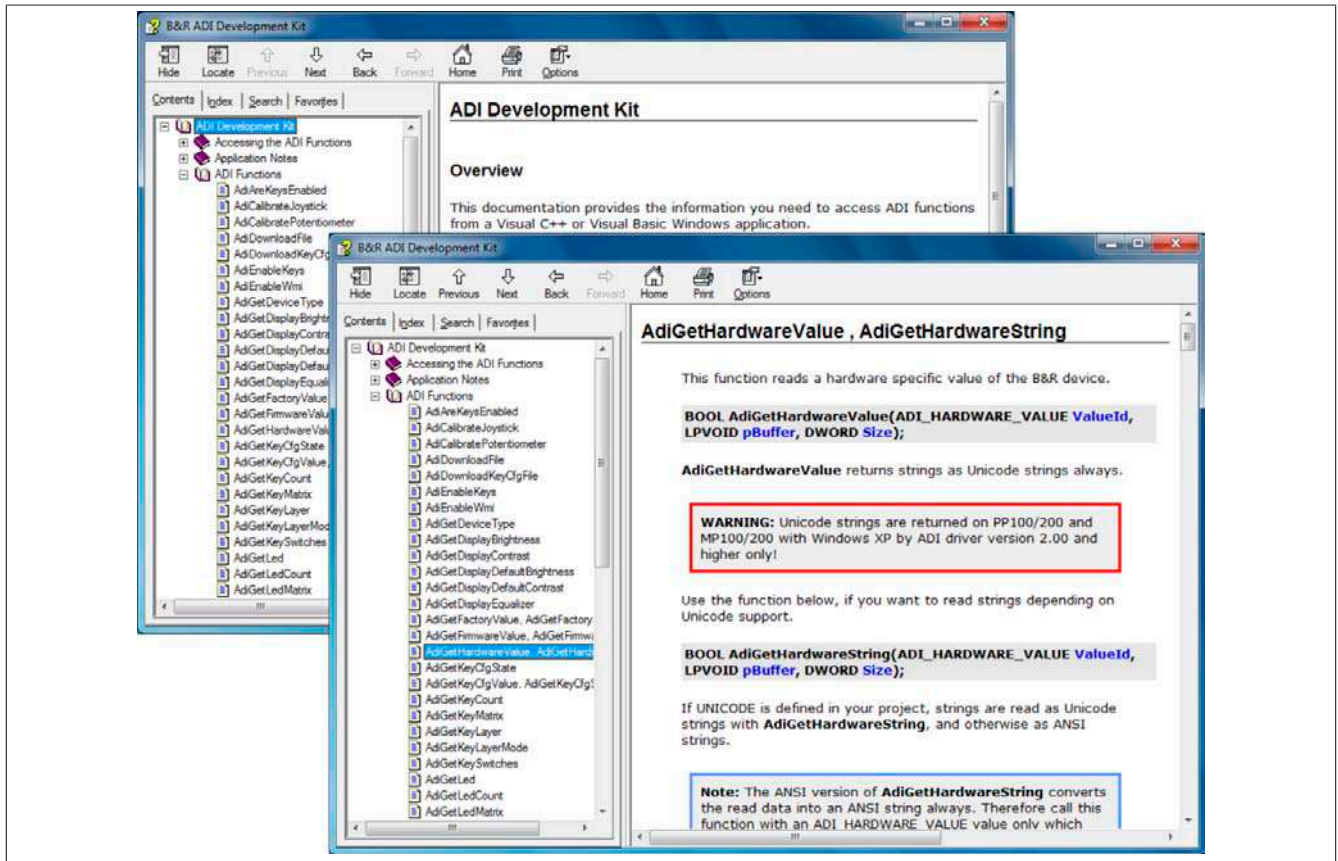

Figure 141: ADI Development Kit Screenshots (Version 3.70)

Features:

- One Microsoft Visual Basic module with ADI function declarations
- Header files and import libraries for Microsoft Visual C++
- Help files for Visual Basic and Visual C++
- Sample projects for Visual Basic and Visual C++
- ADI DLL (for application testing if no ADI driver is installed)

The following systems are supported (version 3.70 and higher):

- Automation PC 510
- Automation PC 511
- Automation PC 620
- Automation PC 810
- Automation PC 820
- Automation PC 910
- Automation PC 2100
- Panel PC 300
- Panel PC 700
- Panel PC 800
- Panel PC 900
- Panel PC 2100

- Power Panel 100/200
- Power Panel 300/400
- Power Panel 500
- Mobile Panel 40/50
- Mobile Panel 100/200

The ADI driver installed on the stated product series must be suitable for that device. The ADI driver is already included in B&R images of embedded operating systems.

A detailed description of how to use ADI functions can be found in the help system.

The B&R Automation Device Interface (ADI) development kit is available at no cost in the Downloads section of the B&R website (www.br-automation.com).

13 B&R Automation Device Interface (ADI) .NET SDK

This software can be used to access B&R Automation Device Interface (ADI) functions directly from .NET applications created using Microsoft Visual Studio 2005 or later.

Supported programming languages:

- Visual Basic
- Visual C++
- Visual C#

System requirements

- Development system: PC with Windows XP or Windows 7 and
 - Microsoft Visual Studio 2005 (or newer)
 - Microsoft .NET Framework 2.0 and/or Microsoft .NET Compact Framework 2.0 (or newer)

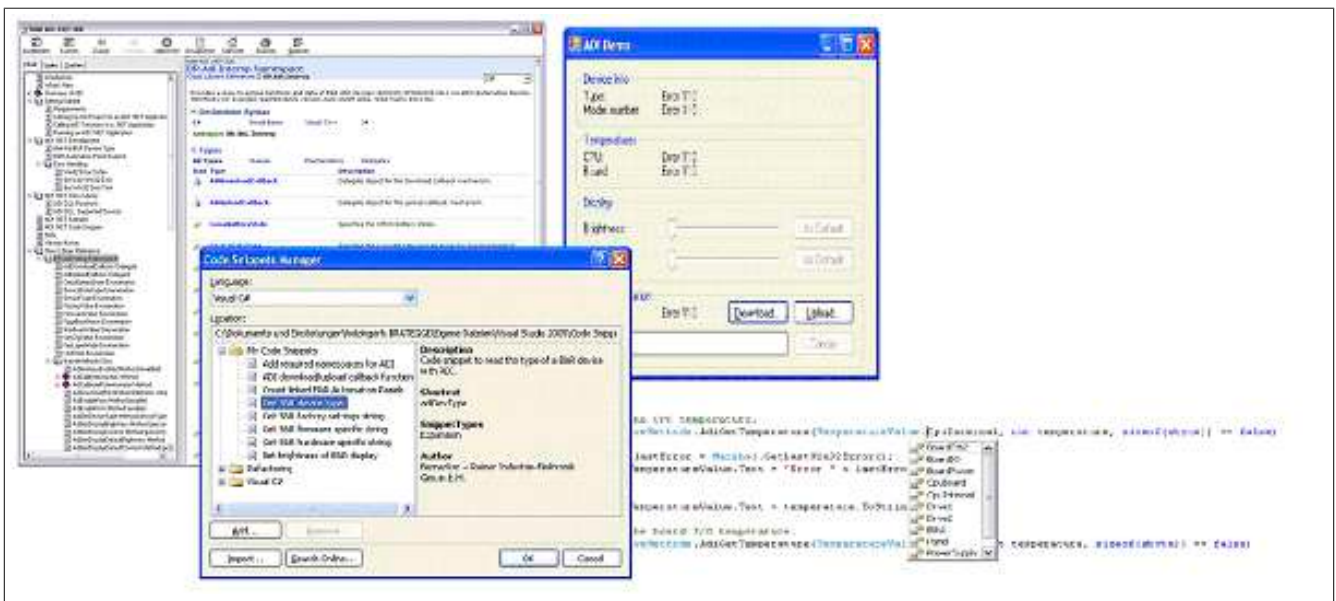

Figure 142: ADI .NET SDK screenshots (version 2.10)

Features (version 2.10 and higher)

- ADI .NET class library
- Help files in HTML Help 1.0 format (.chm), MS Help 2.0 format (.HxS) and MS Help Viewer format (.MSHC) (help documentation is in English only)
- Sample projects and code snippets for Visual Basic, Visual C++ and Visual C#
- ADI DLL (for application testing if no ADI driver is installed)

The following systems are supported (version 2.10 and higher):

- Automation PC 510
- Automation PC 511
- Automation PC 620
- Automation PC 810
- Automation PC 820
- Automation PC 910
- Automation PC 2100
- Panel PC 300
- Panel PC 700
- Panel PC 800
- Panel PC 900
- Panel PC 2100
- Power Panel 100/200
- Power Panel 300/400

- Power Panel 500
- Mobile Panel 40/50
- Mobile Panel 100/200

The ADI driver installed on the stated product series must be suitable for that device. The ADI driver is already included in B&R images of embedded operating systems.

A detailed description of how to use ADI functions can be found in the help system.

The ADI .NET SDK is available in the Downloads section of the B&R website (www.br-automation.com).

14 B&R Key Editor

On display devices, it is often necessary to adapt the function keys and LEDs directly to the application software being used. The B&R Key Editor makes it quick and easy to implement a unique configuration for the application.

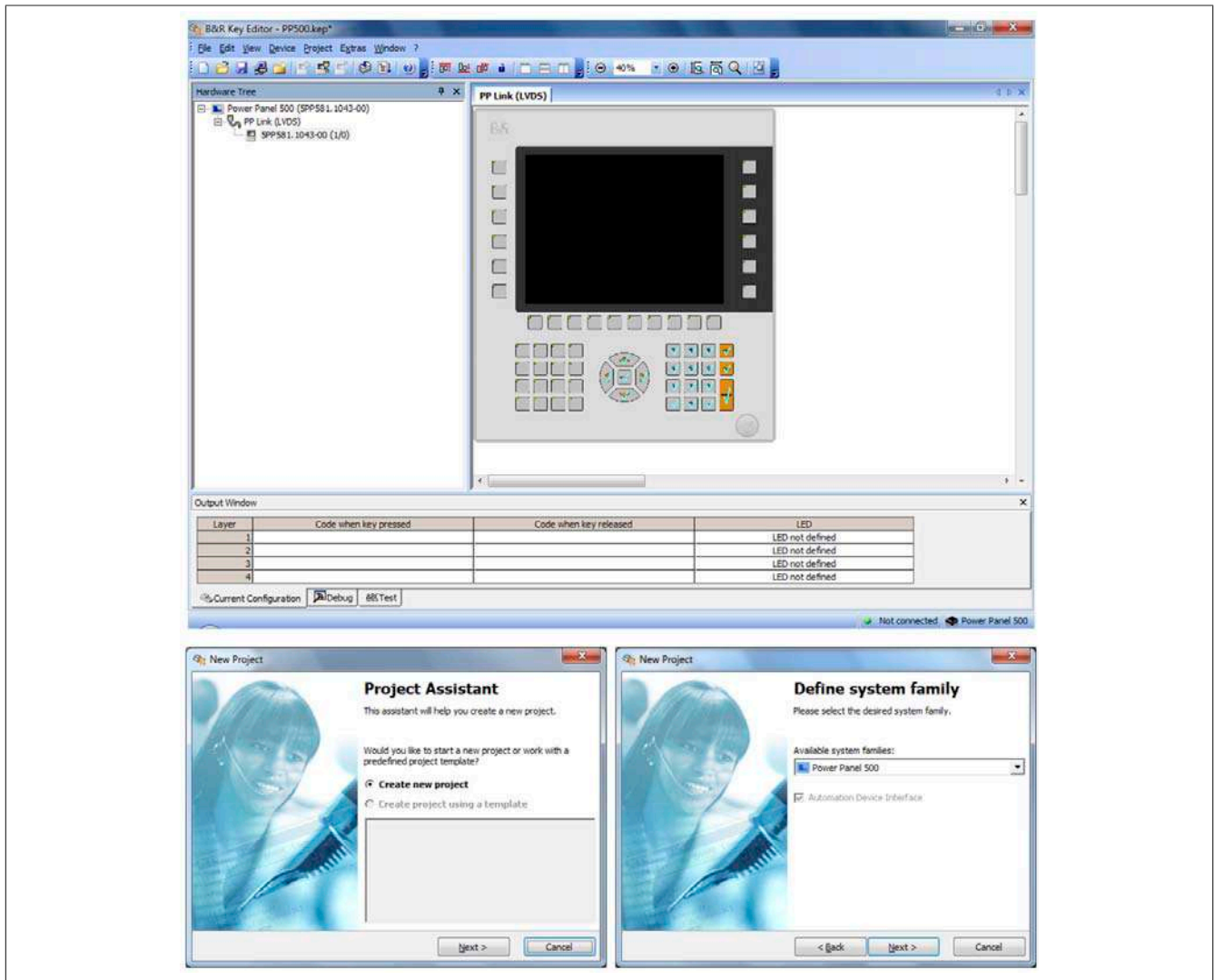

Figure 143: B&R Key Editor screenshots (version 3.50)

Features:

- Configuration of normal keyboard keys (A, B, C, etc.)
- Keyboard shortcuts (CTRL+C, SHIFT+DEL, etc.) using only one key
- Special key functions (change brightness, etc.)
- Assignment of functions to LEDs (HDD access, power, etc.)
- 4 assignments possible per key (using layers)
- Configuration of the panel locking time when multiple Automation Panel 900 devices are connected to Automation PC and Panel PC devices.

The following systems are supported (version 3.50):

- Automation PC 510
- Automation PC 511
- Automation PC 620
- Automation PC 810
- Automation PC 820
- Automation PC 910
- Automation PC 2100
- Automation Panel 800
- Automation Panel 830

- Automation Panel 900
- Automation Panel 9x3 / 9xD
- IPC2000, IPC2001, IPC2002
- IPC5000, IPC5600
- IPC5000C, IPC5600C
- Mobile Panel 40/50
- Mobile Panel 100/200
- Panel PC 300
- Panel PC 700
- Panel PC 800
- Panel PC 900
- Panel PC 2100
- Power Panel 100/200
- Power Panel 300/400
- Power Panel 500

A detailed guide for configuring keys and LEDs can be found in the B&R Key Editor's help system. The B&R Key Editor is available at no cost in the Downloads section of the B&R website (www.br-automation.com). It can also be found on the B&R HMI Drivers & Utilities DVD (model number 5SWHMI.0000-00).

Chapter 5 • Standards and certifications

1 Standards and guidelines

1.1 CE mark



Product complies with all applicable directives and their harmonized EN standards.

1.2 EMC directive

These devices meet the requirements of EC directive "2004/108/EC Electromagnetic compatibility" and are designed for the following areas:

EN 61131-2:2007	Programmable logic controllers - Part 2: Equipment requirements and tests
EN 61000-6 -2:2005	Electromagnetic compatibility (EMC) - Part 6-2: Generic standards - Immunity for industrial environments
EN 61000-6 -4:2007	Electromagnetic compatibility (EMC) - Part 6-4: Generic standards - Emission standard for industrial environments

1.3 Low voltage directive

These devices satisfy the requirements of EC directive "2006/95/EC Low voltage directive" and are designed for the following areas:

EN 61131-2:2007	Programmable logic controllers - Part 2: Equipment requirements and tests
EN 60204-1:2006 + A1:2009	Safety of machinery - Electrical equipment of machines - Part 1: General requirements

2 Certifications

Danger!

A complete system can only receive certification if ALL of the individual components it includes have the applicable certifications. If an individual component is being used that DOES NOT have an applicable certification, then the complete system WILL NOT receive certification.

B&R products and services comply with applicable standards. This includes international standards from organizations such as ISO, IEC and CENELEC, as well as national standards from organizations such as UL, CSA, FCC, VDE, ÖVE, etc. We are committed to ensuring the reliability of our products in an industrial environment.

Unless otherwise specified, the following certifications apply:

2.1 UL certification



Products with this mark have been tested by Underwriters Laboratories and are listed as "Industrial Control Equipment". This mark is valid for the USA and Canada and simplifies the certification of your machines and systems in these areas.

Underwriters Laboratories (UL) in accordance with the UL508 standard - 17th Edition Canadian (CSA) standard in accordance with C22.2 No. 142-M1987

2.2 GOST-R



Products with this mark have been certified by an accredited testing laboratory and have been approved for import to the Russian Federation (based on CE compliance).

Chapter 6 • Accessories

The following accessories have successfully completed functional testing at B&R and are approved for use with this device. Nevertheless, it is important to observe any limitations that may apply to the complete system when operated with other individual components. When operating the complete system, the specifications for the individual components must be observed.

All components listed in this manual have been subjected to extensive system and compatibility testing and are approved for use. B&R can make no guarantee regarding the functionality of non-approved accessories.

1 Replacement CMOS batteries

1.1 0AC201.91 / 4A0006.00-000

1.1.1 General information

This lithium battery is needed to back BIOS CMOS data and the real-time clock (RTC).

The battery is subject to wear and must be replaced when the battery power is insufficient ("Bad" status).

1.1.2 Order data

Model number	Short description	Figure
	Batteries	
0AC201.91	Lithium batteries 4 pcs., 3 V / 950 mAh button cell We hereby state that the lithium cells contained in this shipment qualify as "partly regulated". Handle with care. If the package is damaged, inspect the cells, repack intact cells and protect the cells against short circuit. For emergency information, call RENATA SA at +41 61 319 28 27.	
4A0006.00-000	Lithium battery, 3 V / 950 mAh, button cell	

Table 209: 0AC201.91, 4A0006.00-000 - Order data

1.1.3 Technical data

Warning!

The battery is only permitted to be replaced by a Renata CR2477N battery. The use of another battery may present a risk of fire or explosion.

The battery may explode if handled improperly. Do not recharge, disassemble or dispose of in fire.

Information:

The following characteristics, features and limit values only apply to this accessory and can deviate from those specified for the complete system. The data specifications for the complete system take precedence over those of individual components.

Product ID	0AC201.91	4A0006.00-000
General information		
Storage time	Max. 3 years at 30°C	
Certification		
CE	Yes	
cULus	Yes	
Electrical characteristics		
Capacity	950 mAh	
Self-discharging	<1% per year (at 23°C)	
Voltage range	3 V	

Table 210: 0AC201.91, 4A0006.00-000 - Technical data

Product ID	0AC201.91	4A0006.00-000
Environmental conditions		
Temperature Storage	-20 to 60°C	
Relative humidity Operation	0 to 95%	
Storage	0 to 95%	
Transport	0 to 95%	

Table 210: 0AC201.91, 4A0006.00-000 - Technical data

2 Power connectors

2.1 0TB103.9x

2.1.1 General information

This single-row, 3-pin 0TB103 terminal block is used to connect the voltage supply.

2.1.2 Order data

Model number	Short description	Figure
	Terminal blocks	
0TB103.9	Connector 24 VDC - 3-pin female - Screw clamps 3.31 mm ²	
0TB103.91	Connector 24 VDC - 3-pin female - Cage clamps 3.31 mm ²	

Table 211: 0TB103.9, 0TB103.91 - Order data

2.1.3 Technical data

Information:

The following characteristics, features and limit values only apply to this accessory and can deviate from those specified for the complete system. The data specifications for the complete system take precedence over those of individual components.

Product ID	0TB103.9	0TB103.91
General information		
Certification		
CE		Yes
cULus		Yes
cULus HazLoc Class 1 Division 2	Yes ¹⁾	Yes ²⁾
GL	Yes ¹⁾	Yes ²⁾
Terminal block		
Note	Protected against vibration by the screw flange Nominal values according to UL	Protected against vibration by the screw flange Nominal values according to UL
Number of pins	3 (female)	
Type of terminal clamp	Screw clamps	Cage clamps ³⁾
Cable type	Only copper wires (no aluminum wires!)	
Distance between contacts	5.08 mm	
Connection cross section		
AWG wire	26 to 14 AWG	26 to 12 AWG
Wire end sleeves with plastic covering		0.20 to 1.50 mm ²
Solid wires		0.20 to 2.50 mm ²
Fine strand wires	0.20 to 1.50 mm ²	0.20 to 2.50 mm ²
With wire end sleeves		0.20 to 1.50 mm ²
Tightening torque	0.4 Nm	-
Electrical characteristics		
Nominal voltage	300 V	
Nominal current ⁴⁾	10 A / contact	
Contact resistance	≤5 mΩ	

Table 212: 0TB103.9, 0TB103.91 - Technical data

- 1) Yes, although applies only if all components installed within the complete system have this certification
- 2) Yes, although applies only if all components installed within the complete system have this certification.
- 3) Cage clamp terminal blocks cannot be used side-by-side.
- 4) The limit data for each I/O module must be taken into consideration.

3 DVI/Monitor adapter

3.1 5AC900.1000-00

3.2 General information

This adapter enables a standard monitor to be connected to the DVI-I interface.

3.3 Order data

Model number	Short description	Figure
	Miscellaneous	
5AC900.1000-00	DVI (male connector) to CRT (female connector) adapter. For connecting a standard monitor to a DVI-I interface.	

Table 213: 5AC900.1000-00 - Order data

4 USB interface cover

4.1 5AC900.1201-00

4.1.1 General information

Flat front-side USB interface cover for Automation Panel 900, Power Panel 500, Panel PC 700 and Panel PC 800 devices.

4.1.2 Order data

Model number	Short description	Figure
	Accessories	
5AC900.1201-00	USB interface cover M20 IP65 flat	

Table 214: 5AC900.1201-00 - Order data

4.2 5AC900.1201-01

4.2.1 General information

Round front-side knurled USB interface cover (with anti-loss strap) for Automation Panel 900, Power Panel 500, Panel PC 700 and Panel PC 800 devices.

4.2.2 Order data

Model number	Short description	Figure
	Accessories	
5AC900.1201-01	USB interface cover M20 IP65 curved	

Table 215: 5AC900.1201-01 - Order data

5 Clamping blocks

5.1 5AC900.BLOC-00

5.1.1 General information

These replacement clamping blocks are used to mount B&R panel devices.

5.1.2 Order data

Model number	Short description	Figure
	Accessories	
5AC900.BLOC-00	Terminal block with brackets, 10 pcs.; replacement part	

Table 216: 5AC900.BLOC-00 - Order data

6 Uninterruptible power supply

With an optionally integrated UPS, the B&R Industrial PC makes sure that the PC system completes write operations even when a power failure occurs. If the UPS detects a power failure, it switches to battery operation immediately without interruption. Any running programs will be properly terminated by the UPS. This eliminates the chance of inconsistent data (only works if the UPS has already been configured and the drive is enabled).

Information:

- **The monitor/panel is not buffered by the UPS and will shut off when the power fails.**
- **More detailed information about uninterruptible power supplies can be found in the user's manual for the external UPS. This can be downloaded from the B&R website.**

Because the charging circuit is integrated in the housing of the B&R Industrial PC, installation has been simplified to merely attaching the connection cable to the battery unit mounted next to the PC.

Special emphasis was placed on ease of maintenance when the battery unit was designed. Batteries are easily accessible from the front and can be replaced in just a few moments when servicing.

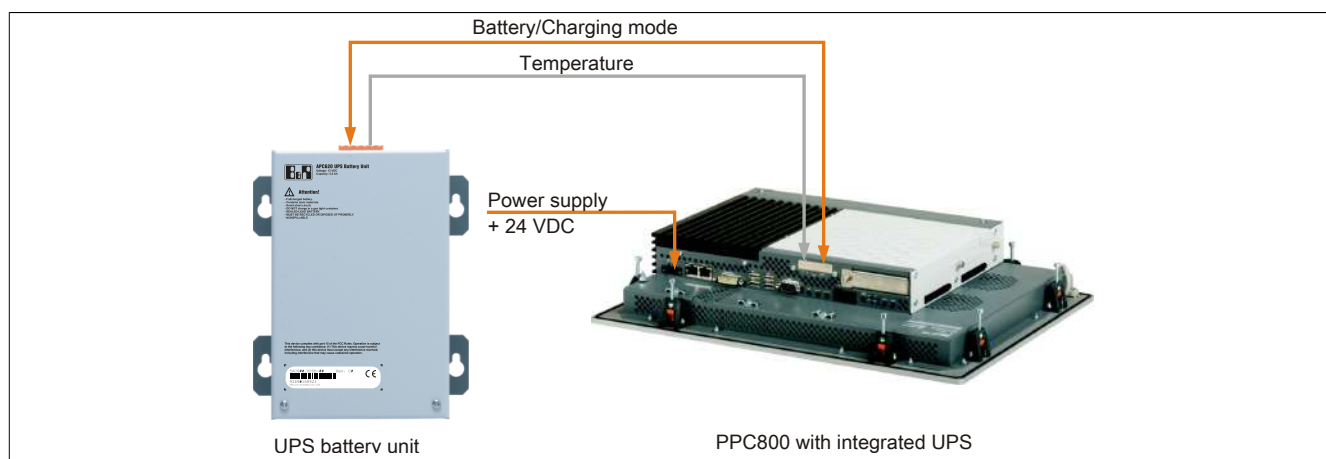

Figure 144: UPS principle

6.1 Features

- Long-lasting, maintenance-free rechargeable batteries
- Communication via integrated interfaces
- Temperature sensor
- Driver software
- Deep discharge protection

6.2 Requirements

- A suitable system unit
- Add-on UPS module 5AC600.UPSI-00
- Battery unit 5AC600.UPSB-00
- UPS connection cable 0.5 m (5CAUPS.0005-00) or 3 m (5CAUPS.0030-00)
- Configuration of the B&R UPS in the ADI Control Center

6.3 5AC600.UPSI-00

6.3.1 General information

This add-on UPS module can easily be installed in an appropriate system unit (for a list of required revisions, see section 6.2 "Requirements" on page 276).

6.3.2 Order data

Model number	Short description	Figure
	Uninterruptible power supplies	
5AC600.UPSI-00	UPS module for APC620, APC810, PPC800; for system units 5PC600.SX01-00 (beginning with rev. H0), 5PC600.SX02-00 (beginning with rev. G0), 5PC600.SX02-01 (beginning with rev. H0), 5PC600.SX05-00 (beginning with rev. F0), 5PC600.SX05-01 (beginning with rev. F0), 5PC600.SF03-00 (beginning with rev. A0), 5PC810.SX*, 5PC820.1505-00, 5PC820.1906-00. Order cable (5CAUPS.0005-00 or 5CAUPS.0030-00) and battery unit (5AC600.UPSB-00) separately.	
	Required accessories	
	Uninterruptible power supplies	
5AC600.UPSB-00	Battery unit 5 Ah; for APC620, APC810 or PPC800 UPS	
5CAUPS.0005-00	UPS cable 0.5 m; for UPS 5AC600.UPSI-00	
5CAUPS.0030-00	UPS cable 3 m - For 5AC600.IUPS-00	

Table 217: 5AC600.UPSI-00 - Order data

6.3.3 Technical data

Information:

The following characteristics, features and limit values only apply to this accessory and can deviate from those specified for the complete system. The data specifications for the complete system take precedence over those of individual components.

Product ID	5AC600.UPSI-00
General information	
Certification	
CE	Yes
cULus	Yes
GOST-R	Yes
GL	Yes ¹⁾
Electrical characteristics	
Power consumption	Max. 7.5 watts
Power failure bypass	Max. 20 min at 150 W load
Deep discharge protection	Yes, at 10 V on the battery unit
Short circuit protection	No
Battery charging data	
Charging current	Max. 0.5 A
Switching threshold	
Battery operation	13 V
Mains operation	15 V

Table 218: 5AC600.UPSI-00 - Technical data

1) Yes, although applies only if all components installed within the complete system have this certification

6.3.4 Installation

This module is installed using the materials included in delivery. For more information regarding installation, see chapter 7 "Maintenance and service".

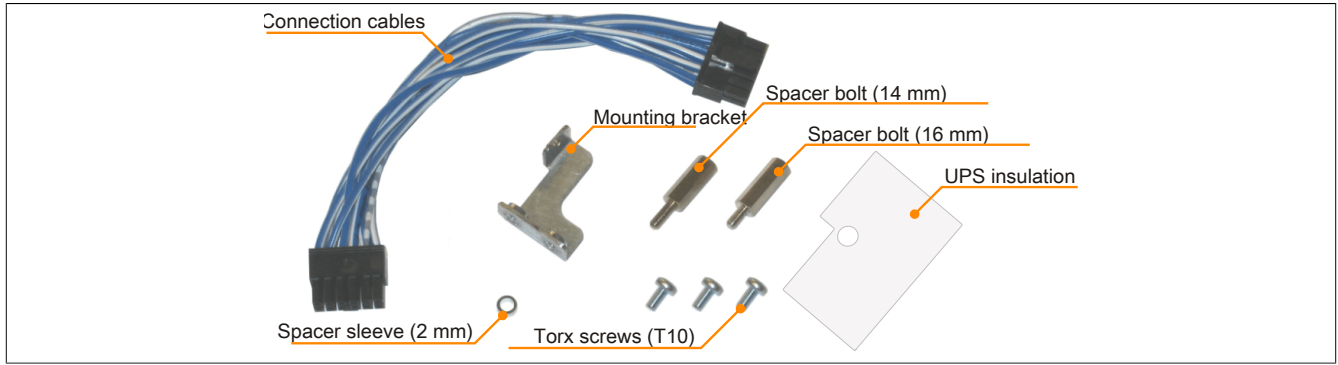

Figure 145: 5AC600.UPI-00 Add-on UPS module - Installation materials

6.4 5AC600.UPSB-00

6.4.1 General information

The battery unit has a limited service life and should be replaced regularly (after the specified service life at the latest).

6.4.2 Order data

Model number	Short description	Figure
	Uninterruptible power supplies	
5AC600.UPSB-00	Battery unit 5 Ah; for APC620, APC810 or PPC800 UPS	

Table 219: 5AC600.UPSB-00 - Order data

6.4.3 Technical data

Information:

The following characteristics, features and limit values only apply to this accessory and can deviate from those specified for the complete system. The data specifications for the complete system take precedence over those of individual components.

Product ID	5AC600.UPSB-00	
Revision	D0	E0
General information		
Battery		
Type	Energys Cyclon 12 V 5 Ah (6 connected in series)	
Service life	Up to 15 years at 20°C / 10 years at 25°C. ¹⁾	
Execution	Single cell	
Temperature sensor	NTC resistance	
Maintenance interval during storage	6 month interval between charges	
Certification		
CE	Yes	
cULus	Yes	
GOST-R	Yes	
GL	Yes ²⁾	
Charge duration when battery low	Typ. 15 hours	
Electrical characteristics		
Nominal voltage	12 V	
Battery current	Max. 8 A	
Capacity	5 Ah	
Fuse ³⁾	No ⁴⁾	Yes ⁴⁾
Deep discharge voltage	10 V	
Environmental conditions		
Temperature		
Charging mode	-30 to 60°C	
Operation	-40 to 80°C	
Storage	-65 to 80°C	
Transport	-65 to 80°C	
Relative humidity		
Operation	5 to 95%, non-condensing	
Storage	5 to 95%, non-condensing	
Transport	5 to 95%, non-condensing	
Altitude		
Operation	Max. 3000 m	

Table 220: 5AC600.UPSB-00, 5AC600.UPSB-00 - Technical data

Product ID	5AC600.UPSB-00
Mechanical characteristics	
Dimensions	
Width	104 mm ⁵⁾
Length	170.5 mm
Height	87.5 mm
Weight	Approx. 3200 g

Table 220: 5AC600.UPSB-00, 5AC600.UPSB-00 - Technical data

- 1) Depending on the charging and discharging cycles (up to 80% battery capacity).
- 2) Yes, although applies only if all components installed within the complete system have this certification
- 3) 25 A fuse. Replacement fuses can be ordered separately whenever needed.
- 4) The fuse can be installed later in revisions up to and including D0. More information can be found in the "Maintenance and service" chapter of the APC810 and PPC800 user's manuals.
- 5) Dimensions without mounting clips.

6.4.4 Service life

The following diagram shows the relationship between ambient temperature and service life.

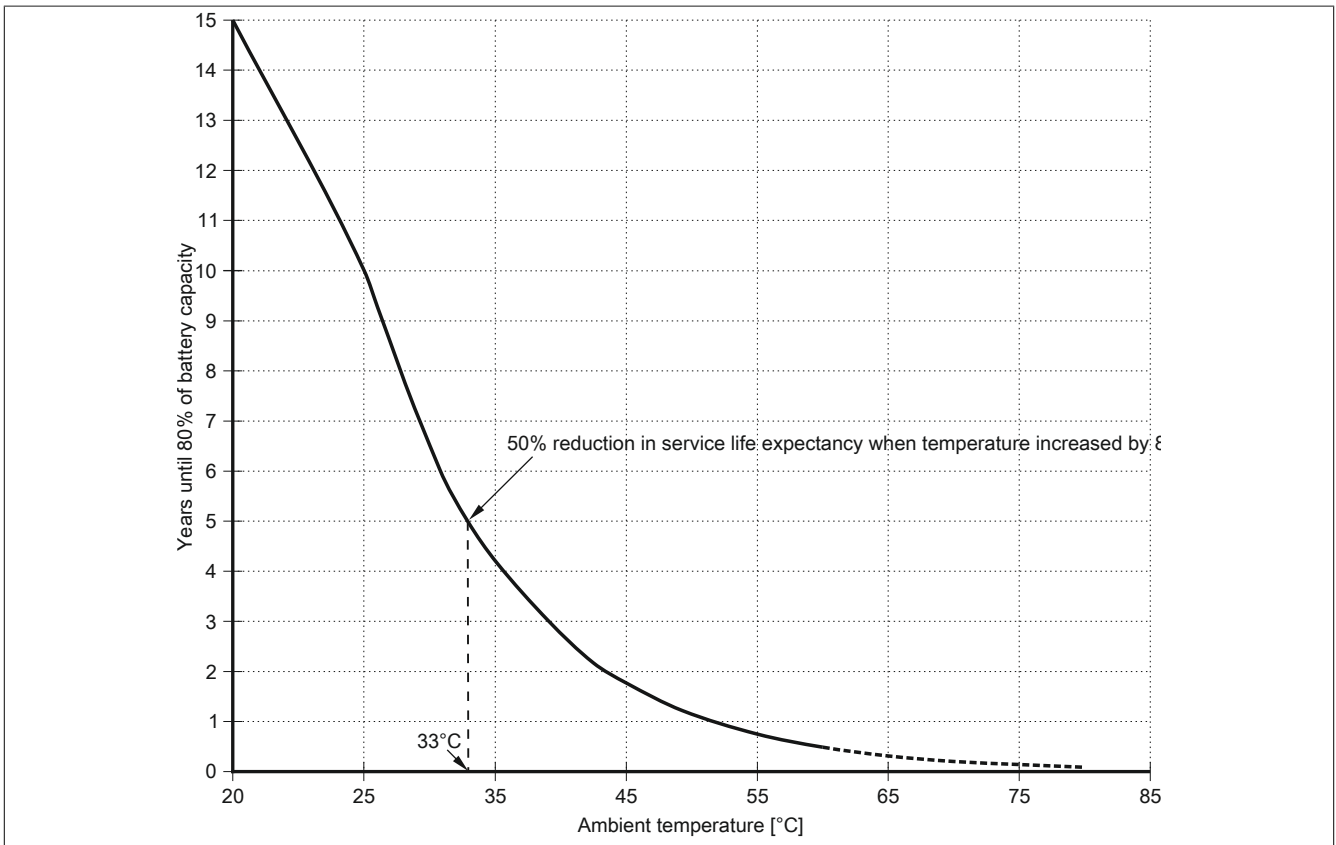

6.4.5 Deep discharge cycles

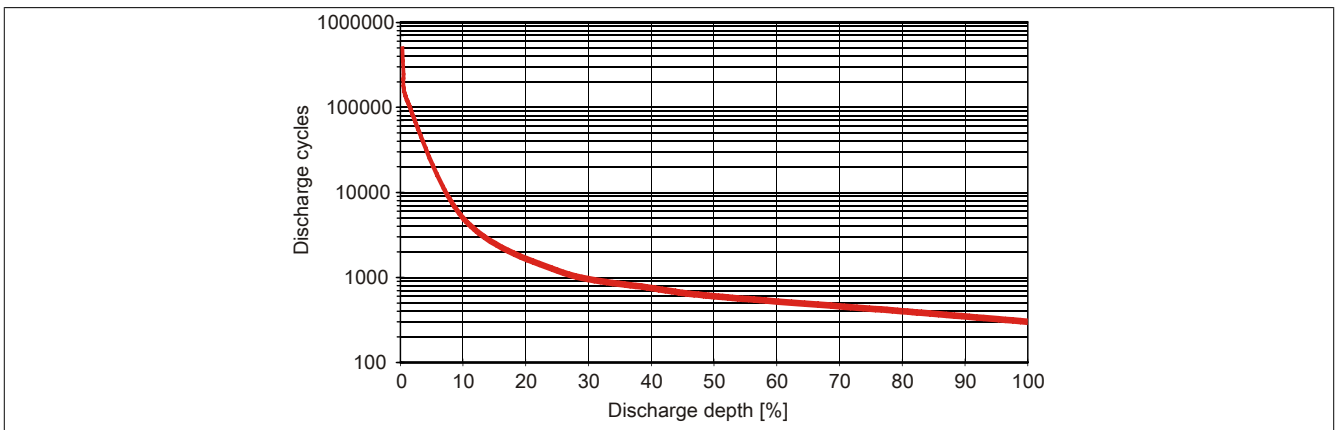

Figure 146: Deep discharge cycles

6.4.6 Dimensions

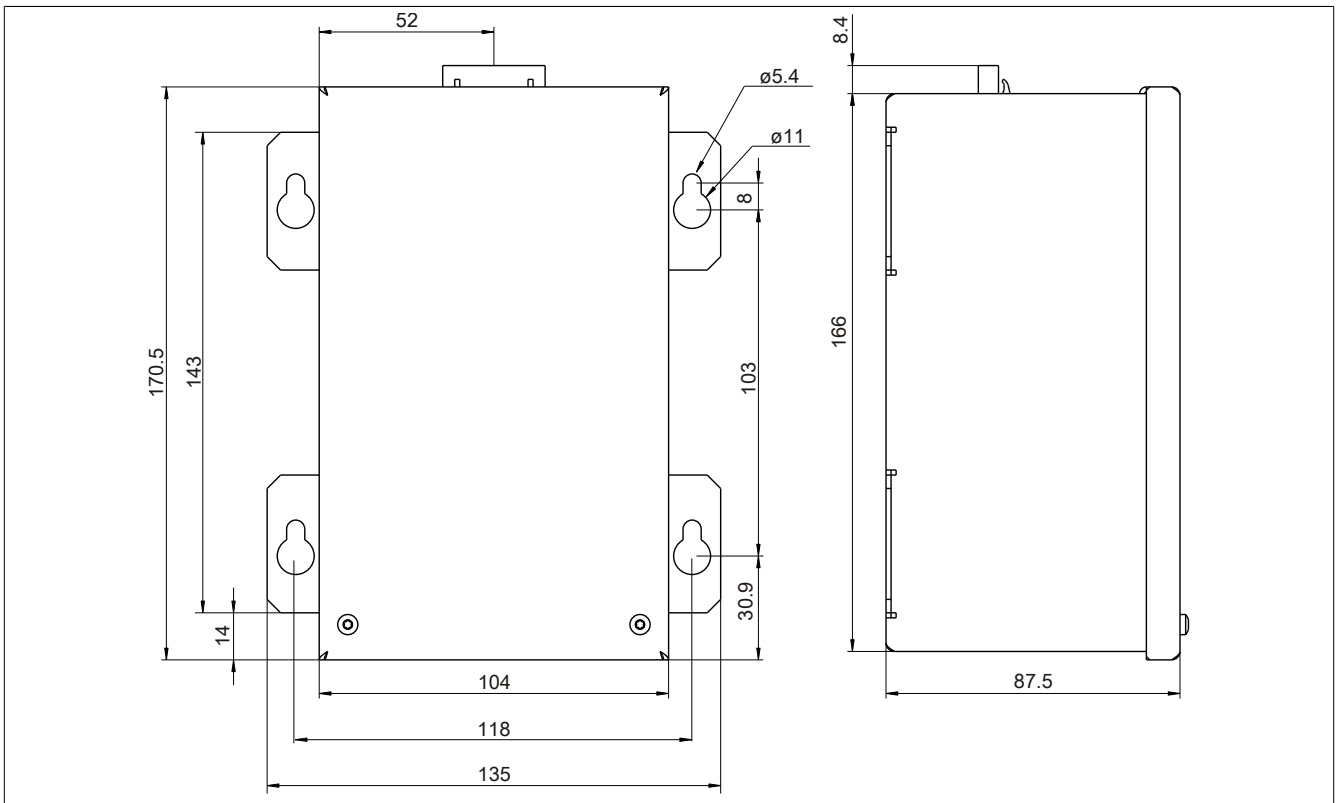

Figure 147: 5PC600.UPSB-00 - Dimensions

6.4.7 Drilling template

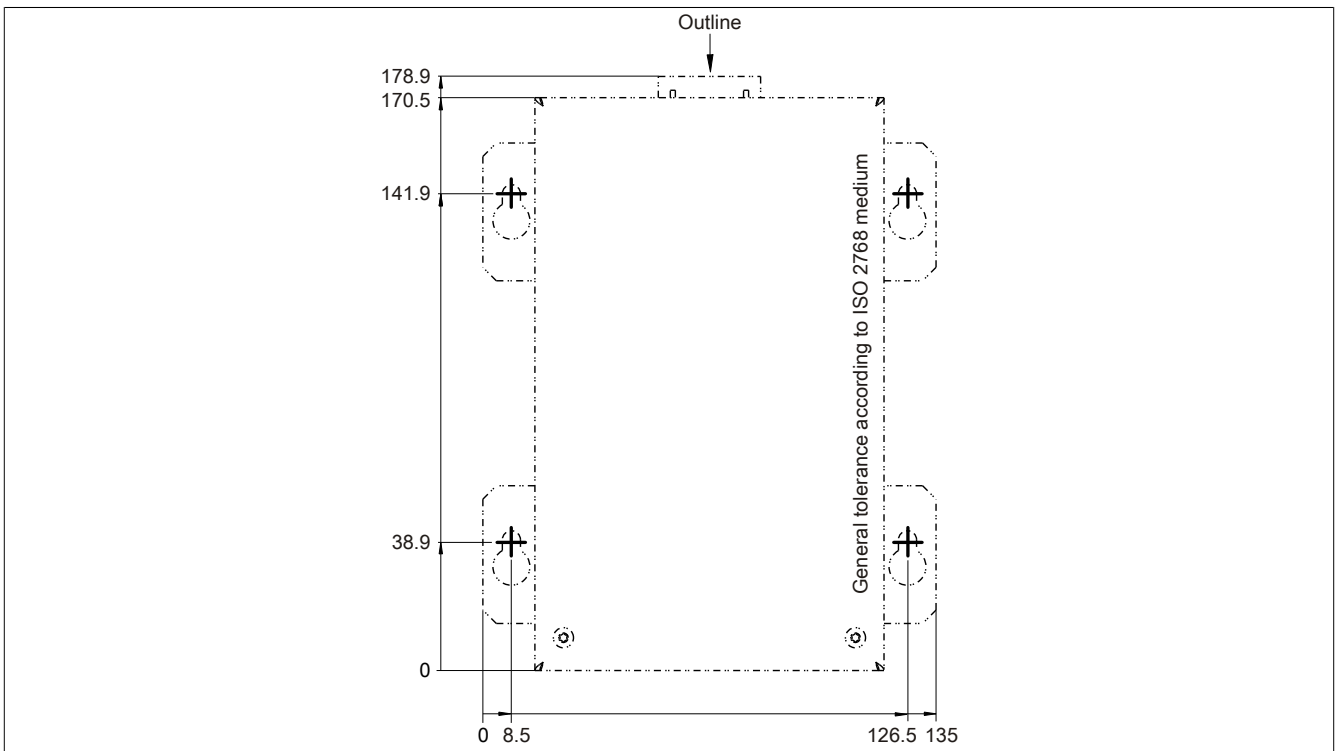

Figure 148: 5PC600.UPSB-00 - Drilling template

6.4.8 Installation instructions

Due to the unique construction of these batteries, they can be stored and operated in any position.

6.5 5CAUPS.00xx-00

6.5.1 General information

The UPS connection cable establishes the connection between the add-on UPS module (5AC600.UPSI-00) and the battery unit (5AC600.UPSB-00). It is available in lengths of 0.5 m and 3 m.

6.5.2 Order data

Model number	Short description	Figure
	Uninterruptible power supplies	
5CAUPS.0005-00	UPS cable 0.5 m; for UPS 5AC600.UPSI-00	
5CAUPS.0030-00	UPS cable 3 m - For 5AC600.IUPS-00	

Table 221: 5CAUPS.0005-00, 5CAUPS.0030-00 - Order data

6.5.3 Technical data

Information:

The following characteristics, features and limit values only apply to this accessory and can deviate from those specified for the complete system. The data specifications for the complete system take precedence over those of individual components.

Product ID	5CAUPS.0005-00	5CAUPS.0030-00
General information		
Certification		
CE		Yes
cULus		Yes
GOST-R		Yes
GL		Yes ¹⁾
Cable construction		
Wire cross section		2x 0.5 mm ² (AWG 20) 4x 2.5 mm ² (AWG 13)
Conductor resistance		At 0.5 mm ² max. 39 Ω/km At 2.5 mm ² max. 7.98 Ω/km
Outer sheathing		
Material		Thermoplastic PVC-based material
Color		Window gray (similar to RAL 7040)
Connector		
Type	6-pin male connector with clamping yoke / 6-pin female multipoint connector with clamping yoke	
Electrical characteristics		
Operating voltage	Max. 300 V	
Peak operating voltage	Typically 12 VDC / max. 15 VDC	
Test voltage		
Wire/Wire	1500 V	
Current load	10 A at 20°C	
Environmental conditions		
Temperature		
Moving	-5 to 80°C	
Static	-30 to 80°C	
Mechanical characteristics		
Dimensions		
Length	0.5 m	3 m
Diameter	8.5 mm ±0.2 mm	
Flex radius		
Moving	10x wire cross section	
Fixed installation	5x wire cross section	
Weight	Approx. 100 g	Approx. 470 g

Table 222: 5CAUPS.0005-00, 5CAUPS.0030-00 - Technical data

1) Yes, although applies only if all components installed within the complete system have this certification

6.6 5AC600.UPSF-00

6.6.1 General information

The UPS fuse kit can be used to add a fuse for the 5AC600.UPSB-00 battery unit.

Information about installing the 5AC600.UPSF-00 fuse kit can be found in the section "Installing the UPS fuse kit on the battery unit" on page 353.

Information:

The 5AC600.UPSF-00 UPS fuse kit is only needed for battery units up to and including revision D0. A 25 A fuse is integrated on the connector circuit board beginning with revision E0.

6.6.2 Order data

Model number	Short description	Figure
	Uninterruptible power supplies	
5AC600.UPSF-00	UPS fuse kit for battery unit 5AC600.UPSB-00 up to revision D0.	
	Optional accessories	
	Uninterruptible power supplies	
5AC600.UPSF-01	UPS fuse, 5 pcs.	

Table 223: 5AC600.UPSF-00 - Order data

6.7 5AC600.UPSF-01

6.7.1 General information

These 25 A fuses are replacement parts for the 5AC600.UPSB-00 battery unit (beginning with revision E0) as well as the 5AC600.UPSF-00 fuse kit.

6.7.2 Order data

Model number	Short description	Figure
	Uninterruptible power supplies	
5AC600.UPSF-01	UPS fuse, 5 pcs.	

Table 224: 5AC600.UPSF-01 - Order data

7 External UPS

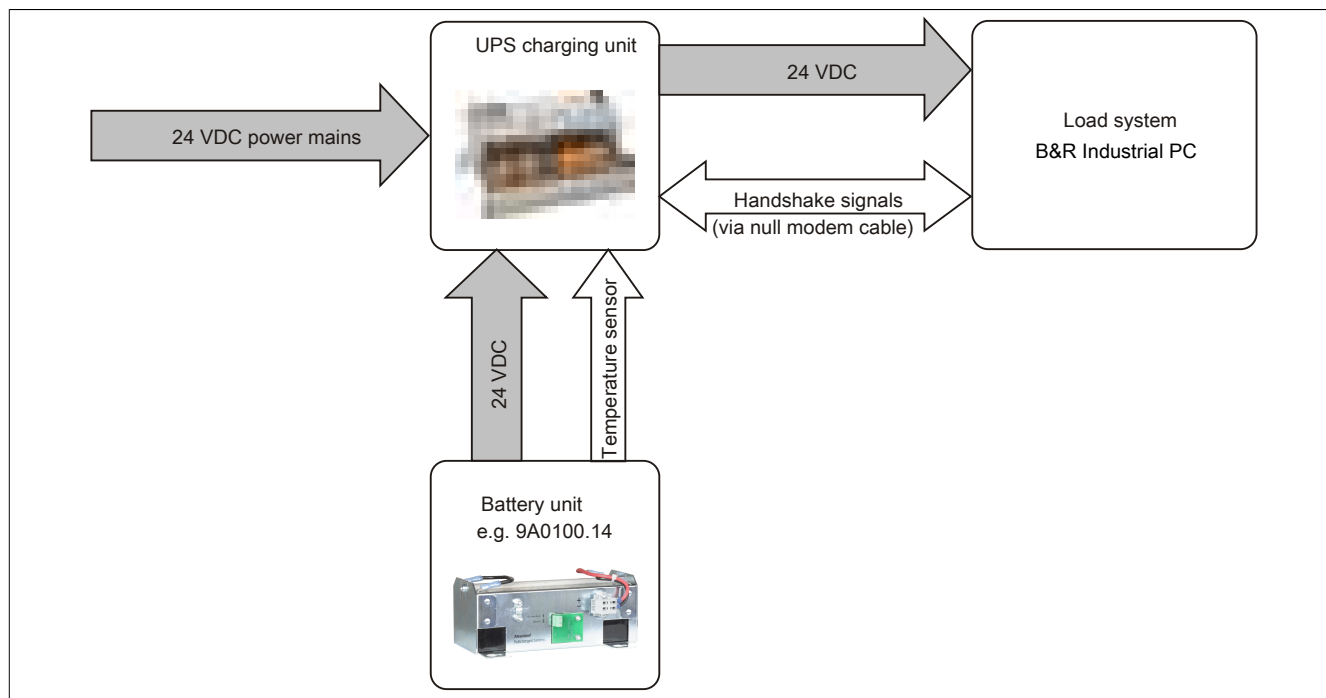

Figure 149: Block diagram of the complete system

7.1 General information

A UPS charging unit, battery unit and null modem cable are required to provide power from an external UPS.

In normal operation, the 24 VDC supply voltage is routed directly to the load system. If the mains supply voltage fails, the UPS battery unit powers the load system power so that shutdown can take place properly without losing data.

Data and commands are exchanged between the UPS and the load system via the handshake signals on the RS232 interface.

Additional information about external UPS is available in the UPS user's manual, which can be downloaded from the B&R website (www.br-automation.com).

7.2 Order data

Model number	Short description	Figure
24 VDC UPS modules		
9A0100.11	UPS 24 VDC, 24 VDC input, 24 VDC output, serial interface	
Battery units		
9A0100.12	UPS battery unit type A, 24 V, 7 Ah, incl. battery cage	
Replacement batteries		
9A0100.13	UPS batteries type A (replacement part), 2x 12 V, 7 Ah, for battery unit 9A0100.12	
9A0100.14	UPS battery unit type B, 24 V, 2.2 Ah, incl. battery cage	
9A0100.15	UPS batteries type B (replacement part), 2x 12 V, 2.2 Ah, for battery unit 9A0100.14	
9A0100.16	UPS battery unit type C, 24 V, 4.5 Ah, incl. battery cage	
9A0100.17	UPS batteries type C (replacement part), 2x 12 V, 4.5 Ah, for battery unit 9A0100.16	
Required accessories		
Battery units		
9A0100.12	UPS battery unit type A, 24 V, 7 Ah, incl. battery cage	
9A0100.14	UPS battery unit type B, 24 V, 2.2 Ah, incl. battery cage	
9A0100.16	UPS battery unit type C, 24 V, 4.5 Ah, incl. battery cage	
Cables		
9A0017.01	RS232 null modem cable, 0.6 m, for connecting UPS and IPC (9-pin female DSUB connector - 9-pin female DSUB connector)	
9A0017.02	RS232 null modem cable, 1.8 m, for connecting UPS and IPC (9-pin female DSUB connector - 9-pin female DSUB connector)	
Optional accessories		
Replacement batteries		

Table 225: 9A0100.11, 9A0100.12, 9A0100.13, 9A0100.14, 9A0100.15, 9A0100.16, 9A0100.17 - Order data

Model number	Short description	Figure
9A0100.13	UPS batteries type A (replacement part), 2x 12 V, 7 Ah, for battery unit 9A0100.12	
9A0100.15	UPS batteries type B (replacement part), 2x 12 V, 2.2 Ah, for battery unit 9A0100.14	
9A0100.17	UPS batteries type C (replacement part), 2x 12 V, 4.5 Ah, for battery unit 9A0100.16	

Table 225: 9A0100.11, 9A0100.12, 9A0100.13, 9A0100.14, 9A0100.15, 9A0100.16, 9A0100.17 - Order data

8 PCI plug-in cards

8.1 5ACPCI.ETH1-01

8.1.1 General information

These universal (3.3 V and 5 V) half-size PCI Ethernet card have a 10/100 Mbit/s network connection and can be inserted and operated in a standard 16-bit PCI slot as an additional network interface.

- PCI Ethernet card
- 1 network connection (10/100 Mbit/s)

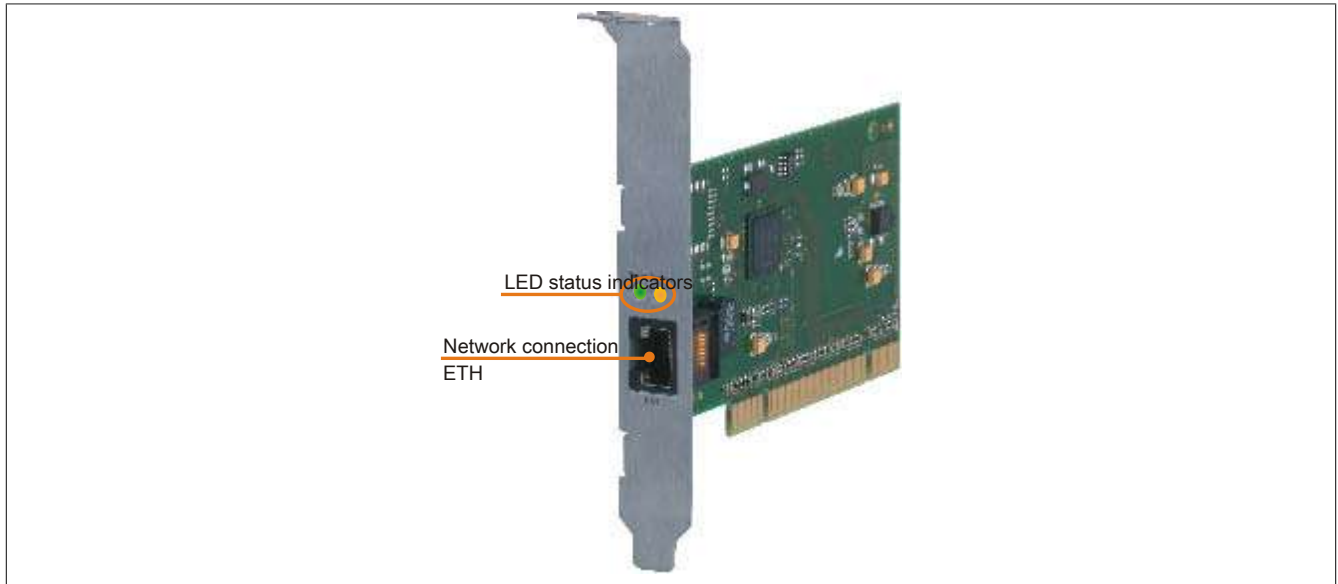

Figure 150: 5ACPCI.ETH1-01 - PCI 10/100 Ethernet card

8.1.2 Order data

Model number	Short description	Figure
5ACPCI.ETH1-01	Accessories PCI Ethernet card 1x 10/100	

Table 226: 5ACPCI.ETH1-01 - Order data

8.1.3 Technical data

Product ID	5ACPCI.ETH1-01
General information	
B&R ID code	0xA58A
Diagnostics	
Data transfer	Yes, using status LED
Certification	
CE	Yes
cULus	Yes
cULus HazLoc Class 1 Division 2	Yes ¹⁾
GOST-R	Yes
GL	Yes ¹⁾

Table 227: 5ACPCI.ETH1-01 - Technical data

Product ID	5ACPCI.ETH1-01
Interfaces	
Ethernet	
Quantity	1
Controller	Intel 82551ER
Execution	Shielded RJ45 port
Transfer rate	10/100 Mbit/s
Cable length	Max. 100 m between two stations (segment length)

Table 227: 5ACPCI.ETH1-01 - Technical data

1) Yes, although applies only if all components installed within the complete system have this certification

8.1.3.1 Ethernet interface

Information:

The following characteristics, features and limit values only apply to this individual component and can deviate from those specified for the complete system. For the complete system in which this individual component is used, refer to the data given specifically for that device.

Ethernet interface		
Controller	Intel 82551ER	
Power supply	Universal card (2 notches) for 3.3 V or 5 V	
Cabling	S/STP (Cat 5e)	
Transfer rate	10/100 Mbit/s	
Cable length	Max. 100 m (min. Cat 5e)	
LED	On	Off
Green	100 Mbit/s	10 Mbit/s
Orange	Link (Ethernet network connection available)	Activity (blinking - data transfer in progress)

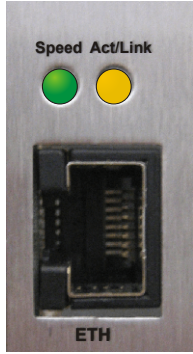

Table 228: 5ACPCI.ETH1-01 - Technical data

8.1.4 Driver support

A special driver is required in order to operate the Intel 82551ER Ethernet controller. Drivers for approved operating systems (Windows XP Professional, Windows XP Embedded and MS-DOS) are available in the Downloads section of the B&R website (www.br-automation.com).

Information:

Required drivers can only be downloaded from the B&R website, not from manufacturer websites.

8.1.5 Dimensions

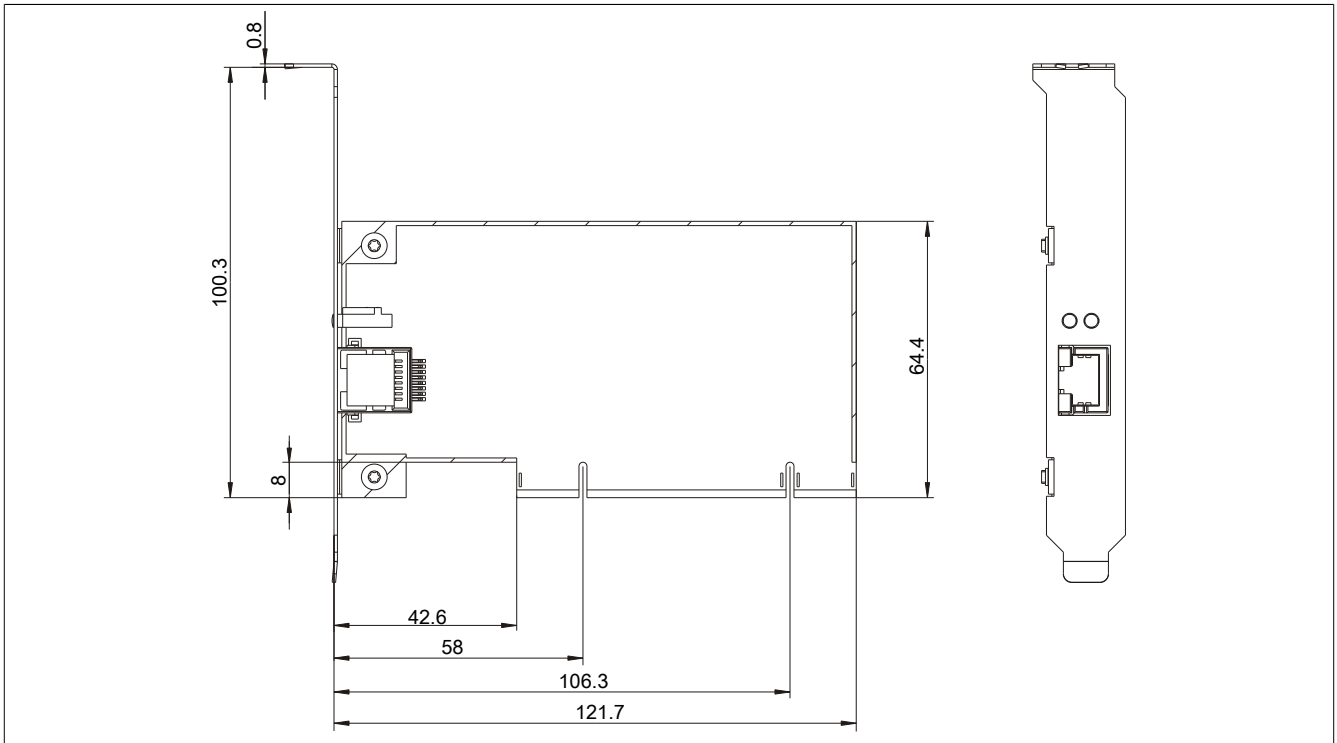

Figure 151: 5ACPCI.ETH1-01 - Dimensions

8.2 5ACPCI.ETH3-01

8.2.1 General information

These universal (3.3 V and 5 V) half-size PCI Ethernet card have three 10/100 Mbit/s network connections and can be inserted and operated in a standard 16-bit PCI slot as an additional network interface.

- PCI Ethernet card
- 3 network connections (10/100 Mbit/s)

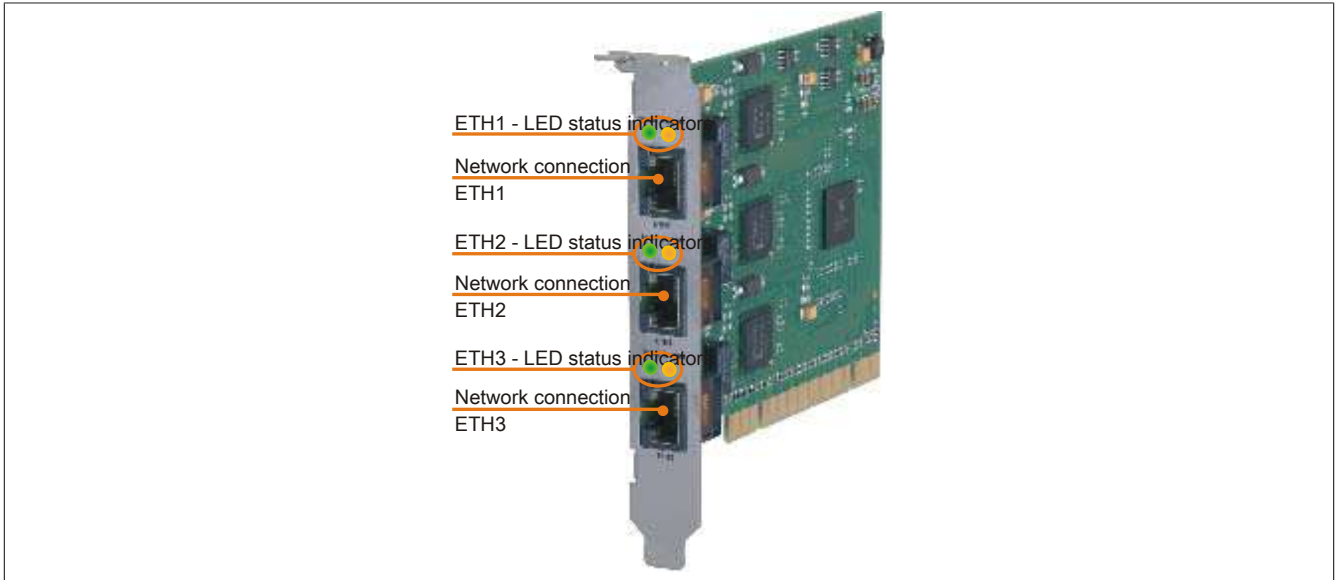

Figure 152: 5ACPCI.ETH3-01 - PCI 10/100 Ethernet card

8.2.2 Order data

Model number	Short description	Figure
	Accessories	
5ACPCI.ETH3-01	PCI Ethernet card 3x 10/100	

Table 229: 5ACPCI.ETH3-01 - Order data

8.2.3 Technical data

Product ID	5ACPCI.ETH3-01
General information	
B&R ID code	0xA58B
Diagnostics	
Data transfer	Yes, using status LED
Certification	
CE	Yes
cULus	Yes
cULus HazLoc Class 1 Division 2	Yes ¹⁾
GOST-R	Yes
GL	Yes ¹⁾

Table 230: 5ACPCI.ETH3-01 - Technical data

Product ID	5ACPCI.ETH3-01
Interfaces	
Ethernet	
Quantity	3
Controller	Intel 82551ER
Execution	Shielded RJ45 port
Transfer rate	10/100 Mbit/s
Cable length	Max. 100 m between two stations (segment length)

Table 230: 5ACPCI.ETH3-01 - Technical data

1) Yes, although applies only if all components installed within the complete system have this certification

8.2.3.1 Ethernet interface

Information:

The following characteristics, features and limit values only apply to this individual component and can deviate from those specified for the complete system. For the complete system in which this individual component is used, refer to the data given specifically for that device.

Ethernet interfaces		
Controller	each with Intel 82551ER	
Power supply	Universal card (2 notches) for 3.3 V or 5 V	
Cabling	S/STP (Cat 5e)	
Transfer rate	10/100 Mbit/s	
Cable length	Max. 100 m (min. Cat 5e)	
LED	On	Off
Green	100 Mbit/s	10 Mbit/s
Orange	Link (Ethernet network connection available)	Activity (blinking - data transfer in progress)

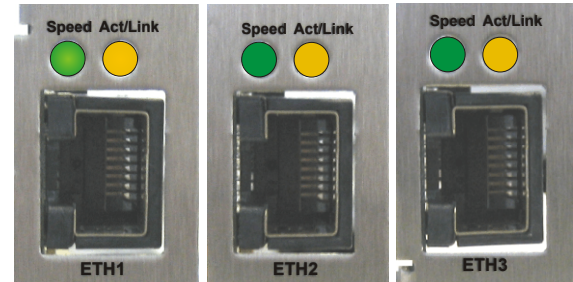

Table 231: 5ACPCI.ETH3-01 - Technical data

8.2.4 Driver support

A special driver is required in order to operate the Intel 82551ER Ethernet controller. Drivers for approved operating systems (Windows XP Professional, Windows XP Embedded and MS-DOS) are available in the Downloads section of the B&R website (www.br-automation.com).

Information:

Required drivers can only be downloaded from the B&R website, not from manufacturer websites.

8.2.5 Dimensions

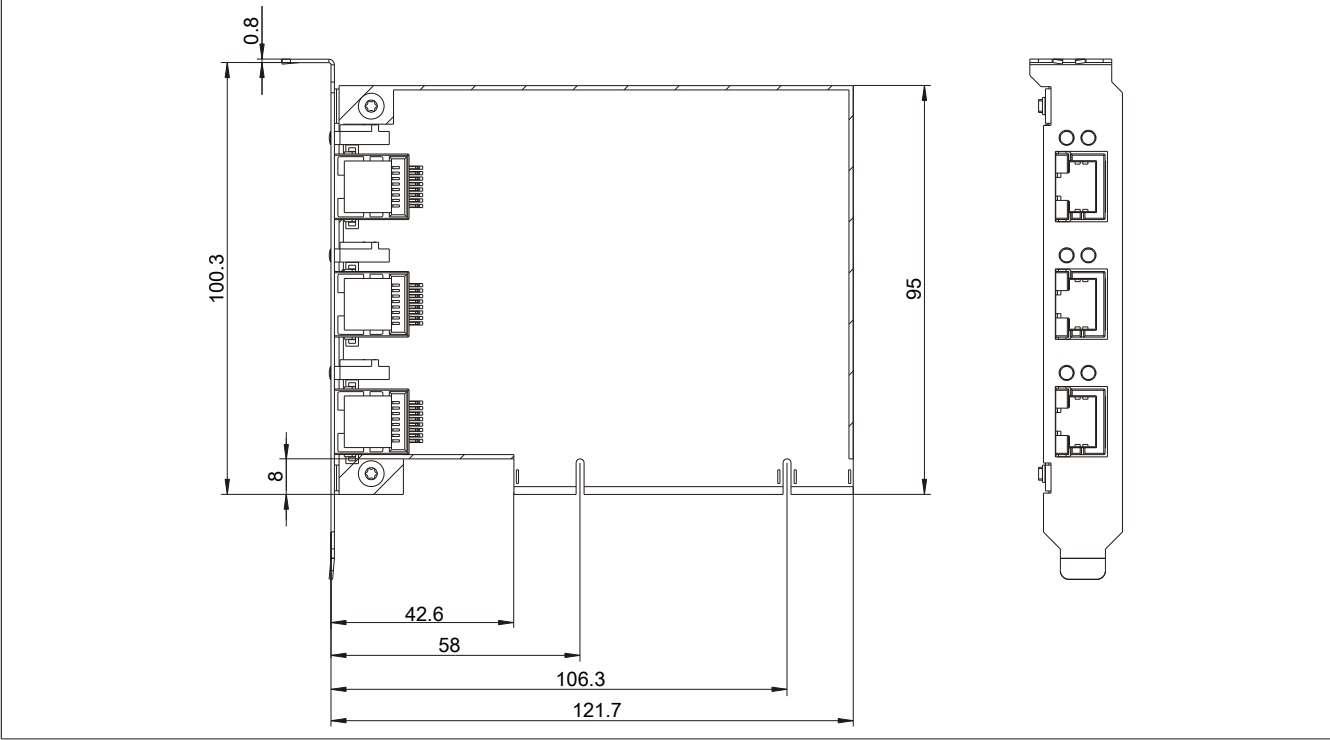

Figure 153: 5ACPCI.ETH3-01 - Dimensions

9 CompactFlash cards

9.1 General information

CompactFlash cards are storage media that are easy to replace. Due to their robustness against environmental influences (e.g. temperature, shock, vibration, etc.), CompactFlash cards are ideal for use as storage media in industrial environments.

9.2 General information

In order to be suited for use in industrial automation, CompactFlash cards must be highly reliable. The following items are very important to achieving the necessary level of reliability:

- The flash technology used
- An efficient algorithm for maximizing service life
- Good mechanisms for detecting and fixing errors in the flash memory

9.2.1 Flash technology

Currently, CompactFlash cards are available with MLC (multi-level cell) and SLC (single-level cell) flash blocks. SLC flash memory has a service life 10 times longer than MLC, which is why only CompactFlash cards with SLC flash blocks are suited for industrial applications.

9.2.2 Wear leveling

Wear leveling is an algorithm that can be used to maximize the service life of a CompactFlash card. There are three different algorithms:

- No wear leveling
- Dynamic wear leveling
- Static wear leveling

The basic idea behind wear leveling is to distribute data over a broad area of blocks or cells on the disk so that the same areas don't have to be cleared and reprogrammed over and over again.

9.2.2.1 No wear leveling

The earliest CompactFlash cards didn't have an algorithm for maximizing service life. The service life of a CompactFlash card was determined only by the guaranteed lifespan of the flash blocks.

9.2.2.2 Dynamic wear leveling

Dynamic wear leveling makes it possible to utilize unused flash blocks when writing to a file.

If the disk is 80% full with files, then only 20% can be used for wear leveling.

The service life of the CompactFlash card is therefore dependent on the amount of unused flash blocks.

9.2.2.3 Static wear leveling

Static wear leveling monitors which data is rarely modified. From time to time, the controller then moves this data to blocks that have already been used frequently in order to prevent further wear on those cells.

9.2.3 ECC error correction

Bit errors can be caused by inactivity or when a certain cell is being operated. Error correction coding (ECC) implemented via hardware or software can detect and correct many errors of this type.

9.2.4 S.M.A.R.T. support

Self-Monitoring, Analysis and Reporting Technology (S.M.A.R.T.) is an industry standard for mass storage devices that has been introduced to monitor important parameters and quickly detect imminent failures. Critical performance and calibration data is monitored and stored in order to help predict the probability of errors.

9.2.5 Maximum reliability

CompactFlash cards used by B&R use SLC flash blocks and static wear leveling together with a powerful ECC algorithm to provide maximum reliability.

9.3 5CFCRD.xxxx-06

9.3.1 General information

Information:

B&R CompactFlash cards 5CFCRD.xxxx-06 and CompactFlash cards from a different manufacturer cannot be used in the same system at the same time. Due to differences in technology (older vs. newer technologies), problems can occur during system startup that are caused by different boot times.

see "Known problems/issues" on page 307

Information:

5CFCRD.xxxx-06 CompactFlash cards are supported on B&R devices with WinCE version ≥ 6.0 .

9.3.2 Order data

Model number	Short description	Figure
	CompactFlash	
5CFCRD.0512-06	CompactFlash 512 MB B&R (SLC) \geq Rev. F0	
5CFCRD.1024-06	CompactFlash 1 GB B&R (SLC) \geq Rev. F0	
5CFCRD.2048-06	CompactFlash 2 GB B&R (SLC) \geq Rev. F0	
5CFCRD.4096-06	CompactFlash 4 GB B&R (SLC) \geq Rev. F0	
5CFCRD.8192-06	CompactFlash 8 GB B&R (SLC) \geq Rev. F0	
5CFCRD.016G-06	CompactFlash 16 GB B&R (SLC) \geq Rev. E0	
5CFCRD.032G-06	CompactFlash 32 GB B&R (SLC) \geq Rev. D0	

Table 232: 5CFCRD.0512-06, 5CFCRD.1024-06, 5CFCRD.2048-06, 5CFCRD.4096-06, 5CFCRD.8192-06, 5CFCRD.016G-06, 5CFCRD.032G-06 - Order data

Model number	Short description	Figure
	CompactFlash	
5CFCRD.0512-06	CompactFlash 512 MB B&R (SLC) \leq Rev. E0	
5CFCRD.1024-06	CompactFlash 1 GB B&R (SLC) \leq Rev. E0	
5CFCRD.2048-06	CompactFlash 2 GB B&R (SLC) \leq Rev. E0	
5CFCRD.4096-06	CompactFlash 4 GB B&R (SLC) \leq Rev. E0	
5CFCRD.8192-06	CompactFlash 8 GB B&R (SLC) \leq Rev. E0	
5CFCRD.016G-06	CompactFlash 16 GB B&R (SLC) \leq Rev. D0	
5CFCRD.032G-06	CompactFlash 32 GB B&R (SLC) \leq Rev. C0	

Table 233: 5CFCRD.0512-06, 5CFCRD.1024-06, 5CFCRD.2048-06, 5CFCRD.4096-06, 5CFCRD.8192-06, 5CFCRD.016G-06, 5CFCRD.032G-06 - Order data

9.3.3 Technical data

Caution!

A sudden loss of power may result in data loss! In very rare cases, the mass storage device may also become damaged.

To prevent damage and loss of data, the use of a UPS device is recommended.

Information:

The following characteristics, features and limit values only apply to this accessory and can deviate from those specified for the complete system. The data specifications for the complete system take precedence over those of individual components.

Product ID	5CFCRD. 0512-06 ≥ Rev. F0	5CFCRD. 1024-06 ≥ Rev. F0	5CFCRD. 2048-06 ≥ Rev. F0	5CFCRD. 4096-06 ≥ Rev. F0	5CFCRD. 8192-06 ≥ Rev. F0	5CFCRD. 016G-06 ≥ Rev. E0	5CFCRD. 032G-06 ≥ Rev. D0
General information							
Capacity	512 MB	1 GB	2 GB	4 GB	8 GB	16 GB	32 GB
Data retention	10 years						
Data reliability	<1 unrecoverable error in 10 ¹⁴ bit read accesses						
Lifetime monitoring	Yes						
MTBF	>3,000,000 hours (at 25°C)						
Maintenance	None						
Supported operating modes	PIO Mode 0-6, Multiword DMA Mode 0-4, Ultra DMA Mode 0-4						
Continuous reading							
Typical	50 MB/s	50 MB/s	59 MB/s	59 MB/s	59 MB/s	59 MB/s	58 MB/s
Maximum	53 MB/s	53 MB/s	65 MB/s	65 MB/s	65 MB/s	65 MB/s	65 MB/s
Continuous writing							
Typical	25 MB/s	25 MB/s	31 MB/s	31 MB/s	31 MB/s	31 MB/s	31 MB/s
Maximum	27 MB/s	27 MB/s	35 MB/s	35 MB/s	35 MB/s	35 MB/s	35 MB/s
Certification							
CE	Yes						
cULus	Yes						
cULus HazLoc Class 1 Division 2	-	-	-	-	-	Yes ¹⁾	-
ATEX Zone 22	-	-	-	-	-	Yes ¹⁾	-
GOST-R	Yes						
GL	Yes ¹⁾						
Endurance							
SLC flash	Yes						
Guaranteed data volume							
Guaranteed ²⁾	50 TB	100 TB	200 TB	400 TB	800 TB	1600 TB	3200 TB
Over 5 years, equates to ²⁾	27.40 GB/day	54.79 GB/day	109.9 GB/day	219.8 GB/day	438.6 GB/day	876.72 GB/day	1753.44 GB/day
Clear/Write cycles							
Guaranteed	100,000						
Wear leveling	Static						
Error correction coding (ECC)	Yes						
S.M.A.R.T. support	Yes						
Support							
Hardware	PP300/400, PP500, PPC300, PPC700, PPC725, PPC800, APC620, APC810, APC820						
Operating systems							
Windows 7 32-bit	No	No	No	No	No	Yes	Yes
Windows 7 64-bit	No	No	No	No	No	No	Yes
Windows Embedded Standard 7 32-bit	No	No	No	No	Yes	Yes	Yes
Windows Embedded Standard 7 64-bit	No	No	No	No	No	Yes	Yes
Windows XP Professional	No	No	No	Yes	Yes	Yes	Yes
Windows XP Embedded	Yes						
Windows Embedded Standard 2009	No	Yes	Yes	Yes	Yes	Yes	Yes
Windows CE 6.0	Yes	Yes	Yes	Yes	Yes	Yes ³⁾	Yes ³⁾
Windows CE 5.0	No						
Software							
PVI Transfer	≥ V3.2.3.8 (part of PVI Development Setup ≥ V2.06.00.3011)	≥ V3.2.3.8 (part of PVI Development Setup ≥ V2.06.00.3011)	≥ V3.2.3.8 (part of PVI Development Setup ≥ V2.06.00.3011)	≥ V3.2.3.8 (part of PVI Development Setup ≥ V2.06.00.3011)	≥ V3.2.3.8 (part of PVI Development Setup ≥ V2.06.00.3011)	≥ V3.6.8.40 (part of PVI Development Setup ≥ V3.0.0.3020)	≥ V4.0.0.8 (part of PVI Development Setup ≥ V3.0.2.3014)
B&R Embedded OS Installer	≥V3.10	≥V3.10	≥V3.10	≥V3.10	≥V3.10	≥V3.20	≥V3.21

Table 234: 5CFCRD.0512-06, 5CFCRD.1024-06, 5CFCRD.2048-06, 5CFCRD.4096-06, 5CFCRD.8192-06, 5CFCRD.016G-06, 5CFCRD.032G-06 - Technical data

Product ID	5CFCRD. 0512-06 ≥ Rev. F0	5CFCRD. 1024-06 ≥ Rev. F0	5CFCRD. 2048-06 ≥ Rev. F0	5CFCRD. 4096-06 ≥ Rev. F0	5CFCRD. 8192-06 ≥ Rev. F0	5CFCRD. 016G-06 ≥ Rev. E0	5CFCRD. 032G-06 ≥ Rev. D0
Environmental conditions							
Temperature							
Operation	0 to 70°C						
Storage	-50 to 100°C						
Transport	-50 to 100°C						
Relative humidity							
Operation	Max. 85% at 85°C						
Storage	Max. 85% at 85°C						
Transport	Max. 85% at 85°C						
Vibration							
Operation	20 g peak, 20 to 2000 Hz, 4 in each direction (JEDEC JESD22, method B103) 5.35 g RMS, 15 min per level (IEC 68-2-6)						
Storage	20 g peak, 20 to 2000 Hz, 4 in each direction (JEDEC JESD22, method B103) 5.35 g RMS, 15 min per level (IEC 68-2-6)						
Transport	20 g peak, 20 to 2000 Hz, 4 in each direction (JEDEC JESD22, method B103) 5.35 g RMS, 15 min per level (IEC 68-2-6)						
Shock							
Operation	1.5 kg peak, 0.5 ms 5 times (JEDEC JESD22, method B110) 30 g, 11 ms 1 times (IEC 68-2-27)						
Storage	1.5 kg peak, 0.5 ms 5 times (JEDEC JESD22, method B110) 30 g, 11 ms 1 times (IEC 68-2-27)						
Transport	1.5 kg peak, 0.5 ms 5 times (JEDEC JESD22, method B110) 30 g, 11 ms 1 times (IEC 68-2-27)						
Altitude							
Operation	Max. 4572 m						
Mechanical characteristics							
Dimensions							
Width	42.8 ±0.10 mm						
Length	36.4 ±0.15 mm						
Height	3.3 ±0.10 mm						
Weight	10 g						

Table 234: 5CFCRD.0512-06, 5CFCRD.1024-06, 5CFCRD.2048-06, 5CFCRD.4096-06, 5CFCRD.8192-06, 5CFCRD.016G-06, 5CFCRD.032G-06 - Technical data

- 1) Yes, although applies only if all components installed within the complete system have this certification
- 2) Endurance of B&R CFs (with linear written block size ≥128 kB).
- 3) Not supported by the B&R Embedded OS Installer.

Caution!

A sudden loss of power may result in data loss! In very rare cases, the mass storage device may also become damaged.

To prevent damage and loss of data, the use of a UPS device is recommended.

Information:

The following characteristics, features and limit values only apply to this accessory and can deviate from those specified for the complete system. The data specifications for the complete system take precedence over those of individual components.

Product ID	5CFCRD. 0512-06 ≤ Rev. E0	5CFCRD. 1024-06 ≤ Rev. E0	5CFCRD. 2048-06 ≤ Rev. E0	5CFCRD. 4096-06 ≤ Rev. E0	5CFCRD. 8192-06 ≤ Rev. E0	5CFCRD. 016G-06 ≤ Rev. D0	5CFCRD. 032G-06 ≤ Rev. C0
General information							
Capacity	512 MB	1 GB	2 GB	4 GB	8 GB	16 GB	32 GB
Data retention	10 years						
Data reliability	<1 unrecoverable error in 10 ¹⁴ bit read accesses						
Lifetime monitoring	Yes						
MTBF	>3,000,000 hours (at 25°C)						
Maintenance	None						
Supported operating modes	PIO Mode 0-6, Multiword DMA Mode 0-4, Ultra DMA Mode 0-4						
Continuous reading							
Typical	33 MB/s	33 MB/s	33 MB/s	33 MB/s	33 MB/s	36 MB/s	36 MB/s
Maximum	35 MB/s	35 MB/s	35 MB/s	34 MB/s	34 MB/s	37 MB/s	37 MB/s
Continuous writing							
Typical	15 MB/s	15 MB/s	15 MB/s	14 MB/s	14 MB/s	28 MB/s	28 MB/s
Maximum	18 MB/s	18 MB/s	18 MB/s	17 MB/s	17 MB/s	30 MB/s	30 MB/s

Table 235: 5CFCRD.0512-06, 5CFCRD.1024-06, 5CFCRD.2048-06, 5CFCRD.4096-06, 5CFCRD.8192-06, 5CFCRD.016G-06, 5CFCRD.032G-06 - Technical data

Product ID	5CFCRD.0512-06 ≤ Rev. E0	5CFCRD.1024-06 ≤ Rev. E0	5CFCRD.2048-06 ≤ Rev. E0	5CFCRD.4096-06 ≤ Rev. E0	5CFCRD.8192-06 ≤ Rev. E0	5CFCRD.016G-06 ≤ Rev. D0	5CFCRD.032G-06 ≤ Rev. C0
Certification							
CE					Yes		
cULus					Yes		
cULus HazLoc Class 1 Division 2	-	-	-	-	-	Yes ¹⁾	-
ATEX Zone 22	-	-	-	-	-	Yes ¹⁾	-
GOST-R					Yes		
GL					Yes ¹⁾		
Endurance							
SLC flash	Yes						
Guaranteed data volume							
Guaranteed ²⁾	50 TB	100 TB	200 TB	400 TB	800 TB	1600 TB	3200 TB
Over 5 years, equates to ²⁾	27.40 GB/day	54.79 GB/day	109.9 GB/day	219.8 GB/day	438.6 GB/day	876.72 GB/day	1753.44 GB/day
Clear/Write cycles							
Guaranteed	100,000						
Wear leveling	Static						
Error correction coding (ECC)	Yes						
S.M.A.R.T. support	Yes						
Support							
Hardware	PP300/400, PP500, PPC300, PPC700, PPC725, PPC800, APC620, APC810, APC820						
Operating systems							
Windows 7 32-bit	No	No	No	No	No	Yes	Yes
Windows 7 64-bit	No	No	No	No	No	No	Yes
Windows Embedded Standard 7 32-bit	No	No	No	No	Yes	Yes	Yes
Windows Embedded Standard 7 64-bit	No	No	No	No	No	Yes	Yes
Windows XP Professional	No	No	No	Yes	Yes	Yes	Yes
Windows XP Embedded				Yes			
Windows Embedded Standard 2009	No	Yes	Yes	Yes	Yes	Yes	Yes
Windows CE 6.0	Yes	Yes	Yes	Yes	Yes	Yes ³⁾	Yes ³⁾
Windows CE 5.0				No			
Software							
PVI Transfer	≥ V3.2.3.8 (part of PVI Development Setup ≥ V2.06.00.3011)	≥ V3.2.3.8 (part of PVI Development Setup ≥ V2.06.00.3011)	≥ V3.2.3.8 (part of PVI Development Setup ≥ V2.06.00.3011)	≥ V3.2.3.8 (part of PVI Development Setup ≥ V2.06.00.3011)	≥ V3.2.3.8 (part of PVI Development Setup ≥ V2.06.00.3011)	≥ V3.6.8.40 (part of PVI Development Setup ≥ V3.0.0.3020)	≥ V4.0.0.8 (part of PVI Development Setup ≥ V3.0.2.3014)
B&R Embedded OS Installer	≥V3.10	≥V3.10	≥V3.10	≥V3.10	≥V3.10	≥V3.20	≥V3.21
Environmental conditions							
Temperature							
Operation	0 to 70°C						
Storage	-50 to 100°C						
Transport	-50 to 100°C						
Relative humidity							
Operation	Max. 85% at 85°C						
Storage	Max. 85% at 85°C						
Transport	Max. 85% at 85°C						
Vibration							
Operation	20 g peak, 20 to 2000 Hz, 4 in each direction (JEDEC JESD22, method B103) 5.35 g RMS, 15 min per level (IEC 68-2-6)						
Storage	20 g peak, 20 to 2000 Hz, 4 in each direction (JEDEC JESD22, method B103) 5.35 g RMS, 15 min per level (IEC 68-2-6)						
Transport	20 g peak, 20 to 2000 Hz, 4 in each direction (JEDEC JESD22, method B103) 5.35 g RMS, 15 min per level (IEC 68-2-6)						
Shock							
Operation	1.5 kg peak, 0.5 ms 5 times (JEDEC JESD22, method B110) 30 g, 11 ms 1 times (IEC 68-2-27)						
Storage	1.5 kg peak, 0.5 ms 5 times (JEDEC JESD22, method B110) 30 g, 11 ms 1 times (IEC 68-2-27)						
Transport	1.5 kg peak, 0.5 ms 5 times (JEDEC JESD22, method B110) 30 g, 11 ms 1 times (IEC 68-2-27)						
Altitude							
Operation	Max. 4572 m						
Mechanical characteristics							
Dimensions							
Width	42.8 ±0.10 mm						
Length	36.4 ±0.15 mm						
Height	3.3 ±0.10 mm						
Weight	10 g						

Table 235: 5CFCRD.0512-06, 5CFCRD.1024-06, 5CFCRD.2048-06, 5CFCRD.4096-06, 5CFCRD.8192-06, 5CFCRD.016G-06, 5CFCRD.032G-06 - Technical data

- 1) Yes, although applies only if all components installed within the complete system have this certification
- 2) Endurance of B&R CFs (with linear written block size ≥128 kB).
- 3) Not supported by the B&R Embedded OS Installer.

9.3.4 Temperature/Humidity diagram

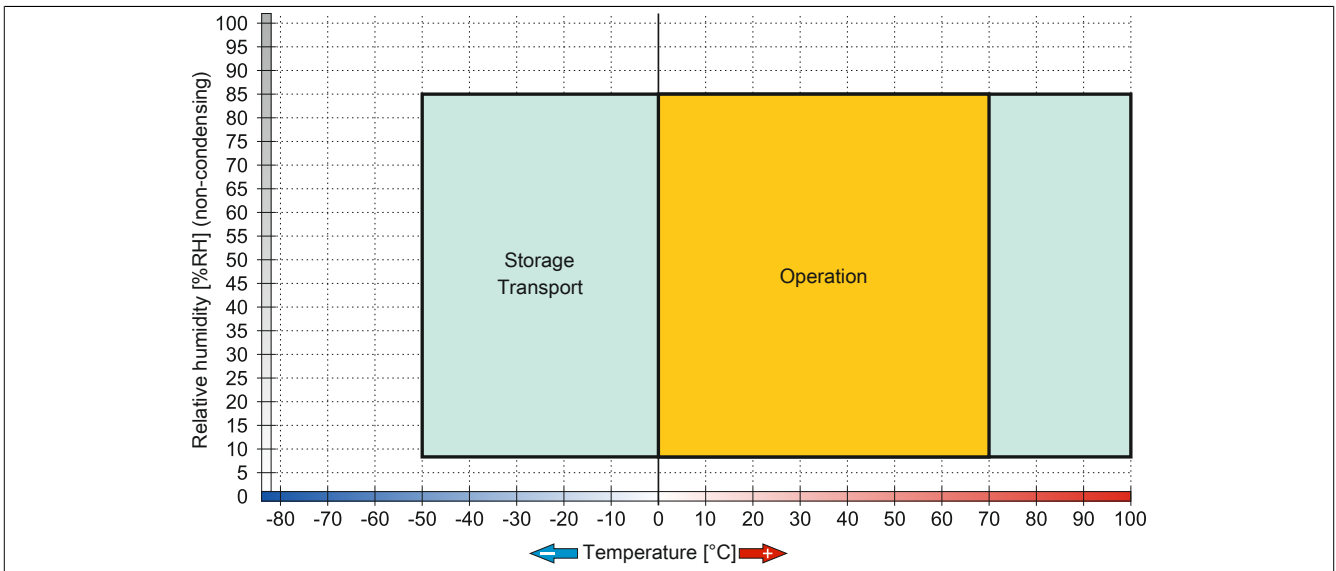

Figure 154: 5CFCRD.xxxx-06 - Temperature/Humidity diagram for CompactFlash cards

9.3.5 Dimensions

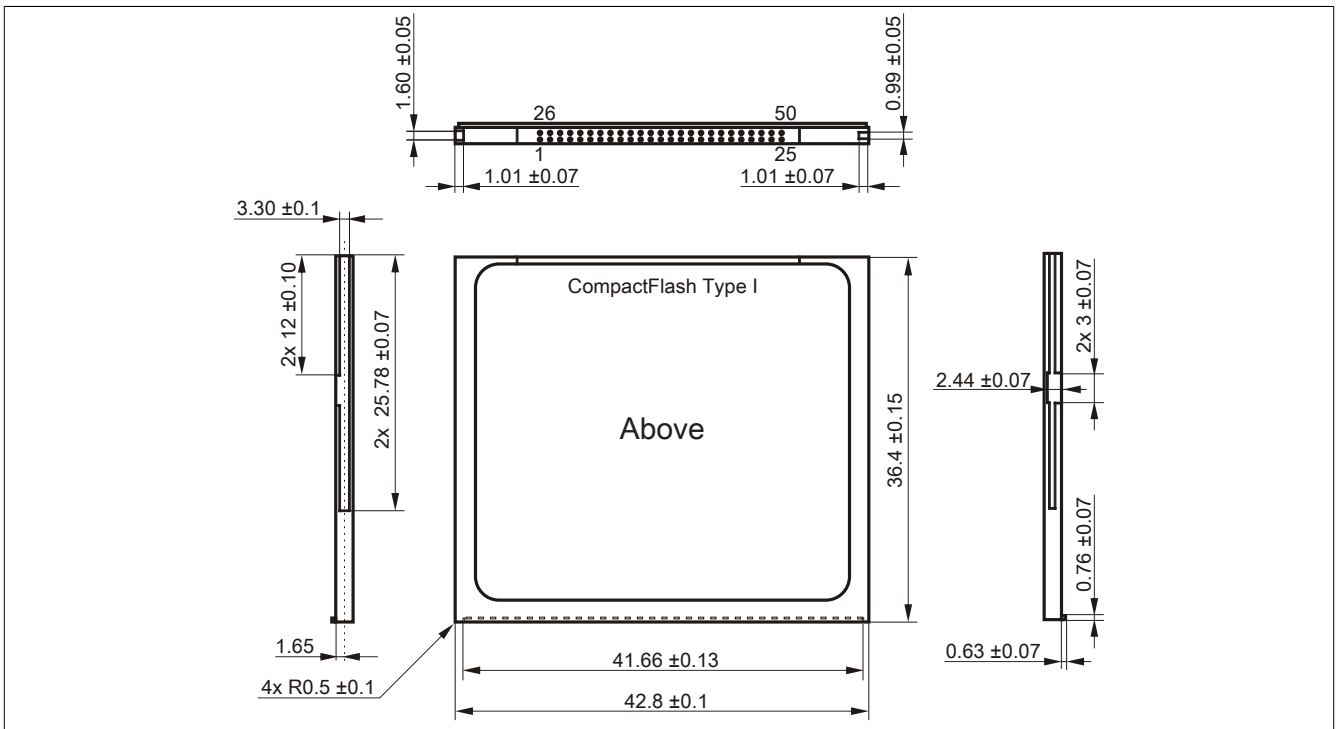

Figure 155: Type I CompactFlash card - Dimensions

9.3.6 Benchmark

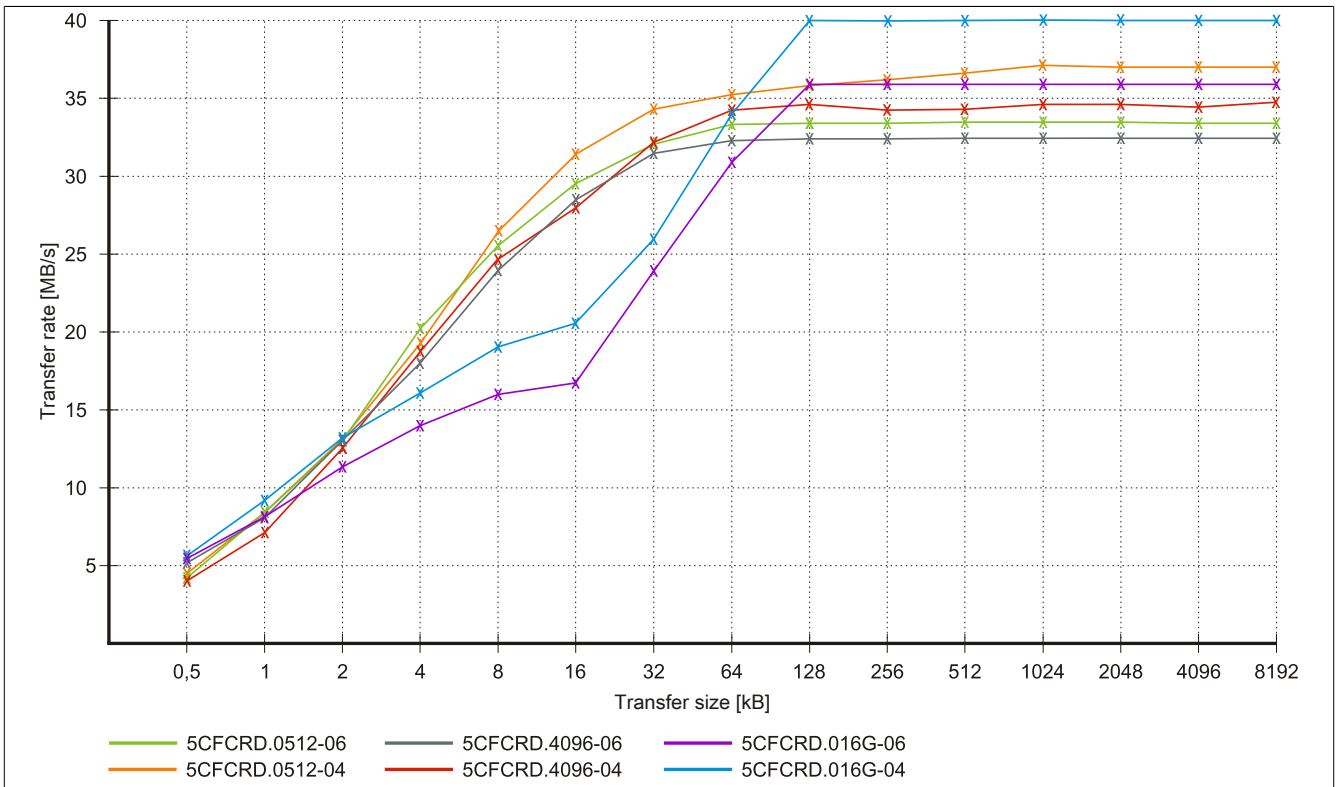

Figure 156: ATTO Disk Benchmark v2.34 read comparison - 5CFCRD.xxxx-04 and 5CFCRD.xxxx-06

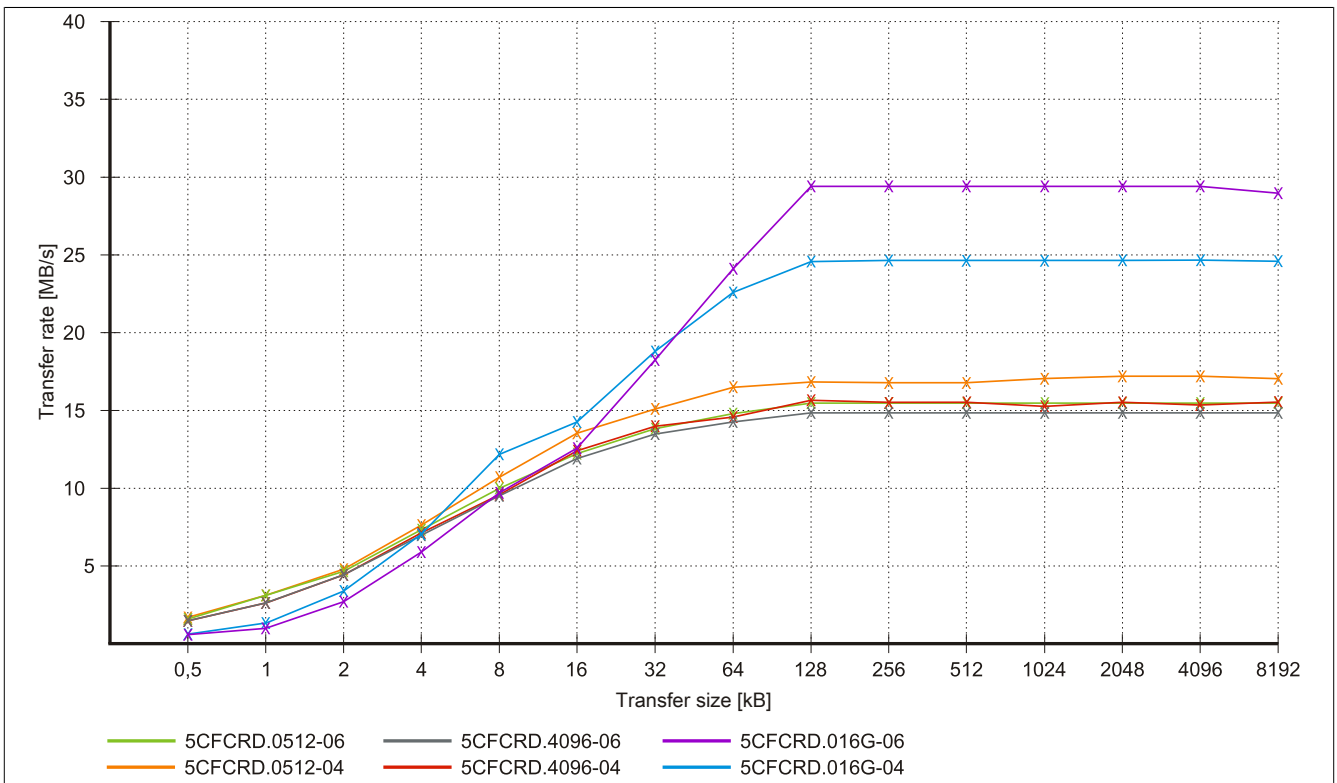

Figure 157: ATTO Disk Benchmark v2.34 write comparison - 5CFCRD.xxxx-04 and 5CFCRD.xxxx-06

9.4 5CFCRD.xxxx-04

9.4.1 General information

Information:

B&R CompactFlash cards 5CFCRD.xxxx-04 and CompactFlash cards from a different manufacturer cannot be used in the same system at the same time. Due to differences in technology (older vs. newer technologies), problems can occur during system startup that are caused by different boot times.

see "Known problems/issues" on page 307

Information:

5CFCRD.xxxx-04 CompactFlash cards are supported on B&R devices with WinCE version ≥ 6.0 .

9.4.2 Order data

Model number	Short description	Figure
	CompactFlash-cards	
5CFCRD.0512-04	CompactFlash 512 MB B&R (SLC)	
5CFCRD.1024-04	CompactFlash 1 GB B&R (SLC)	
5CFCRD.2048-04	CompactFlash 2 GB B&R (SLC)	
5CFCRD.4096-04	CompactFlash 4 GB B&R (SLC)	
5CFCRD.8192-04	CompactFlash 8 GB B&R (SLC)	
5CFCRD.016G-04	CompactFlash 16 GB B&R (SLC)	

Table 236: 5CFCRD.0512-04, 5CFCRD.1024-04, 5CFCRD.2048-04, 5CFCRD.4096-04, 5CFCRD.8192-04, 5CFCRD.016G-04 - Order data

9.4.3 Technical data

Caution!

A sudden loss of power may result in data loss! In very rare cases, the mass storage device may also become damaged.

To prevent damage and loss of data, the use of a UPS device is recommended.

Information:

The following characteristics, features and limit values only apply to this accessory and can deviate from those specified for the complete system. The data specifications for the complete system take precedence over those of individual components.

Product ID	5CFCRD.0512-04	5CFCRD.1024-04	5CFCRD.2048-04	5CFCRD.4096-04	5CFCRD.8192-04	5CFCRD.016G-04
General information						
Capacity	512 MB	1 GB	2 GB	4 GB	8 GB	16 GB
Data retention	10 years					
Data reliability	<1 unrecoverable error in 10^{14} bit read accesses					
Lifetime monitoring	Yes					
MTBF	>3,000,000 hours (at 25°C)					
Maintenance	None					
Supported operating modes	PIO Mode 0-6, Multiword DMA Mode 0-4, Ultra DMA Mode 0-4					
Sequential read						
Typical	35 MB/s (240X) ¹⁾	35 MB/s (240X) ¹⁾	35 MB/s (240X) ¹⁾	33 MB/s (220X) ¹⁾	27 MB/s (180X) ¹⁾	36 MB/s (240X) ¹⁾
Maximum	37 MB/s (260X) ¹⁾	37 MB/s (260X) ¹⁾	37 MB/s (260X) ¹⁾	34 MB/s (226X) ¹⁾	28 MB/s (186X) ¹⁾	37 MB/s (247X) ¹⁾

Table 237: 5CFCRD.0512-04, 5CFCRD.1024-04, 5CFCRD.2048-04, 5CFCRD.4096-04, 5CFCRD.8192-04, 5CFCRD.016G-04 - Technical data

Product ID	5CFCRD.0512-04	5CFCRD.1024-04	5CFCRD.2048-04	5CFCRD.4096-04	5CFCRD.8192-04	5CFCRD.016G-04
Sequential write						
Typical	17 MB/s (110X)	17 MB/s (110X)	17 MB/s (110X)	16 MB/s (106X)	15 MB/s (100X)	18 MB/s (120X)
Maximum	20 MB/s (133X)	20 MB/s (133X)	20 MB/s (133X)	18 MB/s (120X)	17 MB/s (110X)	19 MB/s (126X)
Certification				Yes		
CE				Yes		
cULus				Yes		
GOST-R	-	Yes	Yes	Yes	Yes	Yes
GL				Yes ²⁾		
Endurance						
SLC flash	Yes					
Guaranteed data volume						
Guaranteed ³⁾	50 TB	100 TB	200 TB	400 TB	800 TB	1600 TB
Results for 5 years ³⁾	27.40 GB/day	54.79 GB/day	109.9 GB/day	219.8 GB/day	438.6 GB/day	876.72 GB/day
Clear/Write cycles						
Typical ⁴⁾	2,000,000					
Guaranteed	100,000					
Wear leveling	Static					
Error correction coding (ECC)	Yes					
S.M.A.R.T. support	No					
Support						
Hardware	PP300/400, PP500, PPC300, PPC700, PPC725, PPC800, APC620, APC810, APC820					
Operating systems						
Windows 7 32-bit	No	No	No	No	No	Yes
Windows 7 64-bit				No		
Windows Embedded Standard 7, 32-bit	No	No	No	No	Yes	Yes
Windows Embedded Standard 7, 64-bit	No	No	No	No	No	Yes
Windows XP Professional	No	No	No	Yes	Yes	Yes
Windows XP Embedded				Yes		
Windows Embedded Standard 2009	No	Yes	Yes	Yes	Yes	Yes
Windows CE 6.0	Yes	Yes	Yes	Yes	Yes	Yes ⁵⁾
Windows CE 5.0				No		
Software						
PVI Transfer	≥ V3.2.3.8 (part of PVI Development Setup ≥ V2.06.00.3011)	≥ V3.2.3.8 (part of PVI Development Setup ≥ V2.06.00.3011)	≥ V3.2.3.8 (part of PVI Development Setup ≥ V2.06.00.3011)	≥ V3.2.3.8 (part of PVI Development Setup ≥ V2.06.00.3011)	≥ V3.2.3.8 (part of PVI Development Setup ≥ V2.06.00.3011)	≥ V3.6.8.40 (part of PVI Development Setup ≥ V3.0.0.3020)
B&R Embedded OS Installer	≥V3.10	≥V3.10	≥V3.10	≥V3.10	≥V3.10	≥V3.20
Environmental conditions						
Temperature						
Operation	0 to 70°C					
Storage	-65 to 150°C					
Transport	-65 to 150°C					
Relative humidity						
Operation	Max. 85% at 85°C					
Storage	Max. 85% at 85°C					
Transport	Max. 85% at 85°C					
Vibration						
Operation	20 g peak, 20 to 2000 Hz, 4 in each direction (JEDEC JESD22, method B103) 5.35 g RMS, 15 min per level (IEC 68-2-6)					
Storage	20 g peak, 20 to 2000 Hz, 4 in each direction (JEDEC JESD22, method B103) 5.35 g RMS, 15 min per level (IEC 68-2-6)					
Transport	20 g peak, 20 to 2000 Hz, 4 in each direction (JEDEC JESD22, method B103) 5.35 g RMS, 15 min per level (IEC 68-2-6)					
Shock						
Operation	1.5 kg peak, 0.5 ms 5 times (JEDEC JESD22, method B110) 30 g, 11 ms 1 times (IEC 68-2-27)					
Storage	1.5 kg peak, 0.5 ms 5 times (JEDEC JESD22, method B110) 30 g, 11 ms 1 times (IEC 68-2-27)					
Transport	1.5 kg peak, 0.5 ms 5 times (JEDEC JESD22, method B110) 30 g, 11 ms 1 times (IEC 68-2-27)					
Altitude						
Operation	Max. 4572 m					
Mechanical characteristics						
Dimensions						
Width	42.8 ±0.10 mm					
Length	36.4 ±0.15 mm					
Height	3.3 ±0.10 mm					
Weight	10 g					

Table 237: 5CFCRD.0512-04, 5CFCRD.1024-04, 5CFCRD.2048-04, 5CFCRD.4096-04, 5CFCRD.8192-04, 5CFCRD.016G-04 - Technical data

- Speed specification with 1X = 150 Kb/s. All specifications refer to Samsung flash chips, CompactFlash cards in UDMA mode 4 and 30 ns cycle time in True IDE mode with sequential write/read test.
- Yes, although applies only if all components installed within the complete system have this certification

- 3) Endurance of B&R CFs (with linear written block size ≥ 128 kB).
- 4) Depends on the average file size.
- 5) Not supported by the B&R Embedded OS Installer.

9.4.4 Temperature/Humidity diagram

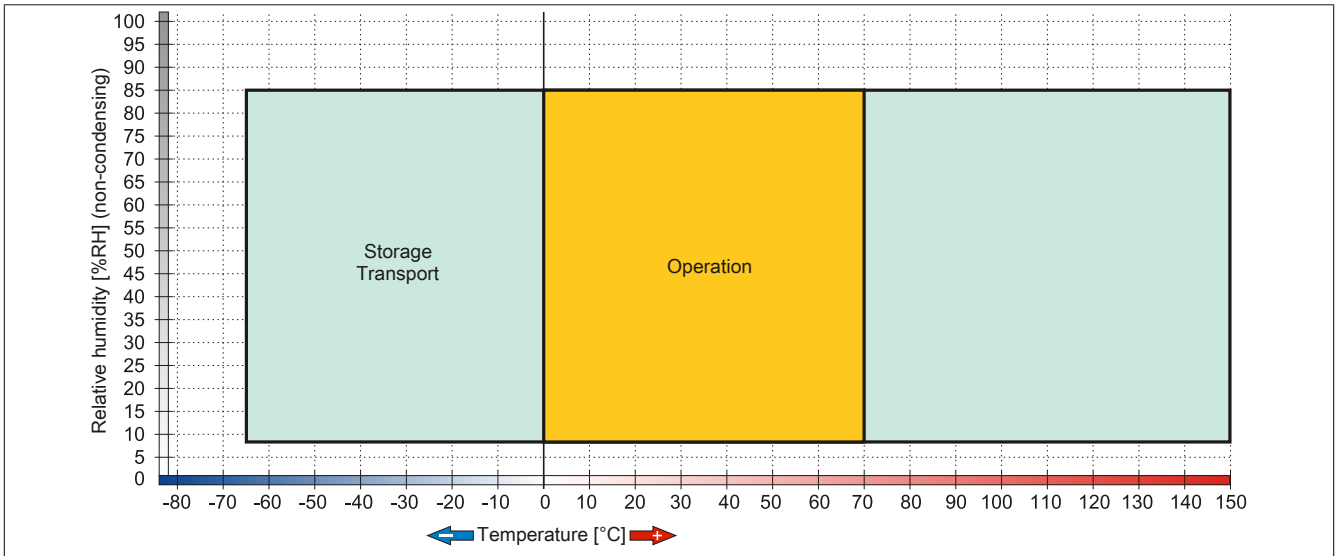

Figure 158: 5CFCRD.xxxx-04 - Temperature/Humidity diagram for CompactFlash cards

9.4.5 Dimensions

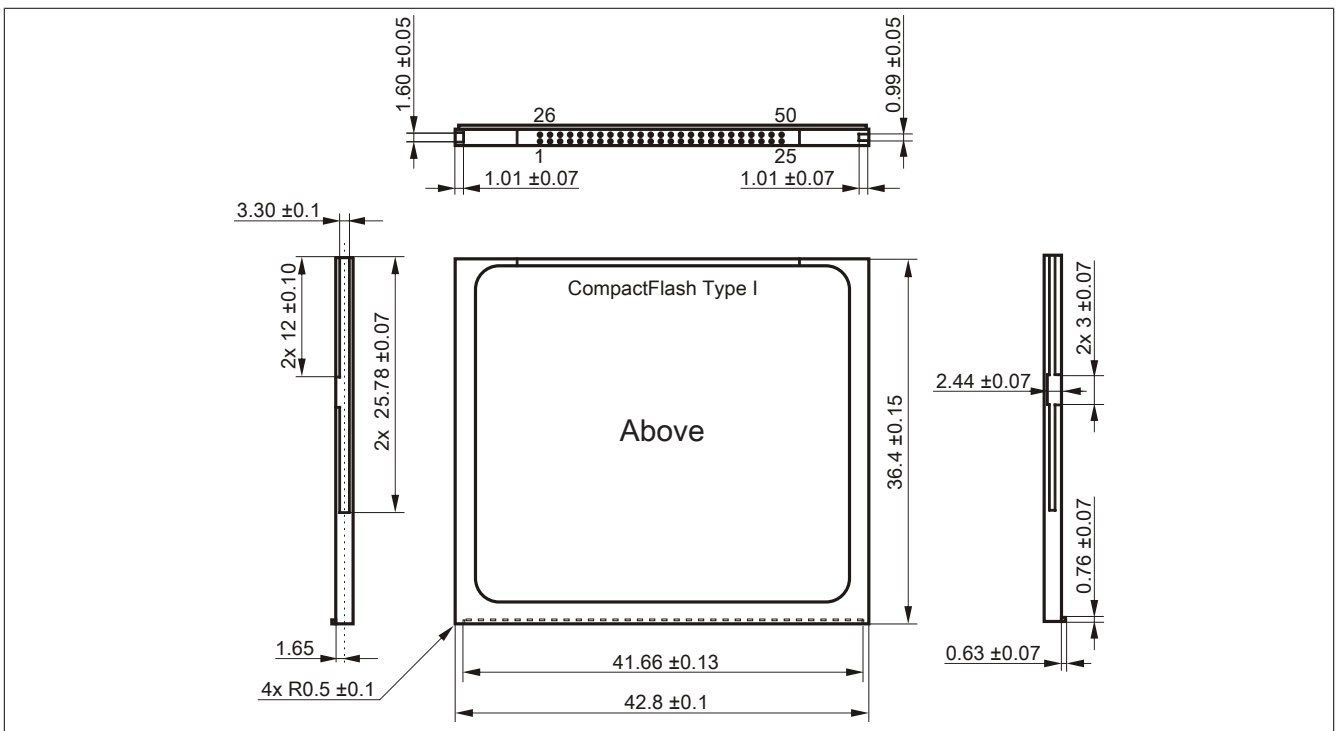

Figure 159: Type I CompactFlash card - Dimensions

9.4.6 Benchmark

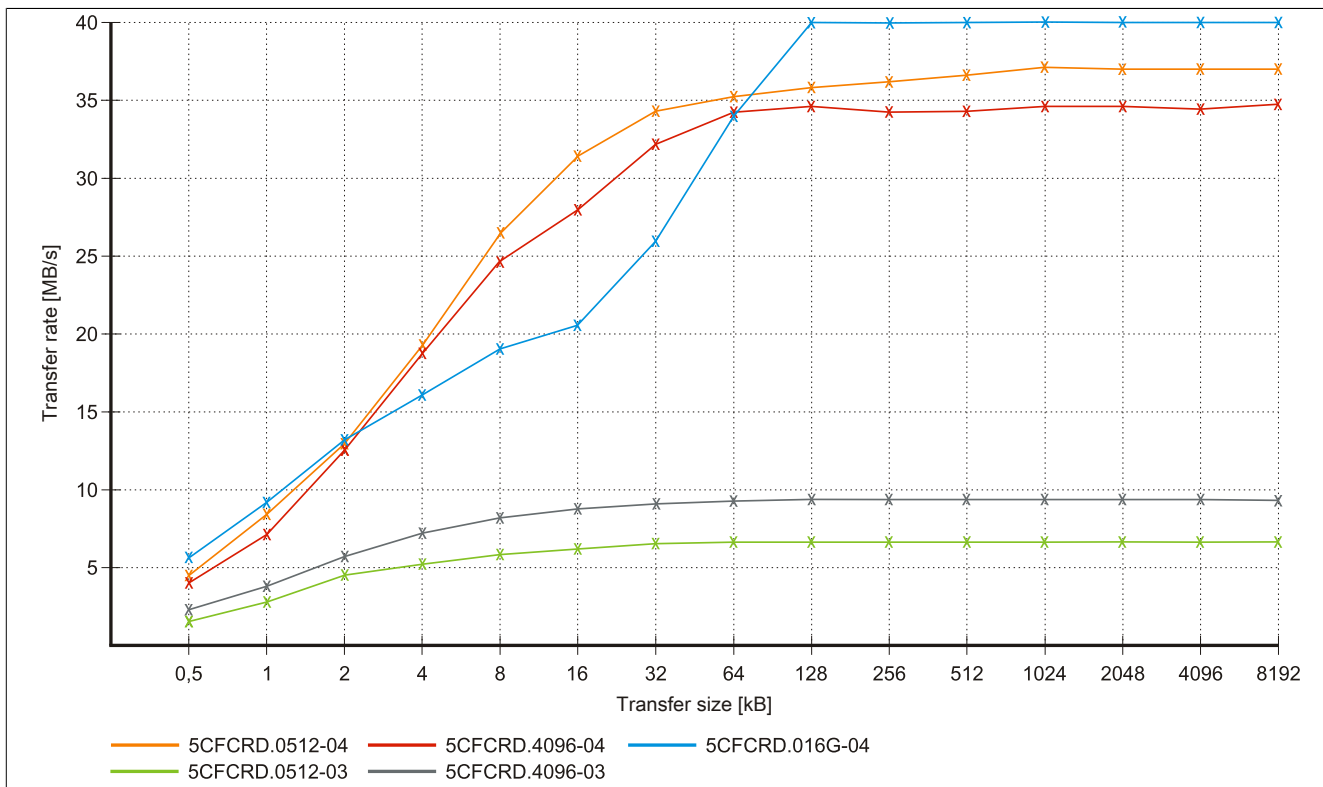

Figure 160: ATTO Disk Benchmark v2.34 read comparison - 5CFCRD.xxxx-03 and 5CFCRD.xxxx-04

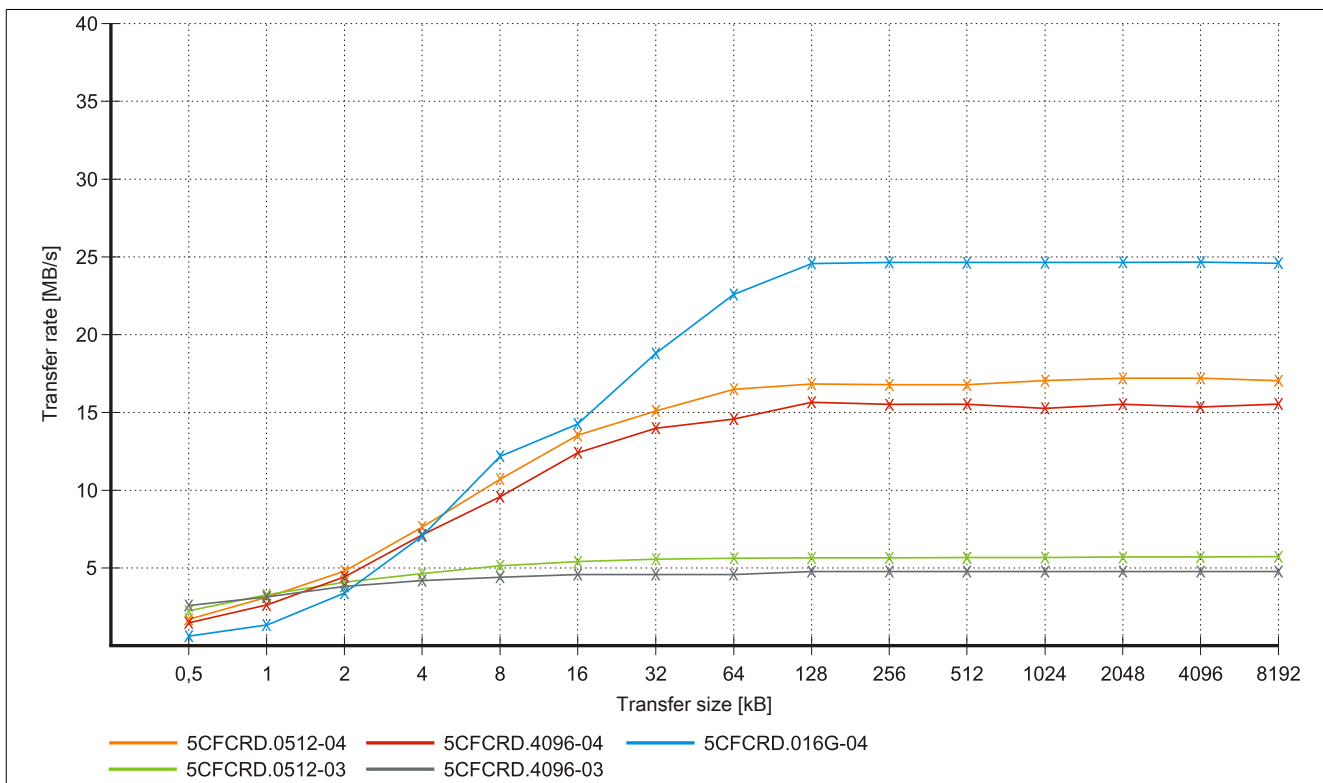

Figure 161: ATTO Disk Benchmark v2.34 write comparison - 5CFCRD.xxxx-03 and 5CFCRD.xxxx-04

9.5 5CFCRD.xxxx-03

9.5.1 General information

Information:

Western Digital CompactFlash cards 5CFCRD.xxxx and CompactFlash cards from a different manufacturer cannot be used in the same system at the same time. Due to differences in technology (older vs. newer technologies), problems can occur during system startup that are caused by different boot times.

see "Known problems/issues" on page 307

Information:

On Windows CE 5.0 devices, 5CFCRD.xxxx-03 CompactFlash cards up to 1 GB are supported.

Information:

On CompactFlash cards 5CFCRD.xxxx-03, only the sticker and the description have changed. The technical data has not been changed.

9.5.2 Order data

Model number	Short description	Figure
	CompactFlash-cards	
5CFCRD.0064-03	CompactFlash 64 MB Western Digital (SLC)	
5CFCRD.0128-03	CompactFlash 128 MB Western Digital (SLC)	
5CFCRD.0256-03	CompactFlash 256 MB Western Digital (SLC)	
5CFCRD.0512-03	CompactFlash 512 MB Western Digital (SLC)	
5CFCRD.1024-03	CompactFlash 1 GB Western Digital (SLC)	
5CFCRD.2048-03	CompactFlash 2 GB Western Digital (SLC)	
5CFCRD.4096-03	CompactFlash 4 GB Western Digital (SLC)	
5CFCRD.8192-03	CompactFlash 8 GB Western Digital (SLC)	

Table 238: 5CFCRD.0064-03, 5CFCRD.0128-03, 5CFCRD.0256-03, 5CFCRD.0512-03, 5CFCRD.1024-03, 5CFCRD.2048-03, 5CFCRD.4096-03, 5CFCRD.8192-03 - Order data

9.5.3 Technical data

Caution!

A sudden loss of power may result in data loss! In very rare cases, the mass storage device may also become damaged.

To prevent damage and loss of data, B&R recommends that you use a UPS device.

Information:

The following characteristics, features and limit values only apply to this accessory and can deviate from those specified for the complete system. The data specifications for the complete system take precedence over those of individual components.

Product ID	5CFCRD.0064-03	5CFCRD.0128-03	5CFCRD.0256-03	5CFCRD.0512-03	5CFCRD.1024-03	5CFCRD.2048-03	5CFCRD.4096-03	5CFCRD.8192-03
General information								
Capacity	64 MB	128 MB	256 MB	512 MB	1 GB	2 GB	4 GB	8 GB
Data retention	10 years							
Data reliability	<1 unrecoverable error in 10 ¹⁴ bit read accesses							
Lifetime monitoring	Yes							

Table 239: 5CFCRD.0064-03, 5CFCRD.0128-03, 5CFCRD.0256-03, 5CFCRD.0512-03, 5CFCRD.1024-03, 5CFCRD.2048-03, 5CFCRD.4096-03, 5CFCRD.8192-03 - Technical data

Product ID	5CFCRD.0064-03	5CFCRD.0128-03	5CFCRD.0256-03	5CFCRD.0512-03	5CFCRD.1024-03	5CFCRD.2048-03	5CFCRD.4096-03	5CFCRD.8192-03
MTBF	>4,000,000 hours (at 25°C)							
Maintenance	None							
Supported operating modes	PIO Mode 0-4, Multiword DMA Mode 0-2							
Sequential read Typical	8 MB/s							
Sequential write Typical	6 MB/s							
Certification CE cULus GOST-R GL	Yes Yes Yes Yes ¹⁾							
Endurance								
SLC flash	Yes							
Clear/Write cycles Typical	>2,000,000							
Wear leveling	Static							
Error correction coding (ECC)	Yes							
S.M.A.R.T. support	No							
Support								
Hardware	MP100/200, PP100/200, PP300/400, PP500, PPC300, PPC700, PPC725, PPC800, Provit 2000, Provit 5000, APC620, APC680, APC810, APC820							
Operating systems								
Windows 7 32-bit	No							
Windows 7 64-bit	No							
Windows Embedded Standard 7, 32-bit	No	No	No	No	No	No	No	Yes
Windows Embedded Standard 7, 64-bit	No							
Windows XP Professional	No	No	No	No	No	No	Yes	Yes
Windows XP Embedded	No	No	No	Yes	Yes	Yes	Yes	Yes
Windows Embedded Standard 2009	No	No	No	No	Yes	Yes	Yes	Yes
Windows CE 6.0	Yes	Yes	Yes	Yes	Yes	Yes	Yes	Yes ²⁾
Windows CE 5.0	Yes	Yes	Yes	Yes	Yes	No	No	No
Software								
PVI Transfer	≥V2.57 (part of PVI Development Setup ≥ V2.5.3.3005)							
B&R Embedded OS Installer	≥V2.21							
Environmental conditions								
Temperature								
Operation	0 to 70°C							
Storage	-50 to 100°C							
Transport	-50 to 100°C							
Relative humidity								
Operation	8 to 95%, non-condensing							
Storage	8 to 95%, non-condensing							
Transport	8 to 95%, non-condensing							
Vibration								
Operation	Max. 16.3 g (159 m/s ² 0-peak)							
Storage	Max. 30 g (294 m/s ² 0-peak)							
Transport	Max. 30 g (294 m/s ² 0-peak)							
Shock								
Operation	Max. 1000 g (9810 m/s ² 0-peak)							
Storage	Max. 3000 g (29430 m/s ² 0-peak)							
Transport	Max. 3000 g (29430 m/s ² 0-peak)							
Altitude								
Operation	Max. 24383 m							
Mechanical characteristics								
Dimensions								
Width	42.8 ±0.10 mm							
Length	36.4 ±0.15 mm							
Height	3.3 ±0.10 mm							
Weight	11.4 g							

Table 239: 5CFCRD.0064-03, 5CFCRD.0128-03, 5CFCRD.0256-03, 5CFCRD.0512-03, 5CFCRD.1024-03, 5CFCRD.2048-03, 5CFCRD.4096-03, 5CFCRD.8192-03 - Technical data

- 1) Yes, although applies only if all components installed within the complete system have this certification
- 2) Not supported by the B&R Embedded OS Installer.

9.5.4 Temperature/Humidity diagram

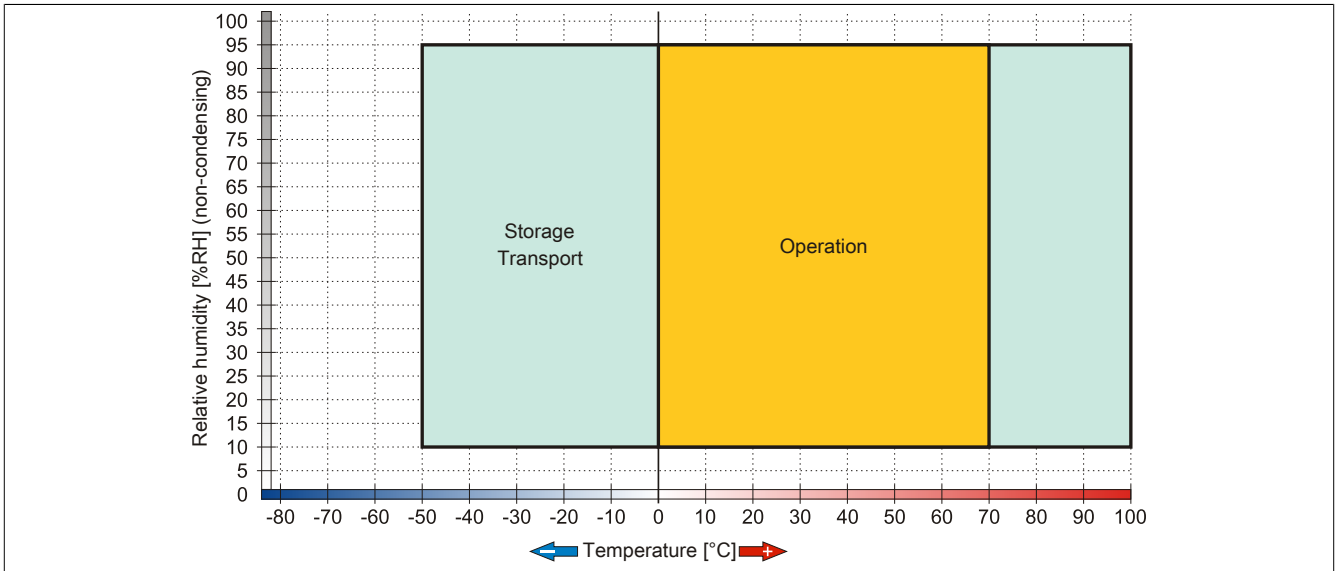

Figure 162: 5CFCRD.xxxx-03 - Temperature/Humidity diagram for CompactFlash cards

9.5.5 Dimensions

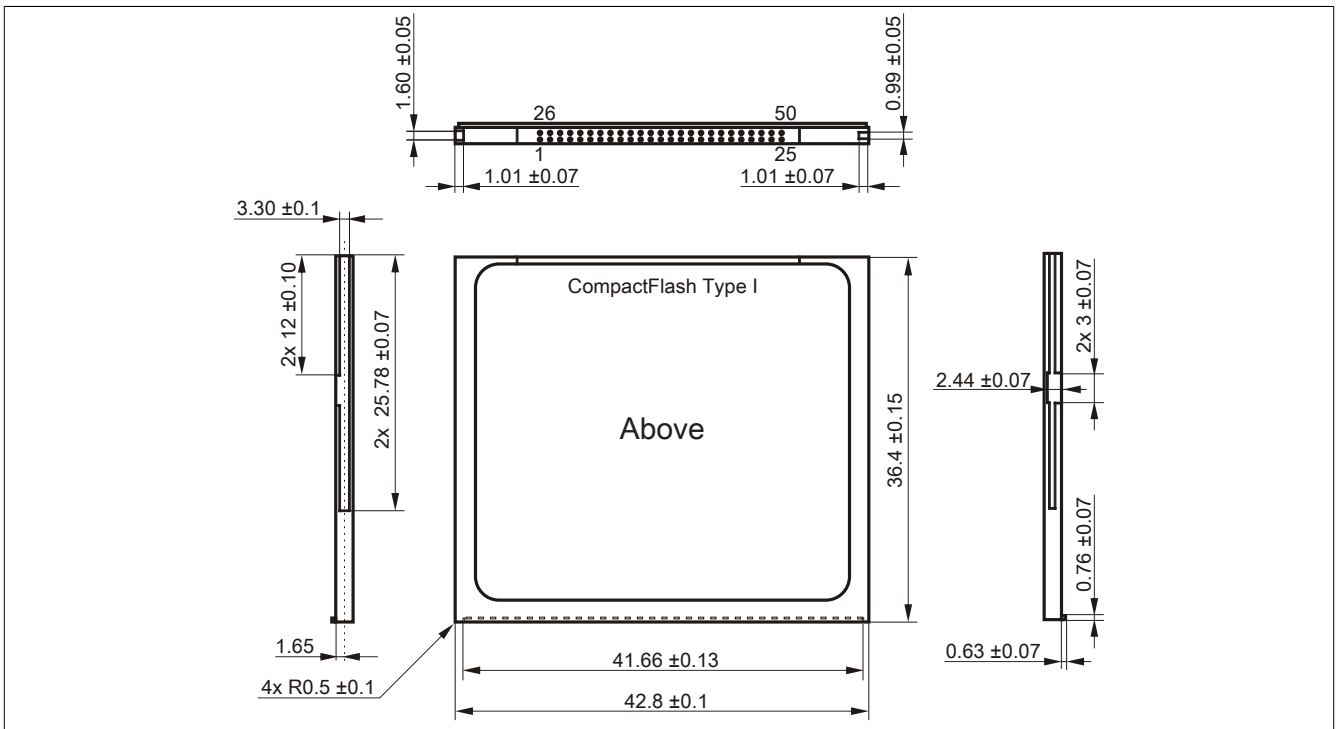

Figure 163: Type I CompactFlash card - Dimensions

9.6 Known problems/issues

The following is a known issue for devices with two CompactFlash slots:

- Using two different types of CompactFlash cards can cause problems with Automation PCs and Panel PCs. For example, it is possible that one of the two cards is not detected during system startup. This is caused by different startup speeds. CompactFlash cards with older technology require significantly more time during system startup than CompactFlash cards with newer technology. This behavior occurs near the end of the time frame provided for startup. The problem described can occur because the startup time for the CompactFlash cards fluctuates due to the different components being used. Depending on the CompactFlash card being used, this error might never, sometimes or always occur.

10 USB flash drives

10.1 5MMUSB.2048-00

10.1.1 General information

USB flash drives are storage media that are easy to exchange. Because of their fast data transfer (USB 2.0), USB flash drives are ideal for use as portable data storage. Without requiring additional drivers ("hot plugging", except in the case of Windows 98SE), the USB flash drive can immediately act as an additional drive for reading or writing data.

Information:

Due to the vast quantity of USB flash drives available on the market as well as their short product life cycle, we reserve the right to supply alternative products at any time. The following measures may therefore be necessary in order to boot from these flash drives as well:

- The flash drive must be reformatted or in some cases even repartitioned (set active partition).
- The flash drive must be the first bootable device in the BIOS boot order; alternatively, the IDE controllers can be disabled in BIOS. This can be avoided in most cases if the "fdisk /mbr" command is additionally executed on the USB flash drive.

10.1.2 Order data

Model number	Short description	Figure
	USB accessories	
5MMUSB.2048-00	USB 2.0 flash drive, 2048 MB	

Table 240: 5MMUSB.2048-00 - Order data

10.1.3 Technical data

Information:

The following characteristics, features and limit values only apply to this accessory and can deviate from those specified for the complete system. The data specifications for the complete system take precedence over those of individual components.

Product ID	5MMUSB.2048-00
General information	
Data retention	10 years
LEDs	1 LED (green) ¹⁾
MTBF	100,000 hours (at 25°C)
Type	USB 1.1, USB 2.0
Maintenance	None
Certification CE	Yes
Interfaces	
USB	
Type	USB 1.1, USB 2.0
Connection	To any USB type A interface
Transfer rate	Low speed (1.5 Mbit/s), full speed (12 Mbit/s), high speed (480 Mbit/s)
Sequential reading	Max. 8.7 MB/s
Sequential writing	Max. 1.7 MB/s
Support	
Operating systems	
Windows XP Professional	Yes
Windows XP Embedded	Yes
Windows ME	Yes
Windows 2000	Yes
Windows CE 5.0	Yes
Windows CE 4.2	Yes
Electrical characteristics	
Power consumption	650 µA sleep mode, 150 mA read/write

Table 241: 5MMUSB.2048-00 - Technical data

Product ID	5MMUSB.2048-00
Environmental conditions	
Temperature	
Operation	0 to 45°C
Storage	-20 to 60°C
Transport	-20 to 60°C
Relative humidity	
Operation	10 to 90%, non-condensing
Storage	5 to 90%, non-condensing
Transport	5 to 90%, non-condensing
Vibration	
Operation	10 to 500 Hz: 2 g (19.6 m/s ² 0-peak), oscillation rate 1/minute
Storage	10 to 500 Hz: 2 g (19.6 m/s ² 0-peak), oscillation rate 1/minute
Transport	10 to 500 Hz: 2 g (19.6 m/s ² 0-peak), oscillation rate 1/minute
Shock	
Operation	Max. 40 g (392 m/s ² 0-peak) and 11 ms duration
Storage	Max. 80 g (784 m/s ² 0-peak) and 11 ms duration
Transport	Max. 80 g (784 m/s ² 0-peak) and 11 ms duration
Altitude	
Operation	Max. 3048 m
Storage	Max. 12192 m
Transport	Max. 12192 m
Mechanical characteristics	
Dimensions	
Width	19 mm
Length	52.2 mm
Height	7.9 mm

Table 241: 5MMUSB.2048-00 - Technical data

1) Indicates data being transferred (sending and receiving).

10.1.4 Temperature/Humidity diagram

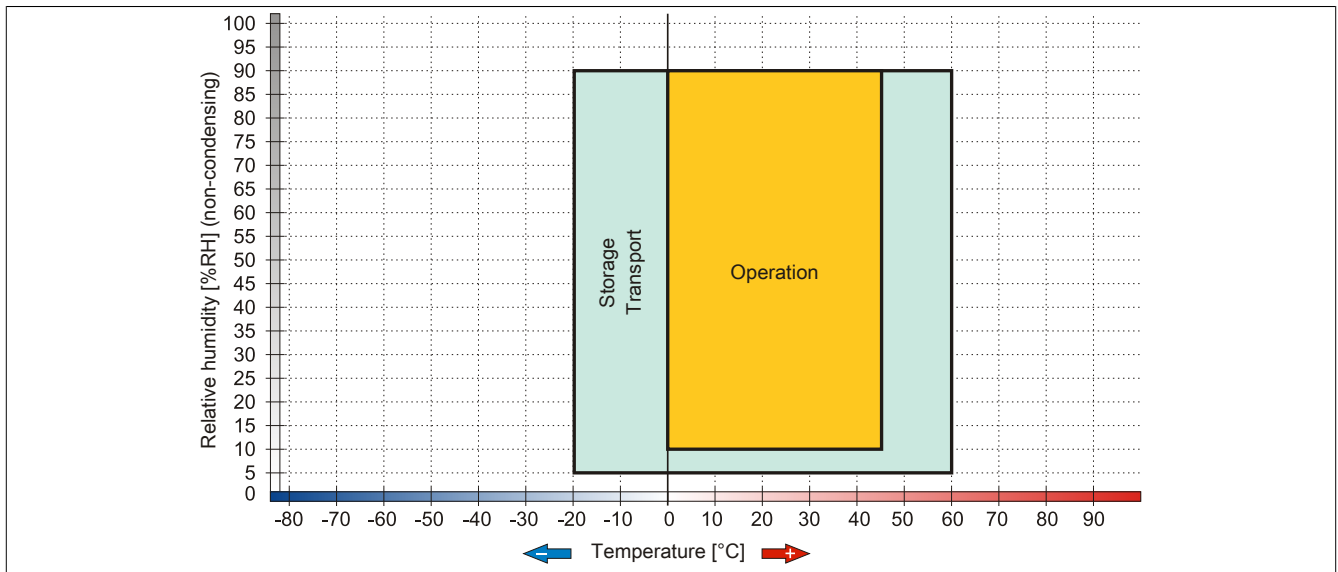

Figure 164: 5MMUSB.2048-00 - Temperature/Humidity diagram

10.2 5MMUSB.xxxx-01

10.2.1 General information

USB flash drives are storage media that are easy to exchange. Because of their fast data transfer (USB 2.0), USB flash drives are ideal for use as portable data storage. Without requiring additional drivers ("hot plugging", except in the case of Windows 98SE), the USB flash drive can immediately act as an additional drive for reading or writing data.

Information:

Due to the vast quantity of USB flash drives available on the market as well as their short product life cycle, we reserve the right to supply alternative products at any time. The following measures may therefore be necessary in order to boot from these flash drives as well:

- The flash drive must be reformatted or in some cases even repartitioned (set active partition).
- The flash drive must be the first bootable device in the BIOS boot order; alternatively, the IDE controllers can be disabled in BIOS. This can be avoided in most cases if the "fdisk /mbr" command is additionally executed on the USB flash drive.

10.2.2 Order data

Model number	Short description	Figure
	USB accessories	
5MMUSB.2048-01	USB 2.0 flash drive, 2048 MB, B&R	
5MMUSB.4096-01	USB 2.0 flash drive, 4096 MB, B&R	

Table 242: 5MMUSB.2048-01, 5MMUSB.4096-01 - Order data

10.2.3 Technical data

Product ID	5MMUSB.2048-01	5MMUSB.4096-01
General information		
Capacity	2 GB	4 GB
LEDs	1 LED (green) ¹⁾	
MTBF	>3,000,000 hours	
Type	USB 1.1, USB 2.0	
Maintenance	None	
Default file system	FAT16	FAT32
Certification		
CE	Yes	
GOST-R	Yes	
Interfaces		
USB		
Type	USB 1.1, USB 2.0	
Connection	To any USB type A interface	
Transfer rate	Low speed (1.5 Mbit/s), full speed (12 Mbit/s), high speed (480 Mbit/s)	
Sequential reading	Full speed max. 1 MB/s, High speed max. 32 MB/s	
Sequential writing	Full speed max. 0.9 MB/s, High speed max. 23 MB/s	
Endurance		
SLC flash	Yes	
Data retention	>10 years	
Data reliability	<1 unrecoverable error in 10 ¹⁴ bit read accesses	
Connection cycles	>1,500	
Support		
Operating systems		
Windows 7	Yes	
Windows XP Professional	Yes	
Windows XP Embedded	Yes	
Windows ME	Yes	
Windows 2000	Yes	
Windows CE 5.0	Yes	
Windows CE 4.2	Yes	
Electrical characteristics		
Current consumption	Max. 500 µA sleep mode, max. 120 mA read/write	

Table 243: 5MMUSB.2048-01, 5MMUSB.4096-01 - Technical data

Product ID	5MMUSB.2048-01	5MMUSB.4096-01
Environmental conditions		
Temperature		
Operation	0 to 70°C	
Storage	-50 to 100°C	
Transport	-50 to 100°C	
Relative humidity		
Operation	85%, non-condensing	
Storage	85%, non-condensing	
Transport	85%, non-condensing	
Vibration		
Operation	20 to 2000 Hz: 20 g (peak)	
Storage	20 to 2000 Hz: 20 g (peak)	
Transport	20 to 2000 Hz: 20 g (peak)	
Shock		
Operation	Max. 1500 g (peak)	
Storage	Max. 1500 g (peak)	
Transport	Max. 1500 g (peak)	
Altitude		
Operation	Max. 3048 m	
Storage	Max. 12192 m	
Transport	Max. 12192 m	
Mechanical characteristics		
Dimensions		
Width	17.97 mm	
Length	67.85 mm	
Height	8.35 mm	

Table 243: 5MMUSB.2048-01, 5MMUSB.4096-01 - Technical data

1) Indicates data being transferred (sending and receiving).

10.2.4 Temperature/Humidity diagram

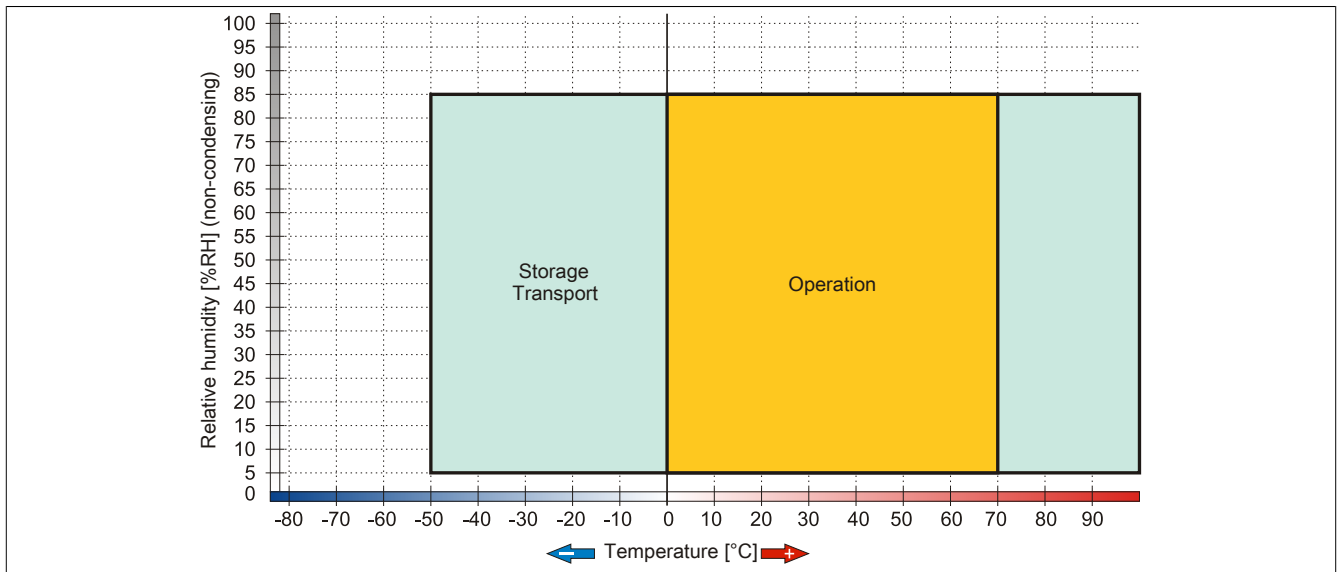

Figure 165: 5MMUSB.xxxx-01 - Temperature/Humidity diagram

11 USB media drive

11.1 5MD900.USB2-02

11.1.1 General information

The USB media drive features a DVD-R/RW DVD+R/RW drive, a CompactFlash slot and one USB port on both the front and back. It is connected to a USB port on the B&R Industrial PC.

- Desktop or rack-mounted operation (mounting rail brackets)
- Integrated DVD-R/RW DVD+R/RW drive
- Integrated IDE/ATAPI CompactFlash slot (hot pluggable)
- Integrated USB 2.0 connection
- +24 VDC supply (back)
- USB 2.0 connection (back)
- Optional front cover

11.1.2 Order data

Model number	Short description	Figure
USB accessories		
5MD900.USB2-02	USB 2.0 drive combination - DVD-R/RW, DVD+R/RW - CompactFlash slot	
Required accessories		
Other		
5SWUTI.0000-00	OEM Nero CD-RW Software, only available with a CD writer.	
Terminal blocks		
0TB103.9	Connector 24 VDC - 3-pin female - Screw clamps 3.31 mm ²	
0TB103.91	Connector 24 VDC - 3-pin female - Cage clamps 3.31 mm ²	
USB cables		
5CAUSB.0018-00	USB 2.0 connection cable type A - type B, 1.8 m	
5CAUSB.0050-00	USB 2.0 connection cable type A - type B, 5 m	

Table 244: 5MD900.USB2-02 - Order data

11.1.3 Interfaces

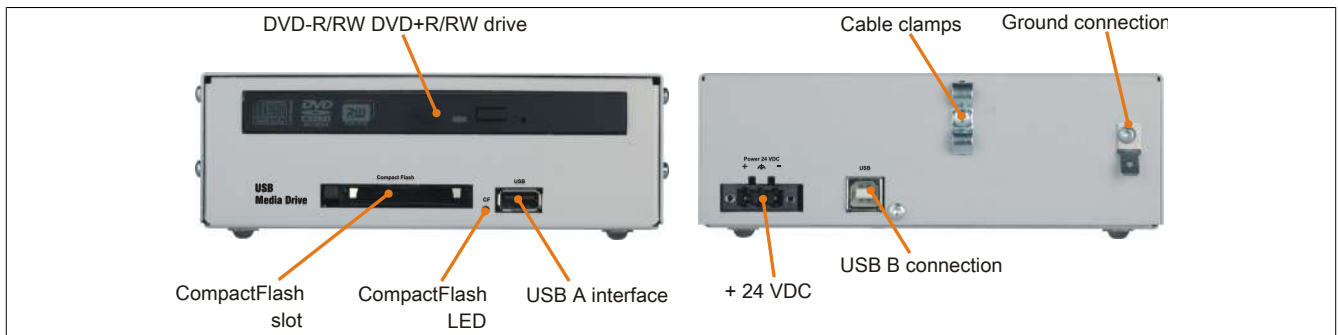

Figure 166: 5MD900.USB2-02 - Interfaces

11.1.4 Technical data

Product ID	5MD900.USB2-02
General information	
Max. cable length	5 m (not including hub)
Certification	
CE	Yes
cULus	Yes
GOST-R	Yes
Interfaces	
CompactFlash slot 1	
Type	Type I
Connection	IDE/ATAPI
Activity LED	Signals read or write access to an inserted CompactFlash card

Table 245: 5MD900.USB2-02 - Technical data

Product ID	5MD900.USB2-02
USB	
Type	USB 2.0
Execution	Type A front Type B back
Transfer rate	Low speed (1.5 Mbit/s), full speed (12 Mbit/s), high speed (480 Mbit/s)
Current load	Max. 500 mA
CD / DVD drive	
Data buffer capacity	2 MB
Data transfer rate	Max. 33.3 MB/s
Speed	Max. 5090 rpm \pm 1%
Noise level	Approx. 45 dBA in a distance of 50 cm (full read access)
Compatible formats	CD-DA, CD-ROM mode 1/mode 2 CD-ROM XA mode 2 (form 1, form 2) Photo CD (single-/multi-session), Enhanced CD, CD text DVD-ROM, DVD-R, DVD-RW, DVD-Video DVD-RAM (4.7GB, 2.6GB) DVD+R, DVD+R (dual layer), DVD+RW
Laser class	Class 1 laser
Service life	60000 POH (power-on hours)
Interface	IDE (ATAPI)
Startup time	
CD	Max. 14 seconds (from 0 rpm to read access)
DVD	Max. 15 seconds (from 0 rpm to read access)
Access time	
CD	Typ. 140 ms (24x)
DVD	Typ. 150 ms (8x)
Readable media	
CD	CD/CD-ROM (12 cm, 8 cm), CD-R, CD-RW
DVD	DVD-ROM, DVD-R, DVD-RW, DVD-RAM, DVD+R, DVD+R (dual layer), DVD+RW
Writable media	
CD	CD-R, CD-RW
DVD	DVD-R/RW, DVD-RAM (4.7 GB), DVD+R/RW, DVD+R (dual layer)
Read speed	
CD	24x
DVD	8x
Write speed	
CD-R	10 to 24x
CD-RW	10 to 24x
DVD+R	3.3 to 8x
DVD+R (dual layer)	2.4 to 4x
DVD+RW	3.3 to 8x
DVD-R	2 to 6x
DVD-R (dual layer)	2 to 4x
DVD-RAM	3 to 5x
DVD-RW	2 to 6x
Write methods	
CD	Disk at once, session at once, packet write, track at once
DVD	Disk at once, incremental, overwrite, sequential
Electrical characteristics	
Nominal voltage	24 VDC \pm 25%
Operating conditions	
EN 60529 protection	Front: IP65 (only with optional front cover), back: IP20
Environmental conditions	
Temperature ¹⁾	
Operation	5 to 45°C
Storage	-20 to 60°C
Transport	-40 to 60°C
Relative humidity	
Operation	20 to 80%
Storage	5 to 90%
Transport	5 to 95%
Vibration	
Operation	5 to 500 Hz: 0.3 g (2.9 m/s ² 0-peak)
Storage	10 to 100 Hz: 2 g (19.6 m/s ² 0-peak)
Transport	10 to 100 Hz: 2 g (19.6 m/s ² 0-peak)
Shock	
Operation	5 g, 11 ms
Storage	60 g, 11 ms
Transport	60 g, 11 ms
Altitude	
Operation	Max. 3000 m

Table 245: 5MD900.USB2-02 - Technical data

Product ID	5MD900.USB2-02
Mechanical characteristics	
Dimensions	
Width	156 mm
Height	52 mm
Depth	140 mm
Weight	Approx. 1100 g (without front cover)

Table 245: 5MD900.USB2-02 - Technical data

- Temperature specifications refer to operation at 500 meters. The maximum ambient temperature is typically derated by 1°C per 1000 meters (starting at 500 meters above sea level).

11.1.5 Dimensions

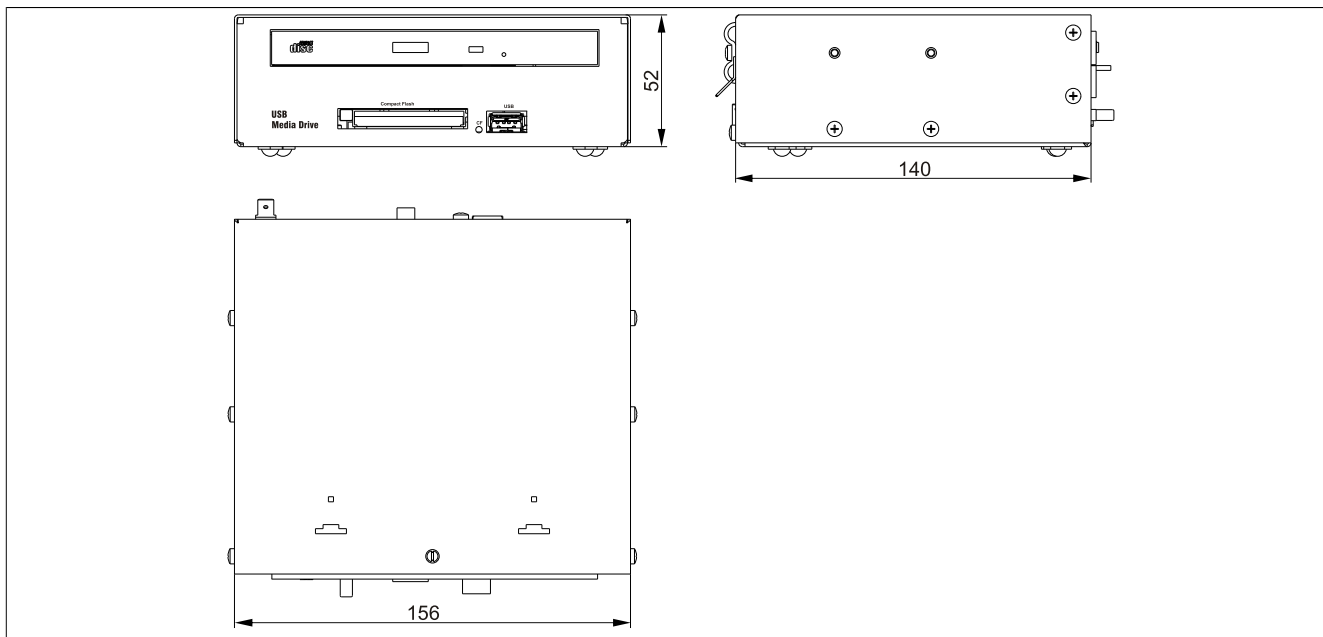

Figure 167: 5MD900.USB2-02 - Dimensions

11.1.6 Dimensions with front cover

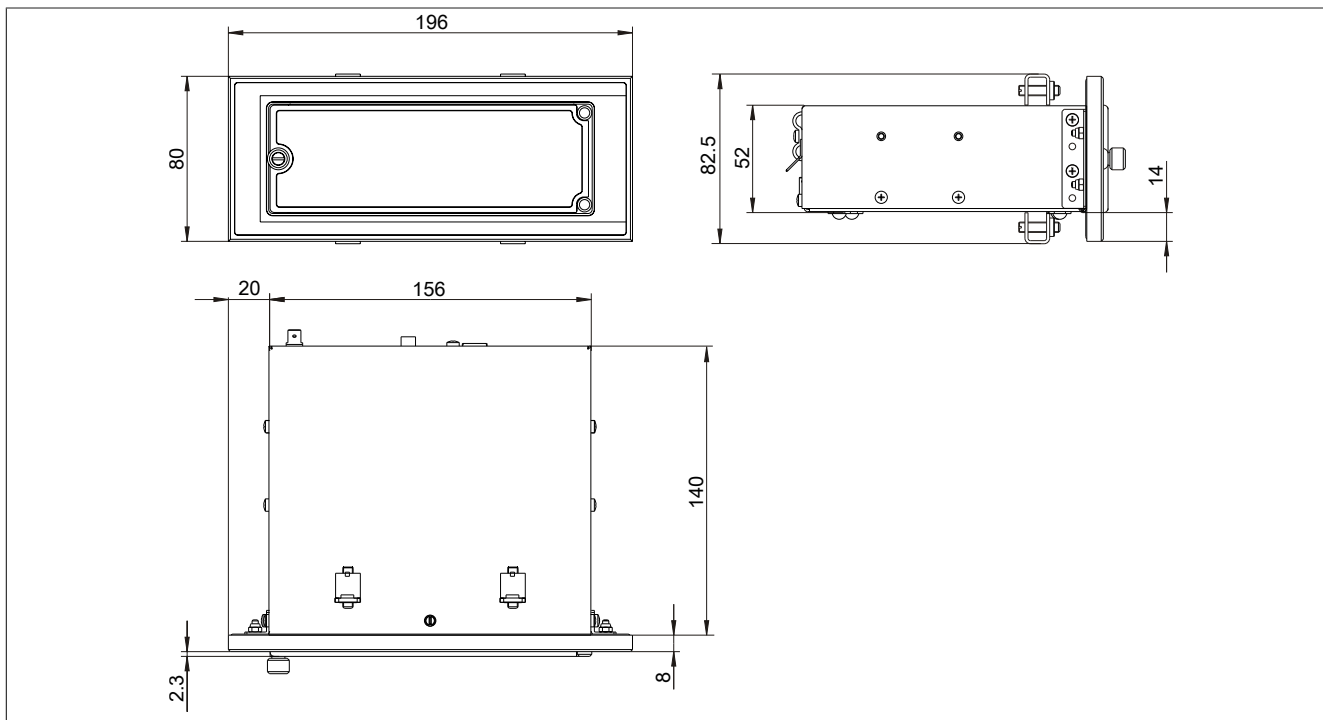

Figure 168: USB media drive with front cover - Dimensions

11.1.7 Cutout installation

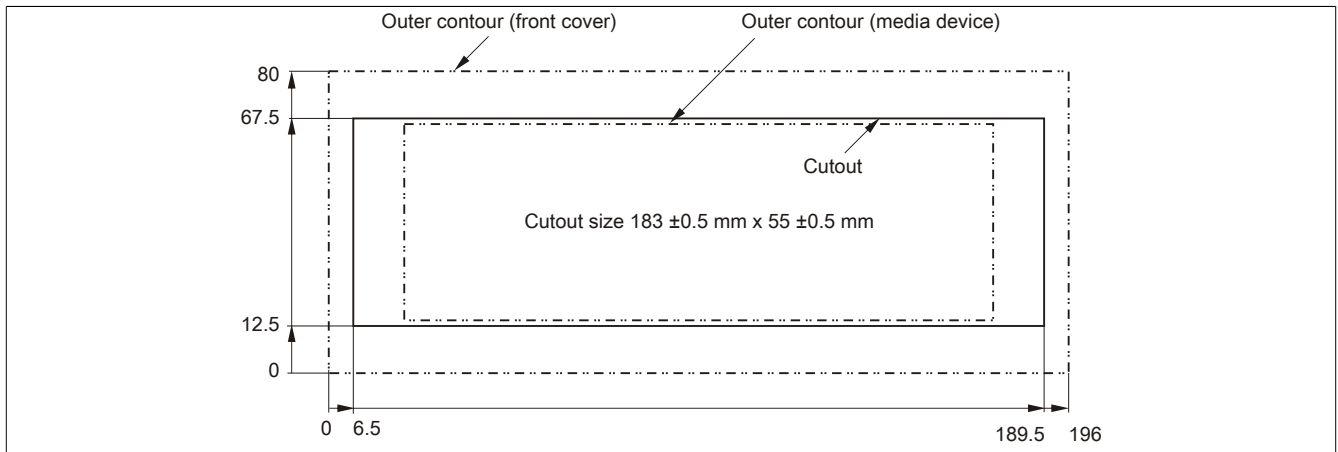

Figure 169: USB media drive with front cover - Installation cutout

11.1.8 Contents of delivery

Quantity	Component
1	USB media drive
2	Mounting rail brackets

Table 246: 5MD900.USB2-02 - Contents of delivery

11.1.9 Installation

The USB media drive can be operated as a desktop device (rubber feet) or as a rack-mounted device (2 mounting rail brackets included).

11.1.9.1 Mounting orientation

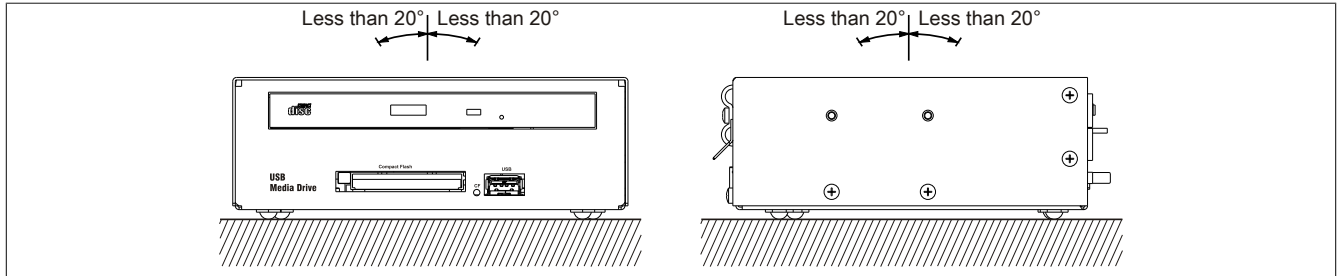

Figure 170: 5MD900.USB2-02 - Mounting orientation

11.2 5A5003.03

11.2.1 General information

This front cover can be mounted on the front of the USB media drive (model number 5MD900.USB2-00, 5MD900.USB2-01 or 5MD900.USB2-02) to protect the interface.

11.2.2 Order data

Model number	Short description	Figure
	USB accessories	
5A5003.03	Front cover for drives - 5A5003.02 - 5MD900.USB2	

Table 247: 5A5003.03 - Order data

11.2.3 Technical data

Product ID	5A5003.03
General information	
Certification	
CE	Yes
cULus	Yes
GOST-R	Yes
Mechanical characteristics	
Front	
Panel overlay	
Light background	Similar to Pantone 427CV
Dimensions	
Width	196 mm
Height	80 mm
Depth	8 mm

Table 248: 5A5003.03 - Technical data

11.2.4 Dimensions

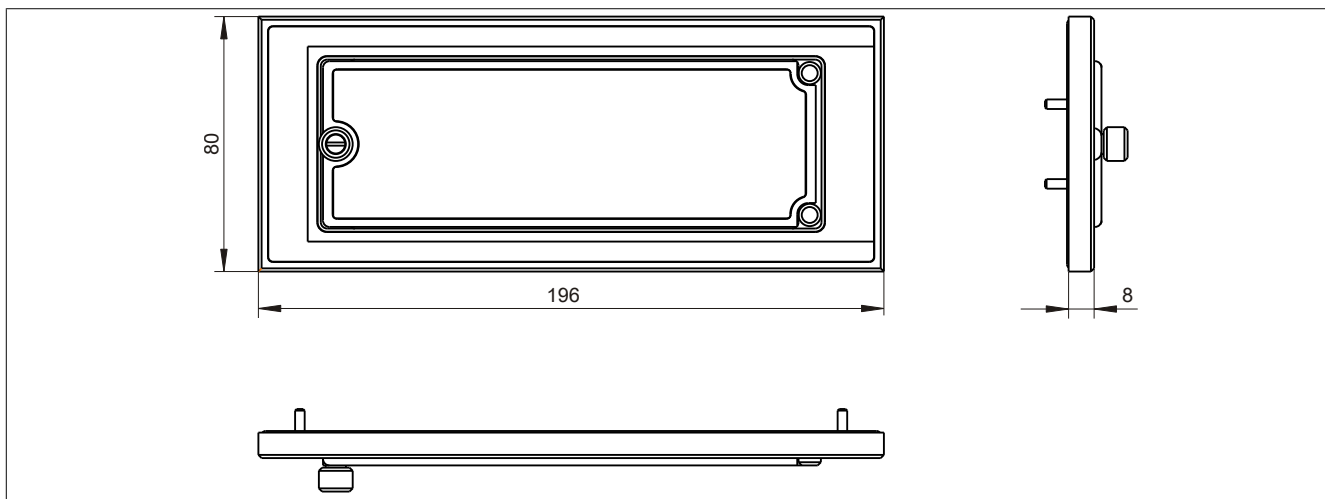

Figure 171: 5A5003.03 - Dimensions

11.2.5 Contents of delivery

Quantity	Component
1	Front cover 5A5003.03 for the USB media drive
4	M3 locknut
4	Cover retaining clip

Table 249: 5A5003.03 - Contents of delivery

11.2.6 Installation

The front cover is attached with 2 mounting rail brackets (included with the USB media drive) and 4 M3 locknuts. The 4 retaining clips provided can be used to mount the USB media drive and front cover as a whole, for example in a control cabinet door.

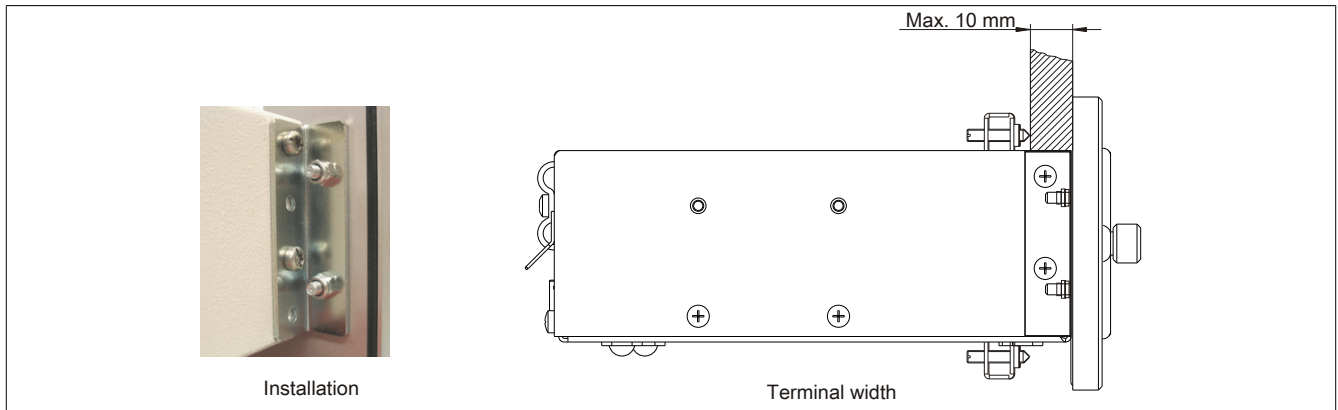

Figure 172: Front cover mounting and installation depth

11.2.6.1 Cutout installation

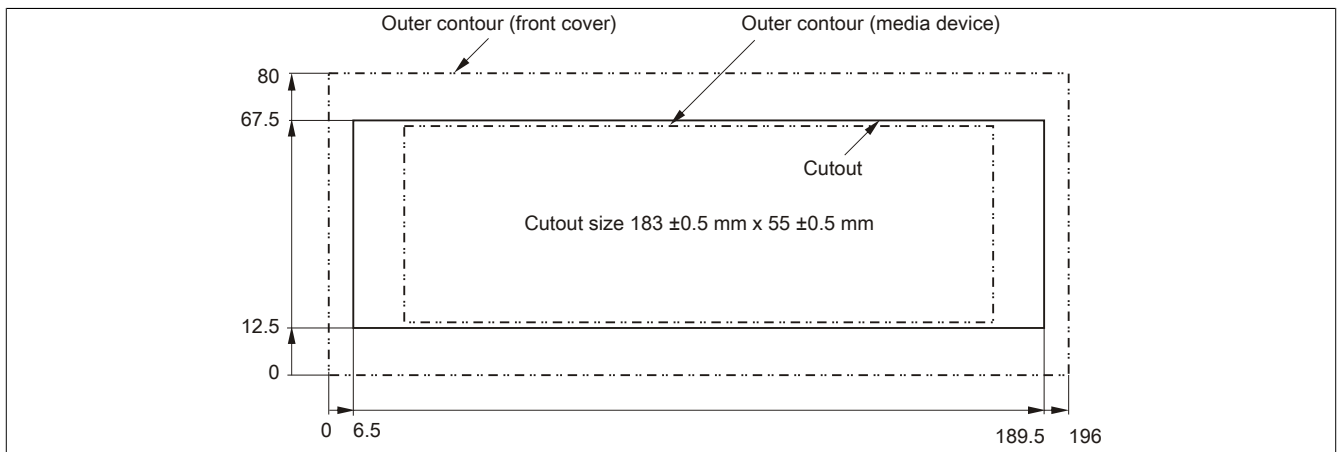

Figure 173: USB media drive with front cover - Installation cutout

12 HMI Drivers & Utilities DVD

12.1 5SWHMI.0000-00

12.1.1 General information

This DVD contains drivers, utilities, software upgrades and user's manuals for B&R panel system products (see the "Industrial PCs" or "Visualization and operation" section of the B&R website at www.br-automation.com).

When the DVD is created, its contents are identical to the files found in the Downloads section of the B&R website (Service / Material-related downloads).

12.1.2 Order data

Model number	Short description	Figure
5SWHMI.0000-00	<p>Other</p> <p>HMI Drivers & Utilities DVD</p>	

Table 250: 5SWHMI.0000-00 - Order data

12.1.3 Contents (V2.20)

BIOS product upgrades

- Automation PC 620 / Panel PC 700 CPU board 815E and 855GME BIOS
- Automation PC 620 / Panel PC 700 CPU board X855GME BIOS
- Automation PC 620 / Panel PC 700 CPU board 945GME BIOS
- Automation PC 620 / Panel PC 700 CPU board 945GME N270 BIOS
- Automation PC 680
- Automation PC 810 / Automation PC 820 / Panel PC 800 B945GME BIOS
- Automation PC 810 / Panel PC 800 945GME N270 CPU board BIOS
- Automation PC 810 / Panel PC 800 GM45 CPU board BIOS
- Provit 2000 product family - IPC2000/2001/2002
- Provit 5000 product family - IPC5000/5600/5000C/5600C
- Power Panel 100 BIOS devices
- Mobile Panel 100 BIOS devices
- Power Panel 100 / Mobile Panel 100 user boot logo
- Power Panel 100 / Mobile Panel 100 REMHOST utility
- Power Panel 300/400 BIOS devices
- Power Panel 300/400 BIOS user boot logo
- Power Panel 500 / Automation PC 510 / Automation PC 511 BIOS
- Panel PC 310

Device drivers

- Automation Device Interface (ADI)
- Audio
- Chipset
- CD-ROM
- LS120

- Graphics
- Network
- PCI / SATA RAID controller
- Touch screen
- Touchpad
- Interface board

Firmware upgrades

- Automation PC 620 / Panel PC 700 (MTCX, SDLR, SDLT)
- Automation PC 810 (MTCX, SDLR, SDLT)
- Automation PC 820 (MTCX, SDLR, SDLT)
- Mobile Panel 100 (SMCX)
- Panel PC 300 (MTCX)
- Power Panel 100 (aPCI)
- Power Panel 300/400 (aPCI)
- Power Panel 300/400 (MTCX)
- Power Panel 500 / Automation PC 510 / Automation PC 511 (MTCX, SDLR, I/O board)
- Panel PC 800 (MTCX, SDLR, SDLT)
- UPS firmware

Utilities/Tools

- B&R Embedded OS Installer
- Windows CE Tools
- User boot logo conversion program
- SATA RAID Installation Utility
- Automation Device Interface (ADI)
- CompactFlash service life calculator (Silicon Systems)
- Miscellaneous
- MTC utilities
- B&R Key Editor
- MTC & Mkey utilities
- Mkey utilities
- UPS configuration software
- ICU ISA configuration
- Intel PCI NIC boot ROM
- Diagnostic programs

Windows

- Windows CE 6.0
- Windows CE 5.0
- Windows CE 4.2
- Windows CE 4.1
- Windows CE Tools
- Windows Embedded Standard 2009
- Windows Embedded Standard 7
- Thin client
- Windows NT Embedded
- Windows XP Embedded
- VNC viewer

MCAD templates for

- Industrial PCs

- Visualization and operating devices
- Slide-in label templates
- Custom designs

ECAD templates for

- Industrial PCs
- Automation PCs
- Automation Panel 900
- Panels (Power Panel)

Documentation for

- Automation PC 511
- Automation PC 620
- Automation PC 680
- Automation PC 810
- Automation PC 820
- Automation Panel 800
- Automation Panel 900
- Panel PC 310
- Panel PC 700
- Panel PC 725
- Panel PC 800
- Power Panel 15/21/35/41
- Power Panel 100/200
- Power Panel 300/400
- Power Panel 500
- Mobile Panel 40/50
- Mobile Panel 100/200
- Mobile Panel connection box
- Provit 2000
- Provit 3030
- Provit 4000
- Provit 5000
- Provit Benchmark
- Provit Mkey
- Windows CE 5.0 help documentation
- Windows CE 6.0 help documentation
- Windows NT Embedded application guide
- Windows XP Embedded application guide
- Uninterruptible power supply
- Implementation guides
- B&R Hilscher fieldbus cards (CANopen, DeviceNet, PROFIBUS, PROFINET)

Service tools

- Acrobat Reader 5.0.5 (freeware in German, English and French)
- Power Archiver 6.0 (freeware in German, English and French)
- Internet Explorer 5.0 (German and English)
- Internet Explorer 6.0 (German and English)

13 Cables

13.1 DVI cables

13.1.1 5CADVI.0xxx-00

13.1.1.1 General information

5CADVI.0xxx-00 DVI cables are designed for use in inflexible applications.

Caution!

Power must be disconnected before connecting or disconnecting cables.

13.1.1.2 Order data

Model number	Short description	Figure
	DVI cables	
5CADVI.0018-00	DVI-D cable - 1.8 m	
5CADVI.0050-00	DVI-D cable - 5 m	
5CADVI.0100-00	DVI-D cable - 10 m	

Table 251: 5CADVI.0018-00, 5CADVI.0050-00, 5CADVI.0100-00 - Order data

13.1.1.3 Technical data

Product ID	5CADVI.0018-00	5CADVI.0050-00	5CADVI.0100-00
General information			
Certification		Yes	
CE		Yes	
cULus		Yes	
GOST-R		Yes	
GL		Yes ¹⁾	
Cable construction			
Wire cross section		AWG 28	
Shield		Individual cable pairs and entire cable	
Complete shielding		Tinned copper braiding, optical coverage >86%	
Outer sheathing		PVC	
Material		Beige	
Color		AWM STYLE 20276 80°C 30V VW1 DVI DIGITAL SINGLE LINK DER AN	
Labeling			
Connector			
Type		2x DVI-D (18+1), male	
Connection cycles		100	
Locating screw tightening torque		Max. 0.5 Nm	
Electrical characteristics			
Conductor resistance		Max. 237 Ω/km	
Insulation resistance		Min. 100 MΩ/km	
Mechanical characteristics			
Dimensions			
Length	1.8 m ±50 mm	5 m ±80 mm	10 m ±100 mm
Diameter		Max. 8.5 mm	
Flex radius	≥5x cable diameter (male connector - ferrite bead and ferrite bead - ferrite bead)		
Weight	Approx. 260 g	Approx. 460 g	Approx. 790 g

Table 252: 5CADVI.0018-00, 5CADVI.0050-00, 5CADVI.0100-00 - Technical data

1) Yes, although applies only if all components installed within the complete system have this certification.

13.1.1.4 Flex radius specifications

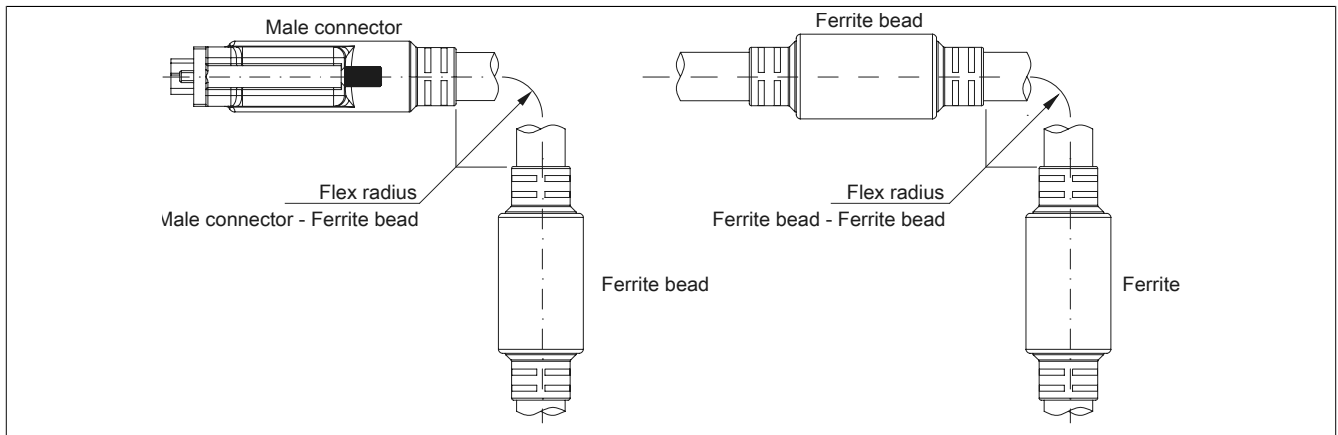

Figure 174: Flex radius specifications

13.1.1.5 Dimensions

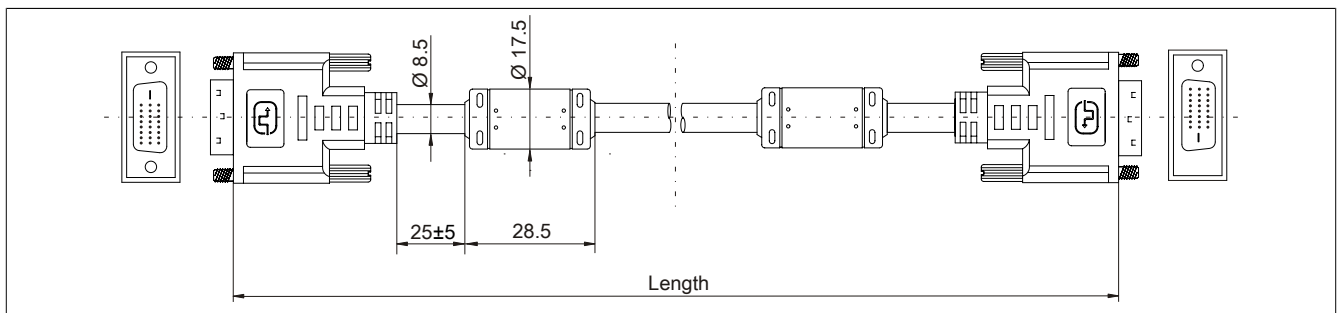

Figure 175: 5CADVI.0xxx-00 - Dimensions

13.1.1.6 Cable pinout

Warning!

Field-assembled cables must be wired according to these specifications.

If a field-assembled cable is used, B&R cannot guarantee that it will function properly. All cables provided by B&R are guaranteed to function properly, however.

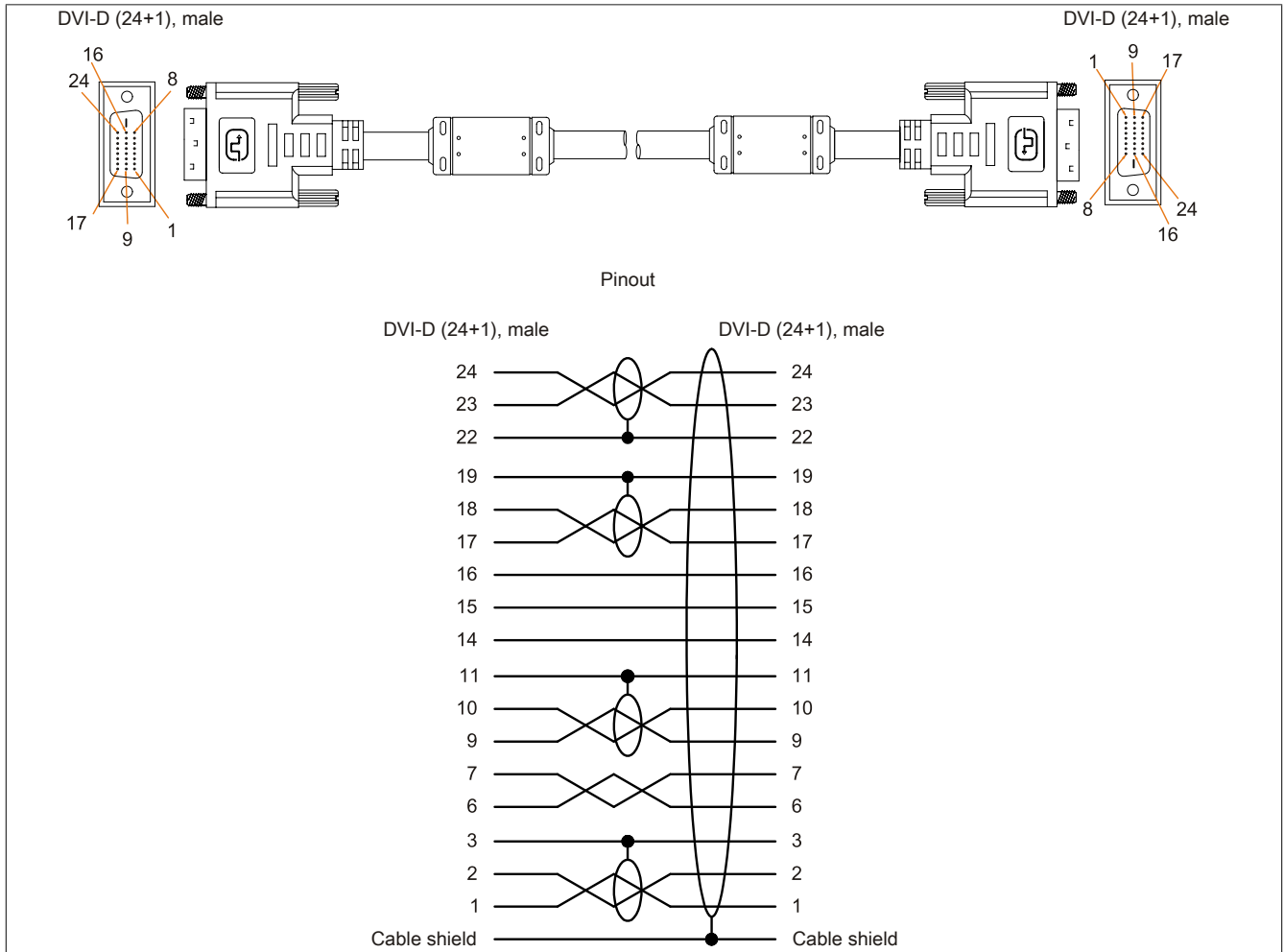

Figure 176: 5CADVI.0xxx-00 - Pinout

13.2 SDL cables

13.2.1 5CASDL.0xxx-00

13.2.1.1 General information

5CASDL.0xxx-00 SDL cables are designed for use in inflexible applications. 5CASDL.0xxx-03 SDL flex cables are required for flexible applications (e.g. swing arm systems).

Caution!

Power must be disconnected before connecting or disconnecting cables.

13.2.1.2 Order data

Model number	Short description	Figure
	SDL cables	
5CASDL.0018-00	SDL cable - 1.8 m	
5CASDL.0050-00	SDL cable - 5 m.	
5CASDL.0100-00	SDL cable, 10 m	
5CASDL.0150-00	SDL cable, 15 m	
5CASDL.0200-00	SDL cable, 20 m	
5CASDL.0250-00	SDL cable, 25 m	
5CASDL.0300-00	SDL cable, 30 m	

Table 253: 5CASDL.0018-00, 5CASDL.0050-00, 5CASDL.0100-00, 5CASDL.0150-00, 5CASDL.0200-00, 5CASDL.0250-00, 5CASDL.0300-00 - Order data

13.2.1.3 Technical data

Product ID	5CASDL. 0018-00	5CASDL. 0050-00	5CASDL. 0100-00	5CASDL. 0150-00	5CASDL. 0200-00	5CASDL. 0250-00	5CASDL. 0300-00
General information							
Certification				Yes			
CE				Yes			
cULus				Yes			
GOST-R				Yes			
GL	Yes ¹⁾	Yes ²⁾			Yes ¹⁾		
Cable construction							
Wire cross section	AWG 28			AWG 24			
Shield	Individual cable pairs and entire cable						
Complete shielding	Tinned copper braiding, optical coverage >85%						
Outer sheathing							
Material	PVC						
Color	Black						
Labeling	E74020-C (UL) AWM STYLE 20176 80°C 30V VW-1 DVI DIGITAL LINK						
Connector							
Type	2x DVI-D (24+1), male						
Connection cycles	100						
Contacts	Gold-plated						
Mechanical protection	Metal cover with crimped stress relief						
Locating screw tightening torque	Max. 0.5 Nm						
Electrical characteristics							
Conductor resistance				≤93 Ω/km			
AWG 24							
AWG 28	≤237 Ω/km						
Insulation resistance	Min. 10 MΩ/km						
Mechanical characteristics							
Dimensions							
Length	1.8 m ±30 mm	5 m ±30 mm	10 m ±50 mm	15 m ±100 mm	20 m ±100 mm	25 m ±100 mm	30 m ±100 mm
Diameter	Typ. 8.6 ±0.2 mm Max. 9 mm			Typ. 11 ±0.2 mm Max. 11.5 mm			
Flex radius	≥5x cable diameter (male connector - ferrite bead and ferrite bead - ferrite bead)						

Table 254: 5CASDL.0018-00, 5CASDL.0050-00, 5CASDL.0100-00, 5CASDL.0150-00, 5CASDL.0200-00, 5CASDL.0250-00, 5CASDL.0300-00 - Technical data

Product ID	5CASDL.0018-00	5CASDL.0050-00	5CASDL.0100-00	5CASDL.0150-00	5CASDL.0200-00	5CASDL.0250-00	5CASDL.0300-00
Flexibility	Limited flexibility, valid for ferrite bead - ferrite bead (tested 100 cycles with 5x cable diameter, 20 cycles/minute)	Limited flexibility; valid for ferrite bead - ferrite bead (tested 100 cycles with 5x cable diameter, 20 cycles / minute)	Limited flexibility, valid for ferrite bead - ferrite bead (tested 100 cycles with 5x cable diameter, 20 cycles/minute)				
Weight	Approx. 300 g	Approx. 580 g	Approx. 1500 g	Approx. 2250 g	Approx. 2880 g	Approx. 4800 g	Approx. 5520 g

Table 254: 5CASDL.0018-00, 5CASDL.0050-00, 5CASDL.0100-00, 5CASDL.0150-00, 5CASDL.0200-00, 5CASDL.0250-00, 5CASDL.0300-00 - Technical data

- 1) Yes, although applies only if all components installed within the complete system have this certification.
- 2) Yes, although applies only if all components installed within the complete system have this certification

13.2.1.4 Flex radius specifications

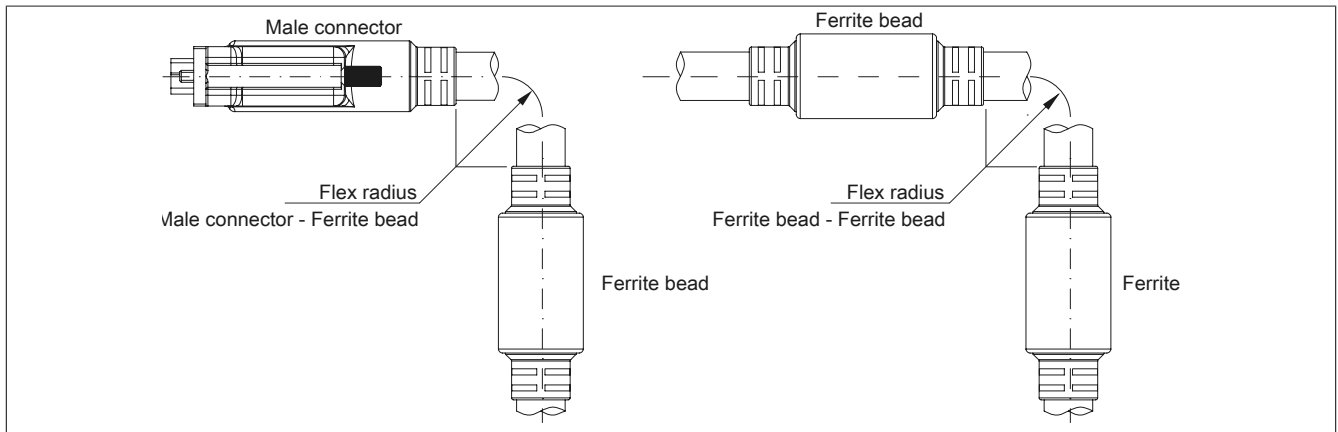

Figure 177: Flex radius specifications

13.2.1.5 Dimensions

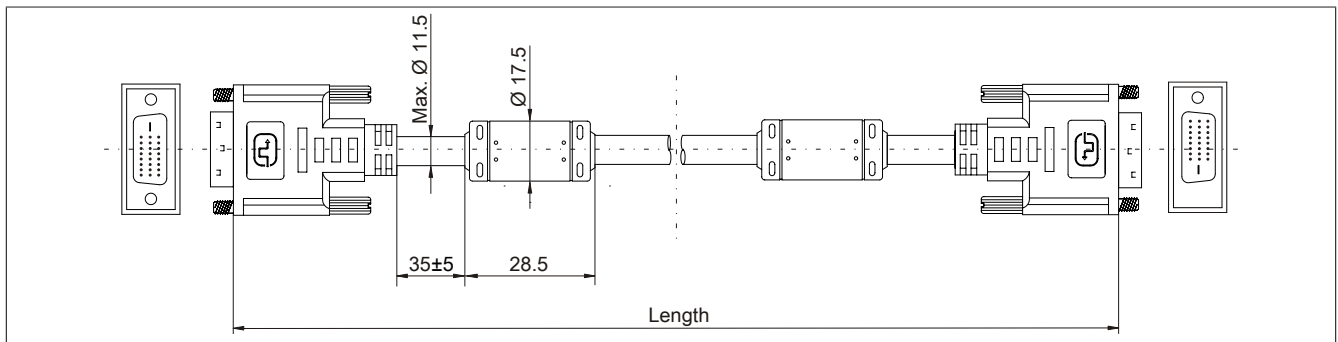

Figure 178: 5CASDL.0xxx-00- Dimensions

13.2.1.6 Cable pinout

Warning!

Field-assembled cables must be wired according to these specifications.

If a field-assembled cable is used, B&R cannot guarantee that it will function properly. All cables provided by B&R are guaranteed to function properly, however.

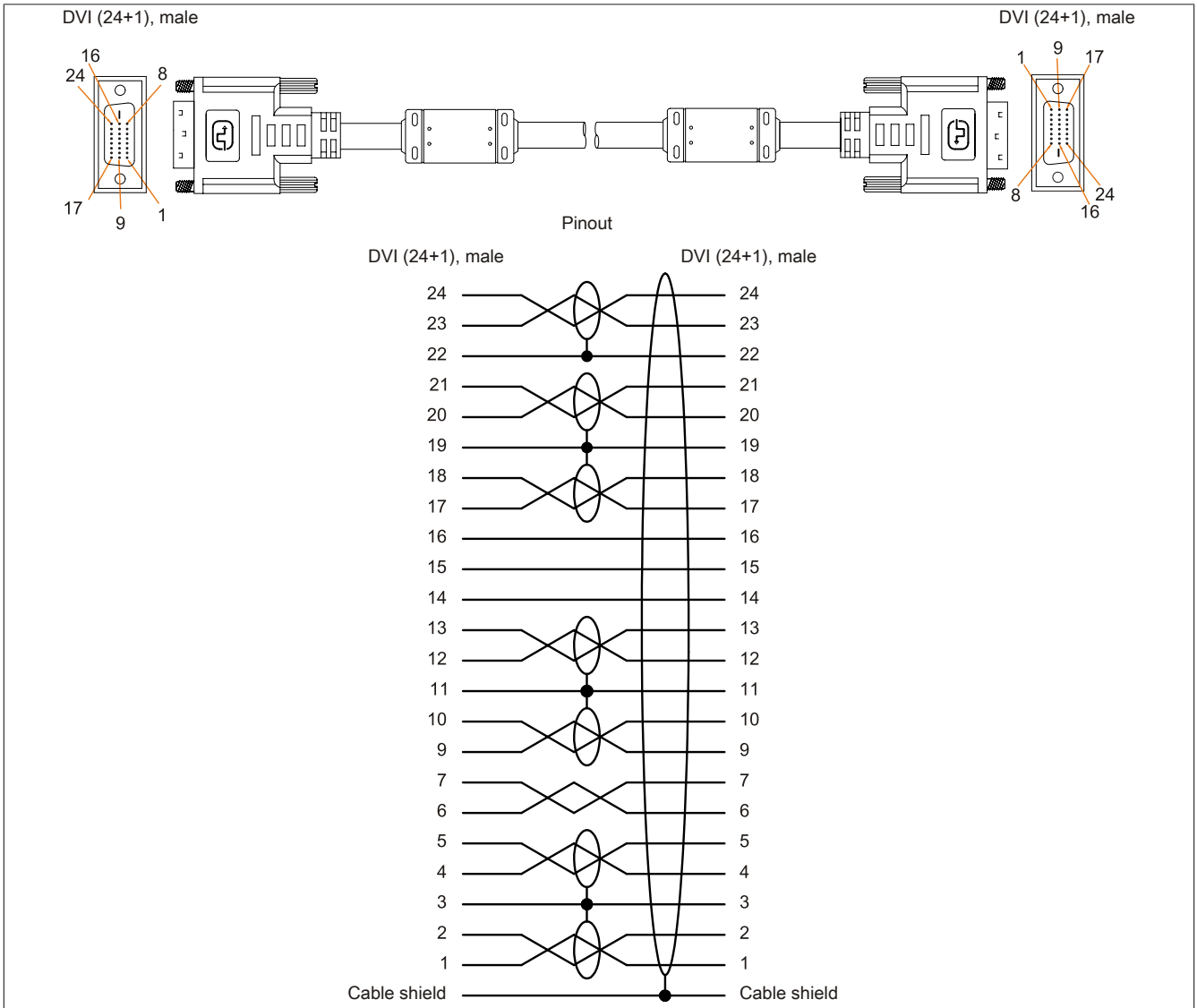

Figure 179: 5CASDL.0xxx-00 - Pinout

13.3 SDL cables with 45° male connector

13.3.1 5CASDL.0xxx-01

13.3.1.1 General information

5CASDL.0xxx-01 SDL cables with a 45° connector are designed for use in inflexible applications.

Caution!

Power must be disconnected before connecting or disconnecting cables.

13.3.1.2 Order data

Model number	Short description	Figure
	SDL cables with 45° connectors	
5CASDL.0018-01	SDL cable - 45° connector - 1.8 m	
5CASDL.0050-01	SDL cable with 45° male connector, 5 m	
5CASDL.0100-01	SDL cable with 45° male connector, 10 m	
5CASDL.0150-01	SDL cable with 45° male connector, 15 m	

Table 255: 5CASDL.0018-01, 5CASDL.0050-01, 5CASDL.0100-01, 5CASDL.0150-01 - Order data

13.3.1.3 Technical data

Product ID	5CASDL.0018-01	5CASDL.0050-01	5CASDL.0100-01	5CASDL.0150-01
General information				
Certification				
CE			Yes	
cULus			Yes	
GOST-R			Yes	
GL			Yes ¹⁾	
Cable construction				
Wire cross section	AWG 28		AWG 24	
Shield	Individual cable pairs and entire cable			
Complete shielding	Tinned copper braiding, optical coverage >85%			
Outer sheathing				
Material	PVC			
Color	Black			
Connector				
Type	2x DVI-D (24+1), male			
Connection cycles	100			
Contacts	Gold-plated			
Mechanical protection	Metal cover with crimped stress relief			
Locating screw tightening torque	Max. 0.5 Nm			
Electrical characteristics				
Conductor resistance				
AWG 24	-		≤93 Ω/km	
AWG 28	≤237 Ω/km		-	
Insulation resistance	Min. 10 MΩ/km			
Mechanical characteristics				
Dimensions				
Length	1.8 m ±30 mm	5 m ±50 mm	10 m ±100 mm	15 m ±100 mm
Diameter	Max. 9 mm		Max. 11.5 mm	
Flex radius	≥5x cable diameter (male connector - ferrite bead and ferrite bead - ferrite bead)			
Fixed installation				
Flexibility	Limited flexibility, valid for ferrite bead - ferrite bead (tested 100 cycles with 5x cable diameter, 20 cycles/minute)			
Weight	Approx. 300 g	Approx. 590 g	Approx. 2800 g	Approx. 2860 g

Table 256: 5CASDL.0018-01, 5CASDL.0050-01, 5CASDL.0100-01, 5CASDL.0150-01 - Technical data

1) Yes, although applies only if all components installed within the complete system have this certification.

13.3.1.4 Flex radius specifications

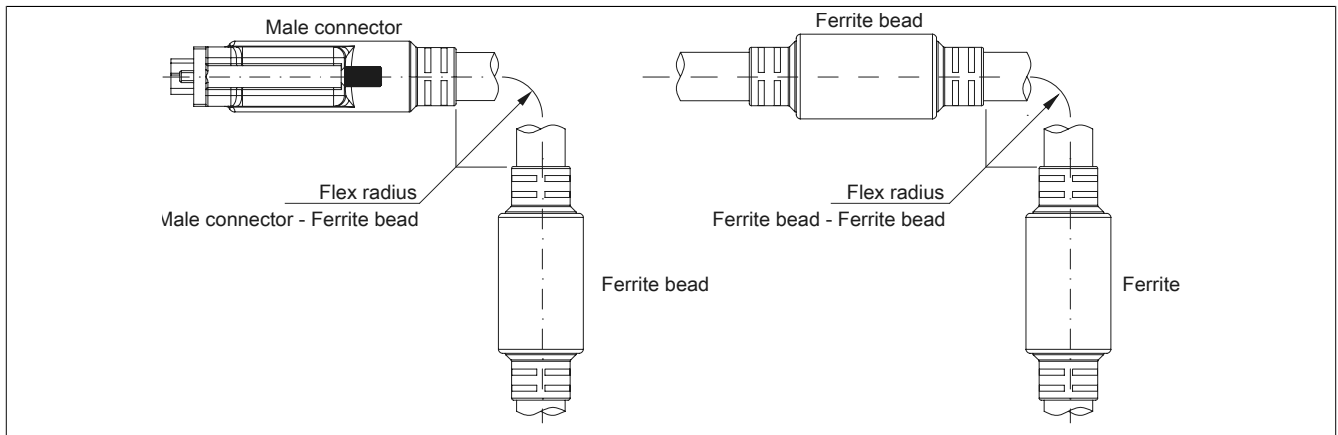

Figure 180: Flex radius specifications

13.3.1.5 Dimensions

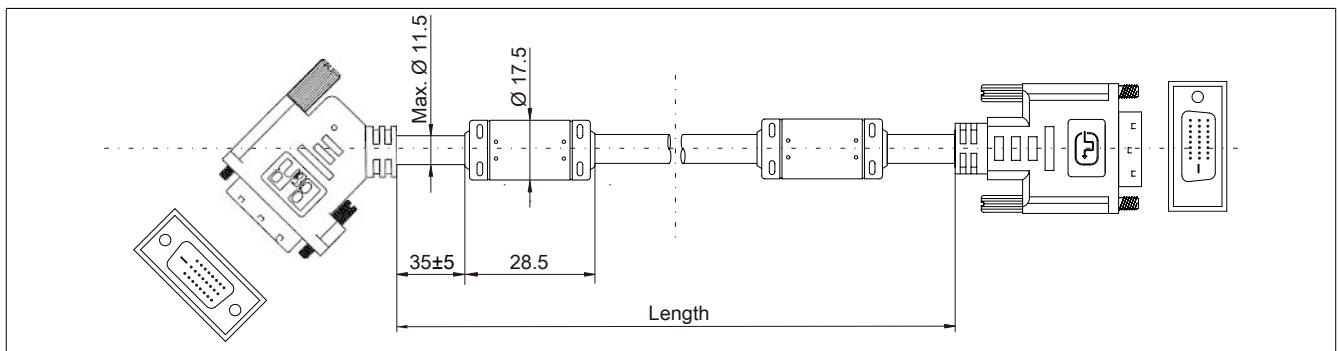

Figure 181: 5CASDL.0xxx-01 - Dimensions

13.3.1.6 Cable pinout

Warning!

Field-assembled cables must be wired according to these specifications.

If a field-assembled cable is used, B&R cannot guarantee that it will function properly. All cables provided by B&R are guaranteed to function properly, however.

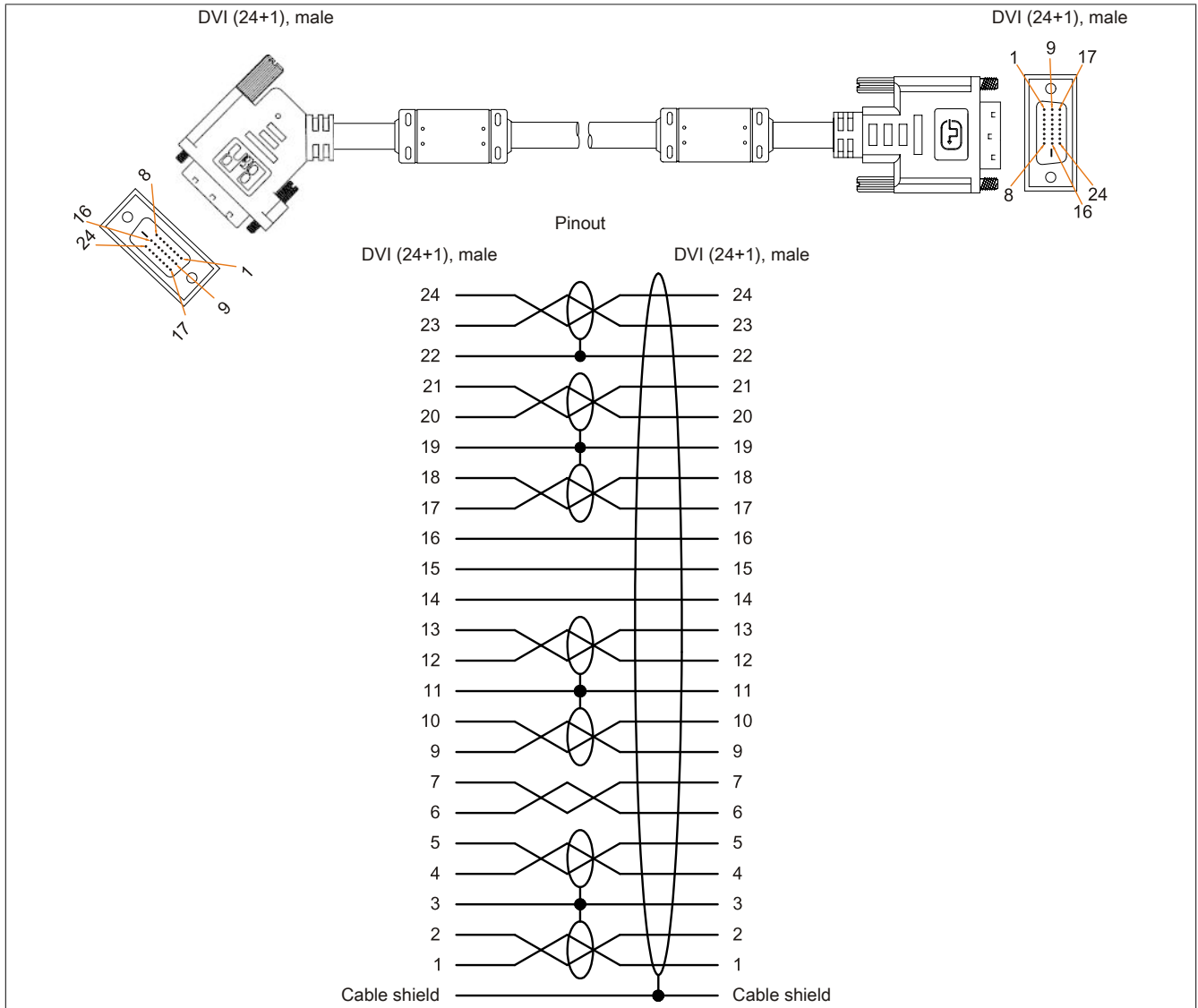

Figure 182: 5CASDL.0xxx-01 - Pinout

13.4 SDL flex cables

13.4.1 5CASDL.0xxx-03

13.4.1.1 General information

5CASDL.0xxx-03 SDL flex cables are designed for use in both inflexible and flexible applications (e.g. swing arm systems).

Caution!

Power must be disconnected before connecting or disconnecting cables.

13.4.1.2 Order data

Model number	Short description	Figure
	SDL flex cables	
5CASDL.0018-03	SDL flex cable - 1.8 m	
5CASDL.0050-03	SDL flex cable, 5 m	
5CASDL.0100-03	SDL flex cable, 10 m	
5CASDL.0150-03	SDL flex cable, 15 m	
5CASDL.0200-03	SDL flex cable, 20 m	
5CASDL.0250-03	SDL flex cable, 25 m	
5CASDL.0300-03	SDL flex cable, 30 m	

Table 257: 5CASDL.0018-03, 5CASDL.0050-03, 5CASDL.0100-03, 5CASDL.0150-03, 5CASDL.0200-03, 5CASDL.0250-03, 5CASDL.0300-03 - Order data

13.4.1.3 Technical data

Product ID	5CASDL. 0018-03	5CASDL. 0050-03	5CASDL. 0100-03	5CASDL. 0150-03	5CASDL. 0200-03	5CASDL. 0250-03	5CASDL. 0300-03
General information							
Certification				Yes			
CE				Yes			
cULus				Yes			
GOST-R				Yes			
GL				Yes ¹⁾			
Cable construction							
Wire cross section				AWG 24 (control wires) AWG 26 (DVI, USB, data)			
Features				Silicone- and halogen-free			
Shield				Individual cable pairs and entire cable			
Complete shielding				Aluminum-clad foil + tinned copper braiding			
Outer sheathing				Special semi-glossy TPU			
Material				Black			
Color				(B&R) SDL Cable (UL) AWM 20236 80°C 30V E 63216			
Labeling							
Connector							
Type				2x DVI-D (24+1), male			
Connection cycles				Min. 200			
Contacts				Gold-plated			
Mechanical protection				Metal cover with crimped stress relief			
Locating screw tightening torque				Max. 0.5 Nm			
Electrical characteristics							
Operating voltage				≤30 V			
Test voltage				1 kV			
Wire/Wire				0.5 kV			
Wire/Shield							
Wave impedance				100 ±10 Ω			
Conductor resistance				≤95 Ω/km			
AWG 24				≤145 Ω/km			
AWG 26							
Insulation resistance				>200 MΩ/km			
Operating conditions							
Approbation				UL AWM 20236 80°C 30 V			
Flame-retardant				In accordance with UL758 (cable vertical flame test)			
Oil and hydrolysis resistance				In accordance with VDE 0282-10			

Table 258: 5CASDL.0018-03, 5CASDL.0050-03, 5CASDL.0100-03, 5CASDL.0150-03, 5CASDL.0200-03, 5CASDL.0250-03, 5CASDL.0300-03 - Technical data

Product ID	5CASDL.0018-03	5CASDL.0050-03	5CASDL.0100-03	5CASDL.0150-03	5CASDL.0200-03	5CASDL.0250-03	5CASDL.0300-03
Environmental conditions							
Temperature							
Storage	-20 to 80°C						
Fixed installation	-20 to 80°C						
Flexible installation	-5 to 60°C						
Mechanical characteristics							
Dimensions							
Length	1.8 m ±20 mm 5 m ±45 mm 10 m ±90 mm 15 m ±135 mm 20 m ±180 mm 25 m ±225 mm 30 m ±270 mm						
Diameter	Max. 12 mm						
Flex radius							
Fixed installation	≥6x cable diameter (from male connector - ferrite bead)						
	≥10x cable diameter (from ferrite bead - ferrite bead)						
Flexible installation	≥15x cable diameter (from ferrite bead - ferrite bead)						
Flexibility	Flexible, valid for ferrite bead - ferrite bead (tested 300,000 cycles with 15x cable diameter, 4800 cycles/hour)			Flexible; valid for ferrite bead - ferrite bead (tested 300,000 cycles with 15x cable diameter, 4800 cycles/hour)			
Drag chain data							
Flex cycles	300,000						
Speed	4800 cycles/hour						
Flex radius	180 mm, 15x cable diameter			180 mm, 15x cable diameter			
Hub	460 mm						
Weight	Approx. 460 g	Approx. 1020 g	Approx. 1940 g	Approx. 2840 g	Approx. 3740 g	Approx. 4560 g	Approx. 5590 g
Tension							
During operation	≤50 N						
During installation	≤400 N						

Table 258: 5CASDL.0018-03, 5CASDL.0050-03, 5CASDL.0100-03, 5CASDL.0150-03, 5CASDL.0200-03, 5CASDL.0250-03, 5CASDL.0300-03 - Technical data

1) Yes, although applies only if all components installed within the complete system have this certification.

13.4.1.4 Flex radius specifications

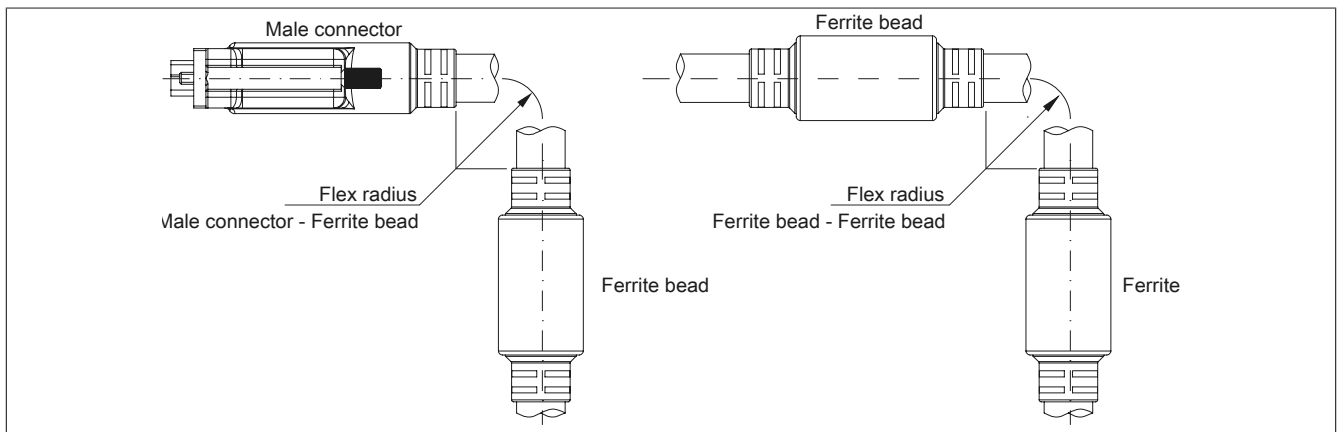

Figure 183: Flex radius specifications

13.4.1.5 Dimensions

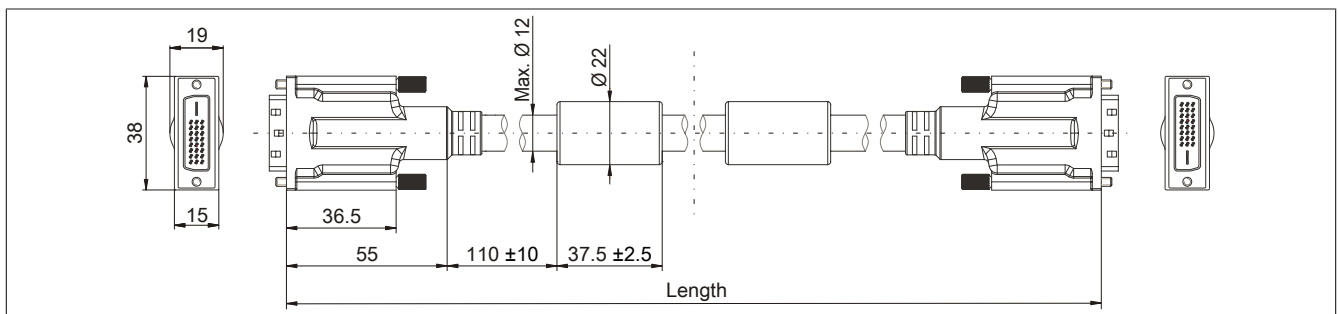

Figure 184: 5CASDL.0xxx-03 - Dimensions

13.4.1.6 Design

Element	Assignment	Cross section
DVI	TMDS data 0	26 AWG
	TMDS data 1	26 AWG
	TMDS data 2	26 AWG
	TMDS cycle	26 AWG
USB	XUSB0	26 AWG
	XUSB1	26 AWG
Data	SDL	26 AWG
	DDC cycle	24 AWG
Control wires	DDC data	24 AWG
	+5 V	24 AWG
	Ground	24 AWG
	Hot plug detect	24 AWG

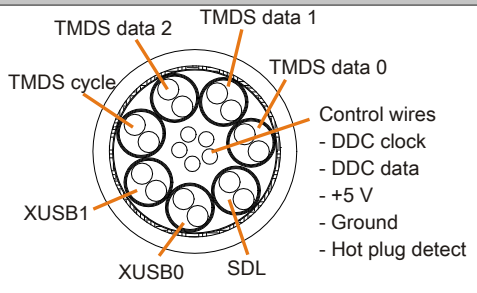

Table 259: 5CASDL.0xxx-03 SDL flex cables - Structure

13.4.1.7 Cable pinout

Warning!

Field-assembled cables must be wired according to these specifications.

If a field-assembled cable is used, B&R cannot guarantee that it will function properly. All cables provided by B&R are guaranteed to function properly, however.

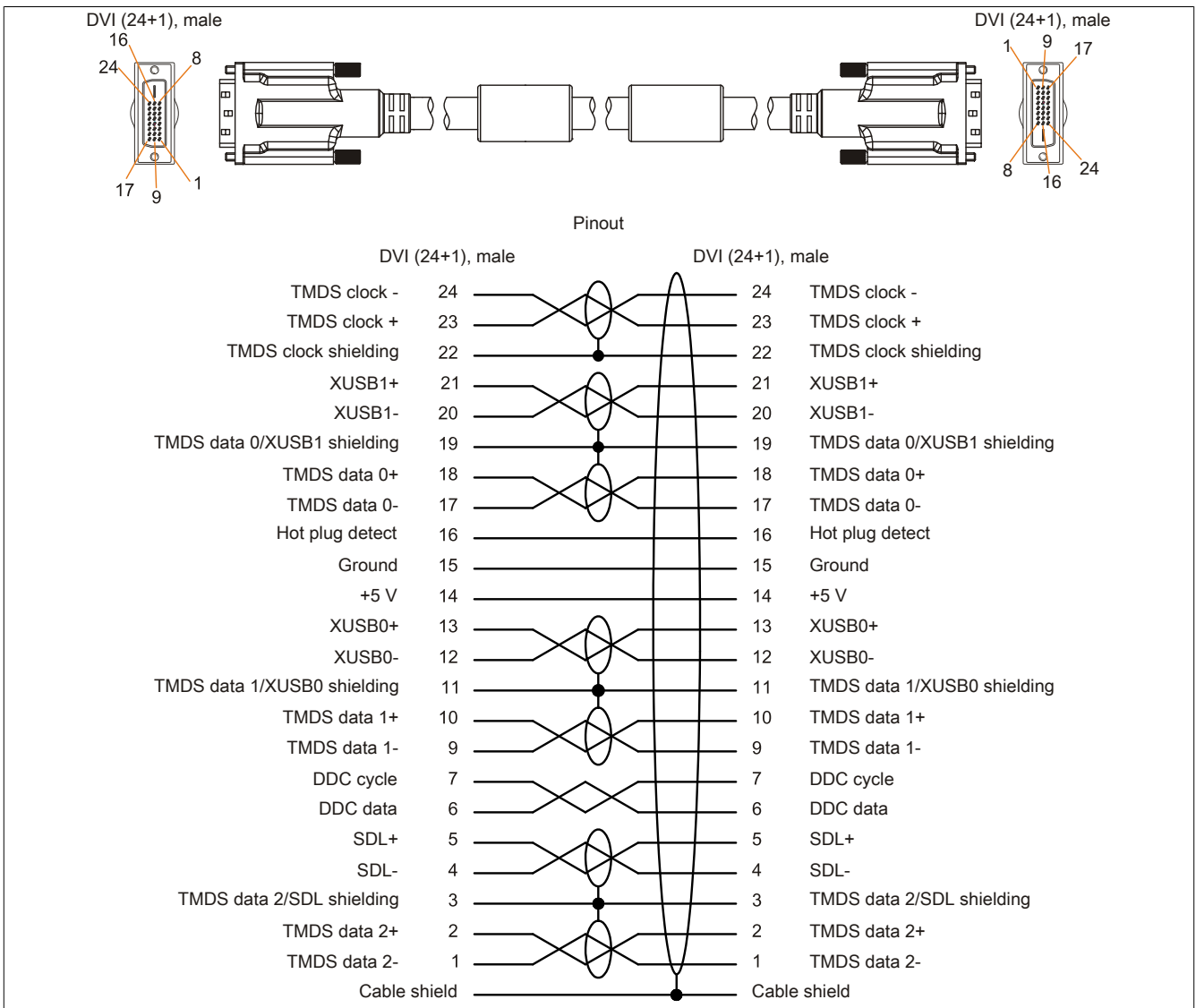

Figure 185: 5CASDL.0xxx-03 - Pinout

13.5 SDL flex cables with extender

13.5.1 5CASDL.0xx0-13

13.5.1.1 General information

5CASDL.0xx0-13 SDL flex cables with an extender are designed for use in both inflexible and flexible applications (e.g. swing arm systems).

Caution!

Power must be disconnected before connecting or disconnecting cables.

13.5.1.2 Order data

Model number	Short description	Figure
	SDL flex cables	
5CASDL.0300-13	SDL flex cable with extender, 30 m	
5CASDL.0400-13	SDL flex cable with extender, 40 m	
5CASDL.0430-13	SDL flex cable with extender, 43 m	

Table 260: 5CASDL.0300-13, 5CASDL.0400-13, 5CASDL.0430-13 - Order data

13.5.1.3 Technical data

Product ID	5CASDL.0300-13	5CASDL.0400-13	5CASDL.0430-13
General information			
Certification		Yes	
CE		Yes	
cULus		Yes	
GOST-R		Yes	
GL		Yes ¹⁾	
Cable construction			
Wire cross section		AWG 24 (control wires) AWG 26 (DVI, USB, data)	
Features		Silicone- and halogen-free	
Shield		Individual cable pairs and entire cable	
Complete shielding		Aluminum-clad foil + tinned copper braiding	
Outer sheathing			
Material		Special semi-glossy TMPU	
Color		Black	
Labeling		(B&R) SDL cable (UL) AWM 20236 80°C 30V E63216	
Connector			
Type		2x DVI-D (24+1), male	
Connection cycles		Min. 200	
Contacts		Gold-plated	
Mechanical protection		Metal cover with crimped stress relief	
Locating screw tightening torque		Max. 0.5 Nm	
Electrical characteristics			
Operating voltage		≤30 V	
Test voltage			
Wire/Wire		1 kV	
Wire/Shield		0.5 kV	
Wave impedance		100 ±10 Ω	
Conductor resistance			
AWG 24		≤95 Ω/km	
AWG 26		≤145 Ω/km	
Insulation resistance		>200 MΩ/km	
Operating conditions			
Approbation		UL AWM 20236 80°C 30 V	
Flame-retardant		In accordance with UL758 (cable vertical flame test)	
Oil and hydrolysis resistance		In accordance with VDE 0282-10	
Environmental conditions			
Temperature			
Storage		-20 to 60°C	
Fixed installation		-20 to 60°C	
Flexible installation		-5 to 60°C	

Table 261: 5CASDL.0300-13, 5CASDL.0400-13, 5CASDL.0430-13 - Technical data

Product ID	5CASDL.0300-13	5CASDL.0400-13	5CASDL.0430-13
Mechanical characteristics			
Dimensions			
Length	30 m ±280 mm	40 m ±380 mm	43 m ±410 mm
Diameter		Max. 12 mm	
Extender box			
Width		35 mm	
Length		125 mm	
Height		18.5 mm	
Flex radius			
Fixed installation	≥6x cable diameter (from male connector - ferrite bead)		
	≥10x cable diameter (from ferrite bead - ferrite bead)		
Flexible installation	≥15x cable diameter (from ferrite bead - ferrite bead)		
Flexibility	Flexible; valid for ferrite bead - ferrite bead (tested 300,000 cycles with 15x cable diameter, 4800 cycles/hour)		
Drag chain data			
Flex cycles	300,000		
Speed	4800 cycles/hour		
Flex radius	180 mm; 15x cable diameter		
Hub	460 mm		
Weight	Approx. 5430 g	Approx. 7200 g	Approx. 7790 g
Tension			
During operation	≤50 N		
During installation	≤400 N		

Table 261: 5CASDL.0300-13, 5CASDL.0400-13, 5CASDL.0430-13 - Technical data

1) Yes, although applies only if all components installed within the complete system have this certification.

13.5.1.4 Flex radius specifications

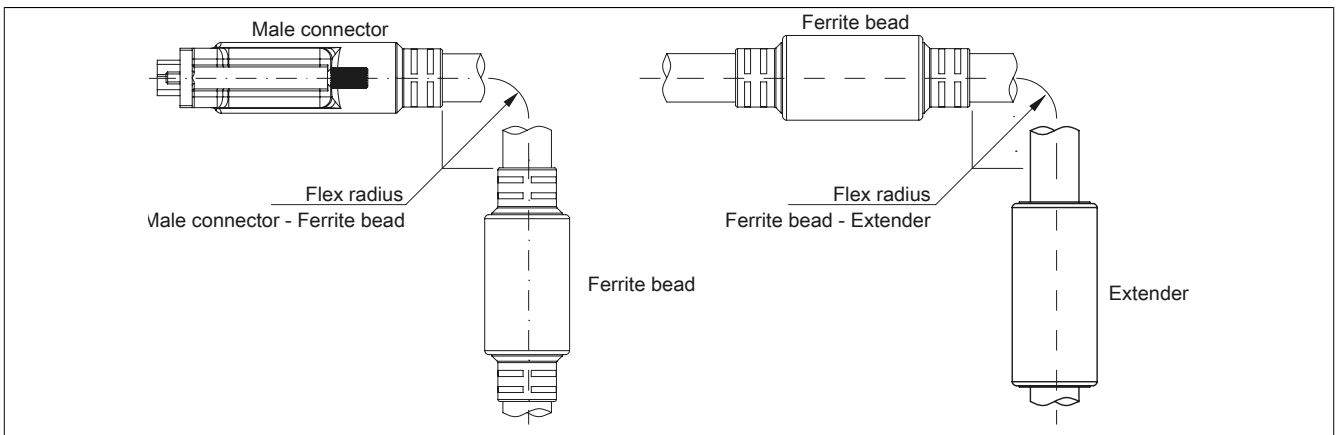

Figure 186: Flex radius specification with extender

13.5.1.5 Dimensions

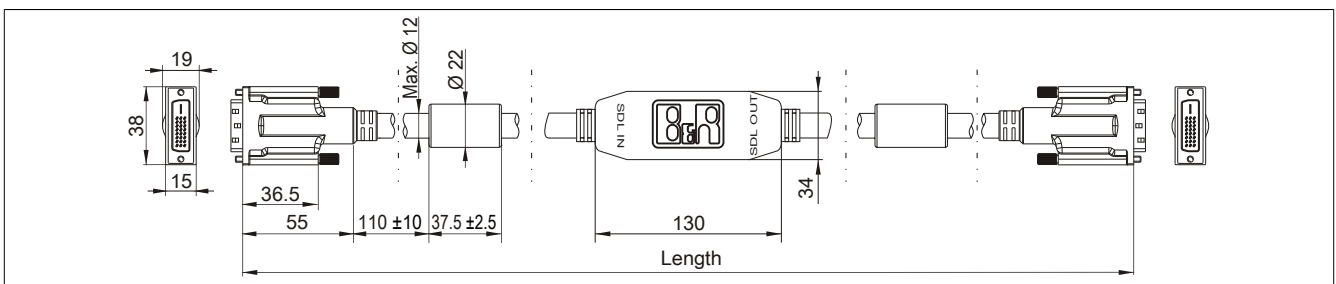

Figure 187: 5CASDL.0xx0-13 - Dimensions

13.5.1.6 Cable pinout

Warning!

Field-assembled cables must be wired according to these specifications.

If a field-assembled cable is used, B&R cannot guarantee that it will function properly. All cables provided by B&R are guaranteed to function properly, however.

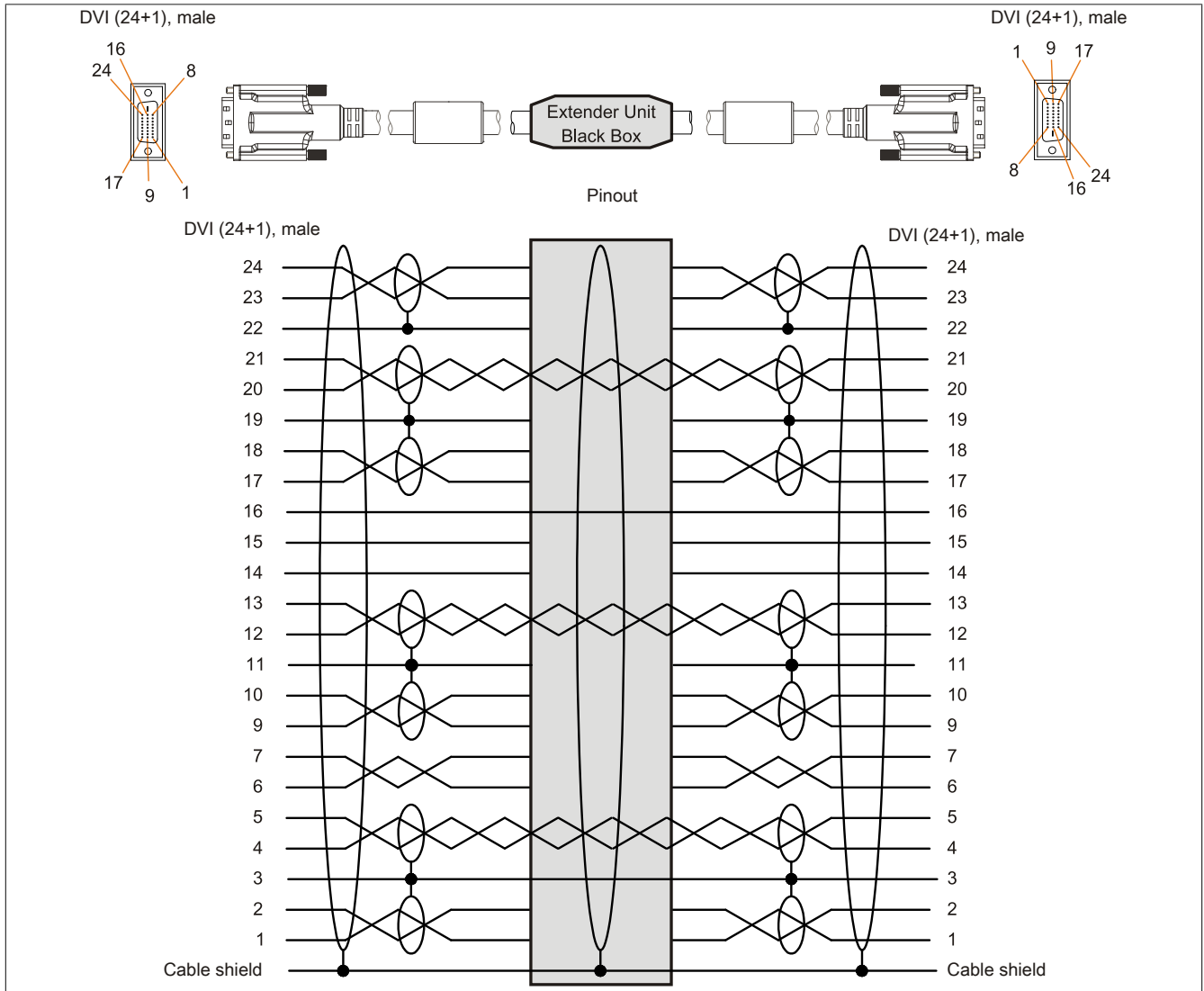

Figure 188: 5CASDL.0xx0-13 - Pinout

13.5.1.7 Cable connection

SDL flex cables with an extender must be connected between the B&R Industrial PC and the Automation Panel display unit in the correct direction. The proper signal direction is indicated on the extender.

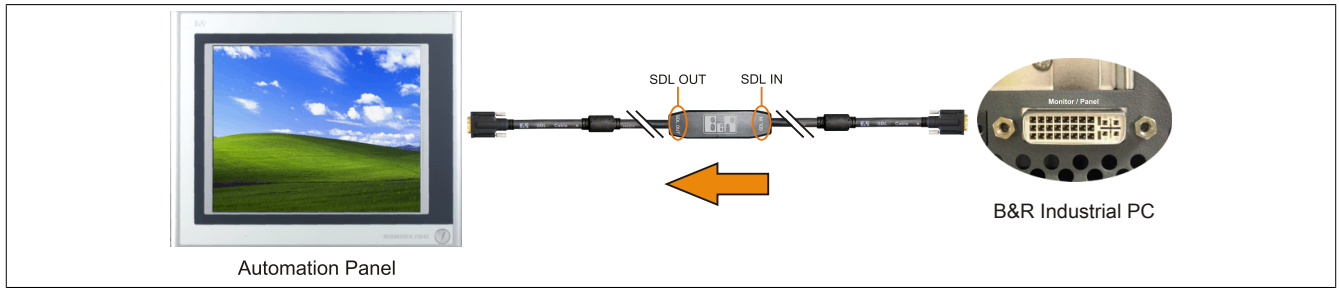

Figure 189: Example of the signal direction for an SDL flex cable with extender

13.6 USB cables

13.6.1 5CAUSB.00xx-00

13.6.1.1 General information

USB cables are designed to achieve USB 2.0 transfer speeds.

13.6.1.2 Order data

Model number	Short description	Figure
	USB cables	
5CAUSB.0018-00	USB 2.0 connection cable type A - type B, 1.8 m	
5CAUSB.0050-00	USB 2.0 connection cable type A - type B, 5 m	

Table 262: 5CAUSB.0018-00, 5CAUSB.0050-00 - Order data

13.6.1.3 Technical data

Product ID	5CAUSB.0018-00	5CAUSB.0050-00
General information		
Certification		
CE		Yes
cULus		Yes
GOST-R		Yes
Cable construction		
Wire cross section		AWG 24, 28
Shield		Entire cable
Outer sheathing		
Color		Beige
Connector		
Type	USB type A male and USB type B male	
Mechanical characteristics		
Dimensions		
Length	1.8 m ±30 mm	5 m ±50 mm
Diameter		Max. 5 mm
Flex radius		Min. 100 mm

Table 263: 5CAUSB.0018-00, 5CAUSB.0050-00 - Technical data

13.6.1.4 Cable pinout

Warning!

Field-assembled cables must be wired according to these specifications.

If a field-assembled cable is used, B&R cannot guarantee that it will function properly. All cables provided by B&R are guaranteed to function properly, however.

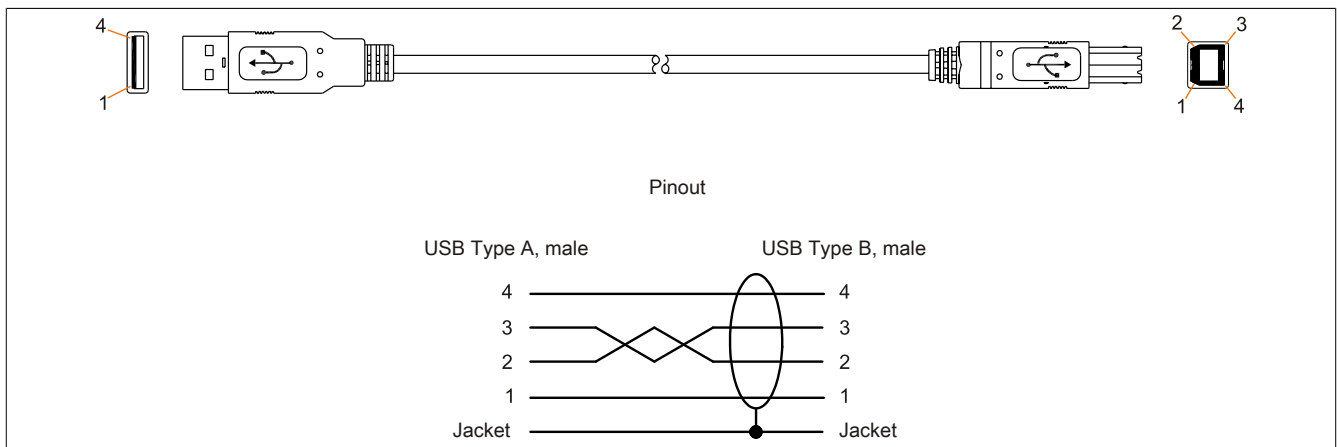

Figure 190: 5CAUSB.00xx-00 USB cables - Pinout

13.7 RS232 cables

13.7.1 9A0014.xx

13.7.1.1 General information

RS232 cables are used as extension cables between two RS232 interfaces.

13.7.1.2 Order data

Model number	Short description	Figure
	RS232 cables	
9A0014.02	RS232 extension cable for remote operation of a display unit with touch screen, 1.8 m	
9A0014.05	RS232 extension cable for remote operation of a display unit with touch screen, 5 m	
9A0014.10	RS232 extension cable for remote operation of a display unit with touch screen, 10 m	

Table 264: 9A0014.02, 9A0014.05, 9A0014.10 - Order data

13.7.1.3 Technical data

Product ID	9A0014.02	9A0014.05	9A0014.10
General information			
Certification		Yes	Yes
CE			
GOST-R	-		
Cable construction			
Wire cross section		AWG 26	
Shield		Entire cable	
Outer sheathing			
Color		Beige	
Connector			
Type		9-pin male/female DSUB connector	
Locating screw tightening torque		Max. 0.5 Nm	
Mechanical characteristics			
Dimensions			
Length	1.8 m ±50 mm	5 m ±80 mm	10 m ±100 mm
Diameter		Max. 5 mm	
Flex radius		Min. 70 mm	

Table 265: 9A0014.02, 9A0014.05, 9A0014.10 - Technical data

13.7.1.4 Cable pinout

Warning!

Field-assembled cables must be wired according to these specifications.

If a field-assembled cable is used, B&R cannot guarantee that it will function properly. All cables provided by B&R are guaranteed to function properly, however.

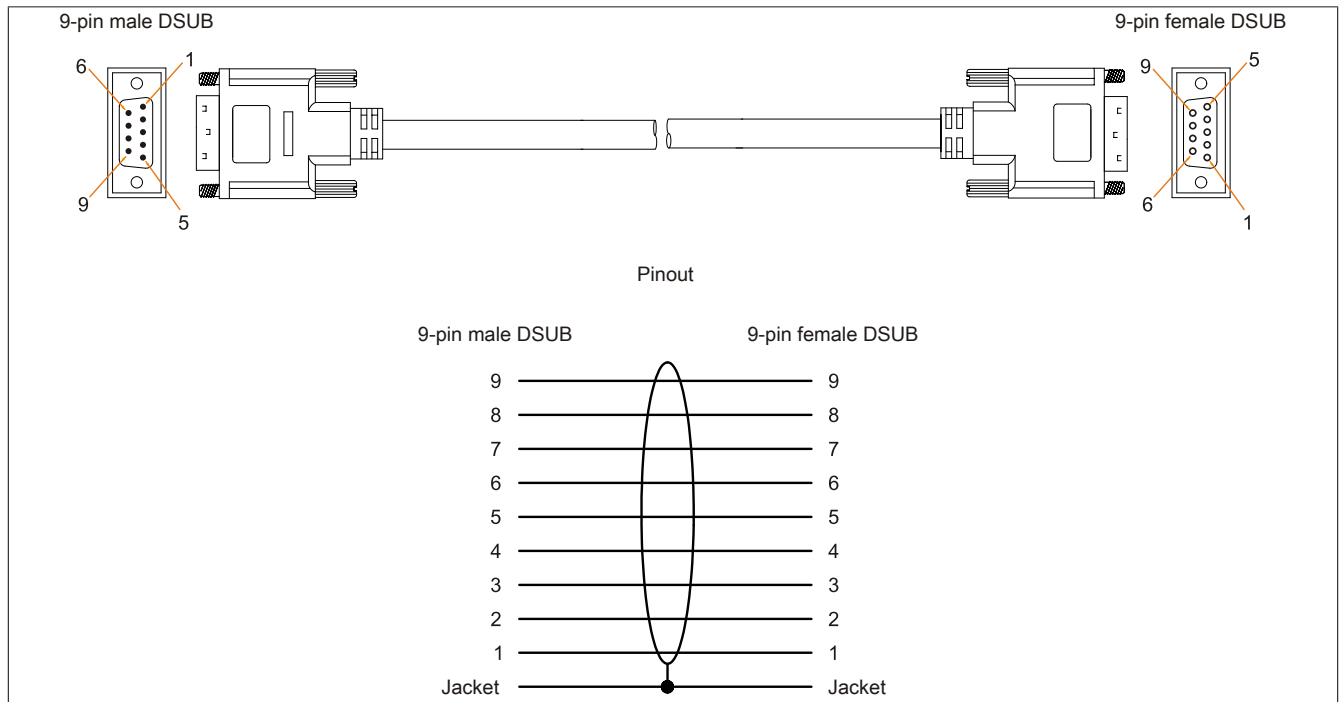

Figure 191: 9A0014.xx RS232 cables - Pinout

13.8 Internal supply cable

13.8.1 5CAMSC.0001-00

13.8.1.1 General information

This supply cable is used internally, for example to provide power to special PCI cards. It is connected to the mainboard.

For requirements and procedures, see "Connecting an external device to the mainboard" on page 364.

Caution!

Power must be turned off before plugging in and unplugging cables.

13.8.1.2 Order data

Model number	Short description	Figure
	Accessories	
5CAMSC.0001-00	Internal supply cable	

Table 266: 5CAMSC.0001-00 - Order data

13.8.1.3 Technical data

Product ID	5CAMSC.0001-00
General information	
Certification	
CE	Yes
GOST-R	Yes
Cable structure	
Wire cross section	AWG 22
Connector	
Type	1x 4-pin male disk drive power connector, 1x 4-pin female connector housing
Mechanical characteristics	
Dimensions	
Length	100 mm ±5 mm
Flexibility	Flexible

Table 267: 5CAMSC.0001-00 - Technical data

Chapter 7 • Maintenance and service

This chapter describes service/maintenance work that can be carried out by a qualified end user.

1 Replacing the battery

The lithium battery buffers the internal real-time clock (RTC) and CMOS data.

Information:

- The product design allows the battery to be changed with the B&R device switched either on or off. In some countries, safety regulations do not allow batteries to be changed while the module is switched on.
- Any BIOS settings that have been made will remain when the battery is changed with the power turned off (stored in nonvolatile EEPROM). The date and time must be reset later since this data is lost when the battery is changed.
- The battery should only be replaced by qualified personnel.

Warning!

The battery is only permitted to be replaced by a Renata CR2477N battery. The use of another battery may present a risk of fire or explosion.

The battery may explode if handled improperly. Do not recharge, disassemble or dispose of in fire.

The following replacement lithium batteries are available: 4A0006.00-000 (1 pc.) and 0AC201.91 (4 pcs.).

1.1 Evaluating the battery status

The status of the battery is determined immediately after the device is started and subsequently checked by the system every 24 hours. During this measurement, the battery is subjected to a brief load (approximately 1 second) and then evaluated. Once determined, the battery status is displayed in BIOS (Advanced - OEM features - System board features - Voltage values) and in the B&R Control Center (ADI driver); it can also be read in a customer application using the ADI library.

Battery status	Function
N/A	The hardware or firmware being used is too old and does not support reading the battery status.
GOOD	Data buffering is intact.
BAD	From the point when battery capacity is recognized as insufficient (BAD), data buffering is intact for approximately another 500 hours.

Table 268: Battery status

From the point when battery capacity is recognized as insufficient, data buffering is intact for approximately another 500 hours. When replacing the battery, data is buffered for approximately 10 minutes by a gold leaf capacitor.

1.2 Procedure

- Disconnect the power supply to the B&R Industrial PC.
- Touch the housing or ground connection in order to discharge any electrostatic charge from your body.
- Remove the cover from the battery compartment and carefully pull out the battery using the removal strip.



Figure 192: Removing the battery

- The battery should not be held by its edges. Insulated tweezers may also be used to insert the battery.

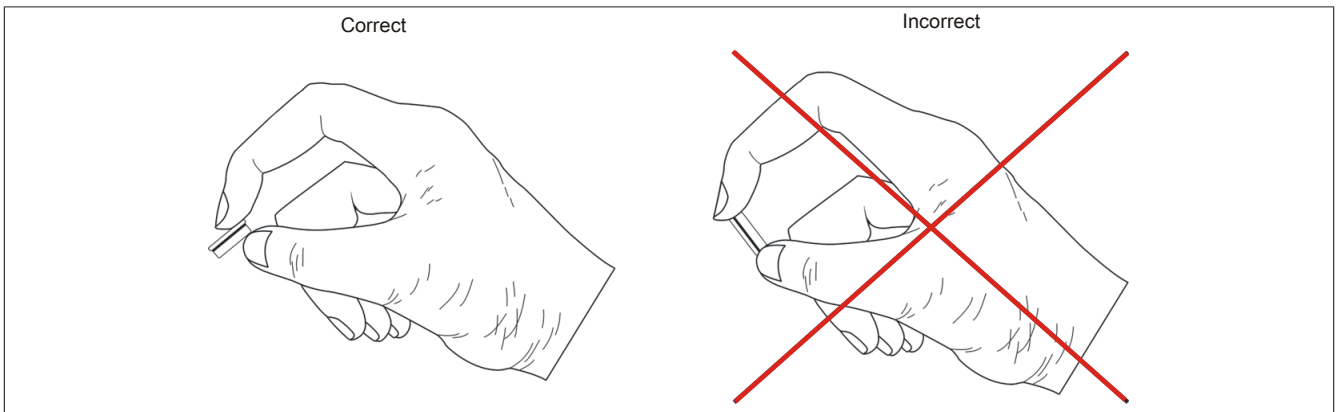

Figure 193: Battery handling

- Insert the new battery with the correct polarity.



Figure 194: Battery polarity

- To make the next battery replacement easier, be sure the removal strip is in place when inserting the battery.
- Reconnect the power supply to the B&R Industrial PC (plug in the power cable).
- Reset the date and time in BIOS.

Warning!

Lithium batteries are considered hazardous waste. Used batteries should be disposed of in accordance with applicable local regulations.

2 Cleaning

Danger!

This device can only be cleaned when switched off in order to prevent unintended functions from being triggered when handling the touch screen or pressing keys.

This device should be cleaned with a moist cloth. The cloth should be moistened with water and detergent, a screen cleaning agent or alcohol (ethanol). The cleaning agent should be applied to the cloth beforehand, not sprayed directly on the device! Aggressive solvents, chemicals, scouring agents, pressurized air or steam jets should never be used.

Information:

Displays with a touch screen should be cleaned regularly.

3 Replacing a CompactFlash card

Caution!

Power must be turned off before replacing CompactFlash cards.

The CompactFlash card can be replaced quickly and easily by pressing the ejector (see image) with a pointed object such as a pen.

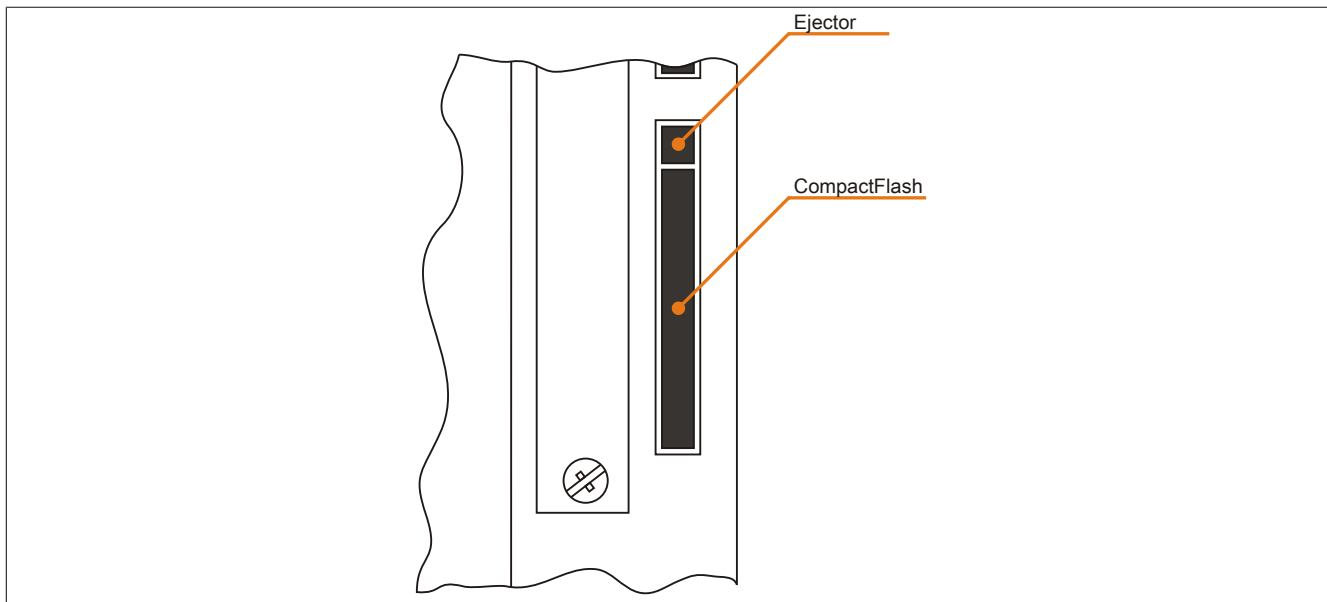

Figure 195: CompactFlash + ejector

4 Installing and replacing slide-in compact drives

Information:

The SATA I interface allows disks to be replaced during operation (hot plugging). In order to take advantage of this capability, this feature must be supported by the operating system.

4.1 Procedure

1. Loosen and remove the two quick release screws on the protective cover / slide-in compact drive.



Figure 196: Loosening the quick release screws

2. Insert the compact SATA drive and tighten the quick release screws.



Figure 197: Inserting the compact SATA drive

5 Installing and replacing slide-in drives

Slide-in drives can be installed and replaced in system units with 1 card slot or in expansions with 2 card slots.

5.1 Procedure

1. Disconnect the power supply to the B&R Industrial PC.
2. Touch the housing or ground connection in order to discharge any electrostatic charge from your body.
3. Remove the dummy slide-in module or slide-in drive by unscrewing the two quick release screws.



Figure 198: Loosening the quick release screws

4. Insert the slide-in drive and tighten with the two ¼ turn screws.



Figure 199: Installing the slide-in drive

6 Installing the slide-in compact adapter

Slide-in compact adapters can be installed and replaced in system units with 1 card slot or in expansions with 2 card slots. A slide-in compact drive (e.g. slide-in compact HDD) can be installed in a slide-in slot using the slide-in compact adapter.

6.1 Procedure

1. Disconnect the power supply to the B&R Industrial PC.
2. Touch the housing or ground connection in order to discharge any electrostatic charge from your body.
3. Remove the dummy slide-in module or slide-in drive by unscrewing the two quick release screws.



Figure 200: Loosening the quick release screws

4. Insert the slide-in compact adapter and tighten the two quick release screws.

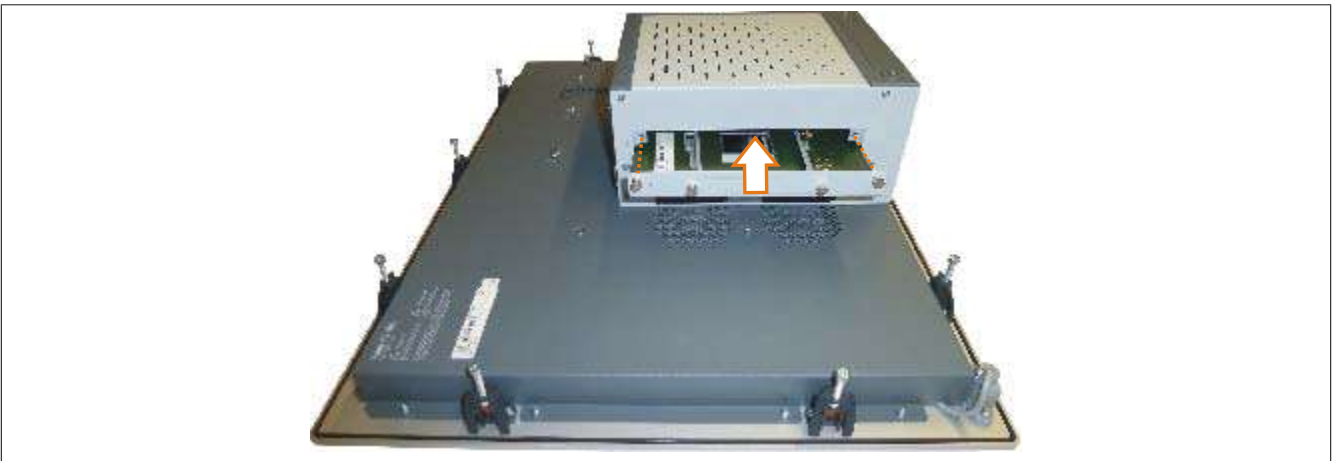

Figure 201: Installing the slide-in compact adapter

5. Once the adapter has been installed, the slide-in compact drive can be inserted.



Figure 202: Inserting the slide-in compact drive

7 Installing and replacing fan kits

Information:

The following section illustrates a characteristic example of a PPC800 model without expansion. The only difference in this procedure compared to models with an expansion is the number of combi-Torx screws to loosen.

7.1 Procedure

1. Loosen the indicated combi-Torx screws (T10) and remove the fan kit cover.

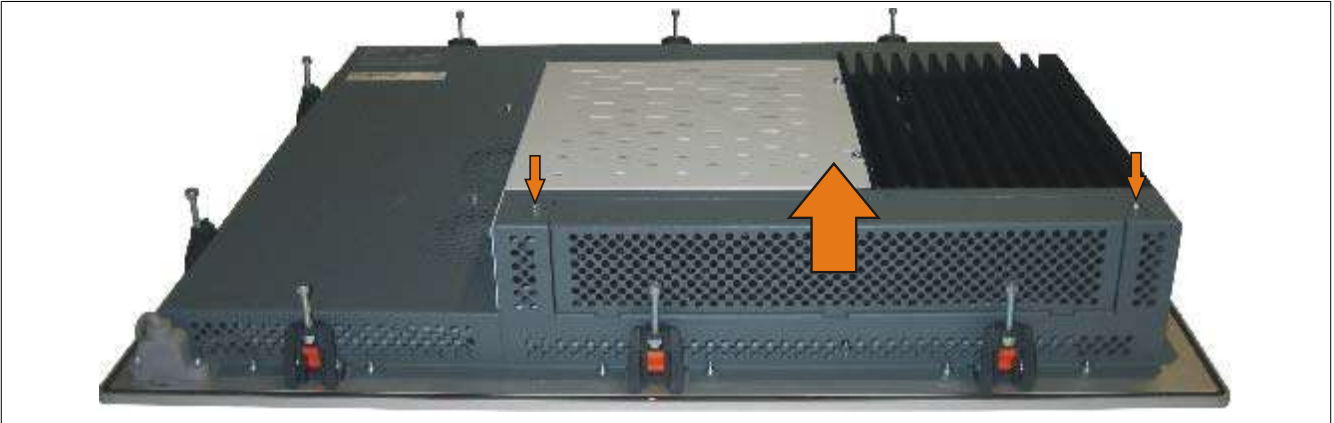

Figure 203: Removing the fan kit cover

2. Insert the fan kit frame and press down until it is fully fastened into the terminal.

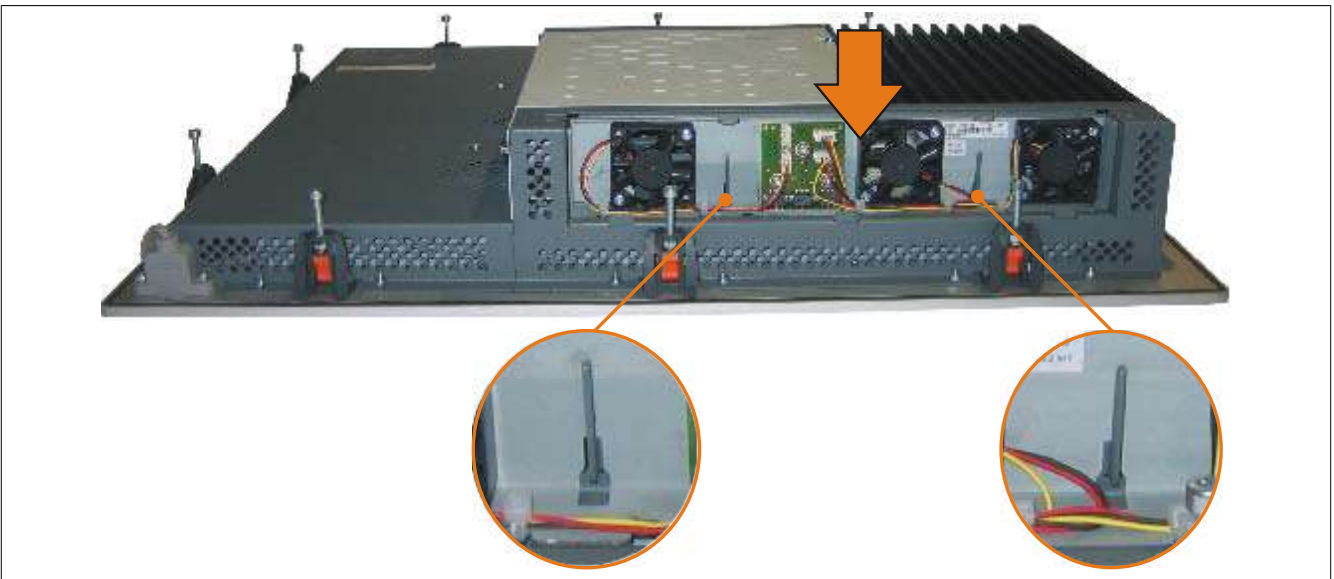

Figure 204: Inserting the fan kit

3. Place the dust filter in the fan kit cover and secure it with the filter clasp.

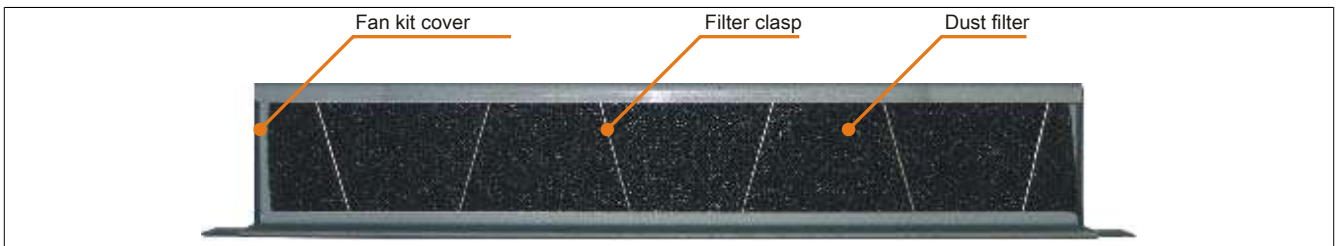

Figure 205: Securing the dust filter with the filter clasp

4. Place the fan kit cover in the housing and fasten using the Torx screws removed earlier.

Information:

The dust filter should be checked regularly depending on the area of use and degree of contamination.

8 Installing the UPS module

This module is installed using the materials included in delivery.

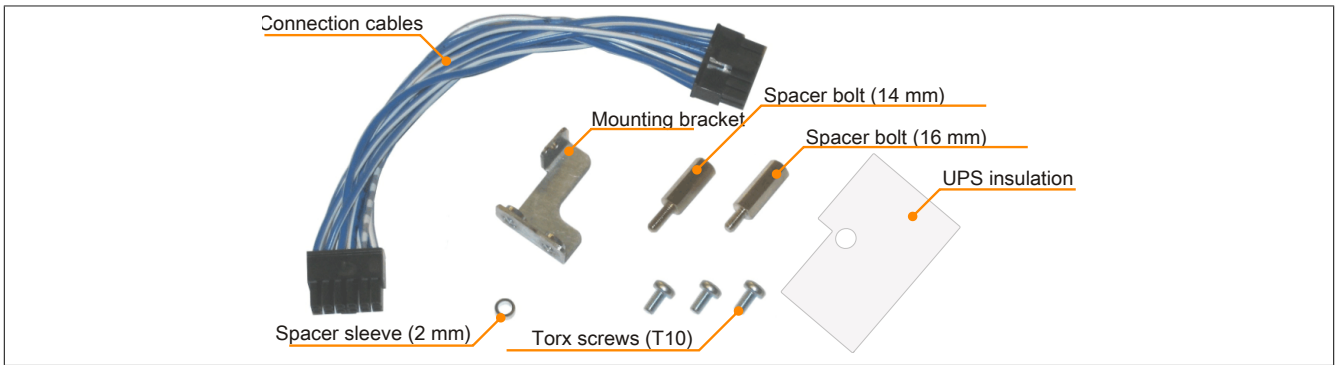

Figure 206: 5AC600.UPI-00 Add-on UPS module - Installation materials

8.1 Installation guidelines

1. Remove the side cover (see "Installing the side cover" on page 359).
2. Remove the UPS module cover by removing the 2 marked Torx screws (T10).

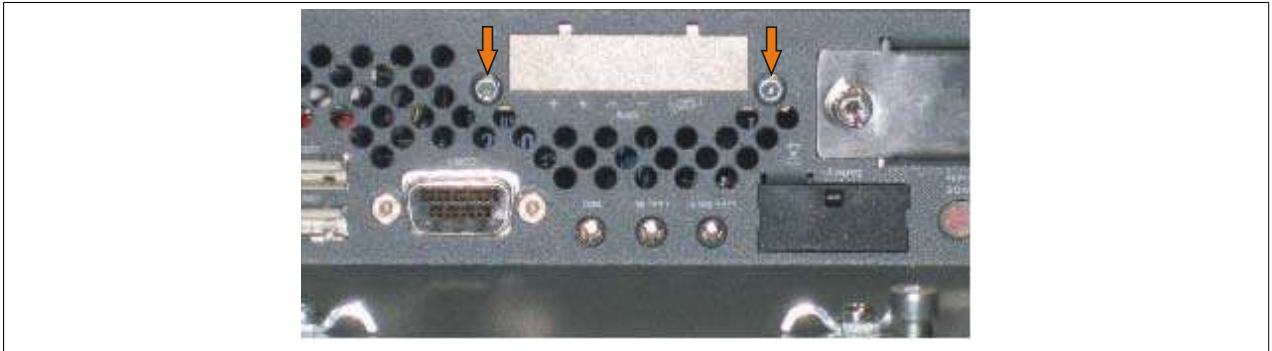

Figure 207: Removing the UPS module cover

3. Attach the UPS isolation to the bottom/rear of the UPS module and install both using 2 Torx screws (T10) on the housing and 1 Torx screw (T10) on the mainboard (spacer bolt). Use the previously removed Torx screws and the Torx screws from the installation material.

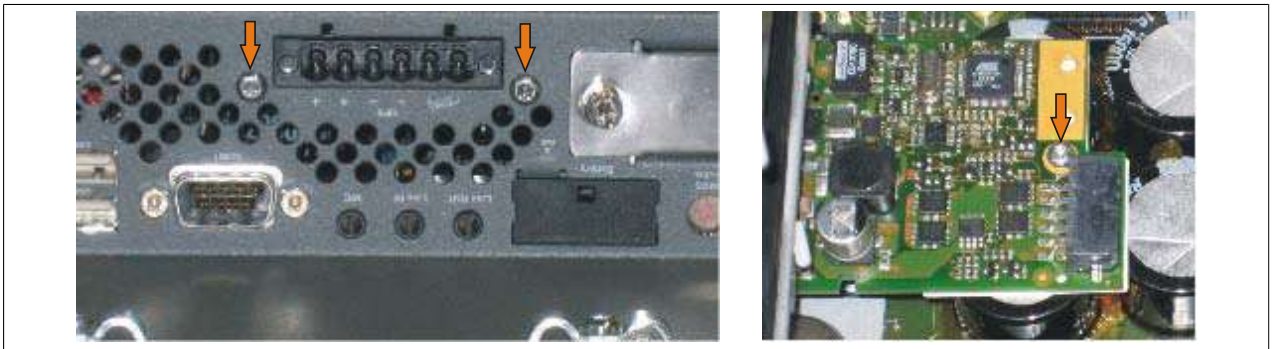

Figure 208: Installing the UPS module

4. Attach the connection cable (see marked female connector).

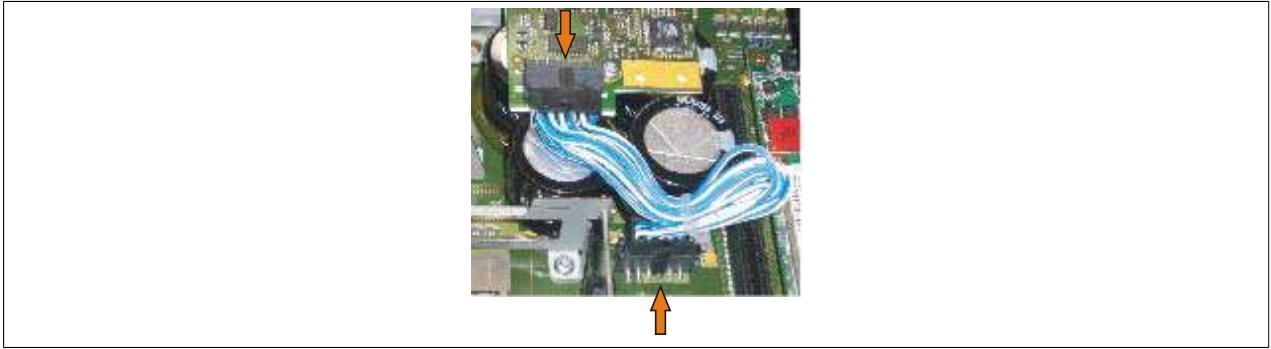

Figure 209: Attaching the connection cable

Information:

When connecting the cable, make sure that the connector locks into place.

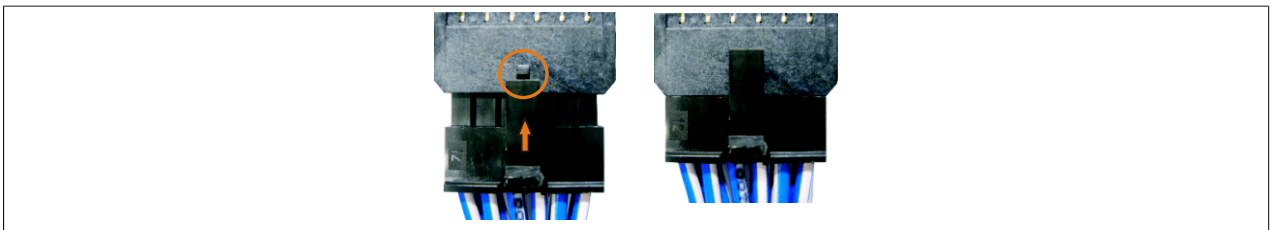

Figure 210: Connector locking mechanism

5. Attach the side cover.

9 Installing the UPS fuse kit on the battery unit

Information:

The 5AC600.UPSF-00 UPS fuse kit is only needed for battery units up to and including revision D0. A 25 A fuse is integrated on the connector circuit board beginning with revision E0.

9.1 Procedure

1. Power to the 5AC600.UPSB-00 battery unit must be disconnected by unplugging the UPS connection cable from the B&R Industrial PC.
2. Remove the cover on the battery unit. This is done by unscrewing the two Torx screws (T10) so that the cover can be removed by sliding it towards the orange connector.



Figure 211: Removing the cover for the battery unit

3. To install the fuse, the red cable must be disconnected from the battery circuit board.



Figure 212: Disconnecting the cable

4. The male fuse kit connector must be connected to the female connector on the red cable (1). The female fuse kit connector must be connected to the male connector on the battery circuit board (2).

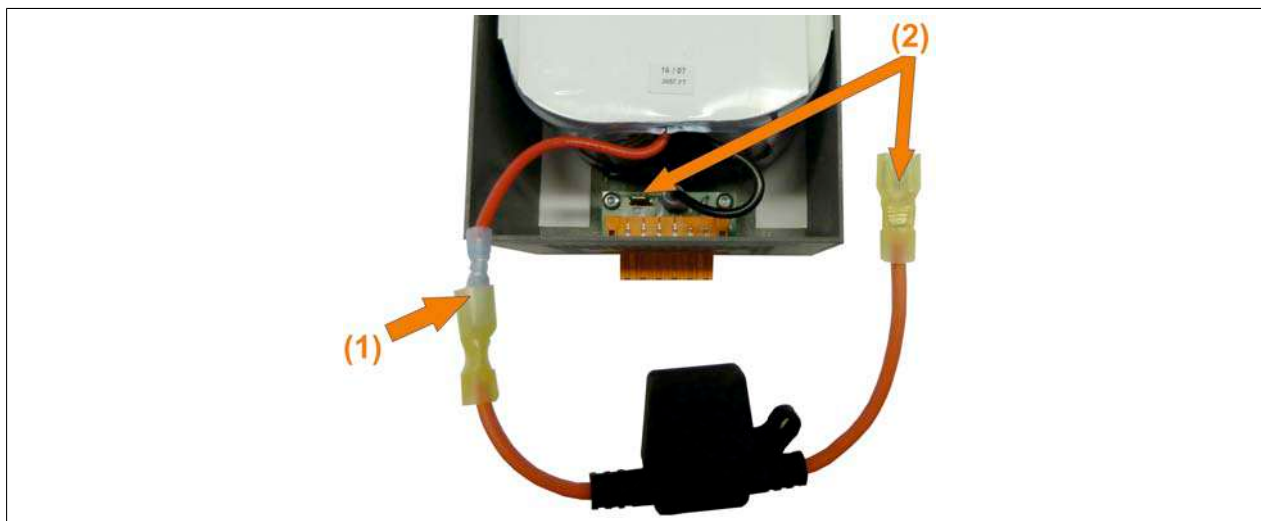

Figure 213: Connecting the fuse

5. The fuse can then be secured in the battery unit.



Figure 214: Securing the fuse

6. The cover for the battery unit can now be reattached. Insert the clips on the cover into the notch on the battery unit and tighten down the cover with the Torx screws removed previously.
7. Reconnect the 5AC600. UPSB-00 battery unit to the B&R Industrial PC.

10 Installing and replacing bus units

Bus units can be installed and replaced in system units with 1 card slot or in expansions with 2 card slots.

10.1 Procedure

1. Disconnect the power supply to the Panel PC 800.
2. Touch the housing or ground connection in order to discharge any electrostatic charge from your body.
3. Remove the side cover (see "Installing the side cover" on page 359).
4. Loosen the Torx screws (T10) mounted to the mainboard.



Figure 215: Removing the screws

5. Plug the bus unit into the bus unit slot and fasten it using three Torx screws (T10).

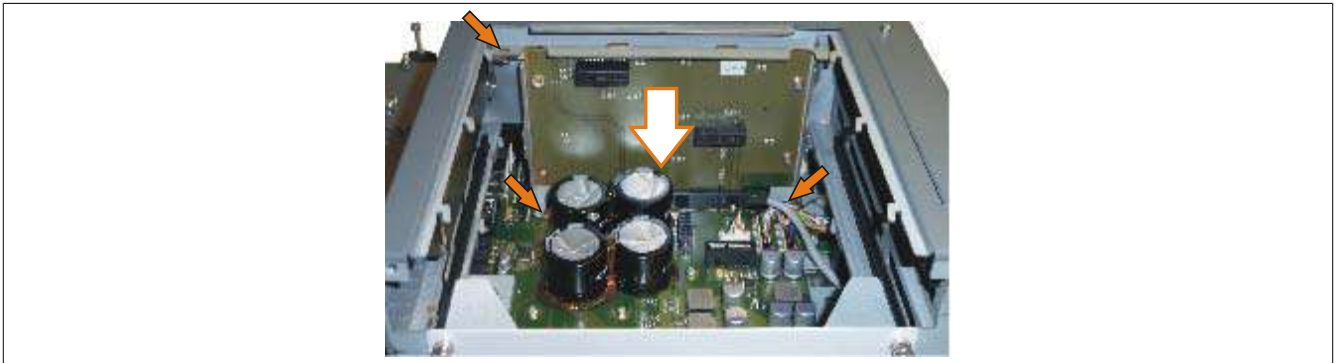

Figure 216: Installing the bus unit

6. Attach the side cover.

11 Installing and replacing adapters

1. Remove the side cover (see "Installing the side cover" on page 359).
2. Remove the 1 card slot or the 2 card slot expansion.

11.1 Procedure for the 5AC803.BC01-00 adapter

1. Loosen the Torx screws (T10) mounted to the mainboard.



Figure 217: Removing the screws

2. Place the adapter and guide rails in the intended positions and fasten them using the Torx screws (T10) removed earlier.

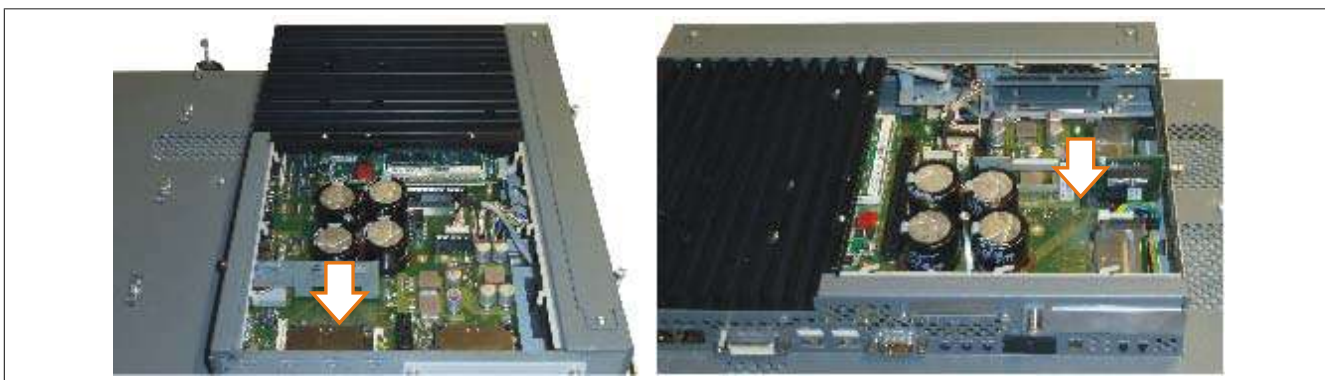

Figure 218: Installing the 5AC803.BC01-00 adapter

3. Attach the side cover.

11.2 Procedure for the 5AC803.BC02-00 adapter

1. Insert the adapter into the intended slot.



Figure 219: Installing the 5AC803.BC02-00 adapter

2. Attach the side cover.

12 Installing and replacing PCIe plug-in cards

12.1 Procedure

1. Loosen the quick release screws and remove the PCIe module cover.



Figure 220: Removing the PCIe module cover

2. Slide the PCIe plug-in card into place.

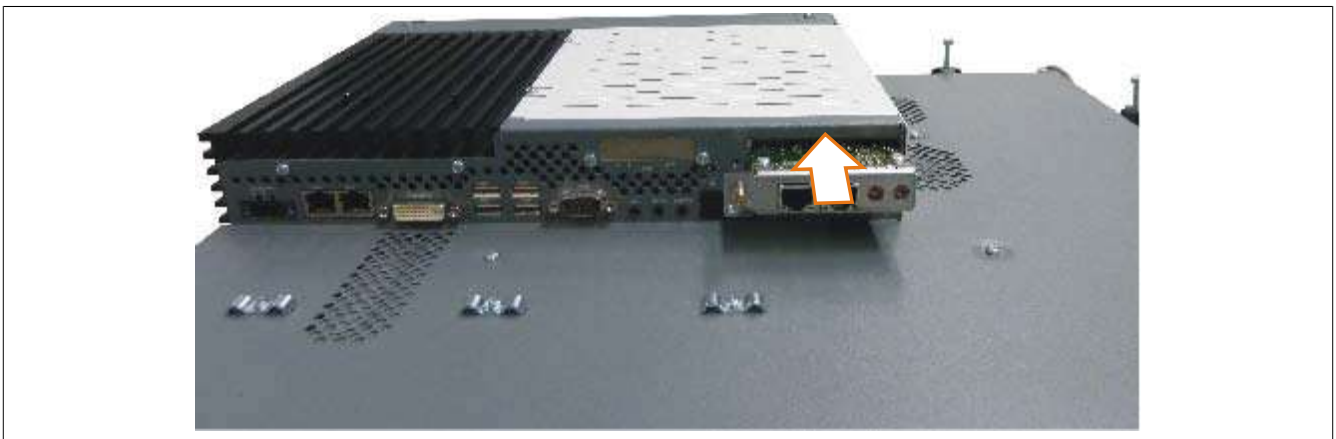

Figure 221: Inserting the PCIe plug-in card

3. Fasten the PCIe plug-in card using the quick release screws.

13 Installing the side cover

The side cover can be easily removed by loosening the Torx (T10) screws. The number of Torx screws can vary depending on the system.

13.1 PPC800 without expansion

1. Disconnect the power supply to the Panel PC 800.
2. Touch the housing or ground connection in order to discharge any electrostatic charge from your body.
3. Loosen the indicated combi-Torx screws (T10).
4. After the screws have been removed, the side cover can be removed by sliding it away from the heat sink.

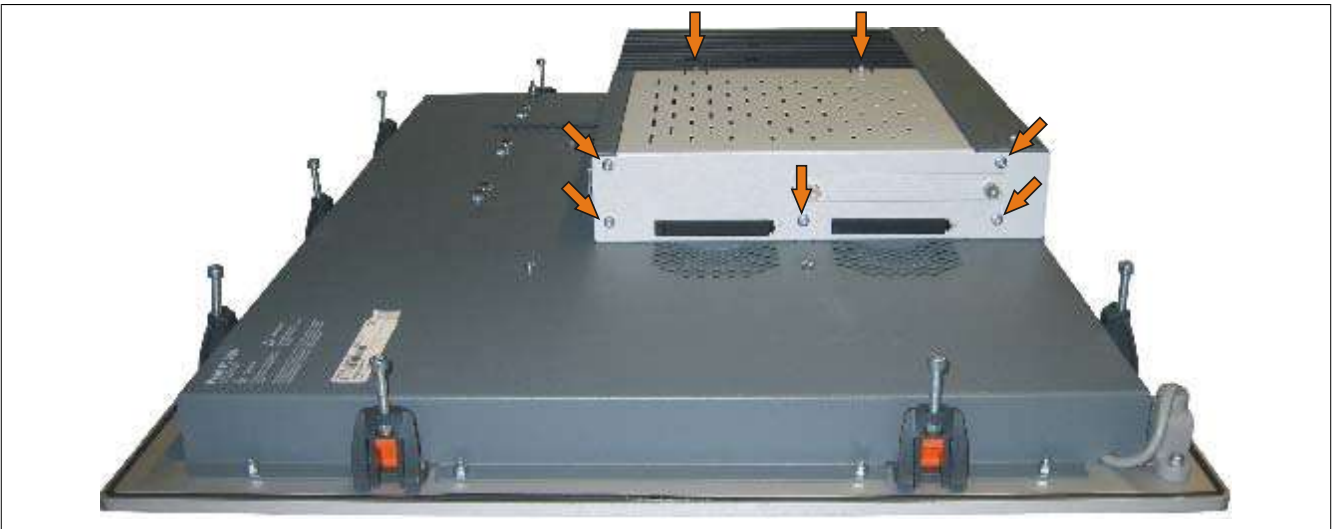

Figure 222: Installing the side cover on a PPC800 without an expansion

13.2 PPC800 with an expansion

1. Disconnect the power supply to the Panel PC 800.
2. Touch the housing or ground connection in order to discharge any electrostatic charge from your body.
3. Loosen the indicated combi-Torx screws (T10).
4. After the screws have been removed, the side cover can be removed by sliding it away from the heat sink.

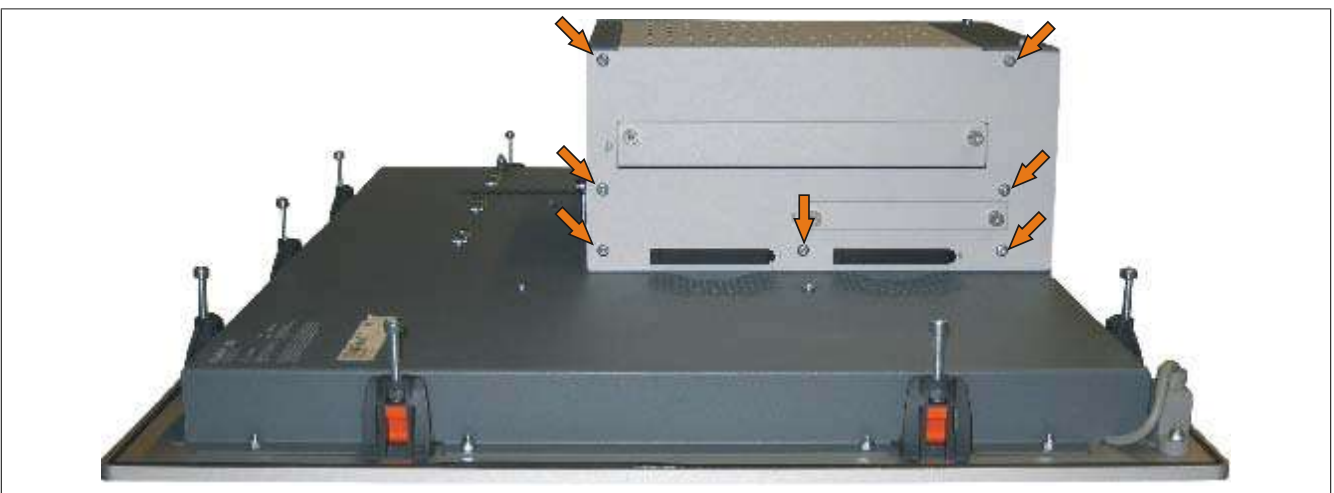

Figure 223: Installing the side cover on a PPC800 with an expansion (1-slot expansion shown in image)

14 Replacing a PCI SATA RAID hard disk in a RAID 1 set

This example assumes that the secondary hard disk (HDD1) is defective in a RAID 1 configuration. In such a case, the defective hard disk can be replaced by the replacement drive SATA hard disk.

Model number of PCI SATA RAID controller	Model number of required replacement SATA HDD	Note
5ACPCI.RAIC-01	5ACPCI.RAIC-02	60 GB hard disk
5ACPCI.RAIC-03	5ACPCI.RAIC-04	160 GB hard disk
5ACPCI.RAIC-05	5MMHDD.0250-00	250 GB hard disk
5ACPCI.RAIC-06	5MMHDD.0500-00	500 GB hard disk

Table 269: Overview of required replacement SATA HDD for PCI SATA HDD RAID controller

A size 10 Torx screwdriver is needed to replace the hard disk.

14.1 Procedure

1. Disconnect the power supply.
2. Touch the housing or ground connection in order to discharge any electrostatic charge from your body.
3. Remove the side cover.
4. Remove the SATA RAID insert.
5. Loosen the 4 appropriate fastening screws (M3x5).

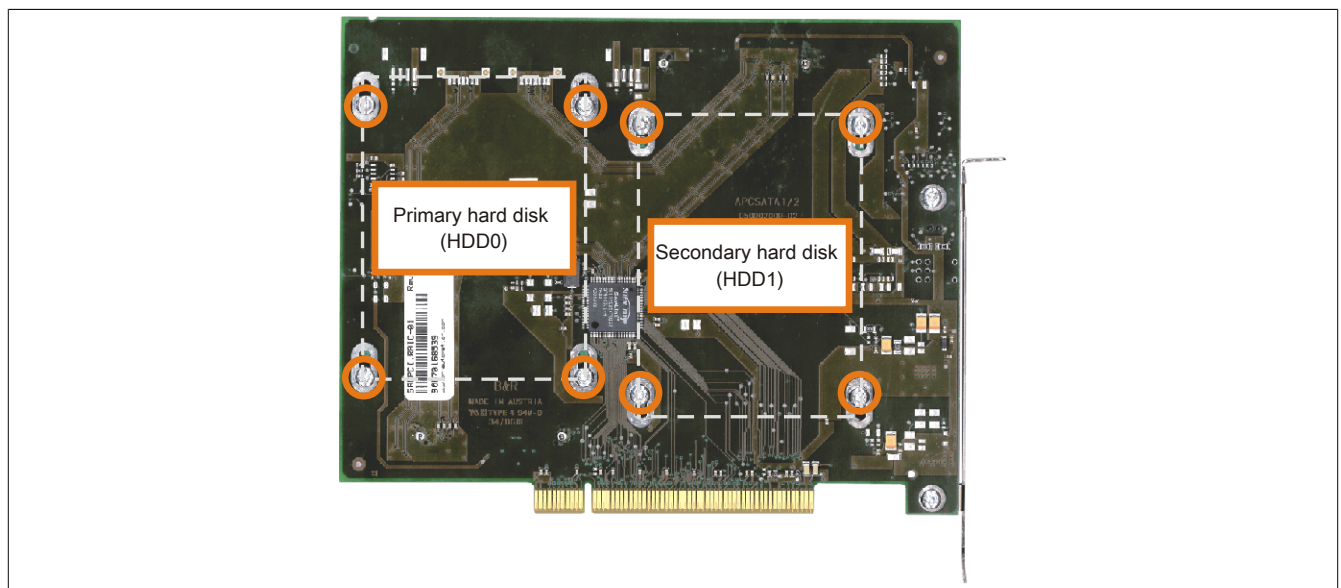

Figure 224: Screw layout on the back side of the 5ACPCI.RAIC-03 SATA RAID controller

6. On the front side, slide the hard disk down and away (Replacing the hard disk - left image).
7. Insert the new hard disk carefully into the connector (Replacing the hard disk - right image), being careful to only touch it on the front, not on the top.

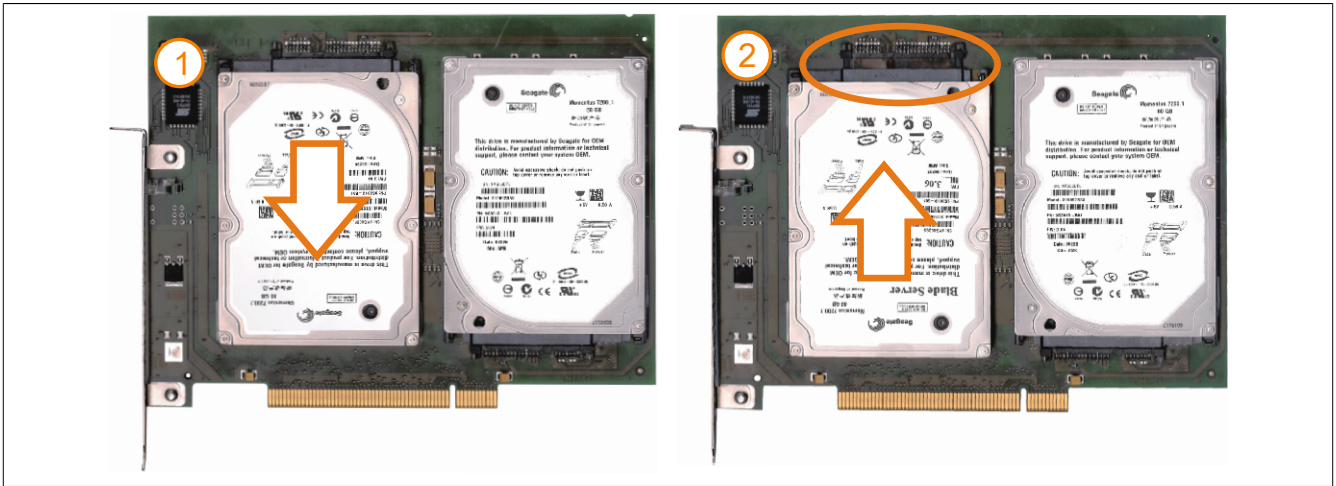

Figure 225: Replacing the hard disk

8. Re-secure the hard disk using the 4 fastening screws (M3x5) used earlier.
9. Reassemble the device in the reverse order.
10. An error message is output by the RAID BIOS after starting the system: "RAID1 set is in Rebuild status. The rebuild will continue after boot sequence is complete".
11. A rebuild can be performed immediately in SATA RAID BIOS or once the PC has booted - see "Rebuild mirrored set" on page 179.

Appendix A

1 Maintenance Controller Extended (MTCX)

The MTCX controller (FPGA processor) is located on the mainboard (part of every system unit).

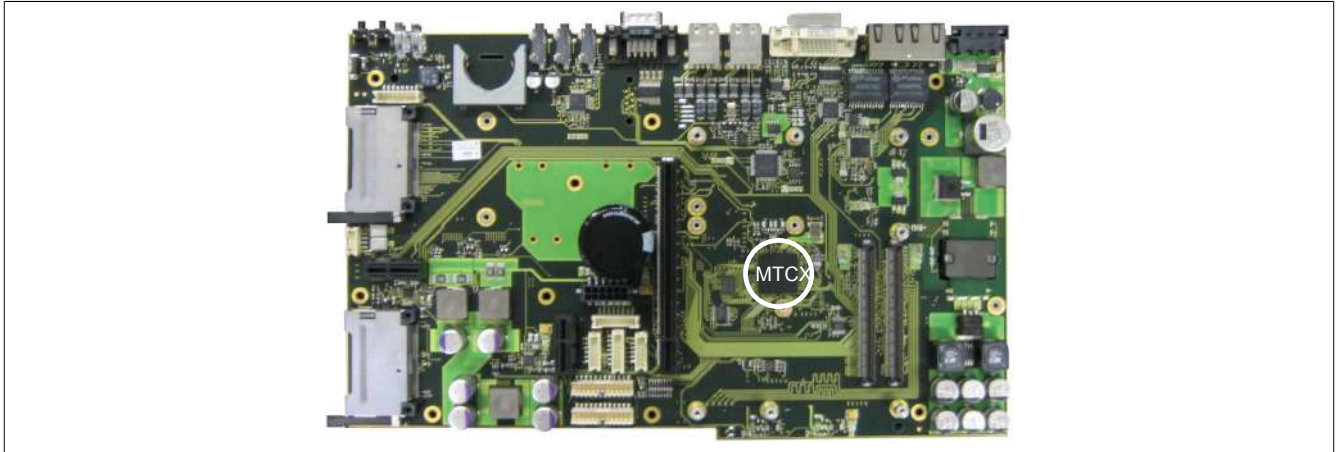

Figure 226: MTCX controller location

The MTCX is responsible for the following monitoring and control functions:

- Power on (power OK sequencing) and power failure logic
- Watchdog handling (NMI and reset handling)
- Temperature monitoring
- Fan control
- Key handling / coordination (matrix keyboard on Automation Panel 900 devices configurable using B&R Key Editor, PS/2 keyboard)
- LED handling (matrix keyboard with LEDs on Automation Panel 900 devices configurable using B&R Key Editor)
- Advanced desktop operation (USB forwarding)
- Daisy chain display operation (touch screen, USB forwarding)
- Panel locking mechanism (can be configured using B&R Control Center - ADI driver)
- Backlight control for connected B&R displays
- Statistical data recording (power cycles - records every switch-on, power on and fan hour; each full hour is counted, i.e. not increased at 50 minutes)
- SDL data transfer (display, matrix keyboard, touch screen, service data, USB)
- LED status indicators (HDD, Link, Run)

Extended MTCX functions are available by upgrading firmware ¹⁾. The version can be read in BIOS ("Advanced" - Baseboard/Panel Features) or in approved Microsoft Windows operating systems with the B&R Control Center.

1.1 Temperature monitoring - Fan control

The MTCX constantly monitors the temperature using temperature sensors, which directly determines how the fans are controlled. The speed depends on the measured temperature. The limit values depend on the MTCX firmware version being used.

¹⁾ Available in the Downloads section of the B&R website (www.br-automation.com).

Sensor range	Startup temperature	Max fan speed at:
Board I/O	60°C	76°C
Board ETH2	60°C	76°C
Board power	60°C	76°C
Power supply	60°C	76°C
Slide-in drive 1	44°C	60°C
IF slot	65°C	81°C

Table 270: Temperature limits of the fan (MTCX PX32 V1.01)

Once the startup temperature is reached, the device is started at the minimum fan speed. The maximum fan speed is reached at a startup temperature of 16°C. The fan speed in this area is controlled depending on the temperature.

For example, slide-in 1: $44^{\circ}\text{C} + 16^{\circ}\text{C} = 60^{\circ}\text{C}$ --> Maximum fan speed

The fans will only be shut off again if the evaluation temperature is more than 6°C below the switch-on temperature for a period of 30 minutes (=overshoot time).

2 Connecting an external device to the mainboard

A male connector on the mainboard allows +5 VDC and +12 VDC to be rerouted in order to provide power to special PCI cards, for example.

This voltage can be accessed using the "5CAMSC.0001-00" on page 340. The connector is located near the reset or power button (see image). In order to reach the connector, the side cover (see "Installing the side cover" on page 359) of the PPC800 as well as any slide-in drives and PCIe and PCI plug-in cards must be removed.



Figure 227: Connector location for external devices

Connector for external devices			
Pin	Assignment	Power	4-pin connector, male 
1	+12 VDC	Max. 10 watts	
2	GND		
3	GND	Max. 5 watts	
4	+5 VDC		

Table 271: Connector on the mainboard - Pinout

Connections are protected with a 1 A multi-fuse.

3 5-wire AMT touch screen

3.1 Technical data

Information:

The following characteristics, features and limit values only apply to this individual component and can deviate from those specified for the complete system. For the complete system in which this individual component is used, refer to the data given specifically for that device.

Product ID	5-wire AMT touch screen	
General information		
Certification		
CE		Yes
c-UL-us		Yes
Manufacturer		AMT
Release pressure		< 1 N
Light permeability		81 ±3%
Environmental conditions		
Temperature		
Operation		- 20 to 70°C
Storage		- 40 to 80°C
Transport		- 40 to 80°C
Relative humidity		
Operation		90% at max. 50°C
Storage		90% RH at max. 60°C for 504 hours
Transport		90% RH at max. 60°C for 504 hours
Operating conditions		
Service life	36 million touch operations at the same position (release pressure: 250 g, interval: 2x per second)	
Chemical resistance ¹⁾	Acetone, methylene chloride, methyl ethyl ketone, isopropyl alcohol, hexane, turpentine, mineral spirits, unleaded gasoline, diesel, motor oil, gear lubricating oil, antifreeze, ammonia-based glass cleaner, chemical cleaning agents, household cleaning agents, vinegar, coffee, tea, lubricant, cooking oil, salt	
Enabling driver	Finger, pointer, credit card, glove	
	Touch screen drivers for approved operating systems are available in the Downloads section of the B&R website (www.br-automation.com).	

Table 272: 5-wire AMT touch screen - Technical data

- 1) The active area of the touch screen is resistant to these chemicals for a period of one hour at 25°C.

3.2 Temperature/Humidity diagram

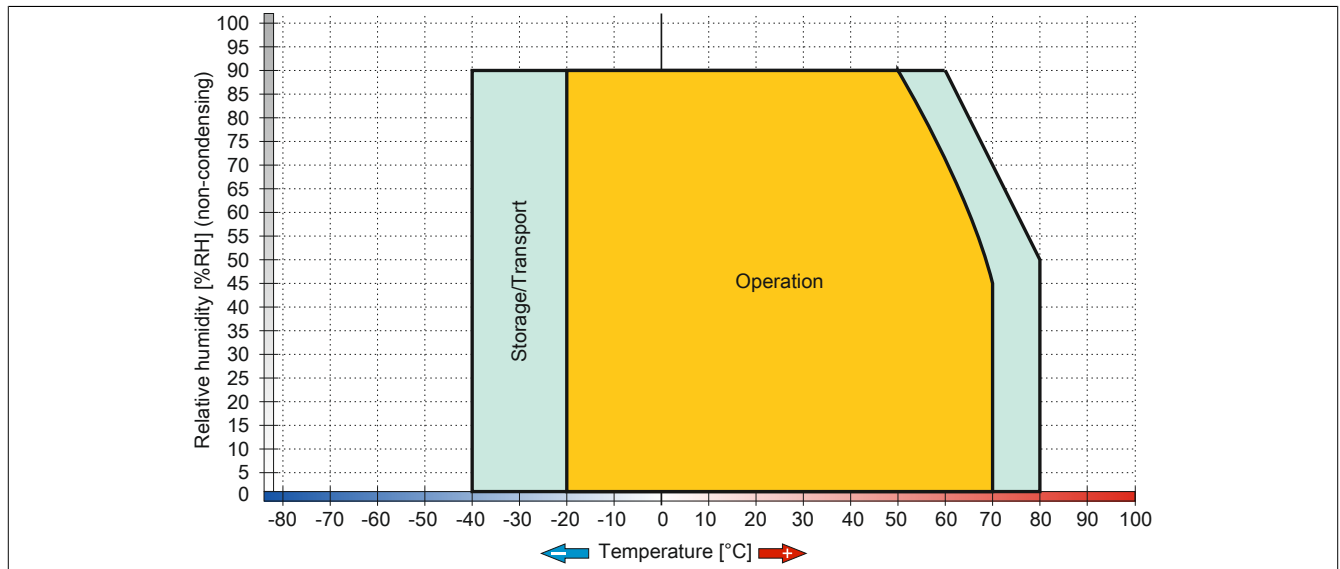

Figure 228: 5-wire AMT touch screen - Temperature/Humidity diagram

3.3 Cleaning

Danger!

This device can only be cleaned when switched off in order to prevent unintended functions from being triggered when handling the touch screen or pressing keys.

This device should be cleaned with a moist cloth. The cloth should be moistened with water and detergent, a screen cleaning agent or alcohol (ethanol). The cleaning agent should be applied to the cloth beforehand, not sprayed directly on the device! Aggressive solvents, chemicals, scouring agents, pressurized air or steam jets should never be used.

Information:

Displays with a touch screen should be cleaned regularly.

4 Panel overlay

The panel overlay conforms to DIN 42115 (Part 2). This means it is resistant to exposure to the following chemicals for a 24-hour period with no visible signs of damage:

Information:

The following characteristics, features and limit values only apply to this individual component and can deviate from those specified for the complete system.

Ethanol Cyclohexanol Diacetone alcohol Glycol Isopropanol Glycerine Methanol Triacetin Dowandol DRM/PM	Formaldehyde 37 to 42% Acetaldehyde Aliphatic hydrocarbons Toluene Xylene White spirits	Trichloroethane Ethyl acetate Diethyl ether N-Butyl acetate Amyl acetate Butylcellosolve Ether
Acetone Methyl ethyl ketone Dioxan Cyclohexanone MIBK Isophorone	Formic acid < 50% Acetic acid < 50% Phosphoric acid < 30% Hydrochloric acid < 36% Nitric acid < 10% Trichloroacetic acid < 50% Sulphuric acid < 10%	Sodium hypochlorite < 20% Hydrogen peroxide < 25% Potassium carbonate Washing agents Tenside Fabric conditioner Ferrous chloride (FeCl ₂) Ferrous chloride (FeCl ₃) Dibutyl phthalate Dioctyl phthalate Sodium carbonate
Ammonia < 40% Caustic soda < 40% Potassium hydroxide Alkali carbonate Bichromate Potassium Acetonitrile Sodium bisulphate	Cutting oil Diesel oil Linseed oil Paraffin oil Blown castor oil Silicon oil Turpentine oil substitute Brake fluid Aviation fuel Gasoline Water Sea water Decon	

Table 273: Chemical resistance of the panel overlay

The panel overlay conforms to DIN 42115 section 2 for exposure to glacial acetic acid for less than one hour without visible damage.

5 Viewing angles

Viewing angle specifications (R, L, U, D) for the display types are listed in the technical data for each device.

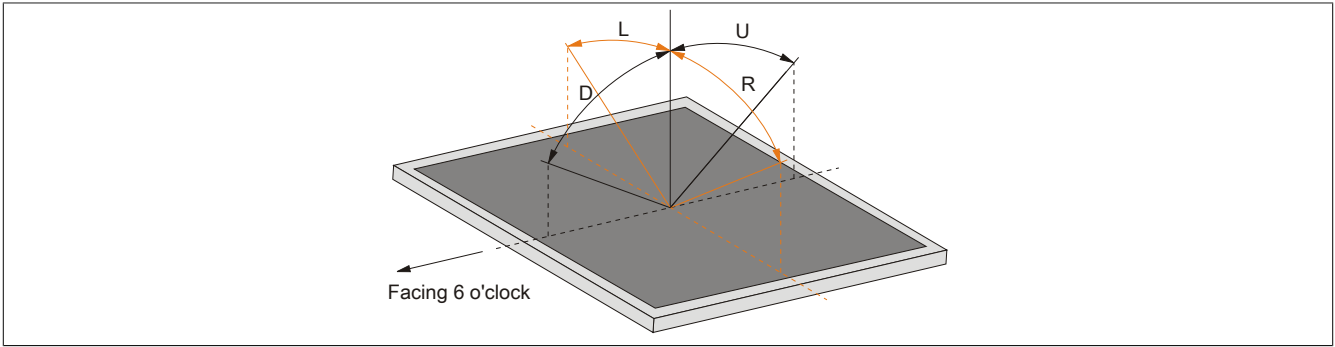

6 Mounting compatibility

This section describes the compatibility of the installation dimensions for Power Panel 100/200, Power Panel 300/400, Power Panel 500, Automation Panel 900, Automation Panel 700 and Panel PC 800 devices according to device display size.

The outer dimensions of the device types are identical for the respective display sizes.

The different device types are abbreviated as follows:

Device type	Abbreviation
Power Panel 100/200	PP100/200
Power Panel 300/400	PP300/400
Power Panel 500	PP500
Automation Panel 900	AP900
Panel PC 700	PPC700
Panel PC 800	PPC800

Table 274: Product abbreviations

6.1 Compatibility overview

The following table provides an overview of PP100/200, PP300/400, PP500, AP900, PPC700 and PPC800 devices. Detailed information can be found in the section 6.2 "Compatibility details" on page 370.

Compatibility between device types is represented on each line by matching symbols.

Size	Format	Compatible	PP100/200	PP300/400	PP500	AP900	PPC700	PPC800
5.7"	Horizontal1	Outer dimensions	■	■	■	-	-	-
		Installation dimensions	●	●	●	-	-	-
	Horizontal2	Outer dimensions	■	■	■	-	-	-
		Installation dimensions	●	●	●	-	-	-
	Vertical1	Outer dimensions	■	■	■	-	-	-
		Installation dimensions	●	●	▲	-	-	-
10.4"	Horizontal 1	Outer dimensions	■	■	■	■	■	-
		Installation dimensions	●	●	●	●	●	-
	Horizontal2	Outer dimensions	■	■	■	■	■	-
		Installation dimensions	●	●	▲	▲	▲	-
	Vertical1	Outer dimensions	■	■	■	■	■	-
		Installation dimensions	●	●	▲	▲	▲	-
12.1"	Horizontal1	Outer dimensions	■	■	■	■	■	-
		Installation dimensions	●	●	▲	▲	▲	-
15"	Horizontal1	Outer dimensions	■	■	■	■	■	■
		Installation dimensions	●	●	▲	●	●	●
	Vertical1	Outer dimensions	■	■	■	■	■	-
		Installation dimensions	●	●	▲	●	●	-
17"	Horizontal 1	Outer dimensions	-	-	-	■	■	-
		Installation dimensions	-	-	-	▲	▲	-
19"	Horizontal 1	Outer dimensions	-	-	-	■	■	-
		Installation dimensions	-	-	-	▲	-	-
21.3"	Horizontal 1	Outer dimensions	-	-	-	■	-	-
		Installation dimensions	-	-	-	▲	-	-

Table 275: Overview of device compatibility

6.2 Compatibility details

6.2.1 Example

The dimensions (all in mm) shown in this image apply to the other figures below.

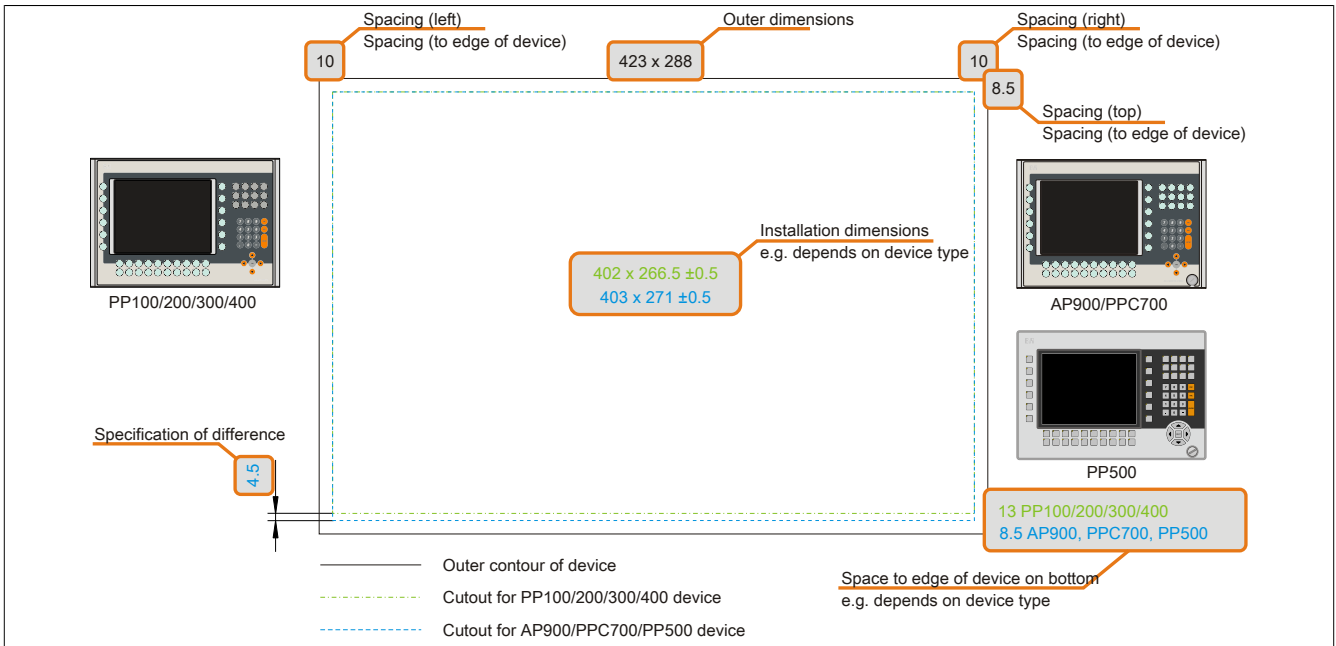

Figure 229: Overview of compatibility figures

6.2.2 5.7" devices

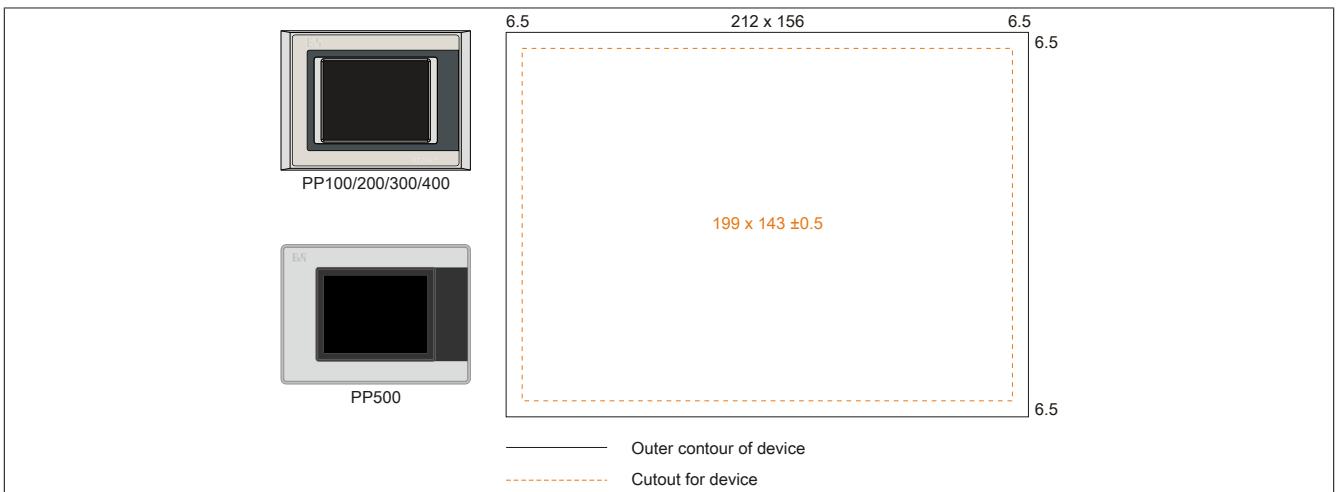

Figure 230: Mounting compatibility - 5.7" device - Horizontal1

5.7" Power Panel 500 devices and Power Panel 100/200/300/400 devices are 100% mounting compatible in the Horizontal1 format.

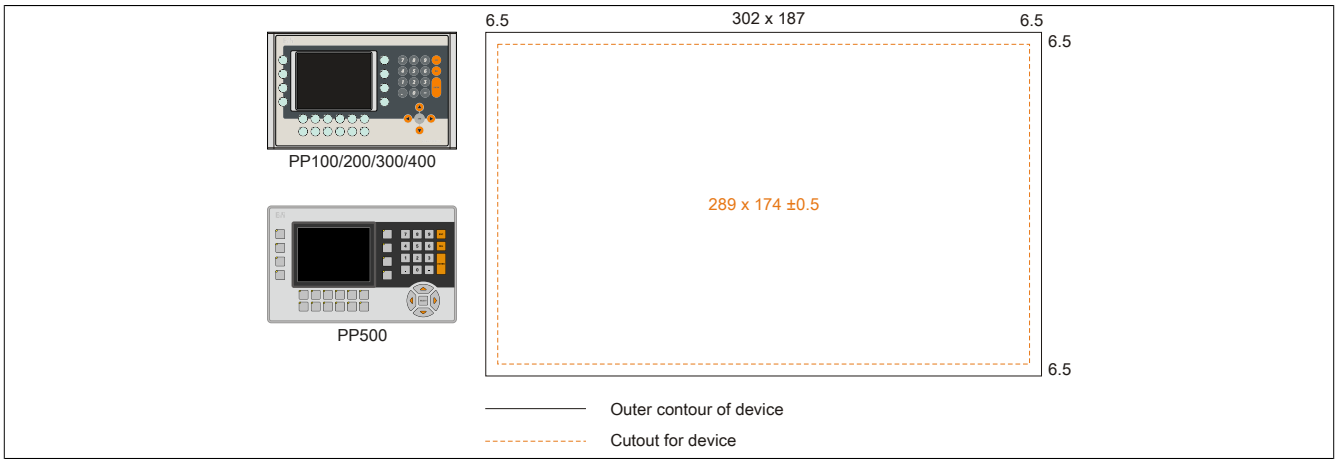

Figure 231: Mounting compatibility - 5.7" device - Horizontal2

5.7" Power Panel 500 devices and Power Panel 100/200/300/400 devices are 100% mounting compatible in the Horizontal2 format.

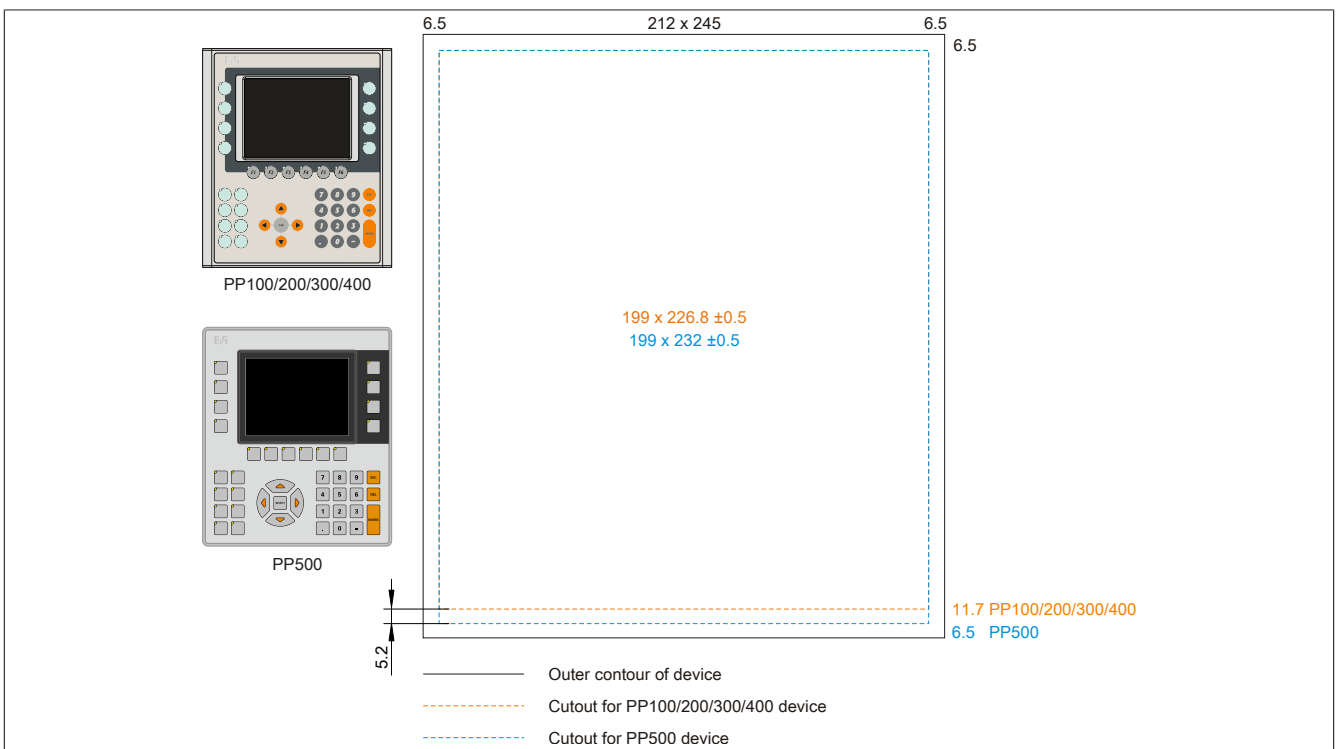

Figure 232: Mounting compatibility - 5.7" device - Vertical1

5.7" Power Panel 500 devices are not 100% mounting compatible with Power Panel 100/200/300/400 devices in the Vertical1 format. Power Panel 500 devices require a cutout that is 5.2 mm higher (bottom edge).

The larger cutout can be used for all devices under certain conditions:

- When mounting, make sure that the PP100/200/300/400 devices are placed and mounted as close to the center of the cutout as possible. Failure to do so can prevent the retaining clips from holding firmly, which means that a firm seal is no longer guaranteed with the gasket (IP65).

6.2.3 10.4" devices

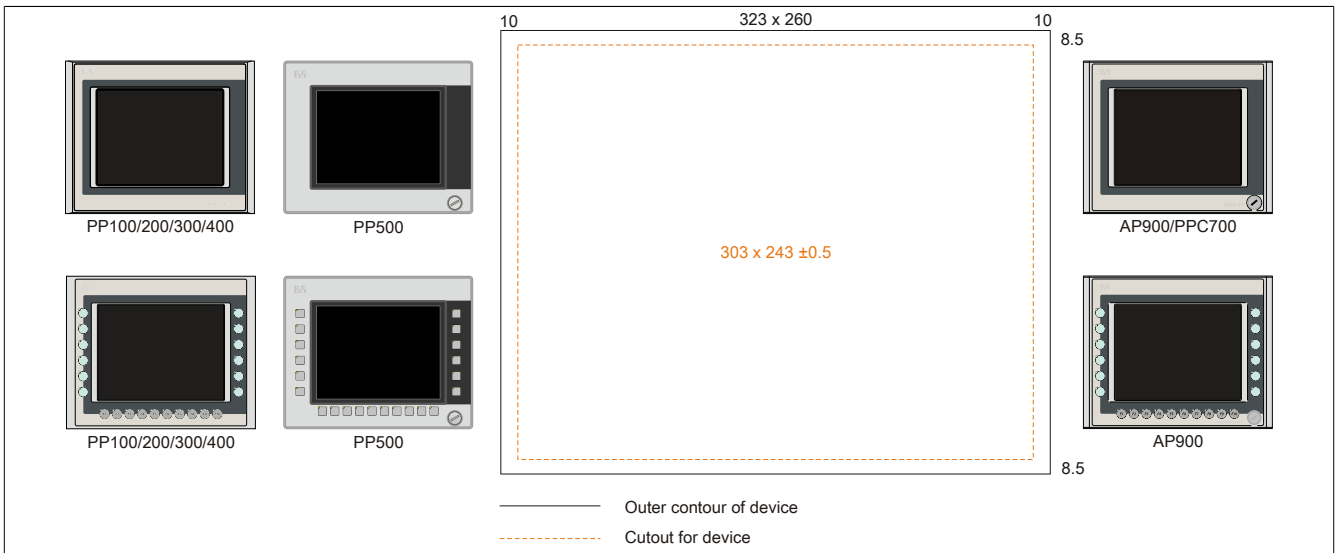

Figure 233: Mounting compatibility - 10.4" device - Horizontal1

10.4" Power Panel 500 devices and Power Panel 100/200/300/400 devices are 100% mounting compatible in the Horizontal1 format.

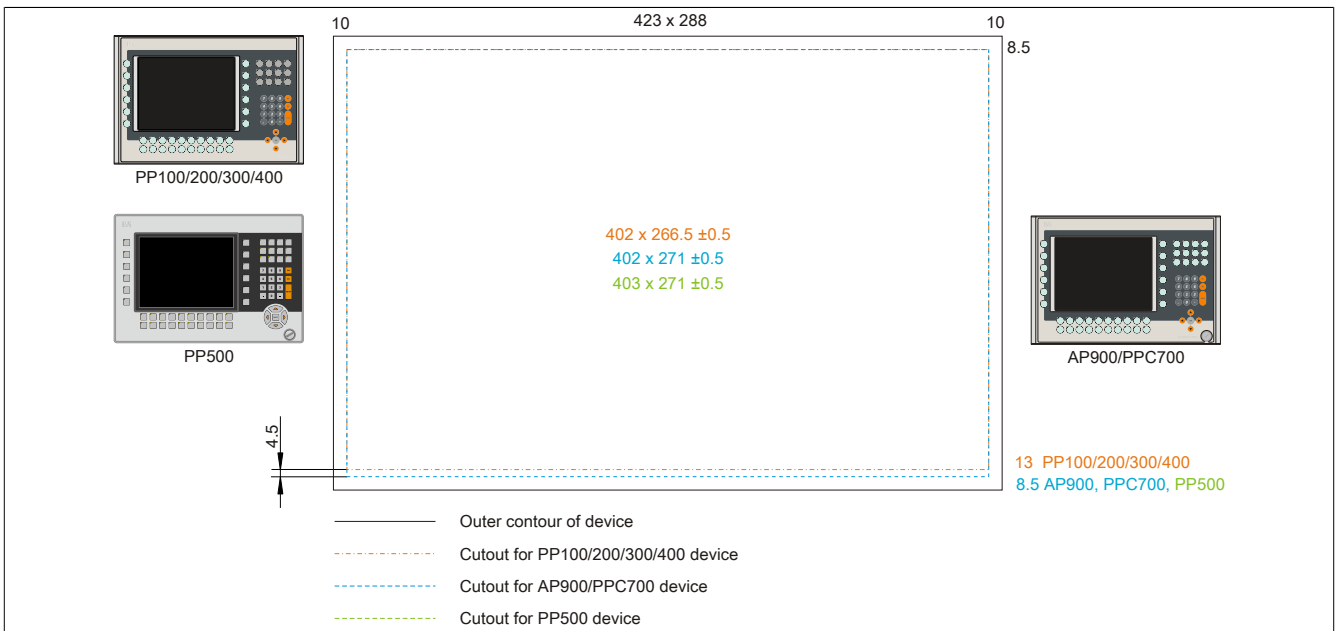

Figure 234: Mounting compatibility - 10.4" device - Horizontal2

10.4" Power Panel 500, Automation Panel 900 and Panel PC 700 devices are not 100% mounting compatible with Power Panel 100/200/300/400 devices in the Horizontal2 format. The Power Panel 500, Automation Panel 900 and Panel PC 700 devices require a cutout that is 4.5 mm higher (bottom edge).

The larger cutout can be used for all devices under certain conditions:

- When mounting, make sure that the PP100/200/300/400 devices are placed and mounted as close to the center of the cutout as possible. Failure to do so can prevent the retaining clips from holding firmly, which means that a firm seal is no longer guaranteed with the gasket (IP65).

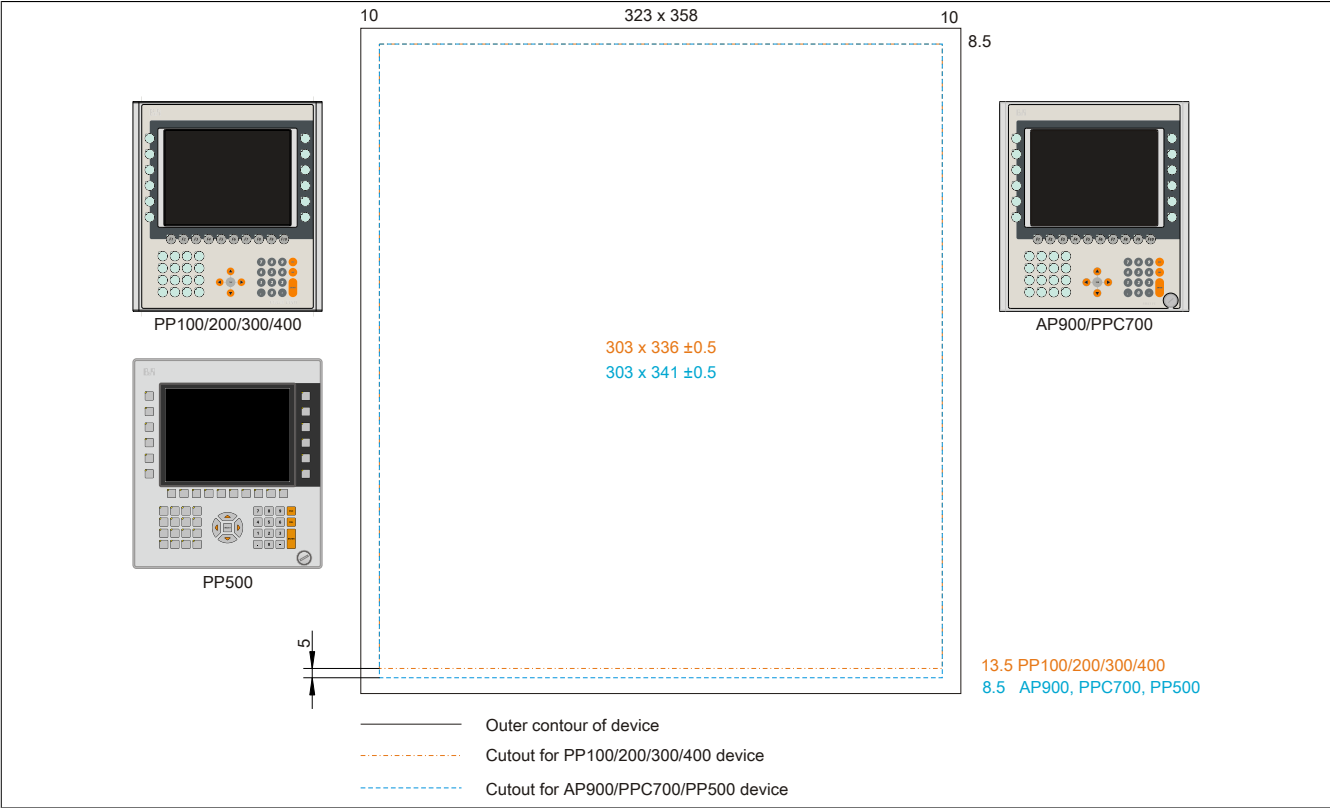

Figure 235: Mounting compatibility - 10.4" device - Vertical1

10.4" Power Panel 500, Automation Panel 900 and Panel PC 700 devices are not 100% mounting compatible with Power Panel 100/200/300/400 devices in Vertical1 format. The Power Panel 500, Automation Panel 900 and Panel PC 700 devices require a cutout that is 5 mm higher (bottom edge).

The larger cutout can be used for all devices under certain conditions:

- When mounting, make sure that the PP100/200/300/400 devices are placed and mounted as close to the center of the cutout as possible. Failure to do so can prevent the retaining clips from holding firmly, which means that a firm seal is no longer guaranteed with the gasket (IP65).

6.2.4 12.1" devices

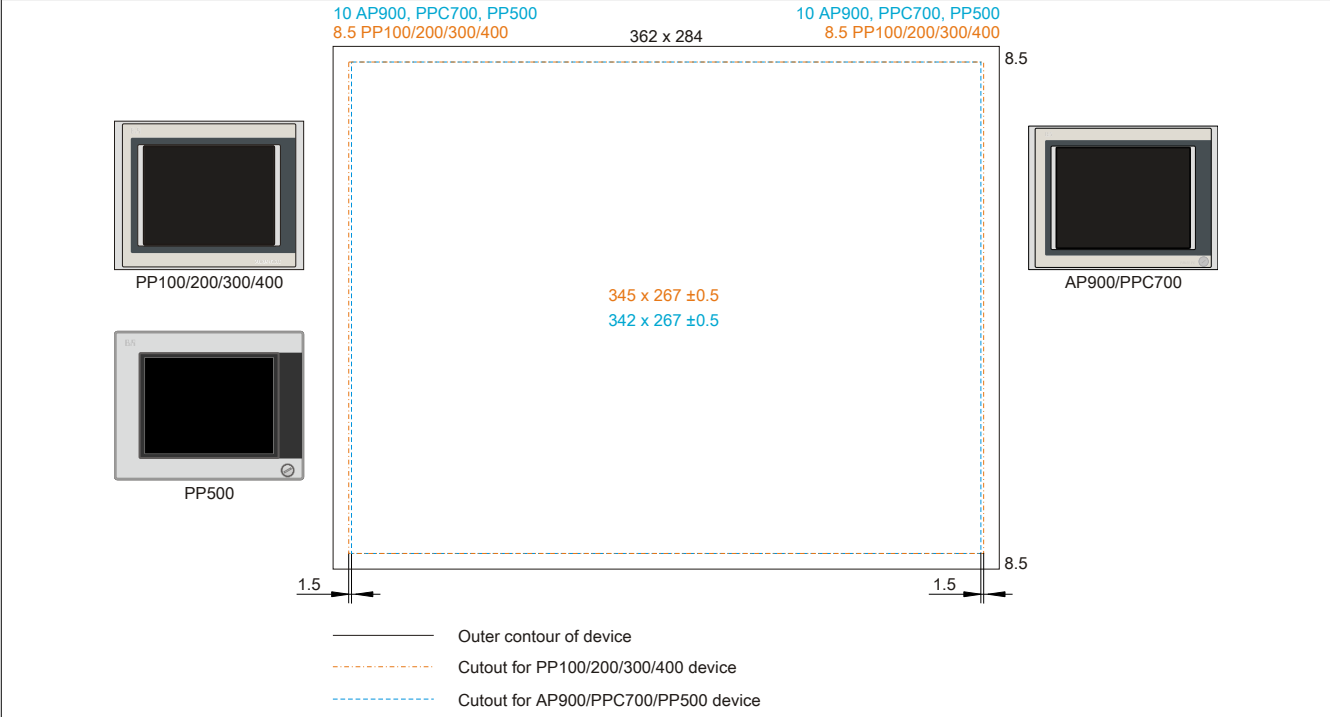

Figure 236: Mounting compatibility - 12.1" device - Horizontal1

12.1" Power Panel 500, Automation Panel 900 and Panel PC 700 devices are not 100% mounting compatible with Power Panel 100/200/300/400 devices in Horizontal1 format. The Power Panel 300/400 and Power Panel 100/200 devices require a cut that is 1.5 mm wider (left and right).

The larger cutout can be used for all devices under certain conditions:

- When mounting, make sure that the PP500, AP900 and PPC700 devices are mounted as close to the center of the cutout as possible.

6.2.5 15" devices

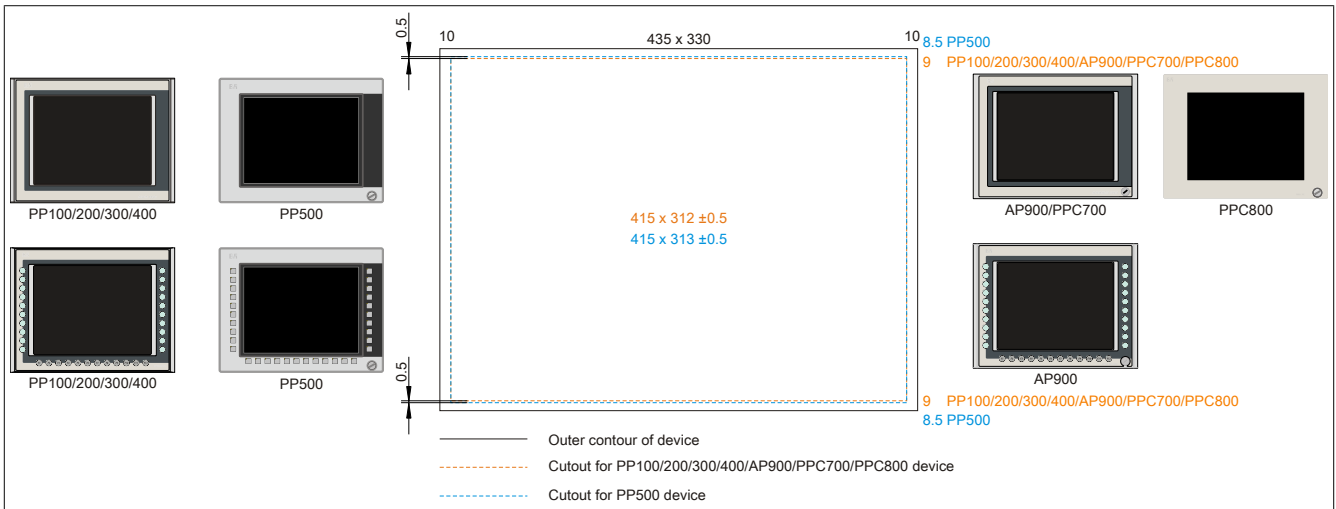

Figure 237: Mounting compatibility - 15" device - Horizontal1

15" Power Panel 500 devices are not 100% mounting compatible with Power Panel 100/200/300/400, Automation Panel 900, Panel PC 700 and Panel PC 800 devices in the Vertical1 format. The Power Panel 500 devices require a cutout that is 0.5 mm higher (top and bottom edge).

The larger cutout can be used for all devices under certain conditions:

- When mounting, make sure that the PP100/200, PP300/400, AP900, PPC700 and PPC800 devices are placed and mounted as close to the center of the cutout as possible. Failure to do so can prevent the retaining clips from holding firmly, which means that a firm seal is no longer guaranteed with the gasket (IP65).

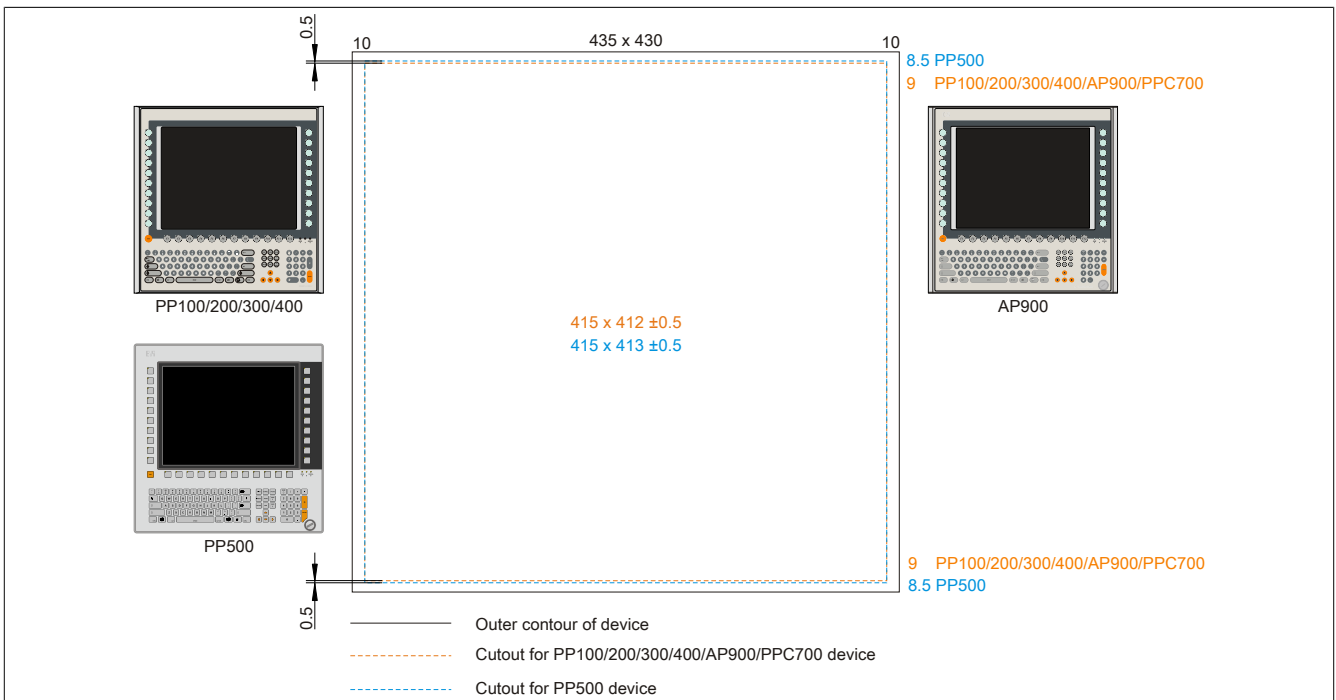

Figure 238: Mounting compatibility - 15" device - Vertical1

15" Power Panel 500 devices are not 100% mounting compatible with Power Panel 100/200/300/400, Automation Panel 900 and Panel PC 700 devices in the Vertical1 format. The Power Panel 500 devices require a cutout that is 0.5 mm higher (top and bottom edge).

The larger cutout can be used for all devices under certain conditions:

- When mounting, make sure that the PP100/200, PP300/400, AP900 and PPC700 devices are mounted as close to the center of the cutout as possible. Failure to do so can prevent the retaining clips from holding firmly, which means that a firm seal is no longer guaranteed with the gasket (IP65).

6.2.6 17" devices

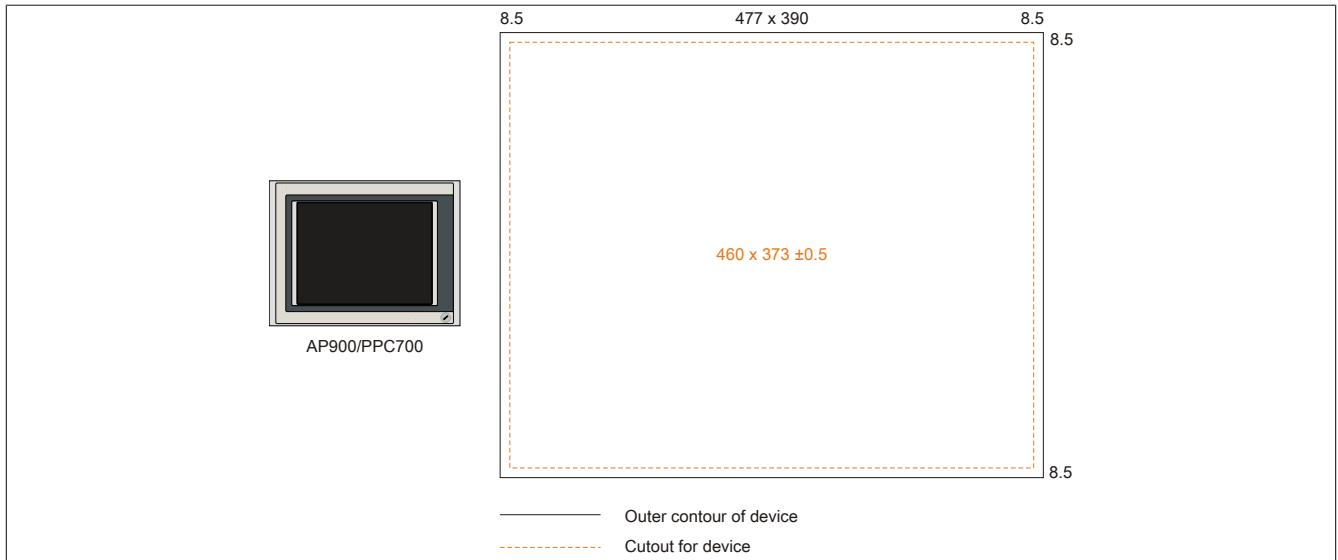

Figure 239: Mounting compatibility - 17" device - Horizontal1

17" Automation Panel 900 devices are 100% mounting compatible with Panel PC 700 devices in the Horizontal1 format.

6.2.7 19" devices

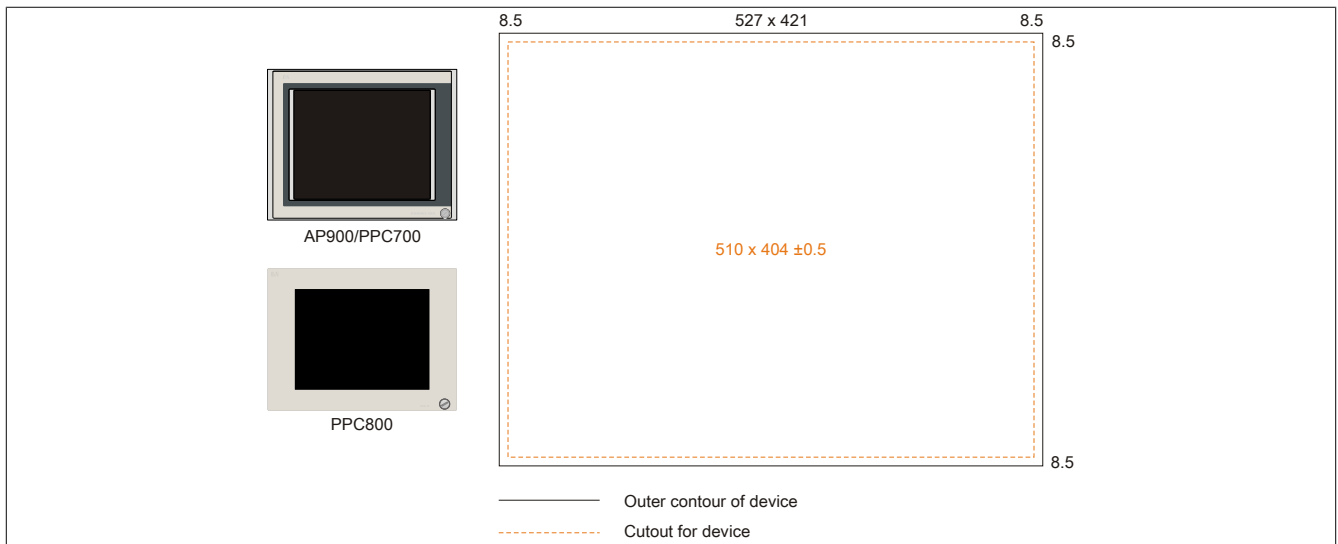

Figure 240: Mounting compatibility - 19" device - Horizontal1

19" Automation Panel 900, Panel PC 700 and Panel PC 800 are 100% mounting compatible in the Horizontal1 format.

6.2.8 21.3" devices

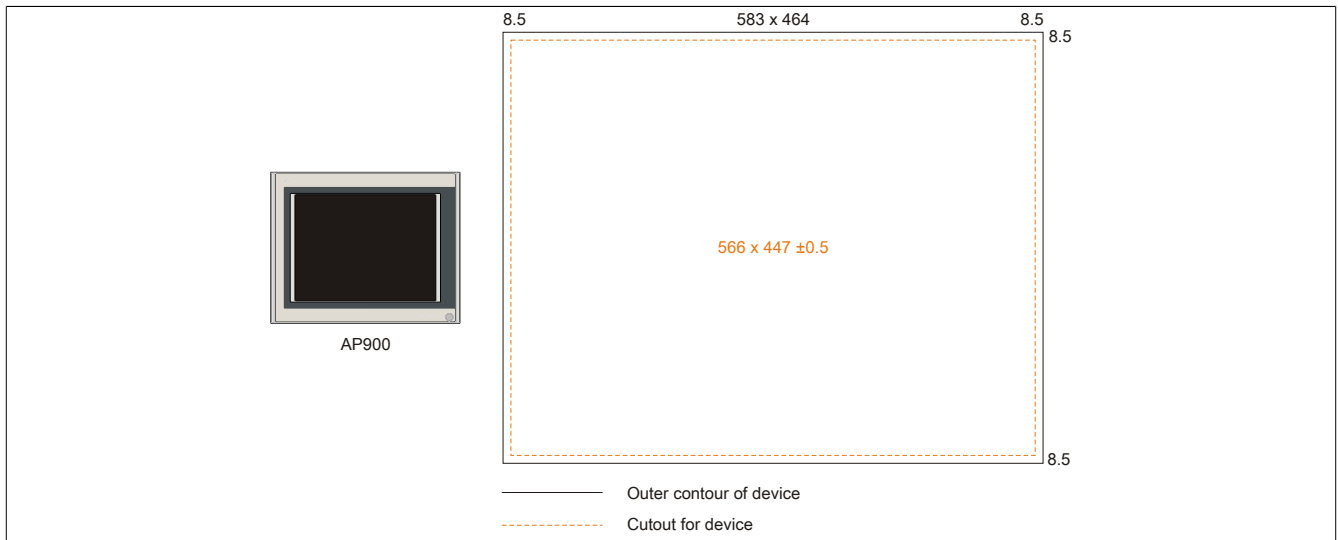

Figure 241: Mounting compatibility - 21.1" device - Horizontal1

7 Glossary

Address	An address is a character string for identifying a memory location or a memory area, where data is stored and can be retrieved. It is also a symbol (e.g. with numerical controllers) for identifying a function unit for which subsequent geometrical or technological data are determined by the symbol.
Algorithms	<p>According to DIN 19226: Algorithms are a finite series of well-defined regulations. The desired output quantities are created from permitted system input quantities. It describes how something is to be done. A procedure must at least satisfy the following requirements to be valid as an algorithm in a mathematical context.</p> <p><i>Discreteness:</i> An algorithm is made up of a finite series of steps.</p> <p><i>Determinacy:</i> Under the same start conditions, it always creates the same end result.</p> <p><i>Clearness:</i> The series of steps is clearly defined.</p> <p><i>Finiteness:</i> It ends after a finite number of steps.</p> <p>From a quantity theory perspective, an algorithm is clearly defined by a set of sizes [input, intermediate and output sizes], a set of elementary operations and also by a regulation, which specifies when and in what sequence certain operations should be carried out. From a functional perspective, it transfers a set of input sizes into a set of output sizes. It can be represented in text form in a natural or artificial formal language or using graphic representations [graph, program flow chart, structured chart, Petri Nets etc.].</p>
Analog Signal	A signal, whose information parameters can accept any number of values, within specific technical limits. Theoretically, they can have an infinitely high resolution. However, in practice it is limited to a range of only 1 to 104. In addition, long-term storage and allocation causes many size problems. Therefore, digital signals are predominantly used in modern automation technology.
ANSI	American National Standards Institute > this organization promotes and manages American industrial standards.
APC	Abbreviation for »Automation PC«
Application software	Software, which is not used for operation by the computer itself, but rather when a computer is used to process a concrete application problem. It sets up the system software and uses this for fulfilling individual tasks. Application software can be accommodated in standard software used by a large number of customers in a wide range of industries. Common examples are Word, Excel, PowerPoint, Paint, Matlab etc. Industrial software tailored to the respective problems of a certain industry and individual software created for solving the particular problems of an individual user.
Automation	According to Brockhaus: The application of technical means, using specific programs that (either partially or totally) do not require human intervention to perform operations.
Automation Runtime	A uniform runtime system for all B&R automation components.
Failure	Failure according to IEC 61508: A function unit loses the ability to perform a required function. In regards to safety-oriented systems, a distinction is made between dangerous and safe failures. This depends on whether the status of the system failure is considered dangerous or safe. The cause of the failure may be load related or age-related, and therefore a random failure, or related to a flaw inherent in the system. In this case, it is known as a systematic failure.

Figure 1:	Configuration - Base system.....	26
Figure 2:	Configuration - Optional components.....	27
Figure 3:	Temperature sensor locations.....	31
Figure 4:	Supply voltage block diagram.....	33
Figure 5:	Block diagram with bus unit 5AC803.BX01-00.....	36
Figure 6:	Block diagram with bus unit 5AC803.BX01-01.....	37
Figure 7:	Block diagram with bus unit 5AC803.BX02-00.....	38
Figure 8:	Block diagram with bus unit 5AC803.BX02-01.....	39
Figure 9:	Serial number sticker (back).....	40
Figure 10:	Example of serial number search.....	40
Figure 11:	Ground connection.....	41
Figure 12:	5PC820.1505-00 - Front view.....	55
Figure 13:	5PC820.1505-00 - Rear view.....	55
Figure 14:	5PC820.1505 - Dimensions.....	58
Figure 15:	5PC820.1505-00 - Cutout installation.....	58
Figure 16:	5PC820.1906-00 - Front view.....	61
Figure 17:	5PC820.1906-00 - Rear view.....	61
Figure 18:	5PC820.1906-00 - Dimensions.....	64
Figure 19:	5PC820.1906-00 - Cutout installation.....	64
Figure 20:	5AC803.SX01-00, 5AC803.SX02-00 - Slots.....	70
Figure 21:	5AC803.SX01-00 - Dimensions.....	71
Figure 22:	5AC803.SX02-00 - Dimensions.....	72
Figure 23:	Standard half-size PCI card - Dimensions.....	72
Figure 24:	Standard half-size PCIe card - Dimensions.....	73
Figure 25:	1-slot bus units.....	75
Figure 26:	2-slot bus units.....	75
Figure 27:	PCI Express compact plug-in cards - Dimensions.....	78
Figure 28:	POWERLINK card - 2-port node number switch.....	84
Figure 29:	Integrating the POWERLINK plug-in card in Automation Studio.....	84
Figure 30:	5AC801.HDDI-00 - Temperature humidity diagram.....	86
Figure 31:	5AC801.HDDI-02 - Temperature humidity diagram.....	88
Figure 32:	5AC801.HDDI-03 - Temperature humidity diagram.....	90
Figure 33:	5AC801.HDDI-04 - Temperature humidity diagram.....	92
Figure 34:	5AC801.SSDI-00 - Temperature/Humidity diagram.....	95
Figure 35:	5AC801.SSDI-00 - ATTO disk benchmark v2.34 - cyclic read.....	96
Figure 36:	5AC801.SSDI-00 - ATTO disk benchmark v2.34 - cyclic write.....	96
Figure 37:	5AC801.SSDI-01 - Temperature humidity diagram.....	98
Figure 38:	5AC801.SSDI-02 - Temperature humidity diagram.....	100
Figure 39:	5AC801.SSDI-03 ≤ Rev. C0 - Temperature/Humidity diagram.....	102
Figure 40:	5AC801.SSDI-03 ≥ Rev. D0 - Temperature/Humidity diagram.....	103
Figure 41:	5AC801.SSDI-04 ≤ Rev. C0 - Temperature/Humidity diagram.....	105
Figure 42:	5AC801.SSDI-04 ≥ Rev. D0 - Temperature/Humidity diagram.....	106
Figure 43:	5AC801.SSDI-05 - Temperature humidity diagram.....	108
Figure 44:	5MMSSD.0060-00 - Temperature humidity diagram.....	110
Figure 45:	5MMSSD.0060-01 ≤ Rev. C0 - Temperature/Humidity diagram.....	112
Figure 46:	5MMSSD.0060-01 ≥ Rev. D0 - Temperature/Humidity diagram.....	113
Figure 47:	5MMSSD.0128-01 ≤ Rev. C0 - Temperature/Humidity diagram.....	115
Figure 48:	5MMSSD.0128-01 ≥ Rev. D0 - Temperature/Humidity diagram.....	116
Figure 49:	5MMSSD.0180-00 - Temperature humidity diagram.....	118
Figure 50:	5MMSSD.0256-00 - Temperature/Humidity diagram.....	120
Figure 51:	5AC801.HDDS-00 - Temperature humidity diagram.....	123
Figure 52:	5AC801.DVDS-00 - Temperature humidity diagram.....	125
Figure 53:	5AC801.DVRS-00 - Temperature humidity diagram.....	128
Figure 54:	PCI SATA RAID controller.....	129
Figure 55:	5ACPCI.RAIC-03 - Temperature humidity diagram.....	131
Figure 56:	5ACPCI.RAIC-04 - Temperature humidity diagram.....	133
Figure 57:	PCI SATA RAID controller.....	134

Figure 58:	5ACPCI.RAIC-05 - Temperature humidity diagram.....	136
Figure 59:	PCI SATA RAID controller.....	137
Figure 60:	5ACPCI.RAIC-06 - Temperature humidity diagram.....	139
Figure 61:	5MMHDD.0250-00 - Temperature humidity diagram.....	141
Figure 62:	5MMHDD.0500-00 - Temperature humidity diagram.....	143
Figure 63:	5AC803.FA01-00 - Fan kit.....	144
Figure 64:	5AC803.FA02-00 - Fan kit.....	145
Figure 65:	5AC803.FA03-00 - Fan kit.....	147
Figure 66:	Clamping blocks.....	149
Figure 67:	Mounting orientation 0° and +/- 45°.....	151
Figure 68:	Mounting orientation with 5AC801.DVRS-00.....	152
Figure 69:	Mounting orientation with 5AC801.DVDS-00.....	153
Figure 70:	Spacing for air circulation.....	154
Figure 71:	Flex radius - Cable connection.....	155
Figure 72:	Symbol for functional ground.....	156
Figure 73:	Grounding concept.....	156
Figure 74:	Settings for Passmark BurnInTest Pro V4 and a 2-slot APC810 with DVD.....	158
Figure 75:	Test overview of a 2-slot APC810 with DVD.....	159
Figure 76:	One Automation Panel 900 via DVI.....	162
Figure 77:	One Automation Panel 900 system via onboard SDL.....	164
Figure 78:	One Automation Panel 800 system via onboard SDL.....	166
Figure 79:	One AP900 and one AP800 via onboard SDL.....	168
Figure 80:	Four Automation Panel 900 systems via onboard SDL.....	170
Figure 81:	Local connection of USB peripheral devices on the PPC800.....	173
Figure 82:	Remote connection of USB peripheral devices on the APC900 via DVI.....	174
Figure 83:	Remote connection of USB peripheral devices on the APC800/900 via SDL.....	175
Figure 84:	Open the RAID Configuration Utility.....	176
Figure 85:	RAID Configuration Utility - Menu.....	176
Figure 86:	RAID Configuration Utility - Menu.....	177
Figure 87:	RAID Configuration Utility - Create RAID set - Striped.....	177
Figure 88:	RAID Configuration Utility - Create RAID set - Mirrored.....	178
Figure 89:	RAID Configuration Utility - Delete RAID set.....	178
Figure 90:	RAID Configuration Utility - Rebuild mirrored set.....	179
Figure 91:	RAID Configuration Utility - Resolve conflicts.....	179
Figure 92:	RAID Configuration Utility - Low level format.....	180
Figure 93:	Boot Screen.....	184
Figure 94:	945GME BIOS Main Menü.....	186
Figure 95:	945GME Advanced Menü.....	187
Figure 96:	945GME Advanced ACPI Configuration.....	188
Figure 97:	945GME Advanced PCI Configuration.....	189
Figure 98:	945GME Advanced PCI IRQ Resource Exclusion.....	190
Figure 99:	945GME Advanced PCI Interrupt Routing.....	191
Figure 100:	945GME Advanced PCI Express Configuration.....	192
Figure 101:	945GME Advanced Graphics Configuration.....	194
Figure 102:	945GME Advanced CPU Configuration.....	196
Figure 103:	945GME Advanced Chipset Configuration.....	197
Figure 104:	945GME Advanced I/O Interface Configuration.....	198
Figure 105:	945GME Advanced Clock Configuration.....	198
Figure 106:	945GME Advanced IDE Configuration.....	199
Figure 107:	945GME Primary IDE Master.....	200
Figure 108:	945GME Primary IDE Slave.....	201
Figure 109:	945GME Secondary IDE Master.....	202
Figure 110:	945GME Secondary IDE Slave.....	203
Figure 111:	945GME Advanced USB Configuration.....	204
Figure 112:	945GME Advanced Keyboard/Mouse Configuration.....	205
Figure 113:	945GME Advanced Remote Access Configuration.....	206
Figure 114:	945GME Advanced CPU Board Monitor.....	207

Figure 115:	945GME Advanced Baseboard/Panel Features.....	208
Figure 116:	945GME Panel Control.....	209
Figure 117:	945GME Baseboard Monitor.....	210
Figure 118:	945GME Legacy Devices.....	211
Figure 119:	945GME Boot Menü.....	212
Figure 120:	945GME Security Menü.....	213
Figure 121:	945GME Hard Disk Security User Password.....	214
Figure 122:	945GME Hard Disk Security Master Password.....	215
Figure 123:	945GME Power Menü.....	215
Figure 124:	945GME Exit Menü.....	217
Figure 125:	PCI and PCIe routing with enabled APIC for 945GME CPU boards and BIOS versions ≥ 1.15.....	225
Figure 126:	Softwareversion.....	226
Figure 127:	Firmware version of the AP Link SDL transmitter.....	227
Figure 128:	Creating a bootable diskette in Windows XP - Step 1.....	231
Figure 129:	Creating a bootable diskette in Windows XP - Step 2.....	231
Figure 130:	Creating a bootable diskette in Windows XP - Step 3.....	231
Figure 131:	Creating a bootable diskette in Windows XP - Step 4.....	232
Figure 132:	Creating a bootable diskette in Windows XP - Step 5.....	232
Figure 133:	Creating a USB flash drive for B&R upgrade files.....	233
Figure 134:	Creating a CompactFlash card for B&R upgrade files.....	234
Figure 135:	ADI Control Center screenshots - Examples.....	252
Figure 136:	ADI Control Center - SDL Equalizer settings.....	254
Figure 137:	ADI Control Center - UPS settings.....	255
Figure 138:	ADI Control Center - UPS monitor.....	256
Figure 139:	ADI Control Center - UPS battery settings.....	257
Figure 140:	ADI Control Center - UPS settings.....	258
Figure 141:	ADI Control Center - Advanced UPS settings.....	260
Figure 142:	ADI Development Kit Screenshots (Version 3.70).....	262
Figure 143:	ADI .NET SDK screenshots (version 2.10).....	264
Figure 144:	B&R Key Editor screenshots (version 3.50).....	266
Figure 145:	UPS principle.....	276
Figure 146:	5AC600.UPSI-00 Add-on UPS module - Installation materials.....	278
Figure 147:	Deep discharge cycles.....	280
Figure 148:	5PC600.UPSB-00 - Dimensions.....	281
Figure 149:	5PC600.UPSB-00 - Drilling template.....	281
Figure 150:	Block diagram of the complete system.....	284
Figure 151:	5ACPCI.ETH1-01 - PCI 10/100 Ethernet card.....	286
Figure 152:	5ACPCI.ETH1-01 - Dimensions.....	288
Figure 153:	5ACPCI.ETH3-01 - PCI 10/100 Ethernet card.....	289
Figure 154:	5ACPCI.ETH3-01 - Dimensions.....	291
Figure 155:	5CFCRD.xxxx-06 - Temperature/Humidity diagram for CompactFlash cards.....	298
Figure 156:	Type I CompactFlash card - Dimensions.....	298
Figure 157:	ATTO Disk Benchmark v2.34 read comparison - 5CFCRD.xxxx-04 and 5CFCRD.xxxx-06.....	299
Figure 158:	ATTO Disk Benchmark v2.34 write comparison - 5CFCRD.xxxx-04 and 5CFCRD.xxxx-06.....	299
Figure 159:	5CFCRD.xxxx-04 - Temperature/Humidity diagram for CompactFlash cards.....	302
Figure 160:	Type I CompactFlash card - Dimensions.....	302
Figure 161:	ATTO Disk Benchmark v2.34 read comparison - 5CFCRD.xxxx-03 and 5CFCRD.xxxx-04.....	303
Figure 162:	ATTO Disk Benchmark v2.34 write comparison - 5CFCRD.xxxx-03 and 5CFCRD.xxxx-04.....	303
Figure 163:	5CFCRD.xxxx-03 - Temperature/Humidity diagram for CompactFlash cards.....	306
Figure 164:	Type I CompactFlash card - Dimensions.....	306
Figure 165:	5MMUSB.2048-00 - Temperature/Humidity diagram.....	309
Figure 166:	5MMUSB.xxxx-01 - Temperature/Humidity diagram.....	311
Figure 167:	5MD900.USB2-02 - Interfaces.....	312
Figure 168:	5MD900.USB2-02 - Dimensions.....	314
Figure 169:	USB media drive with front cover - Dimensions.....	314
Figure 170:	USB media drive with front cover - Installation cutout.....	315

Figure 171:	5MD900.USB2-02 - Mounting orientation	315
Figure 172:	5A5003.03 - Dimensions.....	316
Figure 173:	Front cover mounting and installation depth.....	317
Figure 174:	USB media drive with front cover - Installation cutout.....	317
Figure 175:	Flex radius specifications.....	322
Figure 176:	5CADVI.0xxx-00 - Dimensions.....	322
Figure 177:	5CADVI.0xxx-00 - Pinout.....	323
Figure 178:	Flex radius specifications.....	325
Figure 179:	5CASDL.0xxx-00- Dimensions.....	325
Figure 180:	5CASDL.0xxx-00 - Pinout.....	326
Figure 181:	Flex radius specifications.....	328
Figure 182:	5CASDL.0xxx-01 - Dimensions.....	328
Figure 183:	5CASDL.0xxx-01 - Pinout.....	329
Figure 184:	Flex radius specifications.....	331
Figure 185:	5CASDL.0xxx-03 - Dimensions.....	331
Figure 186:	5CASDL.0xxx-03 - Pinout.....	332
Figure 187:	Flex radius specification with extender.....	334
Figure 188:	5CASDL.0xx0-13 - Dimensions.....	334
Figure 189:	5CASDL.0xx0-13 - Pinout.....	335
Figure 190:	Example of the signal direction for an SDL flex cable with extender.....	336
Figure 191:	5CAUSB.00xx-00 USB cables - Pinout.....	337
Figure 192:	9A0014.xx RS232 cables - Pinout	339
Figure 193:	Removing the battery.....	342
Figure 194:	Battery handling.....	342
Figure 195:	Battery polarity.....	342
Figure 196:	CompactFlash + ejector.....	344
Figure 197:	Loosening the quick release screws.....	345
Figure 198:	Inserting the compact SATA drive.....	345
Figure 199:	Loosening the quick release screws.....	346
Figure 200:	Installing the slide-in drive.....	346
Figure 201:	Loosening the quick release screws.....	347
Figure 202:	Installing the slide-in compact adapter.....	347
Figure 203:	Inserting the slide-in compact drive.....	348
Figure 204:	Removing the fan kit cover.....	349
Figure 205:	Inserting the fan kit.....	349
Figure 206:	Securing the dust filter with the filter clasp.....	349
Figure 207:	5AC600.UPSI-00 Add-on UPS module - Installation materials.....	351
Figure 208:	Removing the UPS module cover.....	351
Figure 209:	Installing the UPS module.....	351
Figure 210:	Attaching the connection cable.....	352
Figure 211:	Connector locking mechanism.....	352
Figure 212:	Removing the cover for the battery unit.....	353
Figure 213:	Disconnecting the cable.....	353
Figure 214:	Connecting the fuse.....	354
Figure 215:	Securing the fuse.....	354
Figure 216:	Removing the screws.....	355
Figure 217:	Installing the bus unit.....	355
Figure 218:	Removing the screws.....	356
Figure 219:	Installing the 5AC803.BC01-00 adapter.....	356
Figure 220:	Installing the 5AC803.BC02-00 adapter.....	357
Figure 221:	Removing the PCIec module cover.....	358
Figure 222:	Inserting the PCIec plug-in card.....	358
Figure 223:	Installing the side cover on a PPC800 without an expansion.....	359
Figure 224:	Installing the side cover on a PPC800 with an expansion (1-slot expansion shown in image).....	359
Figure 225:	Screw layout on the back side of the 5ACPCI.RAIC-03 SATA RAID controller.....	360
Figure 226:	Replacing the hard disk.....	361
Figure 227:	MTCX controller location.....	362

Figure 228:	Connector location for external devices.....	364
Figure 229:	5-wire AMT touch screen - Temperature/Humidity diagram.....	365
Figure 230:	Overview of compatibility figures.....	370
Figure 231:	Mounting compatibility - 5.7" device - Horizontal1.....	370
Figure 232:	Mounting compatibility - 5.7" device - Horizontal2.....	371
Figure 233:	Mounting compatibility - 5.7" device - Vertical1.....	371
Figure 234:	Mounting compatibility - 10.4" device - Horizontal1.....	372
Figure 235:	Mounting compatibility - 10.4" device - Horizontal2.....	372
Figure 236:	Mounting compatibility - 10.4" device - Vertical1.....	373
Figure 237:	Mounting compatibility - 12.1" device - Horizontal1.....	373
Figure 238:	Mounting compatibility - 15" device - Horizontal1.....	374
Figure 239:	Mounting compatibility - 15" device - Vertical1.....	374
Figure 240:	Mounting compatibility - 17" device - Horizontal1.....	375
Figure 241:	Mounting compatibility - 19" device - Horizontal1.....	375
Figure 242:	Mounting compatibility - 21.1" device - Horizontal1.....	376

Table 1:	Manual history.....	13
Table 2:	Environmentally friendly separation of materials.....	18
Table 3:	Description of the safety notices used in this documentation.....	19
Table 4:	Range of nominal sizes.....	19
Table 5:	Ambient temperatures.....	29
Table 6:	Ambient temperatures.....	30
Table 7:	Temperature sensor locations.....	31
Table 8:	Overview of humidity specifications for individual components.....	32
Table 9:	Power calculation for 15" PPC800.....	34
Table 10:	Power calculation for 19" PPC800.....	35
Table 11:	24 VDC power supply interface.....	41
Table 12:	Monitor/Panel interface - SDL, DVI, RGB.....	42
Table 13:	DVI interface - Pinout.....	42
Table 14:	Cable lengths and resolutions for SDL transmission.....	43
Table 15:	Cable lengths and resolutions for DVI transmission.....	43
Table 16:	COM1 - Pinout.....	44
Table 17:	Ethernet interface (ETH1).....	45
Table 18:	Ethernet-Schnittstelle (ETH2).....	45
Table 19:	USB1-, USB2-, USB3-, USB4-Schnittstellen.....	46
Table 20:	USB5-Schnittstelle.....	46
Table 21:	CompactFlash slot (CF1).....	47
Table 22:	CompactFlash slot (CF2).....	47
Table 23:	MIC, Line IN, Line OUT.....	48
Table 24:	Add-on UPS slot.....	48
Table 25:	Power button.....	49
Table 26:	Reset button.....	49
Table 27:	LED status indicators.....	50
Table 28:	CMOS profile switch.....	50
Table 29:	Battery.....	51
Table 30:	Battery status.....	51
Table 31:	Slide-in compact slot.....	52
Table 32:	PClec slot.....	52
Table 33:	5PC820.1505-00 - Order data.....	53
Table 34:	5PC820.1505-00, 5PC820.1505-00 - Technical data.....	55
Table 35:	5PC820.1906-00 - Order data.....	59
Table 36:	5PC820.1906-00, 5PC820.1906-00 - Technical data.....	61
Table 37:	5PC800.B945-00, 5PC800.B945-01, 5PC800.B945-02, 5PC800.B945-03, 5PC800.B945-04, 5PC800.B945-05 - Order data.....	65
Table 38:	5PC800.B945-10, 5PC800.B945-11, 5PC800.B945-12, 5PC800.B945-13, 5PC800.B945-14 - Order data.....	65
Table 39:	5PC800.B945-00, 5PC800.B945-01, 5PC800.B945-02, 5PC800.B945-03, 5PC800.B945-04, 5PC800.B945-05 - Technical data.....	66
Table 40:	5PC800.B945-10, 5PC800.B945-11, 5PC800.B945-12, 5PC800.B945-13, 5PC800.B945-14 - Technical data.....	66
Table 41:	5AC803.HS00-00, 5AC803.HS00-01, 5AC803.HS00-02 - Order data.....	68
Table 42:	5AC803.HS00-00, 5AC803.HS00-01, 5AC803.HS00-02 - Technical data.....	68
Table 43:	5MMDDR.0512-01, 5MMDDR.1024-01, 5MMDDR.2048-01 - Order data.....	69
Table 44:	5MMDDR.0512-01, 5MMDDR.1024-01, 5MMDDR.2048-01 - Technical data.....	69
Table 45:	5AC803.SX01-00, 5AC803.SX02-00 - Order data.....	70
Table 46:	5AC803.SX01-00, 5AC803.SX02-00 - Technical data.....	70
Table 47:	Slide-in slot 1.....	74
Table 48:	5AC803.BX01-00, 5AC803.BX01-01, 5AC803.BX02-00, 5AC803.BX02-01 - Order data.....	75
Table 49:	5AC803.BX01-00, 5AC803.BX01-01, 5AC803.BX02-00, 5AC803.BX02-01 - Technical data.....	75
Table 50:	5AC803.BC01-00 - Order data.....	77
Table 51:	5AC803.BC02-00 - Order data.....	77
Table 52:	5ACPCC.ETH0-00 - Order data.....	79
Table 53:	5ACPCC.ETH0-00 - Technical data.....	79
Table 54:	5ACPCC.ETH0-00 - Ethernet interface.....	80

Table 55:	5ACPCC.MPL0-00 - Order data.....	81
Table 56:	5ACPCC.MPL0-00 - Technical data.....	81
Table 57:	5ACPCC.MPL0-00 - POWERLINK interface.....	82
Table 58:	Status/Error LED - Ethernet mode.....	82
Table 59:	Status/Error LED - POWERLINK V1 operating mode.....	82
Table 60:	Status/Error LED - POWERLINK - Error.....	82
Table 61:	Status/Error LED - POWERLINK - Status.....	83
Table 62:	System stop error codes.....	84
Table 63:	POWERLINK station number (x1, x16).....	84
Table 64:	5AC801.HDDI-00 - Order data.....	85
Table 65:	5AC801.HDDI-00 - Technical data.....	85
Table 66:	5AC801.HDDI-02 - Order data.....	87
Table 67:	5AC801.HDDI-02 - Technical data.....	87
Table 68:	5AC801.HDDI-03 - Order data.....	89
Table 69:	5AC801.HDDI-03 - Technical data.....	89
Table 70:	5AC801.HDDI-04 - Order data.....	91
Table 71:	5AC801.HDDI-04 - Technical data.....	91
Table 72:	5AC801.SSDI-00 - Order data.....	93
Table 73:	5AC801.SSDI-00 - Technical data.....	93
Table 74:	5AC801.SSDI-01 - Order data.....	97
Table 75:	5AC801.SSDI-01 - Technical data.....	97
Table 76:	5AC801.SSDI-02 - Order data.....	99
Table 77:	5AC801.SSDI-02 - Technical data.....	99
Table 78:	5AC801.SSDI-03 - Order data.....	101
Table 79:	5AC801.SSDI-03, 5AC801.SSDI-03 - Technical data.....	101
Table 80:	5AC801.SSDI-04 - Order data.....	104
Table 81:	5AC801.SSDI-04, 5AC801.SSDI-04 - Technical data.....	104
Table 82:	5AC801.SSDI-05 - Order data.....	107
Table 83:	5AC801.SSDI-05 - Technical data.....	107
Table 84:	5MMSSD.0060-00 - Order data.....	109
Table 85:	5MMSSD.0060-00 - Technical data.....	109
Table 86:	5MMSSD.0060-01 - Order data.....	111
Table 87:	5MMSSD.0060-01, 5MMSSD.0060-01 - Technical data.....	111
Table 88:	5MMSSD.0128-01 - Order data.....	114
Table 89:	5MMSSD.0128-01, 5MMSSD.0128-01 - Technical data.....	114
Table 90:	5MMSSD.0180-00 - Order data.....	117
Table 91:	5MMSSD.0180-00 - Technical data.....	117
Table 92:	5MMSSD.0256-00 - Order data.....	119
Table 93:	5MMSSD.0256-00 - Technical data.....	119
Table 94:	5AC801.ADAS-00 - Order data.....	121
Table 95:	5AC801.ADAS-00 - Technical data.....	121
Table 96:	5AC801.HDDS-00 - Order data.....	122
Table 97:	5AC801.HDDS-00 - Technical data.....	122
Table 98:	5AC801.DVDS-00 - Order data.....	124
Table 99:	5AC801.DVDS-00 - Technical data.....	124
Table 100:	5AC801.DVRS-00 - Order data.....	126
Table 101:	5AC801.DVRS-00 - Technical data.....	126
Table 102:	5ACPCI.RAIC-03 - Order data.....	129
Table 103:	5ACPCI.RAIC-03 - Technical data.....	130
Table 104:	5ACPCI.RAIC-04 - Order data.....	132
Table 105:	5ACPCI.RAIC-04 - Technical data.....	132
Table 106:	5ACPCI.RAIC-05 - Order data.....	134
Table 107:	5ACPCI.RAIC-05 - Technical data.....	135
Table 108:	5ACPCI.RAIC-06 - Order data.....	137
Table 109:	5ACPCI.RAIC-06 - Technical data.....	138
Table 110:	5MMHDD.0250-00 - Order data.....	140
Table 111:	5MMHDD.0250-00 - Technical data.....	140

Table 112:	5MMHDD.0500-00 - Order data.....	142
Table 113:	5MMHDD.0500-00 - Technical data.....	142
Table 114:	5AC803.FA01-00 - Order data.....	144
Table 115:	5AC803.FA01-00 - Technical data.....	144
Table 116:	5AC803.FA02-00 - Order data.....	145
Table 117:	5AC803.FA02-00 - Technical data.....	145
Table 118:	5AC803.FA03-00 - Order data.....	147
Table 119:	5AC803.FA03-00 - Technical data.....	147
Table 120:	Evaluation example using a 2-slot APC810.....	160
Table 121:	Selecting display units.....	161
Table 122:	Possible system unit and CPU board combinations.....	162
Table 123:	Link modules.....	162
Table 124:	Cables for DVI configurations.....	162
Table 125:	Possible Automation Panel devices, resolutions and segment lengths.....	163
Table 126:	Possible system unit and CPU board combinations.....	164
Table 127:	Link modules.....	164
Table 128:	Cables for SDL configurations.....	164
Table 129:	Cable lengths and resolutions for SDL transmission.....	165
Table 130:	Possible system unit and CPU board combinations.....	166
Table 131:	Cables for SDL configurations.....	166
Table 132:	Cable lengths and resolutions for SDL transmission.....	167
Table 133:	Possible system unit and CPU board combinations.....	168
Table 134:	Link modules.....	168
Table 135:	Possible system unit and CPU board combinations.....	170
Table 136:	Link modules.....	170
Table 137:	Cables for SDL configurations.....	171
Table 138:	Cable lengths and resolutions for SDL transmission.....	171
Table 139:	BIOS-relevant keys in the RAID Configuration Utility.....	176
Table 140:	BIOS-relevant keys for POST.....	185
Table 141:	BIOS-relevant keys.....	185
Table 142:	945GME Main menu - Configuration options.....	186
Table 143:	945GME Advanced menu.....	187
Table 144:	945GME Advanced - ACPI configuration - Configuration options.....	188
Table 145:	945GME Advanced - PCI configuration - Configuration options.....	189
Table 146:	945GME Advanced - PCI IRQ resource exclusion - Configuration options.....	190
Table 147:	945GME Advanced - PCI interrupt routing - Configuration options.....	191
Table 148:	945GME Advanced - PCI Express configuration - Configuration options.....	192
Table 149:	945GME Advanced - Graphics configuration - Configuration options.....	194
Table 150:	945GME Advanced - CPU configuration - Configuration options.....	196
Table 151:	945GME Advanced - Chipset settings - Configuration options.....	197
Table 152:	945GME Advanced - I/O interface configuration - Configuration options.....	198
Table 153:	945GME Advanced - Clock configuration - Configuration options.....	199
Table 154:	945GME Advanced - Primary IDE master - Configuration options.....	200
Table 155:	945GME Advanced - Primary IDE slave - Configuration options.....	201
Table 156:	945GME Advanced - Secondary IDE master - Configuration options.....	202
Table 157:	945GME Advanced - Secondary IDE slave - Configuration options.....	203
Table 158:	945GME Advanced - USB configuration - Configuration options.....	204
Table 159:	945GME Advanced - Keyboard/Mouse configuration - Configuration options.....	205
Table 160:	945GME Advanced - Remote access configuration - Configuration options.....	206
Table 161:	945GME Advanced - CPU board monitor - Configuration options.....	207
Table 162:	945GME Advanced - Baseboard/Panel features - Configuration options.....	208
Table 163:	945GME Advanced - Panel control - Configuration options.....	209
Table 164:	945GME Advanced - Baseboard monitor - Configuration options.....	210
Table 165:	945GME Advanced - Legacy devices - Configuration options.....	211
Table 166:	945GME Boot menu - Configuration options.....	212
Table 167:	945GME Security menu - Configuration options.....	213
Table 168:	945GME Security - Hard disk security user password.....	214

Table 169:	945GME Security - Hard disk security master password.....	215
Table 170:	945GME Power menu - Configuration options.....	216
Table 171:	855GME (XTX) Exit menu - Configuration options.....	217
Table 172:	Profile overview.....	218
Table 173:	945GME Main - Overview of profile settings.....	218
Table 174:	945GME Advanced - ACPI configuration - Overview of profile settings.....	218
Table 175:	945GME Advanced - PCI configuration - Overview of profile settings.....	218
Table 176:	945GME Advanced - PCI Express configuration - Overview of profile settings.....	219
Table 177:	945GME Advanced - Graphics configuration - Overview of profile settings.....	219
Table 178:	945GME Advanced - CPU configuration - Overview of profile settings.....	219
Table 179:	945GME Advanced - Chipset configuration - Overview of profile settings.....	220
Table 180:	945GME Advanced - I/O interface configuration - Overview of profile settings.....	220
Table 181:	945GME Advanced - Clock configuration - Overview of profile settings.....	220
Table 182:	945GME Advanced - IDE configuration - Overview of profile settings.....	220
Table 183:	945GME Advanced - USB configuration - Overview of profile settings.....	221
Table 184:	945GME Advanced - Keyboard/Mouse configuration - Overview of profile settings.....	221
Table 185:	945GME Advanced - CPU board monitor - Overview of profile settings.....	221
Table 186:	945GME Advanced - Baseboard/Panel features - Overview of profile settings.....	221
Table 187:	945GME Boot - Overview of profile settings.....	222
Table 188:	945GME Security - Overview of profile settings.....	222
Table 189:	945GME Power - Overview of profile settings.....	222
Table 190:	945GME BIOS - POST messages.....	223
Table 191:	RAM address assignment.....	224
Table 192:	I/O address assignment.....	224
Table 193:	IRQ interrupt assignments in PIC mode.....	224
Table 194:	IRQ interrupt assignments in APIC mode.....	225
Table 195:	9S0000.01-010, 9S0000.01-020 - Order data.....	235
Table 196:	Tested resolutions and color depths for DVI signals.....	235
Table 197:	Tested resolutions and color depths for RGB signals.....	235
Table 198:	5SWWXP.0600-GER, 5SWWXP.0600-ENG, 5SWWXP.0600-MUL, 5SWWXP.0500-GER, 5SWWXP.0500-ENG, 5SWWXP.0500-MUL - Order data.....	236
Table 199:	5SWWI7.0100-GER, 5SWWI7.1100-GER, 5SWWI7.0100-ENG, 5SWWI7.1100-ENG, 5SWWI7.0200-GER, 5SWWI7.1200-GER, 5SWWI7.0200-ENG, 5SWWI7.1200-ENG, 5SWWI7.0300-MUL, 5SWWI7.1300-MUL, 5SWWI7.0400-MUL, 5SWWI7.1400-MUL - Order data.....	238
Table 200:	5SWWXP.0427-ENG - Order data.....	241
Table 201:	Device functions in Windows XP Embedded with FP2007.....	241
Table 202:	5SWWXP.0727-ENG - Order data.....	243
Table 203:	Device functions in Windows Embedded Standard 2009.....	243
Table 204:	5SWWI7.0527-ENG, 5SWWI7.1527-ENG, 5SWWI7.0627-ENG, 5SWWI7.1627-ENG, 5SWWI7.0727-MUL, 5SWWI7.1727-MUL, 5SWWI7.0827-MUL, 5SWWI7.1827-MUL - Order data.....	245
Table 205:	Device functions in Windows Embedded Standard 7.....	246
Table 206:	5SWWCE.0827-ENG - Order data.....	248
Table 207:	Windows CE 6.0 features.....	248
Table 208:	0TG1000.01, 1TG4600.10-5, 1TG4601.06-5 - Order data.....	250
Table 209:	0AC201.91, 4A0006.00-000 - Order data.....	270
Table 210:	0AC201.91, 4A0006.00-000 - Technical data.....	270
Table 211:	0TB103.9, 0TB103.91 - Order data.....	272
Table 212:	0TB103.9, 0TB103.91 - Technical data.....	272
Table 213:	5AC900.1000-00 - Order data.....	273
Table 214:	5AC900.1201-00 - Order data.....	274
Table 215:	5AC900.1201-01 - Order data.....	274
Table 216:	5AC900.BLOC-00 - Order data.....	275
Table 217:	5AC600.UPSI-00 - Order data.....	277
Table 218:	5AC600.UPSI-00 - Technical data.....	277
Table 219:	5AC600.UPSB-00 - Order data.....	279
Table 220:	5AC600.UPSB-00, 5AC600.UPSB-00 - Technical data.....	279

Table 221:	5CAUPS.0005-00, 5CAUPS.0030-00 - Order data.....	282
Table 222:	5CAUPS.0005-00, 5CAUPS.0030-00 - Technical data.....	282
Table 223:	5AC600.UPSF-00 - Order data.....	283
Table 224:	5AC600.UPSF-01 - Order data.....	283
Table 225:	9A0100.11, 9A0100.12, 9A0100.13, 9A0100.14, 9A0100.15, 9A0100.16, 9A0100.17 - Order data.....	284
Table 226:	5ACPCI.ETH1-01 - Order data.....	286
Table 227:	5ACPCI.ETH1-01 - Technical data.....	286
Table 228:	5ACPCI.ETH1-01 - Technical data.....	287
Table 229:	5ACPCI.ETH3-01 - Order data.....	289
Table 230:	5ACPCI.ETH3-01 - Technical data.....	289
Table 231:	5ACPCI.ETH3-01 - Technical data.....	290
Table 232:	5CFCRD.0512-06, 5CFCRD.1024-06, 5CFCRD.2048-06, 5CFCRD.4096-06, 5CFCRD.8192-06, 5CFCRD.016G-06, 5CFCRD.032G-06 - Order data.....	294
Table 233:	5CFCRD.0512-06, 5CFCRD.1024-06, 5CFCRD.2048-06, 5CFCRD.4096-06, 5CFCRD.8192-06, 5CFCRD.016G-06, 5CFCRD.032G-06 - Order data.....	294
Table 234:	5CFCRD.0512-06, 5CFCRD.1024-06, 5CFCRD.2048-06, 5CFCRD.4096-06, 5CFCRD.8192-06, 5CFCRD.016G-06, 5CFCRD.032G-06 - Technical data.....	295
Table 235:	5CFCRD.0512-06, 5CFCRD.1024-06, 5CFCRD.2048-06, 5CFCRD.4096-06, 5CFCRD.8192-06, 5CFCRD.016G-06, 5CFCRD.032G-06 - Technical data.....	296
Table 236:	5CFCRD.0512-04, 5CFCRD.1024-04, 5CFCRD.2048-04, 5CFCRD.4096-04, 5CFCRD.8192-04, 5CFCRD.016G-04 - Order data.....	300
Table 237:	5CFCRD.0512-04, 5CFCRD.1024-04, 5CFCRD.2048-04, 5CFCRD.4096-04, 5CFCRD.8192-04, 5CFCRD.016G-04 - Technical data.....	300
Table 238:	5CFCRD.0064-03, 5CFCRD.0128-03, 5CFCRD.0256-03, 5CFCRD.0512-03, 5CFCRD.1024-03, 5CFCRD.2048-03, 5CFCRD.4096-03, 5CFCRD.8192-03 - Order data.....	304
Table 239:	5CFCRD.0064-03, 5CFCRD.0128-03, 5CFCRD.0256-03, 5CFCRD.0512-03, 5CFCRD.1024-03, 5CFCRD.2048-03, 5CFCRD.4096-03, 5CFCRD.8192-03 - Technical data.....	304
Table 240:	5MMUSB.2048-00 - Order data.....	308
Table 241:	5MMUSB.2048-00 - Technical data.....	308
Table 242:	5MMUSB.2048-01, 5MMUSB.4096-01 - Order data.....	310
Table 243:	5MMUSB.2048-01, 5MMUSB.4096-01 - Technical data.....	310
Table 244:	5MD900.USB2-02 - Order data.....	312
Table 245:	5MD900.USB2-02 - Technical data.....	312
Table 246:	5MD900.USB2-02 - Contents of delivery.....	315
Table 247:	5A5003.03 - Order data.....	316
Table 248:	5A5003.03 - Technical data.....	316
Table 249:	5A5003.03 - Contents of delivery.....	316
Table 250:	5SWHMI.0000-00 - Order data.....	318
Table 251:	5CADVI.0018-00, 5CADVI.0050-00, 5CADVI.0100-00 - Order data.....	321
Table 252:	5CADVI.0018-00, 5CADVI.0050-00, 5CADVI.0100-00 - Technical data.....	321
Table 253:	5CASDL.0018-00, 5CASDL.0050-00, 5CASDL.0100-00, 5CASDL.0150-00, 5CASDL.0200-00, 5CASDL.0250-00, 5CASDL.0300-00 - Order data.....	324
Table 254:	5CASDL.0018-00, 5CASDL.0050-00, 5CASDL.0100-00, 5CASDL.0150-00, 5CASDL.0200-00, 5CASDL.0250-00, 5CASDL.0300-00 - Technical data.....	324
Table 255:	5CASDL.0018-01, 5CASDL.0050-01, 5CASDL.0100-01, 5CASDL.0150-01 - Order data.....	327
Table 256:	5CASDL.0018-01, 5CASDL.0050-01, 5CASDL.0100-01, 5CASDL.0150-01 - Technical data.....	327
Table 257:	5CASDL.0018-03, 5CASDL.0050-03, 5CASDL.0100-03, 5CASDL.0150-03, 5CASDL.0200-03, 5CASDL.0250-03, 5CASDL.0300-03 - Order data.....	330
Table 258:	5CASDL.0018-03, 5CASDL.0050-03, 5CASDL.0100-03, 5CASDL.0150-03, 5CASDL.0200-03, 5CASDL.0250-03, 5CASDL.0300-03 - Technical data.....	330
Table 259:	5CASDL.0xxx-03 SDL flex cables - Structure.....	332
Table 260:	5CASDL.0300-13, 5CASDL.0400-13, 5CASDL.0430-13 - Order data.....	333
Table 261:	5CASDL.0300-13, 5CASDL.0400-13, 5CASDL.0430-13 - Technical data.....	333
Table 262:	5CAUSB.0018-00, 5CAUSB.0050-00 - Order data.....	337
Table 263:	5CAUSB.0018-00, 5CAUSB.0050-00 - Technical data.....	337
Table 264:	9A0014.02, 9A0014.05, 9A0014.10 - Order data.....	338
Table 265:	9A0014.02, 9A0014.05, 9A0014.10 - Technical data.....	338

Table 266:	5CAMSC.0001-00 - Order data.....	340
Table 267:	5CAMSC.0001-00 - Technical data.....	340
Table 268:	Battery status.....	341
Table 269:	Overview of required replacement SATA HDD for PCI SATA HDD RAID controller.....	360
Table 270:	Temperature limits of the fan (MTCX PX32 V1.01).....	363
Table 271:	Connector on the mainboard - Pinout.....	364
Table 272:	5-wire AMT touch screen - Technical data.....	365
Table 273:	Chemical resistance of the panel overlay.....	367
Table 274:	Product abbreviations.....	369
Table 275:	Overview of device compatibility.....	369

0AC201.91.....	270
0TB103.9.....	272
0TB103.91.....	272
0TG1000.01.....	250
1TG4600.10-5.....	250
1TG4601.06-5.....	250
4A0006.00-000.....	270
5A5003.03.....	316
5AC600.UPSB-00.....	279
5AC600.UPSF-00.....	283
5AC600.UPSF-01.....	283
5AC600.UPSI-00.....	277
5AC801.ADAS-00.....	121
5AC801.DVDS-00.....	124
5AC801.DVRS-00.....	126
5AC801.HDDI-00.....	85
5AC801.HDDI-02.....	87
5AC801.HDDI-03.....	89
5AC801.HDDI-04.....	91
5AC801.HDDS-00.....	122
5AC801.SSDI-00.....	93
5AC801.SSDI-01.....	97
5AC801.SSDI-02.....	99
5AC801.SSDI-03.....	101
5AC801.SSDI-04.....	104
5AC801.SSDI-05.....	107
5AC803.BC01-00.....	77
5AC803.BC02-00.....	77
5AC803.BX01-00.....	75
5AC803.BX01-01.....	75
5AC803.BX02-00.....	75
5AC803.BX02-01.....	75
5AC803.FA01-00.....	144
5AC803.FA02-00.....	145
5AC803.FA03-00.....	147
5AC803.HS00-00.....	68
5AC803.HS00-01.....	68
5AC803.HS00-02.....	68
5AC803.SX01-00.....	70
5AC803.SX02-00.....	70
5AC900.1000-00.....	273
5AC900.1201-00.....	274
5AC900.1201-01.....	274
5AC900.BLOC-00.....	275
5ACPCC.ETH0-00.....	79
5ACPCC.MPL0-00.....	81
5ACPCI.ETH1-01.....	286
5ACPCI.ETH3-01.....	289
5ACPCI.RAIC-03.....	129
5ACPCI.RAIC-04.....	132
5ACPCI.RAIC-05.....	134
5ACPCI.RAIC-06.....	137
5CADVI.0018-00.....	321
5CADVI.0050-00.....	321
5CADVI.0100-00.....	321
5CAMSC.0001-00.....	340
5CASDL.0018-00.....	324
5CASDL.0018-01.....	327
5CASDL.0018-03.....	330
5CASDL.0050-00.....	324
5CASDL.0050-01.....	327
5CASDL.0050-03.....	330

5CASDL.0100-00.....	324
5CASDL.0100-01.....	327
5CASDL.0100-03.....	330
5CASDL.0150-00.....	324
5CASDL.0150-01.....	327
5CASDL.0150-03.....	330
5CASDL.0200-00.....	324
5CASDL.0200-03.....	330
5CASDL.0250-00.....	324
5CASDL.0250-03.....	330
5CASDL.0300-00.....	324
5CASDL.0300-03.....	330
5CASDL.0300-13.....	333
5CASDL.0400-13.....	333
5CASDL.0430-13.....	333
5CAUPS.0005-00.....	282
5CAUPS.0030-00.....	282
5CAUSB.0018-00.....	337
5CAUSB.0050-00.....	337
5CFCRD.0064-03.....	304
5CFCRD.0128-03.....	304
5CFCRD.016G-04.....	300
5CFCRD.016G-06.....	294
5CFCRD.0256-03.....	304
5CFCRD.032G-06.....	294
5CFCRD.0512-03.....	304
5CFCRD.0512-04.....	300
5CFCRD.0512-06.....	294
5CFCRD.1024-03.....	304
5CFCRD.1024-04.....	300
5CFCRD.1024-06.....	294
5CFCRD.2048-03.....	304
5CFCRD.2048-04.....	300
5CFCRD.2048-06.....	294
5CFCRD.4096-03.....	304
5CFCRD.4096-04.....	300
5CFCRD.4096-06.....	294
5CFCRD.8192-03.....	304
5CFCRD.8192-04.....	300
5CFCRD.8192-06.....	294
5MD900.USB2-02.....	312
5MMDDR.0512-01.....	69
5MMDDR.1024-01.....	69
5MMDDR.2048-01.....	69
5MMHDD.0250-00.....	140
5MMHDD.0500-00.....	142
5MMSSD.0060-00.....	109
5MMSSD.0060-01.....	111
5MMSSD.0128-01.....	114
5MMSSD.0180-00.....	117
5MMSSD.0256-00.....	119
5MMUSB.2048-00.....	308
5MMUSB.2048-01.....	310
5MMUSB.4096-01.....	310
5PC800.B945-00.....	65
5PC800.B945-01.....	65
5PC800.B945-02.....	65
5PC800.B945-03.....	65
5PC800.B945-04.....	65
5PC800.B945-05.....	65
5PC800.B945-10.....	65
5PC800.B945-11.....	65

5PC800.B945-12.....	65
5PC800.B945-13.....	65
5PC800.B945-14.....	65
5PC820.1505-00.....	53
5PC820.1906-00.....	59
5SWHMI.0000-00.....	318
5SWWCE.0827-ENG.....	248
5SWWI7.0100-ENG.....	238
5SWWI7.0100-GER.....	238
5SWWI7.0200-ENG.....	238
5SWWI7.0200-GER.....	238
5SWWI7.0300-MUL.....	238
5SWWI7.0400-MUL.....	238
5SWWI7.0527-ENG.....	245
5SWWI7.0627-ENG.....	245
5SWWI7.0727-MUL.....	245
5SWWI7.0827-MUL.....	245
5SWWI7.1100-ENG.....	238
5SWWI7.1100-GER.....	238
5SWWI7.1200-ENG.....	238
5SWWI7.1200-GER.....	238
5SWWI7.1300-MUL.....	238
5SWWI7.1400-MUL.....	238
5SWWI7.1527-ENG.....	245
5SWWI7.1627-ENG.....	245
5SWWI7.1727-MUL.....	245
5SWWI7.1827-MUL.....	245
5SWWXP.0427-ENG.....	241
5SWWXP.0500-ENG.....	236
5SWWXP.0500-GER.....	236
5SWWXP.0500-MUL.....	236
5SWWXP.0600-ENG.....	236
5SWWXP.0600-GER.....	236
5SWWXP.0600-MUL.....	236
5SWWXP.0727-ENG.....	243
9A0014.02.....	338
9A0014.05.....	338
9A0014.10.....	338
9A0100.11.....	284
9A0100.12.....	284
9A0100.13.....	284
9A0100.14.....	284
9A0100.15.....	284
9A0100.16.....	284
9A0100.17.....	284
9S0000.01-010.....	235
9S0000.01-020.....	235

9

945GME.....	65
945GME CPU board.....	65

A

Abbreviation.....	369
Accessories.....	270
ACPI.....	224, 225
Adapters.....	77
add-on UPS module.....	277
Add-on UPS slot.....	48
ADI.....	252
.NET SDK.....	264
Development Kit.....	262
SDL Equalizer settings.....	254
air circulation.....	154, 154
Ambient temperature.....	29, 30
Maximum.....	29
Minimum.....	31
ARemb.....	251
ARwin.....	250
Automation Runtime.....	250
Automation Runtime Embedded.....	251
Automation Runtime Windows.....	250

B

B&R Automation Device Interface.....	252
B&R CompactFlash.....	300
B&R Control Center.....	252
B&R Embedded OS Installer.....	234, 249
B&R Key Editor.....	266
Backlight.....	181
Battery.....	51
beep codes.....	223
BIOS error signals.....	223
BIOS Setup keys.....	185
BIOS upgrade.....	226
Block diagrams.....	36
bus units.....	72, 75

C

Cable connections.....	155
Cable lengths.....	43, 43
Cables.....	321
DVI.....	321
RS232.....	338
SDL.....	324
SDL flex.....	330
SDL flex cables with extender.....	333
SDL with 45° male connector.....	327
USB.....	337
Card slot.....	52
CE mark.....	268
Certifications.....	269
certifications	
GOST-R.....	269
Certifications	

UL.....	269
CF1.....	47
CF2.....	47
Chemical resistance.....	367
Clamping blocks.....	275
Cleaning.....	343, 365
climate-controlled chamber.....	160
CMOS profile switch.....	50
COM1.....	44
CompactFlash	
Benchmark.....	303
CompactFlash cards.....	292
CompactFlash slot.....	47, 47
Complete system.....	28
Configuration	
Base system.....	26
Optional components.....	27
Connecting an external device.....	364
Control Center.....	157, 252
CPU board.....	65
Creating reports.....	252
Cutout - PPC800 15".....	58
Cutout - PPC800 19".....	64

D

dead/stuck pixels.....	181
defective pixels.....	181
deflect disturbances.....	156
Device interfaces and slots.....	41
Dimensions	
5A5003.03.....	316
5MD900.USB2-02.....	314
Dimensions - PPC800 15".....	58
Dimensions - PPC800 19".....	64
Dimension standards.....	19
Disposal.....	18, 18
Distribution of resources	
I/O address assignments.....	224
dongle.....	251
Drives.....	85
dual-channel memory.....	69
DVI.....	42
DVI cables.....	321
DVI resolution.....	43
DVI transmission.....	43, 43
Dynamic wear leveling.....	292

E

Electromagnetic compatibility.....	268
Embedded OS Installer.....	234
EMC directive.....	268
ESD.....	16
Electrical components with a housing.....	16
Electrical components without a housing.....	16
Individual components.....	16
Packaging.....	16
ETH1.....	45
Ethernet.....	45
evaluate the temperature.....	158
Evaluating temperatures.....	157

Evaluating the battery status.....	51, 341
example programs.....	160
Expansions.....	70
External device.....	364
F	
Fan control.....	362
Fan kit.....	144
Firmware upgrade.....	229
Flex radius.....	155
Flex radius specifications.....	155
Functional ground.....	41, 156
G	
General tolerance.....	19
GOST-R.....	269
Gosudarstwenny standard.....	269
ground connection.....	41, 156
Grounding.....	41
Grounding concept.....	156
Guidelines.....	19
H	
HDA sound.....	48
Heat sink.....	68
HMI Drivers & Utilities DVD.....	318
Humidity specifications.....	32
I	
I/O address assignment.....	224
immunity to disturbances.....	156
implementation guide.....	160
Inserts.....	70
Installation	
with clamping blocks.....	149
Installing and replacing adapters.....	356
Installing and replacing bus units.....	355
Installing and replacing fan kits.....	349
Installing and replacing PCIec plug-in cards.....	358
Installing and replacing slide-in compact drives.....	345
Installing and replacing slide-in drives.....	346
Installing the side cover.....	359
Installing the slide-in compact adapter.....	347
Installing the UPS fuse kit.....	353
Installing the UPS module.....	351
Interfaces.....	41
Interrupt assignment.....	224
K	
Key Editor.....	266
L	
LED status indicators.....	50
loopback plug.....	159
Low battery.....	259, 261

Low voltage directive..... 268

M

Main memory..... 69
 Maintenance Controller Extended..... 362
 Manual history..... 13
 Monitor/Panel interface..... 42
 Mounting compatibility..... 369
 Mounting orientation..... 151
 MS-DOS..... 235
 MTCX..... 362
 MTCX upgrade..... 50

O

Operating system
 Windows 7..... 238
 Windows CE..... 248
 Windows Embedded Standard 2009..... 243
 Windows Embedded Standard 7..... 245
 Windows XP Embedded..... 241
 Windows XP Professional..... 236

P

Panel overlay..... 367
 Parity error..... 223
 PCI..... 286
 PCIe..... 78
 PCIe slot..... 52
 Peripheral USB devices..... 173
 plug-in card..... 78, 286
 Power button..... 49
 Power calculation..... 34, 35
 Power connectors..... 272
 power failure..... 50, 261
 POWERLINK
 Card number switch..... 84
 Link LED..... 82
 Speed LED..... 82
 station number..... 84
 Status/Error LED..... 82
 System stop error codes..... 84
 power supply..... 41, 156
 PPC800 15"
 Cutout..... 58
 Dimensions..... 58
 Interfaces..... 55
 Power calculation..... 34
 Technical data..... 55
 PPC800 19"
 Cutout..... 64
 Dimensions..... 64
 Interfaces..... 61
 Power calculation..... 35
 Technical data..... 61
 PPC800 interfaces 15"..... 55
 PPC800 interfaces 19"..... 61
 Product abbreviations..... 369
 Proper ESD
 handling..... 16

R

Relative humidity.....	32
Replacing a CompactFlash card.....	344
Replacing a PCI SATA RAID hard disk.....	360
Replacing the battery.....	341
Reset button.....	49
Resolution.....	65
Reversed battery polarity.....	256
RGB.....	42
RS232 cables.....	338

S

Safety guidelines.....	16
Environmental conditions.....	17
Environmentally friendly disposal.....	18
Installation.....	17
Intended use.....	16
Operation.....	17
Policies and procedures.....	16
Protection against electrostatic discharge.....	16
Separation of materials.....	18
Transport and storage.....	17
Screen burn-in.....	181, 181
SDL.....	42
SDL cables.....	324
SDL cables with 45° male connector.....	327
SDL flex cables.....	330
SDL flex cables with extender.....	333
SDL resolution.....	43
SDL transmission.....	43, 43
serial interface.....	44
Serial number sticker.....	40, 40
service life of the display.....	181
Slide-in compact slot.....	52
Slide-in slot.....	74
Slots.....	41
software versions.....	252
spacing.....	154
Standards and guidelines.....	268
Static wear leveling.....	292
Supply voltage block diagram.....	33

T

Technical data - PPC800 15".....	55
Technical data - PPC800 19".....	61
Technology Guarding.....	251
Temperature monitoring.....	31, 362
Temperature monitoring - Fan control.....	362
Temperature sensor locations.....	31
Temperature specifications.....	28
temperature testing.....	157
Temperature testing instructions.....	157
Temperature testing procedure.....	157
Touch screen calibration.....	172

U

UL certification.....	269
-----------------------	-----

Uninterruptible power supply.....	276
Upgrade	
BIOS.....	226
Firmware.....	229
Upgrade information.....	226
UPS.....	276
Changing the battery settings.....	256
Changing the shutdown time.....	259
Changing the UPS shutdown time.....	260
Configuring UPS system settings.....	258
Displaying UPS default values.....	255
Installing the UPS service.....	255
Low battery shutdown.....	261
Overcurrent shutdown.....	261
power failure.....	261
Saving battery settings.....	258
Standard shutdown.....	261
Updating battery settings.....	257
UPS configuration.....	255
UPS configuration.....	255
UPS fuse kit.....	353, 353
USB cables.....	337
USB flash drive.....	308
USB media drive.....	312
user serial ID.....	252

V

Viewing angles.....	368
---------------------	-----

W

WES2009.....	243
WES7.....	246
Windows 7.....	238
Windows CE.....	248
Windows CE 6.0 features.....	248
Windows Embedded Standard 2009.....	243
Windows Embedded Standard 7.....	245
Windows XP Embedded.....	241
Windows XP Professional.....	236