

Panel PC 700 with 945GME N270 CPU board

User's Manual

Version: **1.16 (March 2015)**

Model no.: **MAPPC700A-ENG**

All information contained in this manual is current as of its creation/publication. We reserve the right to change the contents of this manual without warning. The information contained herein is believed to be accurate as of the date of publication; however, Bernecker + Rainer Industrie-Elektronik Ges.m.b.H. makes no warranty, expressed or implied, with regard to the products or documentation contained within this manual. In addition, Bernecker + Rainer Industrie-Elektronik Ges.m.b.H. shall not be liable in the event of incidental or consequential damages in connection with or resulting from the furnishing, performance or use of these products. The software names, hardware names, and trademarks used in this manual are registered by the respective companies.





Chapter 1: General information

Chapter 2: Technical data

Chapter 3: Commissioning

Chapter 4: Software

Chapter 5: Standards and certifications

Chapter 6: Accessories



Chapter 7: Maintenance / Servicing

Appendix A

Figure index

Table index

Model number index

Index



Chapter 1: General information	19
1. Manual history	19
2. Safety notices	21
2.1 Intended use	21
2.2 Protection against electrostatic discharge	21
2.2.1 Packaging	21
2.2.2 Guidelines for proper ESD handling	21
2.3 Policy and procedures	22
2.4 Transport and storage	22
2.5 Installation	23
2.6 Operation	23
2.6.1 Protection against touching electrical parts	23
2.6.2 Environmental conditions - dust, humidity, aggressive gases	23
2.6.3 Programs, viruses, and dangerous programs	24
2.7 Environmentally-friendly disposal	24
2.7.1 Separation of materials	24
3. Organization of safety notices	25
4. Directives	25
5. Model numbers	26
5.1 System units	26
5.2 X945 CPU boards	27
5.3 Heat sink	27
5.4 Main memory	27
5.5 Drives	28
5.6 Interface options	28
5.7 Fan kits	28
5.8 Accessories	29
5.8.1 Batteries	29
5.8.2 Supply voltage connectors	29
5.8.3 CompactFlash cards	29
5.8.4 USB flash drives	30
5.8.5 Cables	30
5.8.6 Power supplies	32
5.8.7 External UPS	32
5.8.8 Ethernet PCI interface cards	33
5.8.9 Miscellaneous	33
5.9 Software	34
6. Typical topologies	36
6.1 Panel PC 700 for central control and visualization	36
 Chapter 2: Technical data	 37
1. Introduction	37
1.1 Features	38
1.2 System components / configuration	39
1.2.1 Selection guide - Basic system	40
1.2.2 Selection guide - Optional components	41

Table of contents

2. Entire device	42
2.1 Ambient temperature with X945 CPU board	42
2.1.1 Ambient temperatures with system unit 5PC720.1043-00	44
2.1.2 Ambient temperatures with system unit 5PC720.1043-01	45
2.1.3 Ambient temperatures with system unit 5PC720.1214-00	46
2.1.4 Ambient temperatures with system unit 5PC720.1214-01	47
2.1.5 Ambient temperatures with system unit 5PC720.1505-00	48
2.1.6 Ambient temperatures with system unit 5PC720.1505-01	49
2.1.7 Ambient temperatures with system unit 5PC720.1505-02	50
2.1.8 Ambient temperatures with system unit 5PC720.1706-00	51
2.1.9 Ambient temperatures with system unit 5PC720.1906-00	52
2.1.10 Ambient temperatures with system unit 5PC781.1043-00	53
2.1.11 Ambient temperatures with system unit 5PC781.1505-00	54
2.1.12 Ambient temperatures with system unit 5PC782.1043-00	55
2.1.13 How is the the maximum ambient temperature determined?	56
2.1.14 Temperature monitoring	56
2.2 Humidity specifications	57
2.3 Power management	58
2.3.1 Power calculation for 10.4" Panel PC 700	59
2.3.2 Power calculation for 12.1" Panel PC 700	60
2.3.3 Power calculation for 15" Panel PC 700	61
2.3.4 Power calculation for 17" Panel PC 700	62
2.3.5 Power calculation for 19" Panel PC 700	63
2.3.6 Power management obsolete	64
2.4 Device interfaces	71
2.4.1 Serial interface COM1	72
2.4.2 Serial interface COM2	73
2.4.3 Ethernet connection ETH1	74
2.4.4 Ethernet connection ETH2	76
2.4.5 USB ports	77
2.4.6 Supply voltage	78
2.4.7 Monitor / Panel interface	80
2.4.8 MIC, Line IN and Line OUT ports	81
2.4.9 Add-on interface slot	82
2.4.10 PCI slots	83
2.4.11 Status LEDs	84
2.4.12 CompactFlash slot (CF1)	85
2.4.13 Hard disk / CompactFlash slot (HDD/CF2)	86
2.4.14 Power button	87
2.4.15 Reset button	87
2.4.16 PS/2 keyboard / mouse	88
2.4.17 Battery	89
2.4.18 Hardware security key	91
2.4.19 Slide-in slot 1 drive slot	92
2.5 Serial number sticker	93
3. Individual components	95
3.1 System units	95

3.1.1 Panel PC 5PC720.1043-00	95
3.1.2 Panel PC 5PC720.1043-01	101
3.1.3 Panel PC 5PC720.1214-00	107
3.1.4 Panel PC 5PC720.1214-01	113
3.1.5 Panel PC 5PC720.1505-00	119
3.1.6 Panel PC 5PC720.1505-01	125
3.1.7 Panel PC 5PC720.1505-02	131
3.1.8 Panel PC 5PC720.1706-00	137
3.1.9 Panel PC 5PC720.1906-00	143
3.1.10 Panel PC 5PC781.1043-00	149
3.1.11 Panel PC 5PC781.1505-00	155
3.1.12 Panel PC 5PC782.1043-00	161
3.2 X945 CPU boards	167
3.3 Heat sink	169
3.4 Main memory	170
3.4.1 Technical data	170
3.5 Drives	171
3.5.1 Add-on Solid State Drive 128 GB 24x7 ET - 5AC600.SSDI-00	171
3.5.2 Replacement Solid State Drive 128 GB 24x7 ET - 5MMSSD.0128-00	175
3.5.3 Add-on hard disk 40 GB - 5AC600.HDDI-05	179
3.5.4 Add-on hard disk 80 GB 24x7 ET - 5AC600.HDDI-06	182
3.5.5 Add-on CompactFlash slot - 5AC600.CFSI-00	185
3.5.6 Slide-in USB FDD - 5AC600.FDDS-00	186
3.6 RAID system	189
3.6.1 PCI SATA RAID 2 x 160 GB 24x7 ET - 5ACPCI.RAIC-03	190
3.6.2 Replacement SATA HDD 160 GB - 5ACPCI.RAIC-04	195
3.6.3 PCI SATA RAID 2 x 250 GB - 5ACPCI.RAIC-05	198
3.6.4 Replacement SATA HDD 250 GB - 5MMHDD.0250-00	202
3.7 Interface options	205
3.7.1 Add-on CAN interface - 5AC600.CANI-00	205
3.7.2 Add-on RS232/422/485 interface - 5AC600.485I-00	209
3.8 Fan kits	214
3.8.1 Fan kit 5PC700.FA00-01	214
3.8.2 Fan kit 5PC700.FA02-00	215
3.8.3 Fan kit 5PC700.FA02-01	217
Chapter 3: Commissioning	219
1. Installation	219
1.1 Important mounting information	220
1.2 Air circulation	221
1.3 Mounting orientation	222
2. Cable connections	223
2.1 Ethernet cable lengths for ETH1	223
3. Grounding concept	224
4. Touch screen calibration	225
4.1 Windows XP Professional	225

Table of contents

4.2 Windows CE	225
4.3 Windows XP embedded	225
4.4 Automation Runtime / Visual Components	225
5. Connection examples	226
5.1 An analog CRT device on the monitor/panel connector	227
5.1.1 Basic system requirements	227
5.1.2 BIOS settings	227
6. Connection of USB peripheral devices	228
6.1 Locally on the PPC700	228
7. Configuration of a SATA RAID array	229
7.1 Create RAID set	230
7.2 Create RAID set - Striped	231
7.3 Create RAID set - Mirrored	232
7.4 Delete RAID set	233
7.5 Rebuild mirrored set	234
7.6 Resolve conflicts	235
7.7 Low level format	236
8. Key and LED configurations	237
8.1 Panel PC 10.4" TFT	238
8.1.1 Panel PC 5PC781.1043-00	238
8.1.2 Panel PC 5PC782.1043-00	239
8.2 Panel PC 15" TFT	240
8.2.1 Panel PC 5PC781.1505-00	240
9. User tips for increasing the display lifespan	241
9.1 Backlight	241
9.1.1 How can the lifespan of backlights be extended?	241
9.2 Image sticking	241
9.2.1 What causes image sticking?	241
9.2.2 How can image sticking be avoided?	241
10. Pixel error	242
11. General instructions for performing temperature tests	242
11.1 Procedure	242
11.2 Evaluating the temperatures in Windows operating systems	243
11.2.1 Evaluation using B&R Control Center	243
11.2.2 Evaluation using the BurnIn tool from Passmark	244
11.3 Evaluating the temperatures in an operating system other than Windows	246
11.4 Evaluating the measurement results	246
11.4.1 Example using an APC810 2-slot	247
12. Known problems / issues	247
Chapter 4: Software	249
1. BIOS options	249
1.1 General Information	249
1.2 BIOS setup and boot procedure	249
1.2.1 BIOS setup keys	250
1.3 Main	252

1.4 Advanced	253
1.4.1 ACPI configuration	254
1.4.2 PCI Configuration	256
1.4.3 Graphics configuration	260
1.4.4 CPU configuration	262
1.4.5 Chipset configuration	264
1.4.6 I/O interface configuration	266
1.4.7 Clock Configuration	267
1.4.8 IDE Configuration	268
1.4.9 USB configuration	274
1.4.10 Keyboard/mouse configuration	276
1.4.11 Remote access configuration	277
1.4.12 CPU board monitor	279
1.4.13 Main Board/Panel Features	280
1.5 Boot	285
1.6 Security	287
1.6.1 Hard disk security user password	288
1.6.2 Hard disk security master password	289
1.7 Power	290
1.8 Exit	292
1.9 BIOS default settings	293
1.9.1 Main	294
1.9.2 Advanced	294
1.9.3 Boot	301
1.9.4 Security	302
1.9.5 Power	302
1.10 BIOS Error signals (beep codes)	304
1.10.1 BIOS X945	304
1.11 Distribution of resources	305
1.11.1 RAM address assignment	305
1.11.2 DMA channel assignment	305
1.11.3 I/O address assignment	306
1.11.4 Interrupt assignments in PCI mode	307
1.11.5 Interrupt assignments in APIC mode	308
1.11.6 Inter-IC (I ² C) bus	309
1.11.7 System Management (SM) bus	310
2. Upgrade information	311
2.1 BIOS upgrade	311
2.1.1 What information do I need?	311
2.1.2 Upgrade BIOS for X945	314
2.1.3 Windows XP Embedded and BIOS upgrade	315
2.2 Upgrading the firmware	316
2.2.1 Procedure	316
2.2.2 Possible upgrade problems and version dependencies	318
2.3 Creating an MS-DOS boot diskette in Windows XP	321
2.4 Creating a bootable USB flash drive for B&R upgrade files	323
2.4.1 Requirements	323

Table of contents

2.4.2 Procedure	323
2.4.3 Where do I get MS-DOS?	324
2.5 Creating a bootable CompactFlash card for B&R upgrade files	325
2.5.1 Requirements	325
2.5.2 Procedure	325
2.5.3 Where do I get MS-DOS?	326
2.6 Upgrade problems	326
3. Panel PC 700 with Automation Runtime	327
3.1 ARwin	327
3.2 ARemb	327
4. Panel PC 700 with Windows XP Professional	328
4.1 Installation	329
4.1.1 Installation auf PCI SATA RAID Controller - 5ACPCI.RAIC-03, 5ACPCI.RAIC-05	329
4.2 Drivers	329
5. Panel PC 700 mit Windows 7	330
5.1 Installation	330
5.1.1 Installation on PCI SATA RAID controller - 5ACPCI.RAIC-03, 5ACPCI.RAIC-05	330
5.2 Drivers	331
5.3 Special considerations, limitations:	331
6. Panel PC 700 with Windows XP Embedded	332
6.1 General Information	332
6.2 Features with FP2007 (Feature Pack 2007)	332
6.3 Installation	333
6.4 Touch screen driver	333
7. Panel PC 700 with Windows Embedded Standard 2009	334
7.1 General Information	334
7.2 Features mit WES2009 (Windows Embedded Standard 2009)	335
7.3 Installation	336
7.4 Drivers	336
7.4.1 Touch screen driver	336
8. Panel PC 700 with Windows Embedded Standard 7	337
8.1 General Information	337
8.2 Features with WES7 (Windows Embedded Standard 7)	338
8.3 Installation	339
8.4 Drivers	339
8.4.1 Touch screen driver	339
9. Panel PC 700 with Windows CE	340
9.1 General Information	340
9.2 Windows CE 6.0 features	340
9.3 Requirements	341
9.4 Installation	341
9.4.1 B&R Embedded OS Installer	341
10. B&R Automation Device Interface (ADI) driver - Control Center	342
10.1 Functions	343
10.2 Installation	344
10.3 SDL Equalizer Einstellung	345

Chapter 5: Standards and certifications	347
1. Applicable European directives	347
2. Overview of standards	347
3. Emission requirements	349
3.1 Network-related emissions	350
3.2 Emissions, electromagnetic emissions	351
4. Requirements for immunity to disturbances	352
4.1 Electrostatic discharge (ESD)	353
4.2 High-frequency electromagnetic fields (HF field)	353
4.3 High-speed transient electrical disturbances (burst)	354
4.4 Surges	354
4.5 Conducted disturbances	354
4.6 Magnetic fields with electrical frequencies	355
4.7 Voltage dips, fluctuations and short-term interruptions	356
4.8 Damped vibration	356
5. Mechanical conditions	357
5.1 Vibration operation	357
5.2 Vibration during transport (packaged)	358
5.3 Shock during operation	358
5.4 Shock during transport (packaged)	358
5.5 Toppling	358
5.6 Free fall (packaged)	359
6. Climate conditions	360
6.1 Worst case operation	360
6.2 Dry heat	360
6.3 Dry cold	360
6.4 Large temperature fluctuations	361
6.5 Temperature fluctuations in operation	361
6.6 Humid heat, cyclic	361
6.7 Humid heat, constant (storage)	361
7. Safety	362
7.1 Ground resistance	362
7.2 Insulation resistance	362
7.3 High voltage	363
7.4 Residual voltage	363
7.5 Overload	363
7.6 Defective component	364
7.7 Voltage range	364
8. Other tests	365
8.1 Protection	365
9. SDL flex cable - test description	366
9.1 Torsion	366
9.1.1 Test structure	366
9.1.2 Test conditions	366
9.1.3 Individual tests	366
9.2 Cable drag chain	367
9.2.1 Test structure	367

Table of contents

9.2.2 Test conditions	367
9.2.3 Individual tests:	367
10. International certifications	368

Chapter 6: Accessories 369

1. Overview	369
2. Replacement CMOS batteries	374
2.1 Order data	374
2.2 Technical data	374
3. Supply voltage connector (TB103 3-pin)	375
3.1 General Information	375
3.2 Order data	375
3.3 Technical data	375
4. Power supplies	377
4.1 Model numbers and brief technical overview	378
4.1.1 Single-phase power supplies	378
4.1.2 Three-phase power supplies	378
5. External UPS	379
5.1 General Information	379
5.2 Order data	380
6. Interface covers 5AC600.ICOV-00	381
6.1 Order data	381
6.2 Contents of delivery	381
7. DVI - monitor adapter 5AC900.1000-00	382
7.1 Order data	382
8. USB port cap (attached) - Discontinued	383
8.1 Order data	383
8.2 Installation	383
9. USB port cap (attached)	384
9.1 Order data	384
10. CompactFlash cards 5CFCRD.xxxx-06	385
10.1 General information	385
10.2 Order data	385
10.3 Technical data	386
10.3.1 Temperature humidity diagram	388
10.4 Dimensions	388
10.5 Benchmark	389
11. CompactFlash cards 5CFCRD.xxxx-04	390
11.1 General Information	390
11.2 Order data	390
11.3 Technical data	391
11.3.1 Temperature humidity diagram	393
11.4 Dimensions	393
11.5 Benchmark	394
12. CompactFlash cards - 5CFCRD.xxxx-03	395
12.1 General Information	395

12.2 Order data	395
12.3 Technical data	396
12.3.1 Temperature humidity diagram	397
12.4 Dimensions	398
13. USB Media Drive - 5MD900.USB2-01	399
13.1 Features	399
13.2 Technical data	400
13.3 Dimensions	402
13.4 Dimensions with front cover	403
13.5 Cutout installation	403
13.6 Contents of delivery	404
13.7 Interfaces	404
13.8 Installation	404
13.8.1 Mounting orientation	404
13.9 Front cover 5A5003.03 for the USB Media Drive	405
13.9.1 Technical data	405
13.9.2 Dimensions	405
13.9.3 Installation	406
14. USB flash drive	407
14.1 General Information	407
14.2 Order data	407
14.3 Technical data - 5MMUSB.2048-00	408
14.3.1 Temperature humidity diagram	409
14.4 Technical data - 5MMUSB.2048-01	410
14.4.1 Temperature humidity diagram	411
15. HMI Drivers & Utilities DVD 5SWHMI.0000-00	412
16. Cables	417
16.1 DVI cable 5CADVI.0xxx-00	417
16.1.1 Order data	417
16.1.2 Technical data	418
16.1.3 Cable specifications	420
16.2 SDL cable 5CASDL.0xxx-00	420
16.2.1 Order data	421
16.2.2 Technical data	422
16.2.3 Cable specifications	424
16.3 SDL cable with 45° plug 5CASDL.0xxx-01	425
16.3.1 Order data	425
16.3.2 Technical data	426
16.3.3 Cable specifications	428
16.4 SDL flex cable 5CASDL.0xxx-03	429
16.4.1 Order data	429
16.4.2 Technical data	430
16.4.3 Cable specifications	433
16.5 SDL flex cable with extender 5CASDL.0xx0-13	434
16.5.1 Order data	434
16.5.2 Technical data	435
16.5.3 Cable connection	437

Table of contents

16.5.4 Cable specifications	438
16.6 RS232 cable 9A0014.xx	439
16.6.1 Order data	439
16.6.2 Technical data	439
16.6.3 Cable specifications	440
16.7 USB cable 5CAUSB.00xx-00	441
16.7.1 Order data	441
16.7.2 Technical data	441
16.7.3 Cable specifications	442
17. Legend strip templates	443
17.1 Order data	444
18. Replacement fan	445
18.1 5AC700.FA00-00	445
18.2 5AC700.FA02-00	445
19. SRAM module - 5AC600.SRAM-00	446
19.1 Technical data	446
19.2 Driver support	447
19.3 Installation	448
20. Ethernet PCI interface cards	449
20.1 PCI Ethernet card 10/100 - 5ACPCI.ETH1-01	449
20.1.1 Technical data	449
20.1.2 Driver support	450
20.1.3 Dimensions	450
20.2 PCI Ethernet card 10/100 - 5ACPCI.ETH3-01	451
20.2.1 Technical data	451
20.2.2 Driver support	452
20.2.3 Dimensions	452

Chapter 7: Maintenance / Servicing 453

1. Changing the battery	453
1.1 Battery check	453
1.2 Procedure	454
2. Fan kit installation and replacement	456
2.1 Procedure - PPC700 without PCI slots	456
2.2 Procedure - PPC700 with 1 and 2 PCI slots	459
3. Slide-in drive - installation and exchange	462
3.1 Installation procedure	462
3.2 Exchange procedure	464
4. Exchanging the legend strips	466
4.1 Procedure	466
5. Preventing after-image effect in LCD/TFT monitors	467
5.1 What measures can be taken against this?	467
6. Exchanging a PCI SATA RAID hard disk	468

Appendix A 471

1. Temperature sensor locations	471
---------------------------------------	-----

2. Maintenance Controller Extended (MTCX)	472
2.1 Temperature monitoring - Fan control	473
3. B&R Key Editor	474
4. B&R Automation Device Interface (ADI) development kit	476
5. B&R Automation Device Interface (ADI) .NET SDK	478
6. Touch Screen - Elo Accu Touch	480
6.1 Temperature humidity diagram	481
6.2 Cleaning	481
7. Touch Screen - AMT	482
7.1 Temperature humidity diagram	483
7.2 Cleaning	483
8. Membrane	484
9. Viewing angles	485
10. Glossary	486

Chapter 1 • General information

Information:

B&R works hard to keep the printed versions of its user's manuals as current as possible. However, any newer versions of the User's Manual can always be downloaded in electronic form (pdf) from the B&R homepage www.br-automation.com.

1. Manual history

Version	Date	Change
1.00	2009-11-23	- First version
1.05	2009-12-10	- Section 1 "Temperature sensor locations", on page 471 corrected. - Section 16 "Cables", on page 417 changed and corrected. - One item added to Section 12 "Known problems / issues", on page 247. - Depth dimensions corrected for the device 5PC720.1043-00.
1.06	2010-01-19	- One item removed from Section 12 "Known problems / issues", on page 247.
1.10	2010-09-20	- Chapter 5 "Standards and certifications", on page 347 updated. - Section 7 "Panel PC 700 with Windows Embedded Standard 2009", on page 334 added - Section 10 "B&R Automation Device Interface (ADI) driver - Control Center", on page 342 updated. - B&R ID codes for system units added. - Technical data "Remanent variables for AR (Automation Runtime) in Power Fail" added for the SRAM module 5AC600.SRAM-00. - B&R USB flash drive added to the chapter 6 "Accessories", on page 369. - Section 2 "Upgrade information", on page 330 updated. - Section 8 "Key and LED configurations", on page 237 in chapter 3 "Commissioning" added. - BIOS updated to V1.13.
1.11	2011-02-09	- BIOS updated to version 1.14. - The name "AR010" was changed to "ARwin". - The name "AR106" was changed to "ARemb". - "PCI SATA RAID 2 x 250 GB - 5ACPCI.RAIC-05", on page 198 updated. - "Replacement SATA HDD 250 GB - 5MMHDD.0250-00", on page 202 updated. - "Panel PC 700 mit Windows 7", on page 330 updated. - "Panel PC 700 with Windows Embedded Standard 7", on page 337 updated. - Section 10 "Pixel error", on page 242 updated. - Section 9 "Panel PC 700 with Windows CE", on page 340 changed.
1.12	2011-03-03	- The Windows Embedded Standard 7 Model number 5SWWI7.0729-ENG was corrected to 5SWWI7.0729-MUL.

Table 1: Manual history

General information • Manual history

Version	Date	Change
1.13	2011-06-15	<ul style="list-style-type: none"> - Information of Thermal Analysis Tool at page 42 corrected (V1.4 -> V3.8.1). - Chipset information in sections "X945 CPU boards", on page 167 and "Panel PC 700 with Windows CE", on page 340 corrected. - Connection information of "Slide-in slot 1 drive slot", on page 92 corrected. - 5SWWI7.0900-MUL in section "Panel PC 700 with Windows Embedded Standard 7", on page 337 added. - Sections <ul style="list-style-type: none"> "B&R Automation Device Interface (ADI) driver - Control Center", on page 342, "HMI Drivers & Utilities DVD 5SWHMI.0000-00", on page 412, "B&R Key Editor", on page 474 and "B&R Automation Device Interface (ADI) development kit", on page 476 updated. - Section "B&R Automation Device Interface (ADI) .NET SDK", on page 478 added. - Information of ARemb in section "Panel PC 700 with Automation Runtime", on page 327 added. - Informations about Windows XP Mode in "Features with WES7 (Windows Embedded Standard 7)", on page 338 corrected.
1.14	2011-07-21	<ul style="list-style-type: none"> - Sections "B&R Automation Device Interface (ADI) driver - Control Center", on page 342, "B&R Automation Device Interface (ADI) development kit", on page 476 and "B&R Automation Device Interface (ADI) .NET SDK", on page 478 updated. - „Information:“ to installation in sections "Panel PC 700 with Windows XP Professional", on page 328 and "Panel PC 700 mit Windows 7", on page 330 added. - 5CFCRD.016G-04 in table 41 "CompactFlash slot (CF1)", on page 85 and 42 "Hard disk / CompactFlash slot (HDD/CF2)", on page 86 added.
1.15	2013-04-24	<ul style="list-style-type: none"> - Replacement SSD drive "Replacement Solid State Drive 128 GB 24x7 ET - 5MMSSD.0128-00", on page 175 was added. - For "Add-on Solid State Drive 128 GB 24x7 ET - 5AC600.SSDI-00", on page 171, revision D was added. - The "CompactFlash cards 5CFCRD.xxxx-06", on page 385 were added. - Section "General instructions for performing temperature tests", on page 242 was added.
1.16	2015-03-12	<ul style="list-style-type: none"> - The technical data of the PPC700 system units was updated. - The revision E0 was added at the "Add-on Solid State Drive 128 GB 24x7 ET - 5AC600.SSDI-00", on page 171. - The revision E0 was added at the "Replacement Solid State Drive 128 GB 24x7 ET - 5MMSSD.0128-00", on page 175. - Section "Ground", on page 78 and "Grounding concept", on page 224 updated. - Added information about the discontinuation of support for the OS "Panel PC 700 with Windows XP Professional", on page 328.

Table 1: Manual history

2. Safety notices

2.1 Intended use

Programmable logic controllers (PLCs), operating and monitoring devices (industrial PCs, Power Panels, Mobile Panels, etc.), and B&R uninterruptible power supplies have been designed, developed, and manufactured for conventional use in industry. They were not designed, developed, and manufactured for any use involving serious risks or hazards that could lead to death, injury, serious physical damage or loss of any kind without the implementation of exceptionally stringent safety precautions. In particular, such risks and hazards include the use of these devices to monitor nuclear reactions in nuclear power plants, as well as flight control systems, flight safety, the control of mass transit systems, medical life support systems and the control of weapons systems.

2.2 Protection against electrostatic discharge

Electrical components that can be damaged by electrostatic discharge (ESD) must be handled accordingly.

2.2.1 Packaging

- Electrical components with housing
... do not require special ESD packaging, but must be handled properly (see "Electrical components with housing").
- Electrical components without housing
... must be protected by ESD-suitable packaging.

2.2.2 Guidelines for proper ESD handling

Electrical components with housing

- Do not touch the connector contacts on connected cables.
- Do not touch the contact tips on the circuit boards.

Electrical components without housing

In addition to "Electrical components with housing", the following also applies:

- Any persons handling electrical components or devices that will be installed in the electrical components must be grounded.
- Components can only be touched on the small sides or on the front plate.
- Components should always be stored in a suitable medium (ESD packaging, conductive foam, etc.).
Metallic surfaces are not suitable storage surfaces!

General information • Safety notices

- Electrostatic discharges should be avoided on the components (e.g. through charged plastics).
- A minimum distance of 10 cm must be kept from monitors and TV sets.
- Measurement devices and equipment must be grounded.
- Measurement probes on potential-free measurement devices must be discharged on sufficiently grounded surfaces before taking measurements.

Individual components

- ESD protective measures for individual components are thoroughly integrated at B&R (conductive floors, footwear, arm bands, etc.).

The increased ESD protective measures for individual components are not necessary for our customers for handling B&R products.

2.3 Policy and procedures

Electronic devices are never completely failsafe. In the event of a failure on the programmable control system, operating or monitoring device, or uninterruptible power supply, the user is responsible for ensuring that other devices that may be connected, e.g. motors, are in a secure state.

Both when using programmable logic controllers and when using operating and monitoring devices as control systems in conjunction with a soft PLC (e.g. B&R Automation Runtime or comparable products) or a slot PLC (e.g. B&R LS251 or comparable products), the safety precautions applying to industrial control systems (e.g. the provision of safety devices such as emergency stop circuits, etc.) must be observed in accordance with applicable national and international regulations. The same applies for all other devices connected to the system, such as drives.

All tasks such as installation, commissioning, and maintenance are only permitted to be carried out by qualified personnel. Qualified personnel are persons familiar with transport, mounting, installation, commissioning, and operation of the product who also have the respective qualifications (e.g. IEC 60364). National accident prevention guidelines must be followed.

The safety notices, connection descriptions (type plate and documentation) and limit values listed in the technical data are to be read carefully before installation and commissioning and must be observed.

2.4 Transport and storage

During transport and storage, devices must be protected against impermissible stress (mechanical loads, temperature, humidity, aggressive atmospheres, etc.).

2.5 Installation

- Installation must take place according to the documentation, using suitable equipment and tools.
- Devices must be installed by qualified personnel without voltage applied.
- General safety regulations and nationally applicable accident prevention guidelines must be observed.
- Electrical installation must be carried out according to the relevant guidelines (e.g. line cross section, fuse, protective ground connection).

2.6 Operation

2.6.1 Protection against touching electrical parts

To operate programmable logic controllers, operating and monitoring devices or uninterruptible power supplies, certain components must carry dangerous voltage levels of over 42 VDC. Touching one of these parts can result in a life-threatening electric shock. This could lead to death, severe injury or damage to equipment.

Before turning on the programmable logic controller, the operating and monitoring devices and the uninterruptible power supply, ensure that the housing is properly grounded (PE rail). The ground connection must be established when testing the operating and monitoring devices or the uninterruptible power supply, even when operating them for only a short time.

Before turning the device on, all parts that carry voltage must be securely covered. During operation, all covers must remain closed.

2.6.2 Environmental conditions - dust, humidity, aggressive gases

Use of operating and monitoring devices (e.g. industrial PCs, power panels, mobile panels, etc.) and uninterruptible power supplies in very dusty environments should be avoided. Dust collection on the devices influences their function and, especially in systems with active cooling (fans), sufficient cooling cannot be guaranteed.

The presence of aggressive gases in the environment can also lead to malfunctions. When combined with high temperature and humidity, aggressive gases - e.g. with sulfur, nitrogen and chlorine components - start chemical processes that can damage electronic components very quickly. Signs of the presence of aggressive gases are blackened copper surfaces and cable ends on existing installations.

For operation in dusty or humid conditions, correctly installed (cutout installation) operating and monitoring devices like Automation Panel or Power Panel are protected on the front side. The rear side of all devices must be protected from dust and humidity and must be cleaned at suitable intervals.

2.6.3 Programs, viruses, and dangerous programs

The system is subject to potential danger each time data is exchanged or software is installed from a data medium (e.g. diskette, CD-ROM, USB flash drive, etc.), a network connection, or the Internet. The user is responsible for assessing these dangers, implementing preventative measures such as virus protection programs, firewalls, etc. and obtaining software from reliable sources.

2.7 Environmentally-friendly disposal

All B&R programmable controllers, operating and monitoring devices, and uninterruptible power supplies are designed to inflict as little harm on the environment as possible.

2.7.1 Separation of materials

It is necessary to separate different materials so the device can undergo an environmentally-friendly recycling process.

Component	Disposal
Programmable logic controllers Operating and monitoring devices Uninterruptible power supply Cables	Electronics recycling
Cardboard box / paper packaging	Paper / cardboard recycling
Plastic packaging	Plastic recycling

Table 2: Environmentally-friendly separation of materials

Disposal must comply with the respective legal regulations.

3. Organization of safety notices

The safety notices in this manual are organized as follows:

Safety notice	Description
Danger!	Disregarding safety regulations and notices can be life-threatening.
Caution!	Disregarding safety regulations and notices can result in severe injury or substantial damage to equipment.
Warning!	Disregarding safety guidelines and notices can result in injury or damage to equipment.
Information:	Important information for preventing errors.

Table 3: Organization of safety notices

4. Directives

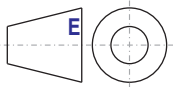

European dimension standards apply to all dimensions (e.g. dimension diagrams, etc.).

5. Model numbers

5.1 System units

Model number	Short description	Note
5PC720.1043-00	Panel PC 720 10.4" VGA T, 0 PCI slots 10.4" VGA color TFT display with touch screen (resistive); connections for 2 x RS232, 3 x USB 2.0, monitor, 2 x Ethernet 10/100, AC97 sound, PS/2 keyboard/mouse; IP65 protection (front side); 24 VDC. Plug for power supply must be ordered separately (screw clamps: 0TB103.9; cage clamp: 0TB103.91)	See page 95
5PC720.1043-01	Panel PC 720 10.4" VGA T, 2 PCI slots, 1 disk drive slot 10.4" VGA color TFT display with touch screen (resistive); 1 drive slot; connections for 2 x RS232, 3 x USB 2.0, monitor, 2 x Ethernet 10/100, AC97 sound, PS/2 keyboard/mouse; IP65 protection (front side); 24 VDC. Plug for power supply must be ordered separately (screw clamps: 0TB103.9; cage clamp: 0TB103.91)	See page 101
5PC720.1214-00	Panel PC 720 12.1" SVGA T, 0 PCI slots 12.1" SVGA color TFT display with touch screen (resistive); connections for 2 x RS232, 3 x USB 2.0, monitor, 2 x Ethernet 10/100, AC97 sound, PS/2 keyboard/mouse; IP65 protection (front side); 24 VDC. Plug for power supply must be ordered separately (screw clamps: 0TB103.9; cage clamp: 0TB103.91)	See page 107
5PC720.1214-01	Panel PC 720 12.1" SVGA T, 2 PCI slots, 1 disk drive slot 12.1" SVGA color TFT display with touch screen (resistive); 1 drive slot; connections for 2 x RS232, 3 x USB 2.0, monitor, 2 x Ethernet 10/100, AC97 sound, PS/2 keyboard/mouse; IP65 protection (front side); 24 VDC. Plug for power supply must be ordered separately (screw clamps: 0TB103.9; cage clamp: 0TB103.91)	See page 113
5PC720.1505-00	Panel PC 720 15" XGA T, 0 PCI slots 15" XGA color TFT display with touch screen (resistive); connections for 2 x RS232, 3 x USB 2.0, monitor, 2 x Ethernet 10/100, AC97 sound, PS/2 keyboard/mouse; IP65 protection (front side); 24 VDC. Plug for power supply must be ordered separately (screw clamps: 0TB103.9; cage clamp: 0TB103.91)	See page 119
5PC720.1505-01	Panel PC 720 15" XGA T, 2 PCI slots, 1 disk drive slot 15" XGA color TFT display with touch screen (resistive); 1 drive slot; connections for 2 x RS232, 3 x USB 2.0, monitor, 2 x Ethernet 10/100, AC97 sound, PS/2 keyboard/mouse; IP65 protection (front side); 24 VDC. Plug for power supply must be ordered separately (screw clamps: 0TB103.9; cage clamp: 0TB103.91)	See page 125
5PC720.1505-02	Panel PC 720 15" XGA T, 1 PCI slot, 1 disk drive slot 15" XGA color TFT display with touch screen (resistive); 1 drive slot; connections for 2 x RS232, 3 x USB 2.0, monitor, 2 x Ethernet 10/100, AC97 sound, PS/2 keyboard/mouse; IP65 protection (front side); 24 VDC. Plug for power supply must be ordered separately (screw clamps: 0TB103.9; cage clamp: 0TB103.91)	See page 131
5PC720.1706-00	Panel PC 720 17" SXGA T, 0 PCI slots 17" SXGA color TFT display with touch screen (resistive); connections for 2 x RS232, 3 x USB 2.0, monitor, 2 x Ethernet 10/100, AC97 sound, PS/2 keyboard/mouse; IP65 protection (front side); 24 VDC. Plug for power supply must be ordered separately (screw clamps: 0TB103.9; cage clamp: 0TB103.91)	See page 137 <i>Discontinued since 04/2009</i>
5PC720.1906-00	Panel PC 720 19" SXGA T, 0 PCI slots 19" SXGA color TFT display with touch screen (resistive); connections for 2 x RS232, 3 x USB 2.0, monitor, 2 x Ethernet 10/100, AC97 sound, PS/2 keyboard/mouse; IP65 protection (front side); 24 VDC. Plug for power supply must be ordered separately (screw clamps: 0TB103.9; cage clamp: 0TB103.91)	See page 143

Table 4: Model numbers - system units

Model number	Short description	Note
5PC781.1043-00	Panel PC 781 10.4" VGA FT, 0 PCI slots 10.4" VGA color TFT display with touch screen (resistive); 10 soft keys; 28 function keys and 20 system keys; connections for 2x RS232, 3x USB 2.0, monitor, 2x Ethernet 10/100, AC97 sound, PS/2 keyboard/mouse; IP65 protection (front side); 24 VDC. Plug for power supply must be ordered separately (screw clamps: 0TB103.9; cage clamp: 0TB103.91)	See page 149
5PC781.1505-00	Panel PC 781 15" XGA FT, 0 PCI slots 15" XGA color TFT display with touch screen (resistive); 12 soft keys; 20 function keys and 92 system keys; connections for 2x RS232, 3x USB 2.0, monitor, 2x Ethernet 10/100, AC97 sound, PS/2 keyboard/mouse; IP65 protection (front side); 24 VDC. Plug for power supply must be ordered separately (screw clamps: 0TB103.9; cage clamp: 0TB103.91)	See page 155
5PC782.1043-00	Panel PC 782 10.4" VGA FT, 0 PCI slots 10.4" VGA color TFT display with touch screen (resistive); 44 function keys and 20 system keys; connections for 2x RS232, 3x USB 2.0, monitor, 2x Ethernet 10/100, AC97 sound, PS/2 keyboard/mouse; IP65 protection (front side); 24 VDC. Plug for power supply must be ordered separately (screw clamps: 0TB103.9; cage clamp: 0TB103.91)	See page 161

Table 4: Model numbers - system units (Forts.)

5.2 X945 CPU boards

Model number	Short description	Note
5PC600.X945-00	X945 CPU board CPU board Intel Atom, 1,600 MHz, 533 MHz FSB, 512 KB L2 cache; 945GME chipset; 1 socket for an SO-DIMM DDR2 RAM module.	See page 167

Table 5: Model numbers - X945 CPU boards

5.3 Heat sink

Model number	Short description	Note
5AC700.HS01-03	Panel PC 700 heat sink 945GME 12.8 mm For PPC700 systems with 945GME CPU boards that have Atom 1,600 MHz processors.	See page 169

Table 6: Model numbers - Heat sinks

5.4 Main memory

Model number	Short description	Note
5MMDDR.0512-01	SO-DIMM DDR2 512MB PC2-5300	See page 170
5MMDDR.1024-01	SO-DIMM DDR2 1024MB PC2-5300	See page 170
5MMDDR.2048-01	SO-DIMM DDR2 2048MB PC2-5300	See page 170

Table 7: Model numbers - Main memory

5.5 Drives

Model number	Short description	Note
5AC600.SSDI-00	Add-on SSD 128 GB MLC 128 GB Solid State Drive SATA (MLC), add-on. For installation in an APC620 or PPC700.	see page 171
5MMSSD.0128-00	Replacement SSD 128 GB MLC 128 GB Solid State Drive SATA (MLC), replacement SSD for 5AC600.SSDI-00	see page 175
5AC600.HDDI-05	Add-on hard disk 40 GB ET, 24x7 40 GB hard disk (add-on); With extended temperature range and also ideal for 24 hour operation. For installation in an APC620 or PPC700.	See page 179
5AC600.HDDI-06	Add-on hard disk 80 GB ET, 24x7 80 GB hard disk (add-on); With extended temperature range and also ideal for 24 hour operation. For installation in an APC620 or PPC700.	See page 182
5AC600.CFSI-00	Add-on CompactFlash slot CompactFlash slot (add-on); for installation in an APC620 or PPC700.	See page 185
5AC600.FDDS-00	Slide-in USB FDD FDD drive (slide-in); for operation in a slide-in drive slot in an APC620 or PPC700 system.	See page 186
5ACPCI.RAIC-03	PCI SATA RAID system 2 x 160 GB 24x7, ET PCI Raid controller + 2 x 160 GB SATA hard disk; Suitable for 24 hour operation (24x7) as well as for operation in the extended temperature range (ET). Requires a free PCI slot.	See page 190
5ACPCI.RAIC-04	Replacement SATA-HDD 160 GB 1 piece Hard disk 160 GB SATA, replacement part for 5ACPCI.RAIC-03	See page 195
5ACPCI.RAIC-05	PCI RAID system SATA 2x250GB (M5400.6) PCI RAID controller + 2 x 250 GB SATA hard disks; requires a free PCI slot.	See page 198
5MMHDD.0250-00	Replacement SATA-HDD 250GB (M5400.6) Hard disk 250 GB SATA, replacement part for 5ACPCI.RAIC-03 and 5ACPCI.RAIC-05.	See page 202

Table 8: Model numbers - Drives

5.6 Interface options

Model number	Short description	Note
5AC600.CANI-00	Add-on CAN interface CAN interface for installation in an APC620 or PPC700.	See page 205
5AC600.485I-00	Add-on RS232/422/485 interface Add-on RS232/422/485 interface for installation in an APC620 and PPC700.	See page 209

Table 9: Model numbers - Interfaces

5.7 Fan kits

Model number	Short description	Note
5PC700.FA00-01	Panel PC 700 fan kit For Panel PC 700 10.4", 12.1", 15", 17" and 19" with 0 PCI slots (5PC720.1043-00, 5PC720.1214-00, 5PC720.1505-00, 5PC720.1706-00, 5PC720.1906-00, 5PC781.1043-00, 5PC781.1505-00 and 5PC782.1043-00).	See page 214
5PC700.FA02-00	Panel PC 700 fan kit For Panel PC 700 10.4" with 2 PCI slots (5PC720.1043-01).	See page 215

Table 10: Model numbers - Fan kits

Model number	Short description	Note
5PC700.FA02-01	Panel PC 700 fan kit For Panel PC 12.1" and 15" with 1 and 2 PCI slots (5PC720.1214-01, 5PC720.1505-01 and 5PC720.1505-02).	See page 217

Table 10: Model numbers - Fan kits

5.8 Accessories

5.8.1 Batteries

Model number	Short description	Note
0AC201.91	Lithium batteries, 4 pcs. Lithium batteries, 4 pcs., 3 V / 950 mAh, button cell	See page 374
4A0006.00-000	Lithium battery, 1 pc. Lithium battery, 1 pc., 3 V / 950 mAh, button cell	See page 374

Table 11: Model numbers - Batteries

5.8.2 Supply voltage connectors

Model number	Short description	Note
0TB103.9	Plug 24V 5.08 3-pin screw clamp 24 VDC 3-pin connector, female. Screw clamp, 3.31 mm ² , protected against vibration by the screw flange.	See page 375
0TB103.91	Plug 24V 5.08 3-pin cage clamp 24 VDC 3-pin connector, female. Cage clamps, 3.31 mm ² , protected against vibration by the screw flange.	See page 375

Table 12: Model numbers - Supply voltage connectors

5.8.3 CompactFlash cards

Model number	Short description	Note
5CFCRD.0512-06	CompactFlash 512 MB B&R CompactFlash card with 512 MB SLC NAND flash and IDE/ATA interface	see page 385
5CFCRD.1024-06	CompactFlash 1024 MB B&R CompactFlash card with 1024 MB SLC NAND flash and IDE/ATA interface	see page 385
5CFCRD.2048-06	CompactFlash 2048 MB B&R CompactFlash card with 2048 MB SLC NAND flash and IDE/ATA interface	see page 385
5CFCRD.4096-06	CompactFlash 4096 MB B&R CompactFlash card with 4096 MB SLC NAND flash and IDE/ATA interface	see page 385
5CFCRD.8192-06	CompactFlash 8192 MB B&R CompactFlash card with 8192 MB SLC NAND flash and IDE/ATA interface	see page 385
5CFCRD.016G-06	CompactFlash 16 GB B&R CompactFlash card with 16 GB SLC NAND flash and IDE/ATA interface	see page 385
5CFCRD.032G-06	CompactFlash 32 GB B&R CompactFlash card with 32 GB SLC NAND flash and IDE/ATA interface	see page 385

Table 13: Model numbers - CompactFlash cards

General information • Model numbers

Model number	Short description	Note
5CFCRD.0512-04	CompactFlash 512 MB B&R CompactFlash card with 512 MB SLC NAND flash and IDE/ATA interface	See page 390
5CFCRD.1024-04	CompactFlash 1024 MB B&R CompactFlash card with 1024 MB SLC NAND flash and IDE/ATA interface	See page 390
5CFCRD.2048-04	CompactFlash 2048 MB B&R CompactFlash card with 2048 MB SLC NAND flash and IDE/ATA interface	See page 390
5CFCRD.4096-04	CompactFlash 4096 MB B&R CompactFlash card with 4096 MB SLC NAND flash and IDE/ATA interface	See page 390
5CFCRD.8192-04	CompactFlash 8192 MB B&R CompactFlash card with 8192 MB SLC NAND flash and IDE/ATA interface	See page 390
5CFCRD.016G-04	CompactFlash 16 GB B&R CompactFlash card with 16 GB SLC NAND flash and IDE/ATA interface	See page 390
5CFCRD.0064-03	CompactFlash 64 MB SSI CompactFlash card with 64 MB SLC NAND flash and IDE/ATA interface	See page 395
5CFCRD.0128-03	CompactFlash 128 MB SSI CompactFlash card with 128 MB SLC NAND flash and IDE/ATA interface	See page 395
5CFCRD.0256-03	CompactFlash 256 MB SSI CompactFlash card with 256 MB SLC NAND flash and IDE/ATA interface	See page 395
5CFCRD.0512-03	CompactFlash 512 MB SSI CompactFlash card with 512 MB SLC NAND flash and IDE/ATA interface	See page 395
5CFCRD.1024-03	CompactFlash 1024 MB SSI CompactFlash card with 1024 MB SLC NAND flash and IDE/ATA interface	See page 395
5CFCRD.2048-03	CompactFlash 2048 MB SSI CompactFlash card with 2048 MB SLC NAND flash and IDE/ATA interface	See page 395
5CFCRD.4096-03	CompactFlash 4096 MB SSI CompactFlash card with 4096 MB SLC NAND flash and IDE/ATA interface	See page 395
5CFCRD.8192-03	CompactFlash 8192 MB SSI CompactFlash card with 8192 MB SLC NAND flash and IDE/ATA interface	See page 395

Table 13: Model numbers - CompactFlash cards (Forts.)

5.8.4 USB flash drives

Model number	Short description	Note
5MMUSB.2048-00	USB flash drive 2 GB SanDisk USB 2.0 flash drive 2 GB	See page 407
5MMUSB.2048-01	USB flash drive 2 GB B&R USB 2.0 flash drive 2 GB	See page 407

Table 14: Model numbers - USB flash drives

5.8.5 Cables

Model number	Short description	Note
5CADVI.0018-00	DVI-D cable 1.8 m Single cable, DVI-D/m:DVI-D/m; length: 1.8 m	See page 417

Table 15: Model numbers - Cables

Model number	Short description	Note
5CADVI.0050-00	DVI-D cable 5 m Single cable, DVI-D/m:DVI-D/m; length: 5 m	See page 417
5CADVI.0100-00	DVI-D cable 10 m Single cable, DVI-D/m:DVI-D/m; length: 10 m	See page 417
5CASDL.0018-00	SDL cable 1.8 m SDL cable for a fixed type of layout; length: 1.8 m	See page 420
5CASDL.0018-01	SDL cable 1.8 m 45° SDL cable for fixed type of layout with one-sided 45° plug; length: 1.8 m	See page 425
5CASDL.0018-03	SDL flex cable 1.8 m SDL cable for fixed and flexible type of layout; length: 1.8 m	See page 429
5CASDL.0050-00	SDL cable 5 m SDL cable for a fixed type of layout; length: 5 m	See page 420
5CASDL.0050-01	SDL cable 5 m 45° SDL cable for fixed type of layout with one-sided 45° plug; length: 5 m	See page 425
5CASDL.0050-03	SDL flex cable 5 m SDL cable for fixed and flexible type of layout; length: 5 m	See page 429
5CASDL.0100-00	SDL cable 10 m SDL cable for a fixed type of layout; length: 10 m	See page 420
5CASDL.0100-01	SDL cable 10 m 45° SDL cable for fixed type of layout with one-sided 45° plug; length: 10 m	See page 425
5CASDL.0100-03	SDL flex cable 10 m SDL cable for fixed and flexible type of layout; length: 10 m	See page 429
5CASDL.0150-00	SDL cable 15 m SDL cable for a fixed type of layout; length: 15 m	See page 420
5CASDL.0150-01	SDL cable 15 m 45° SDL cable for fixed type of layout with one-sided 45° plug; length: 15 m	See page 425
5CASDL.0150-03	SDL flex cable 15 m SDL cable for fixed and flexible type of layout; length: 15 m	See page 429
5CASDL.0200-00	SDL cable 20 m SDL cable for a fixed type of layout; length: 20 m	See page 420
5CASDL.0200-03	SDL flex cable 20 m SDL cable for fixed and flexible type of layout; length: 20 m	See page 429
5CASDL.0250-00	SDL cable 25 m SDL cable for a fixed type of layout; length: 25 m	See page 420
5CASDL.0250-03	SDL flex cable 25 m SDL cable for fixed and flexible type of layout; length: 25 m	See page 429
5CASDL.0300-00	SDL cable 30 m SDL cable for a fixed type of layout; length: 30 m	See page 420
5CASDL.0300-03	SDL flex cable 30 m SDL cable for fixed and flexible type of layout; length: 30 m	See page 429
5CASDL.0300-13	SDL flex cable with extender 30 m SDL cable with extender for fixed and flexible type of layout; length: 30 m	See page 434
5CASDL.0400-13	SDL flex cable with extender 40 m SDL cable with extender for fixed and flexible type of layout; length: 40 m	See page 434
5CAUSB.0018-00	USB 2.0 cable, A/m:B/m 1.8 m USB 2.0 connection cable; plug type A - type B; length 1.8 m	See page 441

Table 15: Model numbers - Cables (Forts.)

General information • Model numbers

Model number	Short description	Note
5CAUSB.0050-00	USB 2.0 cable, A/m:B/m 5 m USB 2.0 connection cable; plug type A - type B; length 5 m	See page 441
9A0014.02	RS232 cable DB9/f:DB9/m 1.8 m RS232 extension cable for remote operation of a display unit with touch screen; length 1.8 m.	See page 439
9A0014.05	RS232 cable DB9/f:DB9/m 5 m RS232 extension cable for remote operation of a display unit with touch screen; length 5 m.	See page 439
9A0014.10	RS232 cable DB9/f:DB9/m 10 m RS232 extension cable for remote operation of a display unit with touch screen; length 10 m.	See page 439

Table 15: Model numbers - Cables (Forts.)

5.8.6 Power supplies

Model number	Short description	Note
0PS102.0	Power supply, 1-phase, 2.1 A 24 VDC power supply, 1-phase, 2.1 A, input 100-240 VAC, wide range, DIN rail mounting	See page 377
0PS104.0	Power supply, 1-phase, 4.2 A 24 VDC power supply, 1 phase, 4.2 A, input 115/230 VAC, auto select, DIN rail mounting	See page 377
0PS105.1	Power supply, 1-phase, 5 A 24 VDC power supply, 1 phase, 5 A, input 115/230 VAC, manual select, DIN rail mounting	See page 377
0PS105.2	Power supply, 1-phase, 5 A, redundant 24 VDC power supply, 1 phase, 5 A, redundant through parallel operation, input 115/230 VAC, manual select, DIN rail mounting	See page 377
0PS110.1	Power supply, 1-phase, 10 A 24 VDC power supply, 1 phase, 10 A, input 115/230 VAC, manual select, DIN rail mounting	See page 377
0PS110.2	Power supply, 1-phase, 10 A, redundant 24 VDC power supply, 1 phase, 10 A, redundant through parallel operation, input 115/230 VAC, manual select, DIN rail mounting	See page 377
0PS120.1	Power supply, 1-phase, 20 A 24 VDC power supply, 1 phase, 20 A, input 115/230 VAC, auto select, DIN rail mounting	See page 377
0PS305.1	Power supply, 3-phase, 5 A 24 VDC power supply, 3-phase, 5 A, input 400..500 VAC (3 phases), wide range, DIN rail mounting	See page 377
0PS310.1	Power supply, 3-phase, 10 A 24 VDC power supply, 3-phase, 10 A, input 400..500 VAC (3 phases), wide range, DIN rail mounting	See page 377
0PS320.1	Power supply, 3-phase, 20 A 24 VDC power supply, 3-phase, 20 A, input 400..500 VAC (3 phases), wide range, DIN rail mounting	See page 377
0PS340.1	Power supply, 3-phase, 40 A 24 VDC power supply, 3-phase, 40 A, input 400..500 VAC (3 phases), wide range, DIN rail mounting	See page 377

Table 16: Model numbers - Power supplies

5.8.7 External UPS

Model number	Short description	Note
9A0100.11	UPS 24 VDC 24 VDC input, 24 VDC output, serial interface	See page 379

Model number	Short description	Note
9A0100.14	UPS battery unit type B 24 V; 2.2 Ah; including battery cage	See page 379
9A0100.15	UPS battery unit type B (replacement part) 2 x 12 V; 2.2 Ah; for battery unit 9A0100.14	See page 379
9A0017.01	RS232 Null Modem Cable, 0.6 m To connect UPS and load system (9-pin DSUB socket - 9-pin DSUB socket)	See page 379
9A0017.02	RS232 Null Modem Cable, 1.8 m To connect UPS and load system (9-pin DSUB socket - 9-pin DSUB socket)	See page 379

5.8.8 Ethernet PCI interface cards

Model number	Short description	Note
5ACPCI.ETH1-01	PCI Ethernet card 10/100 half size PCI Ethernet card, 1 Ethernet connection	See page 449
5ACPCI.ETH3-01	PCI Ethernet card 10/100 3port half size PCI Ethernet card, 3 Ethernet connections	See page 449

Table 17: Model numbers for Ethernet PCI interface cards

5.8.9 Miscellaneous

Model number	Short description	Note
5AC600.ICOV-00	Interface covers Interface covers for APC620 and PPC700 devices; 5 pieces	See page 381
5AC900.1000-00	Adapter DVI-A/m to CRT DB15HD/f Adapter DVI (plug) to CRT (socket), for connecting a standard monitor to a DVI-I interface.	See page 382
5AC900.104X-00	Legend strip template 10.4" portrait format For Panel PC 5PC781.1043-00. For 1 device.	See page 443
5AC900.104X-01	Legend strip template 10.4" landscape format For Panel PC 5PC782.1043-00. For 1 device.	See page 443
5AC900.150X-01	Legend strip template 15" For Panel PC 5PC781.1505-00. For 4 devices.	See page 443
5AC900.1200-00	USB port cap (attached) Front side USB port cover (attached) for Automation Panel 900 and Panel PC 700 devices.	See page 383 Discontinued
5AC900.1200-01	USB port cap IP65 M20 /2 Front-side USB port cap (attached) knurled, short, not slotted.	
5AC900.1200-02	USB port cap IP65 M20 /3 Front-side USB port cap (attached) knurled, tall, not slotted.	
5AC900.1200-03	USB port cap IP65 M20 /4 Front-side USB port cap (attached) knurled, tall, slotted.	
5MD900.USB2-01	USB 2.0 drive DVD-RW/CD-RW FDD CF USB USB 2.0 drive combination; consists of DVD-R/RW DVD+R/RW, FDD, CompactFlash slot (type II), USB connection (type A front, type B back); 24V DC; (Order 0TB103.9 screw clamp or 0TB103.91 cage clamps separately).	See page 399
5A5003.03	Front cover Front cover for the USB 2.0 Media Drive 5MD900.USB2-01.	See page 405

Table 18: Model numbers - Other items

General information • Model numbers

Model number	Short description	Note
5AC600.SRAM-00	APC620/PPC700 SRAM module 512kB 512 KB SRAM module for APC620 and PPC700.	See page 446
5AC700.FA00-00	PPC700 replacement fan filter 0PCI 5 piece For Panel PC 700 10.4", 12.1", 15", 17" and 19" with 0 PCI slots (5PC720.1043-00, 5PC720.1214-00, 5PC720.1505-00, 5PC720.1706-00, 5PC720.1906-00, 5PC781.1043-00, 5PC781.1505-00 and 5PC782.1043-00).	See page 445
5AC700.FA02-00	PPC700 replacement fan filter 1.2PCI 5 piece For Panel PC 700 10.4" and 15" with 1 and 2 PCI slots (5PC720.1043-01, 5PC720.1214-01, 5PC720.1505-01 and 5PC720.1505-02).	See page 445
5SWHMI.0000-00	HMI Drivers & Utilities DVD	See page 412

Table 18: Model numbers - Other items (Forts.)

5.9 Software

Model number	Short description	Note
9S0000.01-010	OEM MS-DOS 6.22 German (disk) OEM MS-DOS 6.22 German disks Only delivered with a new industrial PC.	
9S0000.01-020	OEM MS-DOS 6.22 English (disk) OEM MS-DOS 6.22 English disks Only delivered with a new industrial PC.	
5SWWXP.0600-GER	WinXP Professional with SP3, GER Microsoft OEM Windows XP Professional Service Pack 3, CD, German. Only available with a new device.	See page 328
5SWWXP.0600-ENG	WinXP Professional with SP3, ENG Microsoft OEM Windows XP Professional Service Pack 3, CD, English. Only available with a new device.	See page 328
5SWWXP.0600-MUL	WinXP Professional with SP3, MUL Microsoft OEM Windows XP Professional Service Pack 3, CD, multi-language. Only available with a new device.	See page 328
5SWWXP.0500-GER	WinXP Professional with SP 2c, GER Microsoft OEM Windows XP Professional Service Pack 2c, CD, German. Only available with a new device.	See page 328
5SWWXP.0500-ENG	WinXP Professional with SP 2c, ENG Microsoft OEM Windows XP Professional Service Pack 2c, CD, English. Only available with a new device.	See page 328
5SWWXP.0500-MUL	WinXP Professional with SP 2c, MUL Microsoft OEM Windows XP Professional Service Pack 2c, CD, multi-language. Only available with a new device.	See page 328
5SWWI7.0100-GER	Win7 Pro 32-bit DVD, GER Microsoft OEM Windows 7 Professional 32-bit, DVD, German. Only available with a new device.	See page 330
5SWWI7.0100-ENG	Win7 Pro 32-bit DVD, ENG Microsoft OEM Windows 7 Professional 32-bit, DVD, English. Only available with a new device.	See page 330
5SWWI7.0300-MUL	Win7 Ult 32-bit DVD, MUL Microsoft OEM Windows 7 Ultimate 32-bit, DVD, Multilanguage. Only available with a new device.	See page 330

Table 19: Model numbers - Software

Model number	Short description	Note
5SWWI7.0529-ENG	Windows Embedded Standard 7 PPC700 945GME Microsoft OEM Windows Embedded, Standard 7 32-bit, English; for PPC700 with CPU board, 5PC600.X945-00; order CompactFlash separately (at least 1 GB).	See page 337
5SWWI7.0729-MUL	Windows Embedded Standard 7 Premium PPC700 945GME Microsoft OEM Windows Embedded, Standard 7 Premium 32-bit, Multilanguage; for PPC700 with CPU board, 5PC600.X945-00; order CompactFlash separately (at least 1 GB).	See page 337
5SWWI7.0900-MUL	WES7P 32bit Language Pack DVD	See page 337
5SWWXP.0429-ENG	WinXPe FP2007 PPC700 945GME XTX Microsoft OEM Windows XP Embedded Feature Pack 2007, English; for PPC700 with CPU board 5PC600.X945-00; order CompactFlash separately (at least 512 MB).	See page 332
5SWWXP.0729-ENG	WES2009 PPC700 945GME Microsoft OEM Windows Embedded, Standard 2009, English; for PPC700 with CPU board, 5PC600.X945-00; order CompactFlash separately (at least 1 GB).	See page 334
5SWWCE.0829-ENG	WinCE6.0 Pro PPC700 945GME XTX Microsoft OEM Windows CE 6.0 Professional, English; for PPC700 with CPU board 5PC600.X945-00; order CompactFlash separately (at least 128 MB).	See page 340

Table 19: Model numbers - Software (Forts.)

6. Typical topologies

6.1 Panel PC 700 for central control and visualization

The control program runs on the Panel PC 700. The visualization project is integrated with Visual Components. The Panel PC 700 is networked over Ethernet TCP/IP; additional Power Panel-based operator terminals can also be connected via Ethernet. Communication to I/O systems with axes is handled via fieldbus systems (CAN, Ethernet POWERLINK™).

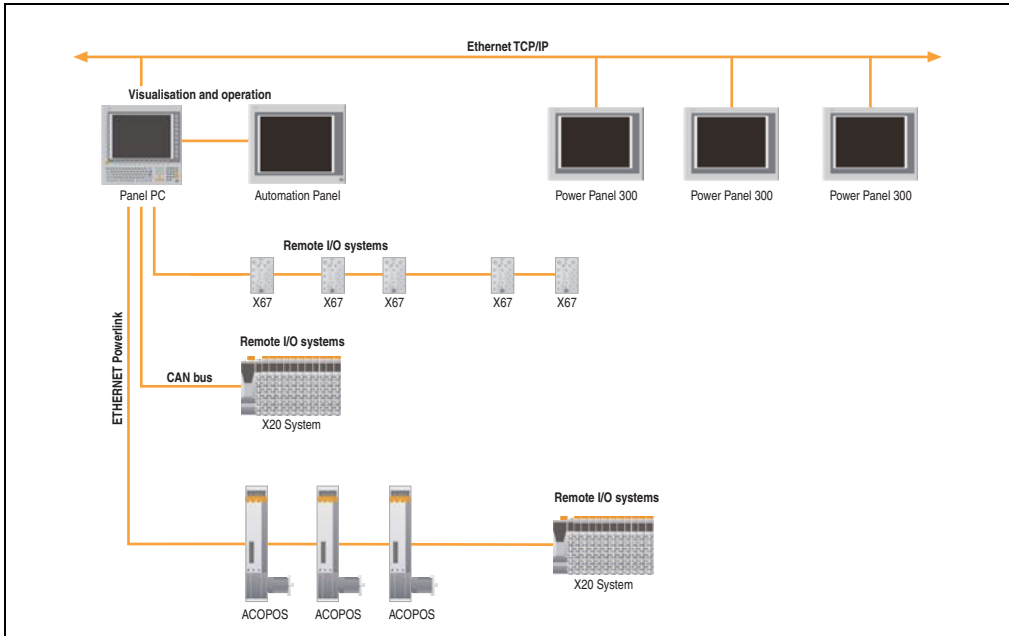

Figure 1: Typical topologies

Chapter 2 • Technical data

1. Introduction

The Panel PC 700 (PPC700) combines an industrial PC and display in one housing. This variant is the first choice anywhere a PC and display must be installed in a limited space.

The Panel PC 700 and the Automation PC 620 are technically based on the same platform. Panel PCs are available as touch devices with 10.4" VGA, 12.1" SVGA, 15" XGA, 17" SXGA and 19" SXGA TFT displays. The housing is also a defining factor: From very flat devices without PCI slots to expandable devices with two PCI slots, the Panel PC can be optimized to meet the requirements of the application. Four additional Automation Panel 900s can be connected to the Panel PC 700 (dual independent display).



1.1 Features

- Diagonals up to 19"
- Intel® Atom™ N270 1.6 GHz processor
- CompactFlash slot (type I)
- Half-size PCI slots (PCI standard 2.2, PCI bus speed 33 MHz)
- AC97 sound
- USB 2.0
- 24 VDC supply voltage
- 2 x Ethernet 10/100 Mbit interfaces
- 2x RS232 Interface, modem compatible
- PS/2 keyboard/mouse (combined)
- CAN add-on interface
- RS232/422/485 add-on interface
- Fan-free operation¹⁾
- BIOS
- Real-time clock, RTC (battery-buffered)
- Up to 2 GB main memory
- Optional SRAM module²⁾ battery backed

1) Dependent on the device configuration and the ambient temperature.

2) Installation depends on the revision of the system unit.

1.2 System components / configuration



The PPC700 system can be assembled to meet individual requirements and operating conditions.

The following components are absolutely essential for operation:

- System unit
- CPU board
- Heat sink (CPU board dependent)
- Main memory (CPU board dependent)
- Drive (mass memory such as CompactFlash card or hard disk) for the operating system
- Software

1.2.1 Selection guide - Basic system





Basic system configuration					
System unit	Select 1				
	10.4" Panel PC	12.1" Panel PC	15" Panel PC	17" Panel PC	19" Panel PC
A system unit consists of a housing, base board, and display Variants: PCI slots (0, 1 or 2) Slide-in slot (0 or 1) Example: 2 / 1 = 2 PCI, 1 slide-in slot	 5PC720.1043-00 (0 / 0) 5PC720.1043-01 (2 / 1) 5PC781.1043-00 (0 / 0) 5PC782.1043-00 (0 / 0)	 5PC720.1214-00 (0 / 0) 5PC720.1214-01 (2 / 1)	 5PC720.1505-00 (0 / 0) 5PC720.1505-01 (2 / 1) 5PC720.1505-02 (1 / 1) 5PC781.1505-00 (0 / 0)	 5PC720.1706-00 (0 / 0)	 5PC720.1906-00 (0 / 0)
CPU board - main memory - heat sink: Select one of each component					
CPU board	5PC600.X945-00				
Main memory	5MMDR.0512-01 - 512 MB 5MMDR.1024-01 - 1 GB 5MMDR.2048-01 - 2 GB				
Heat sink	5AC700.HS01-03				

Figure 2: Configuration - Basic system

Explanation:

- 1) Select a system unit.
- 2) Select CPU board (select 1).
- 3) Select the main memory (select 1).
- 4) Select a heat sink (select 1).
- 5) Select optional components, based on selected system unit (see section 1.2.2 "Selection guide - Optional components", on page 41).

1.2.2 Selection guide - Optional components









Optional configuration				
System unit	Select 1			
A system unit consists of a housing, base board, and display Variants: PCI slots (0, 1 or 2) Slide-in slot (0 or 1) Example: 2 / 1 = 2 PCI, 1 slide-in slot	0 PCI slots	1 PCI slot	2 PCI slots	
		5PC720.1043-00 (0 / 0) 5PC720.1214-00 (0 / 0) 5PC720.1505-00 (0 / 0) 5PC720.1706-00 (0 / 0) 5PC720.1906-00 (0 / 0) 5PC781.1043-00 (0 / 0) 5PC781.1505-00 (0 / 0) 5PC782.1043-00 (0 / 0)	5PC720.1505-02 (1 / 1)	5PC720.1043-01 (2 / 1) 5PC720.1214-01 (2 / 1) 5PC720.1505-01 (2 / 1)
	Fan kit (select 1)			
	A fan kit may be necessary for certain configurations.	 5PC700.FA00-01	 5PC700.FA02-01 (also for 5PC720.1505-01 and 5PC720.1214-01)	 5PC700.FA02-00 (only for 5PC720.1043-01)
	Add-on drive	Select 1		
	5AC600.SSDI-00 (128 GB SSD) 5AC600.HDDI-05 (40 GB Hard disk - 24-hour hard disk and expanded temperature range) 5AC600.CFSI-00 (CompactFlash slot)			
Slide-in drives	Not possible	Select max. 1		
	/	5AC600.FDDS-00 (USB floppy)		
RAID system	Not possible	Select max. 1		
	/	5ACPCL.RAIC-05 (2 x250 GB)		
Interface option	Select 1			
	5AC600.CANI-00 (CAN) 5AC600.485I-00 (combined RS232/RS422/RS485)			
Voltage supply connectors	Select 1			
	0TB103.9 (screw clamps) 0TB103.91 (cage clamps)			

Figure 3: Configuration of optional components

- Depending on the system unit, a compatible fan kit can be installed in the PPC700. Required for certain system configurations and ambient temperatures (see also section 2.1 "Ambient temperature with X945 CPU board", on page 42)
- Select optional drive(s) (add-on / slide-in), based on the system unit. One add-on drive can be installed in each system unit. A slide-in drive is only available in certain system units.
- An optional interface can be added using an add-on interface.
- The appropriate power supply plugs ensure simple connection to the power supply.

2. Entire device

2.1 Ambient temperature with X945 CPU board

It is possible to combine CPU boards with various components, such as drives, main memory, additional insert cards, etc. dependent on system unit and fan kit. The various configurations result in varying maximum possible ambient temperatures, which can be seen in the following graphic (see the figure).

Information:

The maximum specified ambient temperatures were determined under worst-case conditions.

Experience has shown that higher ambient temperatures can be reached under typical conditions, e.g. using Microsoft Windows. The testing and evaluation is to be done on-site by the user (temperatures can be read in BIOS or using the B&R Control Center, see the chapter 4 "Software").

Worst-case conditions for systems with an X945 CPU board

- Confidential Tool from Intel (Thermal Analysis Tool V3.8.1) for simulating 100% processor load.
- BurnIn testing tool (BurnIn V4.0 Pro from Passmark Software) to simulate a 100% load on the interface via loop-back adapters (serial interfaces, add-on and slide-in drives, USB ports, audio outputs)
- Maximum system extension and power consumption.

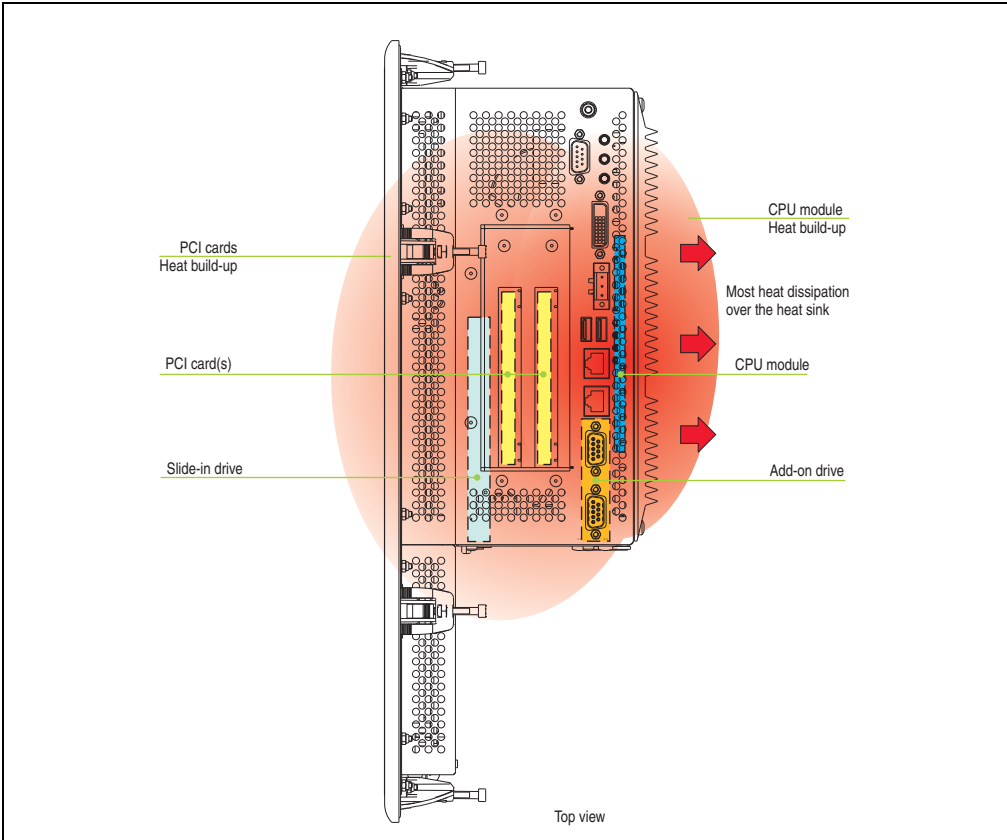

Figure 4: Example of worst-case conditions for temperature measurement

2.1.1 Ambient temperatures with system unit 5PC720.1043-00

Maximum ambient temperature

All temperatures in degrees Celsius (°C) at 500 meters NN

Derating the maximum ambient temperature typically 1°C per 1000 meters above 500 NN.

		① Without fan kit N270 5PC600.X945-00	① With fan kit N270 5PC600.X945-00		
		② Maximum ambient temperature		45	55
		What can still be operated at the maximum ambient temperature, or are there limits?			
③		↓		Temperature limits	Location of sensors
Add-on drive	Onboard CompactFlash ¹⁾	✓	✓	80	I/O
	5AC600.CFSI-00 ¹⁾	✓	✓	80	
	5AC600.HDDI-05	✓	✓	85	
	5AC600.HDDI-06	✓	✓	85	
	5AC600.SSDI-00 ≤ D0	✓	✓	75	
	5AC600.SSDI-00 ≥ E0	✓	✓	80	
Main memory	5MMDDR.0512-01	✓	✓	-	/
	5MMDDR.1024-01	✓	✓	-	
	5MMDDR.2048-01	✓	✓	-	
Other insert card interfaces	5AC600.CANI-00	✓	✓	-	/
	5AC600.485I-00	✓	✓	-	

¹⁾ Only possible in connection with CompactFlash cards 5CFCRD.xxxx-046, 5CFCRD.xxxx-04 and 5CFCRD.xxxx-03 available from B&R.

Figure 5: Ambient temperatures for 5PC720.1043-00 with an X945 CPU board

For a description of this image, see section 2.1.13 "How is the the maximum ambient temperature determined?".

Minimum ambient temperature

The minimum ambient temperature is 0°C.

2.1.2 Ambient temperatures with system unit 5PC720.1043-01

Maximum ambient temperature

All temperature values in degrees celsius (°C) at 500 meters above sea level

Derating of the maximum ambient temperature, generally 1°C per 1000 meters starting at 500 meters above sea level.

		①					
		Without fan kit	With fan kit				
		N270 5PC600.X945-00	N270 5PC600.X945-00				
② Maximum ambient temperature		45	55	Temperature limits		Location of sensor(s)	
What can also be operated at the max. ambient temperature, or are there limits? ↓							
③							
Add-on drive	On-board CompactFlash ¹⁾	✓	✓	80	I/O		
	5AC600.CFSI-00 ¹⁾	✓	✓	80			
	5AC600.HDDI-05	✓	✓	85			
	5AC600.HDDI-06	✓	✓	85			
	5AC600.SSDI-00 ≤ D0	✓	✓	75			
	5AC600.SSDI-00 ≥ E0	✓	✓	80			
Slide-in drive	5AC600.FDDS-00	30	35	50	Slide-in drive 1		
Main memory	5MMDDR.0512-01	✓	✓	-			
	5MMDDR.1024-01	✓	✓	-			
	5MMDDR.2048-01	✓	✓	-			
Additional insert cards Interfaces	5AC600.CANI-00	✓	✓	-			
	5AC600.485I-00	✓	✓	-			
	5ACPCI.RAIC-03 (24 hours / default)	✓	✓	-			
	5ACPCI.RAIC-05 (24 hours / default)	✓	50	-			

¹⁾ Only possible in connection with CompactFlash cards 5CFCRD.xxxx-06, 5CFCRD.xxxx-04 and 5CFCRD.xxxx-03 available from B&R.

Figure 6: Ambient temperatures for 5PC720.1043-01 with an X945 CPU board

For a description of this image, see section 2.1.13 "How is the the maximum ambient temperature determined?".

Minimum ambient temperature

For systems containing one of the following components, the minimum ambient temperature is +5°C: 5AC600.FDDS-00

If these components are not used, then the minimum ambient temperature is 0°C.

2.1.3 Ambient temperatures with system unit 5PC720.1214-00

Maximum ambient temperature

All temperatures in degrees Celsius (°C) at 500 meters NN

Derating the maximum ambient temperature typically 1°C per 1000 meters above 500 NN.

		① Without fan kit N270 5PC600.X945-00	① With fan kit N270 5PC600.X945-00		
② Maximum ambient temperature		45	55	Temperature limits	Location of sensors
What can still be operated at the maximum ambient temperature, or are there limits? ↓					
③ Add-on drive	Onboard CompactFlash ¹⁾	✓	✓	80	I/O
	5AC600.CFSI-00 ¹⁾	✓	✓	80	
	5AC600.HDDI-05	✓	✓	85	
	5AC600.HDDI-06	✓	✓	85	
	5AC600.SSDI-00 ≤ D0	✓	✓	75	
	5AC600.SSDI-00 ≥ E0	✓	✓	80	
Main memory	5MMDDR.0512-01	✓	✓	-	
	5MMDDR.1024-01	✓	✓	-	
	5MMDDR.2048-01	✓	✓	-	
Other insert card interfaces	5AC600.CANI-00	✓	✓	-	
	5AC600.485I-00	✓	✓	-	

¹⁾ Only possible in connection with CompactFlash cards 5CFCRD.xxxx-06, 5CFCRD.xxxx-04 and 5CFCRD.xxxx-03 available from B&R.

Figure 7: Ambient temperatures for 5PC720.1214-00 with an X945 CPU board

For a description of this image, see section 2.1.13 "How is the the maximum ambient temperature determined?".

Minimum ambient temperature

The minimum ambient temperature is 0°C.

2.1.4 Ambient temperatures with system unit 5PC720.1214-01

Maximum ambient temperature

All temperature values in degrees celsius (°C) at 500 meters above sea level

Derating of the maximum ambient temperature, generally 1°C per 1000 meters starting at 500 meters above sea level.

		① Without fan kit N270 5PC600.X945-00	① With fan kit N270 5PC600.X945-00		
② Maximum ambient temperature		45	55	Temperature limits	Location of sensor(s)
What can also be operated at the max. ambient temperature, or are there limits? ↓					
③ Add-on drive	On-board CompactFlash ¹⁾	✓	✓	80	I/O
	5AC600.CFSI-00 ¹⁾	✓	✓	80	
	5AC600.HDDI-05	✓	✓	85	
	5AC600.HDDI-06	✓	✓	85	
	5AC600.SSDI-00 ≤ D0	✓	✓	75	
	5AC600.SSDI-00 ≥ E0	✓	✓	80	
Slide-in drive	5AC600.FDDS-00	30	35	50	Slide-in drive 1
Main memory	5MMDDR.0512-01	✓	✓	-	/
	5MMDDR.1024-01	✓	✓	-	
	5MMDDR.2048-01	✓	✓	-	
Additional insert cards Interfaces	5AC600.CANI-00	✓	✓	-	/
	5AC600.485I-00	✓	✓	-	
	5ACPCI.RAIC-03 (24 hours / default)	✓	✓	-	
	5ACPCI.RAIC-05 (24 hours / default)	✓	50	-	

¹⁾ Only possible in connection with CompactFlash cards 5CFCRD.xxxx-06, 5CFCRD.xxxx-04 and 5CFCRD.xxxx-03 available from B&R.

Figure 8: Ambient temperatures for 5PC720.1214-01 with an X945 CPU board

For a description of this image, see section 2.1.13 "How is the the maximum ambient temperature determined?".

Minimum ambient temperature

For systems containing one of the following components, the minimum ambient temperature is +5°C: 5AC600.FDDS-00

If these components are not used, then the minimum ambient temperature is 0°C.

2.1.5 Ambient temperatures with system unit 5PC720.1505-00

Maximum ambient temperature

All temperatures in degrees Celsius (°C) at 500 meters NN

Derating the maximum ambient temperature typically 1°C per 1000 meters above 500 NN.

		① Without fan kit	① With fan kit		
		N270 5PC600.X945-00	N270 5PC600.X945-00		
② Maximum ambient temperature		45	50	Temperature limits	Location of sensors
What can still be operated at the maximum ambient temperature, or are there limits?					
③ Add-on drive	Onboard CompactFlash ¹⁾	✓	✓	80	I/O
	5AC600.CFSI-00 ¹⁾	✓	✓	80	
	5AC600.HDDI-05	✓	✓	85	
	5AC600.HDDI-06	✓	✓	85	
	5AC600.SSDI-00 ≤ D0	✓	✓	75	
	5AC600.SSDI-00 ≥ E0	✓	✓	80	
Main memory	5MMDDR.0512-01	✓	✓	-	
	5MMDDR.1024-01	✓	✓	-	
	5MMDDR.2048-01	✓	✓	-	
Other insert card interfaces	5AC600.CANI-00	✓	✓	-	
	5AC600.485I-00	✓	✓	-	

③

②

①

①

Temperature limits

Location of sensors

I/O

1) Only possible in connection with CompactFlash cards 5CFCRD.xxxx-06, 5CFCRD.xxxx-04 and 5CFCRD.xxxx-03 available from B&R.

Figure 9: Ambient temperatures for 5PC720.1505-00 with an X945 CPU board

For a description of this image, see section 2.1.13 "How is the the maximum ambient temperature determined?".

Minimum ambient temperature

The minimum ambient temperature is 0°C.

2.1.6 Ambient temperatures with system unit 5PC720.1505-01

Maximum ambient temperature

All temperature values in degrees celsius (°C) at 500 meters above sea level

Derating of the max. ambient temperature, generally 1°C per 1000 meters starting at 500 meters above sea level.

		① Without fan kit	① With fan kit		
		N270 5PC600.X945-00	N270 5PC600.X945-00		
② Maximum ambient temperature		45	50	Temperature limits	Location of sensor(s)
What can also be operated at the max. ambient temperature, or are there limits?					
③ Add-on drive	On-board CompactFlash ¹⁾	✓	✓	80	I/O
	5AC600.CFSI-00 ¹⁾	✓	✓	80	
	5AC600.HDDI-05	✓	✓	85	
	5AC600.HDDI-06	✓	✓	85	
	5AC600.SSDI-00 ≤ D0	✓	✓	75	
	5AC600.SSDI-00 ≥ E0	✓	✓	80	
Slide-in drive	5AC600.FDDS-00	30	35	50	Slide-in drive 1
Main memory	5MMDDR.0512-01	✓	✓	-	/
	5MMDDR.1024-01	✓	✓	-	
	5MMDDR.2048-01	✓	✓	-	
Additional insert cards Interfaces	5AC600.CANI-00	✓	✓	-	/
	5AC600.485I-00	✓	✓	-	
	5ACPCI.RAIC-03 (24 hours / default)	✓	✓	-	
	5ACPCI.RAIC-05 (24 hours / default)	✓	✓	-	

¹⁾ Only possible in connection with CompactFlash cards 5CFCRD.xxxx-06, 5CFCRD.xxxx-04 and 5CFCRD.xxxx-03 available from B&R.

Figure 10: Ambient temperatures for 5PC720.1505-01 with an X945 CPU board

For a description of this image, see section 2.1.13 "How is the the maximum ambient temperature determined?".

Minimum ambient temperature

For systems containing one of the following components, the minimum ambient temperature is +5°C: 5AC600.FDDS-00

If these components are not used, then the minimum ambient temperature is 0°C.

2.1.7 Ambient temperatures with system unit 5PC720.1505-02

Maximum ambient temperature

All temperature limits in degrees celsius (°C) at 500 meters above sea level

Derating of the maximum ambient temperature, generally 1°C per 1000 meters starting at 500 meters above sea level

		① Without fan kit N270 5PC600.X945-00	① With fan kit N270 5PC600.X945-00		
② Maximum ambient temperature		45	50	Temperature limits	Location of sensor(s)
What can also be operated at the max. ambient temperature, or are there limits? ↓					
③ Add-on drive	On-board CompactFlash ¹⁾	✓	✓	80	I/O
	5AC600.CFSI-00 ¹⁾	✓	✓	80	
	5AC600.HDDI-05	✓	✓	85	
	5AC600.HDDI-06	✓	✓	85	
	5AC600.SSDI-00 ≤ D0	✓	✓	75	
	5AC600.SSDI-00 ≥ E0	✓	✓	80	
Slide-in drive	5AC600.FDDS-00	30	35	50	Slide-in drive 1
Main memory	5MMDDR.0512-01	✓	✓	-	/
	5MMDDR.1024-01	✓	✓	-	
	5MMDDR.2048-01	✓	✓	-	
Additional insert cards Interfaces	5AC600.CANI-00	✓	✓	-	/
	5AC600.485I-00	✓	✓	-	
	5ACPCI.RAIC-03 (24 hours / default)	✓	✓	-	
	5ACPCI.RAIC-05 (24 hours / default)	✓	✓	-	

¹⁾ Only possible in connection with CompactFlash cards 5CFCRD.xxxx-06, 5CFCRD.xxxx-04 and 5CFCRD.xxxx-03 available from B&R.

Figure 11: Ambient temperatures for 5PC720.1505-02 with an X945 CPU board

For a description of this image, see section 2.1.13 "How is the the maximum ambient temperature determined?".

Minimum ambient temperature

For systems containing one of the following components, the minimum ambient temperature is +5°C: 5AC600.FDDS-00

If these components are not used, then the minimum ambient temperature is 0°C.

2.1.8 Ambient temperatures with system unit 5PC720.1706-00

Maximum ambient temperature

All temperatures in degrees Celsius (°C) at 500 meters NN

Derating the maximum ambient temperature typically 1°C per 1000 meters above 500 NN.

		① Without fan kit N270 5PC600.X945-00	① With fan kit N270 5PC600.X945-00		
② Maximum ambient temperature		40	40	Temperature limits	Location of sensors
What can still be operated at the maximum ambient temperature, or are there limits? ↓					
③ Add-on drive	Onboard CompactFlash ¹⁾	✓	✓	80	I/O
	5AC600.CFSI-00 ¹⁾	✓	✓	80	
	5AC600.HDDI-05	✓	✓	85	
	5AC600.HDDI-06	✓	✓	85	
	5AC600.SSDI-00 ≤ D0	✓	✓	75	
	5AC600.SSDI-00 ≥ E0	✓	✓	80	
Main memory	5MMDDR.0512-01	✓	✓	-	
	5MMDDR.1024-01	✓	✓	-	
	5MMDDR.2048-01	✓	✓	-	
Other insert card interfaces	5AC600.CANI-00	✓	✓	-	
	5AC600.485I-00	✓	✓	-	

¹⁾ Only possible in connection with CompactFlash cards 5CFCRD.xxxx-06, 5CFCRD.xxxx-04 and 5CFCRD.xxxx-03 available from B&R.

Figure 12: Ambient temperatures for 5PC720.1706-00 with an X945 CPU board

For a description of this image, see section 2.1.13 "How is the the maximum ambient temperature determined?".

Minimum ambient temperature

The minimum ambient temperature is 0°C.

2.1.9 Ambient temperatures with system unit 5PC720.1906-00

Maximum ambient temperature

Information:

The maximum ambient temperatures specified in the following figure are valid for 5PC720.1906-00 system units with a revision F0. In revisions \leq E0, the valid maximum ambient temperature is 5°C smaller than specified.

All temperatures in degrees Celsius (°C) at 500 meters NN
Derating the maximum ambient temperature typically 1°C per 1000 meters above 500 NN.

		① Without fan kit N270 5PC600.X945-00	① With fan kit N270 5PC600.X945-00		
② Maximum ambient temperature		45	45	Temperature limits	Location of sensors
What can still be operated at the maximum ambient temperature, or are there limits?					
③ ↓ Add-on drive	Onboard CompactFlash ¹⁾	✓	✓	80	I/O
	5AC600.CFSI-00 ¹⁾	✓	✓	80	
	5AC600.HDDI-05	✓	✓	85	
	5AC600.HDDI-06	✓	✓	85	
	5AC600.SSDI-00 \leq D0	✓	✓	75	
	5AC600.SSDI-00 \geq E0	✓	✓	80	
Main memory	5MMDDR.0512-01	✓	✓	-	
	5MMDDR.1024-01	✓	✓	-	
	5MMDDR.2048-01	✓	✓	-	
Other insert card interfaces	5AC600.CANI-00	✓	✓	-	
	5AC600.485I-00	✓	✓	-	

③ ↓

②

①

①

Temperature limits

Location of sensors

I/O

1) Only possible in connection with CompactFlash cards 5CFCRD.xxxx-06, 5CFCRD.xxxx-04 and 5CFCRD.xxxx-03 available from B&R.

Figure 13: Ambient temperatures for 5PC720.1906-00 with an X945 CPU board

For a description of this image, see section 2.1.13 "How is the the maximum ambient temperature determined?".

Minimum ambient temperature

The minimum ambient temperature is 0°C.

2.1.10 Ambient temperatures with system unit 5PC781.1043-00

Maximum ambient temperature

All temperatures in degrees Celsius (°C) at 500 meters NN

Derating the maximum ambient temperature typically 1°C per 1000 meters above 500 NN.

		① Without fan kit	① With fan kit		
		N270 5PC600.X945-00	N270 5PC600.X945-00		
② Maximum ambient temperature		45	55	Temperature limits	Location of sensors
What can still be operated at the maximum ambient temperature, or are there limits?					
③					
Add-on drive	Onboard CompactFlash ¹⁾	✓	✓	80	I/O
	5AC600.CFSI-00 ¹⁾	✓	✓	80	
	5AC600.HDDI-05	✓	✓	85	
	5AC600.HDDI-06	✓	✓	85	
	5AC600.SSDI-00 ≤ D0	✓	✓	75	
	5AC600.SSDI-00 ≥ E0	✓	✓	80	
Main memory	5MMDDR.0512-01	✓	✓	-	
	5MMDDR.1024-01	✓	✓	-	
	5MMDDR.2048-01	✓	✓	-	
Other insert card interfaces	5AC600.CANI-00	✓	✓	-	
	5AC600.485I-00	✓	✓	-	

¹⁾ Only possible in connection with CompactFlash cards 5CFCRD.xxxx-06, 5CFCRD.xxxx-04 and 5CFCRD.xxxx-03 available from B&R.

Figure 14: Ambient temperatures for 5PC781.1043-00 with an X945 CPU board

For a description of this image, see section 2.1.13 "How is the the maximum ambient temperature determined?".

Minimum ambient temperature

The minimum ambient temperature is 0°C.

2.1.11 Ambient temperatures with system unit 5PC781.1505-00

Maximum ambient temperature

All temperatures in degrees Celsius (°C) at 500 meters NN

Derating the maximum ambient temperature typically 1°C per 1000 meters above 500 NN.

		① Without fan kit N270 5PC600.X945-00	① With fan kit N270 5PC600.X945-00		
② Maximum ambient temperature		45	50	Temperature limits	Location of sensors
What can still be operated at the maximum ambient temperature, or are there limits? ↓					
③ Add-on drive	Onboard CompactFlash ¹⁾	✓	✓	80	I/O
	5AC600.CFSI-00 ¹⁾	✓	✓	80	
	5AC600.HDDI-05	✓	✓	85	
	5AC600.HDDI-06	✓	✓	85	
	5AC600.SSDI-00 ≤ D0	✓	✓	75	
	5AC600.SSDI-00 ≥ E0	✓	✓	80	
Main memory	5MMDDR.0512-01	✓	✓	-	
	5MMDDR.1024-01	✓	✓	-	
	5MMDDR.2048-01	✓	✓	-	
Other insert card interfaces	5AC600.CANI-00	✓	✓	-	
	5AC600.485I-00	✓	✓	-	

¹⁾ Only possible in connection with CompactFlash cards 5CFCRD.xxxx-06, 5CFCRD.xxxx-04 and 5CFCRD.xxxx-03 available from B&R.

Figure 15: Ambient temperatures for 5PC781.1505-00 with an X945 CPU board

For a description of this image, see section 2.1.13 "How is the the maximum ambient temperature determined?".

Minimum ambient temperature

The minimum ambient temperature is 0°C.

2.1.12 Ambient temperatures with system unit 5PC782.1043-00

Maximum ambient temperature

All temperatures in degrees Celsius (°C) at 500 meters NN

Derating the maximum ambient temperature typically 1°C per 1000 meters above 500 NN.

		① Without fan kit N270 5PC600.X945-00	① With fan kit N270 5PC600.X945-00		
② Maximum ambient temperature		45	55	Temperature limits	Location of sensors
What can still be operated at the maximum ambient temperature, or are there limits? ↓					
③ Add-on drive	Onboard CompactFlash ¹⁾	✓	✓	80	I/O
	5AC600.CFSI-00 ¹⁾	✓	✓	80	
	5AC600.HDDI-05	✓	✓	85	
	5AC600.HDDI-06	✓	✓	85	
	5AC600.SSDI-00 ≤ D0	✓	✓	75	
	5AC600.SSDI-00 ≥ E0	✓	✓	80	
Main memory	5MMDDR.0512-01	✓	✓	-	
	5MMDDR.1024-01	✓	✓	-	
	5MMDDR.2048-01	✓	✓	-	
Other insert card interfaces	5AC600.CANI-00	✓	✓	-	
	5AC600.485I-00	✓	✓	-	

¹⁾ Only possible in connection with CompactFlash cards 5CFCRD.xxxx-06, 5CFCRD.xxxx-04 and 5CFCRD.xxxx-03 available from B&R.

Figure 16: Ambient temperatures for 5PC782.1043-00 with an X945 CPU board

For a description of this image, see section 2.1.13 "How is the the maximum ambient temperature determined?".

Minimum ambient temperature

The minimum ambient temperature is 0°C.

2.1.13 How is the the maximum ambient temperature determined?

- 1) Selection of the CPU board (use **with** or **without** fan kit).
- 2) The lines under "Maximum ambient temperature" shows the maximum ambient temperature for the entire system (= system unit + CPU board).
- 3) Incorporating additional drives (add-on, slide-in), main memory, additional insert cards, etc. can change the temperature limits of a Panel PC 700 system.

If there is a ✓ (checkmark) next to the component, it can be used at the maximum ambient temperature of the whole system without problems.

If there is a specific temperature, for example "35", next to the component, then the ambient temperature of the whole Panel PC 700 system cannot exceed this temperature.

Special case: 5AC600.HDDI-00, 5AC600.HDDS-00 and RAID hard disks

For these hard disks, the limits will depend on whether the system is intended for 24-hour¹⁾ or standard¹⁾ operation.

Example 1: A temperature limit of "30/35" means 30°C for 24-hour operation and 35°C for standard operation.

Example 2: A temperature limit of "-/25" means not intended for 24-hour operation and 25°C for standard operation.

Information:

It is generally recommended to use a fan kit when using RAID hard disks.

2.1.14 Temperature monitoring

The PPC700 has temperature sensors in various places (I/O, power supply, slide-in drive 1). The locations of the temperature sensors can be found in the figure "Temperature sensor locations", on page 471. The value listed in the table represents the defined maximum temperature for this measurement point²⁾. An alarm is not triggered when this temperature is exceeded. The temperatures²⁾ can be read in BIOS (menu item "Advanced" - Baseboard/panel features - Baseboard monitor) or in Microsoft Windows XP/embedded, using the B&R Control Center. Additionally, the hard disks for PPC700 systems available from B&R are equipped with S.M.A.R.T, or Self Monitoring, Analysis, and Reporting Technology. This makes it possible to read various parameters, for example the temperature, using software (e.g. HDD thermometer - freeware) in Microsoft Windows XP/embedded.

1) 24-hour operation = 732 POH (Power On Hours) per month, standard operation = 250 POH or 333 POH (Power On Hours) per month.

2) The measured temperature is a guideline for the immediate ambient temperature, but can be influenced by neighboring components.

2.2 Humidity specifications

The following table displays the minimum and maximum relative humidity for the individual components that are relevant for the humidity limitations of the entire device. The lowest and highest common values are always used when establishing these limits.

Component		Operation	Storage / Transport
X945 CPU boards		10 - 90%	5 - 95%
Main memory for CPU board		10 - 90%	5 - 95%
Add-on drives	5AC600.SSDI-00 ≤ D0	0 - 95%	0 - 95%
	5AC600.SSDI-00 ≥ E0	10 - 95%	10 - 95%
	5AC600.HDDI-05	5 - 90%	5 - 95%
	5AC600.HDDI-06	5 - 90%	5 - 95%
Slide-in drives	5AC600.FDDS-00	20 - 80%	10 - 95%
Additional insert cards Interfaces AP Link	5ACPCI.RAIC-03 (24 hours / default)	8 - 90%	5 - 95%
	5ACPCI.RAIC-04 (24 hours/default)	8 - 90%	5 - 95%
	5ACPCI.RAIC-05 (24 hours/default)	5 - 95%	5 - 95%
	5MMHDD.0250-00 (24 hours/default)	5 - 95%	5 - 95%
	5AC600.CANI-00	5 - 90%	5 - 95%
	5AC600.485I-00	5 - 90%	5 - 95%
Accessories	CompactFlash cards 5CFCRD.xxxx-06	85%	85%
	CompactFlash cards 5CFCRD.xxxx-04	85%	85%
	CompactFlash cards - 5CFCRD.xxxx-03	8 - 95%	8 - 95%
	Flash drive 5MMUSB.2048-xx	10 - 90%	5 - 90%
	USB Media Drive 5MD900.USB2-01	20 - 80%	5 - 90%

Table 20: Overview of humidity specifications for individual components

The listed specifications correspond to the relative humidity at an ambient temperature of 30°C. More detailed information about the specific temperature-dependent humidity values can be found in the technical data for the individual components.

2.3 Power management

The following block diagram presents the simplified structure of the PPC700 supply voltage - valid starting with the following system unit revisions:

Model number	Short text	Starting with revision
5PC720.1043-00	Panel PC 720 10.4" VGA T, 0 PCI slots	K0
5PC720.1043-01	Panel PC 720 10.4" VGA T, 2 PCI slots, 1 disk drive slot	I0
5PC720.1214-00	Panel PC 720 12.1" SVGA T, 0 PCI slots	K0
5PC720.1214-01	Panel PC 720 12.1" SVGA T, 2 PCI slots, 1 disk drive slot	D0
5PC720.1505-00	Panel PC 720 15" XGA T, 0 PCI slots	M0
5PC720.1505-01	Panel PC 720 15" XGA T, 2 PCI slots, 1 disk drive slot	L0
5PC720.1505-02	Panel PC 720 15" XGA T, 1 PCI slot, 1 disk drive slot	K0
5PC720.1706-00	Panel PC 720 17" SXGA T, 0 PCI slots	E0
5PC720.1906-00	Panel PC 720 19" SXGA T, 0 PCI slots	G0
5PC781.1043-00	Panel PC 781 10.4" VGA FT, 0 PCI slots	H0
5PC781.1505-00	Panel PC 781 15" XGA FT, 0 PCI slots	J0
5PC782.1043-00	Panel PC 782 10.4" VGA FT, 0 PCI slots	H0

Table 21: Revision dependent block diagram

If an older system unit revision is used, its necessary to read the power management information in section 2.3.6 "Power management obsolete", on page 64.

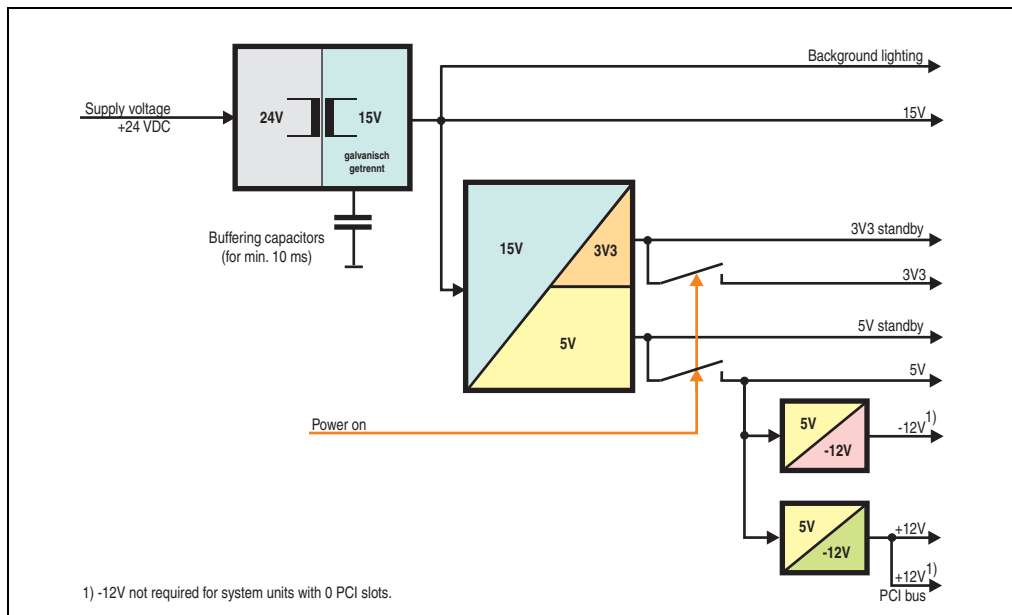

Figure 17: Block diagram - supply voltage

2.3.1 Power calculation for 10.4" Panel PC 700

Model number	Short text	Starting with revision
5PC720.1043-00	Panel PC 720 10.4" VGA T, 0 PCI slots	K0
5PC720.1043-01	Panel PC 720 10.4" VGA T, 2 PCI slots, 1 disk drive slot	I0
5PC781.1043-00	Panel PC 781 10.4" VGA FT, 0 PCI slots	H0
5PC782.1043-00	Panel PC 782 10.4" VGA FT, 0 PCI slots	H0

Table 22: Revision dependent 10.4" Panel PC 700

Information:		10.4" Panel PC 700	Current system	
<p>All values in Watts The values for the suppliers are maximum values. The values for the consumers are average maximum values, but not peak values.</p>		<p>N270 945-00 5PC000.X045-00</p>	<p>Enter values in this column</p> <p>↓</p>	
Total power supply power (maximum)			110	
Total power supply, permanent consumers		9		
Maximum possible at 5V			70	
Total power supply	CPU board, permanent consumers	16		
	Pro CompactFlash, optional (add-on, slide-in)	1		
	Hard disk, optional (add-on, slide-in)	4		
	Pro drive, optional (slide-in CD,DVD CD-RW)	4		
	External PS/2 keyboard, optional	1		
	USB peripheral, optional (max. 2.5 W per USB1 and USB2 connection)	5		
	Interface option (add-on interface), optional	0.5		
	Power value from PCI card manufacturer, optional (max. 3 W without fan kit, max. 17 W with fan kit)			
	External consumers, optional (via base board)	5		
	Keys/LEDs, perm. consumers (system unit dependant)	1.5		
	5V consumers ∑			
	Maximum possible at +12V			24
+12V	Fan kit, optional	2.5		
	External consumers, optional (via base board)	10		
	Power value from PCI card manufacturer, opt. (max. 3 W without fan kit, max. 12 W with fan kit)			
+12V consumers ∑				
Maximum possible at -12V			1.2	
-12V	Power value from PCI card manufacturer, opt. (max. 1.23 W with or without fan kit) ¹⁾			
	-12V consumers ∑			
All 5V consumers ∑				
Maximum possible at 3V3			23	
3V3	System unit, permanent consumers	5		
	Interface option (add-on interface), optional	0.25		
	Power value from PCI card manufacturer, optional (max. 3 W without fan kit, max. 17 W with fan kit)			
3V3 consumers ∑				
All consumers ∑				

¹⁾ The total performance of one PCI card per PCI slot (= sum of power consumptions for each voltage area) may not exceed the limits stated for operation with or without a fan kit.

Figure 18: Power calculation for 10.4" Panel PC 700 system units

2.3.2 Power calculation for 12.1" Panel PC 700

Model number	Short text	Starting with revision
5PC720.1214-00	Panel PC 720 12.1" SVGA T, 0 PCI slots	K0
5PC720.1214-01	Panel PC 720 12.1" SVGA T, 2 PCI slots, 1 disk drive slot	D0

Table 23: Revision dependent 12.1" Panel PC 700

Information:		12.1" Panel PC 700	Current system
<p>All values in Watts The values for the suppliers are maximum values. The values for the consumers are average maximum values, but not peak values.</p>		<small>N270</small> <small>EP0600.Y04E-00</small>	Enter values in this column 
Total power supply power (maximum)			110
Total power supply, permanent consumers		10	
Maximum possible at 5V			70
Total power supply	5V	CPU board, permanent consumers	16
		Pro CompactFlash, optional (add-on, slide-in)	1
		Hard disk, optional (add-on, slide-in)	4
		Pro drive, optional (slide-in CD,DVD CD-RW)	4
		External PS/2 keyboard, optional	1
		USB peripheral, optional <small>(max. 2.5 W per USB1 and USB2 connection)</small>	5
		Interface option (add-on interface), optional	0.5
		Power value from PCI card manufacturer, optional <small>(max. 3 W without fan kit, max. 17 W with fan kit)¹⁾</small>	
		External consumers, optional (via base board)	5
		5V consumers ∑	
Maximum possible at +12V			24
+12V		Fan kit, optional	2.5
		External consumers, optional (via base board)	10
		Power value from PCI card manufacturer, opt. <small>(max. 3 W without fan kit, max. 12 W with fan kit)</small>	
	+12V consumers ∑		
Maximum possible at -12V			1.2
-12V		Power value from PCI card manufacturer, opt. <small>(max. 1.2 W with or without fan kit)¹⁾</small>	
	-12V consumers ∑		
5V consumers ∑			
Maximum possible at 3V3			23
3V3		System unit, permanent consumers	5
		Interface option (add-on interface), optional	0.25
		Power value from PCI card manufacturer, optional <small>(max. 3 W without fan kit, max. 17 W with fan kit)¹⁾</small>	
	3V3 consumers ∑		
All consumers ∑			

1) The total performance of one PCI card per PCI slot (= sum of power consumptions for each voltage area) may not exceed the limits stated for operation with or without a fan kit.

Figure 19: Power calculation for 12.1" Panel PC 700 system units

2.3.3 Power calculation for 15" Panel PC 700

Model number	Short text	Starting with revision
5PC720.1505-00	Panel PC 720 15" XGA T, 0 PCI slots	M0
5PC720.1505-01	Panel PC 720 15" XGA T, 2 PCI slots, 1 disk drive slot	L0
5PC720.1505-02	Panel PC 720 15" XGA T, 1 PCI slot, 1 disk drive slot	K0
5PC781.1505-00	Panel PC 781 15" XGA FT, 0 PCI slots	J0

Table 24: Revision dependent 15" Panel PC 700

Information:		15" Panel PC 700	Current system
All values in Watts The values for the suppliers are maximum values. The values for the consumers are average maximum values, but not peak values.		N270 5PC900.945-00	Enter values in this column ↓
		Total power supply power (maximum)	
Total power supply, permanent consumers		22	
Maximum possible at 5V			70
Total power supply	CPU board, permanent consumers	16	
	Pro CompactFlash, optional (add-on, slide-in)	1	
	Hard disk, optional (add-on, slide-in)	4	
	Pro drive optional (slide-in CD,DVD CD-RW)	4	
	External PS/2 keyboard, optional	1	
	USB peripheral, optional (max. 2.5 W per USB1 and USB2 connection)	5	
	Interface option (add-on interface), optional	0.5	
	Power value from PCI card manufacturer, optional (max. 3 W without fan kit, max. 17 W with fan kit)		
	External consumers, optional (via base board)	5	
	Keys/LEDs, perm. consumers (system unit dependant)	1.5	
	5V consumers Σ		
Maximum possible at +12V			24
+12V	Fan kit, optional	2.5	
	External consumers, optional (via base board)	10	
	Power value from PCI card manufacturer, opt. (max. 3 W without fan kit, max. 12 W with fan kit)		
+12V consumers Σ			
Maximum possible at -12V			1.2
-12V	Power value from PCI card manufacturer, opt. (max. 1.2 W with or without fan kit) ¹⁾		
-12V consumers Σ			
All 5V consumers Σ			
Maximum possible at 3V3			23
3V3	Systemeinheit, Fixverbraucher	7	
	Schnittstellenoption (Add-On Interface), optional	0.25	
	Power value from PCI card manufacturer, optional (max. 3 W without fan kit, max. 17 W with fan kit)		
3V3 consumers Σ			
All consumers Σ			

¹⁾ The total performance of one PCI card per PCI slot (= sum of power consumptions for each voltage area) may not exceed the limits stated for operation with or without a fan kit.

Figure 20: Power calculation for 15" Panel PC 700

2.3.4 Power calculation for 17" Panel PC 700

Model number	Short text	Starting with revision
5PC720.1706-00	Panel PC 720 17" SXGA T, 0 PCI slots	E0

Table 25: Revision dependent 17" Panel PC 700

Information:		17" Panel PC 700	Current system	
<p>All values in Watts The values for the suppliers are maximum values. The values for the consumers are average maximum values, but not peak values.</p>		N270 5PC600.X945-00	Enter values in this column 	
Total power supply power (maximum)			110	
Total power supply, permanent consumers		25		
Maximum possible at 5V			70	
Total power supply	CPU board, permanent consumers	16		
	Pro CompactFlash, optional (add-on, slide-in)	1		
	Hard Disk, optional (add-on, slide-in)	4		
	External PS/2 keyboard, optional	1		
	USB peripheral, optional (max. 2.5 W per USB1 and USB2 connection)	5		
	Interface option (add-on interface), optional	0.5		
	External consumers, optional (via base board)	5		
		5V consumers ∑		
	Maximum possible at +12V			24
	Fan kit, optional	2.5		
External consumers, optional (via base board)	10			
	+12V consumers ∑			
	All 5V consumers ∑			
Maximum possible at 3V3			23	
System unit, permanent consumers	6			
Interface option (add-on interface), optional	0.25			
	3V3 consumers ∑			
	All consumers ∑			

Figure 21: Power calculation for 17" Panel PC 700

2.3.5 Power calculation for 19" Panel PC 700

Model number	Short text	Starting with revision
5PC720.1906-00	Panel PC 720 19" SXGA T, 0 PCI slots	G0

Table 26: Revision dependent 19" Panel PC 700

Information:		19" Panel PC 700	Current system	
All values in Watts The values for the suppliers are maximum values. The values for the consumers are average maximum values, but not peak values.		N270 5PC600.X945-00	Enter values in this column 	
Total power supply power (maximum)			110	
Total power supply, permanent consumers		25		
Maximum possible at 5V			70	
Total power supply	5V	CPU board, permanent consumers	16	
		Pro CompactFlash, optional (add-on, slide-in)	1	
		Hard disk, optional (add-on, slide-in)	4	
		External PS/2 keyboard, optional	1	
		USB peripheral, optional (max. 2.5 W per USB1 and USB2 connection)	5	
		Interface option (add-on interface), optional	0.5	
		External consumers, optional (via base board)	5	
		5V consumers Σ		
	Maximum possible at +12V			24
	+12V	Fan kit, optional	2.5	
	External consumers, optional (via base board)	10		
	+12V consumers Σ			
All 5V consumers Σ				
Maximum possible at 3V3			23	
3V3	System unit, permanent consumers	6		
	Interface option (add-on interface), optional	0.25		
	3V3 consumers Σ			
All consumers Σ				

Figure 22: Power calculation for 19" Panel PC 700

2.3.6 Power management obsolete

The following block diagram presents the simplified structure of the PPC700 supply voltage - valid starting with the following system unit revisions:

Model number	Short text	Lower revision
5PC720.1043-00	Panel PC 720 10.4" VGA T, 0 PCI slots	K0
5PC720.1043-01	Panel PC 720 10.4" VGA T, 2 PCI slots, 1 disk drive slot	I0
5PC720.1214-00	Panel PC 720 12.1" SVGA T, 0 PCI slots	K0
5PC720.1214-01	Panel PC 720 12.1" SVGA T, 2 PCI slots, 1 disk drive slot	D0
5PC720.1505-00	Panel PC 720 15" XGA T, 0 PCI slots	M0
5PC720.1505-01	Panel PC 720 15" XGA T, 2 PCI slots, 1 disk drive slot	L0
5PC720.1505-02	Panel PC 720 15" XGA T, 1 PCI slot, 1 disk drive slot	K0
5PC720.1706-00	Panel PC 720 17" SXGA T, 0 PCI slots	E0
5PC720.1906-00	Panel PC 720 19" SXGA T, 0 PCI slots	G0
5PC781.1043-00	Panel PC 781 10.4" VGA FT, 0 PCI slots	H0
5PC781.1505-00	Panel PC 781 15" XGA FT, 0 PCI slots	J0
5PC782.1043-00	Panel PC 782 10.4" VGA FT, 0 PCI slots	H0

Table 27: Revision dependent block diagram

If a newer system unit revision is used, it's necessary to read the power management information in section 2.3 "Power management", on page 58.

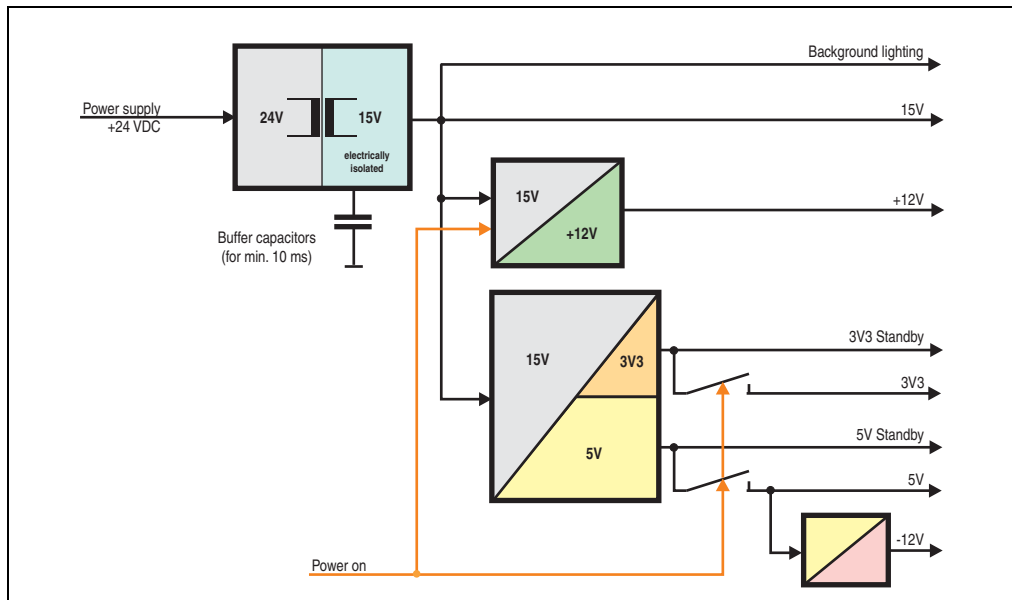

Figure 23: Block diagram - supply voltage

Explanation:

The supply voltage (+24 VDC) is converted to 15 V with a DC/DC converter. The electrically isolated 15 V is used to feed two further DC/DC converters (generation of +12 V, 3V3 and 5V standby) as well as the background lighting.

After the system is turned on (e.g. using the power button), the voltages 3V3, 5 V and +12 V are placed on the bus. At the 5 V output, another DC/DC converter generates -12 V and provides this voltage to the bus.

10.4" Panel PC 700

		10.4" Panel PC 700	Current system	
All entries in Watts		N270 5FC600.X945-00		
Total power supply power (maximum)			110	
Total power supply, permanent consumers		9		
Total power supply	Maximum possible at 5V		55	
	CPU board, permanent consumers	16		
	Pro CompactFlash, optional (add-on, slide-in)	1		
	Hard disk, optional (add-on, slide-in)	4		
	Pro drive, optional (slide-in CD,DVD CD-RW)	4		
	External PS/2 keyboard, optional	1		
	USB peripheral, optional (max. 2.5 W per USB1 and USB2 connection)	5		
	Interface option (add-on interface), optional	0.5		
	Power value from PCI card manufacturer, optional (max. 3 W without fan kit, max. 17 W with fan kit ¹⁾)			
	External consumers, optional (via base board)	5		
	Keys/LEDs, perm. Consumers (system unit dependant)	1.5		
	5V consumers ∑			
	Maximum possible at 3V3			23
	System unit, permanent consumers	5		
Interface option (add-on interface), optional	0.25			
Power value from PCI card manufacturer, optional (max. 3 W without fan kit, max. 17 W with fan kit ¹⁾)				
3V3 consumers ∑				
Maximum possible at +12V			12	
Fan kit, optional	2.5			
External consumers, optional (via base board)	10			
Power value from PCI card manufacturer, optional (max. 3 W without fan kit, max. 12 W with fan kit ¹⁾)				
+12V consumers ∑				
Maximum possible at -12V			1.2	
Power value from PCI card manufacturer, optional (max. 1.2 W with or without fan kit ¹⁾)				
-12V consumers ∑				
All consumers ∑				

¹⁾ The total performance of one PCI card per PCI slot (= sum of power consumptions for each voltage area) may not exceed the limits stated for operation with or without a fan kit.

Figure 24: Power management - 10.4" Panel PC 700

12.1" Panel PC 700

All values in Watts		12.1" Panel PC 700	Current system
		N270 5FC600.X945-00	
Total power supply power (maximum)		110	
Total power supply, permanent consumers		10	
Maximum possible at 5V		55	
5V	CPU board, permanent consumers	16	
	Pro CompactFlash, optional (add-on, slide-in)	1	
	Hard disk, optional (add-on, slide-in)	4	
	Pro drive, optional (slide-in CD,DVD CD-RW)	4	
	External PS/2 keyboard, optional	1	
	USB peripheral, optional (max. 2.5 W per USB1 and USB2 connection)	5	
	Interface option (add-on interface), optional	0.5	
	Power value from PCI card manufacturer, optional (max. 3 W without fan kit, max. 17 W with fan kit) ¹⁾		
	External consumers, optional (via base board)	5	
	5V consumers ∑		
Maximum possible at 3V3		23	
3V3	System unit, permanent consumers	5	
	Interface option (add-on interface), optional	0.25	
	Power value from PCI card manufacturer, optional (max. 3 W without fan kit, max. 17 W with fan kit) ¹⁾		
3V3 consumers ∑			
Maximum possible at +12V		12	
+12V	Fan kit, optional	2.5	
	External consumers, optional (via base board)	10	
	Power value from PCI card manufacturer, optional (max. 3 W without fan kit, max. 12 W with fan kit) ¹⁾		
+12V consumers ∑			
Maximum possible at -12V		1.2	
-12V	Power value from PCI card manufacturer, optional (max. 1.2 W with or without fan kit) ¹⁾		
-12V consumers ∑			
All consumers ∑			

¹⁾ The total performance of one PCI card per PCI slot (= sum of power consumptions for each voltage area) may not exceed the limits stated for operation with or without a fan kit.

Figure 25: Power management - 12.1" Panel PC 700

15" Panel PC 700

All values in Watts		15" Panel PC 700	Current system
		5PFC600.X945-00 N270	
Total power supply power (maximum)		110	
Total power supply, permanent consumers		22	
Maximum possible at 5V		55	
5V	CPU board, permanent consumers	16	
	Pro CompactFlash, optional (add-on, slide-in)	1	
	Hard disk, optional (add-on, slide-in)	4	
	Pro drive, optional (slide-in CD,DVD CD-RW)	4	
	External PS/2 keyboard, optional	1	
	USB peripheral, optional (max. 2.5 W per USB1 and USB2 connection)	5	
	Interface option (add-on interface), optional	0.5	
	Power value from PCI card manufacturer, optional (max. 3 W without fan kit, max. 17 W with fan kit) ¹⁾		
	External consumers, optional (via base board)	5	
	Keys/LEDs, perm. consumers (system unit dependant)	1.5	
5V consumers ∑			
Maximum possible at 3V3		23	
3V3	System unit, permanent consumers	7	
	Interface option (add-on interface), optional	0.25	
	Power value from PCI card manufacturer, optional (max. 3 W without fan kit, max. 17 W with fan kit) ¹⁾		
3V3 consumers ∑			
Maximum possible at +12V		12	
+12V	Fan kit, optional	2.5	
	External consumers, optional (via base board)	10	
	Power value from PCI card manufacturer, optional (max. 3 W without fan kit, max. 12 W with fan kit) ¹⁾		
+12V consumers ∑			
Maximum possible at -12V		1.2	
-12V	Power value from PCI card manufacturer, optional (max. 1.2 W with or without fan kit) ¹⁾		
	-12V consumers ∑		
All consumers ∑			

¹⁾ The total performance of one PCI card per PCI slot (= sum of power consumptions for each voltage area) may not exceed the limits stated for operation with or without a fan kit.

Figure 26: Power management - 15" Panel PC 700

17" Panel PC 700

All values in Watts		17" Panel PC 700	Current system	
		N270 5FC600.X945-00		
Total power supply power (maximum)		110		
Total power supply, permanent consumers		25		
Total power supply	5V	Maximum possible at 5V		
		CPU board, permanent consumers	16	
		Pro CompactFlash, optional (add-on, slide-in)	1	
		Hard disk, optional (add-on, slide-in)	4	
		External PS/2 keyboard, optional	1	
		USB peripheral, optional (max. 2.5 W per USB1 and USB2 connection)	5	
		Interface option (add-on interface), optional	0.5	
		External consumers, optional (via base board)	5	
		5V consumers Σ		
		Maximum possible at 3V3		23
	3V3	System unit, permanent consumers	6	
		Interface option (add-on interface), optional	0.25	
	3V3 consumers Σ			
	Maximum possible at +12V		12	
	+12V	Fan kit, optional	2.5	
		External consumers, optional (via base board)	10	
	+12V consumers Σ			
	All consumers Σ			

Figure 27: Power management - 17" Panel PC 700

19" Panel PC 700

All values in Watts		19" Panel PC 700	Current system	
		N270 5FC600-X945-00		
Total power supply power (maximum)		110		
Total power supply, permanent consumers		25		
Total power supply	5V	Maximum possible at 5V		
	CPU board, permanent consumers		16	
	Pro CompactFlash, optional (add-on, slide-in)		1	
	Hard disk, optional (add-on, slide-in)		4	
	External PS/2 keyboard, optional		1	
	USB peripheral, optional (max. 2.5 W per USB1 and USB2 connection)		5	
	Interface option (add-on interface), optional		0.5	
	External consumers, optional (via base board)		5	
	5V consumers Σ			
	3V3		Maximum possible at 3V3	
System unit, permanent consumers		6		
Interface option (add-on interface), optional		0.25		
3V3 consumers Σ				
+12V		Maximum possible at +12V		
Fan kit, optional		2.5		
External consumers, optional (via base board)		10		
+12V consumers Σ				
All consumers Σ				

Figure 28: Power management - 19" Panel PC 700

2.4 Device interfaces

The following image shows the general and optional device interfaces for an entire Panel PC 700 unit.

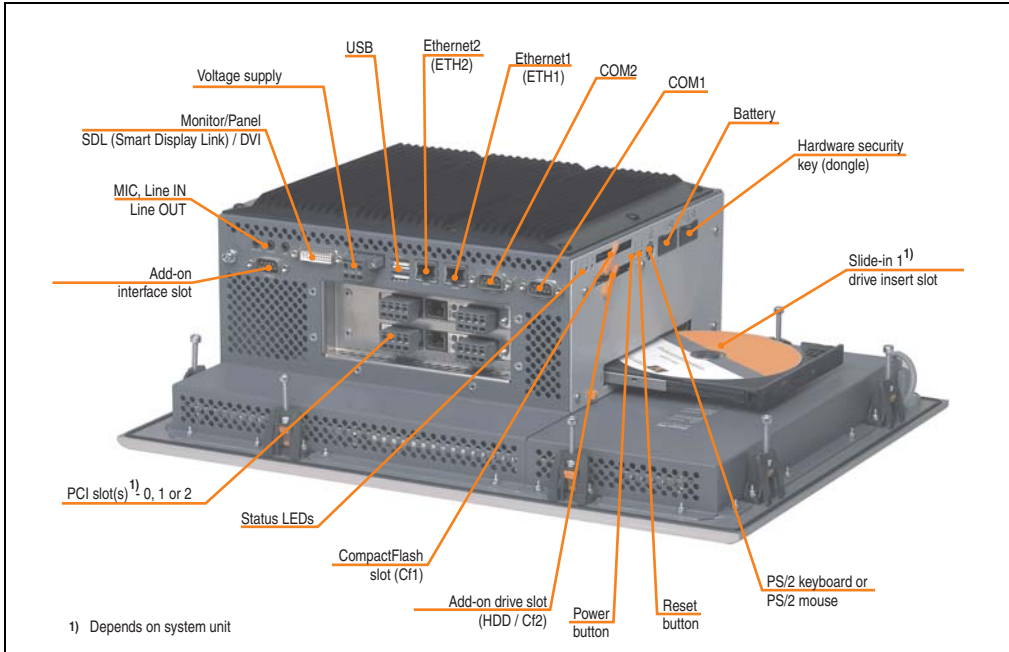

Depending on system unit, the device interfaces will vary only in the number of PCI slots and the presence of a slide-in drive slot.

2.4.1 Serial interface COM1

Serial interfaces - COM1		
Type	RS232, modem-capable, not electrically isolated	<p>9-pin DSUB, male</p> 
UART	16550 compatible, 16 byte FIFO	
Transfer rate	Max. 115 kBaud	
Pin	Assignment	
1	DCD	
2	RXD	
3	TXD	
4	DTR	
5	GND	
6	DSR	
7	RTS	
8	CTS	
9	RI	

Table 28: Pin assignments - COM1

I/O address and IRQ

Resource	Default setting	Additional setting options
I/O address	3F8	2F8, 3E8, 2E8
IRQ	IRQ4	IRQ3

Table 29: COM1 - I/O address and IRQ

The setting for the I/O address and the IRQ can be changed in the BIOS setup (under "Advanced" - submenu "I/O Device Configuration" setting "Serial port A"). Please note any potential conflicts with other resources when changing this setting.

2.4.2 Serial interface COM2

Serial interfaces - COM2		
Type	RS232, modem-capable, not electrically isolated	<p>9-pin DSUB, male</p> 
UART	16550 compatible, 16 byte FIFO	
Transfer rate	Max. 115 kBaud	
Pin	Assignment	
1	DCD	
2	RXD	
3	TXD	
4	DTR	
5	GND	
6	DSR	
7	RTS	
8	CTS	
9	RI	

Table 30: Pin assignments - COM2

I/O address and IRQ

Resource	Default setting	Additional setting options
I/O address	2F8	3F8, 3E8, 2E8
IRQ	IRQ3	IRQ4

Table 31: COM2 - I/O address and IRQ

The setting for the I/O address and the IRQ can be changed in the BIOS setup (under "Advanced" - submenu "I/O Device Configuration" setting "Serial port B"). Please note any potential conflicts with other resources when changing this setting.

2.4.3 Ethernet connection ETH1

This Ethernet connection is integrated in the CPU board being used.

Ethernet connection (ETH1 ¹⁾)		
Controller	Intel 82562	
Cabling	S/STP (Cat5e)	
Transfer rate	10/100 Mbit/s ²⁾	
Cable length	See table 33 "Ethernet cable lengths when using X945 CPU boards", on page 75.	
LED	On	Off
Green	100 Mbit/s	10 Mbit/s
Orange	Link (Ethernet network connection available)	Activity (blinking) (Data transfer in progress)

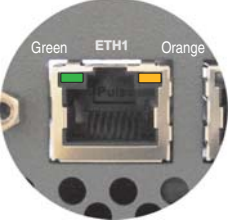

Table 32: Ethernet connection (ETH1)

- 1) The interfaces, etc. available on the device or module were numbered accordingly for easy identification. This numbering can differ from the numbering used by the particular operating system.
- 2) Both operating modes possible. Switching takes place automatically.

Driver support

Special drivers are necessary for operating the Intel Ethernet controller 82562. Drivers for Windows XP Professional, Windows XP Embedded, and DOS are available for download on the B&R Homepage in the download area (www.br-automation.com).

Information:

Required drivers can only be downloaded from the B&R homepage, not from manufacturers' pages.

Ethernet cable lengths when X945 CPU boards are used

When using X945 CPU boards, the supported cable length depends on the system unit revision.

System unit	Cable length with CAT5e cable	
	Up to 50 meters	Up to 100 meters
5PC720.1043-00	Revision < I0	Starting with revision I0
5PC720.1043-01	Revision < H0	Starting with Revision H0
5PC720.1214-00	Revision < J0	Starting with revision J0
5PC720.1214-01	-	Starting with revision C0
5PC720.1505-00	Revision < J0	Starting with revision J0
5PC720.1505-01	Revision < I0	Starting with revision I0
5PC720.1505-02	Revision < H0	Starting with Revision H0
5PC720.1706-00	-	Starting with revision C0
5PC720.1906-00	-	Starting with revision C0
5PC781.1043-00	Revision < G0	Starting with revision G0
5PC781.1505-00	Revision < H0	Starting with Revision H0
5PC782.1043-00	Revision < G0	Starting with revision G0

Table 33: Ethernet cable lengths when using X945 CPU boards

2.4.4 Ethernet connection ETH2

This Ethernet connection is integrated in the system unit.

Ethernet connection (ETH1 ¹⁾)		
Controller	Intel 82551ER	
Cabling	S/STP (Cat5e)	
Transfer rate	10/100 Mbit/s ²⁾	
Cable length	max. 100 m (min. Cat5e)	
LED	On	Off
Green	100 Mbit/s	10 Mbit/s
Orange	Link (Ethernet network connection available)	Activity (blinking) (Data transfer in progress)

RJ45 twisted pair (10BaseT/100BaseT), female

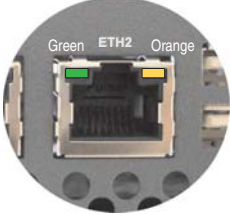

Table 34: Ethernet connection (ETH2)

- 1) The interfaces, etc. available on the device or module were numbered accordingly for easy identification. This numbering can differ from the numbering used by the particular operating system.
- 2) Both operating modes possible. Switching takes place automatically.

Driver support

Special drivers are necessary for operating the Intel Ethernet controller 82551ER. Drivers for Windows XP Professional, Windows XP Embedded, and DOS are available for download on the B&R Homepage in the download area (www.br-automation.com).

Information:

Required drivers can only be downloaded from the B&R homepage, not from manufacturers' pages.

2.4.5 USB ports

All PPC700 devices have a USB 2.0 (Universal Serial Bus) Host Controller with multiple USB ports, 3 of which (2x back, 1x front) are on the outside for easy user access.

Universal Serial Bus (USB1 and UBS2) ¹⁾	
Transfer rate	Low speed (1.5 Mbit/s), Full Speed (12 Mbit/s) to high speed (480 Mbit/s)
Power supply	Max. 500 mA per port ²⁾
Maximum Cable length	5 m (not including hub)
<p>USB type A, female</p> <p>Back side</p> <p>Front side</p>	

Table 35: USB port - back

1) The interfaces, etc. available on the device or module were numbered accordingly for easy identification. This numbering can differ from the numbering used by the particular operating system.

2) For safety, every USB port is equipped with a maintenance free "USB current-limiting circuit breaker" (max. 500 mA)

Warning!

Peripheral USB devices can be connected to the USB ports. Due to the vast number of USB devices available on the market, B&R cannot guarantee their performance. B&R does ensure the performance of all USB devices that they provide.

Warning!

Because of general PC specifications, these interfaces should be handled with extreme care with regard to EMC, location of cables, etc.

Driver support

For optimal functionality of USB 2.0 (transfer speed up to 480 Mbit/s) with Windows XP, at least Service Pack 1 must be installed. Without the Service Pack, Windows XP will only support USB 1.1.

USB 2.0 comes already integrated in B&R's XP embedded operating system.

Information:

Required drivers can only be downloaded from the B&R homepage, not from manufacturers' pages.

2.4.6 Supply voltage

The PPC700 system units have a 24 VDC ATX compatible power supply.

System unit	Max. performance at + 5 V	Max. performance at + 3V3	Max. power at + 12 V	Max. power at - 12 V	Max. total power
All types	55 W	23 W	12 W	1.2 W	110 W

Table 36: Power supply

The 3-pin socket required for the supply voltage connection is not included in delivery. This can be ordered from B&R using the model number 0TB103.9 (screw clamp) or 0TB103.91 (cage clamp).

The pin assignments can be found either in the following table or printed on the Panel PC 700 housing. The supply voltage is internally protected (10A, fast-acting), so that the device cannot be damaged if there is an overload (fuse replacement necessary) or if the voltage supply is connected incorrectly (reverse polarity protection - fuse replacement not necessary).

Supply voltage	
Protected against reverse polarity	
Pin	Description
1	+
2	Functional ground
3	-
Accessories	
0TB103.9	Plug 24 V 5.08 3p screw clamps
0TB103.91	Plug 24 V 5.08 3p cage clamps



3-pin, male

Figure 29: Supply voltage connection

Ground

Warning!

Functional ground (pin 2 of power supply and ground connection) must be kept as short as possible and connected to the largest possible wire cross section at the central grounding point (e.g. the control cabinet or system).

PPC700 systems are equipped with a ground connection. The M4 self-locking nut must be used, for example, to fasten a copper strip that is built into the PPC700 at a central grounding point in the control cabinet or system. The largest possible conductor cross section should be used (at least 2.5 mm²).



Figure 30: Ground connection

See the section "Grounding concept", on page 224.

2.4.7 Monitor / Panel interface

Monitor / Panel	
<p>The following will provide an overview of the video signals available with different system units and CPU boards. For details, see technical data for the CPU board being used.</p>	
System unit	X945 board
5PC720.1043-00	RGB
5PC720.1043-01	RGB
5PC720.1214-00	RGB
5PC720.1214-01	RGB
5PC720.1505-00	RGB
5PC720.1505-01	RGB
5PC720.1505-02	RGB
5PC720.1706-00	RGB
5PC720.1906-00	RGB
5PC781.1043-00	RGB
5PC781.1505-00	RGB
5PC782.1043-00	RGB

24-pin DVI-I with special functions, female



Figure 31: Monitor / Panel interface

Hotplug for a display device is not supported in any combination. The plugs are specified for 100 connection cycles.

Caution!

RGB cables can only be plugged in and unplugged when the PPC700 and display device (monitor) are turned off.

2.4.8 MIC, Line IN and Line OUT ports

All PPC700 systems include an AC97 (specification 2.2) compatible sound chip with access to the channels MIC, Line IN and Line OUT from the outside.

MIC, Line IN and Line OUT		
Controller	Realtek AC97	<p>3.5 mm socket, female</p> 
MIC	Connection of a mono microphone with a 3.5 mm stereo (headphone) jack.	
Line IN	Stereo Line IN signal supplied via 3.5 mm jack.	
Line OUT	Connection of a stereo sound device (e.g. amplifier) via a 3.5 mm jack.	

Table 37: MIC, Line IN and Line OUT ports

Driver support

Special drivers are necessary for operating the AC97 sound chip (Realtek). Drivers for Windows XP Professional and Windows XP Embedded are available for download on the B&R Homepage in the download area (www.br-automation.com).

Information:

Required drivers can only be downloaded from the B&R homepage, not from manufacturers' pages.

2.4.9 Add-on interface slot

An optional add-on interface (e.g. CAN, RS485) can be installed here. See also section 3.7 "Interface options", on page 205.

Add-on interface slot	
Available add-on interfaces	
5AC600.CANI-00	Add-on CAN interface
5AC600.485I-00	Add-on RS232/422/485 interface
	

Table 38: Add-on interface slot

Information:

An add-on interface module is only available factory-installed.

2.4.10 PCI slots

Up to 2 PCI slots are available, depending on the system unit. 5 volt cards and universal cards that comply with the PCI half-size standard 2.2 and do not exceed the following dimensions can be inserted.

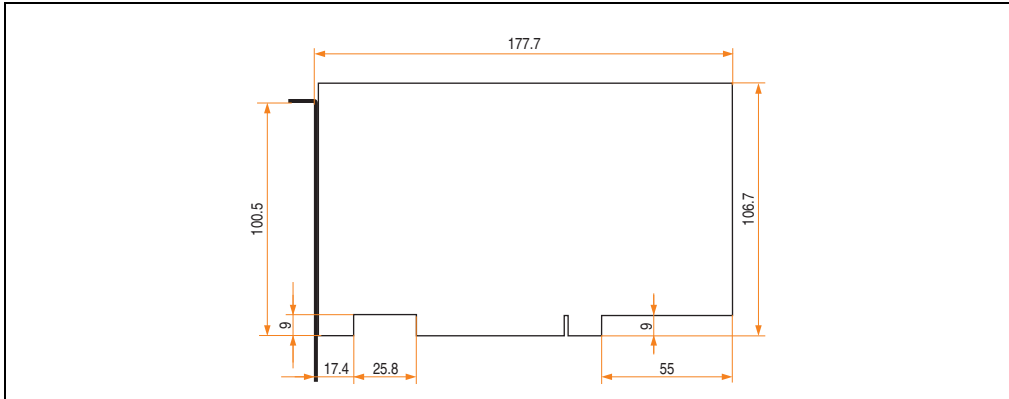

Figure 32: Dimensions - Standard half-size PCI cards

Information:

The total performance of one PCI card per PCI slot should not exceed the limit with or without a fan kit (see section 2.3 "Power management").

Technical data

Features	PCI bus properties
Standard	PCI 2.2
Design	Half-size PCI
PCI bus type	32-bit
PCI bus speed	33 MHz

Table 39: Technical data - PCI bus

Voltages on the PCI slot plug

The plug design for the PCI slot is the same as the design for a 5-volt PCI plug. The supply is applied at 3.3 volts and 5 volts on the actual plug.

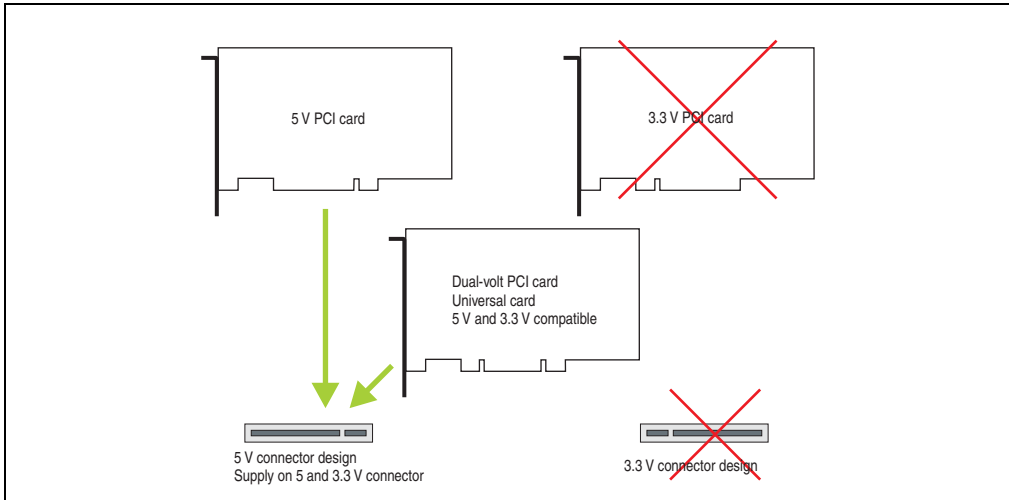

Figure 33: PCI connector type: 5 volt

2.4.11 Status LEDs

The status LEDs are integrated in the system unit.

Status LEDs			
LED	Color		Meaning
Power	Green	On	Supply voltage OK
	Red	On	The system is in standby mode (S5: soft-off mode or S4: Hibernate mode -Suspend-to-Disk)
HDD	Yellow	On	Signals IDE drive access (CF, HDD, CD, etc.)
Link 1	Yellow	On	Indicates an active SDL connection on the monitor / panel plug.
		blinking	An active SDL connection has been interrupted by a loss of power in the display unit.
Link 2	-	-	No function

The image shows the front panel of the system unit with five status LEDs. From top to bottom: a green LED labeled 'Power', a yellow LED labeled 'HDD', a yellow LED labeled 'Link 1', a grey LED labeled 'Link 2', and two black LEDs labeled 'HDD / CF2' and 'CF1'.

Table 40: Status LEDs

2.4.12 CompactFlash slot (CF1)

This CompactFlash slot is a fixed component of an PPC700 system, and is defined in BIOS as the primary master drive. Available CompactFlash cards - see table 13 "Model numbers - CompactFlash cards", on page 29.

CompactFlash slot (CF1)	
Connection	Primary master IDE device
CompactFlash Type	Type I
Accessories	Short description
5CFCRD.0512-06	CompactFlash 512 MB B&R
5CFCRD.1024-06	CompactFlash 1024 MB B&R
5CFCRD.2048-06	CompactFlash 2048 MB B&R
5CFCRD.4096-06	CompactFlash 4096 MB B&R
5CFCRD.8192-06	CompactFlash 8192 MB B&R
5CFCRD.016G-06	CompactFlash 16 GB B&R
5CFCRD.032G-06	CompactFlash 32 GB B&R
5CFCRD.0064-03	CompactFlash 64 MB SSI
5CFCRD.0128-03	CompactFlash 128 MB SSI
5CFCRD.0256-03	CompactFlash 256 MB SSI
5CFCRD.0512-03	CompactFlash 512 MB SSI
5CFCRD.1024-03	CompactFlash 1024 MB SSI
5CFCRD.2048-03	CompactFlash 2048 MB SSI
5CFCRD.4096-03	CompactFlash 4096 MB SSI
5CFCRD.8192-03	CompactFlash 8192 MB SSI

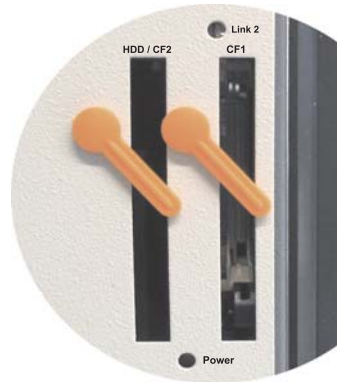

Table 41: CompactFlash slot (CF1)

Warning!

Turn off power before inserting or removing the CompactFlash card!

2.4.13 Hard disk / CompactFlash slot (HDD/CF2)

This slot allows for installation of a hard disk or a second CompactFlash slot as so-called add-on drives (see table 8 "Model numbers - Drives" for available add-on drives). The add-on drive is referred to in BIOS as the primary slave drive.

Information:

Add-on drives are only available factory-installed. Therefore, they need to be requested when placing an order.

Hard disk / CompactFlash slot (HDD/CF2)	
Connection	Primary slave IDE device
Add-on hard disks 2.5" drive (internal)	
5AC600.SSDI-00	Add-on SSD 128 GB MLC
5AC600.HDDI-05	Add-on hard disk 40 GB ET, 24/7
5AC600.HDDI-06	Add-on hard disk 80 GB ET, 24/7
Add-on CompactFlash slot	
5AC600.CFSI-00	Add-on CompactFlash slot
CompactFlash Type	Type I
Accessories	Short description
5CFCRD.0512-06	CompactFlash 512 MB B&R
5CFCRD.1024-06	CompactFlash 1024 MB B&R
5CFCRD.2048-06	CompactFlash 2048 MB B&R
5CFCRD.4096-06	CompactFlash 4096 MB B&R
5CFCRD.8192-06	CompactFlash 8192 MB B&R
5CFCRD.016G-06	CompactFlash 16 GB B&R
5CFCRD.032G-06	CompactFlash 32 GB B&R
5CFCRD.0064-03	CompactFlash 64 MB SSI
5CFCRD.0128-03	CompactFlash 128 MB SSI
5CFCRD.0256-03	CompactFlash 256 MB SSI
5CFCRD.0512-03	CompactFlash 512 MB SSI
5CFCRD.1024-03	CompactFlash 1024 MB SSI
5CFCRD.2048-03	CompactFlash 2048 MB SSI
5CFCRD.4096-03	CompactFlash 4096 MB SSI
5CFCRD.8192-03	CompactFlash 8192 MB SSI



Table 42: Hard disk / CompactFlash slot (HDD/CF2)

Warning!

Turn off power before inserting or removing the CompactFlash card!

2.4.14 Power button

Due to the complete ATX power supply support, the power button serves various functions. These functions can be configured either in the BIOS setup (see BIOS function "Power button function" in section "Power", on page 290 for X945 CPU boards) or, for example, in the operating system Windows XP.

Power button	
<p>The power button can be pressed with a pointed object (e.g. paper clip or tip of a pen).</p> <p>The power button acts like the on/off switch on a normal desktop PC with ATX power supply: Press and release ... Switches on PPC700 or shuts down the operating system and switches off the PPC700. Press and hold ... ATX power supply switches off without shutting down the PPC700 (data could be lost!).</p> <p>Pressing the power button does not reset the MTCX processor.</p>	

Table 43: Power button

2.4.15 Reset button

Reset button	
<p>The reset button can be pressed with a pointed object (e.g. paper clip or tip of a pen).</p> <p>Pushing the reset button triggers a hardware and PCI reset. The PPC700 is restarted (cold restart).</p> <p>The MTCX processor is not reset when the reset button is pressed.</p>	

Table 44: Reset button

Warning!

A system reset can result in data loss!

2.4.16 PS/2 keyboard / mouse

Slot for a standard PS/2 mouse or a PS/2 AT-Enhanced keyboard. BIOS automatically determines whether a mouse or a keyboard has been connected and passes this information to the operating system.

With a PS/2 Y-cable, both keyboard and mouse can be operated simultaneously. They must be connected before the system is switched on.

This interface has a "hot plug" function for PS/2 keyboards (only when no PS/2 mouse has ever been connected and used!).

Connection for keyboard/mouse (PS/2)	
Pin	Assignment
1	DATA 0
2	DATA 1
3	GND
4	+5 V ¹⁾
5	CLK 0
6	CLK 1

PS/2 socket, female

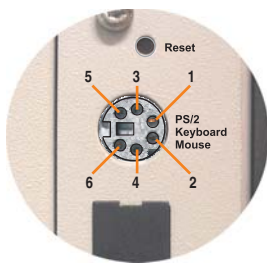

Table 45: Connection for external keyboard/mouse (PS/2)

1) The PS/2 keyboard/mouse interface is protected by a multifuse (1A).

Warning!

Because of general PC specifications, this interface should be used with extreme care concerning EMC, location of cables, etc.. It should therefore only be used for service!

Information:

The BIOS setup defaults only allow for the operation of a PS/2 keyboard. If a PS/2 mouse is connected, it must be enabled in BIOS. In order to do this, set "PS/2 mouse" in the BIOS setup menu to "Enabled" and save. (Located under "Advanced" / "Miscellaneous" / "PS/2 mouse").

2.4.17 Battery

The lithium battery (3 V, 950 mAh) buffers the internal real-time clock (RTC) as well as the individually saved BIOS settings and is located behind the black cover. The buffer duration of the battery is at least 4 years (at 50°C, 8.5 µA current requirements of the supplied components and a self discharge of 40%). The battery is subject to wear and should be replaced regularly (at least in accordance with the specified buffer duration).

Battery		
Battery Type Removable Service life	Renata 950 mAh Yes, accessible from the outside 4 years ¹⁾	
Accessories	Short description	
0AC201.91	Lithium batteries, 4 pcs. Lithium batteries, 4 pcs., 3 V / 950 mAh, button cell	
4A0006.00-000	Lithium battery, 1 pc. Lithium battery, 1 pc., 3 V / 950 mAh, button cell	

Table 46: Battery

1) At 50°C, 8.5 µA of the supplied components and a self discharge of 40%.

For more on changing the lithium battery, see chapter 7 "Maintenance / Servicing", section 1 "Changing the battery", on page 453.

For technical information on the lithium battery, see chapter 6 "Accessories", section 2 "Replacement CMOS batteries", on page 374.

Battery status evaluation

The battery status is evaluated immediately following start-up of the device and is subsequently checked by the system every 24 hours. The battery is subjected to a brief load (1 second) during the measurement and then evaluated. The evaluated battery status is displayed in the BIOS Setup pages (under Advanced - Baseboard monitor) and in the B&R Control Center (ADI driver), but can also be read in a customer application via the ADI Library.

Battery status	Meaning
N/A	Hardware, i.e. firmware used is too old and does not support read.
GOOD	Data buffering is guaranteed
BAD	Data buffering is guaranteed for approx. another 500 hours from the point in time that the battery capacity is determined to be BAD (insufficient).

Table 47: Meaning of battery status

[Hardware requirements \(system unit\)](#)

- 5PC720.1043-00 starting with Rev. K0
- 5PC720.1043-01 starting with Rev. I0
- 5PC720.1214-00 starting with Rev. K0
- 5PC720.1214-01 starting with Rev. D0
- 5PC720.1505-00 starting with Rev. M0
- 5PC720.1505-01 starting with Rev. L0
- 5PC720.1505-02 starting with Rev. K0
- 5PC720.1706-00 starting with Rev. E0
- 5PC720.1906-00 starting with Rev. G0
- 5PC781.1043-00 starting with Rev. H0
- 5PC781.1505-00 starting with Rev. J0
- 5PC782.1043-00 starting with Rev. H0

[Firmware / BIOS requirements](#)

- APC620 / Panel PC 700 Firmware Upgrade V1.19 (MTCX PX32: V1.63, MTCX FPGA V1.19)
- BIOS 855GME (ETX) V1.26, BIOS 855GME (XTX) V1.14

2.4.18 Hardware security key

B&R recommends a hardware security key (dongle) based on the DS1425 from MAXIM (previously Dallas Semiconductors) for software copy protection.

Hardware security key	
<p>A hardware security key (dongle) can be inserted behind the black cover.</p>	

Table 48: Hardware security key

Warning!

Turn off power before removing or adding the hardware security key.

I/O address and IRQ

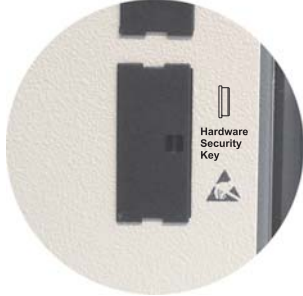
Resource	Default setting	Additional setting options
I/O address	378	278, 3BC
IRQ	-	-

Table 49: Hardware security key - I/O address and IRQ

The setting for the I/O address and the IRQ can be changed in the BIOS Setup ("Advanced" / "I/O Device Configuration" / "Parallel port").

2.4.19 Slide-in slot 1 drive slot

This slide-in slot 1 drive slot exists only in PPC700 system units with 1 or 2 PCI slots. It is possible to insert a number of slide-in drives into it. See table for available slide-in drives 8 "Model numbers - Drives", on page 28.

The slide-in USB FDD drive (5AC600.FDDS-00) is referred to as USB.

Information:

It is possible to add, remove, or modify the slide-in drive at any time.

Slide-in slot 1	
Connection	USB
Accessories	Short description
5AC600.FDDS-00	Slide-in USB FDD
	

Table 50: Slide-in slot 1

Caution!

Turn off power before adding or removing a slide-in drive.

2.5 Serial number sticker

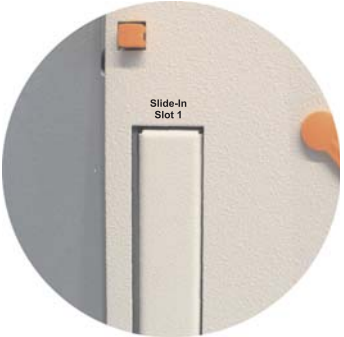
Each B&R device is assigned a unique serial number label with a bar code (type 128), which allows the device to be clearly identified.

The serial number for the entire device is located on the back of the device. This serial number represents all of the components built into the system (model number, name, revision, serial number, delivery date and duration of warranty).



Figure 34: Serial number sticker for PPC700 assembly (back)

A sticker with detailed information about the individual components can also be found on the device.



Figure 35: Serial number stickers for individual PPC700 components

This information can also be found on the B&R homepage. Enter the serial number for the entire device in the serial number search field on the start page www.br-automation.com. The search provides you with a detailed list of the individual components.

The screenshot shows the B&R website interface. At the top, there is a navigation bar with 'Company', 'Products', 'Service', 'Events', 'News', and 'myPortal'. The main content area is titled 'Industrial PCs > Panel PC > System units > SPC720.1505-00'. A search bar on the right contains the serial number '72580168752'. Below the search bar, there is a 'Serial Number' field with the value '72580168752'. A 'Description' section provides details about the Panel PC 720 15" XGA, 0 PCI slots, 15" XGA color TFT display with touch screen (resistiv), connections for 2 x RS232, 3 x USB 2.0, monitor, 2 x Ethernet 10/100, AC97 sound, PS/2 keyboard/mouse, IP65 protection (front side), 24 VDC. Plug for power supply must be ordered separately (see clamp: 078103.9; cage clamp: 078103.91).

Below the description, there is a table titled 'CREATE ORDER' with columns: Serial number, Model number, Rev, Delivery date, and End of warranty. The table contains one row of data:

Serial number	Model number	Rev	Delivery date	End of warranty
72580168752	SPC720.1505-00	F0	0000-00-00	0000-00-00

Below the table, there is a note: 'This material is part of a configured material which was assembled as follows.' Another table below that lists the components:

Serial number	Model number	Rev	Delivery date-0	End of warranty
72580168752	SPC720.1505-00	F0	0000-00-00	0000-00-00
720720165040	SPC700.FA89-01	B0	0000-00-00	0000-00-00
70420170406	SMHDDR.0512-00	C0	0000-00-00	0000-00-00
72840165291	SAC700.H011-01	F0	0000-00-00	0000-00-00
64380174752	SCPCRD.0512-02	C0	0000-00-00	0000-00-00
49080165798	SACA90.MC01-00	E0	0000-00-00	0000-00-00
72130149484	SPC600.E895-00	E6	0000-00-00	0000-00-00

On the right side of the page, there is a 'Product Search' section with a 'Serial Number' field containing '72580168752'. Below that, there is a 'List of installed components after the serial number search' section with a list of components including: APC620/Panel PC 700, Intel® i150/255GME, Chipset Software (Windows XP/Vista), APC620/Panel PC 700 AGI, Driver (Windows XP/Vista), APC620/Panel PC 700, Hard Drive (1000GB, SATA), (Windows XP/Vista), APC620/Panel PC 700, Intel® i150/255GME, (Windows XP/Vista), APC620/Panel PC 700, AC97, Audio driver (Windows XP/Vista).

Figure 36: Example of serial number search: 72580168752

3. Individual components

3.1 System units

All components (CPU board, fan, main memory, drives) are connected together to form the system unit.

3.1.1 Panel PC 5PC720.1043-00

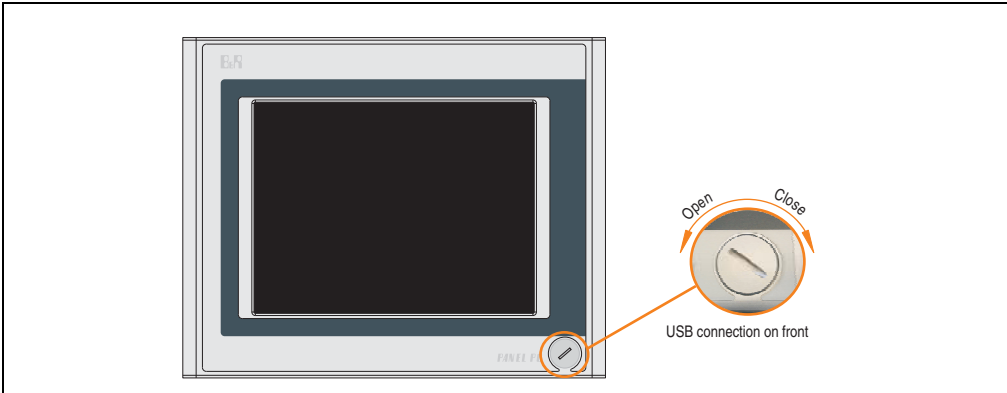

Figure 37: Front view 5PC720.1043-00

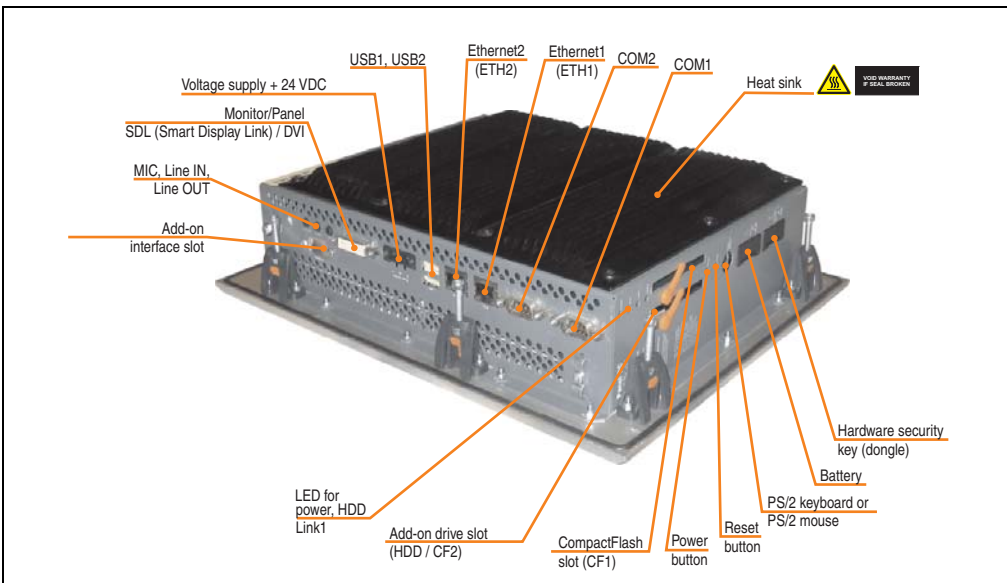

Figure 38: Rear view 5PC720.1043-00

Warning!

Do not remove mounting screws from the heat sink, as it is connected to the processor and chipset by a thermal coupling. If this connection is broken, the PPC700 must be sent for repair. Removal of the mounting screws, which can be determined by a broken seal, voids all warranty.

During operation, surface temperatures of the heat sink may reach 70°C (warning "hot surface").

Dimensions

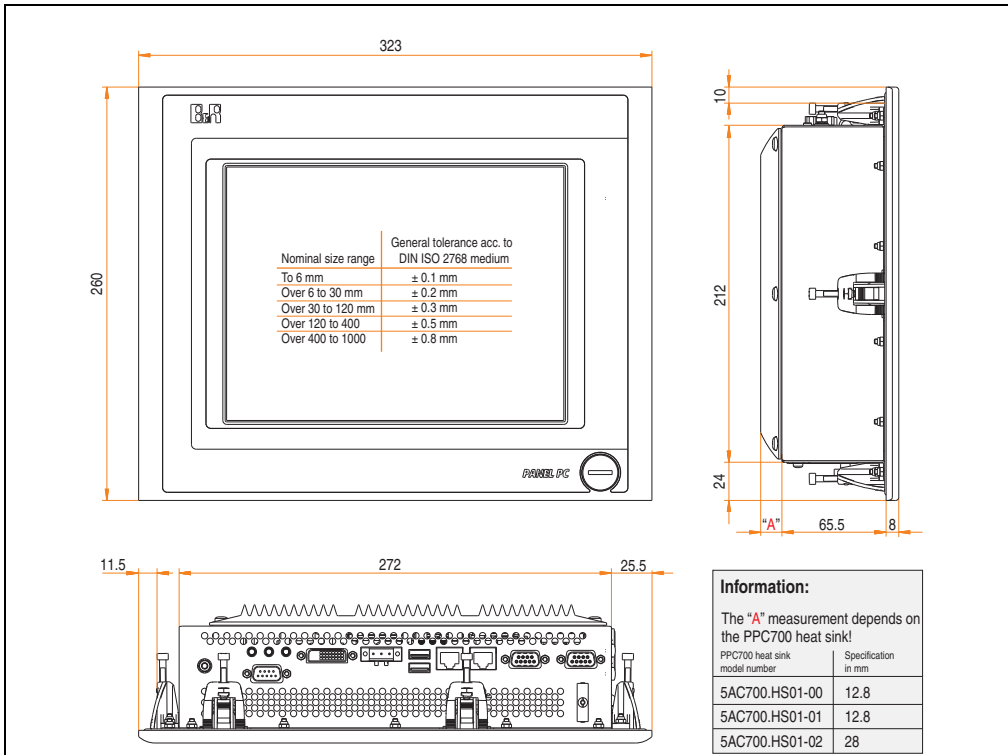

Figure 39: Dimensions - 5PC720.1043-00

Technical data

Features	5PC720.1043-00 ≤ 00	5PC720.1043-00 ≥ P0
B&R ID code	0x1C5C	
Serial interfaces	See "Serial interface COM1", on page 72 and "Serial interface COM2", on page 73	
Type	RS232, modem capable	
Amount	2	
UART	16550 compatible, 16 byte FIFO	
Transfer rate	Max. 115 kBaud	
Connection	9-pin DSUB, male	
Ethernet	See "Ethernet connection ETH1", on page 74 and "Ethernet connection ETH2", on page 76	
Controller	10/100 Mbit/s	
Transfer rate	RJ45 twisted pair (10 Base T / 100 Base T)	
Connection		
USB ports	See also "USB ports", on page 77	
Type	USB 2.0	
Amount	3 (2x back side, 1x front side)	
Transfer rate	Up to 480 Mbit ¹⁾ (high speed)	
Connection	Type A	
Monitor / Panel	See also "Monitor / Panel interface", on page 80	
Type	DVI-I, female	
AC97 sound	See also "MIC, Line IN and Line OUT ports", on page 81	
Inputs	Microphone, line in	
Outputs	Line out	
Add-on interface slot	See also "Add-on interface slot", on page 82	
Amount	1	
PCI slots	-	
Amount		
Type		
Standard		
CompactFlash slot 1 (CF1)	Yes, see also "CompactFlash slot (CF1)", on page 85	
Internal organization	Primary master	
CompactFlash slot 2 / hard disk (HDD/CF2)	Yes, see also "Hard disk / CompactFlash slot (HDD/CF2)", on page 86	
Type	Combined	
Internal organization	Primary slave	
Insert for slide-in drive 1	Yes, see also "Slide-in slot 1 drive slot", on page 92	
Internal organization	Secondary Slave	
SRAM internal slot options	No	
Reset button	Yes, see also "Power button", on page 87	
Power button	Yes, see also "Reset button", on page 87	
PS/2 keyboard / mouse	Yes, see also "PS/2 keyboard / mouse", on page 88	
Type	Combined, automatically detected	
Battery	Yes, see also "Battery", on page 89	
Type	Renata 950 mAh	
Removable	Yes, accessible from the outside	
Service life	4 years ²⁾	
Hardware security key compartment	Yes, see also "Hardware security key", on page 91	
Optimized for	DS1425 from MAXIM/Dallas	

Table 51: Technical data - 5PC720.1043-00

Technical data • Individual components

Features	5PC720.1043-00 ≤ 00	5PC720.1043-00 ≥ P0
Fan insert for fan kit	Yes, compatible fan kit - see section 3.8.2 "Fan kit 5PC700.FA02-00", on page 215	
LED Amount	See also "Status LEDs", on page 84 3 (Power, HDD, Link 1)	
Touch screen ³⁾ Touch screen type Technology Controller Degree of transmission	Elo Accu Touch Analog, resistive Elo, serial, 12-bit Up to 78%	AMT Analog, resistive Elo, serial, 12-bit Up to 81% ±3%
Display Type Diagonal Colors Resolution Contrast Viewing angle (see page 485) Horizontal Vertical Background lighting Type Brightness Half-brightness time ⁴⁾	Color TFT 10.4 inch (264 mm) 262,144 colors VGA, 640 x 480 pixels 300:1 Direction R / direction L = 70° Direction U / direction D = 70° CCFL 350 cd/m ² 50000 hours	
Keys Function keys Soft keys Cursor keys Number block Other keys Key lifespan LED brightness	-	
Electrical characteristics		
Power supply Rated voltage Rated current Starting current Power consumption Electrical isolation	See also "Supply voltage", on page 78 24 VDC ±25% 3.8 A Typ. 10 A, max. 40 A for < 300 µs See power management section "Power calculation for 10.4" Panel PC 700", on page 59 Yes	
Mechanical characteristics		
Front Frame Design Membrane Dark gray border around display Light background Gasket	Naturally anodized aluminum ⁵⁾ Gray ⁵⁾ Polyester Similar to Pantone432CV ⁵⁾ Similar to Pantone 427CV ⁵⁾ Flat gasket around display front	
Housing	Metal	
Outer dimensions Width Height Depth	Also see diagram "Dimensions - 5PC720.1043-00", on page 96 323 mm 260 mm 86.3 mm (depending on the heat sink)	
Weight	Approx. 3.6 kg	

Table 51: Technical data - 5PC720.1043-00 (Forts.)

Environmental characteristics	5PC720.1043-00 ≤ 00	5PC720.1043-00 ≥ P0
Ambient temperature Operation Bearings Transport	See 2.1.1 "Ambient temperatures with system unit 5PC720.1043-00", on page 44 -30 to +70°C -30 to +70°C	
Relative humidity Operation / Storage / Transport	T ≤ 40°C: 5% to 90%, non-condensing T > 40°C: < 90%, non-condensing	
Vibration Operation (continuous) Operation (occasional) Bearings Transport	2 - 9 Hz: 1.75 mm amplitude / 9 - 200 Hz: 0.5 g 2 - 9 Hz: 3.5 mm amplitude / 9 - 200 Hz: 1 g 2 - 8 Hz: 7.5 mm amplitude / 8 - 200 Hz: 2 g / 200 - 500 Hz: 4 g 2 - 8 Hz: 7.5 mm amplitude / 8 - 200 Hz: 2 g / 200 - 500 Hz: 4 g	
Shock Operation Bearings Transport	15 g, 11 ms 30 g, 15 ms 30 g, 15 ms	
Protection	IP20 back side (only with installed CompactFlash card) IP65 / NEMA 250 type 4X, dust and sprayed water protection (front side)	
Altitude	Max. 3,000 m	

Table 51: Technical data - 5PC720.1043-00 (Forts.)

- 1) Software must support USB 2.0 (e.g. Windows XP with at least Service Pack 1).
- 2) At 50°C, 8.5 µA of the supplied components and a self discharge of 40%.
- 3) Touch screen drivers can be downloaded from the download area on the B&R homepage (www.br-automation.com).
- 4) At 25°C ambient temperature. Reducing the brightness by 50% can result in an approximate 50% increase of the half-brightness time.
- 5) Depending on the process or batch, there may be visible deviations in the color and surface structure.

Cutout installation

The Panel PC 700 with preassembled mounting blocks is installed e.g. in a housing cutout. A cutout that corresponds to the following drawing must be made.

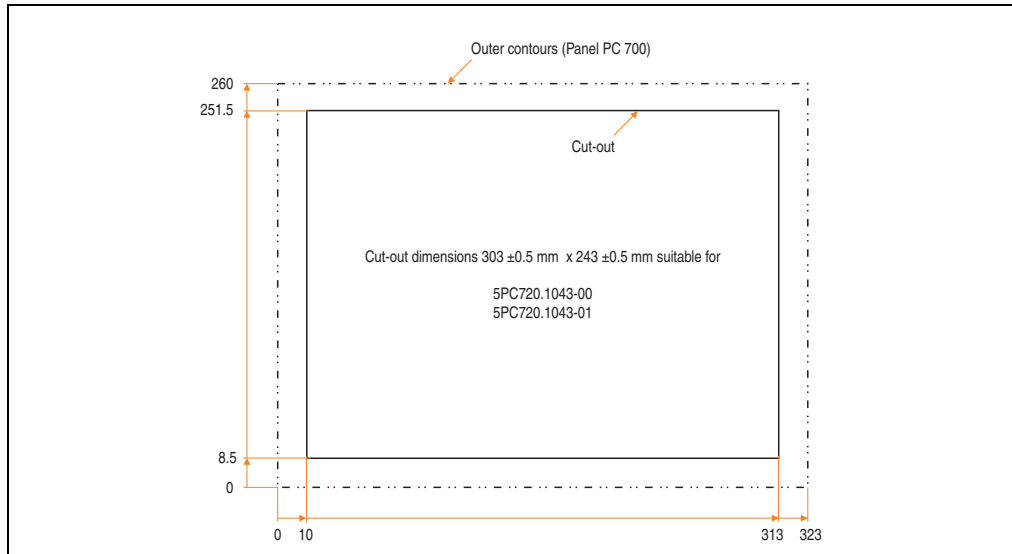

Figure 40: Cutout installation - 5PC720.1043-00

For further information regarding mounting and installation position, see chapter 3 "Commissioning", on page 219.

3.1.2 Panel PC 5PC720.1043-01

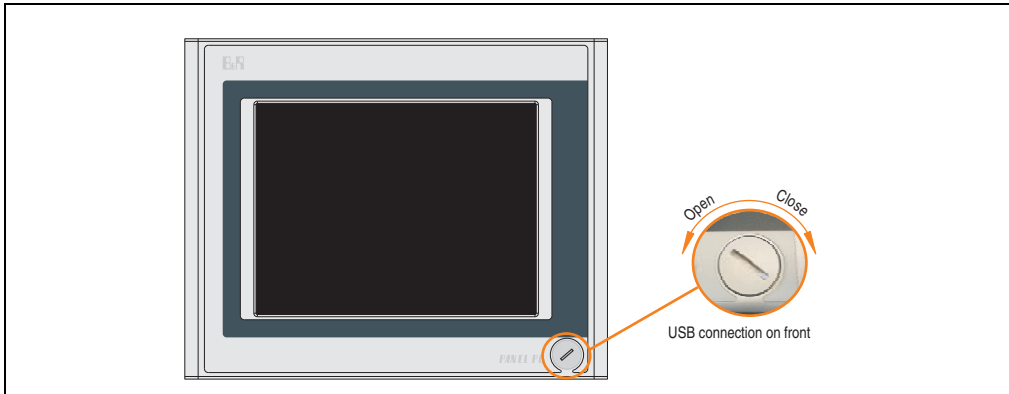

Figure 41: Front view 5PC720.1043-01

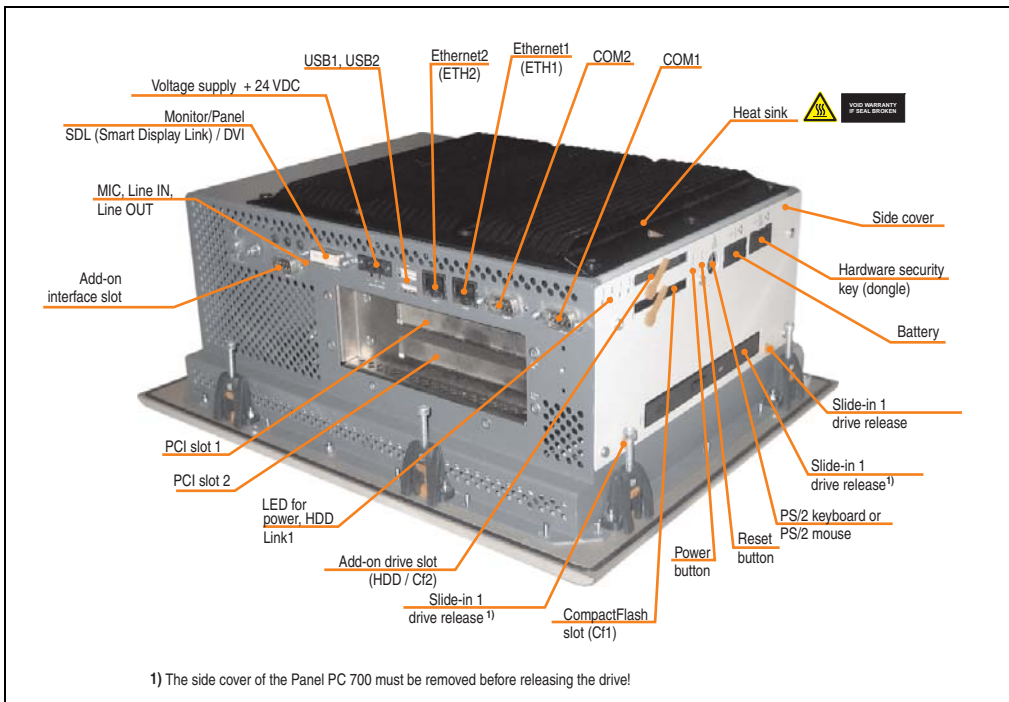

Figure 42: Rear view 5PC720.1043-01

Warning!

Do not remove mounting screws from the heat sink, as it is connected to the processor and chipset by a thermal coupling. If this connection is broken, the PPC700 must be sent for repair. Removal of the mounting screws, which can be determined by a broken seal, voids all warranty.

During operation, surface temperatures of the heat sink may reach 70°C (warning "hot surface").

Dimensions

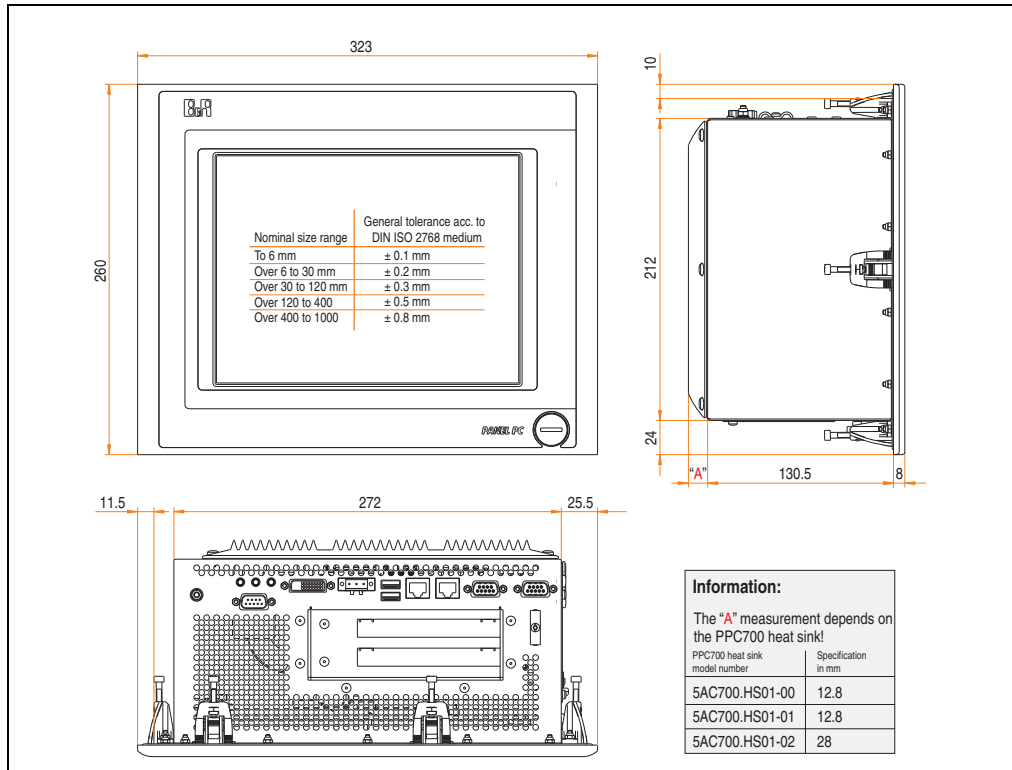

Figure 43: Dimensions - 5PC720.1043-01

Technical data

Features	5PC720.1043-01 ≤ M0	5PC720.1043-01 ≥ N0
B&R ID code	0x1C5D	
Serial interfaces	See "Serial interface COM1", on page 72 and "Serial interface COM2", on page 73	
Type	RS232, modem capable	
Amount	2	
UART	16550 compatible, 16 byte FIFO	
Transfer rate	Max. 115 kBaud	
Connection	9-pin DSUB, male	
Ethernet	See "Ethernet connection ETH1", on page 74 and "Ethernet connection ETH2", on page 76	
Controller	10/100 Mbit/s	
Transfer rate	RJ45 twisted pair (10 Base T / 100 Base T)	
Connection		
USB ports	See also "USB ports", on page 77	
Type	USB 2.0	
Amount	3 (2x back side, 1x front side)	
Transfer rate	Up to 480 Mbit ¹⁾ (high speed)	
Connection	Type A	
Monitor / Panel	See also "Monitor / Panel interface", on page 80	
Type	DVI-I, female	
AC97 sound	See also "MIC, Line IN and Line OUT ports", on page 81	
Inputs	Microphone, line in	
Outputs	Line out	
Add-on interface slot	See also "Add-on interface slot", on page 82	
Amount	1	
PCI slots	See also "PCI slots", on page 83	
Amount	2	
Type	Half-size	
Standard	According to PCI half-size standard 2.2	
CompactFlash slot 1 (CF1)	Yes, see also "CompactFlash slot (CF1)", on page 85	
Internal organization	Primary master	
CompactFlash slot 2 / hard disk (HDD/CF2)	Yes, see also "Hard disk / CompactFlash slot (HDD/CF2)", on page 86	
Type	Combined	
Internal organization	Primary slave	
Insert for slide-in drive 1	Yes, see also "Slide-in slot 1 drive slot", on page 92	
Internal organization	Secondary Slave	
SRAM internal slot options	Yes (available starting with revision I0)	
Reset button	Yes, see also "Power button", on page 87	
Power button	Yes, see also "Reset button", on page 87	
PS/2 keyboard / mouse	Yes, see also "PS/2 keyboard / mouse", on page 88	
Type	Combined, automatically detected	
Battery	Yes, see also "Battery", on page 89	
Type	Renata 950 mAh	
Removable	Yes, accessible from the outside	
Service life	4 years ²⁾	
Hardware security key compartment	Yes, see also "Hardware security key", on page 91	
Optimized for	DS1425 from MAXIM/Dallas	

Table 52: Technical data - 5PC720.1043-01

Technical data • Individual components

Features	5PC720.1043-01 ≤ M0	5PC720.1043-01 ≥ N0
Fan insert for fan kit	Yes, compatible fan kit - see section 3.8.2 "Fan kit 5PC700.FA02-00", on page 215	
LED Amount	See also "Status LEDs", on page 84 3 (Power, HDD, Link 1)	
Touch screen ³⁾ Touch screen type Technology Controller Degree of transmission	Elo Accu Touch Analog, resistive Elo, serial, 12-bit Up to 78%	AMT Analog, resistive Elo, serial, 12-bit Up to 81% ±3%
Display Type Diagonal Colors Resolution Contrast Viewing angle (see page 485) Horizontal Vertical Background lighting Type Brightness Half-brightness time ⁴⁾	Color TFT 10.4 inch (264 mm) 262,144 colors VGA, 640 x 480 pixels 300:1 Direction R / direction L = 70° Direction U / direction D = 70° CCFL 350 cd/m ² 50000 hours	
Keys Function keys Soft keys Cursor keys Number block Other keys Key lifespan LED brightness	-	
Electrical characteristics		
Power supply Rated voltage Rated current Starting current Power consumption Electrical isolation	See also "Supply voltage", on page 78 24 VDC ±25% 3.8 A Typ. 10 A, max. 40 A for < 300 µs See power management section "Power calculation for 10.4" Panel PC 700", on page 59 Yes	
Mechanical characteristics		
Front Frame Design Membrane Dark gray border around display Light background Gasket	Naturally anodized aluminum ⁵⁾ Gray ⁵⁾ Polyester Similar to Pantone432CV ⁵⁾ Similar to Pantone 427CV ⁵⁾ Flat gasket around display front	
Housing	Metal	
Outer dimensions Width Height Depth	Also see diagram "Dimensions - 5PC720.1043-01", on page 102 323 mm 260 mm 151.3 mm (depending on the heat sink)	
Weight	Approx. 4.5 kg	

Table 52: Technical data - 5PC720.1043-01 (Forts.)

Environmental characteristics	5PC720.1043-01 ≤ M0	5PC720.1043-01 ≥ N0
Ambient temperature Operation Bearings Transport	See 2.1.2 "Ambient temperatures with system unit 5PC720.1043-01", on page 45 -30 to +70°C -30 to +70°C	
Relative humidity Operation / Storage / Transport	T ≤ 40°C: 5% to 90%, non-condensing T > 40°C: < 90%, non-condensing	
Vibration Operation (continuous) Operation (occasional) Bearings Transport	2 - 9 Hz: 1.75 mm amplitude / 9 - 200 Hz: 0.5 g 2 - 9 Hz: 3.5 mm amplitude / 9 - 200 Hz: 1 g 2 - 8 Hz: 7.5 mm amplitude / 8 - 200 Hz: 2 g / 200 - 500 Hz: 4 g 2 - 8 Hz: 7.5 mm amplitude / 8 - 200 Hz: 2 g / 200 - 500 Hz: 4 g	
Shock Operation Bearings Transport	15 g, 11 ms 30 g, 15 ms 30 g, 15 ms	
Protection	IP20 back side (only with installed CompactFlash card) IP65 / NEMA 250 type 4X, dust and sprayed water protection (front side)	
Altitude	Max. 3,000 m	

Table 52: Technical data - 5PC720.1043-01 (Forts.)

- 1) Software must support USB 2.0 (e.g. Windows XP with at least Service Pack 1).
- 2) At 50°C, 8.5 µA of the supplied components and a self discharge of 40%.
- 3) Touch screen drivers can be downloaded from the download area on the B&R homepage (www.br-automation.com).
- 4) At 25°C ambient temperature. Reducing the brightness by 50% can result in an approximate 50% increase of the half-brightness time.
- 5) Depending on the process or batch, there may be visible deviations in the color and surface structure.

Cutout installation

The Panel PC 700 with preassembled mounting blocks is installed e.g. in a housing cutout. A cutout that corresponds to the following drawing must be made.

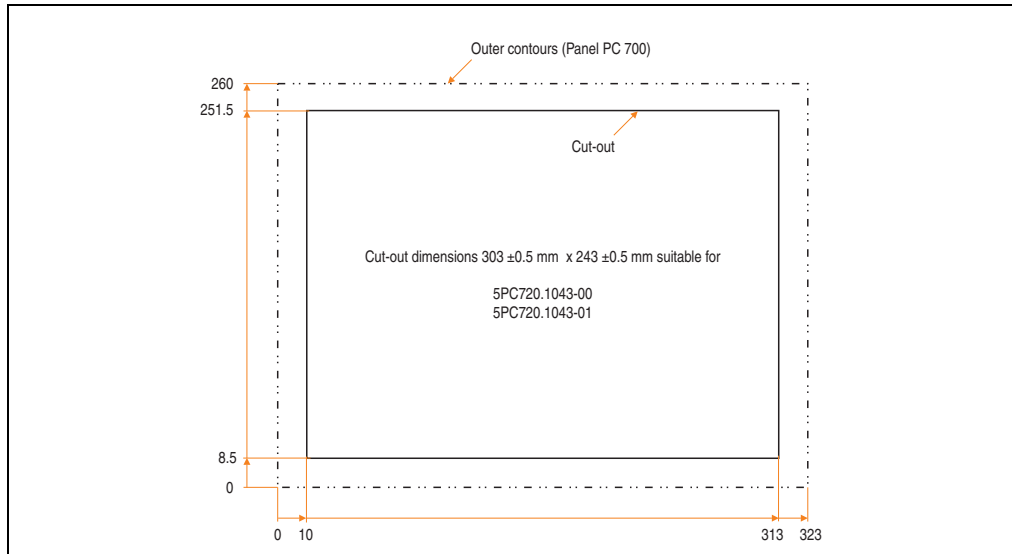

Figure 44: Cutout installation - 5PC720.1043-01

For further information regarding mounting and installation position, see chapter 3 "Commissioning", on page 219.

3.1.3 Panel PC 5PC720.1214-00

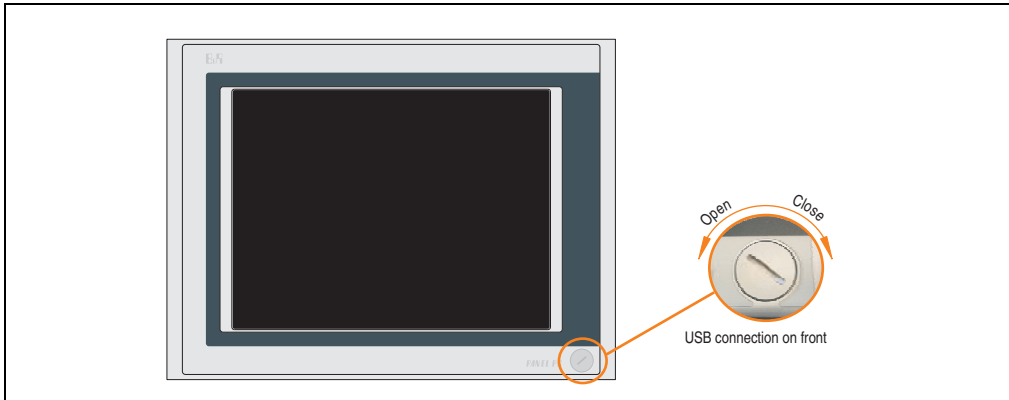

Figure 45: Front view 5PC720.1214-00

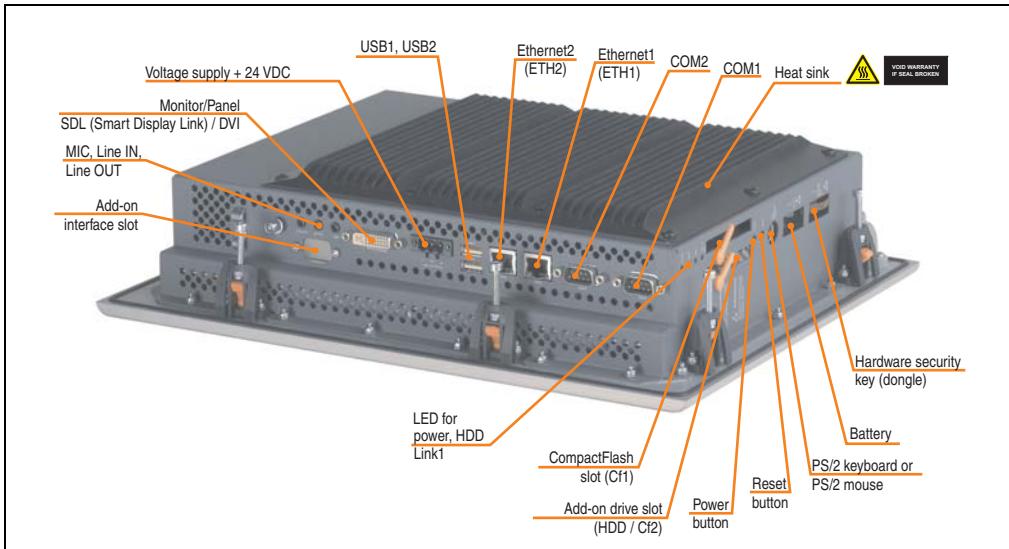

Figure 46: Rear view 5PC720.1214-00

Warning!

Do not remove mounting screws from the heat sink, as it is connected to the processor and chipset by a thermal coupling. If this connection is broken, the PPC700 must be sent for repair. Removal of the mounting screws, which can be determined by a broken seal, voids all warranty.

During operation, surface temperatures of the heat sink may reach 70°C (warning "hot surface").

Dimensions

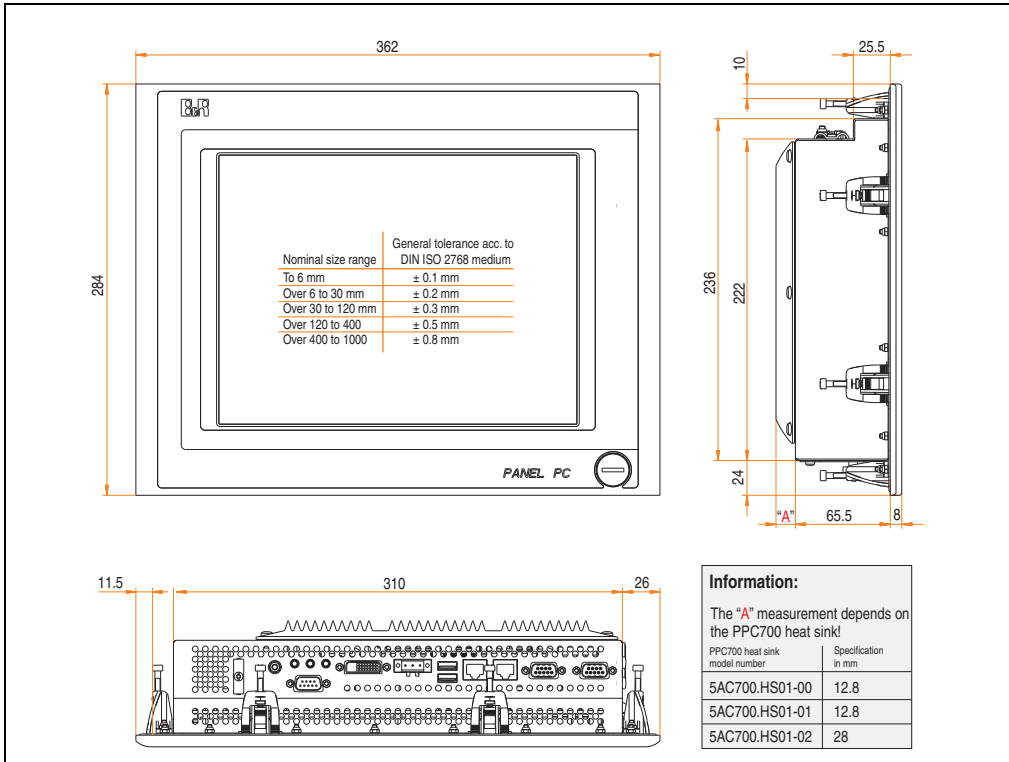

Figure 47: Dimensions - 5PC720.1214-00

Technical data

Features	5PC720.1214-00 ≤ 00	5PC720.1214-00 = P0	5PC720.1214-00 ≥ Q0
B&R ID code	0x1C5E		
Serial interfaces	See "Serial interface COM1", on page 72 and "Serial interface COM2", on page 73		
Type	RS232, modem capable		
Amount	2		
UART	16550 compatible, 16 byte FIFO		
Transfer rate	Max. 115 kBaud		
Connection	9-pin DSUB, male		
Ethernet	See "Ethernet connection ETH1", on page 74 and "Ethernet connection ETH2", on page 76		
Controller	10/100 Mbit/s		
Transfer rate	RJ45 twisted pair (10 Base T / 100 Base T)		
Connection			
USB ports	See also "USB ports", on page 77		
Type	USB 2.0		
Amount	3 (2x back side, 1x front side)		
Transfer rate	Up to 480 Mbit ¹⁾ (high speed)		
Connection	Type A		
Monitor / Panel	See also "Monitor / Panel interface", on page 80		
Type	DVI-I, female		
AC97 sound	See also "MIC, Line IN and Line OUT ports", on page 81		
Inputs	Microphone, line in		
Outputs	Line out		
Add-on interface slot	See also "Add-on interface slot", on page 82		
Amount	1		
PCI slots	-		
Amount			
Type			
Standard			
CompactFlash slot 1 (CF1)	Yes, see also "CompactFlash slot (CF1)", on page 85		
Internal organization	Primary master		
CompactFlash slot 2 / hard disk (HDD/CF2)	Yes, see also "Hard disk / CompactFlash slot (HDD/CF2)", on page 86		
Type	Combined		
Internal organization	Primary slave		
Insert for slide-in drive 1	-		
Internal organization			
SRAM internal slot options	No		
Reset button	Yes, see also "Power button", on page 87		
Power button	Yes, see also "Reset button", on page 87		
PS/2 keyboard / mouse	Yes, see also "PS/2 keyboard / mouse", on page 88		
Type	Combined, automatically detected		
Battery	Yes, see also "Battery", on page 89		
Type	Renata 950 mAh		
Removable	Yes, accessible from the outside		
Service life	4 years ²⁾		
Hardware security key compartment	Yes, see also "Hardware security key", on page 91		
Optimized for	DS1425 from MAXIM/Dallas		

Table 53: Technical data - 5PC720.1214-00

Technical data • Individual components

Features	5PC720.1214-00 ≤ O0	5PC720.1214-00 = P0	5PC720.1214-00 ≥ Q0
Fan insert for fan kit	Yes, compatible fan kit - see section 3.8.1 "Fan kit 5PC700.FA00-01", on page 214		
LED Amount	See also "Status LEDs", on page 84 3 (Power, HDD, Link 1)		
Touch screen ³⁾ Touch screen type Technology Controller Degree of transmission	Elo Accu Touch Analog, resistive Elo, serial, 12-bit Up to 78%	AMT Analog, resistive Elo, serial, 12-bit Up to 81% ±3%	
Display Type Diagonal Colors Resolution Contrast Viewing angle (see page 485) Horizontal Vertical Background lighting Type Brightness Half-brightness time ⁴⁾	Color TFT 12.1 inch (307 mm) 262,144 colors SVGA, 800 x 600 pixels 300:1 Direction R / direction L = 70° Direction U / direction D = 70° CCFL 350 cd/m ² 50000 hours		Color TFT 12.1 inch (307 mm) 262,144 colors SVGA, 800 x 600 pixels 800:1 Direction R / direction L = 80° Direction U / direction D = 60° LED 450 cd/m ² 50,000 hours
Keys Function keys Soft keys Cursor keys Number block Other keys Key lifespan LED brightness	-		
Electrical characteristics			
Power supply Rated voltage Rated current Starting current Power consumption Electrical isolation	See also "Supply voltage", on page 78 24 VDC ±25% 3.8 A Typ. 10 A, max. 40 A for < 300 µs See power management section "Power calculation for 12.1" Panel PC 700", on page 60 Yes		
Mechanical characteristics			
Front Frame Design Membrane Dark gray border around display Light background Gasket	Naturally anodized aluminum ⁵⁾ Gray ⁵⁾ Polyester Similar to Pantone432CV ⁵⁾ Similar to Pantone 427CV ⁵⁾ Flat gasket around display front		
Housing	Metal		
Outer dimensions Width Height Depth	Also see diagram "Dimensions - 5PC720.1214-00", on page 108 362 mm 284 mm 86.3 mm (depending on the heat sink)		
Weight	Approx. 4.2 kg		

Table 53: Technical data - 5PC720.1214-00 (Forts.)

Environmental characteristics	5PC720.1214-00 ≤ 00	5PC720.1214-00 = P0	5PC720.1214-00 ≥ Q0
Ambient temperature Operation Bearings Transport	See 2.1.3 "Ambient temperatures with system unit 5PC720.1214-00", on page 46 -30 to +70°C -30 to +70°C		
Relative humidity Operation / Storage / Transport	T ≤ 40°C: 5% to 90%, non-condensing T > 40°C: < 90%, non-condensing		
Vibration Operation (continuous) Operation (occasional) Bearings Transport	2 - 9 Hz: 1.75 mm amplitude / 9 - 200 Hz: 0.5 g 2 - 9 Hz: 3.5 mm amplitude / 9 - 200 Hz: 1 g 2 - 8 Hz: 7.5 mm amplitude / 8 - 200 Hz: 2 g / 200 - 500 Hz: 4 g 2 - 8 Hz: 7.5 mm amplitude / 8 - 200 Hz: 2 g / 200 - 500 Hz: 4 g		
Shock Operation Bearings Transport	15 g, 11 ms 30 g, 15 ms 30 g, 15 ms		
Protection	IP20 back side (only with installed CompactFlash card) IP65 / NEMA 250 type 4X, dust and sprayed water protection (front side)		
Altitude	Max. 3,000 m		

Table 53: Technical data - 5PC720.1214-00 (Forts.)

- 1) Software must support USB 2.0 (e.g. Windows XP with at least Service Pack 1).
- 2) At 50°C, 8.5 µA of the supplied components and a self discharge of 40%.
- 3) Touch screen drivers can be downloaded from the download area on the B&R homepage (www.br-automation.com).
- 4) At 25°C ambient temperature. Reducing the brightness by 50% can result in an approximate 50% increase of the half-brightness time.
- 5) Depending on the process or batch, there may be visible deviations in the color and surface structure.

Cutout installation

The Panel PC 700 with preassembled mounting blocks is installed e.g. in a housing cutout. A cutout that corresponds to the following drawing must be made.

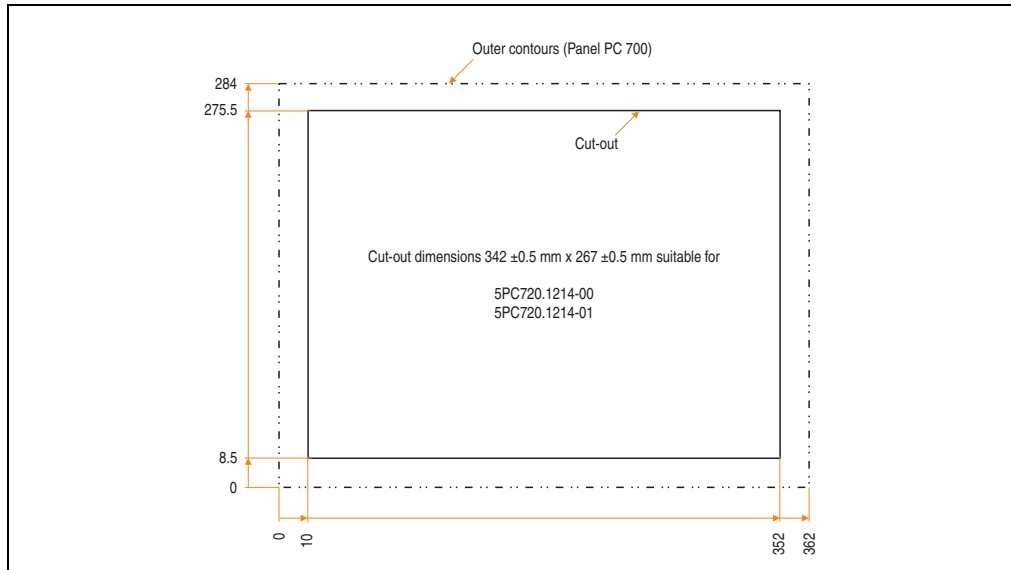

Figure 48: Cutout installation - 5PC720.1214-00

For further information regarding mounting and installation position, see chapter 3 "Commissioning", on page 219.

3.1.4 Panel PC 5PC720.1214-01

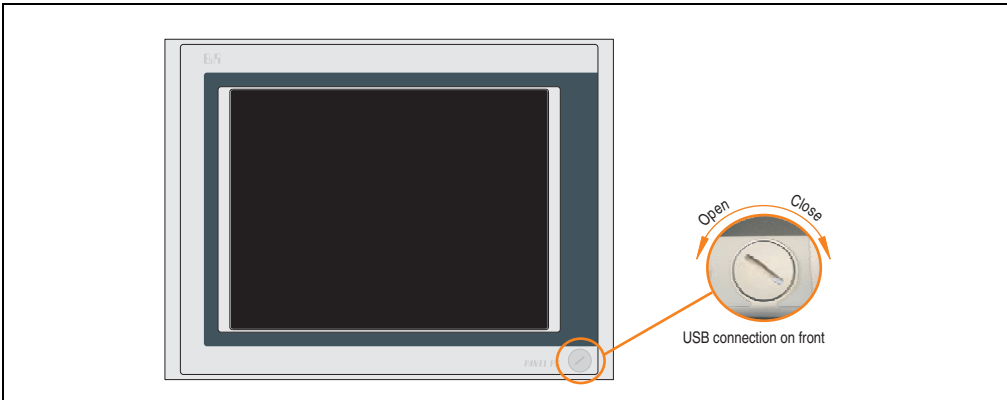

Figure 49: Front view 5PC720.1214-01

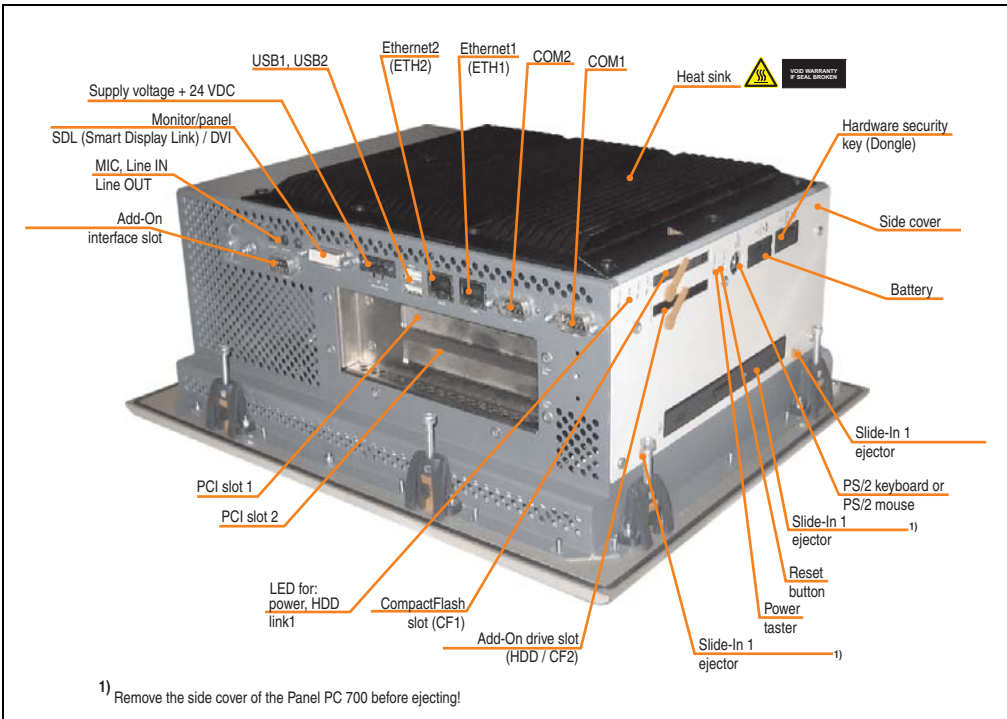

Figure 50: Rear view - 5PC720.1214-01

Warning!

Do not remove mounting screws from the heat sink, as it is connected to the processor and chipset by a thermal coupling. If this connection is broken, the PPC700 must be sent for repair. Removal of the mounting screws, which can be determined by a broken seal, voids all warranty.

During operation, surface temperatures of the heat sink may reach 70°C (warning "hot surface").

Dimensions

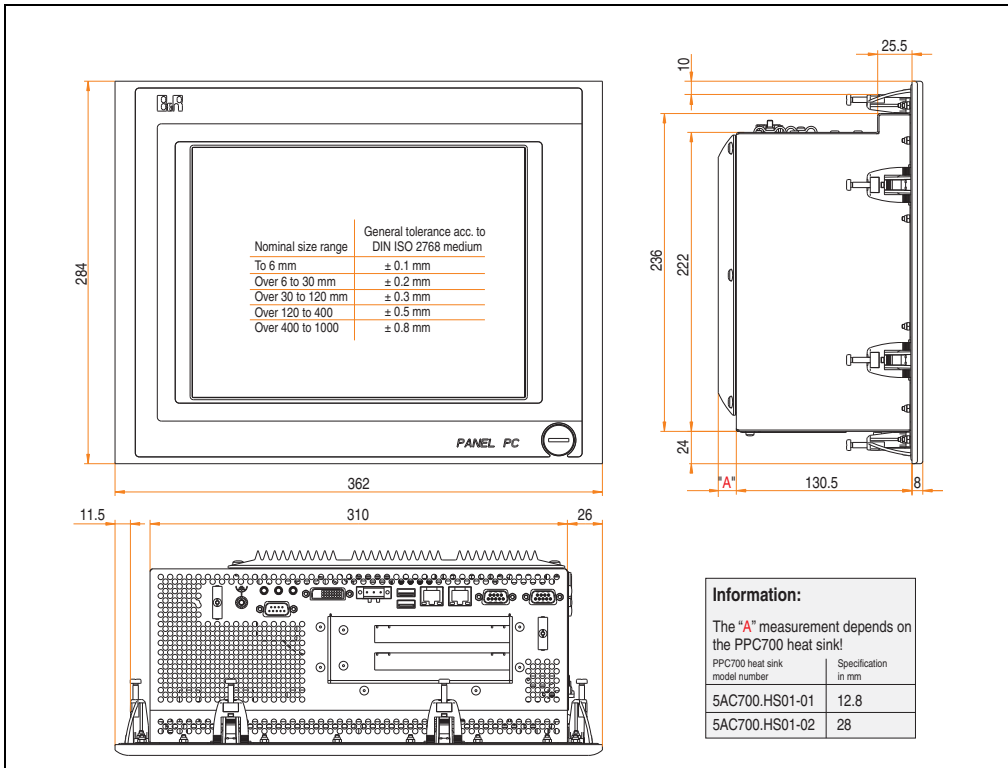

Figure 51: Dimensions - 5PC720.1214-01

Technical data

Features	5PC720.1214-01 ≤ H0	5PC720.1214-01 ≥ I0	5PC720.1214-01 ≥ K0
B&R ID code	0x254C		
Serial interfaces	See "Serial interface COM1", on page 72 and "Serial interface COM2", on page 73		
Type	RS232, modem capable		
Amount	2		
UART	16550 compatible, 16 byte FIFO		
Transfer rate	Max. 115 kBaud		
Connection	9-pin DSUB, male		
Ethernet	See "Ethernet connection ETH1", on page 74 and "Ethernet connection ETH2", on page 76		
Controller	10/100 Mbit/s		
Transfer rate	RJ45 twisted pair (10 Base T / 100 Base T)		
Connection			
USB ports	See also "USB ports", on page 77		
Type	USB 2.0		
Amount	3 (2x back side, 1x front side)		
Transfer rate	Up to 480 Mbit ¹⁾ (high speed)		
Connection	Type A		
Monitor / Panel	See also "Monitor / Panel interface", on page 80		
Type	DVI-I, female		
AC97 sound	See also "MIC, Line IN and Line OUT ports", on page 81		
Inputs	Microphone, line in		
Outputs	Line out		
Add-on interface slot	See also "Add-on interface slot", on page 82		
Amount	1		
PCI slots	See also "PCI slots", on page 83		
Amount	2		
Type	Half-size		
Standard	According to PCI half-size standard 2.2		
CompactFlash slot 1 (CF1)	Yes, see also "CompactFlash slot (CF1)", on page 85		
Internal organization	Primary master		
CompactFlash slot 2 / hard disk (HDD/CF2)	Yes, see also "Hard disk / CompactFlash slot (HDD/CF2)", on page 86		
Type	Combined		
Internal organization	Primary slave		
Insert for slide-in drive 1	-		
Internal organization			
SRAM internal slot options	Yes (available starting with revision D0)		
Reset button	Yes, see also "Power button", on page 87		
Power button	Yes, see also "Reset button", on page 87		
PS/2 keyboard / mouse	Yes, see also "PS/2 keyboard / mouse", on page 88		
Type	Combined, automatically detected		
Battery	Yes, see also "Battery", on page 89		
Type	Renata 950 mAh		
Removable	Yes, accessible from the outside		
Service life	4 years ²⁾		
Hardware security key compartment	Yes, see also "Hardware security key", on page 91		
Optimized for	DS1425 from MAXIM/Dallas		

Table 54: Technical data - 5PC720.1214-01

Technical data • Individual components

Features	5PC720.1214-01 ≤ H0	5PC720.1214-01 ≥ I0	5PC720.1214-01 ≥ K0
Fan insert for fan kit	Yes, compatible fan kit - see section 3.8.1 "Fan kit 5PC700.FA00-01", on page 214		
LED Amount	See also "Status LEDs", on page 84 3 (Power, HDD, Link 1)		
Touch screen ³⁾ Touch screen type Technology Controller Degree of transmission	Elo Accu Touch Analog, resistive Elo, serial, 12-bit Up to 78%	AMT Analog, resistive Elo, serial, 12-bit Up to 81% ±3%	
Display Type Diagonal Colors Resolution Contrast Viewing angle (see page 485) Horizontal Vertical Background lighting Type Brightness Half-brightness time ⁴⁾	Color TFT 12.1 inch (307 mm) 262,144 colors SVGA, 800 x 600 pixels 300:1 Direction R / direction L = 70° Direction U / direction D = 70° CCFL 350 cd/m ² 50000 hours		Color TFT 12.1 inch (307 mm) 262,144 colors SVGA, 800 x 600 pixels 800:1 Direction R / direction L = 80° Direction U / direction D = 60° LED 450 cd/m ² 50,000 hours
Keys Function keys Soft keys Cursor keys Number block Other keys Key lifespan LED brightness	-		
Electrical characteristics			
Power supply Rated voltage Rated current Starting current Power consumption Electrical isolation	See also "Supply voltage", on page 78 24 VDC ±25% 3.8 A Typ. 10 A, max. 40 A for < 300 µs See power management section "Power calculation for 12.1" Panel PC 700", on page 60 Yes		
Mechanical characteristics			
Front Frame Design Membrane Dark gray border around display Light background Gasket	Naturally anodized aluminum ⁵⁾ Gray ⁵⁾ Polyester Similar to Pantone432CV ⁵⁾ Similar to Pantone 427CV ⁵⁾ Flat gasket around display front		
Housing	Metal		
Outer dimensions Width Height Depth	Also see diagram "Dimensions - 5PC720.1214-01", on page 114 362 mm 284 mm 151.3 mm (depending on the heat sink)		
Weight	Approx. 5.3 kg		

Table 54: Technical data - 5PC720.1214-01 (Forts.)

Environmental characteristics	5PC720.1214-01 ≤ H0	5PC720.1214-01 ≥ I0	5PC720.1214-01 ≥ K0
Ambient temperature Operation Bearings Transport	See 2.1.4 "Ambient temperatures with system unit 5PC720.1214-01", on page 47 -30 to +70°C -30 to +70°C		
Relative humidity Operation / Storage / Transport	T ≤ 40°C: 5% to 90%, non-condensing T > 40°C: < 90%, non-condensing		
Vibration Operation (continuous) Operation (occasional) Bearings Transport	2 - 9 Hz: 1.75 mm amplitude / 9 - 200 Hz: 0.5 g 2 - 9 Hz: 3.5 mm amplitude / 9 - 200 Hz: 1 g 2 - 8 Hz: 7.5 mm amplitude / 8 - 200 Hz: 2 g / 200 - 500 Hz: 4 g 2 - 8 Hz: 7.5 mm amplitude / 8 - 200 Hz: 2 g / 200 - 500 Hz: 4 g		
Shock Operation Bearings Transport	15 g, 11 ms 30 g, 15 ms 30 g, 15 ms		
Protection	IP20 back side (only with installed CompactFlash card) IP65 / NEMA 250 type 4X, dust and sprayed water protection (front side)		
Altitude	Max. 3,000 m		

Table 54: Technical data - 5PC720.1214-01 (Forts.)

- 1) Software must support USB 2.0 (e.g. Windows XP with at least Service Pack 1).
- 2) At 50°C, 8.5 µA of the supplied components and a self discharge of 40%.
- 3) Touch screen drivers can be downloaded from the download area on the B&R homepage (www.br-automation.com).
- 4) At 25°C ambient temperature. Reducing the brightness by 50% can result in an approximate 50% increase of the half-brightness time.
- 5) Depending on the process or batch, there may be visible deviations in the color and surface structure.

Cutout installation

The Panel PC 700 with preassembled mounting blocks is installed e.g. in a housing cutout. A cutout that corresponds to the following drawing must be made.

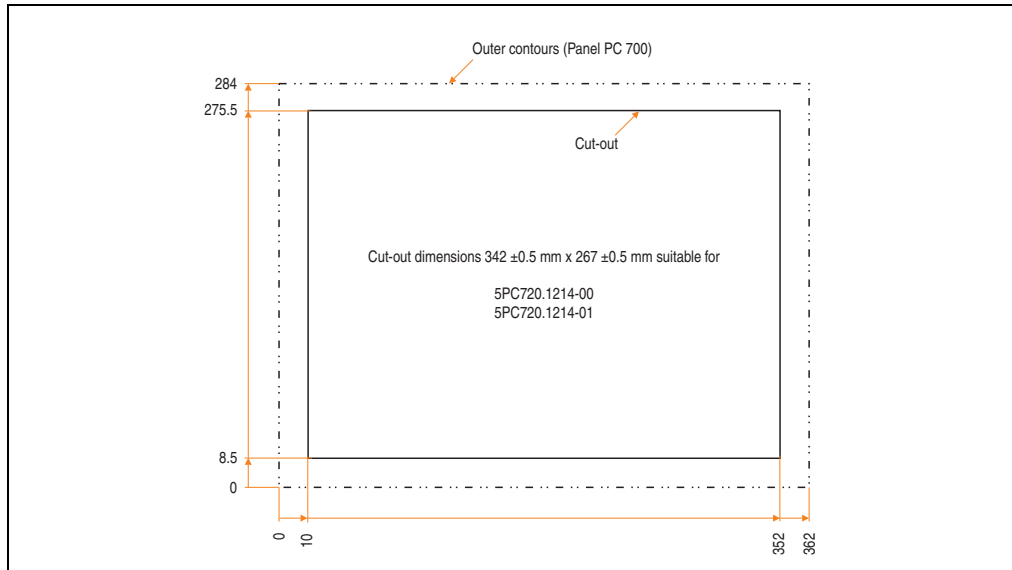

Figure 52: Cutout installation - 5PC720.1214-01

For further information regarding mounting and installation position, see chapter 3 "Commissioning", on page 219.

3.1.5 Panel PC 5PC720.1505-00

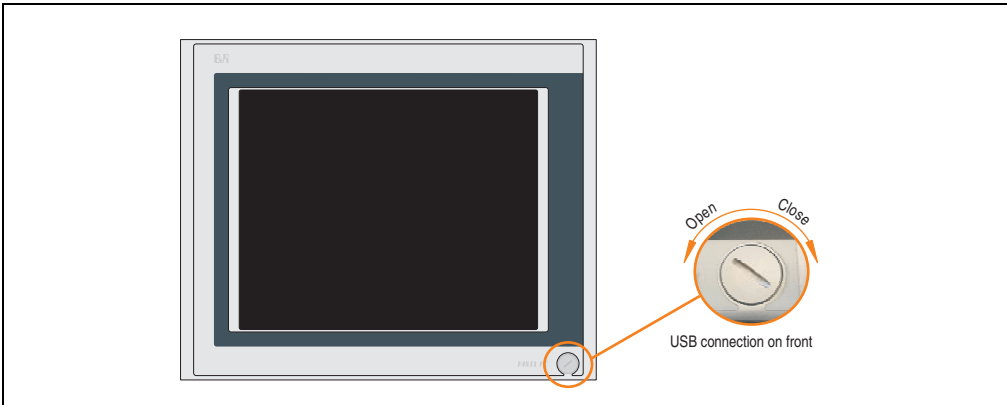

Figure 53: Front view 5PC720.1505-00

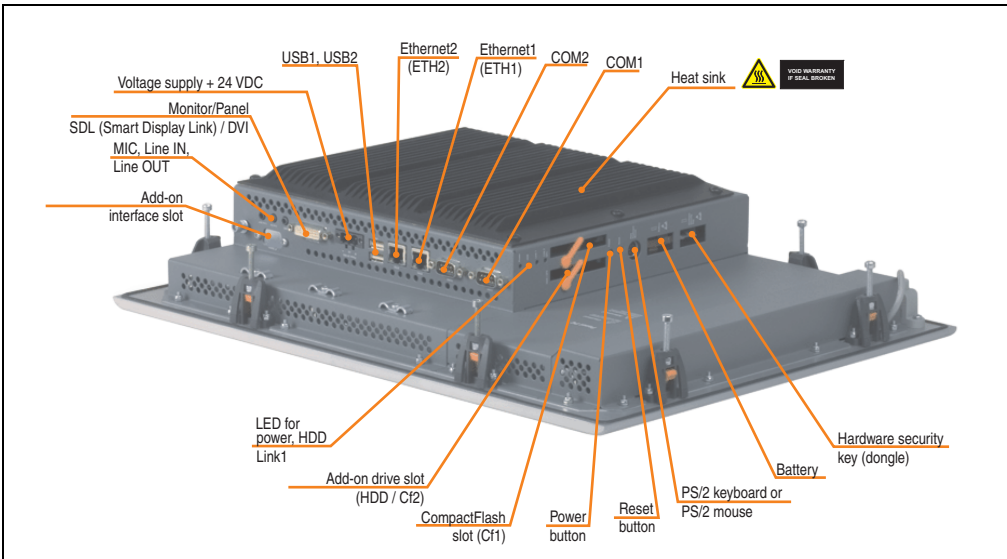

Figure 54: Rear view 5PC720.1505-00

Warning!

Do not remove mounting screws from the heat sink, as it is connected to the processor and chipset by a thermal coupling. If this connection is broken, the PPC700 must be sent for repair. Removal of the mounting screws, which can be determined by a broken seal, voids all warranty.

During operation, surface temperatures of the heat sink may reach 70°C (warning "hot surface").

Dimensions

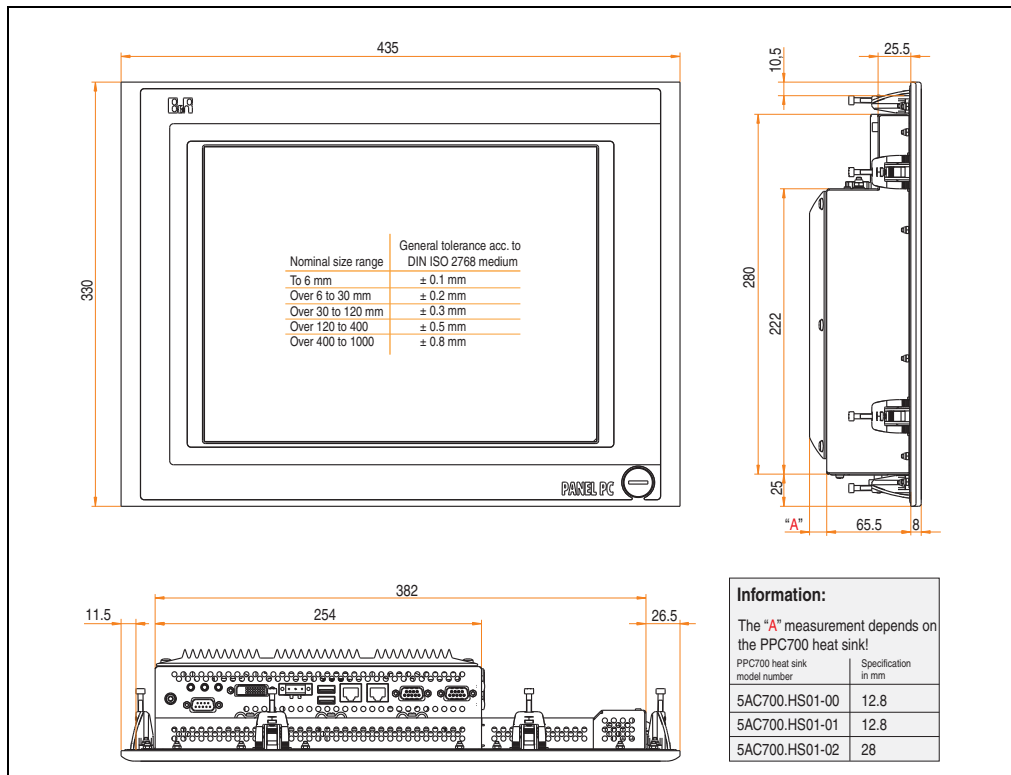

Figure 55: Dimensions - 5PC720.1505-00

Technical data

Features	5PC720.1505-00 ≤ Q0	5PC720.1505-00 ≥ R0	5PC720.1505-00 ≥ U0
B&R ID code	0x1C5A		
Serial interfaces	See "Serial interface COM1", on page 72 and "Serial interface COM2", on page 73		
Type	RS232, modem capable		
Amount	2		
UART	16550 compatible, 16 byte FIFO		
Transfer rate	Max. 115 kBaud		
Connection	9-pin DSUB, male		
Ethernet	See "Ethernet connection ETH1", on page 74 and "Ethernet connection ETH2", on page 76		
Controller	10/100 Mbit/s		
Transfer rate	RJ45 twisted pair (10 Base T / 100 Base T)		
Connection			
USB ports	See also "USB ports", on page 77		
Type	USB 2.0		
Amount	3 (2x back side, 1x front side)		
Transfer rate	Up to 480 Mbit ¹⁾ (high speed)		
Connection	Type A		
Monitor / Panel	See also "Monitor / Panel interface", on page 80		
Type	DVI-I, female		
AC97 sound	See also "MIC, Line IN and Line OUT ports", on page 81		
Inputs	Microphone, line in		
Outputs	Line out		
Add-on interface slot	See also "Add-on interface slot", on page 82		
Amount	1		
PCI slots	-		
Amount			
Type			
Standard			
CompactFlash slot 1 (CF1)	Yes, see also "CompactFlash slot (CF1)", on page 85		
Internal organization	Primary master		
CompactFlash slot 2 / hard disk (HDD/CF2)	Yes, see also "Hard disk / CompactFlash slot (HDD/CF2)", on page 86		
Type	Combined		
Internal organization	Primary slave		
Insert for slide-in drive 1	-		
Internal organization			
SRAM internal slot options	No		
Reset button	Yes, see also "Power button", on page 87		
Power button	Yes, see also "Reset button", on page 87		
PS/2 keyboard / mouse	Yes, see also "PS/2 keyboard / mouse", on page 88		
Type	Combined, automatically detected		
Battery	Yes, see also "Battery", on page 89		
Type	Renata 950 mAh		
Removable	Yes, accessible from the outside		
Service life	4 years ²⁾		
Hardware security key compartment	Yes, see also "Hardware security key", on page 91		
Optimized for	DS1425 from MAXIM/Dallas		

Table 55: Technical data - 5PC720.1505-00

Technical data • Individual components

Features	5PC720.1505-00 ≤ Q0	5PC720.1505-00 ≥ R0	5PC720.1505-00 ≥ U0
Fan insert for fan kit	Yes, compatible fan kit - see section 3.8.1 "Fan kit 5PC700.FA00-01", on page 214		
LED Amount	See also "Status LEDs", on page 84 3 (Power, HDD, Link 1)		
Touch screen ³⁾ Touch screen type Technology Controller Degree of transmission	Elo Accu Touch Analog, resistive Elo, serial, 12-bit Up to 78%	AMT analog, resistiv Elo, seriell, 12 Bit bis zu 81% ±3%	
Display Type Diagonal Colors Resolution Contrast Viewing angle (see page 485) Horizontal Vertical Background lighting Type Brightness Half-brightness time ⁴⁾	Color TFT 15 inch (381 mm) 16 million XGA, 1024 x 768 pixels 400:1 Direction R / direction L = 85° Direction U / direction D = 85° CCFL 250 cd/m ² 50000 hours		TFT Farbe 15 inch (381 mm) 16 Mio. XGA, 1024 x 768 Bildpunkte 1000:1 Richtung R / Richtung L = 85° Richtung U / Richtung D = 85° LED 350 cd/m ² 70000 Stunden
Keys Function keys Soft keys Cursor keys Number block Other keys Key lifespan LED brightness	-		
Electrical characteristics			
Power supply Rated voltage Rated current Starting current Power consumption Electrical isolation	See also "Supply voltage", on page 78 24 VDC ±25% 3.8 A Typ. 10 A, max. 40 A for < 300 µs See power management section "Power calculation for 15" Panel PC 700", on page 61 Yes		
Mechanical characteristics			
Front Frame Design Membrane Dark gray border around display Light background Gasket	Naturally anodized aluminum ⁵⁾ Gray ⁵⁾ Polyester Similar to Pantone432CV ⁵⁾ Similar to Pantone 427CV ⁵⁾ Flat gasket around display front		
Housing	Metal		
Outer dimensions Width Height Depth	Also see diagram "Dimensions - 5PC720.1505-00", on page 120 435 mm 330 mm 86.3 mm (depending on the heat sink)		
Weight	Approx. 6 kg		

Table 55: Technical data - 5PC720.1505-00 (Forts.)

Environmental characteristics	5PC720.1505-00 ≤ Q0	5PC720.1505-00 ≥ R0	5PC720.1505-00 ≥ U0
Ambient temperature Operation Bearings Transport	See 2.1.5 "Ambient temperatures with system unit 5PC720.1505-00", on page 48		
Relative humidity Operation / Storage / Transport	T ≤ 40°C: 5% to 90%, non-condensing T > 40°C: < 90%, non-condensing		
Vibration Operation (continuous) Operation (occasional) Bearings Transport	2 - 9 Hz: 1.75 mm amplitude / 9 - 200 Hz: 0.5 g 2 - 9 Hz: 3.5 mm amplitude / 9 - 200 Hz: 1 g 2 - 8 Hz: 7.5 mm amplitude / 8 - 200 Hz: 2 g / 200 - 500 Hz: 4 g 2 - 8 Hz: 7.5 mm amplitude / 8 - 200 Hz: 2 g / 200 - 500 Hz: 4 g		
Shock Operation Bearings Transport	15 g, 11 ms 30 g, 15 ms 30 g, 15 ms		
Protection	IP20 back side (only with installed CompactFlash card) IP65 / NEMA 250 type 4X, dust and sprayed water protection (front side)		
Altitude	Max. 3,000 m		

Table 55: Technical data - 5PC720.1505-00 (Forts.)

- 1) Software must support USB 2.0 (e.g. Windows XP with at least Service Pack 1).
- 2) At 50°C, 8.5 µA of the supplied components and a self discharge of 40%.
- 3) Touch screen drivers can be downloaded from the download area on the B&R homepage (www.br-automation.com).
- 4) At 25°C ambient temperature. Reducing the brightness by 50% can result in an approximate 50% increase of the half-brightness time.
- 5) Depending on the process or batch, there may be visible deviations in the color and surface structure.

Cutout installation

The Panel PC 700 with preassembled mounting blocks is installed e.g. in a housing cutout. A cutout that corresponds to the following drawing must be made.

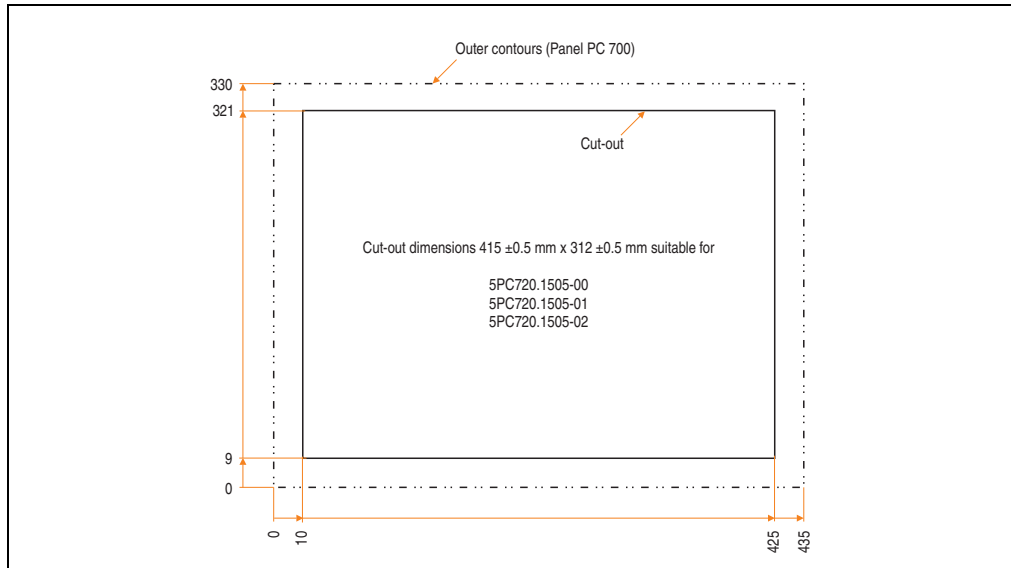

Figure 56: Cutout installation - 5PC720.1505-00

For further information regarding mounting and installation position, see chapter 3 "Commissioning", on page 219.

3.1.6 Panel PC 5PC720.1505-01

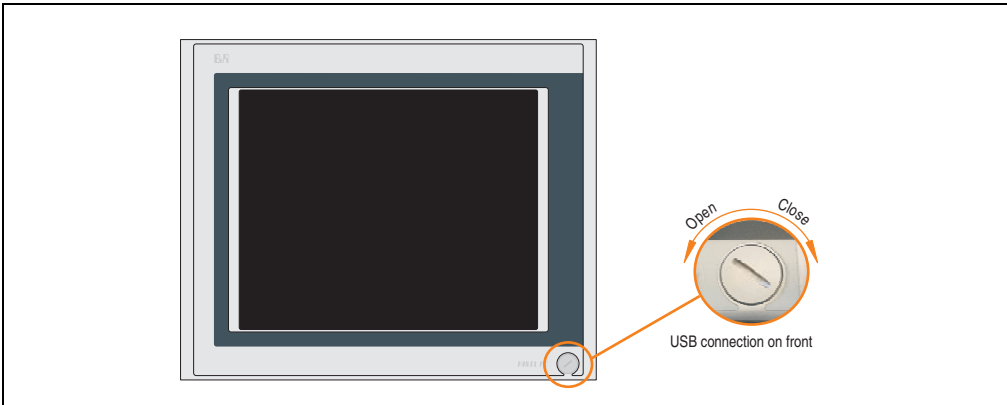

Figure 57: Front view 5PC720.1505-01

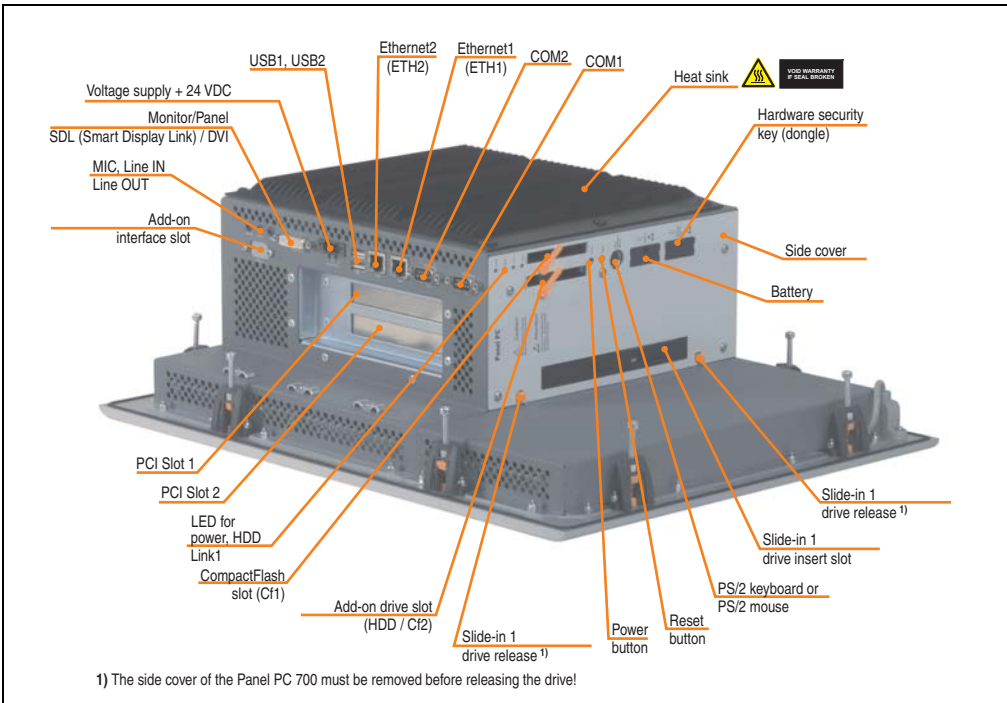

Figure 58: Rear view 5PC720.1505-01

Warning!

Do not remove mounting screws from the heat sink, as it is connected to the processor and chipset by a thermal coupling. If this connection is broken, the PPC700 must be sent for repair. Removal of the mounting screws, which can be determined by a broken seal, voids all warranty.

During operation, surface temperatures of the heat sink may reach 70°C (warning "hot surface").

Dimensions

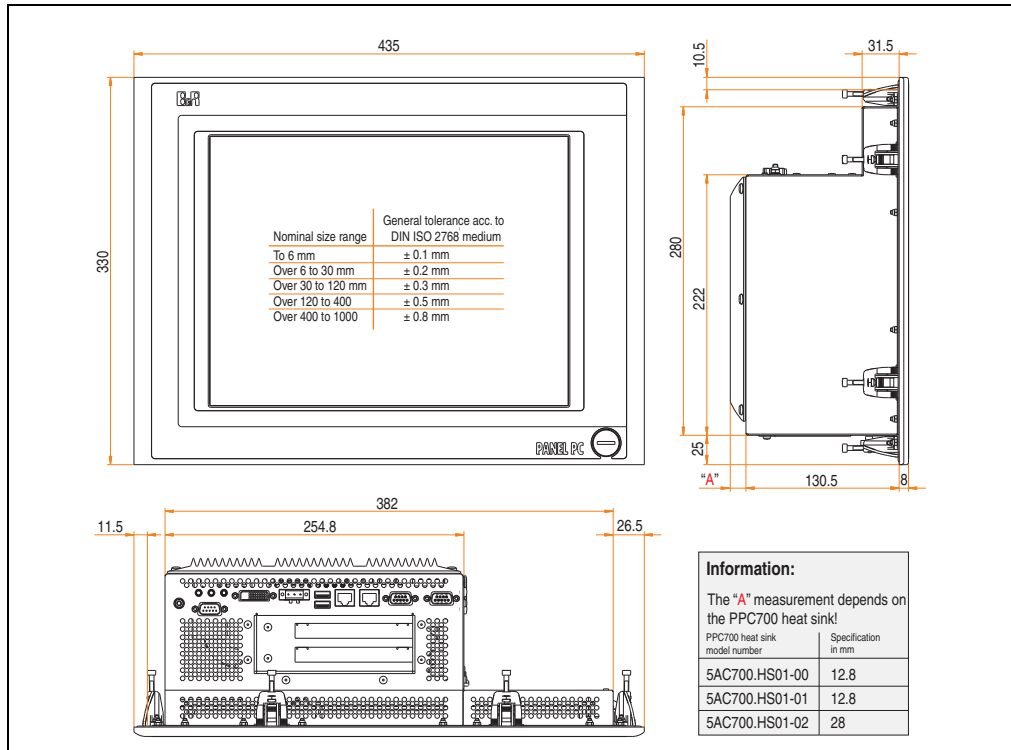

Figure 59: Dimensions - 5PC720.1505-01

Technical data

Features	5PC720.1505-01 ≤ O0	5PC720.1505-01 ≥ P0	5PC720.1505-01 ≥ S0
B&R ID code	0x1C5B		
Serial interfaces	See "Serial interface COM1", on page 72 and "Serial interface COM2", on page 73		
Type	RS232, modem capable		
Amount	2		
UART	16550 compatible, 16 byte FIFO		
Transfer rate	Max. 115 kBaud		
Connection	9-pin DSUB, male		
Ethernet	See "Ethernet connection ETH1", on page 74 and "Ethernet connection ETH2", on page 76		
Controller	10/100 Mbit/s		
Transfer rate	RJ45 twisted pair (10 Base T / 100 Base T)		
Connection			
USB ports	See also "USB ports", on page 77		
Type	USB 2.0		
Amount	3 (2x back side, 1x front side)		
Transfer rate	Up to 480 Mbit ¹⁾ (high speed)		
Connection	Type A		
Monitor / Panel	See also "Monitor / Panel interface", on page 80		
Type	DVI-I, female		
AC97 sound	See also "MIC, Line IN and Line OUT ports", on page 81		
Inputs	Microphone, line in		
Outputs	Line out		
Add-on interface slot	See also "Add-on interface slot", on page 82		
Amount	1		
PCI slots	See also "PCI slots", on page 83		
Amount	2		
Type	Half-size		
Standard	According to PCI half-size standard 2.2		
CompactFlash slot 1 (CF1)	Yes, see also "CompactFlash slot (CF1)", on page 85		
Internal organization	Primary master		
CompactFlash slot 2 / hard disk (HDD/CF2)	Yes, see also "Hard disk / CompactFlash slot (HDD/CF2)", on page 86		
Type	Combined		
Internal organization	Primary slave		
Insert for slide-in drive 1	Yes, see also "Slide-in slot 1 drive slot", on page 92		
Internal organization	Secondary Slave		
SRAM internal slot options	Yes (available starting with revision L0)		
Reset button	Yes, see also "Power button", on page 87		
Power button	Yes, see also "Reset button", on page 87		
PS/2 keyboard / mouse	Yes, see also "PS/2 keyboard / mouse", on page 88		
Type	Combined, automatically detected		
Battery	Yes, see also "Battery", on page 89		
Type	Renata 950 mAh		
Removable	Yes, accessible from the outside		
Service life	4 years ²⁾		
Hardware security key compartment	Yes, see also "Hardware security key", on page 91		
Optimized for	DS1425 from MAXIM/Dallas		

Table 56: Technical data - 5PC720.1505-01

Technical data • Individual components

Features	5PC720.1505-01 ≤ O0	5PC720.1505-01 ≥ P0	5PC720.1505-01 ≥ S0
Fan insert for fan kit	Yes, compatible fan kit - see section 3.8.3 "Fan kit 5PC700.FA02-01", on page 217		
LED Amount	See also "Status LEDs", on page 84 3 (Power, HDD, Link 1)		
Touch screen ³⁾ Touch screen type Technology Controller Degree of transmission	Elo Accu Touch Analog, resistive Elo, serial, 12-bit Up to 78%	AMT analog, resistiv Elo, seriell, 12 Bit bis zu 81% ±3%	
Display Type Diagonal Colors Resolution Contrast Viewing angle (see page 485) Horizontal Vertical Background lighting Type Brightness Half-brightness time ⁴⁾	Color TFT 15 inch (381 mm) 16 million XGA, 1024 x 768 pixels 400:1 Direction R / direction L = 85° Direction U / direction D = 85° CCFL 250 cd/m ² 50000 hours		TFT Farbe 15 inch (381 mm) 16 Mio. XGA, 1024 x 768 Bildpunkte 1000:1 Richtung R / Richtung L = 85° Richtung U / Richtung D = 85° LED 350 cd/m ² 70000 Stunden
Keys/LED Function keys Soft keys Cursor keys Number block Other keys Key lifespan LED brightness	-		
Electrical characteristics			
Power supply Rated voltage Rated current Starting current Power consumption Electrical isolation	See also "Supply voltage", on page 78 24 VDC ±25% 3.8 A Typ. 10 A, max. 40 A for < 300 µs See power management section "Power calculation for 15" Panel PC 700", on page 61 Yes		
Mechanical characteristics			
Front Frame Design Membrane Dark gray border around display Light background Gasket	Naturally anodized aluminum ⁵⁾ Gray ⁵⁾ Polyester Similar to Pantone 432CV ⁵⁾ Similar to Pantone 427CV ⁵⁾ Flat gasket around display front		
Housing	Metal		
Outer dimensions Width Height Depth	Also see diagram "Dimensions - 5PC720.1505-01", on page 126 435 mm 330 mm 151.3 mm (depending on the heat sink)		
Weight	Approx. 6.7 kg		

Table 56: Technical data - 5PC720.1505-01 (Forts.)

Environmental characteristics	5PC720.1505-01 ≤ O0	5PC720.1505-01 ≥ P0	5PC720.1505-01 ≥ S0
Ambient temperature Operation Bearings Transport	See 2.1.6 "Ambient temperatures with system unit 5PC720.1505-01", on page 49 -20 to +60°C -20 to +60°C		
Relative humidity Operation / Storage / Transport	T ≤ 40°C: 5% to 90%, non-condensing T > 40°C: < 90%, non-condensing		
Vibration Operation (continuous) Operation (occasional) Bearings Transport	2 - 9 Hz: 1.75 mm amplitude / 9 - 200 Hz: 0.5 g 2 - 9 Hz: 3.5 mm amplitude / 9 - 200 Hz: 1 g 2 - 8 Hz: 7.5 mm amplitude / 8 - 200 Hz: 2 g / 200 - 500 Hz: 4 g 2 - 8 Hz: 7.5 mm amplitude / 8 - 200 Hz: 2 g / 200 - 500 Hz: 4 g		
Shock Operation Bearings Transport	15 g, 11 ms 30 g, 15 ms 30 g, 15 ms		
Protection	IP20 back side (only with installed CompactFlash card) IP65 / NEMA 250 type 4X, dust and sprayed water protection (front side)		
Altitude	Max. 3,000 m		

Table 56: Technical data - 5PC720.1505-01 (Forts.)

- 1) Software must support USB 2.0 (e.g. Windows XP with at least Service Pack 1).
- 2) At 50°C, 8.5 µA of the supplied components and a self discharge of 40%.
- 3) Touch screen drivers can be downloaded from the download area on the B&R homepage (www.br-automation.com).
- 4) At 25°C ambient temperature. Reducing the brightness by 50% can result in an approximate 50% increase of the half-brightness time.
- 5) Depending on the process or batch, there may be visible deviations in the color and surface structure.

Cutout installation

The Panel PC 700 with preassembled mounting blocks is installed e.g. in a housing cutout. A cutout that corresponds to the following drawing must be made.

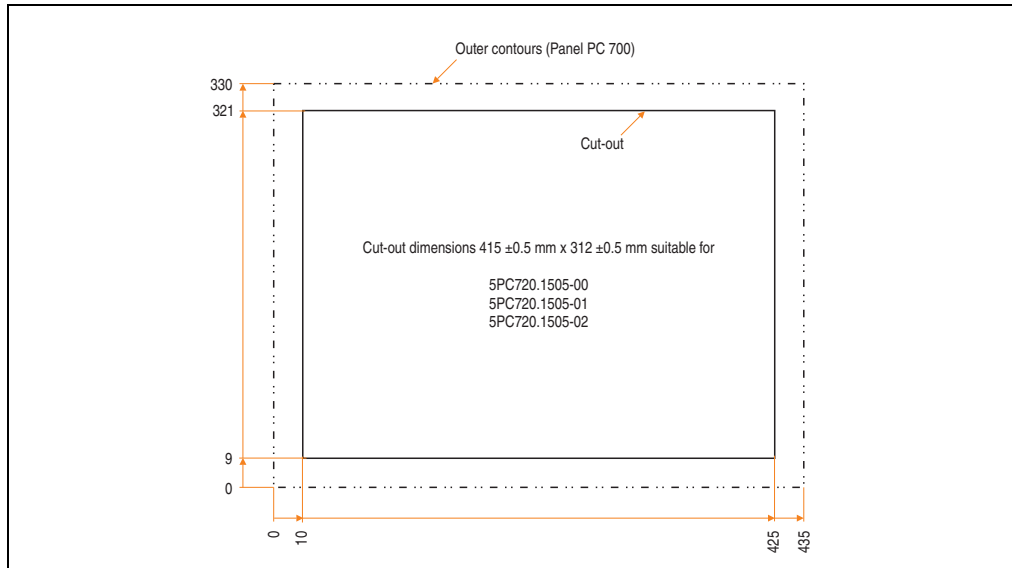

Figure 60: Cutout installation - 5PC720.1505-01

For further information regarding mounting and installation position, see chapter 3 "Commissioning", on page 219.

3.1.7 Panel PC 5PC720.1505-02

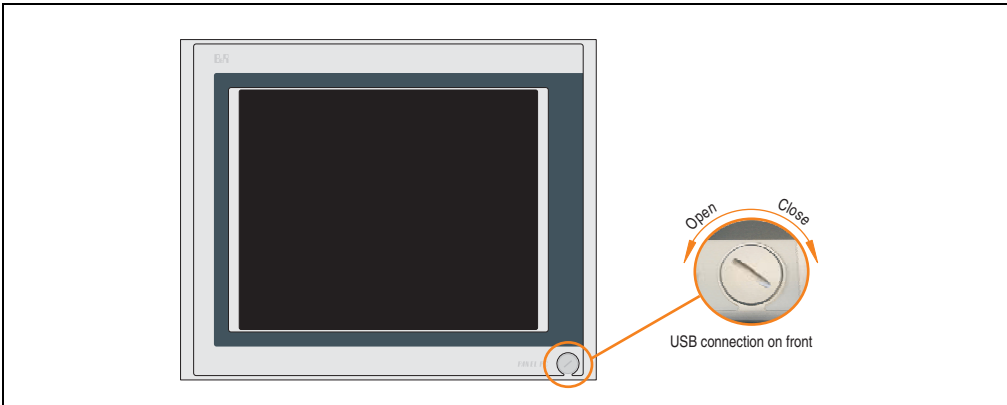

Figure 61: Front view 5PC720.1505-02

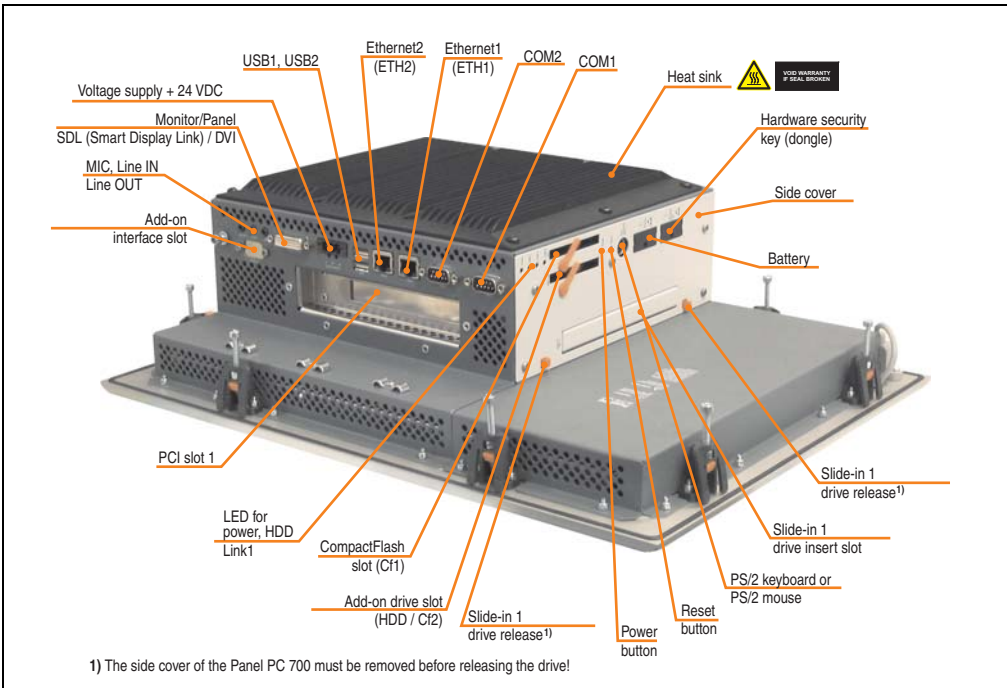

Figure 62: Rear view 5PC720.1505-02

Warning!

Do not remove mounting screws from the heat sink, as it is connected to the processor and chipset by a thermal coupling. If this connection is broken, the PPC700 must be sent for repair. Removal of the mounting screws, which can be determined by a broken seal, voids all warranty.

During operation, surface temperatures of the heat sink may reach 70°C (warning "hot surface").

Dimensions

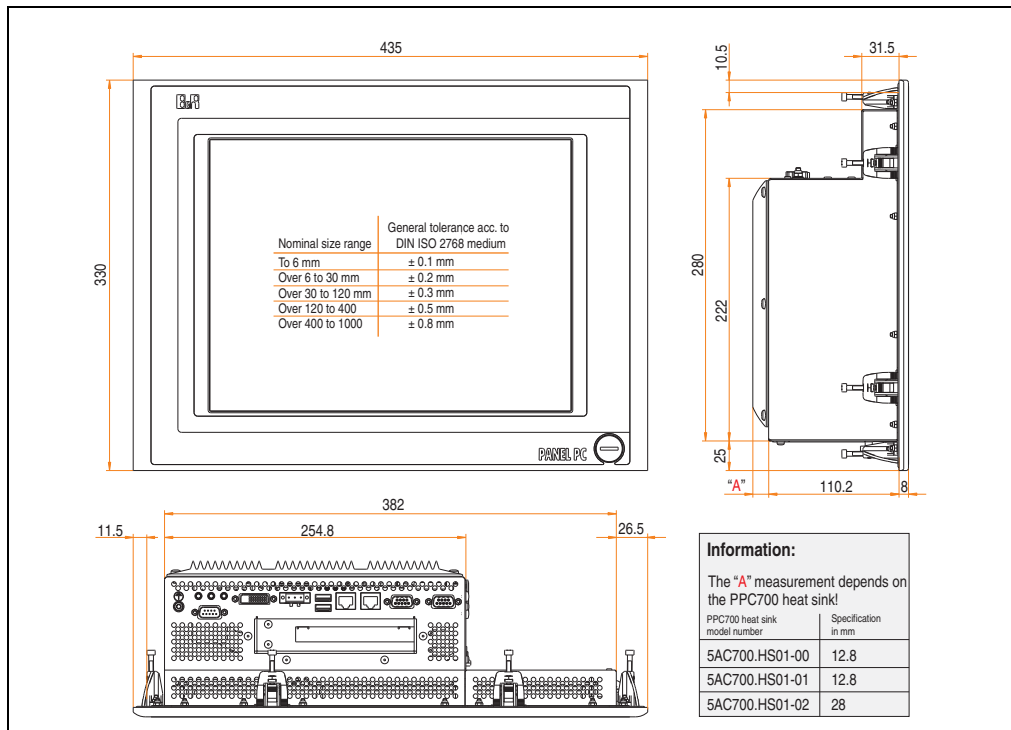

Figure 63: Dimensions - 5PC720.1505-02

Technical data

Features	5PC720.1505-02 ≤ N0	5PC720.1505-02 ≥ O0	5PC720.1505-02 ≥ R0
B&R ID code	0x1DA9		
Serial interfaces	See "Serial interface COM1", on page 72 and "Serial interface COM2", on page 73		
Type	RS232, modem capable		
Amount	2		
UART	16550 compatible, 16 byte FIFO		
Transfer rate	Max. 115 kBaud		
Connection	9-pin DSUB, male		
Ethernet	See "Ethernet connection ETH1", on page 74 and "Ethernet connection ETH2", on page 76		
Controller	10/100 Mbit/s		
Transfer rate	RJ45 twisted pair (10 Base T / 100 Base T)		
Connection			
USB ports	See also "USB ports", on page 77		
Type	USB 2.0		
Amount	3 (2x back side, 1x front side)		
Transfer rate	Up to 480 Mbit ¹⁾ (high speed)		
Connection	Type A		
Monitor / Panel	See also "Monitor / Panel interface", on page 80		
Type	DVI-I, female		
AC97 sound	See also "MIC, Line IN and Line OUT ports", on page 81		
Inputs	Microphone, line in		
Outputs	Line out		
Add-on interface slot	See also "Add-on interface slot", on page 82		
Amount	1		
PCI slots	See also "PCI slots", on page 83		
Amount	1		
Type	Half-size		
Standard	According to PCI half-size standard 2.2		
CompactFlash slot 1 (CF1)	Yes, see also "CompactFlash slot (CF1)", on page 85		
Internal organization	Primary master		
CompactFlash slot 2 / hard disk (HDD/CF2)	Yes, see also "Hard disk / CompactFlash slot (HDD/CF2)", on page 86		
Type	Combined		
Internal organization	Primary slave		
Insert for slide-in drive 1	Yes, see also "Slide-in slot 1 drive slot", on page 92		
Internal organization	Secondary Slave		
SRAM internal slot options	Yes (available starting with revision K0)		
Reset button	Yes, see also "Power button", on page 87		
Power button	Yes, see also "Reset button", on page 87		
PS/2 keyboard / mouse	Yes, see also "PS/2 keyboard / mouse", on page 88		
Type	Combined, automatically detected		
Battery	Yes, see also "Battery", on page 89		
Type	Renata 950 mAh		
Removable	Yes, accessible from the outside		
Service life	4 years ²⁾		
Hardware security key compartment	Yes, see also "Hardware security key", on page 91		
Optimized for	DS1425 from MAXIM/Dallas		

Table 57: Technical data - 5PC720.1505-02

Technical data • Individual components

Features	5PC720.1505-02 ≤ N0	5PC720.1505-02 ≥ O0	5PC720.1505-02 ≥ R0
Fan insert for fan kit	Yes, compatible fan kit - see section 3.8.3 "Fan kit 5PC700.FA02-01", on page 217		
LED Amount	See also "Status LEDs", on page 84 3 (Power, HDD, Link 1)		
Touch screen ³⁾ Touch screen type Technology Controller Degree of transmission	Elo Accu Touch Analog, resistive Elo, serial, 12-bit Up to 78%	AMT analog, resistiv Elo, seriell, 12 Bit bis zu 81% ±3%	
Display Type Diagonal Colors Resolution Contrast Viewing angle (see page 485) Horizontal Vertical Background lighting Type Brightness Half-brightness time ⁴⁾	Color TFT 15 inch (381 mm) 16 million XGA, 1024 x 768 pixels 400:1 Direction R / direction L = 85° Direction U / direction D = 85° CCFL 250 cd/m ² 50000 hours		TFT Farbe 15 inch (381 mm) 16 Mio. XGA, 1024 x 768 Bildpunkte 1000:1 Richtung R / Richtung L = 85° Richtung U / Richtung D = 85° LED 350 cd/m ² 70000 Stunden
Keys/LED Function keys Soft keys Cursor keys Number block Other keys Key lifespan LED brightness	-		
Electrical characteristics			
Power supply Rated voltage Rated current Starting current Power consumption Electrical isolation	See also "Supply voltage", on page 78 24 VDC ±25% 3.8 A Typ. 10 A, max. 40 A for < 300 µs See power management section "Power calculation for 15" Panel PC 700", on page 61 Yes		
Mechanical characteristics			
Front Frame Design Membrane Dark gray border around display Light background Gasket	Naturally anodized aluminum ⁵⁾ Gray ⁵⁾ Polyester Similar to Pantone 432CV ⁵⁾ Similar to Pantone 427CV ⁵⁾ Flat gasket around display front		
Housing	Metal		
Outer dimensions Width Height Depth	Also see diagram "Dimensions - 5PC720.1505-02", on page 132 435 mm 330 mm 131 mm (depending on the heat sink)		
Weight	Approx. 6.5 kg		

Table 57: Technical data - 5PC720.1505-02 (Forts.)

Environmental characteristics	5PC720.1505-02 ≤ N0	5PC720.1505-02 ≥ O0	5PC720.1505-02 ≥ R0
Ambient temperature Operation Bearings Transport	See 2.1.7 "Ambient temperatures with system unit 5PC720.1505-02", on page 50 -20 to +60°C -20 to +60°C		
Relative humidity Operation / Storage / Transport	T ≤ 40°C: 5% to 90%, non-condensing T > 40°C: < 90%, non-condensing		
Vibration Operation (continuous) Operation (occasional) Bearings Transport	2 - 9 Hz: 1.75 mm amplitude / 9 - 200 Hz: 0.5 g 2 - 9 Hz: 3.5 mm amplitude / 9 - 200 Hz: 1 g 2 - 8 Hz: 7.5 mm amplitude / 8 - 200 Hz: 2 g / 200 - 500 Hz: 4 g 2 - 8 Hz: 7.5 mm amplitude / 8 - 200 Hz: 2 g / 200 - 500 Hz: 4 g		
Shock Operation Bearings Transport	15 g, 11 ms 30 g, 15 ms 30 g, 15 ms		
Protection	IP20 back side (only with installed CompactFlash card) IP65 / NEMA 250 type 4X, dust and sprayed water protection (front side)		
Altitude	Max. 3,000 m		

Table 57: Technical data - 5PC720.1505-02 (Forts.)

- 1) Software must support USB 2.0 (e.g. Windows XP with at least Service Pack 1).
- 2) At 50°C, 8.5 µA of the supplied components and a self discharge of 40%.
- 3) Touch screen drivers can be downloaded from the download area on the B&R homepage (www.br-automation.com).
- 4) At 25°C ambient temperature. Reducing the brightness by 50% can result in an approximate 50% increase of the half-brightness time.
- 5) Depending on the process or batch, there may be visible deviations in the color and surface structure.

Cutout installation

The Panel PC 700 with preassembled mounting blocks is installed e.g. in a housing cutout. A cutout that corresponds to the following drawing must be made.

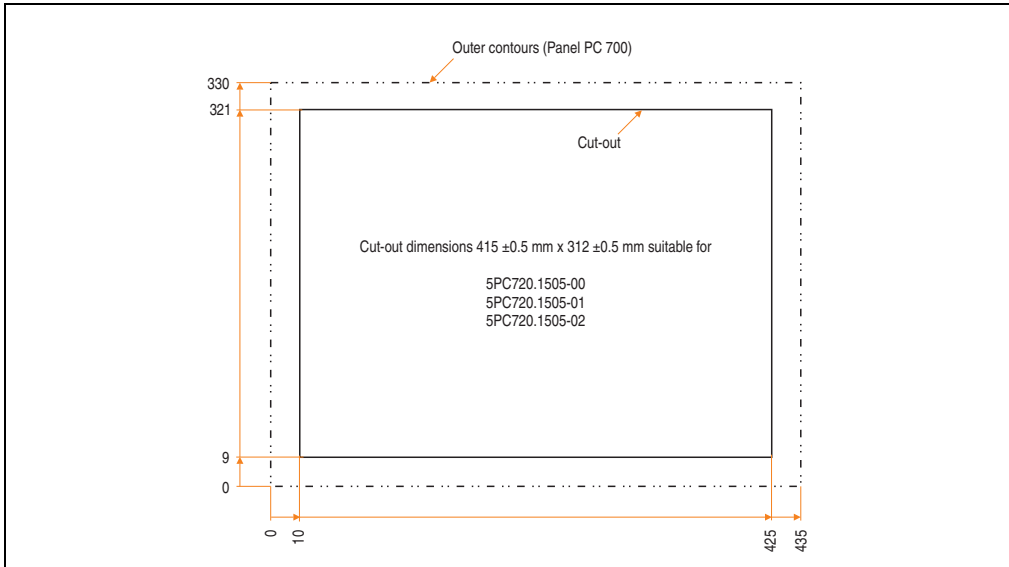

Figure 64: Cutout installation - 5PC720.1505-02

For further information regarding mounting and installation position, see chapter 3 "Commissioning", on page 219.

3.1.8 Panel PC 5PC720.1706-00

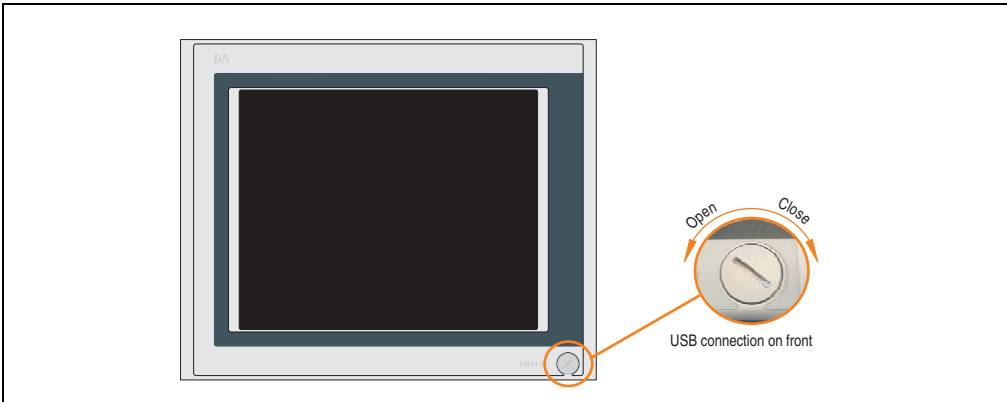

Figure 65: Front view 5PC720.1706-00

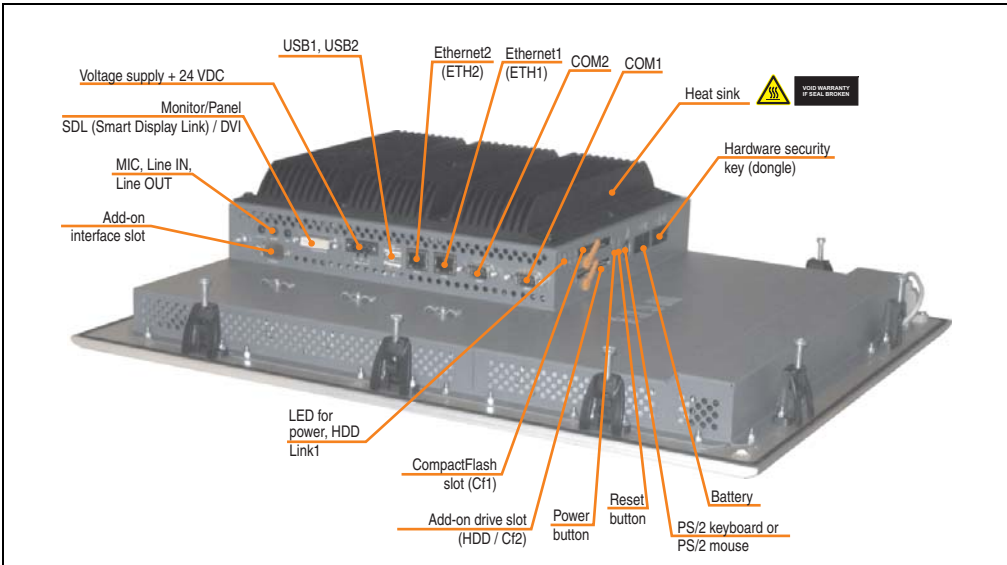

Figure 66: Rear view 5PC720.1706-00

Warning!

Do not remove mounting screws from the heat sink, as it is connected to the processor and chipset by a thermal coupling. If this connection is broken, the PPC700 must be sent for repair. Removal of the mounting screws, which can be determined by a broken seal, voids all warranty.

During operation, surface temperatures of the heat sink may reach 70°C (warning "hot surface").

Dimensions

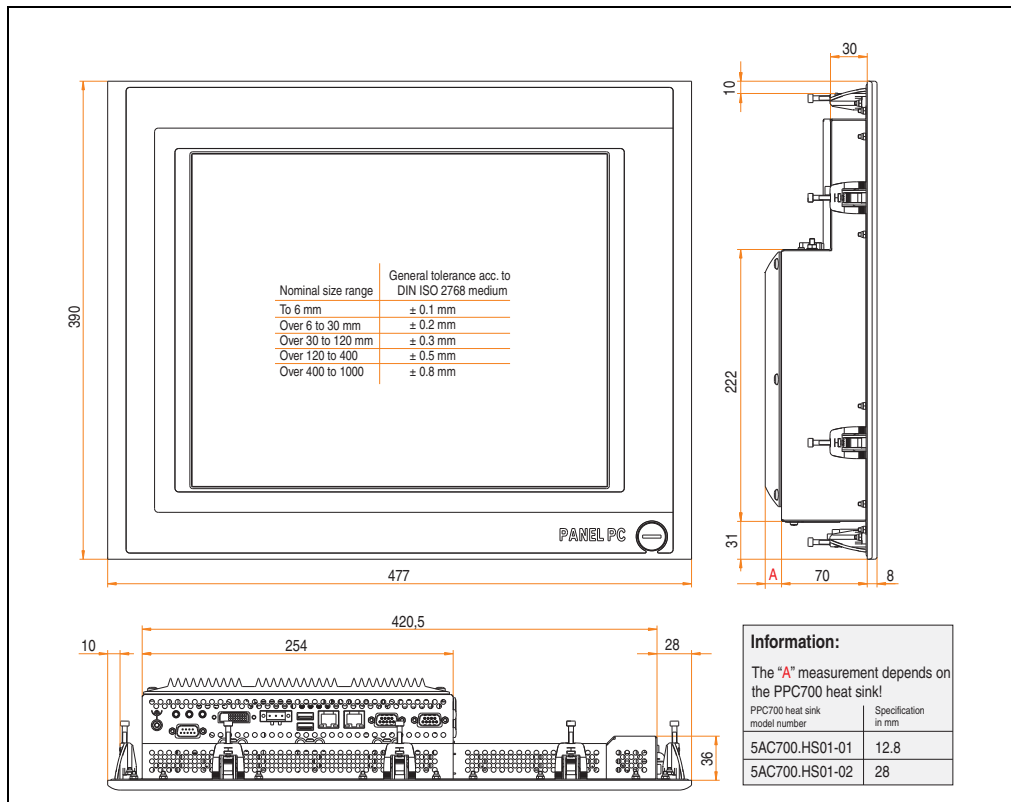

Figure 67: Dimensions - 5PC720.1706-00

Technical data

Features	5PC720.1706-00
B&R ID code	0x1C61
Serial interfaces	See "Serial interface COM1", on page 72 and "Serial interface COM2", on page 73
Type	RS232, modem capable
Amount	2
UART	16550 compatible, 16 byte FIFO
Transfer rate	Max. 115 kBaud
Connection	9-pin DSUB, male
Ethernet	See "Ethernet connection ETH1", on page 74 and "Ethernet connection ETH2", on page 76
Controller	10/100 Mbit/s
Transfer rate	
Connection	RJ45 twisted pair (10 Base T / 100 Base T)
USB ports	See also "USB ports", on page 77
Type	USB 2.0
Amount	3 (2x back side, 1x front side)
Transfer rate	Up to 480 Mbit ¹⁾ (high speed)
Connection	Type A
Monitor / Panel	See also "Monitor / Panel interface", on page 80
Type	DVI-I, female
AC97 sound	See also "MIC, Line IN and Line OUT ports", on page 81
Inputs	Microphone, line in
Outputs	Line out
Add-on interface slot	See also "Add-on interface slot", on page 82
Amount	1
PCI slots	-
Amount	
Type	
Standard	
CompactFlash slot 1 (CF1)	Yes, see also "CompactFlash slot (CF1)", on page 85
Internal organization	Primary master
CompactFlash slot 2 / hard disk (HDD/CF2)	Yes, see also "Hard disk / CompactFlash slot (HDD/CF2)", on page 86
Type	Combined
Internal organization	Primary slave
Insert for slide-in drive 1	-
Internal organization	
SRAM internal slot options	No
Reset button	Yes, see also "Power button", on page 87
Power button	Yes, see also "Reset button", on page 87
PS/2 keyboard / mouse	Yes, see also "PS/2 keyboard / mouse", on page 88
Type	Combined, automatically detected
Battery	Yes, see also "Battery", on page 89
Type	Renata 950 mAh
Removable	Yes, accessible from the outside
Service life	4 years ²⁾
Hardware security key compartment	Yes, see also "Hardware security key", on page 91
Optimized for	DS1425 from MAXIM/Dallas

Table 58: Technical data - 5PC720.1706-00

Technical data • Individual components

Features	5PC720.1706-00
Fan insert for fan kit	Yes, compatible fan kit - see section 3.8.1 "Fan kit 5PC700.FA00-01", on page 214
LED Amount	See also "Status LEDs", on page 84 3 (Power, HDD, Link 1)
Touch screen ³⁾ Touch screen type Technology Controller Degree of transmission	Elo Accu Touch Analog, resistive Elo, serial, 12-bit Up to 78%
Display Type Diagonal Colors Resolution Contrast Viewing angle (see page 485) Horizontal Vertical Background lighting Brightness Half-brightness time ⁴⁾	Color TFT 17 inch (431.8 mm) 16 million SXGA, 1280 x 1024 pixels 400:1 Direction R / direction L = 85° Direction U / direction D = 85° 250 cd/m ² 50000 hours
Keys Function keys Soft keys Cursor keys Number block Other keys Key lifespan LED brightness	-
Electrical characteristics	
Power supply Rated voltage Rated current Starting current Power consumption Electrical isolation	See also "Supply voltage", on page 78 24 VDC ±25% 3.8 A Typ. 10 A, max. 40 A for < 300 µs See power management section "Power calculation for 17" Panel PC 700", on page 62 Yes
Mechanical characteristics	
Front Frame Design Membrane Dark gray border around display Light background Gasket	Naturally anodized aluminum ⁵⁾ Gray ⁵⁾ Polyester Similar to Pantone432CV ⁵⁾ Similar to Pantone 427CV ⁵⁾ Flat gasket around display front
Housing	Metal
Outer dimensions Width Height Depth	Also see diagram "Dimensions - 5PC720.1706-00", on page 138 477 mm 390 mm 90.8 mm (depending on the heat sink)
Weight	Approx. 7.7 kg

Table 58: Technical data - 5PC720.1706-00 (Forts.)

Environmental characteristics	5PC720.1706-00
Ambient temperature Operation Bearings Transport	See 2.1.8 "Ambient temperatures with system unit 5PC720.1706-00", on page 51 -20 to +60°C -20 to +60°C
Relative humidity Operation / Storage / Transport	T ≤ 40°C: 5% to 90%, non-condensing T > 40°C: < 90%, non-condensing
Vibration Operation (continuous) Operation (occasional) Bearings Transport	2 - 9 Hz: 1.75 mm amplitude / 9 - 200 Hz: 0.5 g 2 - 9 Hz: 3.5 mm amplitude / 9 - 200 Hz: 1 g 2 - 8 Hz: 7.5 mm amplitude / 8 - 200 Hz: 2 g / 200 - 500 Hz: 4 g 2 - 8 Hz: 7.5 mm amplitude / 8 - 200 Hz: 2 g / 200 - 500 Hz: 4 g
Shock Operation Bearings Transport	15 g, 11 ms 30 g, 15 ms 30 g, 15 ms
Protection	IP20 back side (only with installed CompactFlash card) IP65 / NEMA 250 type 4X, dust and sprayed water protection (front side)
Altitude	Max. 3,000 m

Table 58: Technical data - 5PC720.1706-00 (Forts.)

- 1) Software must support USB 2.0 (e.g. Windows XP with at least Service Pack 1).
- 2) At 50°C, 8.5 µA of the supplied components and a self discharge of 40%.
- 3) Touch screen drivers can be downloaded from the download area on the B&R homepage (www.br-automation.com).
- 4) At 25°C ambient temperature. Reducing the brightness by 50% can result in an approximate 50% increase of the half-brightness time.
- 5) Depending on the process or batch, there may be visible deviations in the color and surface structure.

Cutout installation

The Panel PC 700 with preassembled mounting blocks is installed e.g. in a housing cutout. A cutout that corresponds to the following drawing must be made.

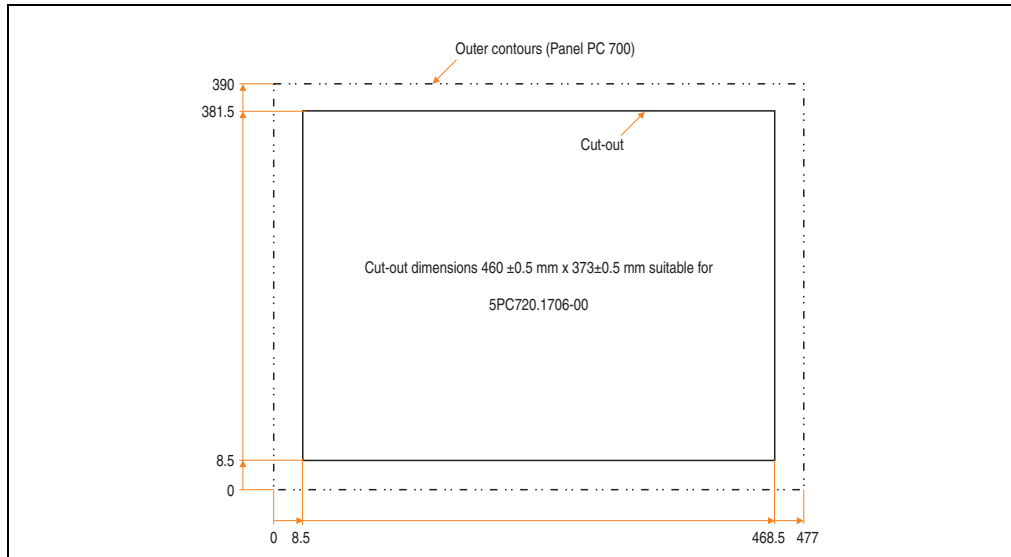

Figure 68: Cutout installation - 5PC720.1706-00

For further information regarding mounting and installation position, see chapter 3 "Commissioning", on page 219.

3.1.9 Panel PC 5PC720.1906-00

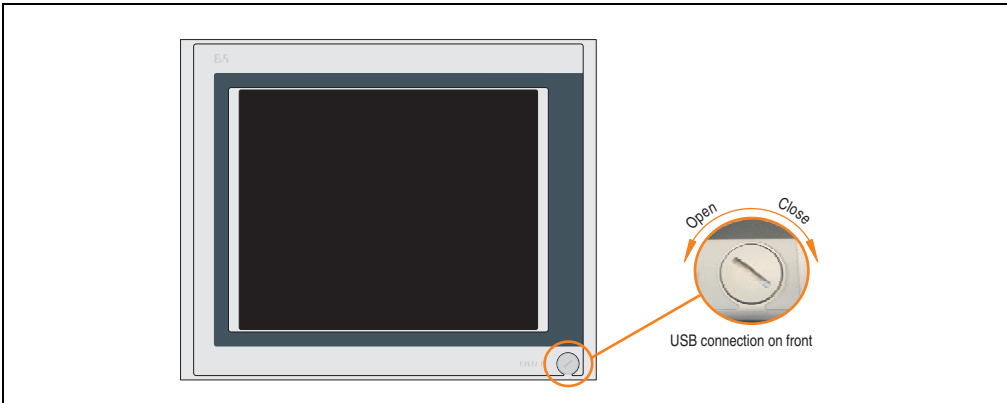

Figure 69: Front view 5PC720.1906-00

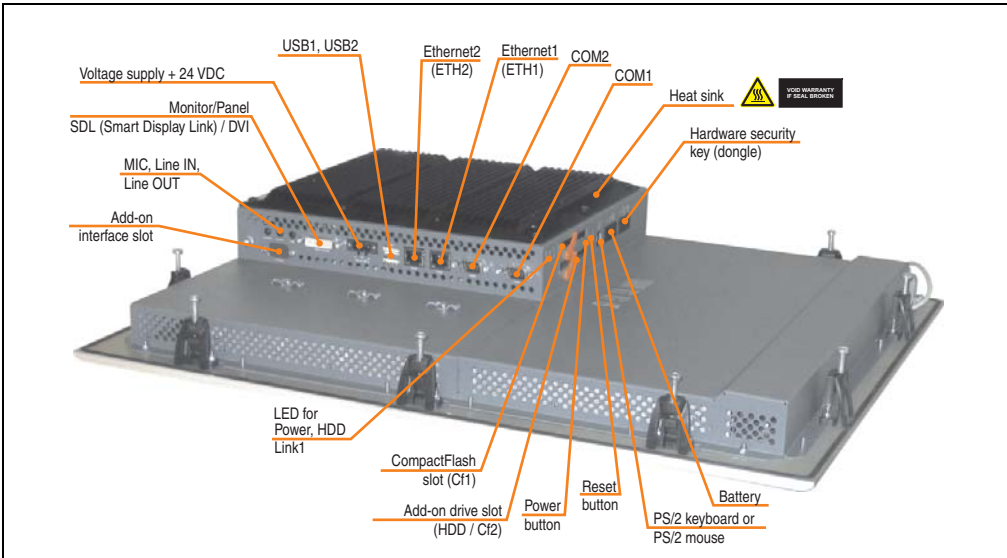

Figure 70: Rear view 5PC720.1906-00

Warning!

Do not remove mounting screws from the heat sink, as it is connected to the processor and chipset by a thermal coupling. If this connection is broken, the PPC700 must be sent for repair. Removal of the mounting screws, which can be determined by a broken seal, voids all warranty.

During operation, surface temperatures of the heat sink may reach 70°C (warning "hot surface").

Dimensions

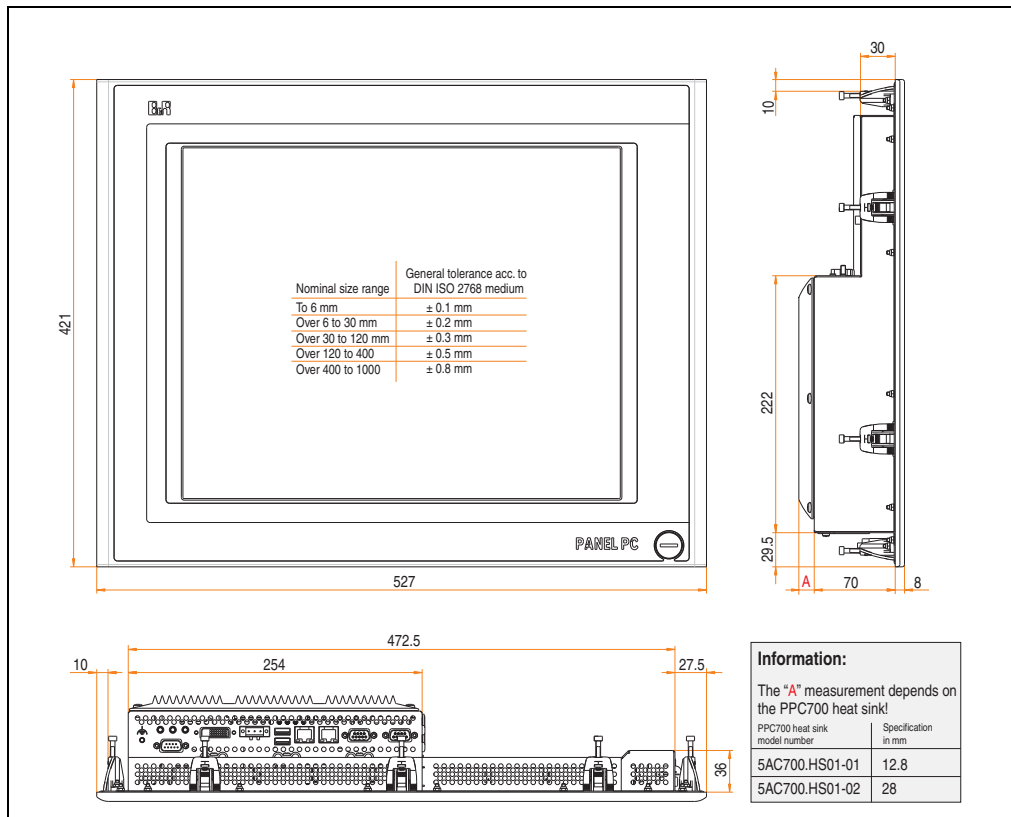

Figure 71: Dimensions - 5PC720.1906-00

Technical data

Features	5PC720.1906-00 ≤ K0	5PC720.1906-00 ≥ L0	5PC720.1906-00 ≥ M0
B&R ID code	0x24E8		
Serial interfaces	See "Serial interface COM1", on page 72 and "Serial interface COM2", on page 73		
Type	RS232, modem capable		
Amount	2		
UART	16550 compatible, 16 byte FIFO		
Transfer rate	Max. 115 kBaud		
Connection	9-pin DSUB, male		
Ethernet	See "Ethernet connection ETH1", on page 74 and "Ethernet connection ETH2", on page 76		
Controller	10/100 Mbit/s		
Transfer rate	RJ45 twisted pair (10 Base T / 100 Base T)		
Connection			
USB ports	See also "USB ports", on page 77		
Type	USB 2.0		
Amount	3 (2x back side, 1x front side)		
Transfer rate	Up to 480 Mbit ¹⁾ (high speed)		
Connection	Type A		
Monitor / Panel	See also "Monitor / Panel interface", on page 80		
Type	DVI-I, female		
AC97 sound	See also "MIC, Line IN and Line OUT ports", on page 81		
Inputs	Microphone, line in		
Outputs	Line out		
Add-on interface slot	See also "Add-on interface slot", on page 82		
Amount	1		
PCI slots	-		
Amount			
Type			
Standard			
CompactFlash slot 1 (CF1)	Yes, see also "CompactFlash slot (CF1)", on page 85		
Internal organization	Primary master		
CompactFlash slot 2 / hard disk (HDD/CF2)	Yes, see also "Hard disk / CompactFlash slot (HDD/CF2)", on page 86		
Type	Combined		
Internal organization	Primary slave		
Insert for slide-in drive 1	-		
Internal organization			
SRAM internal slot options	No		
Reset button	Yes, see also "Power button", on page 87		
Power button	Yes, see also "Reset button", on page 87		
PS/2 keyboard / mouse	Yes, see also "PS/2 keyboard / mouse", on page 88		
Type	Combined, automatically detected		
Battery	Yes, see also "Battery", on page 89		
Type	Renata 950 mAh		
Removable	Yes, accessible from the outside		
Service life	4 years ²⁾		
Hardware security key compartment	Yes, see also "Hardware security key", on page 91		
Optimized for	DS1425 from MAXIM/Dallas		

Table 59: Technical data - 5PC720.1906-00

Technical data • Individual components

Features	5PC720.1906-00 ≤ K0	5PC720.1906-00 ≥ L0	5PC720.1906-00 ≥ M0
Fan insert for fan kit	Yes, compatible fan kit - see section 3.8.1 "Fan kit 5PC700.FA00-01", on page 214		
LED Amount	See also "Status LEDs", on page 84 3 (Power, HDD, Link 1)		
Touch screen ³⁾ Touch screen type Technology Controller Degree of transmission	Elo Accu Touch Analog, resistive Elo, serial, 12-bit Up to 78%		AMT analog, resistiv Elo, seriell, 12 Bit bis zu 81% ±3%
Display Type Diagonal Colors Resolution Contrast Viewing angle (see page 485) Horizontal Vertical Background lighting Type Brightness Half-brightness time ⁴⁾	Color TFT 19 inch (482.6 mm) 16 million SXGA, 1280 x 1024 pixels 400:1 Direction R / direction L = 85° Direction U / direction D = 85° CCFL 250 cd/m² 50000 hours	TFT Farbe 19 inch (482,6 mm) 16 Mio. SXGA, 1280 x 1024 Bildpunkte 1000:1 Richtung R / Richtung L = 89° Richtung U / Richtung D = 89° LED 300 cd/m² 50000 Stunden	
Keys Function keys Soft keys Cursor keys Number block Other keys Key lifespan LED brightness			
Electrical characteristics			
Power supply Rated voltage Rated current Starting current Power consumption Electrical isolation	See also "Supply voltage", on page 78 24 VDC ±25% 3.8 A Typ. 10 A, max. 40 A for < 300 µs See power management section "Power calculation for 19" Panel PC 700", on page 63 Yes		
Mechanical characteristics			
Front Frame Design Membrane Dark gray border around display Light background Gasket	Naturally anodized aluminum ⁵⁾ Gray ⁵⁾ Polyester Similar to Pantone432CV ⁵⁾ Similar to Pantone 427CV ⁵⁾ Flat gasket around display front		
Housing	Metal		
Outer dimensions Width Height Depth	Also see diagram "Dimensions - 5PC720.1906-00", on page 144 527 mm 421 mm 90.8 mm (depending on the heat sink)		
Weight	Approx. 9 kg		

Table 59: Technical data - 5PC720.1906-00 (Forts.)

Environmental characteristics	5PC720.1906-00 ≤ K0	5PC720.1906-00 ≥ L0	5PC720.1906-00 ≥ M0
Ambient temperature Operation Bearings Transport	See 2.1.9 "Ambient temperatures with system unit 5PC720.1906-00", on page 52		
Relative humidity Operation / Storage / Transport	T ≤ 40°C: 5% to 90%, non-condensing T > 40°C: < 90%, non-condensing		
Vibration Operation (continuous) Operation (occasional) Bearings Transport	2 - 9 Hz: 1.75 mm amplitude / 9 - 200 Hz: 0.5 g 2 - 9 Hz: 3.5 mm amplitude / 9 - 200 Hz: 1 g 2 - 8 Hz: 7.5 mm amplitude / 8 - 200 Hz: 2 g / 200 - 500 Hz: 4 g 2 - 8 Hz: 7.5 mm amplitude / 8 - 200 Hz: 2 g / 200 - 500 Hz: 4 g		
Shock Operation Bearings Transport	15 g, 11 ms 30 g, 15 ms 30 g, 15 ms		
Protection	IP20 back side (only with installed CompactFlash card) IP65 / NEMA 250 type 4X, dust and sprayed water protection (front side)		
Altitude	Max. 3,000 m		

Table 59: Technical data - 5PC720.1906-00 (Forts.)

- 1) Software must support USB 2.0 (e.g. Windows XP with at least Service Pack 1).
- 2) At 50°C, 8.5 µA of the supplied components and a self discharge of 40%.
- 3) Touch screen drivers can be downloaded from the download area on the B&R homepage (www.br-automation.com).
- 4) At 25°C ambient temperature. Reducing the brightness by 50% can result in an approximate 50% increase of the half-brightness time.
- 5) Depending on the process or batch, there may be visible deviations in the color and surface structure.

Cutout installation

The Panel PC 700 with preassembled mounting blocks is installed e.g. in a housing cutout. A cutout that corresponds to the following drawing must be made.

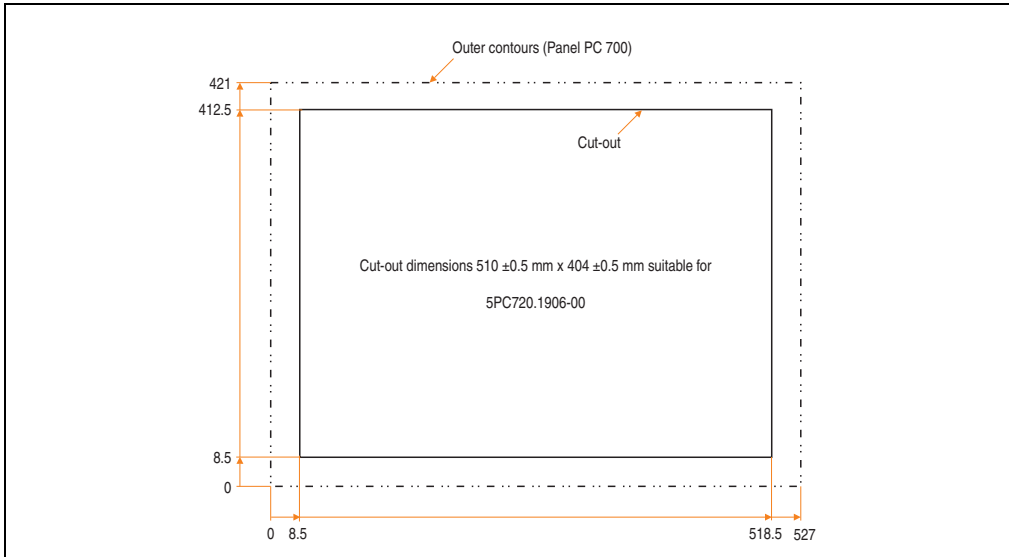

Figure 72: Cutout installation - 5PC720.1906-00

For further information regarding mounting and installation position, see chapter 3 "Commissioning", on page 219.

3.1.10 Panel PC 5PC781.1043-00

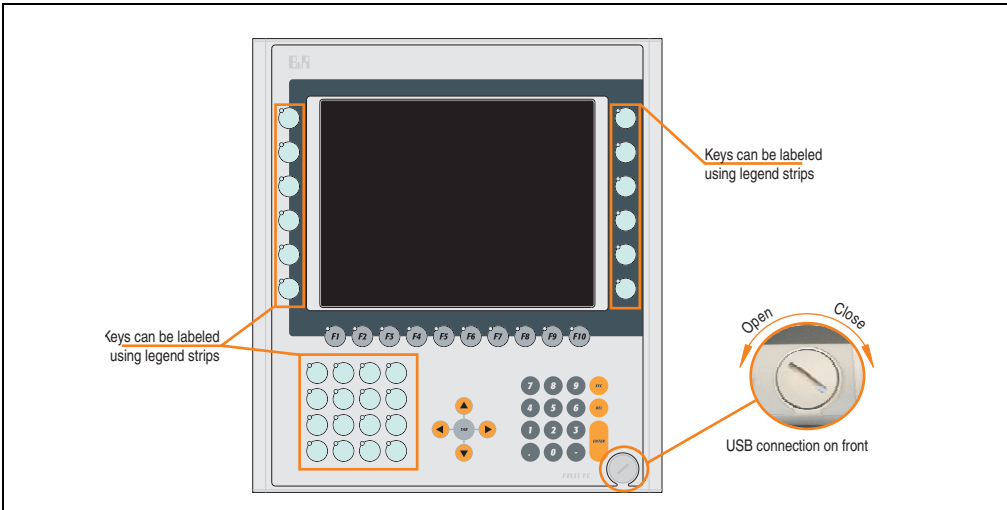

Figure 73: Front view 5PC781.1043-00

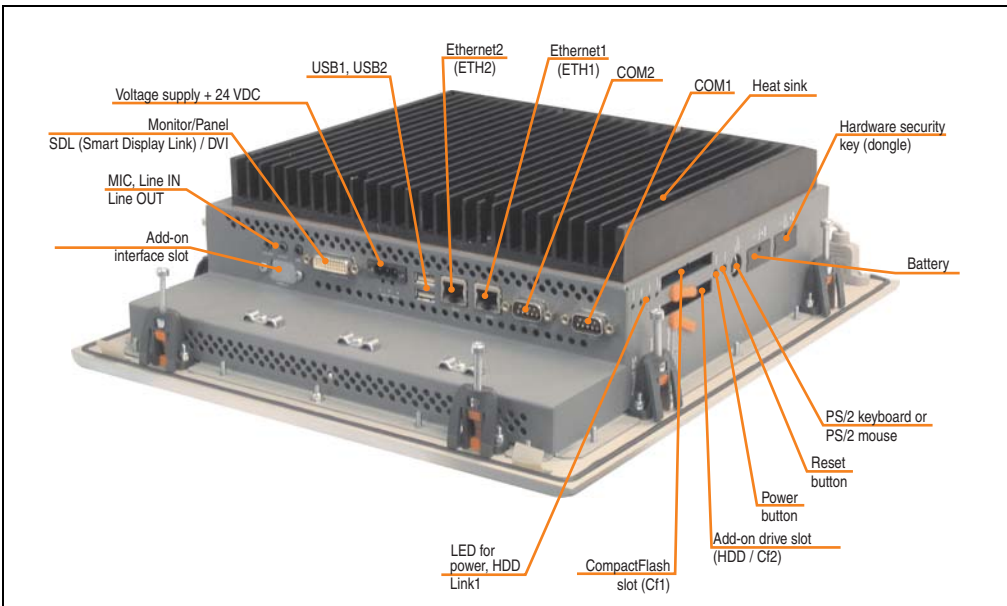

Figure 74: Rear view 5PC781.1043-00

Warning!

Do not remove mounting screws from the heat sink, as it is connected to the processor and chipset by a thermal coupling. If this connection is broken, the PPC700 must be sent for repair. Removal of the mounting screws, which can be determined by a broken seal, voids all warranty.

During operation, surface temperatures of the heat sink may reach 70°C (warning "hot surface").

Dimensions

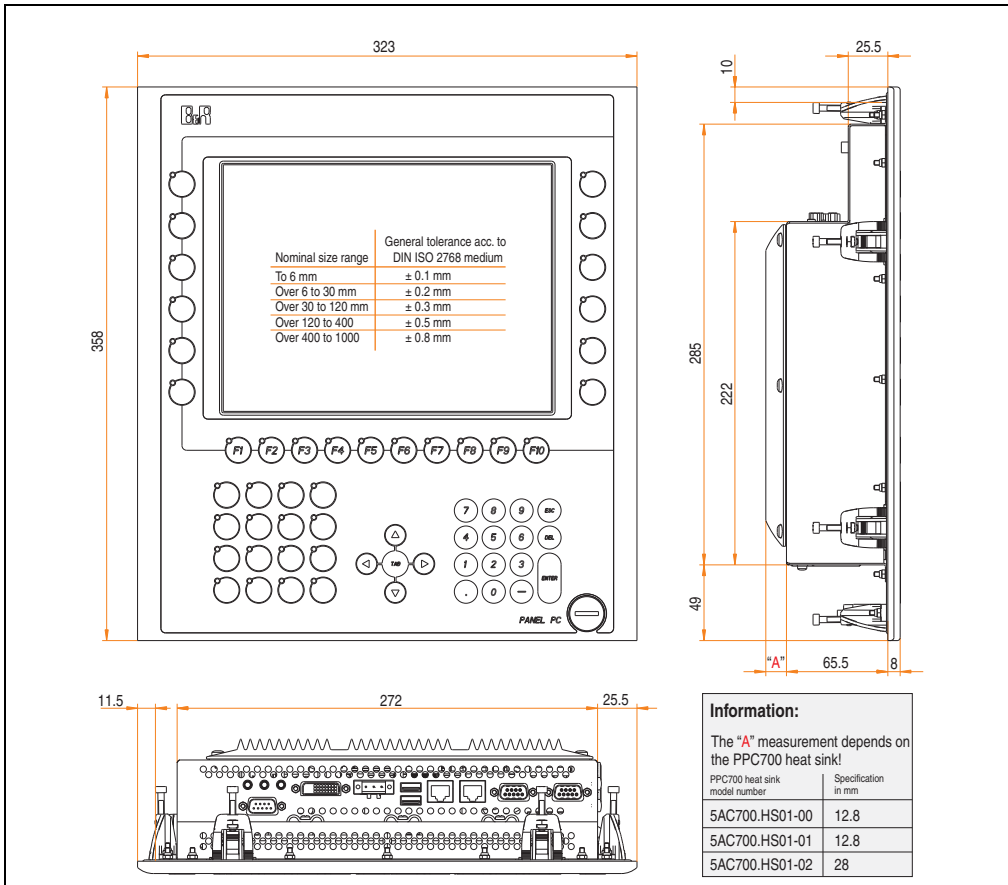

Figure 75: Dimensions - 5PC781.1043-00

Technical data

Features	5PC781.1043-00 ≤ K0	5PC781.1043-00 ≥ L0
B&R ID code	0x1C60	
Serial interfaces	See "Serial interface COM1", on page 72 and "Serial interface COM2", on page 73	
Type	RS232, modem capable	
Amount	2	
UART	16550 compatible, 16 byte FIFO	
Transfer rate	Max. 115 kBaud	
Connection	9-pin DSUB, male	
Ethernet	See "Ethernet connection ETH1", on page 74 and "Ethernet connection ETH2", on page 76	
Controller	10/100 Mbit/s	
Transfer rate	RJ45 twisted pair (10 Base T / 100 Base T)	
Connection		
USB ports	See also "USB ports", on page 77	
Type	USB 2.0	
Amount	3 (2x back side, 1x front side)	
Transfer rate	Up to 480 Mbit ¹⁾ (high speed)	
Connection	Type A	
Monitor / Panel	See also "Monitor / Panel interface", on page 80	
Type	DVI-I, female	
AC97 sound	See also "MIC, Line IN and Line OUT ports", on page 81	
Inputs	Microphone, line in	
Outputs	Line out	
Add-on interface slot	See also "Add-on interface slot", on page 82	
Amount	1	
PCI slots	-	
Amount		
Type		
Standard		
CompactFlash slot 1 (CF1)	Yes, see also "CompactFlash slot (CF1)", on page 85	
Internal organization	Primary master	
CompactFlash slot 2 / hard disk (HDD/CF2)	Yes, see also "Hard disk / CompactFlash slot (HDD/CF2)", on page 86	
Type	Combined	
Internal organization	Primary slave	
Insert for slide-in drive 1	-	
Internal organization		
SRAM internal slot options	No	
Reset button	Yes, see also "Power button", on page 87	
Power button	Yes, see also "Reset button", on page 87	
PS/2 keyboard / mouse	Yes, see also "PS/2 keyboard / mouse", on page 88	
Type	Combined, automatically detected	
Battery	Yes, see also "Battery", on page 89	
Type	Renata 950 mAh	
Removable	Yes, accessible from the outside	
Service life	4 years ²⁾	
Hardware security key compartment	Yes, see also "Hardware security key", on page 91	
Optimized for	DS1425 from MAXIM/Dallas	

Table 60: Technical data - 5PC781.1043-00

Technical data • Individual components

Features	5PC781.1043-00 ≤ K0	5PC781.1043-00 ≥ L0
Fan insert for fan kit	Yes, compatible fan kit - see section 3.8.1 "Fan kit 5PC700.FA00-01", on page 214	
LED Amount	See also "Status LEDs", on page 84 3 (Power, HDD, Link 1)	
Touch screen ³⁾ Touch screen type Technology Controller Degree of transmission	Elo Accu Touch Analog, resistive Elo, serial, 12-bit Up to 78%	AMT analog, resistiv Elo, seriell, 12 Bit bis zu 81% ±3%
Display Type Diagonal Colors Resolution Contrast Viewing angle (see page 485) Horizontal Vertical Background lighting Type Brightness Half-brightness time ⁴⁾	Color TFT 10.4 inch (264 mm) 262,144 colors VGA, 640 x 480 pixels 300:1 Direction R / direction L = 70° Direction U / direction D = 70° CCFL 350 cd/m ² 50000 hours	
Keys/LED ⁵⁾ Function keys Soft keys Cursor keys Number block Other keys Key lifespan LED brightness	28 with LED (yellow) 10 with LED (yellow) - 15 without LED 5 without LED > 1,000,000 actuations with 1 ±0.3 to 3 ±0.3 N operating force Typically 12 mcd (yellow)	
Caution! Pressing more than one key at a time may result in so-called phantom keys, and may trigger unintended actions.		
Electrical characteristics		
Power supply Rated voltage Rated current Starting current Power consumption Electrical isolation	See also "Supply voltage", on page 78 24 VDC ±25% 3.8 A Typ. 10 A, max. 40 A for < 300 µs See power management section "Power calculation for 10.4" Panel PC 700", on page 59 Yes	
Mechanical characteristics		
Front Frame Design Membrane Dark gray border around display Light background Orange keys Dark gray keys Color legend strips Gasket	Naturally anodized aluminum ⁶⁾ Gray ⁶⁾ Polyester Similar to Pantone 432CV ⁶⁾ Similar to Pantone 427CV ⁶⁾ Similar to Pantone 151CV ⁶⁾ Similar to Pantone 431CV ⁶⁾ Similar to Pantone 429CV ⁶⁾ Flat gasket around display front	
Housing	Metal	

Table 60: Technical data - 5PC781.1043-00 (Forts.)

Mechanical characteristics	5PC781.1043-00 ≤ K0	5PC781.1043-00 ≥ L0
Outer dimensions Width Height Depth	Also see diagram "Dimensions - 5PC781.1043-00", on page 150 323 mm 358 mm 86.3 mm (depending on the heat sink)	
Weight	Approx. 4.5 kg	
Environmental characteristics		
Ambient temperature Operation Bearings Transport	See section 2.1.10 "Ambient temperatures with system unit 5PC781.1043-00", on page 53--30 to +70°C -30 to +70°C	
Relative humidity Operation / Storage / Transport	T ≤ 40°C: 5% to 90%, non-condensing T > 40°C: < 90%, non-condensing	
Vibration Operation (continuous) Operation (occasional) Bearings Transport	2 - 9 Hz: 1.75 mm amplitude / 9 - 200 Hz: 0.5 g 2 - 9 Hz: 3.5 mm amplitude / 9 - 200 Hz: 1 g 2 - 8 Hz: 7.5 mm amplitude / 8 - 200 Hz: 2 g / 200 - 500 Hz: 4 g 2 - 8 Hz: 7.5 mm amplitude / 8 - 200 Hz: 2 g / 200 - 500 Hz: 4 g	
Shock Operation Bearings Transport	15 g, 11 ms 30 g, 15 ms 30 g, 15 ms	
Protection	IP20 back side (only with installed CompactFlash card) IP65 / NEMA 250 type 4X, dust and sprayed water protection (front side)	
Altitude	Max. 3,000 m	

Table 60: Technical data - 5PC781.1043-00 (Forts.)

- 1) Software must support USB 2.0 (e.g. Windows XP with at least Service Pack 1).
- 2) At 50°C, 8.5 µA of the supplied components and a self discharge of 40%.
- 3) Touch screen drivers can be downloaded from the download area on the B&R homepage (www.br-automation.com).
- 4) At 25°C ambient temperature. Reducing the brightness by 50% can result in an approximate 50% increase of the half-brightness time.
- 5) The key and LED functions can be freely configured with the B&R Key Editor, which can be found in the download area of the B&R homepage (www.br-automation.com) or on the B&R HMI Driver & Utilities DVD (model number 5SWHMI.0000-00).
- 6) Depending on the process or batch, there may be visible deviations in the color and surface structure.

Cutout installation

The Panel PC 700 with preassembled mounting blocks is installed e.g. in a housing cutout. A cutout that corresponds to the following drawing must be made.

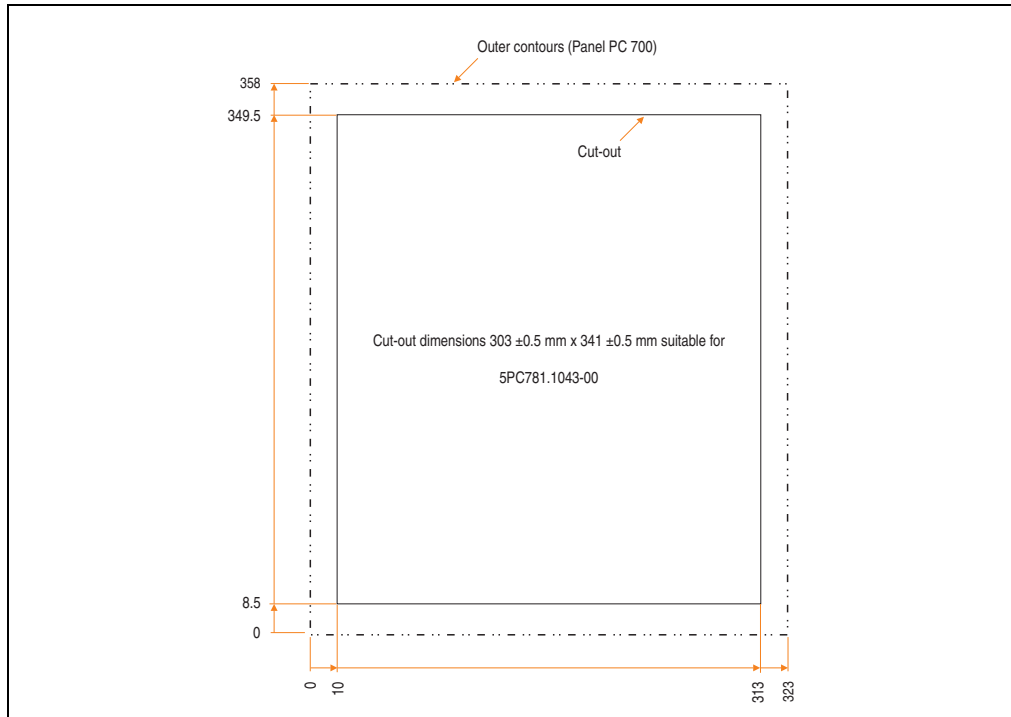

Figure 76: Cutout installation - 5PC781.1043-00

For further information regarding mounting and installation position, see chapter 3 "Commissioning", on page 219.

3.1.11 Panel PC 5PC781.1505-00

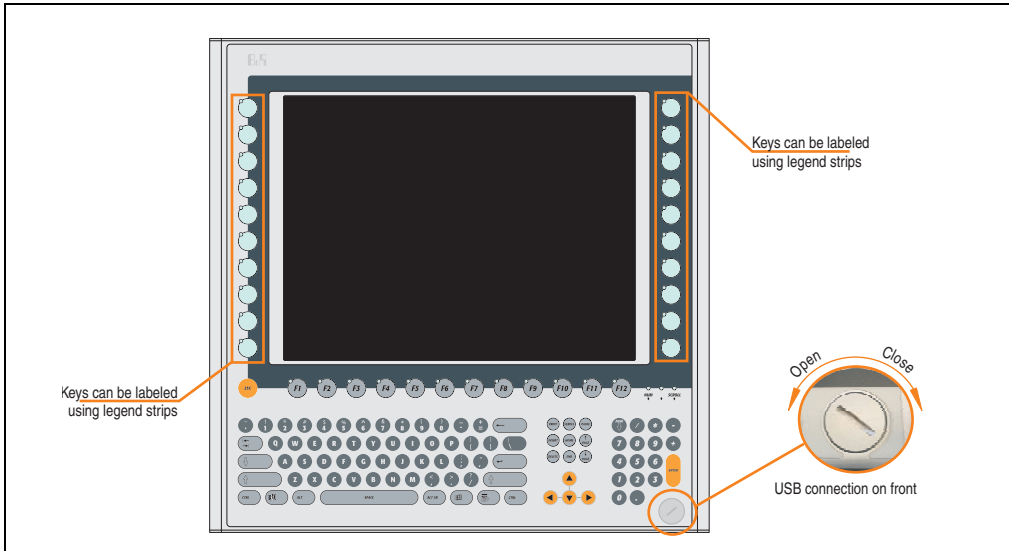

Figure 77: Front view 5PC781.1505-00

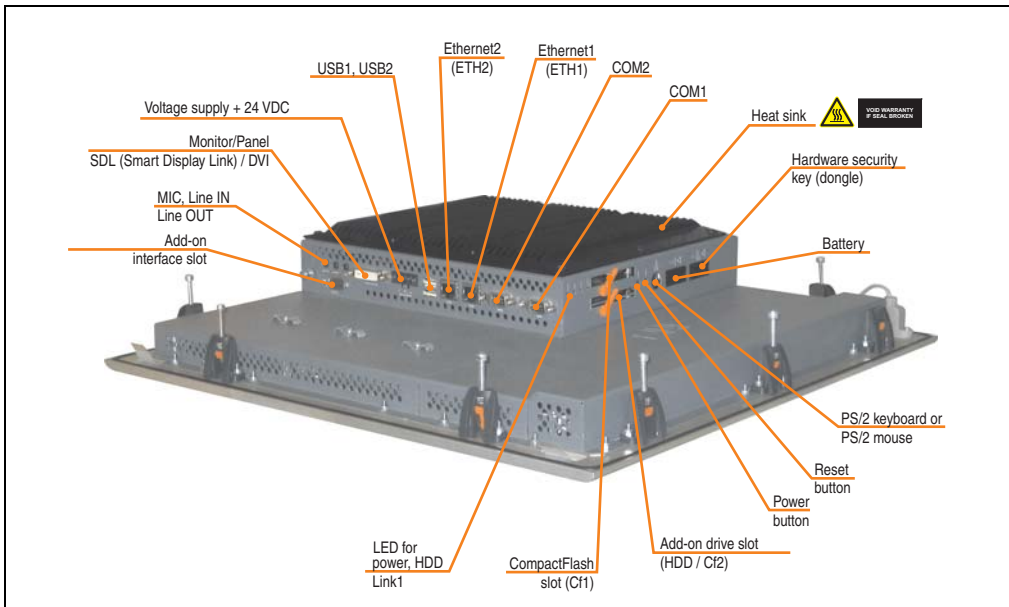

Figure 78: Rear view 5PC781.1505-00

Warning!

Do not remove mounting screws from the heat sink, as it is connected to the processor and chipset by a thermal coupling. If this connection is broken, the PPC700 must be sent for repair. Removal of the mounting screws, which can be determined by a broken seal, voids all warranty.

During operation, surface temperatures of the heat sink may reach 70°C (warning "hot surface").

Dimensions

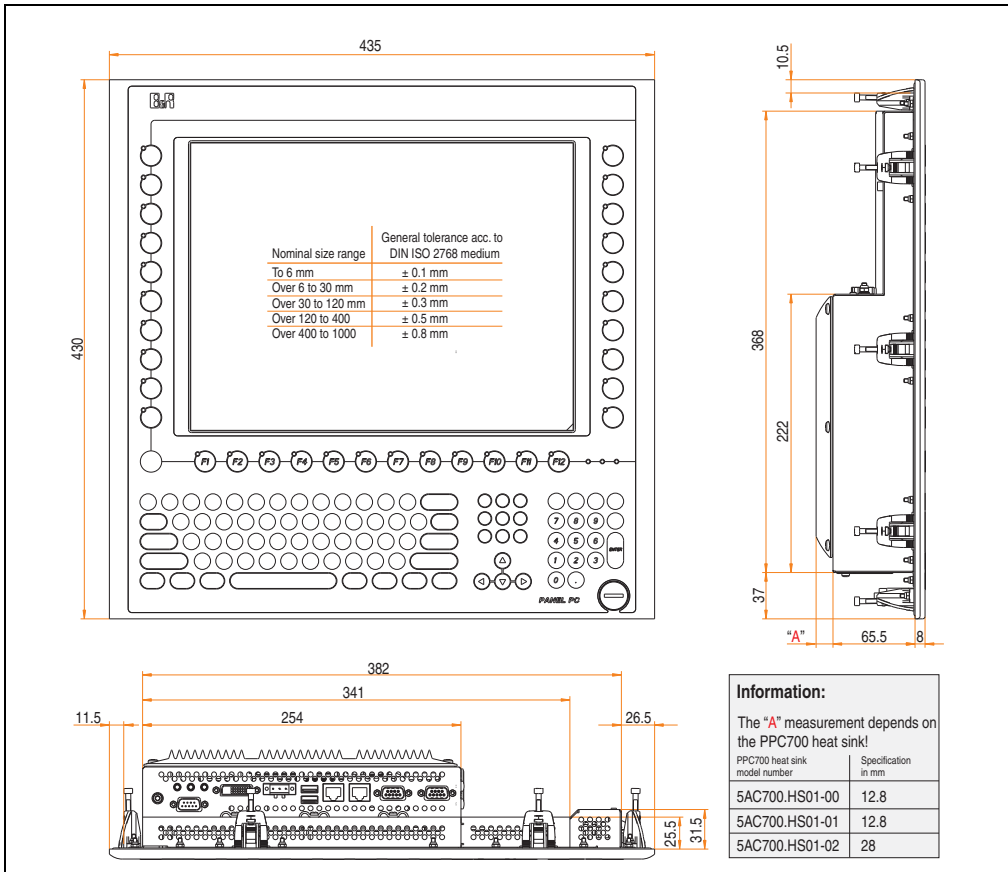

Figure 79: Dimensions - 5PC781.1505-00

Technical data

Features	5PC781.1505-00 ≤ N0	5PC781.1505-00 ≥ O0	5PC781.1505-00 ≥ Q0
B&R ID code	0x1C5F		
Serial interfaces	See "Serial interface COM1", on page 72 and "Serial interface COM2", on page 73		
Type	RS232, modem capable		
Amount	2		
UART	16550 compatible, 16 byte FIFO		
Transfer rate	Max. 115 kBaud		
Connection	9-pin DSUB, male		
Ethernet	See "Ethernet connection ETH1", on page 74 and "Ethernet connection ETH2", on page 76		
Controller	10/100 Mbit/s		
Transfer rate	RJ45 twisted pair (10 Base T / 100 Base T)		
Connection			
USB ports	See also "USB ports", on page 77		
Type	USB 2.0		
Amount	3 (2x back side, 1x front side)		
Transfer rate	Up to 480 Mbit ¹⁾ (high speed)		
Connection	Type A		
Monitor / Panel	See also "Monitor / Panel interface", on page 80		
Type	DVI-I, female		
AC97 sound	See also "MIC, Line IN and Line OUT ports", on page 81		
Inputs	Microphone, line in		
Outputs	Line out		
Add-on interface slot	See also "Add-on interface slot", on page 82		
Amount	1		
PCI slots	-		
Amount			
Type			
Standard			
CompactFlash slot 1 (CF1)	Yes, see also "CompactFlash slot (CF1)", on page 85		
Internal organization	Primary master		
CompactFlash slot 2 / hard disk (HDD/CF2)	Yes, see also "Hard disk / CompactFlash slot (HDD/CF2)", on page 86		
Type	Combined		
Internal organization	Primary slave		
Insert for slide-in drive 1	-		
Internal organization			
SRAM internal slot options	No		
Reset button	Yes, see also "Power button", on page 87		
Power button	Yes, see also "Reset button", on page 87		
PS/2 keyboard / mouse	Yes, see also "PS/2 keyboard / mouse", on page 88		
Type	Combined, automatically detected		
Battery	Yes, see also "Battery", on page 89		
Type	Renata 950 mAh		
Removable	Yes, accessible from the outside		
Service life	4 years ²⁾		
Hardware security key compartment	Yes, see also "Hardware security key", on page 91		
Optimized for	DS1425 from MAXIM/Dallas		

Table 61: Technical data - 5PC781.1505-00

Technical data • Individual components

Features	5PC781.1505-00 ≤ N0	5PC781.1505-00 ≥ O0	5PC781.1505-00 ≥ Q0
Fan insert for fan kit	Yes, compatible fan kit - see section 3.8.1 "Fan kit 5PC700.FA00-01", on page 214		
LED Amount	See also "Status LEDs", on page 84 3 (Power, HDD, Link 1)		
Touch screen ³⁾ Touch screen type Technology Controller Degree of transmission	Elo Accu Touch Analog, resistive Elo, serial, 12-bit Up to 78%	AMT analog, resistiv Elo, seriell, 12 Bit bis zu 81% ±3%	
Display Type Diagonal Colors Resolution Contrast Viewing angle (see page 485) Horizontal Vertical Background lighting Type Brightness Half-brightness time ⁴⁾	Color TFT 15 inch (381 mm) 16 million XGA, 1024 x 768 pixels 400:1 Direction R / direction L = 85° Direction U / direction D = 85° CCFL 250 cd/m ² 50000 hours		TFT Farbe 15 inch (381 mm) 16 Mio. XGA, 1024 x 768 Bildpunkte 1000:1 Richtung R / Richtung L = 85° Richtung U / Richtung D = 85° LED 350 cd/m ² 70000 Stunden
Keys/LED ⁵⁾ Function keys Soft keys Cursor keys Number block Other keys Key lifespan LED brightness	20 with LED (yellow) 12 with LED (yellow) - 15 without LED 77 without LED > 1,000,000 actuations with 1 ±0.3 to 3 ±0.3 N operating force Typically 12 mcd (yellow)		
Caution! Pressing more than one key at a time may result in so-called phantom keys, and may trigger unintended actions.			
Electrical characteristics			
Power supply Rated voltage Rated current Starting current Power consumption Electrical isolation	See also "Supply voltage", on page 78 24 VDC ±25% 3.8 A Typ. 10 A, max. 40 A for < 300 µs See power management section "Power calculation for 15" Panel PC 700", on page 61 Yes		
Mechanical characteristics			
Front Frame Design Membrane Dark gray border around display Light background Orange keys Dark gray keys Color legend strips Gasket	Naturally anodized aluminum ⁶⁾ Gray ⁶⁾ Polyester Similar to Pantone 432CV ⁶⁾ Similar to Pantone 427CV ⁶⁾ Similar to Pantone 151CV ⁶⁾ Similar to Pantone 431CV ⁶⁾ Similar to Pantone 429CV ⁶⁾ Flat gasket around display front		
Housing	Metal		

Table 61: Technical data - 5PC781.1505-00 (Forts.)

Mechanical characteristics	5PC781.1505-00 ≤ N0	5PC781.1505-00 ≥ O0	5PC781.1505-00 ≥ Q0
Outer dimensions Width Height Depth	Also see diagram "Dimensions - 5PC781.1505-00", on page 156 435 mm 430 mm 86.3 mm (depending on the heat sink)		
Weight	Approx. 7.5 kg		
Environmental characteristics			
Ambient temperature Operation Bearings Transport	See 2.1.11 "Ambient temperatures with system unit 5PC781.1505-00", on page 54 -30 to +70°C -30 to +70°C		
Relative humidity Operation / Storage / Transport	T ≤ 40°C: 5% to 90%, non-condensing T > 40°C: < 90%, non-condensing		
Vibration Operation (continuous) Operation (occasional) Bearings Transport	2 - 9 Hz: 1.75 mm amplitude / 9 - 200 Hz: 0.5 g 2 - 9 Hz: 3.5 mm amplitude / 9 - 200 Hz: 1 g 2 - 8 Hz: 7.5 mm amplitude / 8 - 200 Hz: 2 g / 200 - 500 Hz: 4 g 2 - 8 Hz: 7.5 mm amplitude / 8 - 200 Hz: 2 g / 200 - 500 Hz: 4 g		
Shock Operation Bearings Transport	15 g, 11 ms 30 g, 15 ms 30 g, 15 ms		
Protection	IP20 back side (only with installed CompactFlash card) IP65 / NEMA 250 type 4X, dust and sprayed water protection (front side)		
Altitude	Max. 3,000 m		

Table 61: Technical data - 5PC781.1505-00 (Forts.)

- 1) Software must support USB 2.0 (e.g. Windows XP with at least Service Pack 1).
- 2) At 50°C, 8.5 µA of the supplied components and a self discharge of 40%.
- 3) Touch screen drivers can be downloaded from the download area on the B&R homepage (www.br-automation.com).
- 4) At 25°C ambient temperature. Reducing the brightness by 50% can result in an approximate 50% increase of the half-brightness time.
- 5) The key and LED functions can be freely configured with the B&R Key Editor, which can be found in the download area of the B&R homepage (www.br-automation.com) or on the B&R HMI Driver & Utilities DVD (model number 5SWHMI.0000-00).
- 6) Depending on the process or batch, there may be visible deviations in the color and surface structure.

Cutout installation

The Panel PC 700 with preassembled mounting blocks is installed e.g. in a housing cutout. A cutout that corresponds to the following drawing must be made.

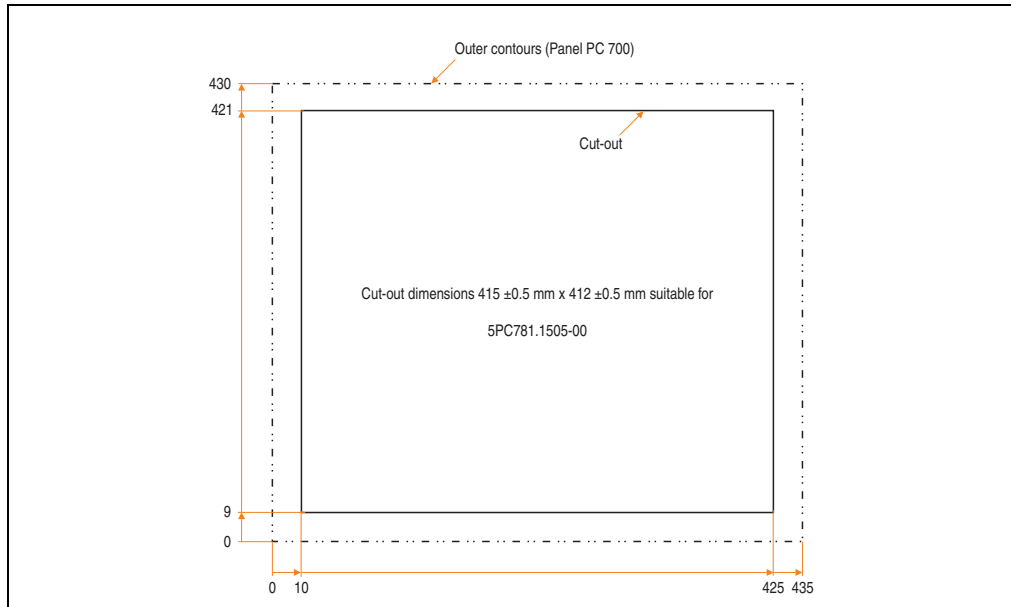

Figure 80: Cutout installation - 5PC781.1505-00

For further information regarding mounting and installation position, see chapter 3 "Commissioning", on page 219.

3.1.12 Panel PC 5PC782.1043-00

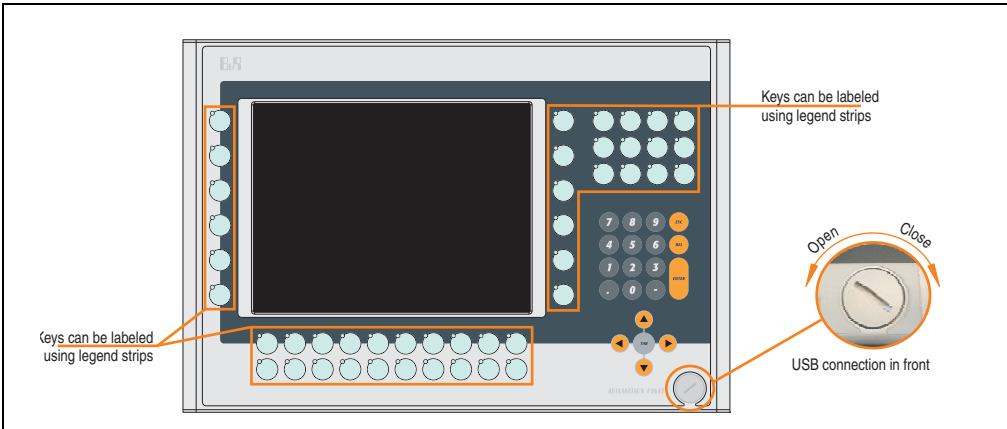

Figure 81: Front view 5PC782.1043-00

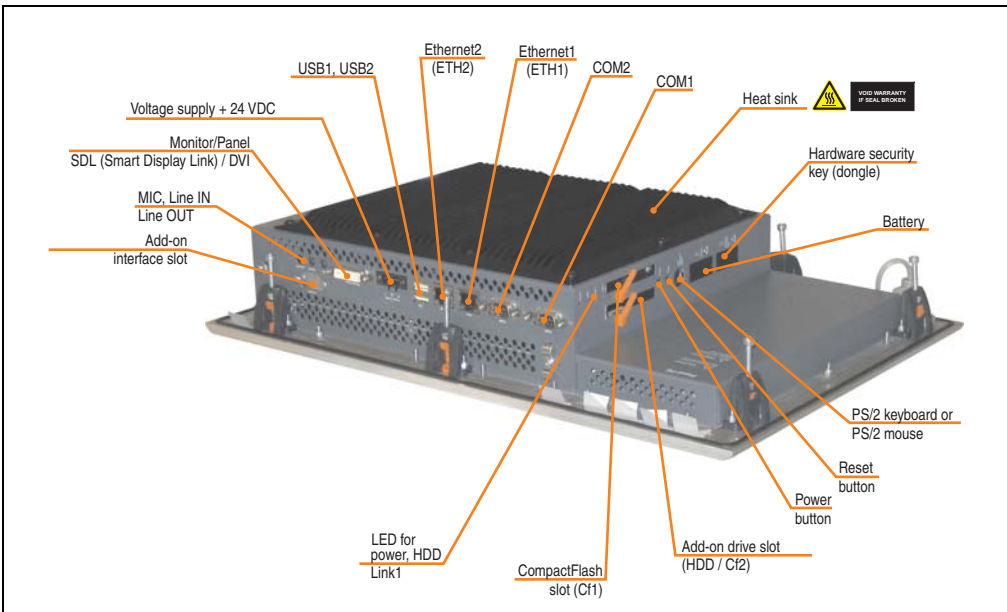

Figure 82: Rear view 5PC782.1043-00

Warning!

Do not remove mounting screws from the heat sink, as it is connected to the processor and chipset by a thermal coupling. If this connection is broken, the PPC700 must be sent for repair. Removal of the mounting screws, which can be determined by a broken seal, voids all warranty.

During operation, surface temperatures of the heat sink may reach 70°C (warning "hot surface").

Dimensions

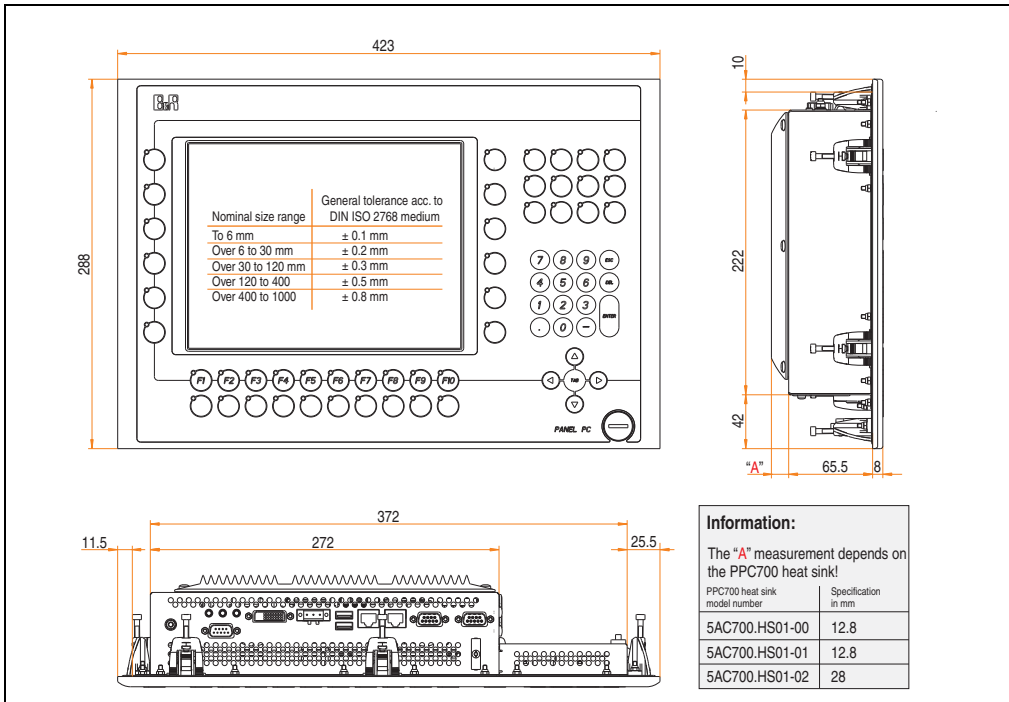

Figure 83: Dimensions - 5PC782.1043-00

Technical data

Features	5PC782.1043-00 ≤ K0	5PC782.1043-00 ≥ L0
B&R ID code	0x1C62	
Serial interfaces	See "Serial interface COM1", on page 72 and "Serial interface COM2", on page 73	
Type	RS232, modem capable	
Amount	2	
UART	16550 compatible, 16 byte FIFO	
Transfer rate	Max. 115 kBaud	
Connection	9-pin DSUB, male	
Ethernet	See "Ethernet connection ETH1", on page 74 and "Ethernet connection ETH2", on page 76	
Controller	10/100 Mbit/s	
Transfer rate	RJ45 twisted pair (10 Base T / 100 Base T)	
Connection		
USB ports	See also "USB ports", on page 77	
Type	USB 2.0	
Amount	3 (2x back side, 1x front side)	
Transfer rate	Up to 480 Mbit ¹⁾ (high speed)	
Connection	Type A	
Monitor / Panel	See also "Monitor / Panel interface", on page 80	
Type	DVI-I, female	
AC97 sound	See also "MIC, Line IN and Line OUT ports", on page 81	
Inputs	Microphone, line in	
Outputs	Line out	
Add-on interface slot	See also "Add-on interface slot", on page 82	
Amount	1	
PCI slots	-	
Amount		
Type		
Standard		
CompactFlash slot 1 (CF1)	Yes, see also "CompactFlash slot (CF1)", on page 85	
Internal organization	Primary master	
CompactFlash slot 2 / hard disk (HDD/CF2)	Yes, see also "Hard disk / CompactFlash slot (HDD/CF2)", on page 86	
Type	Combined	
Internal organization	Primary slave	
Insert for slide-in drive 1	-	
Internal organization		
SRAM internal slot options	No	
Reset button	Yes, see also "Power button", on page 87	
Power button	Yes, see also "Reset button", on page 87	
PS/2 keyboard / mouse	Yes, see also "PS/2 keyboard / mouse", on page 88	
Type	Combined, automatically detected	
Battery	Yes, see also "Battery", on page 89	
Type	Renata 950 mAh	
Removable	Yes, accessible from the outside	
Service life	4 years ²⁾	
Hardware security key compartment	Yes, see also "Hardware security key", on page 91	
Optimized for	DS1425 from MAXIM/Dallas	

Table 62: Technical data - 5PC782.1043-00

Technical data • Individual components

Features	5PC782.1043-00 ≤ K0	5PC782.1043-00 ≥ L0
Fan insert for fan kit	Yes, compatible fan kit - see section 3.8.1 "Fan kit 5PC700.FA00-01", on page 214	
LED Amount	See also "Status LEDs", on page 84 3 (Power, HDD, Link 1)	
Touch screen ³⁾ Touch screen type Technology Controller Degree of transmission	Elo Accu Touch Analog, resistive Elo, serial, 12-bit Up to 78%	AMT analog, resistiv Elo, seriell, 12 Bit bis zu 81% ±3%
Display Type Diagonal Colors Resolution Contrast Viewing angle (see page 485) Horizontal Vertical Background lighting Type Brightness Half-brightness time ⁴⁾	Color TFT 10.4 inch (264 mm) 262,144 colors VGA, 640 x 480 pixels 300:1 Direction R / direction L = 70° Direction U / direction D = 70° CCFL 350 cd/m ² 50000 hours	
Keys/LED ⁵⁾ Function keys Soft keys Cursor keys Number block Other keys Key lifespan LED brightness	44 with LED (yellow) - - 15 without LED 5 without LED > 1,000,000 actuations with 1 ±0.3 to 3 ±0.3 N operating force Typically 12 mcd (yellow)	
Caution! Pressing more than one key at a time may result in so-called phantom keys, and may trigger unintended actions.		
Electrical characteristics		
Power supply Rated voltage Rated current Starting current Power consumption Electrical isolation	See also "Supply voltage", on page 78 24 VDC ±25% 3.8 A Typ. 10 A, max. 40 A for < 300 µs See power management section "Power calculation for 10.4" Panel PC 700", on page 59 Yes	
Mechanical characteristics		
Front Frame Design Membrane Dark gray border around display Light background Orange keys Dark gray keys Color legend strips Gasket	Naturally anodized aluminum ⁶⁾ Gray ⁶⁾ Polyester Similar to Pantone 432CV ⁶⁾ Similar to Pantone 427CV ⁶⁾ Similar to Pantone 151CV ⁶⁾ Similar to Pantone 431CV ⁶⁾ Similar to Pantone 429CV ⁶⁾ Flat gasket around display front	
Housing	Metal	

Table 62: Technical data - 5PC782.1043-00 (Forts.)

Mechanical characteristics	5PC782.1043-00 ≤ K0	5PC782.1043-00 ≥ L0
Outer dimensions Width Height Depth	Also see diagram "Dimensions - 5PC782.1043-00", on page 162 423 mm 288 mm 86.3 mm (depending on the heat sink)	
Weight	Approx. 7.5 kg	
Environmental characteristics		
Ambient temperature Operation Bearings Transport	See 2.1.12 "Ambient temperatures with system unit 5PC782.1043-00", on page 55 -30 to +70°C -30 to +70°C	
Relative humidity Operation / Storage / Transport	T ≤ 40°C: 5% to 90%, non-condensing T > 40°C: < 90%, non-condensing	
Vibration Operation (continuous) Operation (occasional) Bearings Transport	2 - 9 Hz: 1.75 mm amplitude / 9 - 200 Hz: 0.5 g 2 - 9 Hz: 3.5 mm amplitude / 9 - 200 Hz: 1 g 2 - 8 Hz: 7.5 mm amplitude / 8 - 200 Hz: 2 g / 200 - 500 Hz: 4 g 2 - 8 Hz: 7.5 mm amplitude / 8 - 200 Hz: 2 g / 200 - 500 Hz: 4 g	
Shock Operation Bearings Transport	15 g, 11 ms 30 g, 15 ms 30 g, 15 ms	
Protection	IP20 back side (only with installed CompactFlash card) IP65 / NEMA 250 type 4X, dust and sprayed water protection (front side)	
Altitude	Max. 3,000 m	

Table 62: Technical data - 5PC782.1043-00 (Forts.)

- 1) Software must support USB 2.0 (e.g. Windows XP with at least Service Pack 1).
- 2) At 50°C, 8.5 µA of the supplied components and a self discharge of 40%.
- 3) Touch screen drivers can be downloaded from the download area on the B&R homepage (www.br-automation.com).
- 4) At 25°C ambient temperature. Reducing the brightness by 50% can result in an approximate 50% increase of the half-brightness time.
- 5) The key and LED functions can be freely configured with the B&R Key Editor, which can be found in the download area of the B&R homepage (www.br-automation.com) or on the B&R HMI Driver & Utilities DVD (model number 5SWHMI.0000-00).
- 6) Depending on the process or batch, there may be visible deviations in the color and surface structure.

Cutout installation

The Panel PC 700 with preassembled mounting blocks is installed e.g. in a housing cutout. A cutout that corresponds to the following drawing must be made.

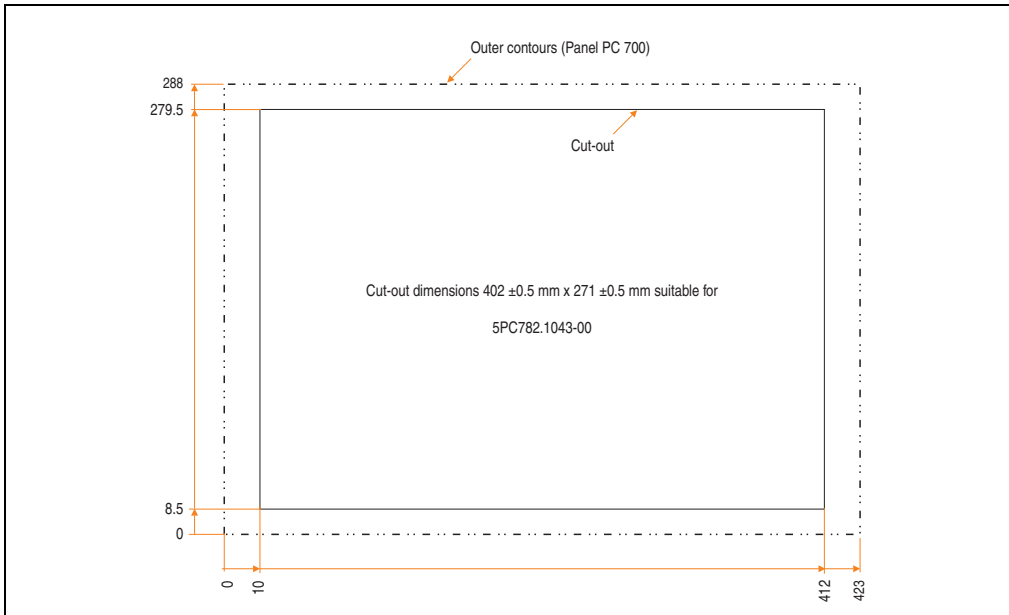

Figure 84: Cutout installation - 5PC782.1043-00

For further information regarding mounting and installation position, see chapter 3 "Commissioning", on page 219.

3.2 X945 CPU boards

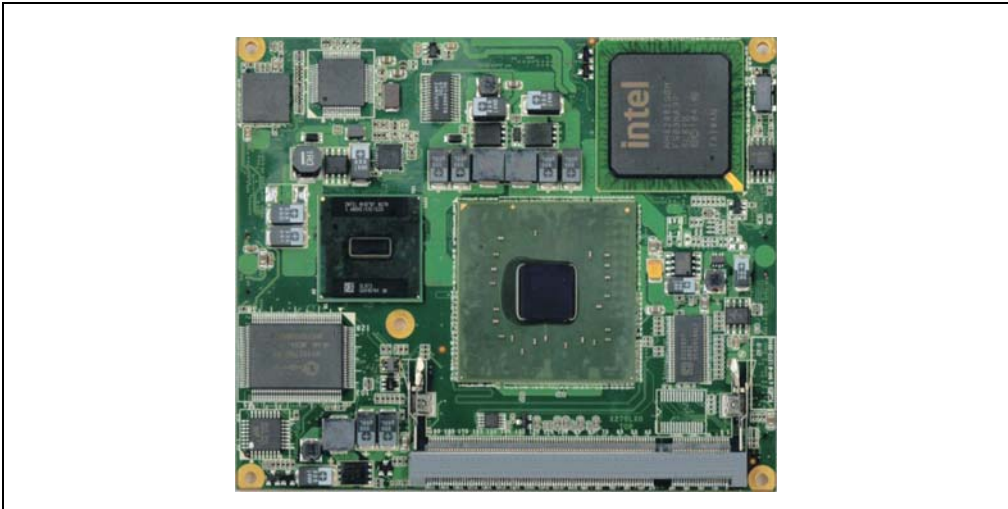

Figure 85: X945 CPU board

Information:

The following characteristics, features, and limit values only apply to this individual component and can deviate from those specified for the entire device. For the entire device in which this individual component is used, refer to the data given specifically for the entire device.

Features	5PC600.X945-00
Boot loader / Operating system	BIOS AMI (see Section 1 "BIOS options", on page 249)
Processor	
Architectures	45 nm
Type	Intel® Atom™
Name	N270
Clock frequency	1.6 GHz
Expanded command set	Hyper-threading technology, enhanced speed step SSE, SSE2, SSE3 (Streaming SIMD extensions)
L1 cache	24 KB
L2 cache	512 KB
Floating point unit (FPU)	Yes
Chipset	Intel® 945GME / Intel 82801GBM (ICH7-M)
Real-time clock (RTC)	Yes
Battery-buffered	
Accuracy	At 25°C, typically 12 ppm (1sec) ¹⁾ per day

Table 63: Technical data - CPU board X945

Technical data • Individual components

Features	5PC600.X945-00
Front side bus	533 MHz
Mass memory management	1x EIDE
Memory Type Size Socket	DDR2 Max. 2 GB SO-DIMM 200-pin
Graphics Controller Memory Color depth Resolution RGB GE ¹⁾²⁾ = LVDS	Intel® Graphics Media Accelerator 950 Up to 224 MB (reserved from main memory) Max 32 Bit 400 MHz RAMDAC, up to 2048 x 1536 @75 Hz (QXGA) including 1920 x 1080 @ >85 Hz (HDTV) From 640 x 480 up to 1920 x 1200 (Embedded Panel Interface based on VESA EDID™ 1.3)

Table 63: Technical data - CPU board X945 (Forts.)

- 1) At max. specified ambient temperature: typically 58 ppm (5 seconds) - worst-case 220 ppm (19 seconds).
- 2) GE = Graphics Engine

Driver support

In order for the CPU board with the Intel 945GME chipset to work properly, it is necessary to install the Intel chipset driver (e.g. special USB driver) and the graphics chip. The necessary software can be downloaded from the download area on the B&R homepage (www.br-automation.com).

Information:

Required drivers can only be downloaded from the B&R homepage, not from manufacturers' pages.

3.3 Heat sink

There are a number of heat sink variants available to be used with different CPU boards.

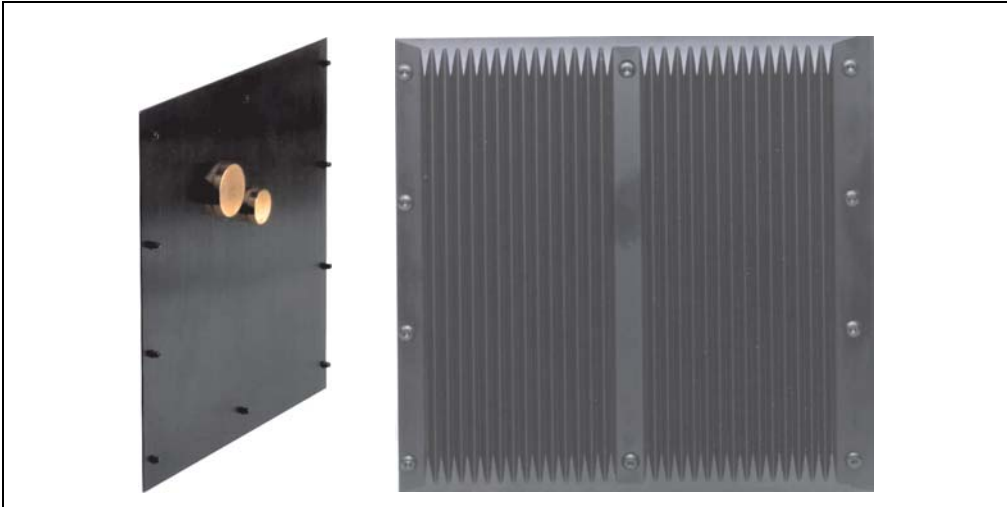

Figure 86: Heat sink

Information:

The following characteristics, features, and limit values only apply to this individual component and can deviate from those specified for the entire device. For the entire device in which this individual component is used, refer to the data given specifically for the entire device.

A heat sink can only be replaced at the B&R plant.

Mechanical characteristics	5AC700.HS01-03
Ideal for CPU boards	5PC600.X945-00
Material	Black-coated aluminum
Outer dimensions	
Width	205 mm
Height	208 mm
Depth	12.8 mm
Weight	1450 g

Table 64: Technical data - Heat sink

3.4 Main memory

When choosing a main memory, it is important to consider the 2 GB maximum memory capacity of the CPU boards.

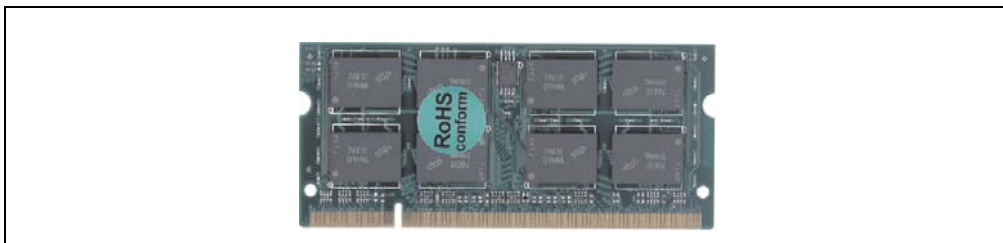

Figure 87: Main memory module

3.4.1 Technical data

Features	5MMDDR.0512-01	5MMDDR.1024-01	5MMDDR.2048-01
Size	512 MB	1 GB	2 GB
Type	DDR2 SDRAM / PC2-5300		
Construction	200 Pin SO-DIMM		
Organization	64M x 64-bit	128M x 64-bit	256M x 64-bit

Table 65: Technical data - Main memory

Information:

A main memory module can only be replaced at the B&R plant.

3.5 Drives

3.5.1 Add-on Solid State Drive 128 GB 24x7 ET - 5AC600.SSDI-00

This 128 GB add-on SSD (Solid State Drive) is based on Multi Level Cell (MLC) technology and is ATA/ATAPI compatible. The add-on drive is referred to internally as the primary slave drive.

Information:

Add-on drives are only available factory-installed. Therefore, they need to be requested when placing an order.



Figure 88: Add-on SSD 128 GB - 5AC600.SSDI-00 ≤ D0



Figure 89: Add-on SSD 128 GB - 5AC600.SSDI-00 ≥ E0

Technical data

Information:

A sudden loss of power may result in data loss! In very rare cases, mass memory may also be damaged.

To prevent damage and loss of data, the use of a UPS device is recommended.

Information:

The following characteristics, features and limit values only apply to this individual component and can deviate from those specified for the fully assembled device. For the assembled device in which this individual component is used, refer to the data given specifically for that device.

Features	5AC600.SSDI-00 Revision ≤ C0	5AC600.SSDI-00 Revision ≥ D0	5AC600.SSDI-00 Revision ≥ E0 ¹⁾
Manufacturer	Transcend		Innodisk
Manufacturer's product ID	TS128GSPSD320	TS128GSPSD330	DEP25-A28D06SWH88
Formatted capacity	128 GB		
Data reliability	< 1 unrecoverable error in 10 ¹⁶ bit read accesses		
Interface	PATA		
S.M.A.R.T. Support	Yes		
MTBF	1,000,000 hours		3,000,000 hours
Continuous reading	Max. 103.7 MB/s	Max. 118.4 MB/s	Max. 90 MB/s
Continuous writing	Max. 93.15 MB/s	Max. 92.75 MB/s	Max. 90 MB/s
IOPS ²⁾			
4k read	7.733 MB/s	13.09 MB/s	-
4k write	0.722 MB/s	1.225 MB/s	-
Mechanical characteristics			
MLC flash	Yes		
Compatibility	PATA (ATA/ATAPI 8) SSD Enhanced SMART ATA feature set Ultra DMA Mode 0-6 Multi-Word DMA Mode 0-2 PIO Mode 0-4		
Data volume	80 TBW ³⁾		345,6 TBW ³⁾
Mechanical characteristics			
Add-on mounting	Fixed		
Outer dimensions ⁴⁾			
Width	69.85 mm		69.85 mm
Height	7.40 mm		7.20 mm
Depth	100.3 mm		99,85 mm
Weight ⁵⁾	55 g		100 g
Environmental characteristics			
Ambient temperature			
Operation	0 to 70°C		-40 to 85°C
Storage	-40 to 85°C		-55 to 95°C
Transport	-40 to 85°C		-55 to 95°C

Table 66: Technical data - Add-on SSD - 5AC600.SSDI-00

Features	5AC600.SSDI-00 Revision ≤ C0	5AC600.SSDI-00 Revision ≥ D0	5AC600.SSDI-00 Revision ≥ E0 ¹⁾
Relative humidity Operation Storage Transport	0 to 95%, non-condensing 0 to 95%, non-condensing 0 to 95%, non-condensing		10 to 95%, non-condensing 10 to 95%, non-condensing 10 to 95%, non-condensing
Vibration Operation Storage Transport	20 to 2000 Hz: 20 g 20 to 2000 Hz: 20 g 20 to 2000 Hz: 20 g		7 to 2000 Hz: 20 g 7 to 2000 Hz: 20 g 7 to 2000 Hz: 20 g
Shock (pulse with a sine half-wave) Operation Storage Transport	1500 g, 0,5 ms 1500 g, 0,5 ms 1500 g, 0,5 ms		
Altitude Operation Storage Transport	- 300 to 12192 meters - 300 to 12192 meters - 300 to 12192 meters		

Table 66: Technical data - Add-on SSD - 5AC600.SSDI-00 (Forts.)

- 1) The simultaneous operation with a CompactFlash card in the CompactFlash1 slot is no longer recommended.
- 2) IOPS: Random read and write input/output operations per second.
- 3) TBW: Terabyte written
- 4) Dimensions without add-on
- 5) Weight without add-on

Temperature humidity diagram

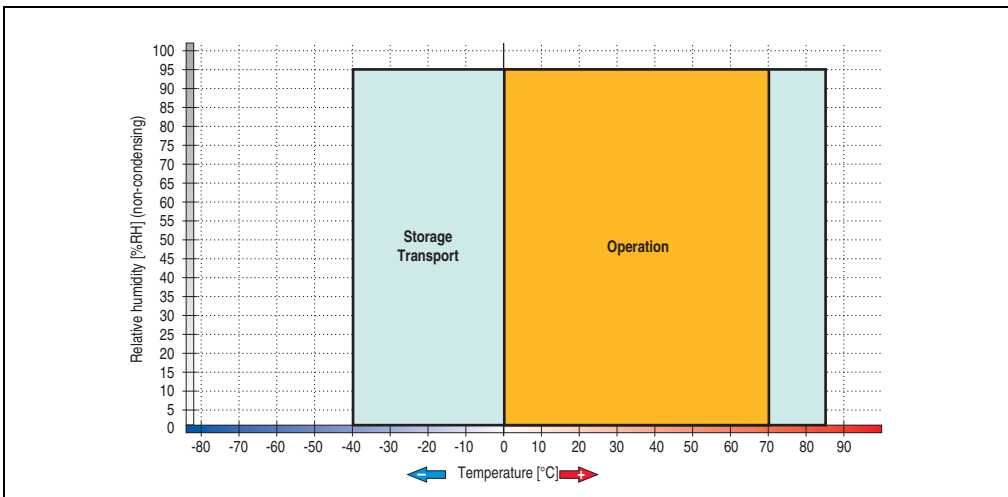

Figure 90: Temperature humidity diagram - Add-on SSD 128 GB - 5AC600.SSDI-00 ≤ D0

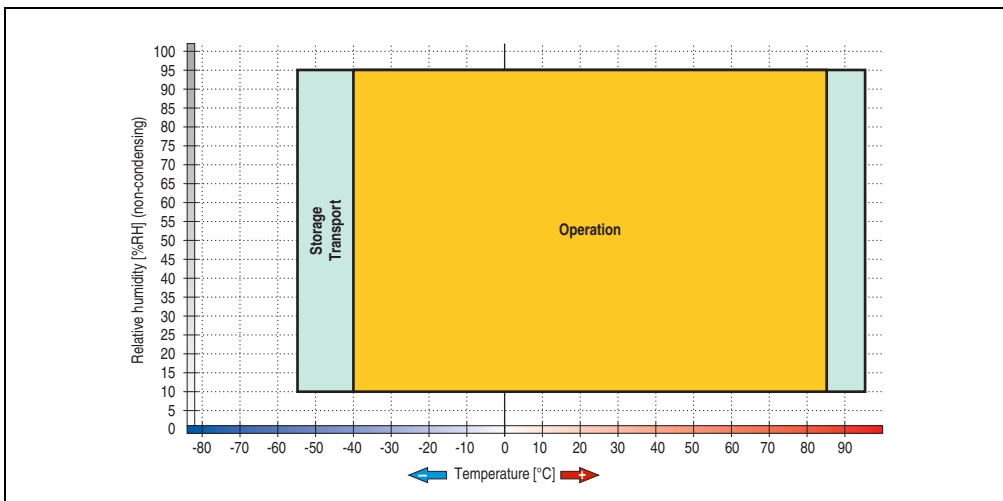

Figure 91: Temperature humidity diagram - Add-on SSD 128 GB - 5AC600.SSDI-00 ≥ E0

3.5.2 Replacement Solid State Drive 128 GB 24x7 ET - 5MMSSD.0128-00

This 128 GB Solid State Drive can be used as a replacement part for the 5AC600.SSDI-00 SSD.



Figure 92: Replacement SSD 128 GB - 5MMSSD.0128-00 ≤ D0

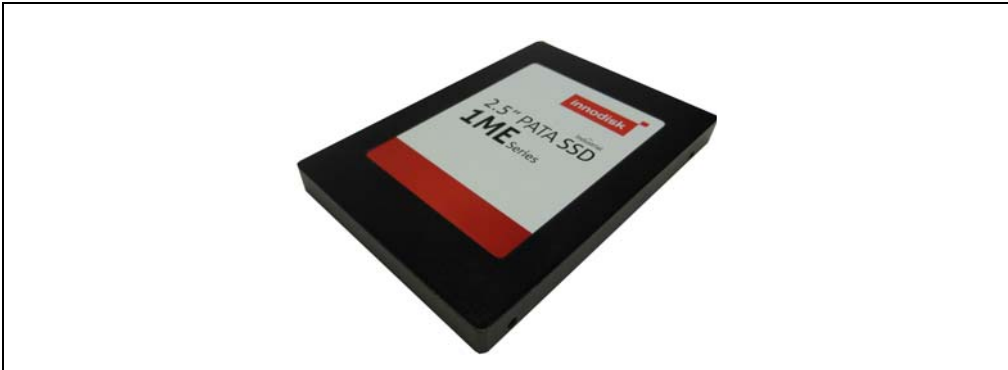

Figure 93: Replacement SSD 128 GB - 5MMSSD.0128-00 ≥ E0

Technical data

Information:

A sudden loss of power may result in data loss! In very rare cases, mass memory may also be damaged.

To prevent damage and loss of data, the use of a UPS device is recommended.

Information:

The following characteristics, features, and limit values only apply to this individual component and can deviate from those specified for the fully assembled device. For the assembled device in which this individual component is used, refer to the data given specifically for that device.

Technical data • Individual components

Features	5MMSSD.0128-00 Revision ≤ C0	5MMSSD.0128-00 Revision ≥ D0	5MMSSD.0128-00 Revision ≥ E0
Manufacturer	Transcend		Innodisk
Manufacturer's product ID	TS128GPSD320	TS128GPSD330	DEP25-A28D06SWH88
Formatted capacity	128 GB		
Data reliability	< 1 unrecoverable error in 10 ¹⁶ bit read accesses		
Interface	PATA		
S.M.A.R.T. Support	Yes		
MTBF	1,000,000 hours		3,000,000 hours
Continuous reading	Max. 103.7 MB/s	Max. 118.4 MB/s	Max. 90 MB/s
Continuous writing	Max. 93.15 MB/s	Max. 92.75 MB/s	Max. 90 MB/s
IOPS ¹⁾			
4k read	7.733 MB/s	13.09 MB/s	-
4k write	0.722 MB/s	1.225 MB/s	-
Mechanical characteristics			
MLC flash	Yes		
Compatibility	PATA (ATA/ATAPI 8) SSD Enhanced SMART ATA feature set Ultra DMA Mode 0-6 Multi-Word DMA Mode 0-2 PIO Mode 0-4		
Data volume	80 TBW ²⁾		345,6 TBW ²⁾
Mechanical characteristics			
Outer dimensions			
Width	69.85 mm		69.85 mm
Height	7.40 mm		9.20 mm
Depth	100.3 mm		99.85 mm
Weight	55 g		100 g
Environmental characteristics			
Ambient temperature			
Operation	0 to 70°C		-40 to 85°C
Storage	-40 to 85°C		-55 to 95°C
Transport	-40 to 85°C		-55 to 95°C
Relative humidity			
Operation	0 to 95%, non-condensing		10 to 95%, non-condensing
Storage	0 to 95%, non-condensing		10 to 95%, non-condensing
Transport	0 to 95%, non-condensing		10 to 95%, non-condensing
Vibration			
Operation	20 to 2000 Hz: 20 g		7 to 2000 Hz: 20 g
Storage	20 to 2000 Hz: 20 g		7 to 2000 Hz: 20 g
Transport	20 to 2000 Hz: 20 g		7 to 2000 Hz: 20 g
Shock (pulse with a sine half-wave)			
Operation	1500 g, 0.5 ms		
Storage	1500 g, 0.5 ms		
Transport	1500 g, 0.5 ms		

Table 67: Technical data - Replacement SSD - 5MMSSD.0128-00

Features	5MMSSD.0128-00 Revision ≤ C0	5MMSSD.0128-00 Revision ≥ D0	5MMSSD.0128-00 Revision ≥ E0
Altitude Operation Storage Transport		- 300 to 12192 meters - 300 to 12192 meters - 300 to 12192 meters	

Table 67: Technical data - Replacement SSD - 5MMSSD.0128-00 (Forts.)

- 1) IOPS: Random read and write input/output operations per second.
- 2) TBW: Terabyte written

Temperature humidity diagram

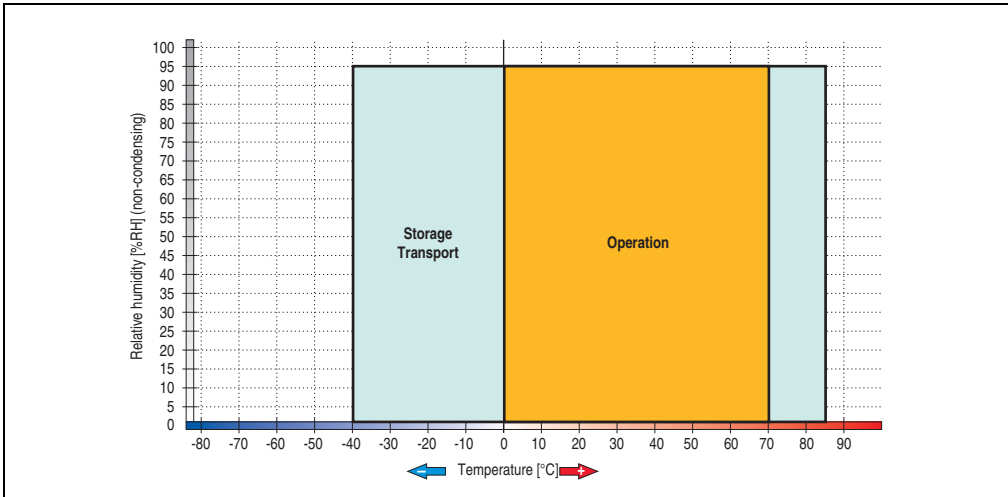

Figure 94: Temperature humidity diagram - Replacement SSD 128 GB - 5MMSSD.0128-00 ≤ D0

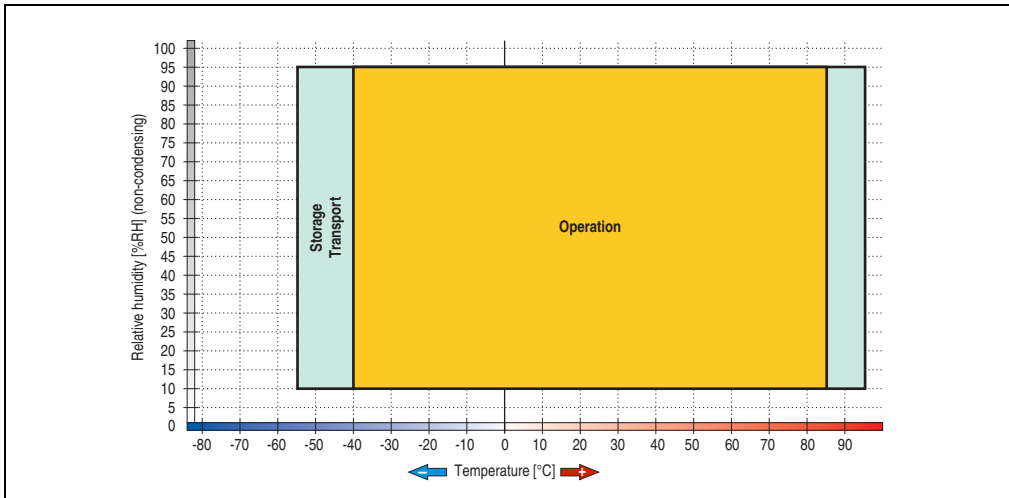

Figure 95: Temperature humidity diagram - Replacement SSD 128 GB - 5MMSSD.0128-00 ≥ E0

3.5.3 Add-on hard disk 40 GB - 5AC600.HDDI-05

This hard disk is specified for 24-hour operation and also provides an extended temperature specification. The add-on drive is referred to internally as the primary slave drive.

Information:

Add-on drives are only available factory-installed. Therefore, they need to be requested when placing an order.



Figure 96: Add-on hard disk 40 GB - 5AC600.HDDI-05

Technical data

Information:

The following characteristics, features, and limit values only apply to this individual component and can deviate from those specified for the entire device. For the entire device in which this individual component is used, refer to the data given specifically for the entire device.

Features	5AC600.HDDI-05
Manufacturer's product ID	Seagate ST940813AM
Formatted capacity	40 GB
Number of heads	2
Number of sectors (user)	78,140,160
Bytes per sector	512
Revolution speed	5400 rpm \pm 1%
Access time (average)	12.5 ms

Table 68: Technical data - Add-on hard disk 5AC600.HDDI-05

Technical data • Individual components

Features	5AC600.HDDI-05
Positioning time (seek, typical values) Minimum (track to track) Average (read access) Maximum (read access)	1 ms 12.5 ms 22 ms
Starting time (0 rpm to read access)	3 seconds (typically)
Interface	ATA-6
Data transfer rate On the medium To/from host	max. 321 Mbit/s Max. 100 MB/s (ultra-DMA mode 5)
Cache	8 MB
S.M.A.R.T. Support	Yes
MTBF	550000 hours ¹⁾
Mechanical characteristics	
Add-on mounting	Fixed
Outer dimensions Width Length Height	70 mm 100 mm 9.5 mm
Weight	100 g
Environmental characteristics	
Ambient temperature ²⁾ Operation - Standard / 24-hour Storage Transport	-30 to +85°C -40 to +95°C -40 to +95°C
Relative humidity Operation Storage Transport	5 to 90%, non-condensing 5 to 95%, non-condensing 5 to 95%, non-condensing
Vibration Operation Storage	10 - 500 Hz: 1 g (9.8 m/s ² 0-peak) no non-recovered errors 5 - 500 Hz: 5 g (49 m/s ² 0-peak) no non-recovered errors
Shock (pulse with a sine half-wave) Operation Storage	No non-recovered errors at max. 200 g (1962 m/s ² 0-peak) and 2 ms duration No non-recovered errors at max. 110 g (1079 m/s ² 0-peak) and 11 ms duration No damage at max. 800 g (7848 m/s ² 0-peak) and 2 ms duration No damage at max. 400 g (3924 m/s ² 0-peak) and 0.5 ms duration
Altitude Operation Storage	- 300 to 4419 meters - 300 to 12192 meters

Table 68: Technical data - Add-on hard disk 5AC600.HDDI-05 (Forts.)

- 1) With 8760 POH (Power On Hours) per year and 70°C surface temperature.
- 2) Temperature values for 305 meter altitude. The temperature specification must be reduced linearly by 1°C every 305 meters. The temperature increase and decrease can be a maximum of 3°C per minute.

Temperature humidity diagram

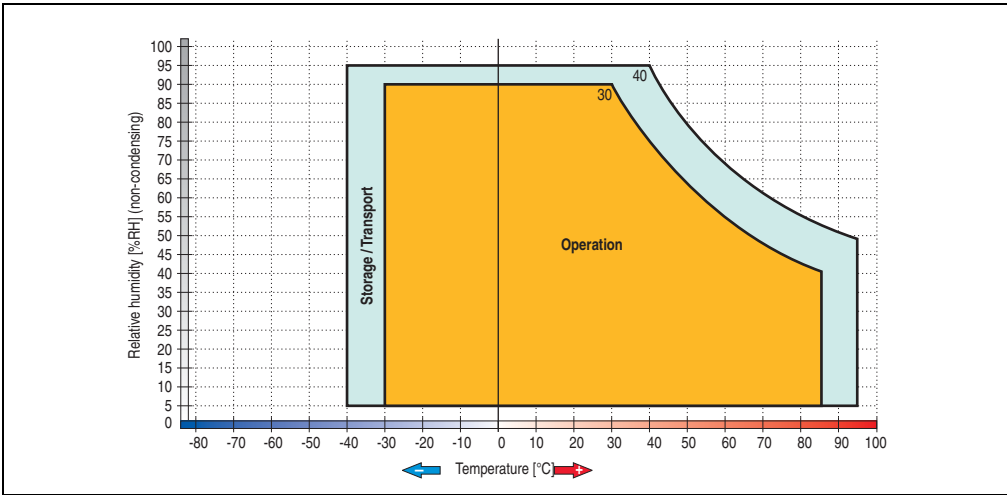

Figure 97: Temperature humidity diagram - Add-on hard disk 5AC600.HDDI-05

Temperature data is for operation at 500 meters. Derating the max. ambient temperature - typically 1°C per 1000 meters (from 500 meters above sea level).

3.5.4 Add-on hard disk 80 GB 24x7 ET - 5AC600.HDDI-06

This hard disk is specified for 24-hour operation (24x7) and also provides an extended temperature specification (ET). The add-on drive is referred to internally as the primary slave drive.

Information:

Add-on drives are only available factory-installed. Therefore, they need to be requested when placing an order.



Figure 98: Add-on hard disk 80 GB - 5AC600.HDDI-06

Technical data

Information:

The following characteristics, features, and limit values only apply to this individual component and can deviate from those specified for the entire device. For the entire device in which this individual component is used, refer to the data given specifically for the entire device.

Features	5AC600.HDDI-06
Manufacturer's product ID	Seagate ST980817AM
Formatted capacity	80 GB
Number of heads	2
Number of sectors (user)	156,301,488
Bytes per sector	512
Revolution speed	5400 rpm \pm 1%
Access time (average)	10 ms

Table 69: Technical data - add-on hard disk - 5AC600.HDDI-06

Features	5AC600.HDDI-06
Positioning time (seek, typical values) Minimum (track to track) Average (read access) Maximum (read access)	1 ms 12.5 ms 22 ms
Starting time (0 rpm to read access)	4 seconds (typically)
Interface	ATA-6
Data transfer rate On the medium To/from host	Max. 450 Mbit/s Max. 100 MB/s (Ultra-DMA Mode 5)
S.M.A.R.T. Support	Yes
Cache	8 MB
MTBF	750000 hours ¹⁾
Mechanical characteristics	
Add-on mounting	Fixed
Outer dimensions (without slide-in) Width Length Height	70 mm 100 mm 9.5 mm
Weight	120 g
Environmental characteristics	
Ambient temperature ²⁾ Operation - Standard / 24-hour Storage Transport	-30 to +85°C -40 to +95°C -40 to +95°C
Relative humidity Operation Storage Transport	5 to 90%, non-condensing 5 to 95%, non-condensing 5 to 95%, non-condensing
Vibration Operation Storage	5 - 500 Hz: 2 g; no non-recovered errors 5 - 500 Hz: 5 g; no non-recovered errors
Shock (pulse with a sine half-wave) Operation Storage	Max. 300 g, 2 ms; no non-recovered errors Max. 150 g, 11 ms; no non-recovered errors Max. 800 g, 2 ms; no damage Max. 400 g, 0.5 ms; no damage
Altitude Operation Storage	- 300 to 5000 meters - 300 to 12192 meters

Table 69: Technical data - add-on hard disk - 5AC600.HDDI-06 (Forts.)

- 1) With 8760 POH (Power On Hours) per year and 70°C surface temperature.
- 2) Temperature values for 305 meter altitude. The temperature specification must be reduced linearly by 1°C every 305 meters. The temperature increase and decrease can be a maximum of 3°C per minute.

Temperature humidity diagram

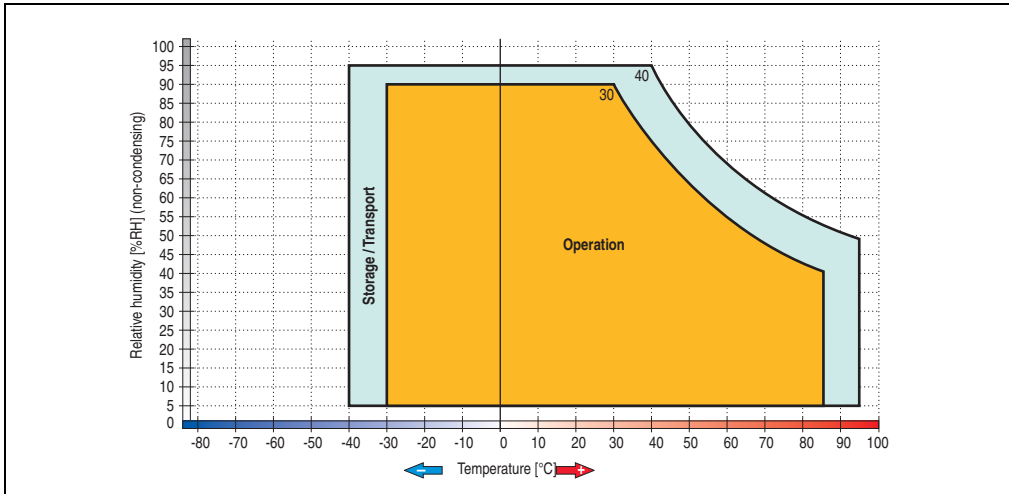

Figure 99: Temperature humidity diagram - Add-on hard disk 5AC600.HDDI-06

Temperature values for 305 meter altitude. The temperature specification must be reduced linearly by 1°C every 305 meters. The temperature increase and decrease can be a maximum of 3°C per minute.

3.5.5 Add-on CompactFlash slot - 5AC600.CFSI-00

A CompactFlash card inserted in the add-on drive is referred to internally as the "primary slave drive."

Information:

Add-on drives are only available factory-installed. Therefore, they need to be requested when placing an order.

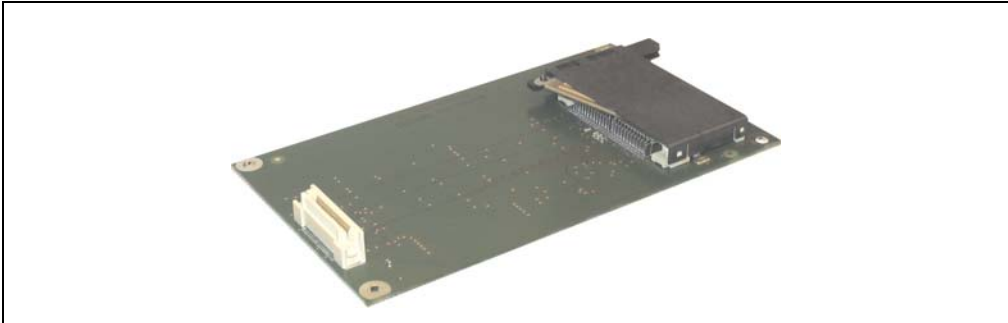

Figure 100: Add-on CompactFlash slot - 5AC600.CFSI-00

Technical data

Features	5AC600.CFSI-00
CompactFlash Type	Type I
Amount	1 slot
Connection	Primary slave
Weight	100 g

Table 70: Technical data - Add-on CompactFlash slot 5AC600.CFSI-00

Warning!

Turn off power before inserting or removing the CompactFlash card!

3.5.6 Slide-in USB FDD - 5AC600.FDDS-00

The slide-in drive can be used in system units with 1 or 2 PCI slots. In these units it is connected to the system via USB.

Information:

It is possible to add or remove a slide-in drive at any time.

Caution!

Turn off power before adding or removing a slide-in drive.



Figure 101: Slide-in USB FDD - 5AC600.FDDS-00

Technical data

Information:

The following characteristics, features, and limit values only apply to this individual component and can deviate from those specified for the entire device. For the entire device in which this individual component is used, refer to the data given specifically for the entire device.

Features	5AC600.FDDS-00
Data capacity	720 KB / 1.25 MB / 1.44 MB (formatted)
USB transfer rate	Full speed (12 Mbps)
Data transfer rate	250 kbits (720 KB) or 500 kbits (1.25 MB and 1.44 MB)
Rotation speed	Up to 360 rpm
Diskette media	High density (2HD) or normal density (2DD) 3.5" diskettes
MTBF	30000 POH (Power-On Hours)
Environmental characteristics	
Ambient temperature ¹⁾	
Operation	+4 to +50°C
Storage	-20 to +60°C
Transport	-20 to +60°C
Relative humidity	
Operation	20 to 80%, non-condensing
Storage	5 to 90%, non-condensing
Transport	5 to 90%, non-condensing
Vibration	
Operation	At max. 5 - 500 Hz and 0.3 g
Storage	At max. 10 - 100 Hz and 2 g
Transport	At max. 10 - 100 Hz and 2 g
Shock (pulse with a sine half-wave)	
Operation	At max. 5 g for 11 ms
Storage	At max. 60 g for 11 ms
Transport	At max. 60 g for 11 ms
Altitude	Max. 3000 meters

Table 71: Technical data - Slide-in USB diskette drive - 5AC600.FDDS-00

1) Temperature data is for operation at 500 meters. Derating the max. ambient temperature - typically 1°C per 1000 meters (from 500 meters above sea level).

Temperature humidity diagram

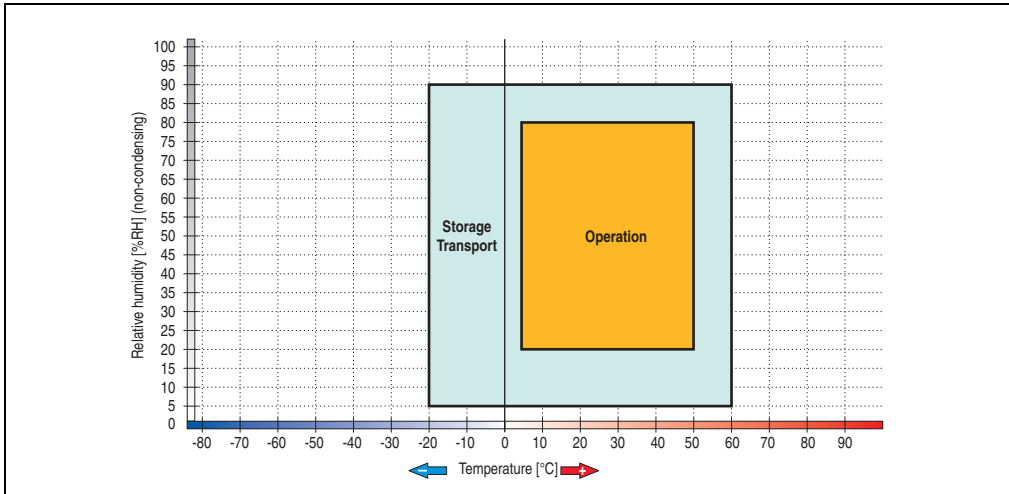

Figure 102: Temperature humidity diagram - Slide-in USB diskette drive 5AC600.FDDS-00

Temperature data is for operation at 500 meters. Derating the max. ambient temperature - typically 1°C per 1000 meters (from 500 meters above sea level).

3.6 RAID system

Sometimes it is simply not possible to avoid using hard disks due to the amount of data that needs to be saved. In this case, a RAID provides high system availability. All data is simultaneously and automatically stored on two hard drives. This double data storage means that when one hard disk fails, the system will continue to run on the second hard disk.

Advantages for the user:

- No data loss when hard drive fails.
- The system continues to run with a hard disk.
- Data redundancy is automatically restored by the system when the faulty hard disk has been replaced.

Depending on the type, the RAID 1 system is designed in the form of 1 or 2 PCI cards.

1 PCI slot: PCI SATA RAID controller - 5ACPCI.RAIC-03 (2x160GB)

2 PCI slot: PCI RAID controller (5ACPCI.RAIC-00) and PCI card with two hard disks (5ACPCI.RAIS-00 or 5ACPCI.RAIS-01)

The system can be flexibly implemented in all APC620 und PPC700s with 1 free PCI slot (depending on the RAID system design). The system also supports RAID 0 applications. As a result, parallel access to two hard drives with a relatively high data throughput is the main focus, in addition to the high availability.

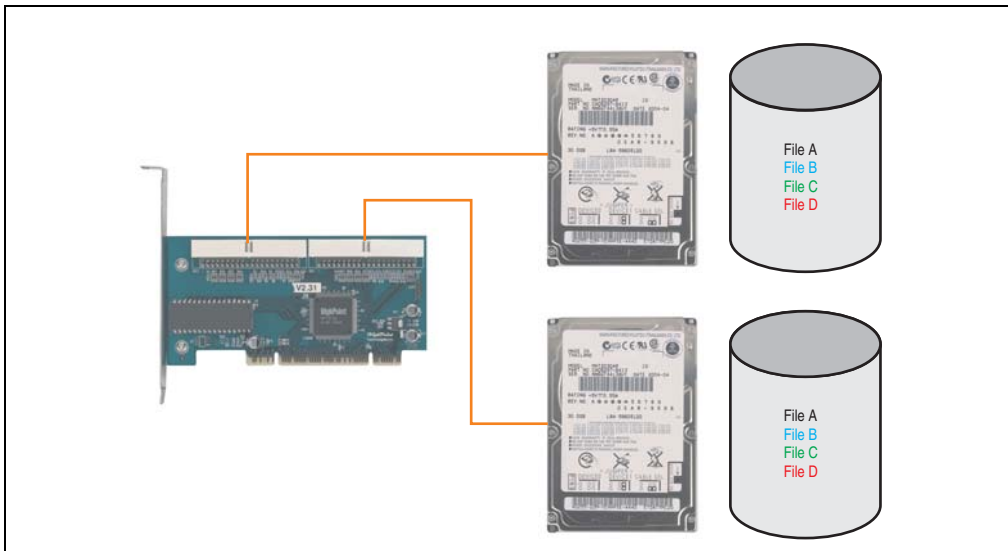

Figure 103: RAID 1 system schematic

3.6.1 PCI SATA RAID 2 x 160 GB 24x7 ET - 5ACPCI.RAIC-03

The hard disks being used are specified for 24-hour operation (24x7) and also provides an extended temperature specification (ET).

Features

- SATA RAID controller
- RAID Level 0 (striped) and 1 (mirrored)
- 2 SATA hard disk drives (suitable for 24 hour operation)
- Only requires 1 PCI slot
- Transfer rates up to 150 MB/s

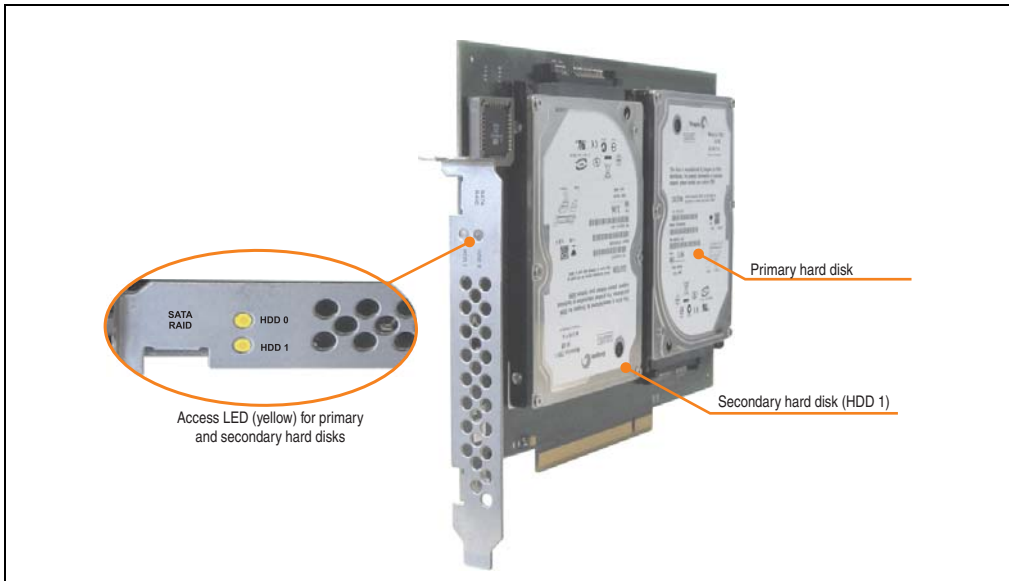

Figure 104: PCI SATA RAID controller - 5ACPCI.RAIC-03

Information:

The PCI SATA RAID controller can not be used in place of a Universal Power Supply (UPS). If the operating system is shut down improperly, the next time it is started it is detected as an error by the RAID 1, and a complete rebuild is executed. This generally takes at least 50 minutes (configurable) to complete.

Technical data

Information:

The following characteristics, features, and limit values only apply to this individual component and can deviate from those specified for the entire device. For the entire device in which this individual component is used, refer to the data given specifically for the entire device.

Features	5ACPCI.RAIC-03
SATA RAID controller Type Specifications Data transfer rate RAID level BIOS Extension ROM - requirements	Sil 3512 SATA link Serial ATA 1.0 Max. 1.5 GB/s (150 MB/s) Supports RAID 0, 1 Approx. 32 KB
Hard disks Amount	Fujitsu M120-ESW MHY2160BH-ESW 2
Formatted capacity (512 bytes/sector)	160 GB
Number of heads	3
Number of sectors (user)	312,581,808
Bytes per sector	512
Revolution speed	5400 rpm ±1%
Access time (average)	5.56 ms
Positioning time (seek, typical values) Minimum (track to track) Average (read access) Maximum (read access)	1.5 ms 12 ms 22 ms
Starting time (0 rpm to read access)	4 seconds (typically)
Supported transfer mode	SATA 1.0, PIO mode 0-4, multiword DMA mode 0-2, UDMA 0-5
Data transfer rate On the medium To/from host	Max. 84.6 Mbit/s Max. 150 MB/s
Cache	8 MB
S.M.A.R.T. Support	Yes
Lifespan	5 years
Electrical characteristics	
Power consumption	0.3 A at 3.3 V (PCI bus) 1 A at 5 V (PCI bus)
Mechanical characteristics	
Mounted on PCI insert	Fixed
Weight	350 g

Table 72: Technical data - RAID hard disk - 5ACPCI.RAIC-03

Technical data • Individual components

Environmental characteristics	5ACPCI.RAIC-03
Ambient temperature ¹⁾ Operation - Standard / 24-hour ²⁾ Storage Transport	-15 to +80°C -40 to +95°C -40 to +95°C
Relative humidity Operation Storage Transport	8 to 90% non-condensing (maximum humidity at +29°C) 5 to 95% non-condensing (maximum humidity at +40°C) 5 to 95% non-condensing (maximum humidity at +40°C)
Vibration ³⁾ Operation (continuous) Operation (occasional) Storage Transport	5 - 500 Hz: max. 0.125 g; duration 1 octave per minute; no unrecoverable errors 5 - 500 Hz: max. 0.25 g; duration 1 octave per minute; no unrecoverable errors 5 - 500 Hz: max. 5 g; duration 0.5 octaves per minute; no damage 5 - 500 Hz: max. 5 g; duration 0.5 octaves per minute; no damage
Shock (pulse with a sine half-wave) Operation Storage	Max. 125 g, 2 ms; no unrecoverable errors Max. 400 g, 2 ms; no damage Max. 450 g, 1 ms; no damage Max. 200 g, 0.5 ms; no damage
Altitude Operation Storage	- 300 to 3048 meters - 300 to 12192 meters

Table 72: Technical data - RAID hard disk - 5ACPCI.RAIC-03 (Forts.)

- 1) Temperature values for 305 meter altitude. The temperature specification must be reduced linearly by 1°C every 305 meters. The temperature increase and decrease can be a maximum of 3°C per minute.
- 2) 24-hour operation means 732 POH (power-on hours) per month.
- 3) Operation in areas prone to vibration and shock can affect performance negatively (reduction of transfer rate).

Temperature humidity diagram

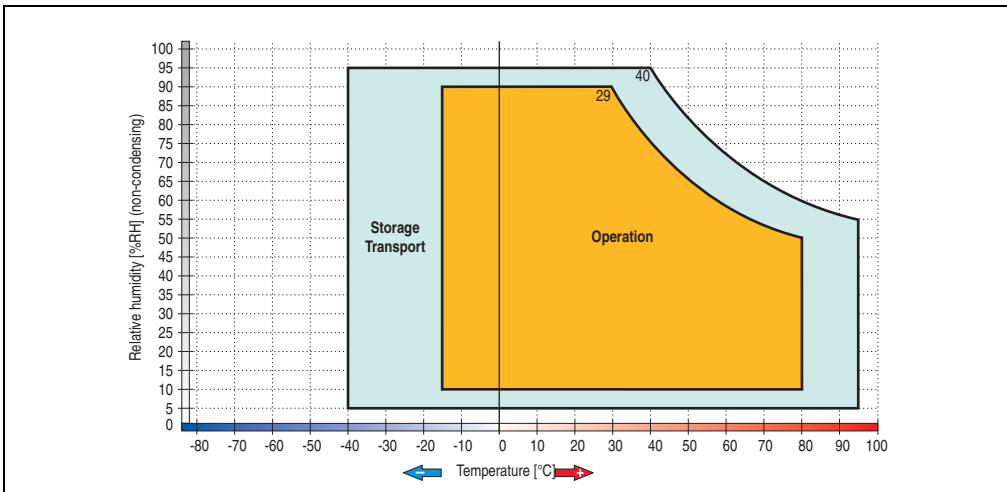

Figure 105: Temperature humidity diagram - SATA RAID hard disk 5ACPCI.RAIC-03

Temperature values for 305 meter altitude. The temperature specification must be reduced linearly by 1°C every 305 meters. The temperature increase and decrease can be a maximum of 3°C per minute.

Driver support

Special drivers are necessary for operating the PCI SATA RAID controller. Drivers for Windows XP Professional and Windows XP Embedded are available for download on the B&R Homepage in the download area (www.br-automation.com).

The .Net based SATA RAID Installation Utility is also on the B&R homepage. This software detects all error states (also during operation) and signals this to the user using pop-up messages.

Information:

Required drivers can only be downloaded from the B&R homepage, not from manufacturers' pages.

Behavior if an error occurs in a RAID1 configuration

If one of the two hard disks is physically damaged, when the system is booted the SATA RAID BIOS displays the following error message for approx. 5 seconds: "RAID1 set is in critical status". After this time the operating system is automatically started on the functioning hard disk.

The installed SATA RAID management software detects this error status. After repairing the cause of the error (e.g. replacing the hard disk - see section "Exchanging a PCI SATA Hard Disk", on page 246 or section "Rebuild Mirrored Set", on page 306) the SATA RAID management software automatically executes a rebuild (mirroring of the hard disk). This process takes approximately 50 minutes to complete, regardless of the amount of data and with the highest possible setting for "Rebuild rate".

Important notes / BIOS Extension ROM

For PCI cards with BIOS Extension ROM, there is a limited area of 64 KB available in the Phoenix BIOS. A B&R PCI SATA RAID controller requires a free area of approx. 32 KB. The remaining area can be used as desired.

Configuration of a PCI SATA RAID array

Instructions for configuration of a PCI SATA RAID array using RAID BIOS can be found in chapter 3 "Commissioning", section "Configuration of a SATA RAID array", on page 229.

3.6.2 Replacement SATA HDD 160 GB - 5ACPCI.RAIC-04

The hard disk can be used as a replacement part for 5ACPCI.RAIC-03.



Figure 106: Replacement SATA HDD 160 GB - 5ACPCI.RAIC-04

Technical data

Information:

The following characteristics, features, and limit values only apply to this individual component and can deviate from those specified for the entire device. For the entire device in which this individual component is used, refer to the data given specifically for the entire device.

Features	5ACPCI.RAIC-04
Hard disks Amount	Fujitsu M120-ESW MHY2160BH-ESW 1
Formatted capacity (512 bytes/sector)	160 GB
Number of heads	3
Number of sectors (user)	312,581,808
Bytes per sector	512
Revolution speed	5400 rpm \pm 1%
Access time (average)	5.56 ms
Positioning time (seek, typical values)	
Minimum (track to track)	1.5 ms
Average (read access)	12 ms
Maximum (read access)	22 ms
Starting time (0 rpm to read access)	4 seconds (typically)
Supported transfer mode	SATA 1.0, PIO mode 0-4, multiword DMA mode 0-2, UDMA 0-5
Data transfer rate	
On the medium	Max. 84.6 Mbit/s
To/from host	Max. 150 MB/s

Table 73: Technical data - RAID hard disk - 5ACPCI.RAIC-04

Technical data • Individual components

Features	5ACPCI.RAIC-04
Cache	8 MB
S.M.A.R.T. Support	Yes
Lifespan	5 years
Environmental characteristics	
Ambient temperature ¹⁾ Operation - Standard / 24-hour ²⁾ Storage Transport	-15 to +80°C -40 to +95°C -40 to +95°C
Relative humidity Operation Storage Transport	8 to 90% non-condensing (maximum humidity at +29°C) 5 to 95% non-condensing (maximum humidity at +40°C) 5 to 95% non-condensing (maximum humidity at +40°C)
Vibration ³⁾ Operation (continuous) Operation (occasional) Storage Transport	5 - 500 Hz: max. 0.125 g; duration 1 octave per minute; no unrecoverable errors 5 - 500 Hz: max. 0.25 g; duration 1 octave per minute; no unrecoverable errors 5 - 500 Hz: max. 5 g; duration 0.5 octaves per minute; no damage 5 - 500 Hz: max. 5 g; duration 0.5 octaves per minute; no damage
Shock (pulse with a sine half-wave) Operation Storage	Max. 125 g, 2 ms; no unrecoverable errors Max. 400 g, 2 ms; no damage Max. 450 g, 1 ms; no damage Max. 200 g, 0.5 ms; no damage
Altitude Operation Storage	- 300 to 3048 meters - 300 to 12192 meters

Table 73: Technical data - RAID hard disk - 5ACPCI.RAIC-04 (Forts.)

- 1) Temperature values for 305 meter altitude. The temperature specification must be reduced linearly by 1°C every 305 meters. The temperature increase and decrease can be a maximum of 3°C per minute.
- 2) 24-hour operation means 732 POH (power-on hours) per month.
- 3) Operation in areas prone to vibration and shock can affect performance negatively (reduction of transfer rate).

Temperature humidity diagram

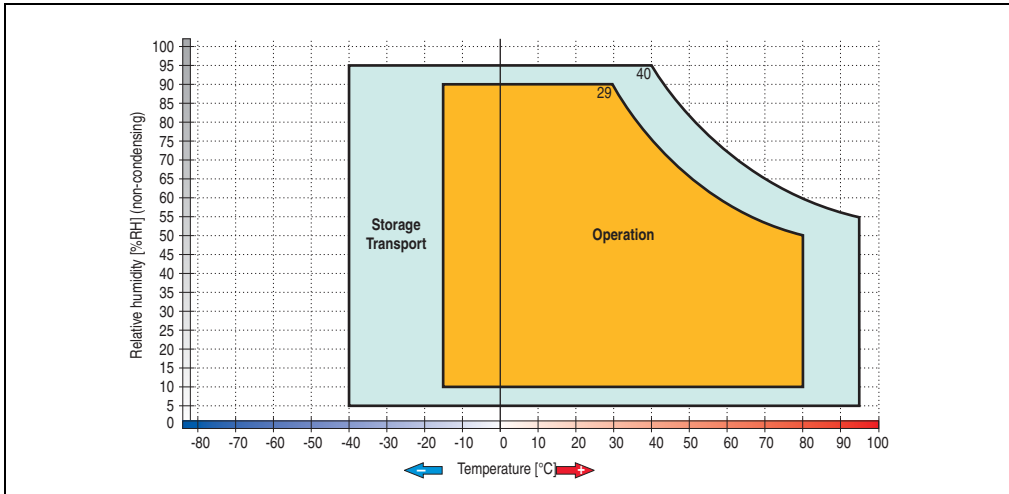

Figure 107: Temperature humidity diagram - SATA RAID hard disk 5ACPCI.RAIC-04

Exchanging a PCI SATA RAID hard disk

Instructions for exchanging a SATA hard disk can be found in chapter 7 "Maintenance / Servicing", section "Exchanging a PCI SATA RAID hard disk", on page 468.

3.6.3 PCI SATA RAID 2 x 250 GB - 5ACPCI.RAIC-05

The hard disks that are used are specified for 24-hour operation (24x7).

Features

- SATA RAID controller
- RAID Level 0 (striped) and 1 (mirrored)
- 2 SATA hard disk drives (suitable for 24 hour operation)
- Only requires 1 PCI slot
- Transfer rates up to 150 MB/s

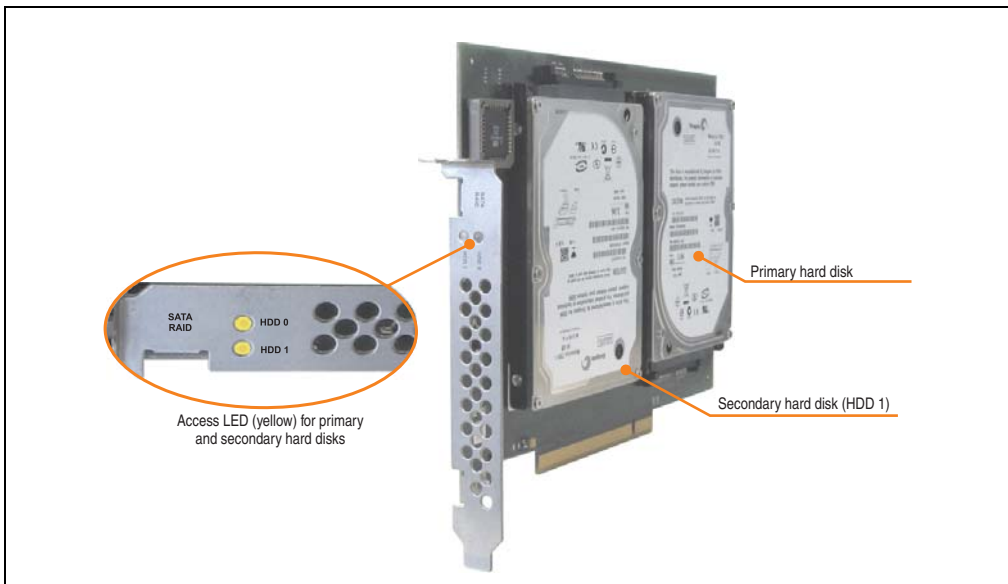

Figure 108: PCI SATA RAID controller - 5ACPCI.RAIC-05

Information:

The PCI SATA RAID controller can not be used in place of a Universal Power Supply (UPS). If the operating system is shut down improperly, the next time it is started it is detected as an error by the RAID 1, and a complete rebuild is executed. This generally takes at least 120 minutes (configurable) to complete.

Technical data

Information:

The following characteristics, features, and limit values only apply to this individual component and can deviate from those specified for the entire device. For the entire device in which this individual component is used, refer to the data given specifically for the entire device.

Features	5ACPCI.RAIC-05
SATA RAID controller Type Specifications Data transfer rate RAID level BIOS Extension ROM - requirements	Sil 3512 SATA link Serial ATA 1.0 Max. 1.5 GB/s (150 MB/s) Supports RAID 0, 1 Approx. 32 KB
Hard disks Amount	Seagate ST9250315AS 2
Formatted capacity (512 bytes/sector)	250 GB
Number of heads	1
Number of sectors (user)	488,397,168
Bytes per sector	512
Revolution speed	5400 rpm ±0.2%
Access time (average)	5.56 ms
Positioning time (seek, typical values) Minimum (track to track) Average (read access) Maximum (read access)	1 ms 14 ms 30 ms
Starting time (0 rpm to read access)	3.6 seconds (typically)
Supported transfer modes	SATA 1.0, Serial ATA Revision 2.6 PIO mode 0-4, multiword DMA mode 0-2, UDMA mode 0-6
Data transfer rate On the medium To/from host	Max. 1175 Mbits/s Max. 150 MB/s
Cache	8 MB
S.M.A.R.T. Support	Yes
Electrical characteristics	
Power consumption	0.3 A at 3.3 V (PCI bus) 1 A at 5 V (PCI bus)
Mechanical characteristics	
Mounted on PCI insert	Fixed
Weight	350 g

Table 74: Technical data - RAID Hard Disk - 5ACPCI.RAIC-05

Technical data • Individual components

Environmental characteristics	5ACPCI.RAIC-05
Ambient temperature ¹⁾ Operation - Standard / 24-hour ²⁾ Storage Transport	0 to 60°C -40 to 70°C -40 to 70°C
Relative humidity ³⁾ Operation Storage Transport	5 to 95%, non-condensing 5 to 95%, non-condensing 5 to 95%, non-condensing
Vibration ⁴⁾ Operation (continuous) Operation (occasional) Storage Transport	5 - 500 Hz: max. 0.125 g; duration 1 octave per minute; no unrecoverable errors 5 - 500 Hz: max. 0.25 g; duration 1 octave per minute; no unrecoverable errors 5 - 500 Hz: max. 5 g; duration 0.5 octaves per minute; no damage 5 - 500 Hz: max. 5 g; duration 0.5 octaves per minute; no damage
Shock ⁴⁾ (pulse with a sine half-wave) Operation Storage	Max. 125 g, 2 ms; no unrecoverable errors Max. 400 g, 2 ms; no damage Max. 500 g, 1 ms; no damage Max. 300 g, 0.5 ms; no damage
Altitude Operation Storage	- 300 to 3048 m - 300 to 12192 m

Table 74: Technical data - RAID Hard Disk - 5ACPCI.RAIC-05 (Forts.)

- 1) Temperature values for 305 meter altitude. The temperature specification must be reduced linearly by 1°C every 305 meters. The temperature increase and decrease can be a maximum of 20°C per hour.
- 2) 24-hour operation means 732 POH (power-on hours) per month.
- 3) Humidity gradient: Maximum 30% per hour.
- 4) Operation in areas prone to vibration and shock can affect performance negatively (reduction of transfer rate).

Temperature humidity diagram

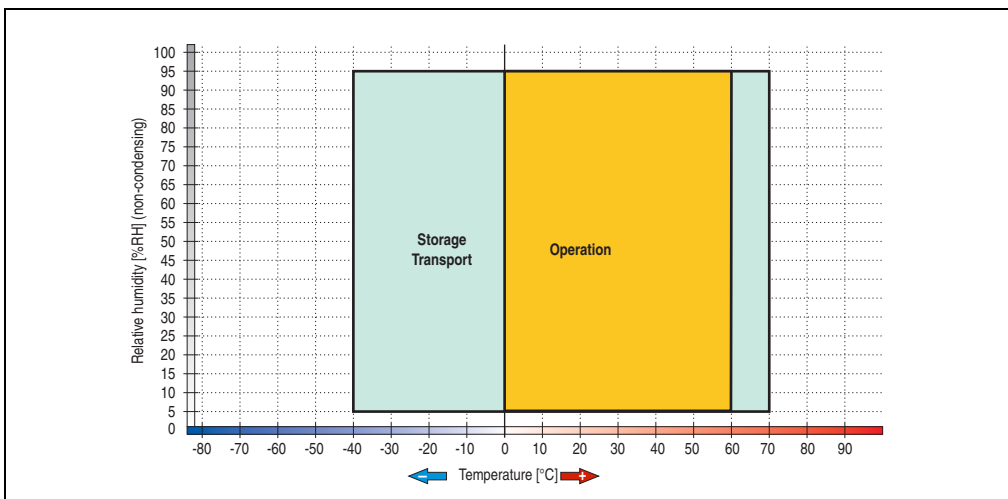

Figure 109: Temperature humidity diagram - SATA RAID Hard Disk - 5ACPCI.RAIC-05

Temperature values for 305 meter altitude. The temperature specification must be reduced linearly by 1°C every 305 meters. The temperature increase and decrease can be a maximum of 20°C per hour.

Driver support

Special drivers are necessary for operating the PCI SATA RAID controller. Drivers for Windows XP Professional and Windows XP Embedded are available for download on the B&R Homepage in the download area (www.br-automation.com).

The .NET-based SATARaid™ serial ATA RAID management software can also be found on the B&R homepage.

Information:

Required drivers can only be downloaded from the B&R homepage, not from manufacturers' pages.

Configuration

For configuration of a SATA RAID network, see Chapter 3 "Commissioning", section "Configuration of a SATA RAID array", on page 229.

Exchanging a HDD

A hard drive can be easily exchanged in the event of an error when using the RAID1 (mirroring) configuration without having to re-install the system. The replacement SATA HDD 250GB 5MMHDD.0250-00 is available as a replacement part for a HDD.

For instructions on exchanging the drive, see Chapter 7 "Maintenance / Servicing", section "Slide-in drive - installation and exchange", on page 462.

3.6.4 Replacement SATA HDD 250 GB - 5MMHDD.0250-00

The hard disk can be used as a replacement part for 5ACPCI.RAIC-05.



Figure 110: Replacement SATA HDD 250 GB - 5MMHDD.0250-00

Technical data

Information:

The following characteristics, features, and limit values only apply to this individual component and can deviate from those specified for the entire device. For the entire device in which this individual component is used, refer to the data given specifically for the entire device.

Features	5MMHDD.0250-00
Hard disks Amount	Seagate ST9250315AS 1
Formatted capacity (512 bytes/sector)	250 GB
Number of heads	1
Number of sectors (user)	488,397,168
Bytes per sector	512
Revolution speed	5400 rpm \pm 0.2%
Access time (average)	5.56 ms
Positioning time (seek, typical values) Minimum (track to track) Average (read access) Maximum (read access)	1 ms 14 ms 30 ms
Starting time (0 rpm to read access)	3.6 seconds (typically)
Supported transfer modes	SATA 1.0, Serial ATA Revision 2.6 PIO mode 0-4, multiword DMA mode 0-2, UDMA mode 0-6
Interface	SATA

Table 75: Technical data - RAID hard disk - 5MMHDD.0250-00

Features	5MMHDD.0250-00
Data transfer rate On the medium To/from host	Max. 1175 Mbits/s Max. 150 MB/s (SATA I), max. 300 MB/s (SATA II)
Cache	8 MB
S.M.A.R.T. Support	Yes
MTBF	550,000 Power On Hours ¹⁾
Environmental characteristics	
Ambient temperature ²⁾ Operation - Standard / 24-hour ³⁾ Storage Transport	0 to 60°C -40 to 70°C -40 to 70°C
Relative humidity ⁴⁾ Operation Storage Transport	5 to 95%, non-condensing 5 to 95%, non-condensing 5 to 95%, non-condensing
Vibration Operation Storage	0.5 g at 5 - 500 Hz, no non-recovered errors 5 g at 5 - 500 Hz, no non-recovered errors
Shock (pulse with a sine half-wave) Operation Storage	350 g and 2 ms duration, no non-recovered errors 800 g and 2 ms duration, no non-recovered errors 1000 g and 1 ms duration, no non-recovered errors 600 g and 0.5 ms duration, no non-recovered errors
Altitude Operation Storage	- 300 to 3048 m - 300 to 12192 m

Table 75: Technical data - RAID hard disk - 5MMHDD.0250-00 (Forts.)

- 1) With 8760 POH (Power On Hours) per year and 25°C surface temperature.
- 2) Temperature values for 305 meter altitude. The temperature specification must be reduced linearly by 1°C every 305 meters. The temperature increase and decrease can be a maximum of 20°C per hour.
- 3) 24-hour operation means 732 POH (power-on hours) per month.
- 4) Humidity gradient: Maximum 30% per hour.

Temperature humidity diagram

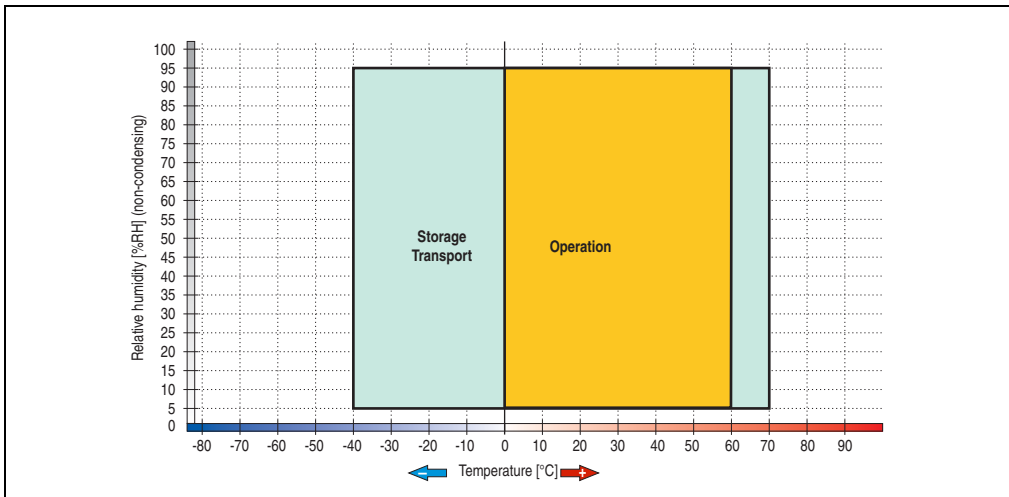

Figure 111: Temperature humidity diagram - SATA RAID hard disk - 5MMHDD.0250-00

Temperature values for 305 meter altitude. The temperature specification must be reduced linearly by 1°C every 305 meters. The temperature increase and decrease can be a maximum of 20°C per hour.

3.7 Interface options

An add-on interface (CAN or combined RS232/422/485) can be inserted.

Information:
It is possible to add or remove an add-on interface at any time.

Caution!
Turn off power before adding or removing an add-on interface.

3.7.1 Add-on CAN interface - 5AC600.CANI-00

The add-on CAN interface is equipped with a Bosch CC770 CAN controller (compatible with an Intel 82527 CAN controller), which conforms to CAN specifications 2.0 part A/B. The CAN controller can trigger an NMI (non-maskable interrupt).

Order data

Model number	Description	Image
5AC600.CANI-00	Add-on CAN interface CAN interface for installation in an APC620 or PPC700.	

Table 76: Add-on CAN interface - 5AC600.CANI-00

Technical data

Features	5AC600.CANI-00
CAN interface Controller Amount Connection	Bosch CC770 (compatible with Intel 82527 CAN controller) 1 9-pin DSUB, male
Terminating resistor Default setting	Can be activated and deactivated using a sliding switch Disabled

Table 77: Technical data - Add-on CAN interface - 5AC600.CANI-00

Pin assignments

Add-on CAN	
Type	Electrically isolated
Transfer rate	Max. 500 kbit/s
Bus length	Max. 1000 Meter
Pin	Assignment
1	n.c.
2	CAN low
3	GND
4	n.c.
5	n.c.
6	Reserved
7	CAN high
8	n.c.
9	n.c.

9-pin DSUB connector



Table 78: Pin assignments - CAN

I/O address and IRQ

Resource	Default setting	Additional setting options
I/O address	384h / 385h	-
IRQ	IRQ10	NMI ¹⁾

Table 79: Add-on CAN - I/O Adresse und IRQ

1) NMI = Non Maskable Interrupt.

The setting for the IRQ can be changed in the BIOS setup (under "Advanced" - submenu "Baseboard/Panel Features" - submenu "Legacy Devices", setting "CAN"). Please note any potential conflicts with other resources when changing this setting.

I/O address	Register	Function
384h	Address register	Defines the register number to access.
385h	Data register	Access to the register defined in the address register.

Table 80: CAN address register

Bus length and cable type

The type of cable used depends largely on the required bus length and the number of nodes. The bus length is mainly determined by the bit rate. In accordance with CiA (CAN in Automation) the maximum bus length is 1000 meters.

The following bus lengths are permitted with a maximum oscillator tolerance of 0.121%:

Distance [m]	Transfer rate [kbit/s]
≤ 1000	Typ. 50
≤ 200	Typ. 250
≤ 60	Typ. 500

Table 81: Bus length and transfer rate - CAN

The material used for the cable should preferably have all or most of the following properties in order to reach an optimal transfer rate.

CAN cable	Property
Signal lines Cable cross section Wire insulation Conductor resistance Stranding Shielding	2 x 0.25 mm ² (24AWG/19), tinned Cu wire PE ≤ 82 Ω / km Wires stranded in pairs Paired shield with aluminum foil
Grounding line Cable cross section Wire insulation Conductor resistance	1 x 0.34 mm ² (22AWG/19), tinned Cu wire PE ≤ 59 Ω / km
Outer sheathing Material Characteristics Total shielding	PUR mixture Halogen free From tinned cu wires

Table 82: CAN cable requirements

Terminating resistor

CAN networks are cabled using a bus structure where both ends of the bus are equipped with terminating resistors. The add-on CAN interface has an integrated terminating resistor (delivery state: disabled with the setting "Off").

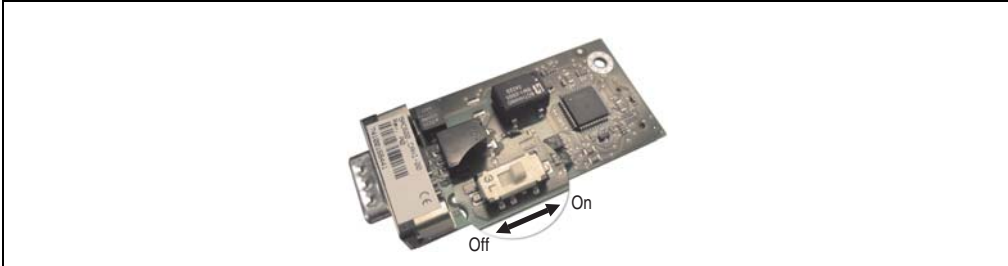

Figure 112: Terminating resistor - Add-on CAN interface 5AC600.CANI-00

Contents of the delivery / mounting material

The screws included in the mounting kit are to be used for installation.



Figure 113: Contents of the delivery / mounting material - 5AC600.CANI-00

3.7.2 Add-on RS232/422/485 interface - 5AC600.485I-00

The serial interface is a combined RS232/RS422/RS485 interface. The operating mode (RS232/RS422/RS485) is selected automatically, depending on the electrical connection.

Order data

Model number	Description	Image
5AC600.485I-00	Add-on RS232/422/485 interface Add-on RS232/422/485 interface for installation in an APC620 and PPC700.	

Table 83: Add-on RS232/422/485 interface - 5AC600.485I-00

Pin assignments

Add-on RS232/422/485		
	RS232	RS422/485
Type	RS232 not modem compatible; Electrically isolated	
UART	16550 compatible, 16 byte FIFO	
Transfer rate	Max. 115 kbit/s	
Bus length	Max. 15 meters	Max. 1200 meters
Pin	Assignments (RS232)	Assignments (RS422)
1	n.c.	TXD\
2	RXD	n.c.
3	TXD	n.c.
4	n.c.	TXD
5	GND	GND
6	n.c.	RXD\
7	RTS	n.c.
8	CTS	n.c.
9	n.c.	RXD

9-pin DSUB connector



Table 84: Pin assignments - RS232/RS422

I/O address and IRQ

Resource	Default setting	Additional setting options
I/O address	2E8	238, 2F8, 338, 3E8, 3F8
IRQ	IRQ10	IRQ 3, 4, 5, 7, 11, 12

Table 85: Add-on RS232/422/485 - I/O address and IRQ

The setting for the I/O address and the IRQ can be changed in the BIOS setup (under "Advanced" - submenu "Main board/Panel Features" - submenu "Legacy Devices", setting "COM E"). Please note any potential conflicts with other resources when changing this setting.

Bus length and cable type RS232

The maximum transfer rate of 115 kbit/s depends on the cable type being used.

Distance [m]	Transfer rate [kbit/s]
≤ 15	Typ. 64
≤ 10	Typ. 115
≤ 5	Typ. 115

Table 86: RS232 - Bus length and transfer rate

The material used for the cable should preferably have all or most of the following properties in order to reach an optimal transfer rate.

RS232 cable	Property
Signal lines Cable cross section Wire insulation Conductor resistance Stranding Shielding	4 x 0.16 mm ² (26AWG), tinned Cu wire PE ≤ 82 Ω / km Wires stranded in pairs Paired shield with aluminum foil
Grounding line Cable cross section Wire insulation Conductor resistance	1 x 0.34 mm ² (22AWG/19), tinned Cu wire PE ≤ 59 Ω / km
Outer sheathing Material Characteristics Total shielding	PUR mixture Halogen free From tinned cu wires

Table 87: RS232 - Cable requirements

RS422 - Bus length and cable type

The RTS line must be switched on to activate the sender.

The maximum transfer rate of 115 kbit/s depends on the cable type being used.

Distance [m]	Transfer rate [kbit/s]
1200	Typ. 115

Table 88: RS422 - Bus length and transfer rate

The material used for the cable should preferably have all or most of the following properties in order to reach an optimal transfer rate.

RS422 cable	Property
Signal lines Cable cross section Wire insulation Conductor resistance Stranding Shielding	4 x 0.25 mm ² (24AWG/19), tinned Cu wire PE ≤ 82 Ω / km Wires stranded in pairs Paired shield with aluminum foil
Grounding line Cable cross section Wire insulation Conductor resistance	1 x 0.34 mm ² (22AWG/19), tinned Cu wire PE ≤ 59 Ω / km
Outer sheathing Material Characteristics Total shielding	PUR mixture Halogen free From tinned cu wires

Table 89: RS422 - Cable requirements

RS485 interface operation

The pins of the RS422 default interface (1, 4, 6 and 9) should be used for operation. The pins should be connected as shown.

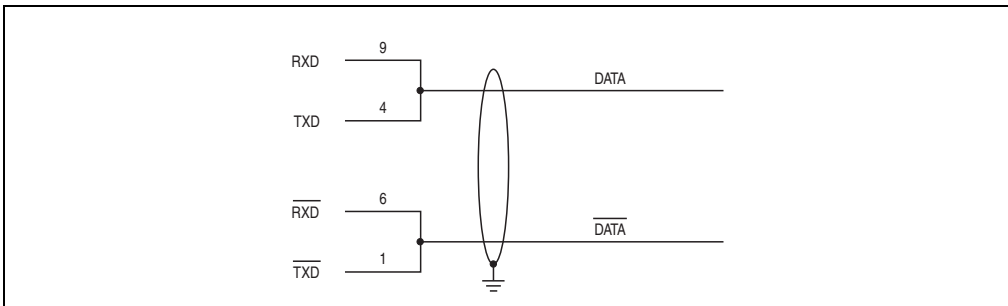

Figure 114: Add-on RS232/422/485 interface - operated in RS485 mode

The RTS line must be switched each time the driver is sent and received, and there is also no automatic switch back. This cannot be configured in Windows.

Technical data • Individual components

The voltage drop caused by long line lengths can lead to greater potential differences between the bus stations, which can hinder communication. This can be improved by running ground wire with the others.

The line ends of the RS485 interface should (at least for longer line lengths or larger transfer rates) be closed. Normally a passive terminator can be used on the bus ends by connecting each of the signal lines with 120 Ω resistance.

RS485 - Bus length and cable type

The maximum transfer rate of 115 kbit/s depends on the cable type being used.

Distance [m]	Transfer rate [kbit/s]
1200	Typ. 115

Table 90: RS485 - Bus length and transfer rate

The material used for the cable should preferably have all or most of the following properties in order to reach an optimal transfer rate.

RS485 cable	Property
Signal lines Cable cross section Wire insulation Conductor resistance Stranding Shielding	4 x 0.25 mm ² (24AWG/19), tinned Cu wire PE $\leq 82 \Omega / \text{km}$ Wires stranded in pairs Paired shield with aluminum foil
Grounding line Cable cross section Wire insulation Conductor resistance	1 x 0.34 mm ² (22AWG/19), tinned Cu wire PE $\leq 59 \Omega / \text{km}$
Outer sheathing Material Characteristics Total shielding	PUR mixture Halogen free From tinned cu wires

Table 91: RS485 - Cable requirements

Contents of the delivery / mounting material

The screws included in the mounting kit are to be used for installation.



Figure 115: Contents of the delivery / mounting material 5AC600.485I-00

3.8 Fan kits

Information:

Fans are necessary when using components which must work within certain temperature limits, e.g. hard disks, DVD combos, PCI cards, etc.

The fan kits are subject to wear and must be checked with appropriate frequency and cleaned or replaced when not functioning properly (e.g. due to dirt and grime).

3.8.1 Fan kit 5PC700.FA00-01

This fan kit can be used as an option for 10.4", 12.1", 15", 17" and 19" Panel PC 700 system units with 0 PCI slots (5PC720.1043-00, 5PC720.1214-00, 5PC720.1505-00, 5PC720.1706-00, 5PC720.1906-00, 5PC781.1043-00, 5PC781.1505-00 and 5PC782.1043-00).

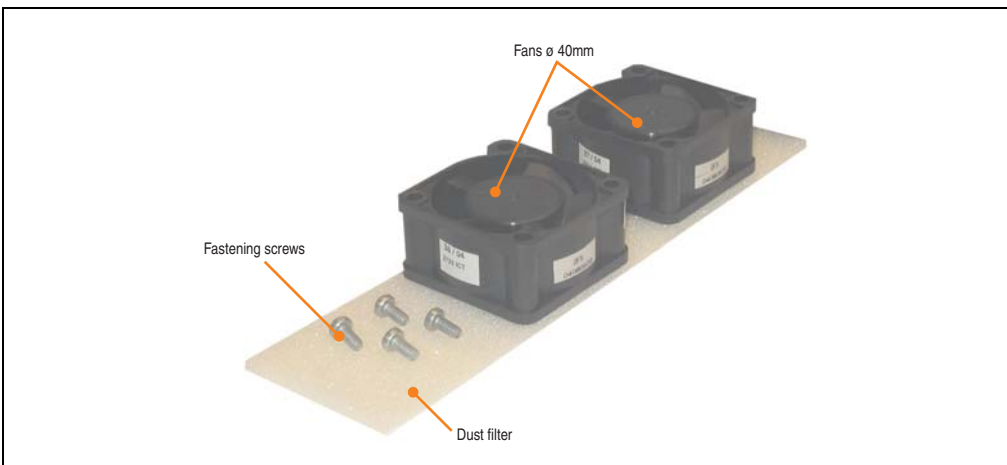

Figure 116: Fan kit 5PC700.FA00-01

Technical data

Features	5PC700.FA00-01
Fan type	Double ball bearings
Width	40 mm
Length	40 mm
Height	20 mm
Revolution speed	5600 rpm \pm 10%
Noise level	24 dB
Service life	80000 hours at 30°C

Table 92: Technical data - 5PC700.FA00-01

Features	5PC700.FA00-01
Maintenance interval	Depending on the work environment, the dust filter should be checked with appropriate frequency to determine whether the air flow provides sufficient cooling. An exchange or cleaning of the filter kit is appropriate at that time.
Installation	See "Procedure - PPC700 without PCI slots", on page 456

Table 92: Technical data - 5PC700.FA00-01 (Forts.)

Contents of delivery

- 2 fans with 40 mm diameter
- 1 dust filter
- Installation material - Mounting screws

Installation

For a description of how to install the fan kit, see chapter 7 "Maintenance / Servicing", section 2 "Fan kit installation and replacement", starting on page 456.

3.8.2 Fan kit 5PC700.FA02-00

This fan kit can be used as an option for 10.4" Panel PC 700 system units with 2 PCI slots (5PC720.1043-01).

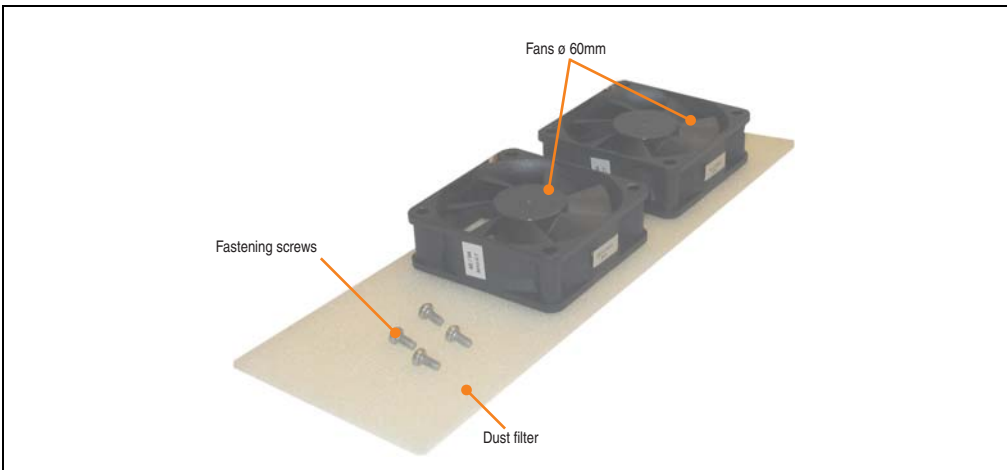

Figure 117: Fan kit 5PC700.FA02-00

Technical data

Features	5PC700.FA02-00
Fan type	Double ball bearings
Width	60 mm
Length	60 mm
Height	10 mm
Revolution speed	3600 rpm \pm 10%
Noise level	30.5 dB
Service life	80000 hours at 30°C
Maintenance interval	Depending on the work environment, the dust filter should be checked with appropriate frequency to determine whether the air flow provides sufficient cooling. An exchange or cleaning of the filter kit is appropriate at that time.
Installation	See "Procedure - PPC700 with 1 and 2 PCI slots", on page 459

Table 93: Technical data - 5PC700.FA02-00

Contents of delivery

- 2 fans with 60 mm diameter
- 1 dust filter
- Installation material - Mounting screws

Installation

For a description of how to install the fan kit, see chapter 7 "Maintenance / Servicing", section 2 "Fan kit installation and replacement", starting on page 459.

3.8.3 Fan kit 5PC700.FA02-01

This fan kit can be used as an option for 12.1" and 15" Panel PC 700 system units with 1 and 2 PCI slots (5PC720.1214-01, 5PC720.1505-01 and 5PC720.1505-02).

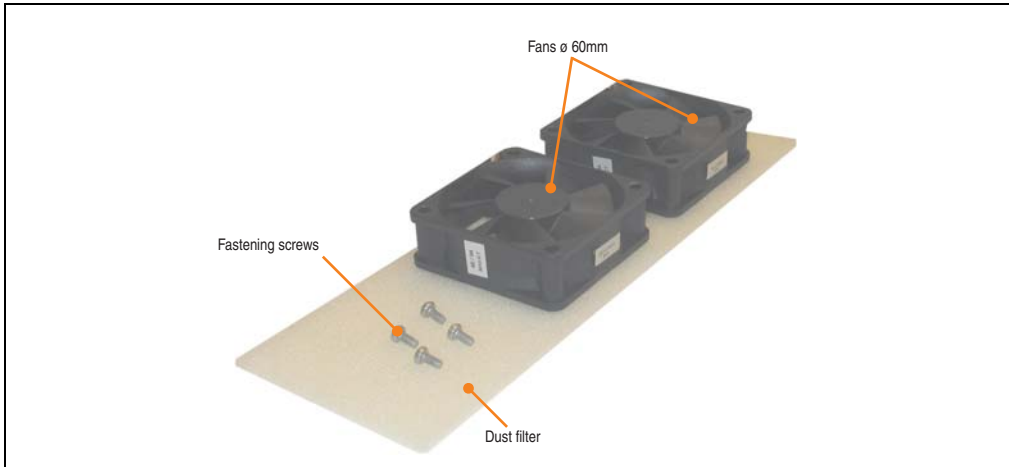

Figure 118: Fan kit 5PC700.FA02-01

Technical data

Features	5PC700.FA02-01
Fan type	Double ball bearings
Width	60 mm
Length	60 mm
Height	20 mm
Revolution speed	3600 rpm \pm 10%
Noise level	30.5 dB
Service life	80000 hours at 30°C
Maintenance interval	Depending on the work environment, the dust filter should be checked with appropriate frequency to determine whether the air flow provides sufficient cooling. An exchange or cleaning of the filter kit is appropriate at that time.
Installation	See "Procedure - PPC700 with 1 and 2 PCI slots", on page 459

Table 94: Technical data - 5PC700.FA02-01

Contents of delivery

- 2 fans with 60 mm diameter
- 1 dust filter
- Installation material - Mounting screws

Installation

For a description of how to install the fan kit, see chapter 7 "Maintenance / Servicing", section 2 "Fan kit installation and replacement", starting on page 459.

Chapter 3 • Commissioning

1. Installation

Panel PC 700 devices are best mounted in a housing cutout using the clamps found on the housing (different designs possible). The cutout dimensions for the respective Panel PC 700 device can be found in the technical data for the system units (see chapter 2 "Technical data" starting on page 37).

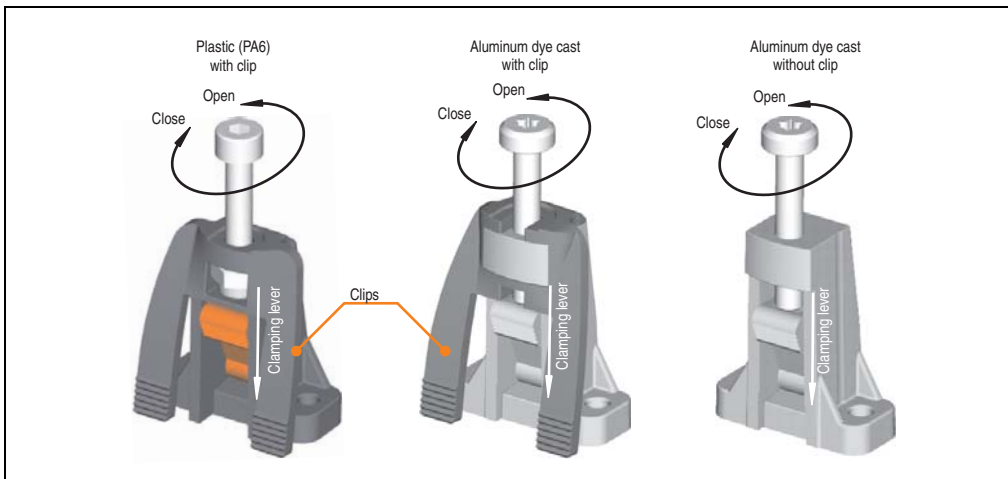

Figure 119: Terminal block

The mounting clamps are designed for a max. thickness of 10 mm for the material where the device is being clamped. The minimum thickness is 2 mm.

In order to tighten or loosen the screws, a hex key (size 3) is required for the plastic clamps and a Torx screwdriver (size 20) or a large flat-head screwdriver for the aluminum die casting.

The maximum torque when tightening the clamp is 0.5 Nm. A Panel PC 700 unit must be mounted to a flat surface. Uneven areas can cause damage to the display when the screws are tightened.

1.1 Important mounting information

- The environmental conditions must be taken into consideration (see chapter 2 "Technical data", section "Ambient temperature with X945 CPU board", on page 42).
- The PPC700 must be mounted to a planar surface.
- The PPC700 is only for operation in closed rooms.
- The PPC700 cannot be situated in direct sunlight.
- The ventilation holes cannot be covered.
- When mounting the device, be sure to adhere to the allowable mounting orientations (see Section "Mounting orientation", on page 222).
- Be sure the wall or control cabinet can withstand four times the total weight of the the PPC700.
- When connecting certain cable types (DVI, SDL, USB, etc.), keep the flex radius in mind.

1.2 Air circulation

In order to guarantee proper air circulation, allow the specified amount of space above, below, to the side and behind the Panel PC 700. The minimum specified free space can be found in the diagram below.

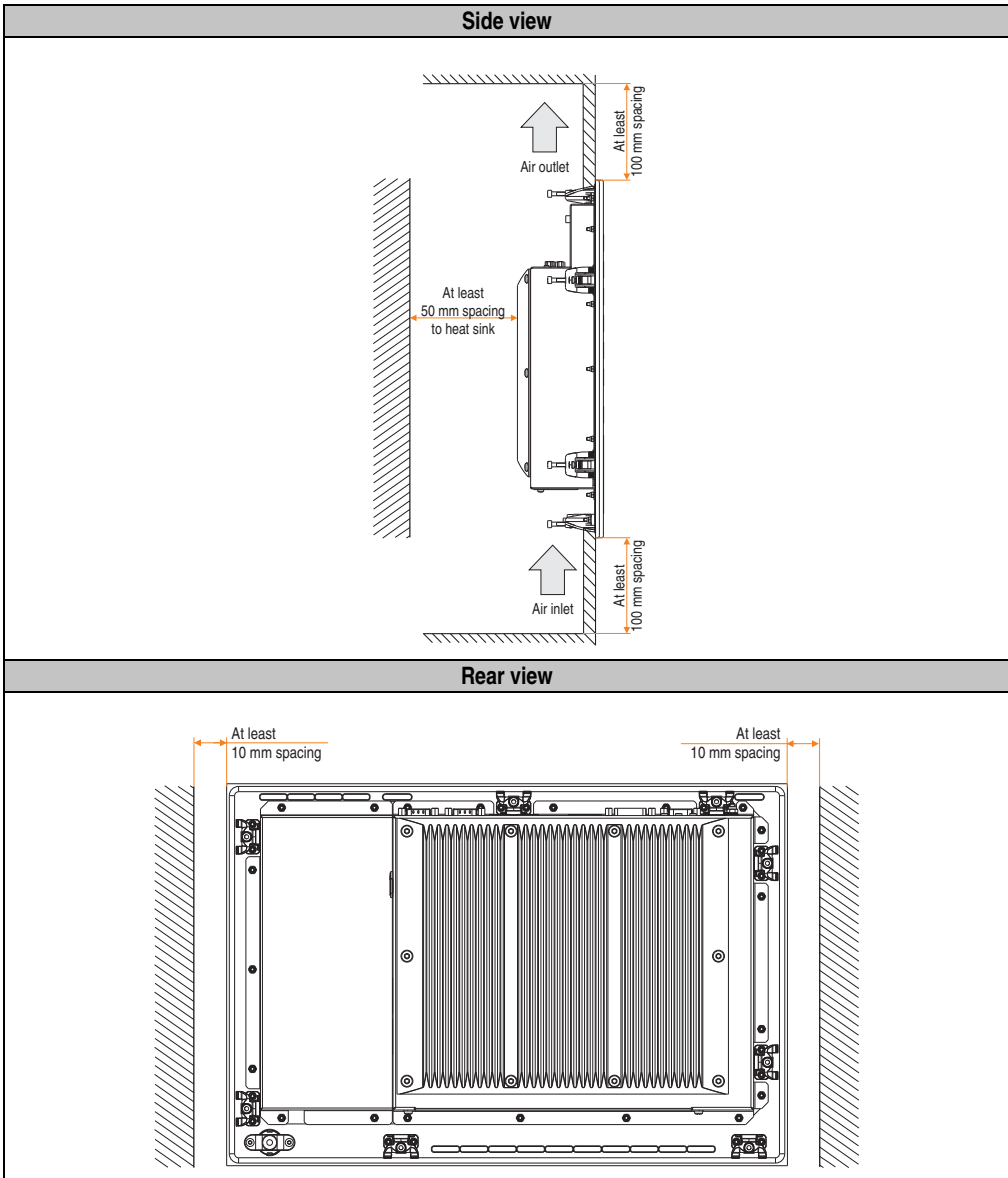

Figure 120: Spaces for air circulation

1.3 Mounting orientation

The following diagram displays the specified mounting orientation for the Panel PC 700 device.

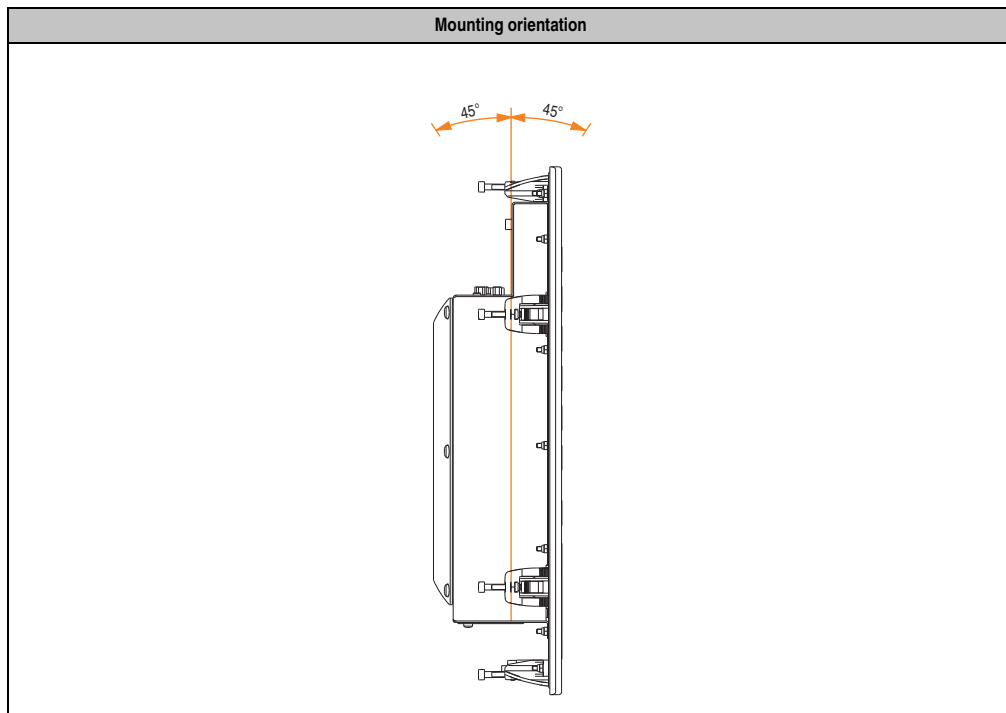

Table 95: Mounting orientation

2. Cable connections

When making cable connections and installing cables, it is not permitted to have a flex radius smaller than the minimum value specified.

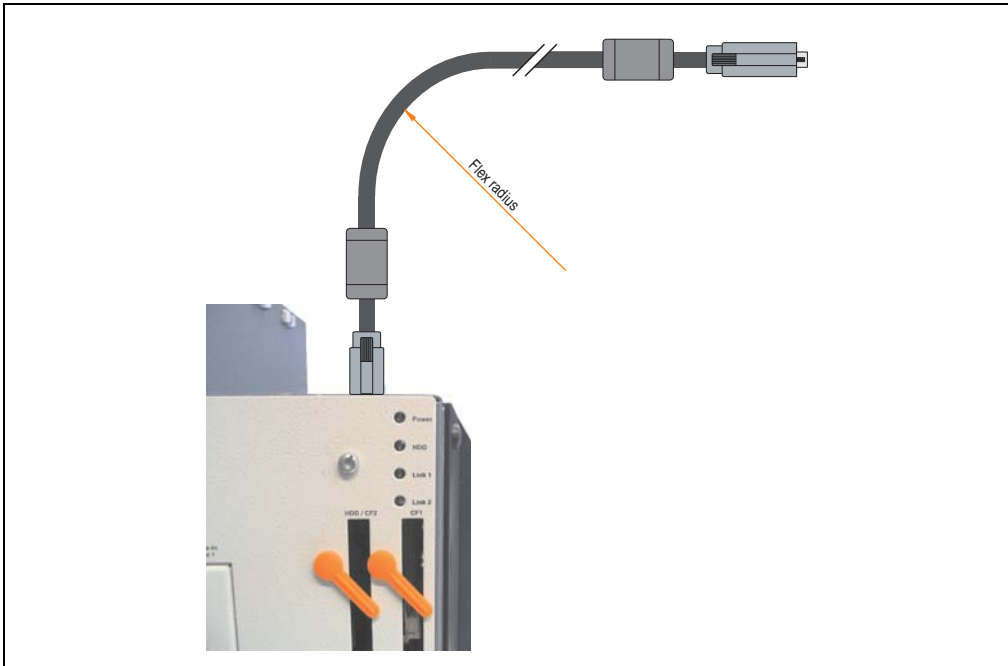

Figure 121: Flex radius - Cable connection

Information:

The value specified for the minimum flex radius can be found in the technical data for the cable that is being used.

2.1 Ethernet cable lengths for ETH1

More information can be found in section "Ethernet connection ETH1", on page 74.

3. Grounding concept

Functional ground is a current path of low impedance between electrical circuits and ground. It is used, for example, to improve immunity to disturbances and not necessarily as a protective measure. It therefore serves only to deflect disturbances, not to provide any kind of protection against electric shock.

This device comes equipped with two functional ground connections:

- Supply voltage
- Ground connection

To guarantee safe conductance of electric disturbances, the following points must be observed:

- The device must be connected to the central grounding point in the control cabinet using the shortest route possible.
- A cable with a minimum cross section of 2.5 mm^2 per connection should be used. If a cable with wire end sleeves is connected to the OTB103.9 or OTB103.91 terminal block, then a cable with maximum 1.5 mm^2 per connection is possible.
- Note the line shielding concept. All data cables connected to the device must be shielded.

Symbol indicating functional ground on the B&R device: 

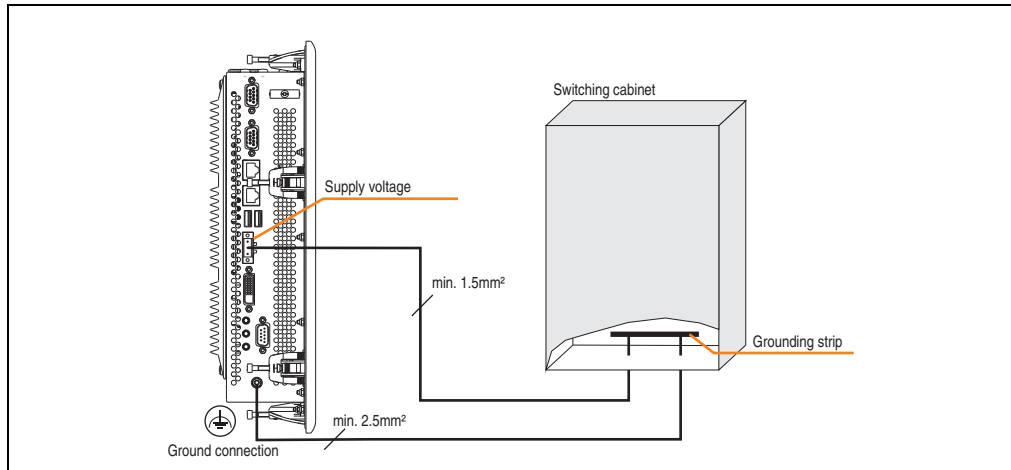

Figure 122: Grounding concept

4. Touch screen calibration

B&R touch screen devices are equipped with a touch controller that supports hardware calibration. This means that the devices are pre-calibrated from stock. This feature proves advantageous in the case of a replacement part because a new calibration is no longer required when exchanging devices (identical model / type). Nevertheless, we recommend calibrating the device in order to achieve the best results and to better readjust the touch screen to the user's preferences.

Regardless of this, the touch screen driver requires calibration following installation.

4.1 Windows XP Professional

After installing Windows XP Professional, the touch screen driver must be installed in the device in order to operate the touch screen. The corresponding drivers can be downloaded from the download area on the B&R homepage (www.br-automation.com). The touch screen should be calibrated during driver installation.

4.2 Windows CE

Windows CE starts the touch screen calibration sequence during its first boot in the default configuration / delivered state.

4.3 Windows XP embedded

After first starting Windows XP embedded (First Boot Agent), the touch screen driver must be installed in the device in order to operate the touch screen. The corresponding drivers can be downloaded from the download area on the B&R homepage (www.br-automation.com). The touch screen should be calibrated during driver installation.

4.4 Automation Runtime / Visual Components

The first time the touch screen is used, it must be calibrated once in the customer application for the existing device and project.

5. Connection examples

The following example provides an overview of the configuration possibilities regarding the way an analog RGB device can be connected with the PPC700. The following questions will be answered:

- Automation Panel 900 or Automation Panel 800 devices cannot be connected to the monitor/panel output on the PPC700.
- Do BIOS settings have to be changed for a specific configuration?

5.1 An analog CRT device on the monitor/panel connector

An analog RGB device is connected to the integrated SDL interface (onboard) using the monitor/panel connector.

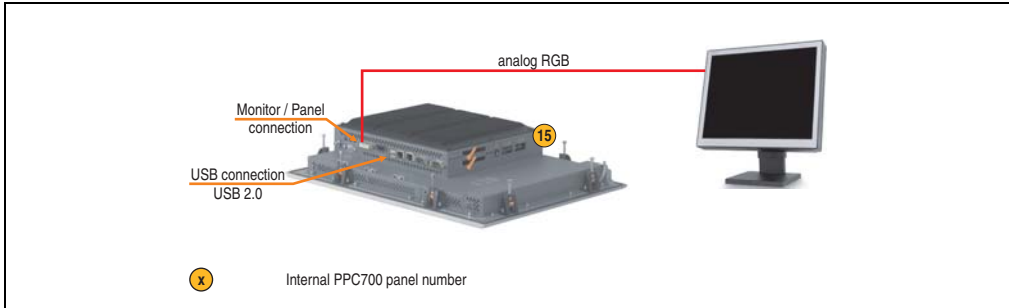

Figure 123: Configuration - An analog CRT device on the monitor/panel connector

5.1.1 Basic system requirements

The following table displays the possible combinations for the PPC700 system unit with CPU board to implement the configuration shown in the figure above. If the maximum resolution is limited when making the combination then it is also shown in this table.

System unit	CPU board	Restriction
	5PC600.X945-00	Resolution
5PC720.1043-00	✓	Max. UXGA
5PC720.1043-01	✓	Max. UXGA
5PC720.1214-00	✓	Max. UXGA
5PC720.1214-01	✓	Max. UXGA
5PC720.1505-00	✓	Max. UXGA
5PC720.1505-01	✓	Max. UXGA
5PC720.1505-02	✓	Max. UXGA
5PC720.1706-00	✓	Max. UXGA
5PC720.1906-00	✓	Max. UXGA
5PC781.1043-00	✓	Max. UXGA
5PC781.1505-00	✓	Max. UXGA
5PC782.1043-00	✓	Max. UXGA

Table 96: Possible combinations of system unit and CPU board

5.1.2 BIOS settings

No special BIOS settings are necessary for operation.

6. Connection of USB peripheral devices

Warning!

Peripheral USB devices can be connected to the USB ports. Due to the vast number of USB devices available on the market, B&R cannot guarantee their performance. B&R does ensure the performance of all USB devices that they provide.

6.1 Locally on the PPC700

Many different peripheral USB devices can be connected to the 2 or 3 USB ports on the Panel PC 700. These can each handle a load of 1A. The maximum transfer rate is USB 2.0.



Figure 124: Local connection of USB peripheral devices on the PPC 700

7. Configuration of a SATA RAID array

You must enter the BIOS "RAID Configuration Utility" in order to make the necessary settings. After the POST, enter <Ctrl+S> or <F4> to open RAID BIOS.

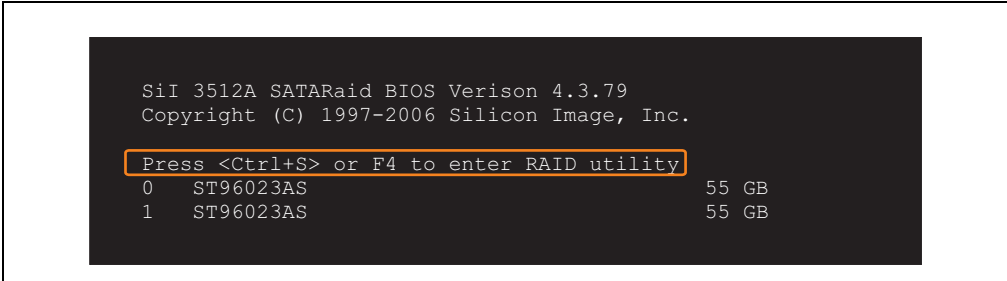

Figure 125: Open the RAID Configuration Utility

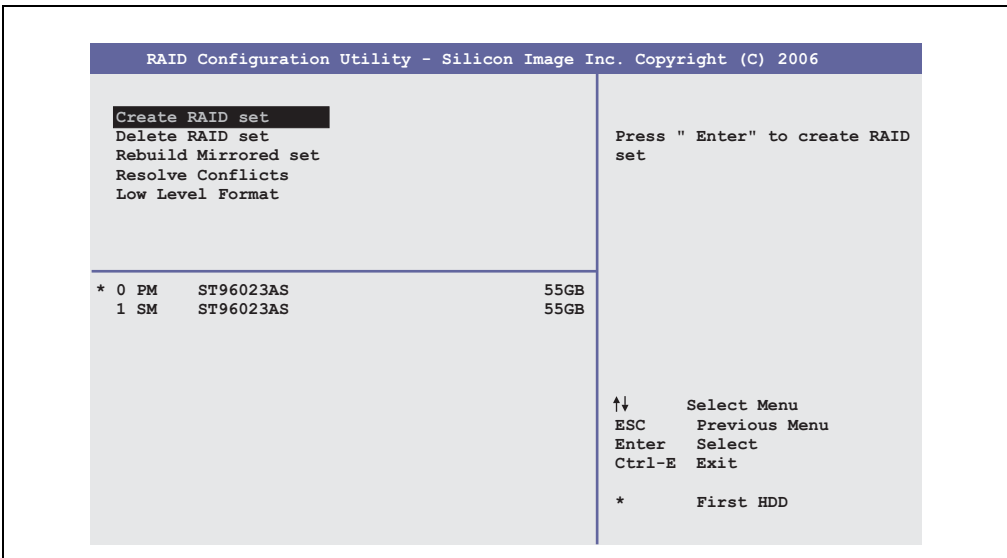

Figure 126: RAID Configuration Utility - Menu

The following keys can be used after entering the BIOS setup:

Key	Function
Cursor ↑	Go to previous item.
Cursor ↓	Go to the next item.
Enter	Select an item or open a submenu.
ESC	Go back to previous menu.

Table 97: BIOS-relevant keys in the RAID Configuration Utility

Commissioning • Configuration of a SATA RAID array

Key	Function
Ctrl+E	Exit setup and save the changed settings.

Table 97: BIOS-relevant keys in the RAID Configuration Utility

7.1 Create RAID set

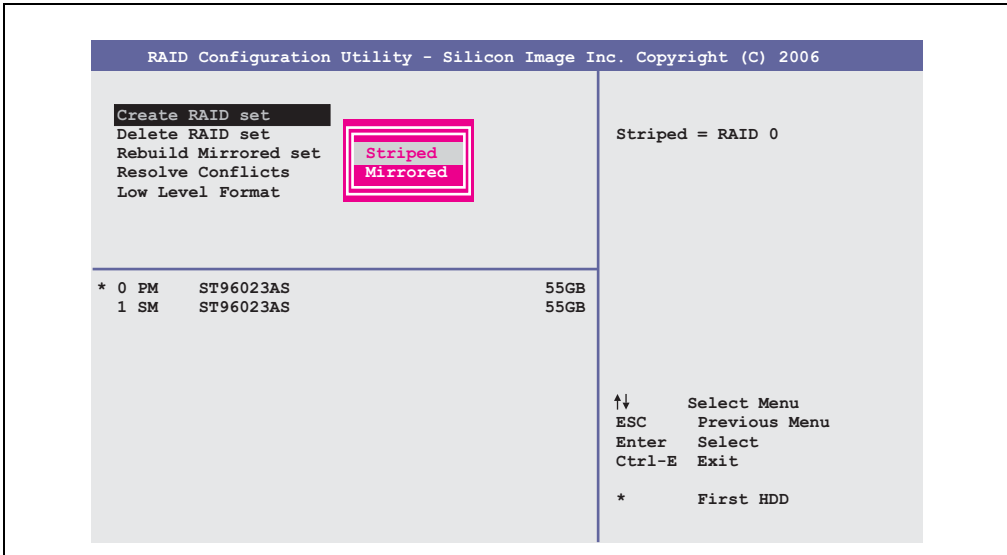

Figure 127: RAID Configuration Utility - Menu

The RAID system can be recreated as "Striped" = RAID0 or "Mirrored" = RAID1 using the menu "Create RAID set".

7.2 Create RAID set - Striped

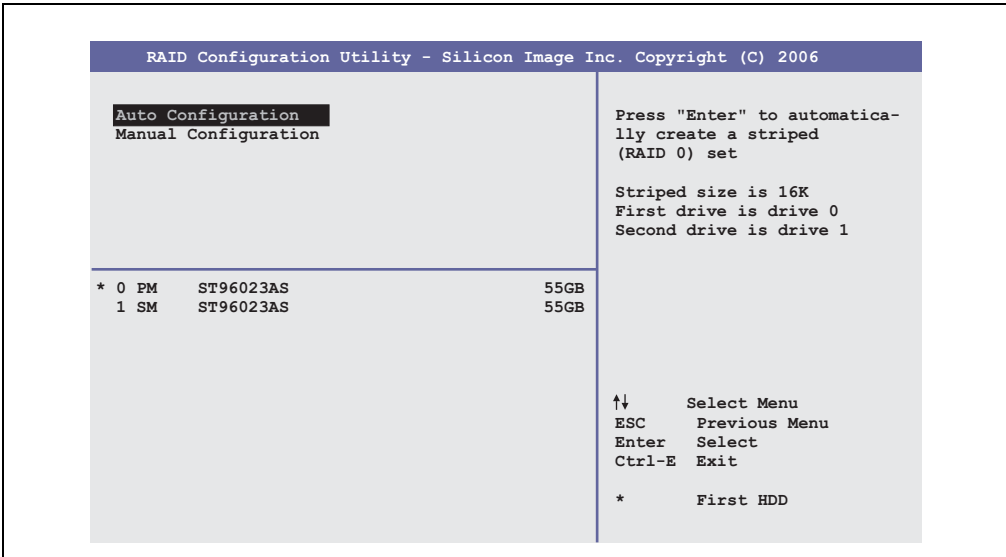

Figure 128: RAID Configuration Utility - Create RAID set - Striped

Auto Configuration

Auto Configuration optimizes all settings.

Manual Configuration

It is possible to specify the first and second HDD as well as the "Chunk Size" (= block size, application-dependent).

7.3 Create RAID set - Mirrored

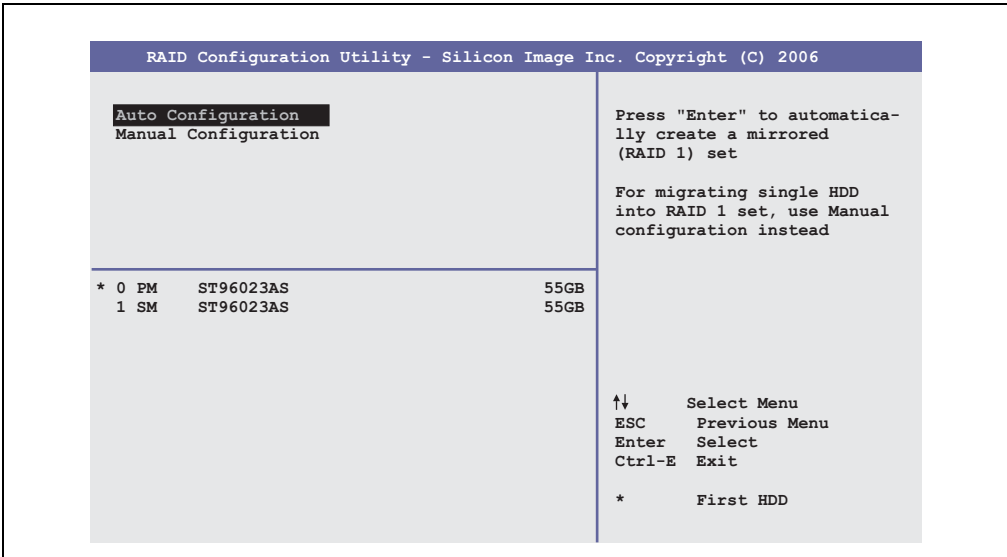

Figure 129: RAID Configuration Utility - Create RAID set - Mirrored

Auto Configuration

Auto Configuration optimizes all settings.

Manual Configuration

It is possible to specify the "Source" and "Target" HDD, and also to specify whether a rebuild (mirror) should be performed immediately (approx. 50 minutes).

7.4 Delete RAID set

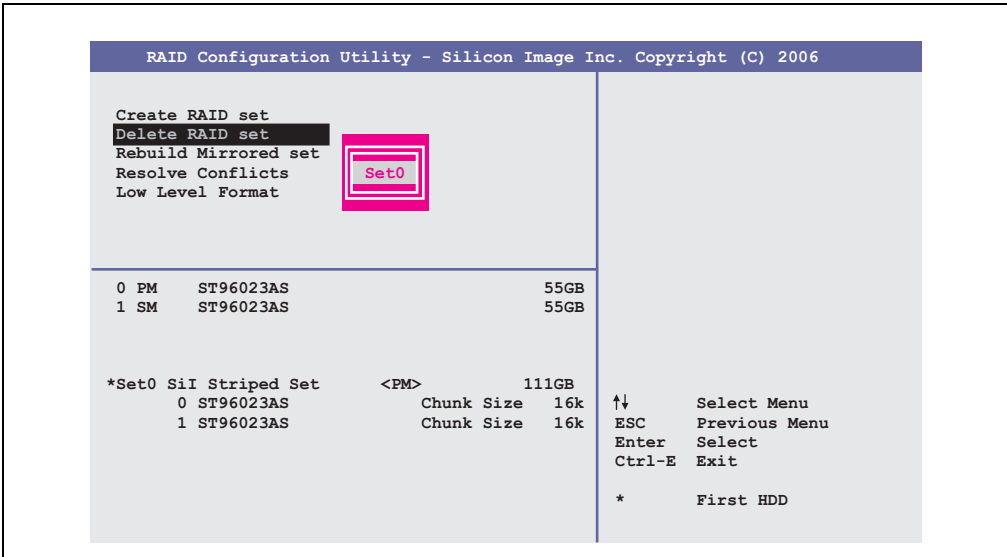

Figure 130: RAID Configuration Utility - Delete RAID set

An existing RAID set can be deleted using the menu "Delete RAID set".

7.5 Rebuild mirrored set

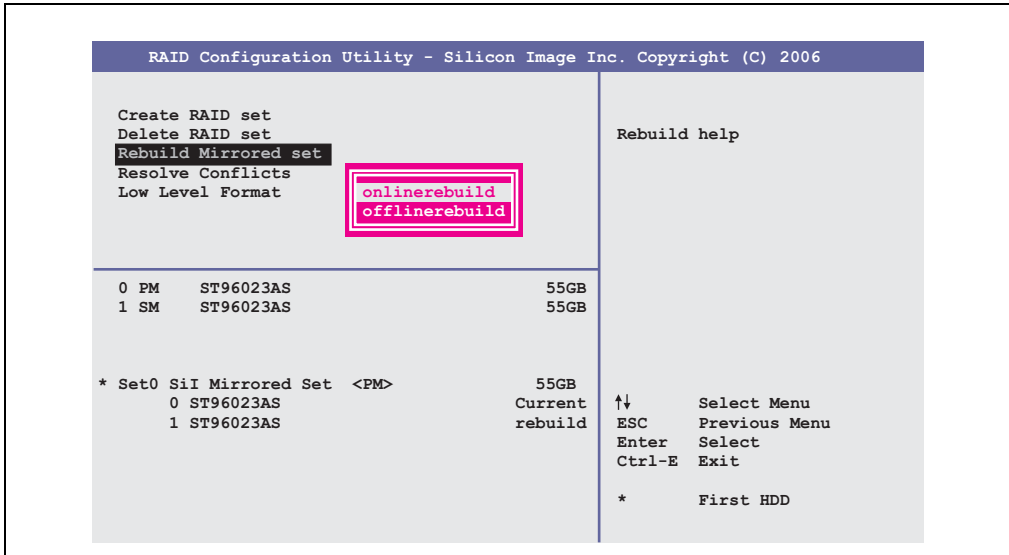

Figure 131: RAID Configuration Utility - Rebuild mirrored set

The "Rebuild mirrored set" menu can be used to restart a rebuild procedure in a RAID 1 set if an error occurs, after first interrupting the rebuild procedure or when exchanging a hard disk.

If "onlinerebuild" is selected, then the rebuild is executed during operation after the system is booted. E.g. an event pop-up is displayed by the installed SATA RAID configuration program: `SATAraid detected a new event and the rebuild is started`. The entire rebuild lasts approximately 50 minutes.

If "offlinerebuild" is selected, then a rebuild is performed immediately before starting the operating system (lasts approximately 30 minutes).

7.6 Resolve conflicts

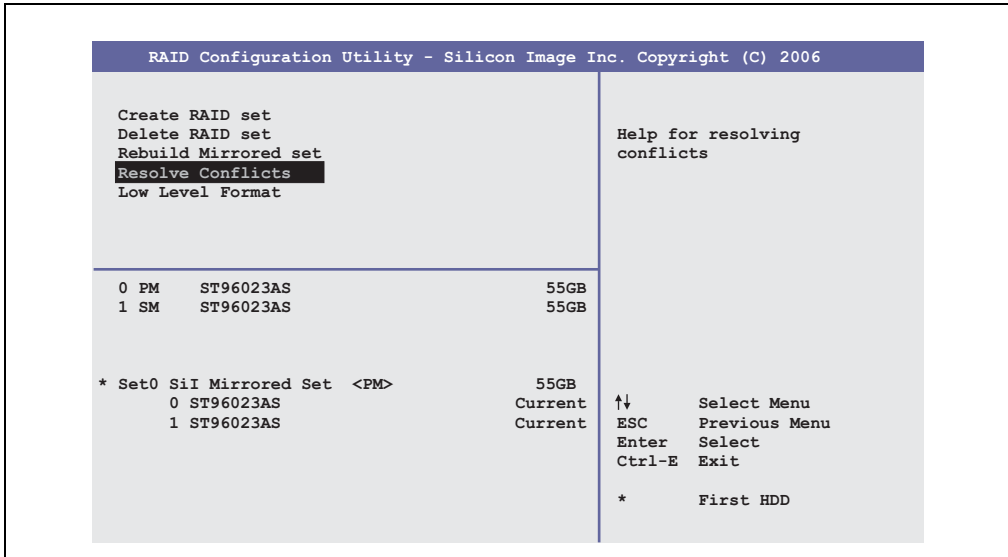

Figure 132: RAID Configuration Utility - Resolve conflicts

Conflicts in a RAID set can be resolved using the "Resolve conflicts" menu. This function is only available if the status of the hard disk is "conflict".

7.7 Low level format

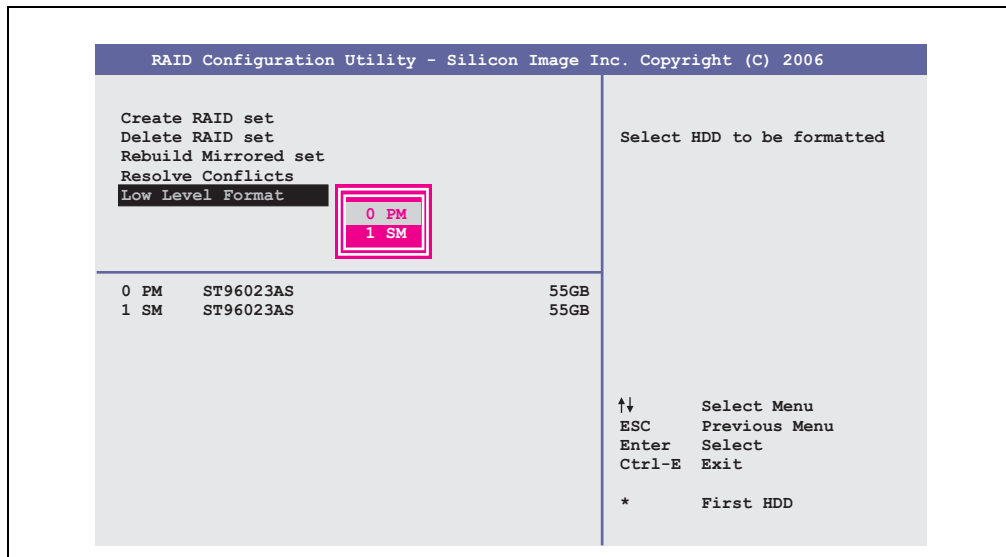

Figure 133: RAID Configuration Utility - Low level format

Individual hard disks can be configured using the "Low Level Format" menu. This can only be done if a RAID set is not configured. A low level format of a hard disk takes approx. 40 minutes.

8. Key and LED configurations

Each key or LED can be configured individually and adjusted to suit the application. Various B&R tools are available for this purpose:

- B&R Key Editor for Windows operating systems
- Visual Components for Automation Runtime

Keys and LEDs from each device are processed by the matrix controller in a bit sequence of 128 bits each.

The positions of the keys and LEDs in the matrix are shown as hardware numbers. The hardware numbers can be read directly on the target system, for example with the B&R Key Editor and the B&R Control Center.

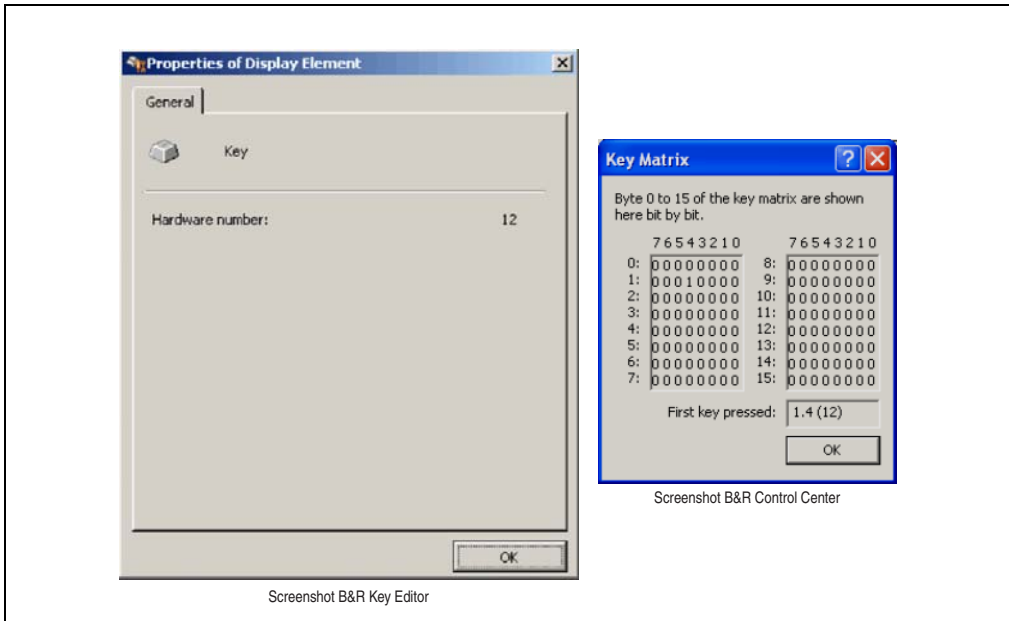

Figure 134: Example - Hardware number in the B&R Key Editor or in the B&R Control Center

The following graphics show the positions of the keys and LEDs in the matrix. They are shown as follows.

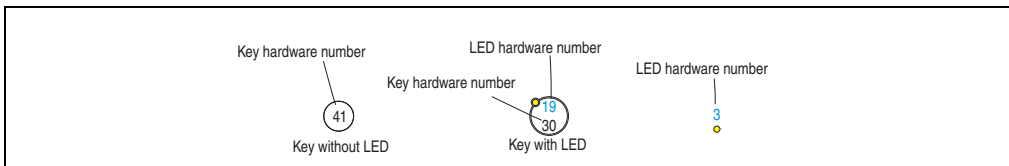

Figure 135: Display - Keys and LEDs in the matrix

8.1 Panel PC 10.4" TFT

8.1.1 Panel PC 5PC781.1043-00

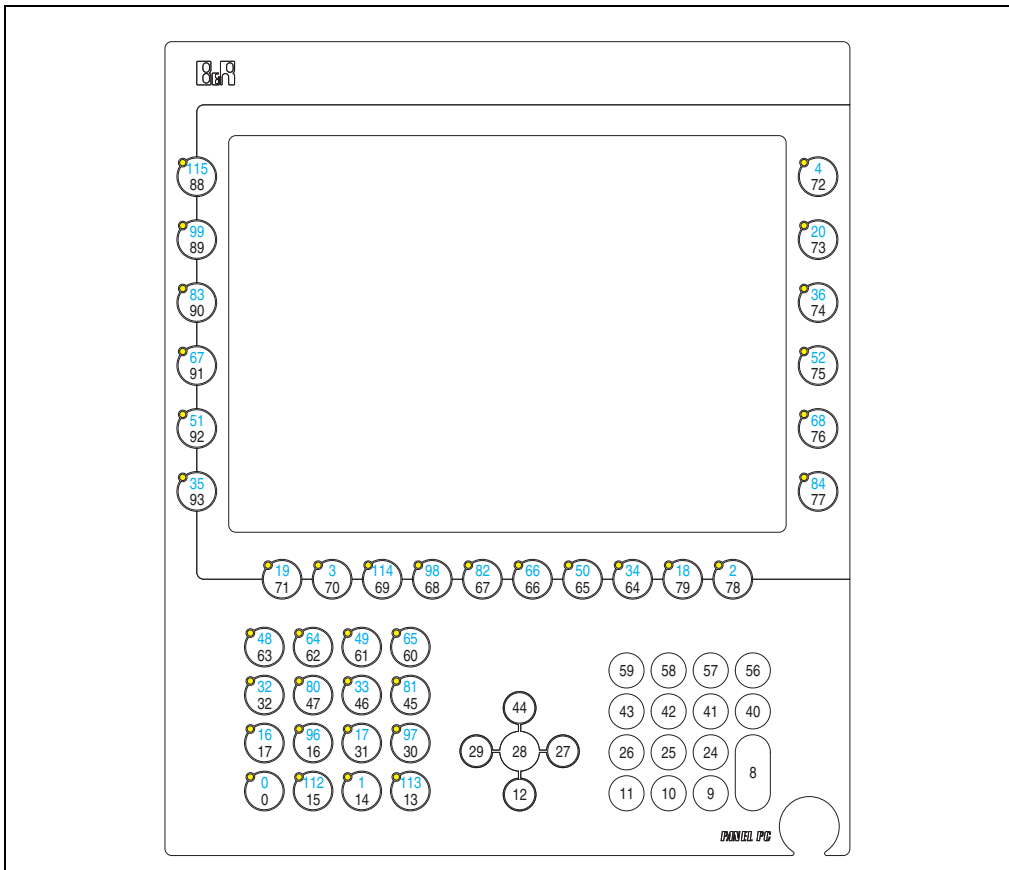

Figure 136: Hardware numbers - 5PC781.1043-00

8.1.2 Panel PC 5PC782.1043-00

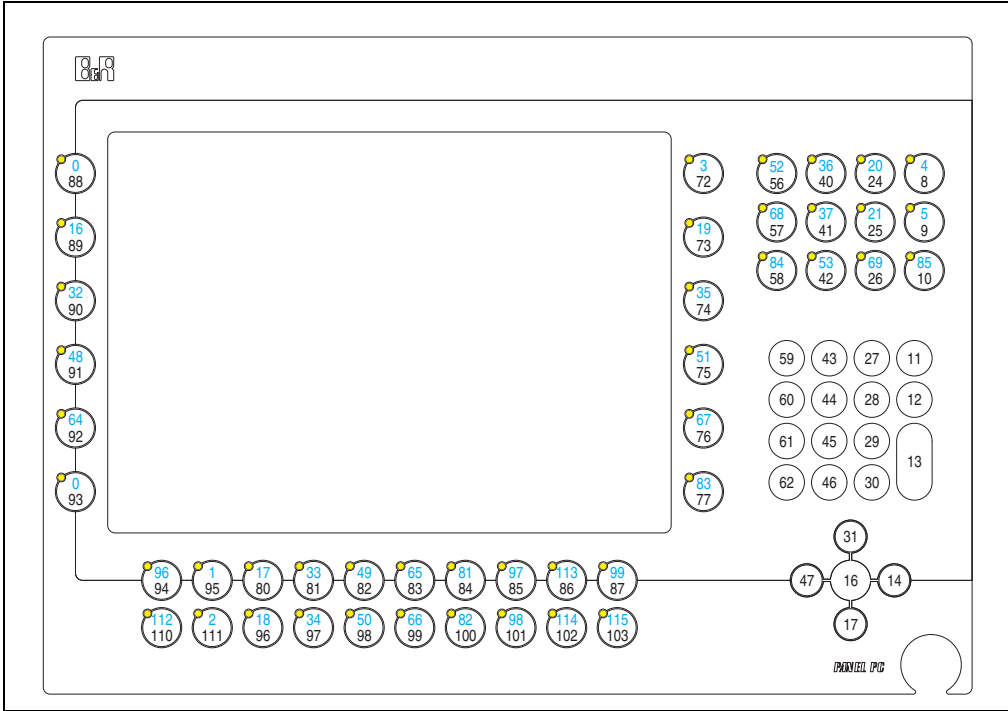

Figure 137: Hardware numbers - 5PC782.1043-00

8.2 Panel PC 15" TFT

8.2.1 Panel PC 5PC781.1505-00

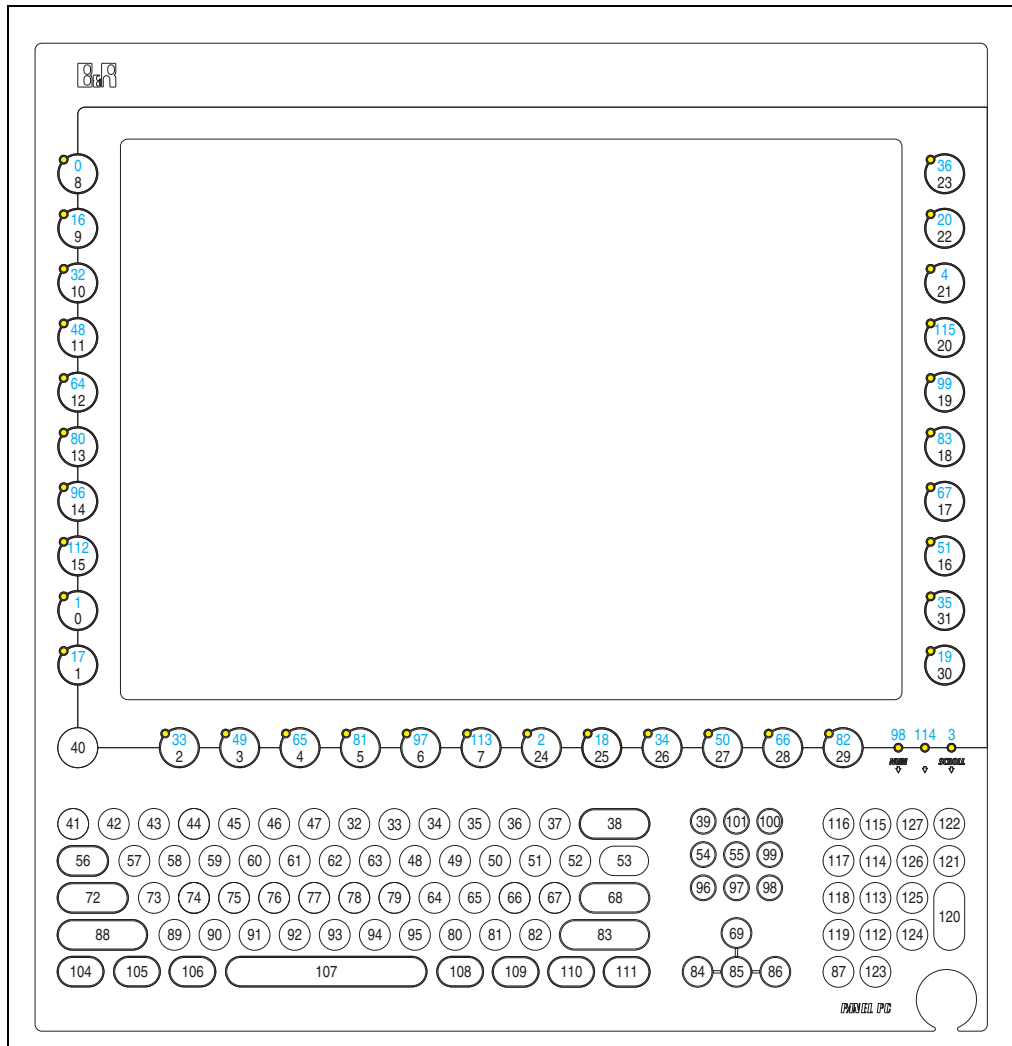

Figure 138: Hardware numbers - 5PC781.1505-00

9. User tips for increasing the display lifespan

9.1 Backlight

The lifespan of the backlight is specified in "Half Brightness Time". An operating time of 50,000 hours would mean that the display brightness would still be 50% after this time.

9.1.1 How can the lifespan of backlights be extended?

- Set the display brightness to the lowest value that is still comfortable for the eyes
- Use dark images
- Reducing the brightness by 50% can result in an approximate 50% increase of the half-brightness time.

9.2 Image sticking

Image sticking is the "burning in" of a static image on a display after being displayed for a prolonged period of time. However, this does not only occur with static images. Image sticking is known in technical literature as the "burn-in effect", "image retention", "memory effect", "memory sticking" or "ghost image".

There are 2 types of this:

- Area type: This is seen with a dark gray image. The effect disappears if the display is switched off for a longer period of time.
- Line type: This can cause lasting damage.

9.2.1 What causes image sticking?

- Static images
- Screensaver not enabled
- Sharp contrast transitions (e.g. black / white)
- High ambient temperatures
- Operation outside of the specifications

9.2.2 How can image sticking be avoided?

- continual change between static and dynamic images
- avoiding excessive brightness contrast between foreground and background display
- use of colors with similar brightness
- use of complementary colors in subsequent images
- use of screensavers

10. Pixel error

Information:

Displays can contain dead pixels that result from the manufacturing process. These flaws are not grounds claiming reclamation or warranty.

11. General instructions for performing temperature tests

The purpose of these instructions is to explain general procedures for performing application-specific temperature tests with B&R industrial PCs or Power Panels. However, these instructions are meant to serve only as a guideline.

11.1 Procedure

In order to obtain accurate results, the testing conditions should match the conditions in the field. This means that for the duration of the temperature tests, the target application should be running, the PC should be installed in the control cabinet that will be used, etc.

Additionally, a temperature sensor should be installed for the device being tested to provide live monitoring of the ambient temperature. In order to obtain accurate measurements, this sensor should be mounted at a distance of 5 to 10 cm from the B&R industrial PC, near the air intake (not near the exhaust).

All B&R industrial PCs and Power Panels are equipped with internal temperature sensors. These are installed in different locations for each series. The number of sensors and the temperature limits also vary from series to series.

Information about the locations of temperature sensors and the maximum specified values can be found in section "Temperature sensor locations", on page 471.

To ensure a reliable evaluation of the temperature situation, a minimum of 8 hours are recommended for testing.

11.2 Evaluating the temperatures in Windows operating systems

11.2.1 Evaluation using B&R Control Center

The B&R Control Center can be used to evaluate the temperatures. The temperatures can be viewed on the "Temperatures" tab. The B&R Control Center can be downloaded at no cost from the Downloads section of the B&R website (www.br-automation.com). The B&R Control Center uses the B&R Automation Device Interface (ADI).

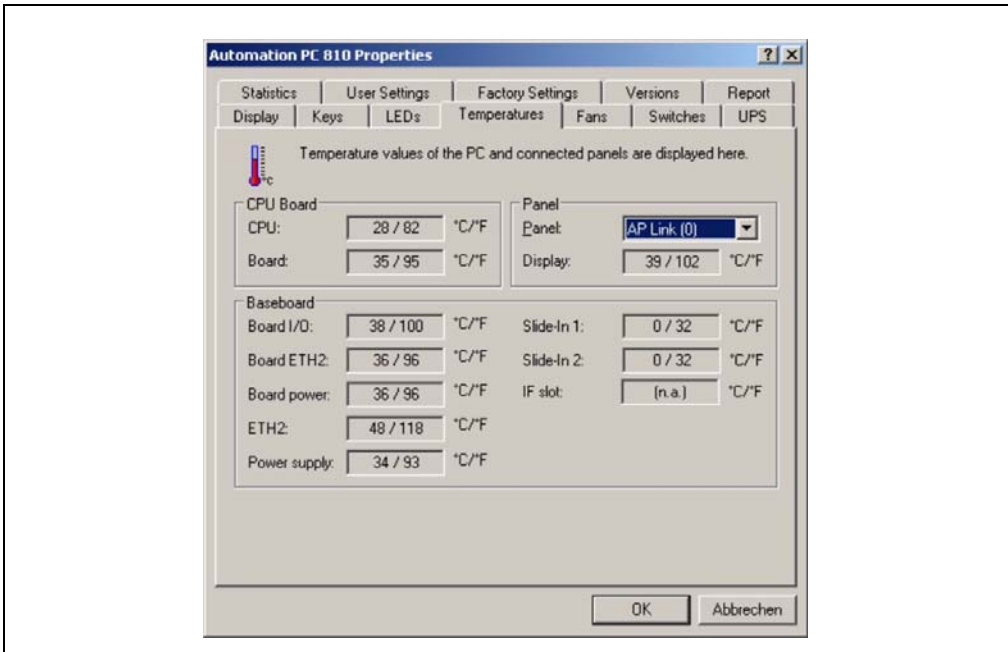

Figure 139: B&R Control Center

A new application can be created if a historic recording of the data is required.

Information:

There are SDK's (e.g. the ADI .NET SDK) available on the B&R website (www.br-automation.com) that can be helpful in creating a new application.

11.2.2 Evaluation using the BurnIn tool from Passmark

If a new application is not created for evaluating the temperatures, B&R recommends using the BurnIn Test software tool from the company Passmark.

Standard and Professional versions of the BurnIn tool are available. In addition to the software package, there are also various loopback adapters (serial, parallel, USB, etc.) and test CDs/DVDs available. The exact software and loopback adapters used will determine the corresponding load that can be generated on the system and peripheral devices.

Information:

Loopback adapters are also available from Passmark. More information can be found at www.passmark.com.

The following screenshots are based on Passmark BurnIn Pro Version V4 and an APC810 2-slot with DVD.

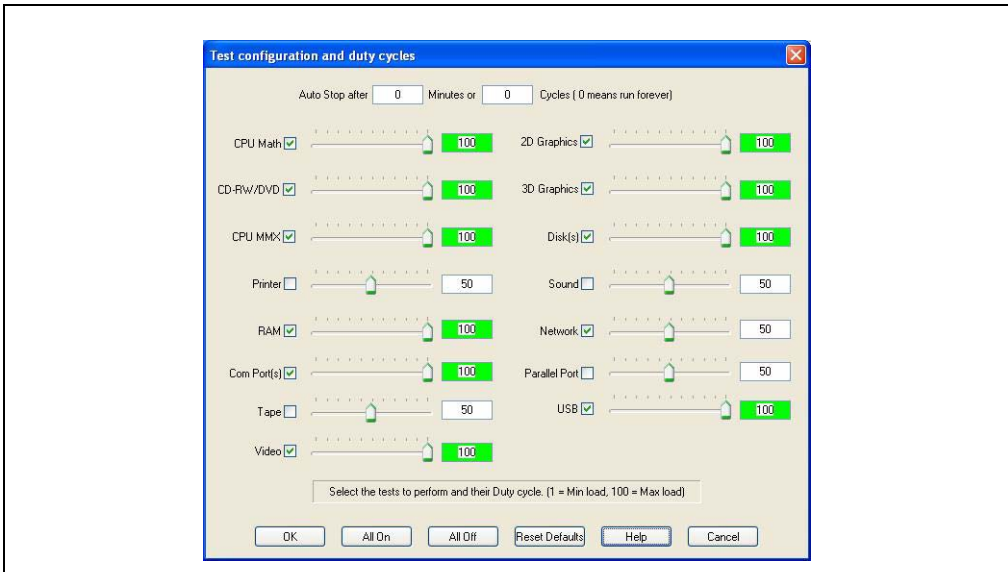

Figure 140: Settings for Passmark BurnIn Pro V4 with an APC810 2-slot with DVD

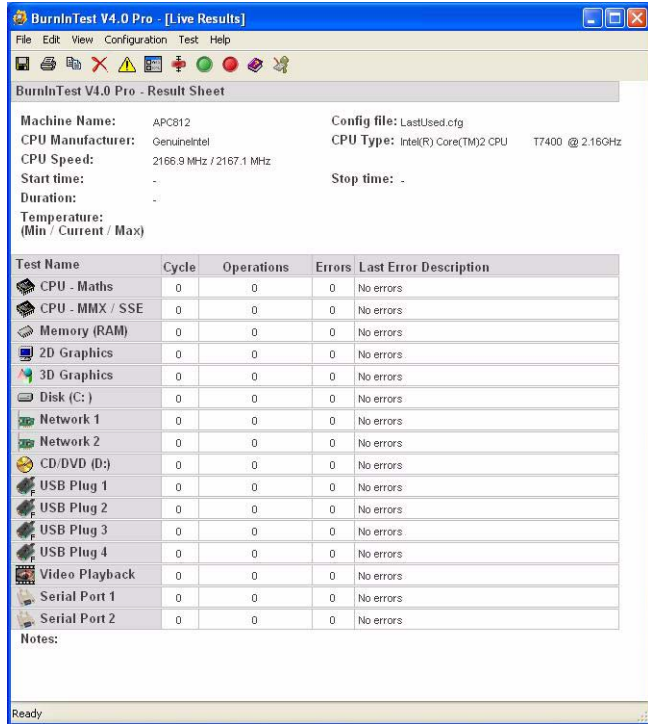

Figure 141: Test overview of an APC810 2-slot with DVD

The respective test properties may need to be fine tuned depending on the availability of a loopback adapter and DVDs.

Information:

If there is no USB loopback adapter available, USB flash drives can also be used. The USB flash drives must be available in Windows as formatted drives. The test USB must then be deselected and the USB flash drives must be configured in the disk properties.



Information:

Serial loopback adapters are relatively easy to create yourself. Simple connect several pins on the serial interface with wires.

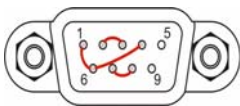

11.3 Evaluating the temperatures in an operating system other than Windows

For applications that don't use Windows, the temperatures can be evaluated using the B&R implementation guide. In addition to the implementation guide, there are also programs available in MS-DOS.

The implementation guide only describes the device-specific functions and not the main functions of the sample programs.

If code from the sample programs is used, please observe the notes in the implementation guide regarding the TODO statements, I/O access functions, etc.

Information:

Sample programs and implementation guides for any B&R industrial PC or Power Panel can be downloaded free of charge from the B&R website (www.br-automation.com).

11.4 Evaluating the measurement results

The maximum temperature value recorded by each sensor must not exceed the temperature limits specified in the user's manuals.

If the temperature tests cannot be performed in a climate controlled chamber, they can also be performed in an office environment. In this case, however, it is necessary to measure the ambient temperature. Experience at B&R has shown that values measured on passive systems (systems without a fan kit) can be projected linearly based on the ambient temperature. In order to be able to project the temperature values for systems with a fan kit, the fans must be running. It is also important to consider the speed, etc.

If the temperature tests are performed in a climate controlled chamber with fans, the devices will be cooled by these fans, and the results will be skewed. The measurement results for passive devices would therefore be unusable. In order to obtain accurate results in climate controlled chambers with fans, the chamber fans must be turned off and the device must be allowed to run for a sufficient amount of time (several hours) before beginning the test.

11.4.1 Example using an APC810 2-slot

The following example is only valid as long as the instructions for installation and mounting orientation provided in the user's manual are followed.

Temperature sensor	Measured temperature	Projected temperature	
Ambient temperature	20°C	35°C	45°C
CPU	48°C	63°C	73°C
CPU board	51°C	66°C	76°C
Board I/O	51°C	66°C	76°C
Board ETH2	52°C	67°C	77°C
Board power supply	51°C	66°C	76°C
ETH2	65°C	80°C	90°C
Power supply	51°C	66°C	76°C

Table 98: Evaluation example using an APC810 2-slot

12. Known problems / issues

The following issues for the APC620/PPC700 devices are known:

- No support for IDE-based slide-in drives. Only USB slide-in drives are supported.
- Graphics Engine 2 (GE2) interface not supported. Only GE1 and analog RGB are supported.
- In Windows XP, the Windows Standby mode is not supported in combination with the add-on hard disk (5AC600.HDDI-05 and 5AC600.HDDI-06) in IDE Slave Only mode. A blue screen or Windows crash can occur sporadically when returning from Windows Standby mode. Windows Standby mode will function if a CompactFlash card is connected to the IDE Master in addition the HDD on the slave slot. The same problem also occurs if the hard disk is switched off under Control Panel -> Power Options.
- If the Intel GMA driver (Graphics Media Accelerator) is installed in the system (e.g. in Windows XP / Windows 7), then an analog RGB monitor will always be detected, regardless of whether one is connected or not.
- Using two different types of CompactFlash cards can cause problems in Automation PCs and Panel PCs. This can result in one of the two cards not being detected during system startup. This is caused by varying startup speeds. CompactFlash cards with older technology require significantly more time during system startup than CompactFlash cards with newer technology. This behavior occurs near the limits of the time frame provided for startup. The problem described above can occur because the startup time for the CompactFlash cards fluctuates due to the variance of the components being used. Depending on the CompactFlash cards being used, this error might never, sometimes or always occur.

Chapter 4 • Software

1. BIOS options

The BIOS settings available for the X945 CPU boards are described in the following sections.

Information:

- **The following diagrams and BIOS menu items including descriptions refer to BIOS version 1.14. It is therefore possible that these diagrams and BIOS descriptions do not correspond with the installed BIOS version.**
- **The setup defaults are the settings recommended by B&R. The setup defaults are dependant on the DIP switch configuration on the baseboard (see section 1.9 "BIOS default settings", on page 293).**

1.1 General Information

BIOS stands for "Basic Input Output System". It is the most basic standardized communication between the user and the system (hardware). The BIOS system used in the Panel PC 700 systems is produced by American Megatrends Inc.

The BIOS Setup Utility lets you modify basic system configuration settings. These settings are stored in CMOS and in EEPROM (as a backup).

The CMOS data is buffered by a battery, and remains in the PPC700 even when the power is turned off (no 24VDC supply).

1.2 BIOS setup and boot procedure

BIOS is immediately activated when switching on the power supply of the Panel PC 700 system or pressing the power button. The system checks if the setup data from the EEPROM is "OK". If the data is "OK", then it is transferred to the CMOS. If the data is "not OK", then the CMOS data is checked for validity. An error message is output if the CMOS data contains errors and the boot procedure can be continued by pressing the <F1> key. To prevent the error message from appearing at each restart, open the BIOS setup by pressing the key and re-save the settings.

BIOS reads the system configuration information in CMOS RAM, checks the system, and configures it using the Power On Self Test (POST).

Software • BIOS options

When these "preliminaries" are finished, BIOS seeks an operating system in the data storage devices available (hard drive, floppy drive, etc.). BIOS launches the operating system and hands over control of system operations to it.

To enter BIOS Setup, the DEL key must be pressed as soon as the following message appears on the monitor (during POST):

"Press DEL to run SETUP"

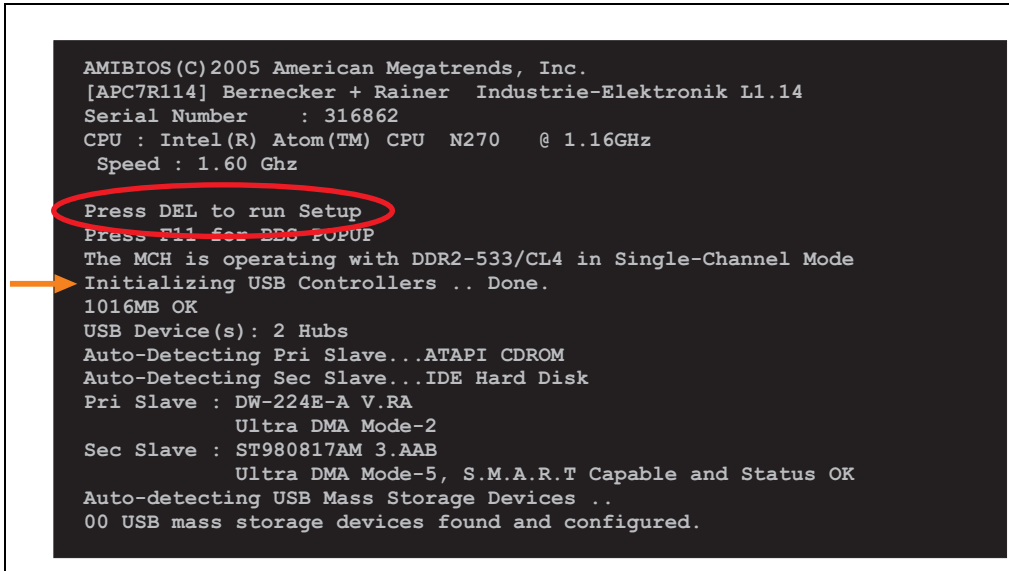

```
AMIBIOS(C) 2005 American Megatrends, Inc.
[APC7R114] Bernecker + Rainer Industrie-Elektronik L1.14
Serial Number      : 316862
CPU : Intel(R) Atom(TM) CPU N270 @ 1.16Ghz
Speed : 1.60 Ghz
Press DEL to run Setup
Press F11 for BDO POPUP
The MCH is operating with DDR2-533/CL4 in Single-Channel Mode
Initializing USB Controllers .. Done.
1016MB OK
USB Device(s): 2 Hubs
Auto-Detecting Pri Slave...ATAPI CDROM
Auto-Detecting Sec Slave...IDE Hard Disk
Pri Slave : DW-224E-A V.RA
              Ultra DMA Mode-2
Sec Slave : ST980817AM 3.AAB
              Ultra DMA Mode-5, S.M.A.R.T Capable and Status OK
Auto-detecting USB Mass Storage Devices ..
00 USB mass storage devices found and configured.
```

Figure 142: X945 - BIOS diagnostics screen

1.2.1 BIOS setup keys

The following keys are enabled during the POST:

Key	Function
ESC	The system RAM check can be skipped by pressing ESC.
Del	Enters the BIOS setup menu.
F12	Using the F12 key, you can boot from the network.
F11	Cues the boot menu. Lists all bootable devices that are connected to the system. With cursor ↑ and cursor ↓ and by pressing <ENTER>, select the device from which will be booted.
<Break>	Pressing the <pause> key stops the POST. Press any other key to resume the POST.

Table 99: X945 bios-relevant keys at POST

The following keys can be used after entering the BIOS setup:

Key	Function
F1	General help
Cursor ↑	Moves to the previous item.
Cursor ↓	Go to the next item.
Cursor ←	Moves to the previous item.
Cursor →	Go to the next item.
+ -	Changes the setting of the selected function.
Enter	Changes to the selected menu.
PageUp ↑	Change to the previous page.
PageDown ↓	Change to the previous page.
Pos 1	Jumps to the first BIOS menu item or object.
End	Jumps to the last BIOS menu item or object.
F2 / F3	The colors of the BIOS Setup are switched.
F7	Changes are reset.
F9	These settings are loaded for all BIOS configurations.
F10	Save and close.
Esc	Exits the submenu.

Table 100: X945 bios-relevant keys in the BIOS menu

The following sections explain the individual BIOS main menu items in detail.

BIOS setup menu item	Function	From page
Main	You can configure the ground configuration time and date in this menu.	252
Advanced	Advanced BIOS options such as cache areas, PnP, keyboard repeat rate, as well as settings specific to B&R integrated hardware, can be configured here.	253
Boot	The boot order can be set here.	285
Security	For setting up the system's security functions.	287
Power	Setup of various APM (Advanced Power Management) options.	290
Exit	To end the BIOS setup.	292

Table 101: X945 - Overview of BIOS menu items

1.3 Main

Immediately after the DEL button is pressed during startup, the main BIOS setup menu appears.

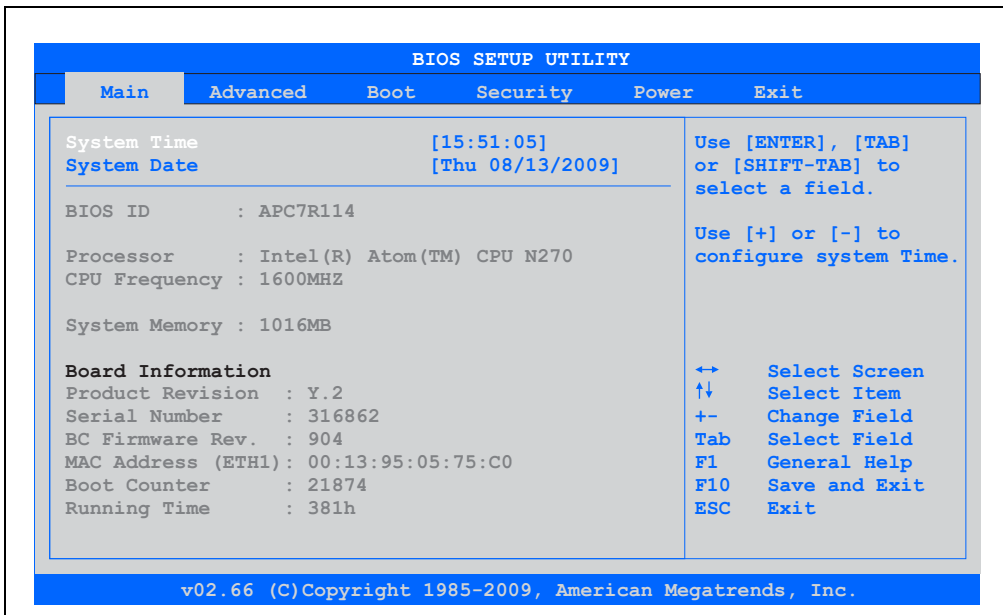

Figure 143: X945 BIOS Main Menu

BIOS setting	Meaning	Setting options	Effect
System Time	This is the current system time setting. The time is buffered by a battery (CMOS battery) after the system has been switched off.	Changes the System time	Set the system time in the format Hour:Minute:Second (hh:mm:ss).
System Date	This is the current system date setting. The time is buffered by a battery (CMOS battery) after the system has been switched off.	Changes the system date	Sets the system date in the format Month:Day:Year (mm:dd:yyyy).
BIOS ID	Displays the BIOS recognition.	None	-
Processor	Displays the processor type.	None	-
CPU Frequency	Displays the processor frequency.	None	-
System Memory	Displays the system memory size.	None	-
Product Revision	Displays the CPU board HW revision.	None	-
Serial number	Displays the CPU board serial number.	None	-
BC Firmware Rev.	Displays the CPU board controller firmware revision.	None	-
MAC Address (ETH1)	Displays the MAC addresses assigned for the ETH1 interface.	None	-

Table 102: X945 Main Menu setting options

BIOS setting	Meaning	Setting options	Effect
Boot Counter	Displays the boot counter - each restart increments the counter by one (max. 16777215).	None	-
Running Time	Displays the runtime in whole hours. (max. 65535).	None	-

Table 102: X945 Main Menu setting options (Forts.)

1.4 Advanced

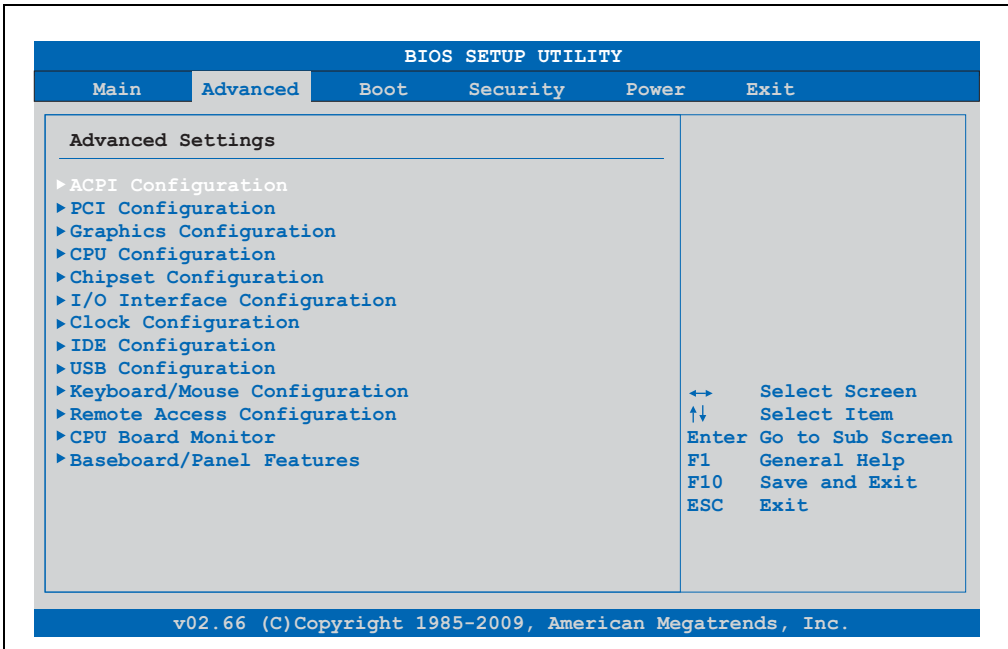

Figure 144: X945 Advanced Menu

BIOS setting	Meaning	Setting options	Effect
ACPI configuration	Configures the APCI devices.	Enter	Opens the submenu See "ACPI configuration", on page 254.
PCI Configuration	Configures PCI devices.	Enter	Opens the submenu See "PCI Configuration", on page 256.
Graphics configuration	Configures the graphics settings.	Enter	Opens the submenu See "Graphics configuration", on page 260.
CPU configuration	Configures the CPU settings.	Enter	Opens the submenu See "CPU configuration", on page 262.
Chipset configuration	Configures the chipset functions.	Enter	Opens the submenu See "Chipset configuration", on page 264.

Table 103: X945 Advanced Menu setting options

Software • BIOS options

BIOS setting	Meaning	Setting options	Effect
I/O interface configuration	Configures the I/O devices.	Enter	Opens the submenu See "I/O interface configuration", on page 266.
Clock Configuration	Configures the clock settings.	Enter	Opens the submenu See "Clock Configuration", on page 267.
IDE Configuration	Configures the IDE functions.	Enter	Opens the submenu See "IDE Configuration", on page 268.
USB configuration	Configures the USB settings.	Enter	Opens the submenu See "USB configuration", on page 274.
Keyboard/mouse configuration	Configures the keyboard/mouse options.	Enter	Opens the submenu See "Keyboard/mouse configuration", on page 276.
Remote access configuration	Configures the remote access settings.	Enter	Opens the submenu See "Remote access configuration", on page 277.
CPU board monitor	Displays the current voltages and temperature of the processor in use.	Enter	Opens the submenu See "CPU board monitor", on page 279.
Main Board/Panel Features	Displays device specific information and setup of device specific values.	Enter	Opens the submenu See "Main Board/Panel Features", on page 280.

Table 103: X945 Advanced Menu setting options (Forts.)

1.4.1 ACPI configuration

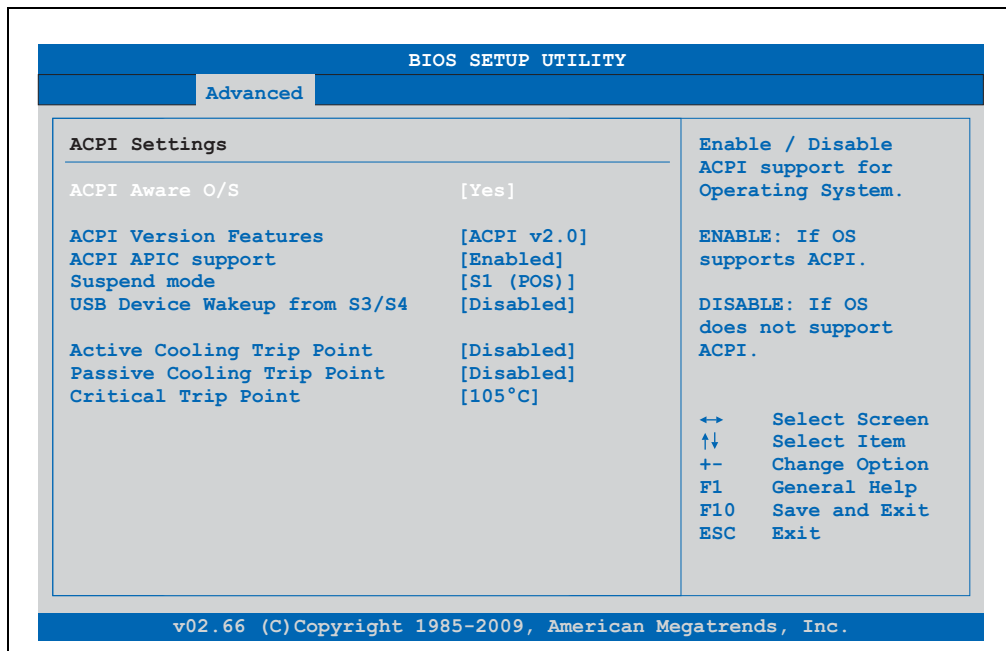

Figure 145: X945 Advanced ACPI configuration

BIOS setting	Meaning	Setting options	Effect
ACPI Aware O/S	This function determines if the operating system supports the ACPI function (Advanced Configuration and Power Interface).	Yes	The operating system supports ACPI.
		No	The operating system does not support ACPI.
ACPI Version Features	Option for setting the power option specifications to be supported. The ACPI functions must be supported by the drivers and operating systems being used.	ACPI v1.0	ACPI functions in accordance with v1.0
		ACPI v2.0	ACPI functions in accordance with v2.0
		ACPI v3.0	ACPI functions in accordance with v3.0
ACPI APIC support	This option controls the support of the advanced programmable interrupt controller in the processor.	Enabled	Enables this function.
		Disabled	Disables the function
Suspend mode	Selects the ACPI status to be used when Suspend Mode is enabled.	S1 (POS)	Sets S1 as Suspend mode. Only a few functions are disabled and are available again at the touch of a button
		S3 (STR)	Sets S3 as Suspend Mode. The current state of the operating system is written to the RAM, which is then supplied solely with power.
USB Device Wakeup from S3/S4	This options makes it possible for activity on a connected USB device to wake the system up from the S3/S4 standby mode.	Enabled	Enables this function.
		Disabled	Disables the function
Active Cooling Trip Point	With this function, an optional CPU fan is activated by the operating system when the CPU reaches the set temperature. Temperature reached.	Disabled	Disables this function.
		50°C, 60°C, 70°C, 80°C, 90°C	Temperature setting for the active cooling trip point. Can be set in 10 degree increments.
Passive Cooling Trip Point	With this function, a temperature can be set at which the CPU automatically reduces its speed.	Disabled	Disables this function.
		50°C, 60°C, 70°C, 80°C, 90°C	Temperature setting for the passive cooling trip point. Can be set in 10 degree increments.
Critical Trip Point	With this function, a temperature can be set at which the operating system automatically shuts the system down.	80°C, 85°C, 90°C, 95°C, 100°C, 105°C, 110°C	Temperature setting for the critical trip point. Can be set in 5 degree increments.

Table 104: X945 Advanced ACPI configuration setting options

1.4.2 PCI Configuration

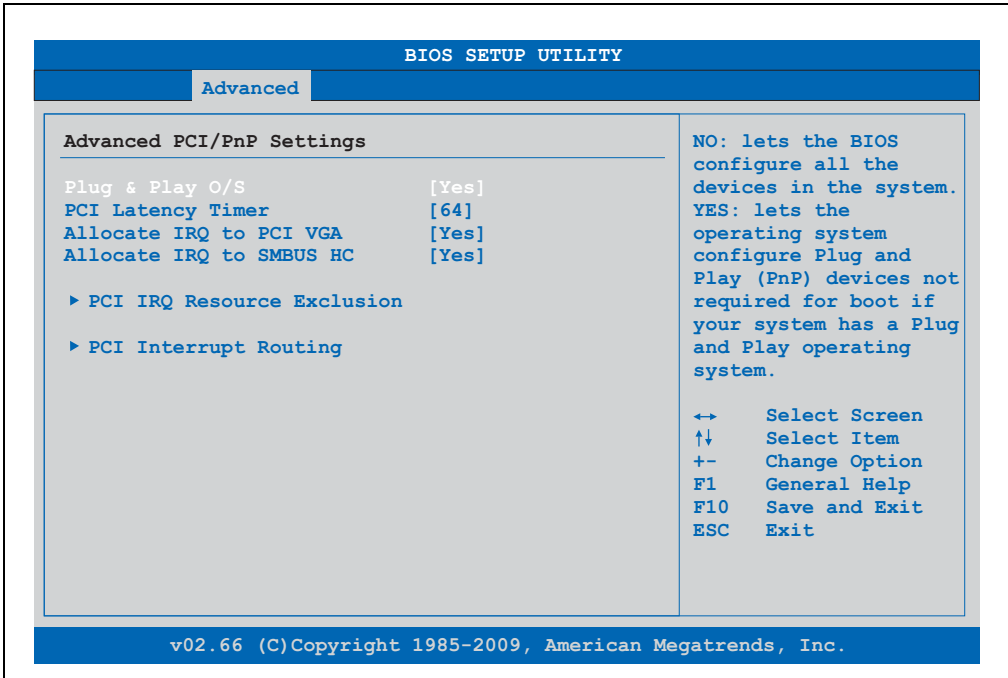

Figure 146: X945 Advanced PCI Configuration

BIOS setting	Meaning	Setting options	Effect
Plug & Play O/S	BIOS is informed if Plug & Play is capable on the operating system.	Yes	The operating system handles the distribution of resources.
		No	BIOS handles the distribution of resources.
PCI Latency Timer	This option controls how long (in PCI ticks) one PCI bus card can continue to use the master after another PCI card has requested access.	32, 64, 96, 128, 160, 192, 224, 248	Manually sets the value in PCI ticks.
Allocate IRQ to PCI VGA	This function is used to determine if an interrupt is assigned to the PCI VGA.	Yes	Automatic assignment of an interrupt.
		No	No assignment of an interrupt.
Allocate IRQ to SMBUS HC	Use this function to set whether or not the SM (System Management) bus controller is assigned a PCI interrupt.	Yes	Automatic assignment of a PCI interrupt.
		No	No assignment of an interrupt.
PCI IRQ Resource Exclusion	Configures the PCI IRQ resource settings for ISA Legacy devices.	Enter	Opens the submenu See "PCI IRQ Resource Exclusion", on page 257
PCI Interrupt Routing	Configures PCI interrupt routing	Enter	Opens the submenu See "PCI Interrupt Routing", on page 258

Table 105: X945 Advanced PCI configuration setting options

PCI IRQ Resource Exclusion

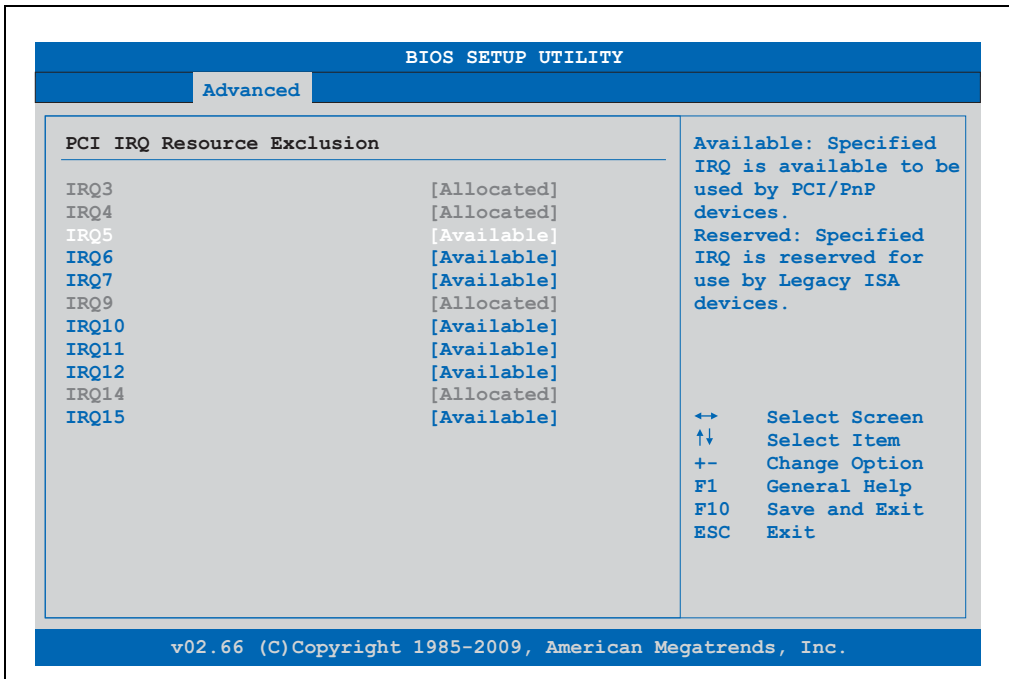

Figure 147: X945 Advanced PCI IRQ Resource Exclusion

BIOS setting	Meaning	Setting options	Effect
IRQx	IRQ interrupt routing for Legacy ISA devices.	Allocated	Allocated by the system - cannot be used.
		Available	Available - can be used.
		Reserved	Reserved - cannot be used.

Table 106: X945 Advanced PCI IRQ Resource Exclusion setting options

PCI Interrupt Routing

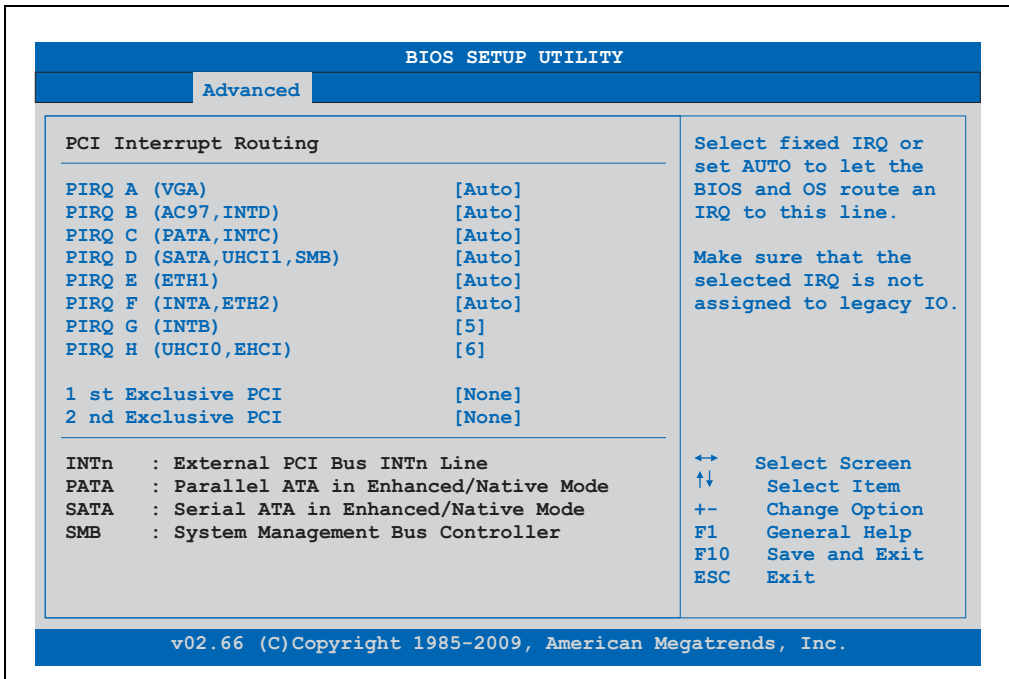

Figure 148: X945 Advanced PCI Interrupt Routing

BIOS setting	Meaning	Setting options	Effect
PIRQ A (VGA)	Option for setting the PIRQ A.	Auto	Automatic assignment by the BIOS and operating system.
		5,6,7,9,10,11,12	Manual assignment
PIRQ B (AC97, INTD)	Option for setting the PIRQ B.	Auto	Automatic assignment by the BIOS and operating system.
		5,6,7,9,10,11,12	Manual assignment.
PIRQ C (PATA,INTC)	Option for setting the PIRQ C.	Auto	Automatic assignment by the BIOS and operating system.
		5,6,7,9,10,11,12	Manual assignment.
PIRQ D (SATA,UHCI1,SMB)	Option for setting the PIRQ D.	Auto	Automatic assignment by the BIOS and operating system.
		5,6,7,9,10,11,12	Manual assignment.
PIRQ E (ETH1)	Option for setting the PIRQ E.	Auto	Automatic assignment by the BIOS and operating system.
		5,6,7,9,10,11,12	Manual assignment.

Table 107: X945 Advanced PCI Interrupt Routing setting options

BIOS setting	Meaning	Setting options	Effect
PIRQ F (INTA, ETH2)	Option for setting the PIRQ F.	Auto	Automatic assignment by the BIOS and operating system.
		5,6,7,9,10,11,12	Manual assignment.
PIRQ G (INTB)	Option for setting the PIRQ G.	Auto	Automatic assignment by the BIOS and operating system.
		5,6,7,9,10,11,12	Manual assignment.
PIRQ H (UHCI0, EHCI)	Option for setting the PIRQ H.	Auto	Automatic assignment by the BIOS and operating system.
		5,6,7,9,10,11,12	Manual assignment.
1st Exclusive PCI	With this option you can determine if the IRQ assigned to the PIRQ x is handled exclusively (no IRQ sharing). Information: Is only displayed if a PIRQ is manually set (e.g. 5).	None	No interrupt is assigned.
		x	Assigns the PIRQ as 1st exclusive PCI IRQ.
2nd Exclusive PCI	With this option you can determine if the IRQ assigned to the PIRQ x is handled exclusively (no IRQ sharing). Information: Only displayed when two PIRQs are set manually.	None	No interrupt is assigned.
		x	Assigns the PIRQ as 2nd exclusive PCI IRQ.
3rd Exclusive PCI	With this option you can determine if the IRQ assigned to the PIRQ x is handled exclusively (no IRQ sharing). Information: Only displayed in connection with an APC620e and if three PIRQs are set manually.	None	No interrupt is assigned.
		x	Assigns the PIRQ as 3rd exclusive PCI IRQ.

Table 107: X945 Advanced PCI Interrupt Routing setting options (Forts.)

1.4.3 Graphics configuration

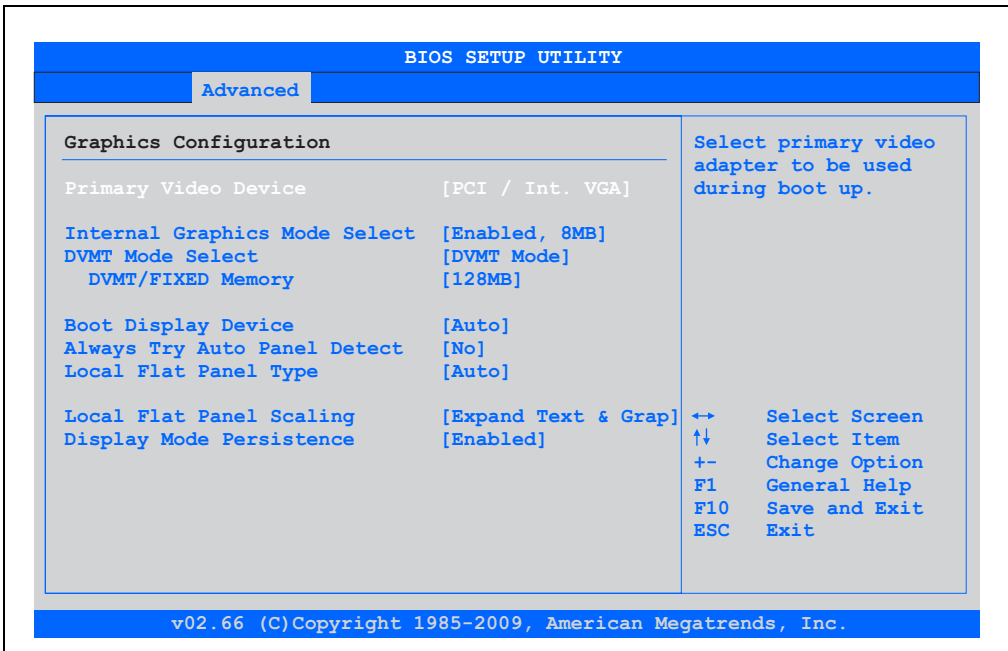

Figure 149: X945 Advanced Graphics configuration

BIOS setting	Meaning	Setting options	Effect
Primary Video Device	Option for selecting the primary video device.	Internal VGA	The internal graphics chip on the CPU board is used as video device (monitor / panel connection).
		PCI / Int. VGA	The graphics chip of a connected graphics card is used as video device.
Internal Graphics Mode Select	Option for setting the memory size that can be used for the internal graphics controller.	Disabled	No reservation - Disables the graphics controller.
		Enabled, 1MB	1MB main memory provided.
		Enabled, 8MB	8MB main memory provided.
DVMT Mode Select	Option for determining the DVMT mode (Dynamic Video Memory Technology) of the DVMT graphics driver.	Fixed Mode	A fixed amount of memory is allocated to the graphics chip, which is no longer available to the PC.
		DVMT Mode	Memory consumption is controlled dynamically by the DVMT graphics driver. Only the amount of memory that is required is used.
		Combo Mode	The DVMT graphics driver reserves at least 64MB, but can use up to 224MB if necessary.

Table 108: X945 Advanced Graphics configuration setting options

BIOS setting	Meaning	Setting options	Effect
DVMT/FIXED Memory	Option for setting the amount of memory used for the DVMT mode.	64MB	64MB of main memory can be used.
		128MB	128MB of main memory can be used.
		Maximum DVMT	The remaining available main memory can be used.
Boot Display Device	Determines which video channel should be enabled for a video device during the boot procedure.	Auto	Automatic selection.
		CRT only	Only use the CRT (Cathode Ray Tube) channel.
		LFP only	Only use the LFP (Local Flat Panel) channel.
		CRT + LFP	Use CRT + LFP channel.
Always Try Auto Panel Detect	This option first searches for EDID data in an external EEPROM to configure the LFP. If no EDID data is found, then the data selected under "Local Flat Panel Type" is used.	No	Disables this function.
		Yes	Enables this function.
Local Flat Panel Type	This option can be used to set a pre-defined profile for the LVDS channel.	Auto	Automatic detection and setting using the EDID data.
		VGA 1x18 (002h)	640 x 480
		VGA 1x18 (013h)	640 x 480
		SVGA 1x18 (01Ah)	800 x 600
		XGA 1x18 (006h)	1024 x 768
		XGA 2x18 (007h)	1024 x 768
		XGA 1x24 (008h)	1024 x 768
		XGA 2x24 (012h)	1024 x 768
		SXGA 2x24 (00Ah)	1280 x 1024
		SXGA 2x24 (018h)	1280 x 1024
		UXGA 2x24 (00Ch)	1600 x 1200
		Customized EDID 1	User-defined profile
		Customized EDID 2	User-defined profile
Customized EDID 3	User-defined profile		
Local flat panel scaling	Determines the screen content should be output according to the defined Local Flat Panel Type.	Centering	The screen content is output centered on the display.
		Expand Text	The text is stretched across the entire surface of the display.
		Expand Graphics	The graphics are stretched across the entire surface of the display.
		Expand Text & Graphics	Text and graphics are stretched across the entire surface of the display.
Display Mode Persistence	When enabled, the operating system graphics driver attempts to restore the most recent configuration.	Enabled	Enables this function.
		Disabled	Disables this function.

Table 108: X945 Advanced Graphics configuration setting options (Forts.)

1.4.4 CPU configuration

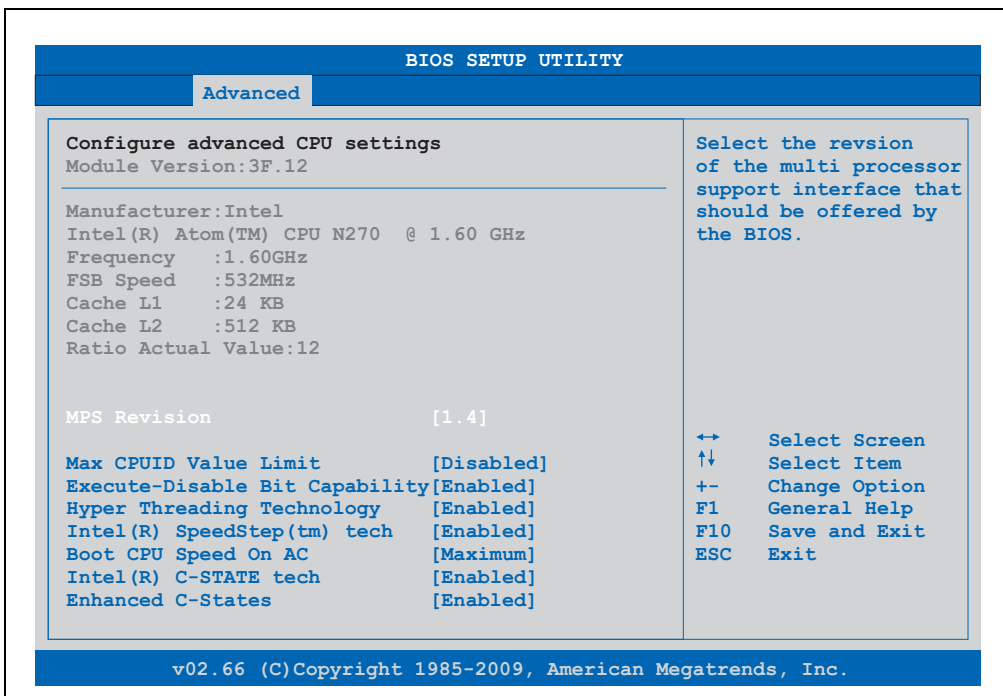

Figure 150: X945 Advanced CPU Configuration

BIOS setting	Meaning	Setting options	Effect
Module Version	BIOS Module Version	None	-
Manufacturer	Manufacturer's display.	None	-
Frequency	Processor speed display	None	-
FSB speed	Cycle display of all addressed components. (Front side bus)	None	-
L1 cache	Displays first level cache memory area.	None	-
L2 cache	Displays first level cache memory area.	None	-
Ratio Actual Value	Displays the Ratio Actual Value.	None	-
MPS Revision	This option supports the use of multiple CPUs (MPS=multi-processor system).	1.1	Sets MPS support Revision 1.1
		1.4	Sets MPS support Revision 1.4
Max CPUID value limit	Option for limiting the CPUID input value. This could be necessary for older operating systems.	Enabled	The processor limits the maximum CPUID input value to 03h if necessary when the the processor supports a higher value.
		Disabled	The processor returns the current maximum value upon request of the CPUID input value.

Table 109: X945 Advanced CPU Configuration setting options

BIOS setting	Meaning	Setting options	Effect
Execute-Disable Bit Capability	Option for enabling or disabling hardware support for prevention of data execution.	Enabled	Enables this function.
		Disabled	Disables this function.
Hyper Threading Technology	Hyper threading technology enables a single physical processor to appear as a multitude of logical processors. This technology allows the operating system to get more out of the internal processor resources, which in turns leads to increased performance. Information: This setting should only be disabled when using an operating system older than Windows XP.	Enabled	Enables this function.
		Disabled	Disables this function.
Intel (R) SpeedStep (tm) tech	Option for controlling the Intel(R) SpeedStep(TM) technology. The processor clock speed is increased or decreased according to the amount of calculations that must be made. As a result, the power consumption depends largely on the processor load.	Enabled	SpeedStep technology enabled.
		Disabled	Disables SpeedStep technology.
Boot CPU Speed On AC	This setting is used to define the maximum or minimum CPU speed during the boot procedure. However, the operating system can change the speed during operation.	Minimum	CPU starts with minimum speed during the boot procedure.
		Maximum	CPU starts with maximum speed during the boot procedure.
Intel(R) C-STATE tech	This setting allows the operating system to set processor clock rates on its own, thereby saving energy.	Enabled	Enables this function. The processors are run at different frequencies, thereby saving energy.
		Disabled	Disables this function. Both processors are run at the same frequency.
Enhanced C-States ¹⁾	This setting allows the operating system to set processor clock rates on its own, thereby saving energy.	Enabled	Enables this function.
		Disabled	Disables this function.

Table 109: X945 Advanced CPU Configuration setting options

1) This setting is only shown if *Intel(R) C-State Tech.* is set to *Enabled*.

1.4.5 Chipset configuration

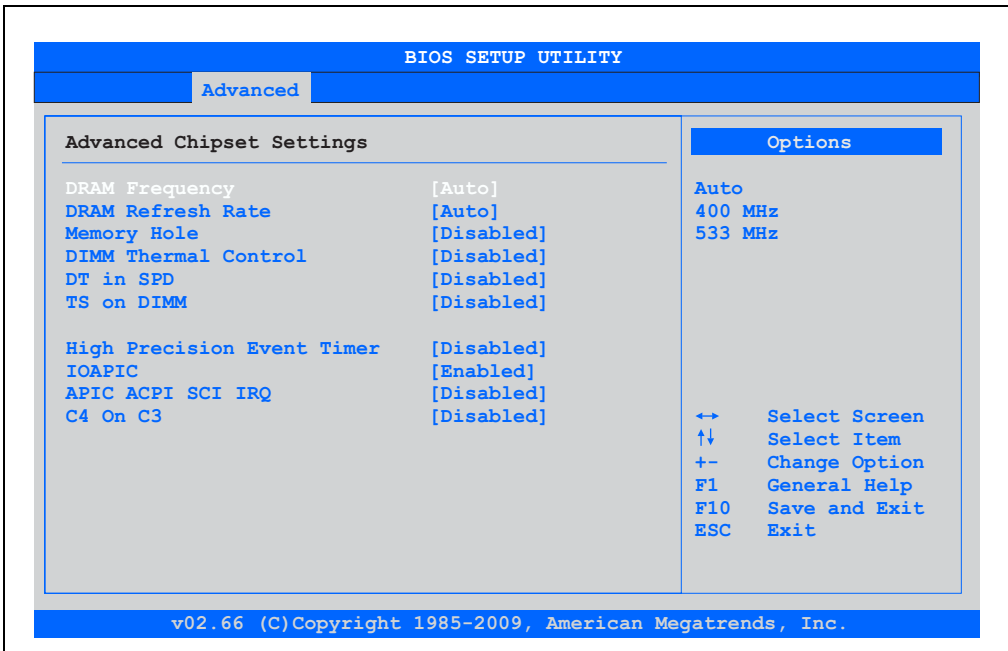

Figure 151: X945 Advanced Chipset Configuration

BIOS setting	Meaning	Setting options	Effect
DRAM Frequency	Option for setting the RAM frequency.	Auto	Frequency set automatically by the BIOS.
		400, 533 MHz	Desired clock frequency set manually.
DRAM Refresh Rate	Option for setting the DRAM refresh rate.	Auto	DRAM Refresh is read from the SPD data of the DRAM module.
		7.8 μs	Manual setting for the DRAM refresh rate.
		3.9 μs	Manual setting for the DRAM refresh rate.
Memory Hole	Option for ISA cards with frame buffer. Not relevant for an PPC700.	Disabled	Disables this function.
		15MB-16MB	This address area is reserved.
DIMM Thermal Control	Option for setting the maximum surface temperature of the DIMM module. The module is cooled by limiting the memory bandwidth if the defined surface temperature is reached.	Disabled	Surface temperature not limited.
		40°C, 50°C, 60°C, 70°C, 80°C, 85°C, 90°C	Temperature limit value for the limitation.
DT in SPD	Option to determine whether the GMCH (Graphics and Memory Controller Hub) supports DT (Delta Temperature) in the SPD (Serial Presence Detect) Management Algorithm of the DIMM module.	Disabled	Disables this function.
		Enabled	Enables this function.

Table 110: X945 Advanced Chipset setting options

BIOS setting	Meaning	Setting options	Effect
TS on DIMM	Option to determine whether the GMCH (Graphics and Memory Controller Hub) supports TS (Thermal Sensor) in the Thermal Management Algorithm of the DIMM module.	Disabled	Disables this function.
		Enabled	Enables this function.
High Precision Event Timer	The HPET is a timer inside the PC. It is able to trigger an interrupt with a high degree of accuracy, which allows other programs to better synchronize a variety of applications.	Disabled	Disables this function.
		Enabled	Enables this function. This function is recommended for multimedia applications.
IOAPIC	This option is used to activate or deactivate the APIC (Advanced Programmable Interrupt Controller). Information: The IRQ resources available to the system are expanded when the APIC mode is enabled.	Disabled	Disables this function.
		Enabled	The IRQ resources available to the system are expanded when the APIC mode is enabled.
APIC ACPI SCI IRQ	This option is used to modify the SCI IRQ when in APIC (Advanced Programmable Interrupt Controller) mode.	Disabled	IRQ9 is used for SCI.
		Enabled	IRQ20 is used for SCI.
C4 On C3	Fine-tunes the power saving function on an ACPI operating system.	Disabled	Disables this function.
		Enabled	Processor is needed in C4 if the operating system is initiated in a C3 state.

Table 110: X945 Advanced Chipset setting options

1.4.6 I/O interface configuration

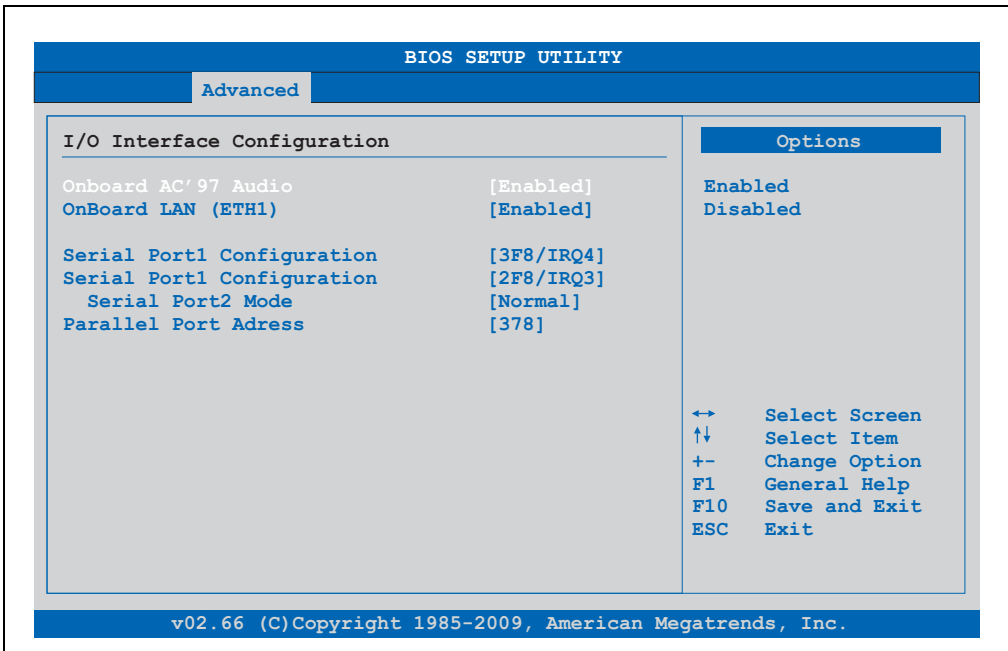

Figure 152: X945 Advanced I/O Interface Configuration

BIOS setting	Meaning	Setting options	Effect
Onboard AC'97 Audio	For turning the AC97 Sound on and off.	Enabled	Enables AC'97 sound.
		Disabled	Disables AC'97 sound.
Onboard LAN (ETH1)	For turning the on-board LAN controller (for ETH1) on and off.	Enabled	Activates the LAN controller or the ETH1 interface.
		Disabled	Deactivates the LAN controller or the ETH1 interface.
Serial port 1 configuration	For the configuration of serial port 1 (COM1).	Disabled	Port 1 deactivated.
		3F8/IRQ4	Assignment of the base I/O address and the interrupt.
		3E8 / IRQ4	Assignment of the base I/O address and the interrupt.
Serial port 2 configuration	For the configuration of serial port 2 (COM1).	Disabled	Port 1 deactivated.
		2F8/IRQ3	Assignment of the base I/O address and the interrupt.
		2E8 / IRQ3	Assignment of the base I/O address and the interrupt.

Table 111: X945 Advanced I/O Interface Configuration setting options

BIOS setting	Meaning	Setting options	Effect
Serial port 2 mode	This option is for setting the serial port B as either a standard interface or as an infrared interface (not currently supported).	Normal	Standard interface.
		IrDA	IrDA interface (compliant serial infrared port).
		ASK IR	Interface for IR devices (amplitude shift keyed infrared port).
Parallel port address	The address of the parallel interface can be defined with this option. Information: Address is automatically set, even if the function is disabled.	Disabled	Deactivates the port.
		378, 278, 3BC	Manual assignment of the port address.

Table 111: X945 Advanced I/O Interface Configuration setting options

1.4.7 Clock Configuration

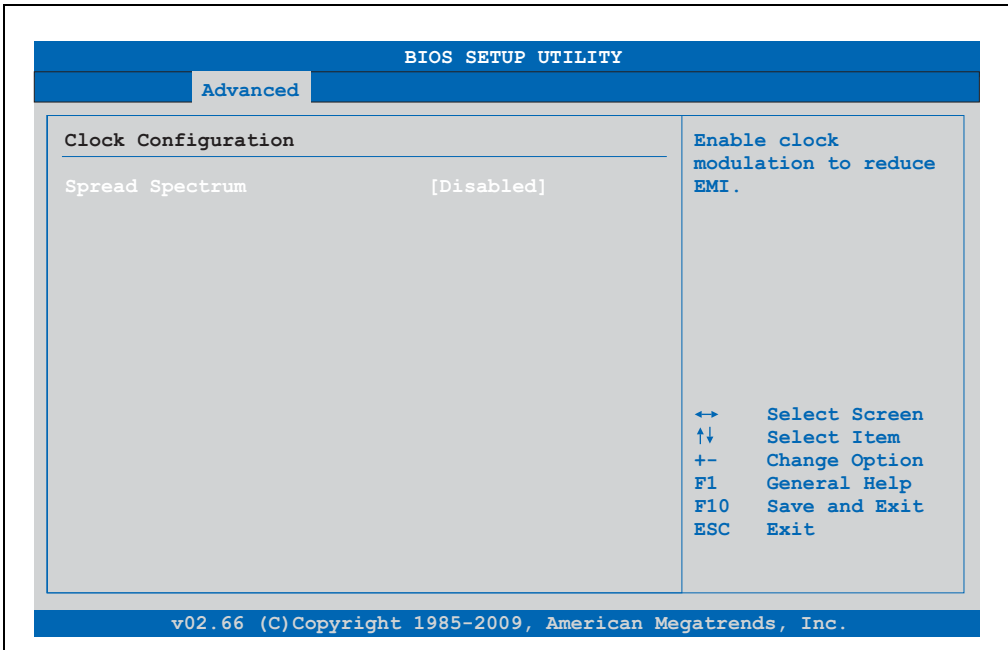

Figure 153: X945 Advanced Clock Configuration

BIOS setting	Meaning	Setting options	Effect
Spread spectrum	With this option, the cycle frequency can be modulated by reducing electromagnetic disturbances.	Enabled	Enables this function.
		Disabled	Disables this function.

Table 112: X945 Advanced Clock Configuration setting options

1.4.8 IDE Configuration

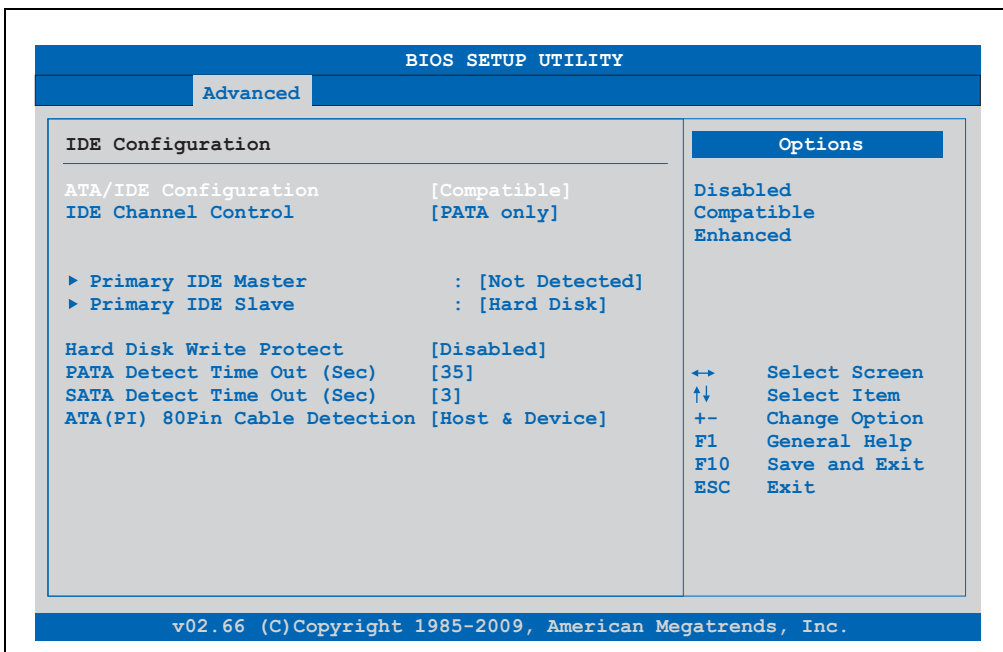

Figure 154: X945 Advanced IDE Configuration

BIOS setting	Meaning	Setting options	Effect
ATA/IDE Configuration	Option for configuring the integrated PATA and SATA controller.	Disabled	Both controllers disabled.
		Compatible	Both controllers run in Legacy or Compatible Mode.
		Enhanced	Both controllers run in Enhanced or Native Mode.
IDE Channel Control ¹⁾	Option for configuring the IDE channels in "Compatible" mode.	SATA only	Only use SATA drives.
		SATA Pri, PATA Sec	SATA drives are address primarily and PATA drive secondarily.
		PATA only ²⁾	Only use PATA drives.
Primary IDE Master	The drive in the system that is connected to the IDE primary master port is configured here.	Enter	Opens the submenu See "Primary IDE Master", on page 270
Primary IDE slave	The drive in the system that is connected to the IDE primary slave port is configured here.	Enter	Opens the submenu See "Primary IDE slave", on page 272
Secondary IDE Master	The drive in the system that is connected to the IDE secondary master port is configured here.	Enter	Opens the submenu

Table 113: X945 Advanced IDE Configuration setting options

BIOS setting	Meaning	Setting options	Effect
Secondary IDE Slave	The drive in the system that is connected to the IDE secondary slave port is configured here.	Enter	Opens the submenu
Third IDE Master³⁾	The drive in the system that is connected to the IDE third master port is configured here.	Enter	Opens the submenu
Third IDE Slave⁴⁾	The drive in the system that is connected to the IDE third slave port is configured here.	Enter	Opens the submenu
Hard disk write protect	Write protection for the hard drive can be enabled/disabled here.	Disabled	Disables this function.
		Enabled	Enables this function.
PATA Detect Time Out (Sec)	Configuring the time overrun limit value for the PATA device identification.	0, 5, 10, 15, 20, 25, 30, 35	Value set manually.
SATA Detect Time Out (Sec)	Configuring the time overrun limit value for the SATA device identification.	0, 1, 2, 3, 5, 10, 15, 30	Value set manually.
ATA(Pi) 80Pin Cable Detection	Detects whether an 80 pin cable is connected to the drive, the controller or to both. Information: This option is not available on the PPC700 CPU board. Therefore this setting is not relevant.	Host & device	Using both IDE controllers (motherboard, disk drive).
		Host	IDE controller motherboard used.
		Device	IDE disk drive controller used.

Table 113: X945 Advanced IDE Configuration setting options

- 1) These settings are only possible if *ATA/IDE Configuration* is set to *Compatible* or *Enhanced*.
- 2) If this setting is enabled and *ATA/IDE Configuration* is set to *Compatible*, then only the submenus *Primary IDE Master* and *Primary IDE Slave* will be shown.
- 3) This submenu is only open if *ATA/IDE Configuration* is set to *Enhanced*.
- 4) This submenu is only open if *ATA/IDE Configuration* is set to *Enhanced*.

Primary IDE Master

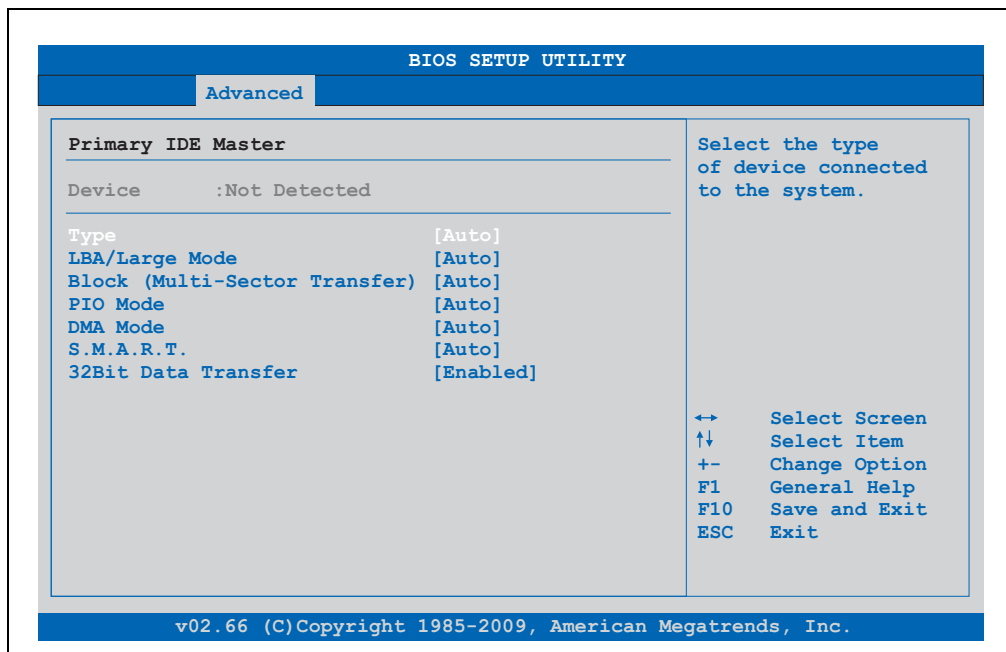

Figure 155: X945 Primary IDE Master

BIOS setting	Meaning	Setting options	Effect
Type	The type of drive connected to the primary master is configured here.	Not installed	No drive installed.
		Auto	Automatic recognition of the drive and setup of appropriate values.
		CD/DVD	CD -/ DVD drive.
		ARMD	ARMD - drive (zip drive)
LBA/Large Mode	This option activates the logical block addressing / large mode for IDE.	Disabled	Disables this function.
		Auto	Automatic enabling of this function when supported by the system.
Block (Multi-Sector Transfer)	This option enables the block mode for IDE hard drives. When this option is enabled, the number of blocks per request from the configuration sector of the hard drive is read.	Disabled	Disables this function.
		Auto	Automatic enabling of this function when supported by the system.

Table 114: X945 Primary IDE Master setting options

BIOS setting	Meaning	Setting options	Effect
PIO Mode	The PIO mode determines the data rate of the hard drive. Information: This option is not available on the PPC700. Therefore this setting is not relevant.	Auto	Automatic configuration of PIO mode.
		0, 1, 2, 3, 4	Manual configuration of PIO mode.
DMA Mode	The data transfer rate to and from the primary master drive is defined here. The DMA mode must be activated in the Windows device manager in order to guarantee maximum performance. Only possible when manually setting up the drive.	Auto	Automatic definition of the transfer rate.
		Disabled	Manual definition of the transfer rate.
S.M.A.R.T.	Monitoring function of modern hard drives (self-monitoring, analysis and reporting technology).	Auto	Automatic detection and enabling.
		Disabled	Disables this function.
		Enabled	Enables this function.
32 Bit Data Transfer	This function enables 32-bit data transfer.	Disabled	Disables this function.
		Enabled	Enables this function.

Table 114: X945 Primary IDE Master setting options (Forts.)

Primary IDE slave

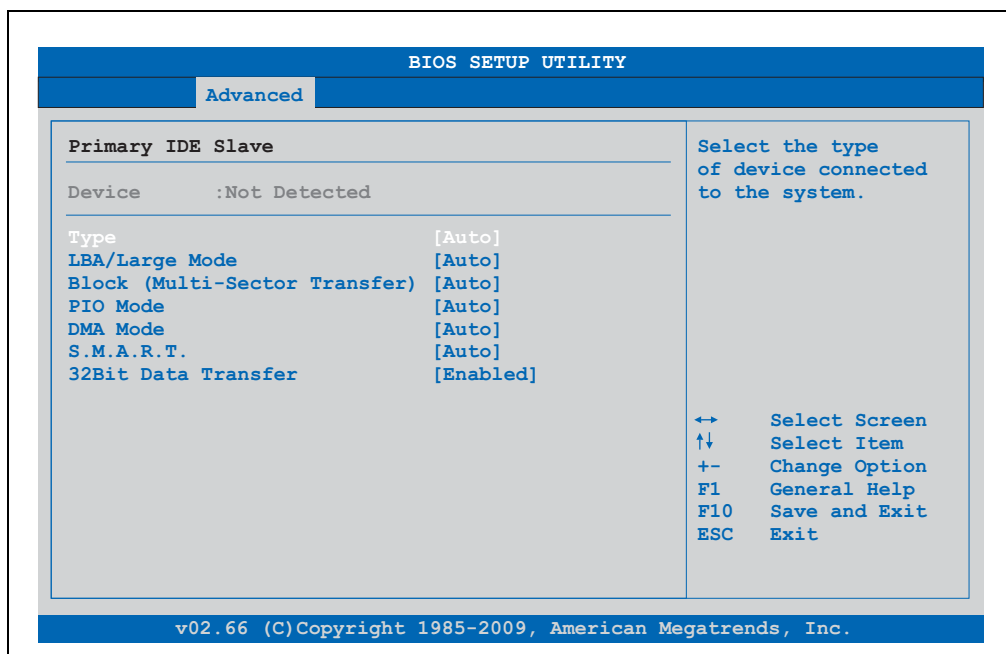

Figure 156: X945 Primary IDE Slave

BIOS setting	Meaning	Setting options	Effect
Type	The type of drive connected to the secondary slave is configured here.	Not installed	No drive installed.
		Auto	Automatic recognition of the drive and setup of appropriate values.
		CD/DVD	CD -/ DVD drive.
		ARMD	ARMD - drive (zip drive)
LBA/Large Mode	This option activates the logical block addressing / large mode for IDE.	Disabled	Disables this function.
		Auto	Automatic enabling of this function when supported by the system.
Block (Multi-Sector Transfer)	This option enables the block mode for IDE hard drives. When this option is enabled, the number of blocks per request from the configuration sector of the hard drive is read.	Disabled	Disables this function.
		Auto	Automatic enabling of this function when supported by the system.

Table 115: X945 Primary IDE Slave setting options

BIOS setting	Meaning	Setting options	Effect
PIO Mode	<p>The PIO mode determines the data rate of the hard drive.</p> <p>Information:</p> <p>This option is not available on the PPC700. Therefore this setting is not relevant.</p>	Auto	Automatic configuration of PIO mode.
		0, 1, 2, 3, 4	Manual configuration of PIO mode.
DMA Mode	<p>The data transfer rate to and from the secondary slave drive is defined here. The DMA mode must be activated in the Windows device manager in order to guarantee maximum performance. Only possible when manually setting up the drive.</p>	Auto	Automatic definition of the transfer rate.
		Disabled	Manual definition of the transfer rate.
S.M.A.R.T.	<p>Monitoring function of modern hard drives (self-monitoring, analysis and reporting technology).</p>	Auto	Automatic detection and enabling.
		Disabled	Disables this function.
		Enabled	Enables this function.
32 Bit Data Transfer	<p>This function enables 32-bit data transfer.</p>	Disabled	Disables this function.
		Enabled	Enables this function.

Table 115: X945 Primary IDE Slave setting options (Forts.)

1.4.9 USB configuration

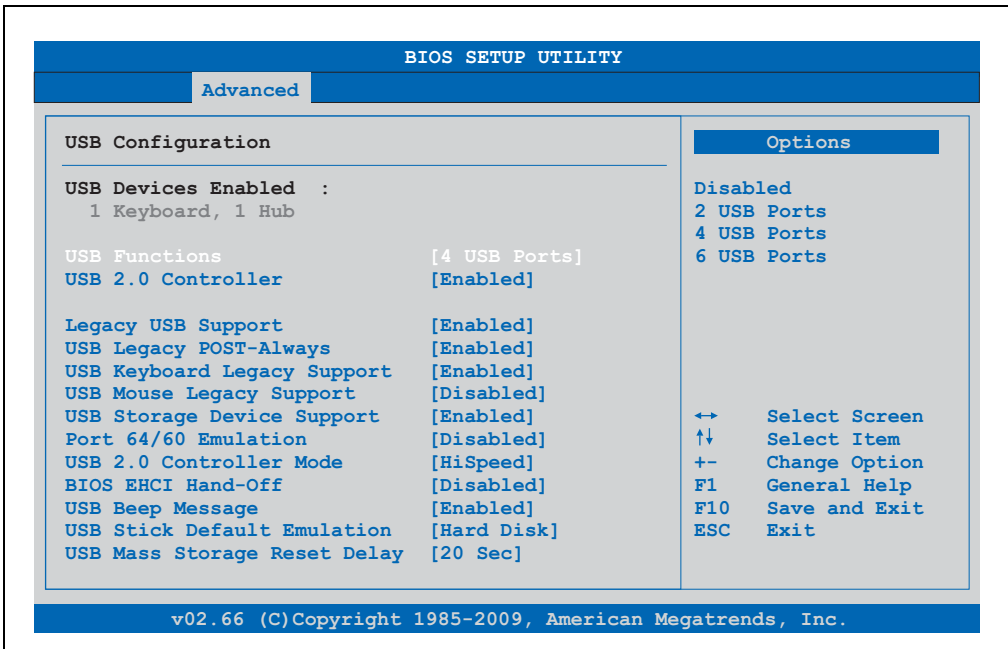

Figure 157: X945 Advanced USB Configuration

BIOS setting	Meaning	Setting options	Effect
USB Function	USB ports can be enabled/disabled here. The USB numbers (e.g. USB1, USB3, etc.) are printed on the PPC700 housing).	Disabled	Disables the USB port.
		2 USB Ports	USB1, USB3 are enabled.
		4 USB Ports	USB1, USB2, USB3, USB4 are enabled.
		6 USB Ports	USB1, USB2, USB3, USB4, USB5 are enabled.
		8 USB Ports	USB1, USB2, USB3, USB4, USB5, USB are enabled on an AP via SDL.
USB 2.0 Controller	Option for enabling or disabling USB 2.0 mode.	Enabled	All USB ports run in USB 2.0 mode.
		Disabled	All USB ports run in USB 1.1 mode.
Legacy USB Support	Legacy USB support can be enabled/disabled here. USB ports do not function during startup. USB is supported again after the operating system has started. A USB keyboard is still recognized during the POST.	Disabled	Disables this function.
		Enabled	Enables this function.
		Auto	Automatic enabling.
USB Legacy POST-Always	Option to enable Legacy USB Support during the POST (Power On Self Test) the same as the Legacy USB Support setting.	Enabled	The BIOS Setup can be called up during the POST using a USB keyboard.
		Disabled	Disables this function.

Table 116: X945 Advanced USB Configuration setting options

BIOS setting	Meaning	Setting options	Effect
USB Keyboard Legacy Support	USB keyboard support can be enabled/disabled here.	Disabled	Disables this function.
		Enabled	Enables this function.
USB Mouse Legacy Support	USB mouse support can be enabled/disabled here.	Disabled	Disables this function.
		Enabled	Enables this function.
USB Storage Device Support	USB storage device support can be enabled/disabled here.	Disabled	Disables this function.
		Enabled	Enables this function.
Port 64/60 Emulation	Port 64/60 emulation can be enabled/disabled here.	Disabled	USB keyboard functions in all systems excluding Windows NT.
		Enabled	USB keyboard functions in Windows NT.
USB 2.0 Controller Mode	Settings can be made for the USB controller.	Full Speed	12 MBps
		Hi Speed	480 MBps
BIOS EHCI Hand-Off	The support for the operating system can be set up without the fully automatic EHCI function.	Disabled	Disables the function
		Enabled	Enables this function.
USB Beep Message	Option for outputting a tone each time a USB device is detected by the BIOS during the POST.	Disabled	Disables this function.
		Enabled	Enables this function.
USB Stick Default Emulation	You can set how the USB device is to be used.	Auto	USB devices with fewer than 530MB of memory are simulated as floppy disk drives and devices with larger capacities are simulated as hard drives.
		Hard disk	An HDD-formatted drive can be used as an FDD (e.g. zip drive) for starting the system.
USB Mass Storage Reset Delay	<p>The waiting time that the USB device POST requires after the device start command can be set.</p> <p>Information:</p> <p>The message "No USB mass storage device detected" is displayed if no USB memory device has been installed.</p>	10 Sec, 20 Sec, 30 Sec, 40 Sec	Value set manually.

Table 116: X945 Advanced USB Configuration setting options (Forts.)

1.4.10 Keyboard/mouse configuration

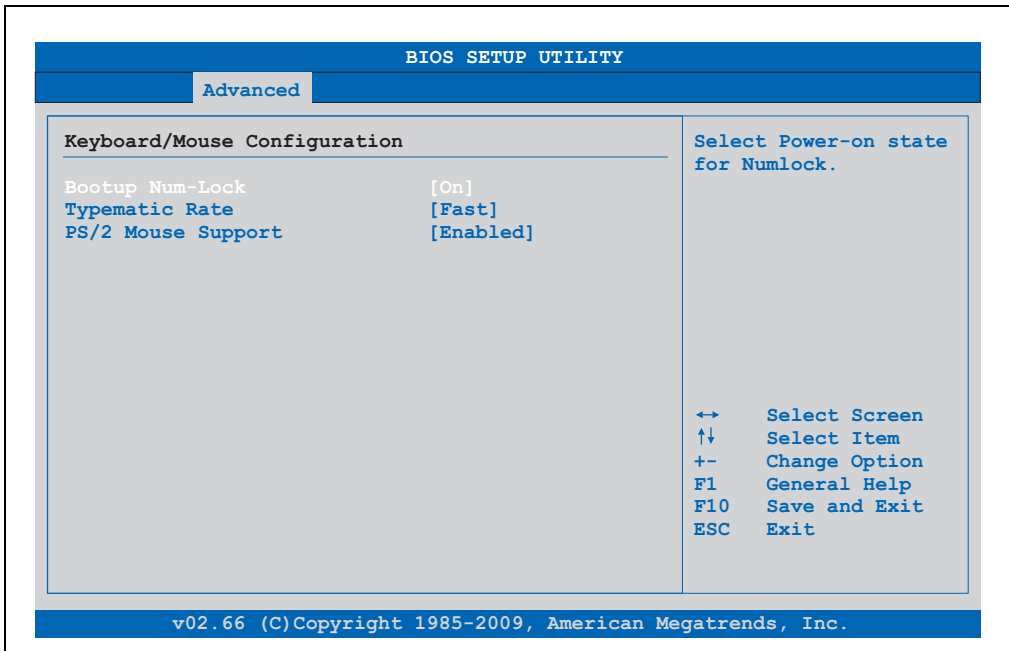

Figure 158: X945 Advanced Keyboard/Mouse Configuration

BIOS setting	Meaning	Setting options	Effect
Boot-up Num-lock	This option sets the status of the numeric keypad when the the system is booted.	Off	Only the cursor functions of the numerical keypad are enabled.
		On	Numeric keypad is enabled.
Typematic rate	The key repeat function is set here.	Slow	Slow key repeat.
		Fast	Fast key repeat.
PS/2 mouse support	Sets whether the PS/2 mouse port should be activated.	Disabled	Disables this function.
		Enabled	Enables this function.
		Auto	Automatic activation of the function if PS/2 mouse port is supported.

Table 117: X945 Advanced Keyboard/Mouse Configuration setting options

1.4.11 Remote access configuration

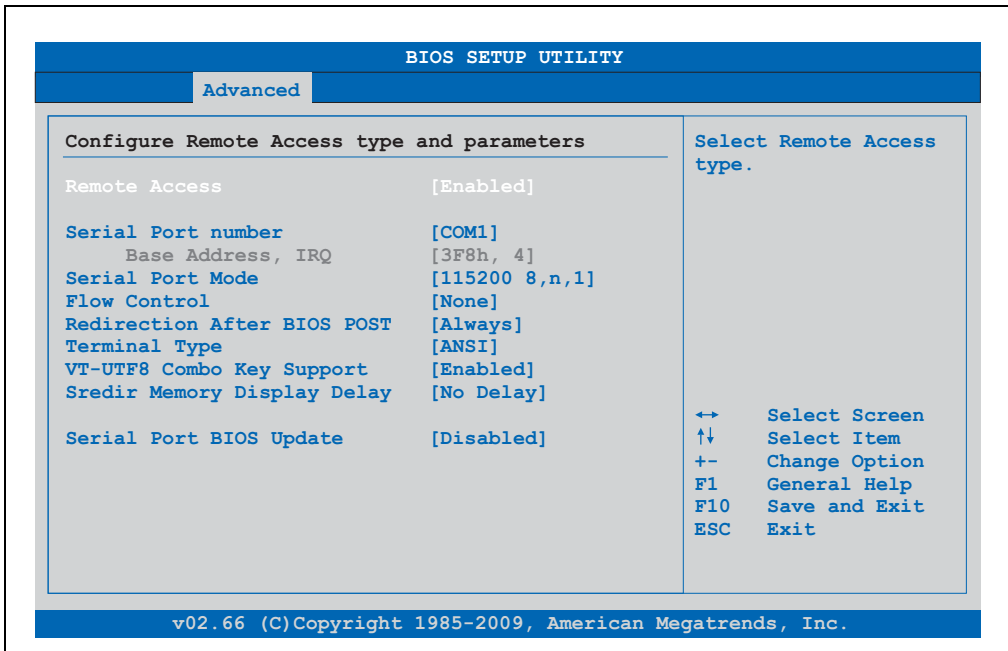

Figure 159: X945 Advanced Remote Access Configuration

BIOS setting	Meaning	Setting options	Effect
Remote access	The remote access function can be enabled/disabled here.	Disabled	Disables this function.
		Enabled	Enables this function.
Serial port number	The serial interface can be set using this option, as long as disabled is not entered in the <i>remote access</i> field.	COM1	Enables the COM1 interface as remote access interface.
		COM2	Enables the COM2 interface as remote access interface.
Base address, IRQ	Serial connection display for the logical address and interrupt, as long as disabled is not entered in the <i>remote access</i> field.	None	-
Serial port mode	The serial interface transfer rate is defined here, as long as disabled is not entered in the <i>remote access</i> field.	115200 8,n,1 57600 8,n,1 38400 8,n,1 19200 8,n,1 09600 8,n,1	Value set manually.
Flow control	This setting determines how the transfer is controlled via the interface. Information: The setting must be the same on the terminal and the server.	None	The interface is operated without transfer control.
		Hardware	The interface transfer control is carried out through hardware. This mode must be supported by a cable.
		Software	The interface transfer control is carried out through software.

Table 118: X945 Advanced Remote Access Configuration setting options

Software • BIOS options

BIOS setting	Meaning	Setting options	Effect
Redirection after BIOS POST	The redirection after start up can be set here, as long as disabled is not entered in the <i>remote access</i> field.	Disabled	The redirection is switched off after start up.
		Boot loader	Redirection is enabled during system start up and charging.
		Always	Redirection is always enabled.
Terminal type	The type of connection can be chosen here, as long as disabled is not entered in the <i>remote access</i> field.	ANSI, VT100, VT-UTF8	Manual configuration of the connection type.
VT-UTF8 Combo Key Support	With this option, the VT-UTF8 Combo Key Support for the ANSI and VT100 connections can be enabled, as long as disabled is not entered in the <i>remote access</i> field.	Disabled	Disables this function.
		Enabled	Enables this function.
Sredir Memory Display Delay	The memory output delay can be set using this option, as long as disabled is not entered in the <i>remote access</i> field (Sredir -> serial redirection).	No delay	No delay.
		Delay 1 sec, Delay 2 sec, Delay 4 sec	Value set manually.
Serial port BIOS update	During system start up, the update is loaded via the serial interface in the processor. Information: If this option is disabled, the boot time is reduced.	Disabled	Disables this function.
		Enabled	Enables this function.

Table 118: X945 Advanced Remote Access Configuration setting options (Forts.)

1.4.12 CPU board monitor

Information:

The displayed voltage values (e.g. core voltage, battery voltage) on this BIOS Setup page represent uncalibrated information values. These cannot be used to draw any conclusions about any hardware alarms or error conditions. The hardware components used have automatic diagnostics functions that can be applied in the event of error.

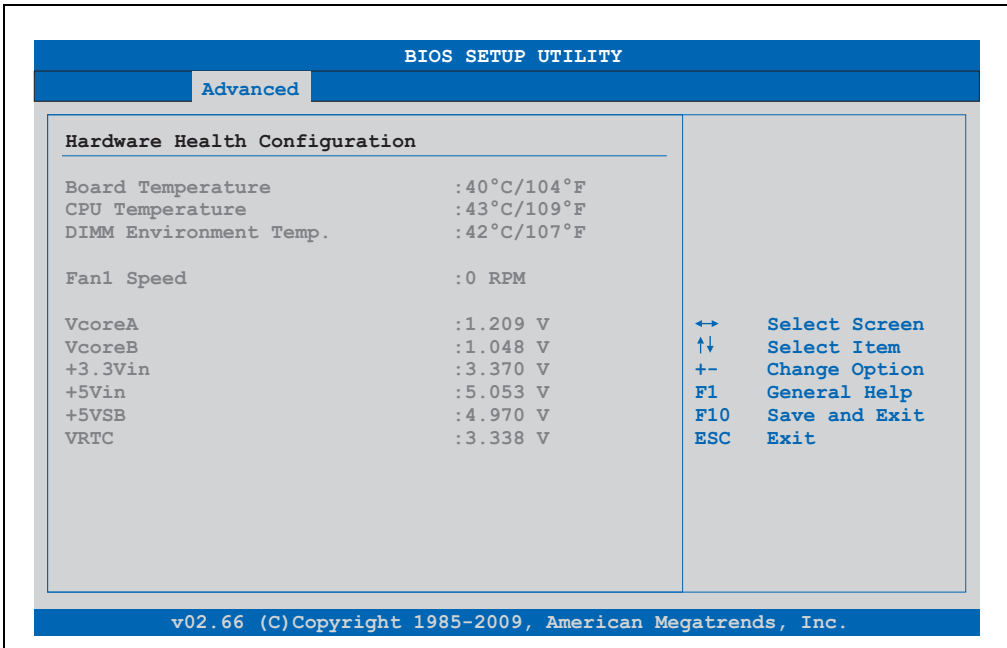

Figure 160: X945 Advanced CPU board monitor

BIOS setting	Meaning	Setting options	Effect
Board temperature	Displays the board temperature in degrees Celsius and Fahrenheit.	None	-
CPU temperature	Displays the processor's temperature (in degrees Celsius and Fahrenheit).	None	-
DIMM Environment Temp.	Displays the temperature of the DRAM module.	None	-
Fan1 Speed	Displays the rotating speed of the processor fan.	None	-
VcoreA	Displays the processor's core voltage A in volts.	None	-

Table 119: X945 Advanced Remote Access Configuration setting options

Software • BIOS options

BIOS setting	Meaning	Setting options	Effect
VcoreB	Displays the DDR's core voltage B in volts.	None	-
+3.3Vin	Displays the current voltage of the 3.3 volt supply.	None	-
+5Vin	Displays the current voltage of the 5 volt supply.	None	-
+5VSB	Displays the current level of the jumper.	None	-
VRTC	Displays the battery voltage (in volts).	None	-

Table 119: X945 Advanced Remote Access Configuration setting options (Forts.)

1.4.13 Main Board/Panel Features

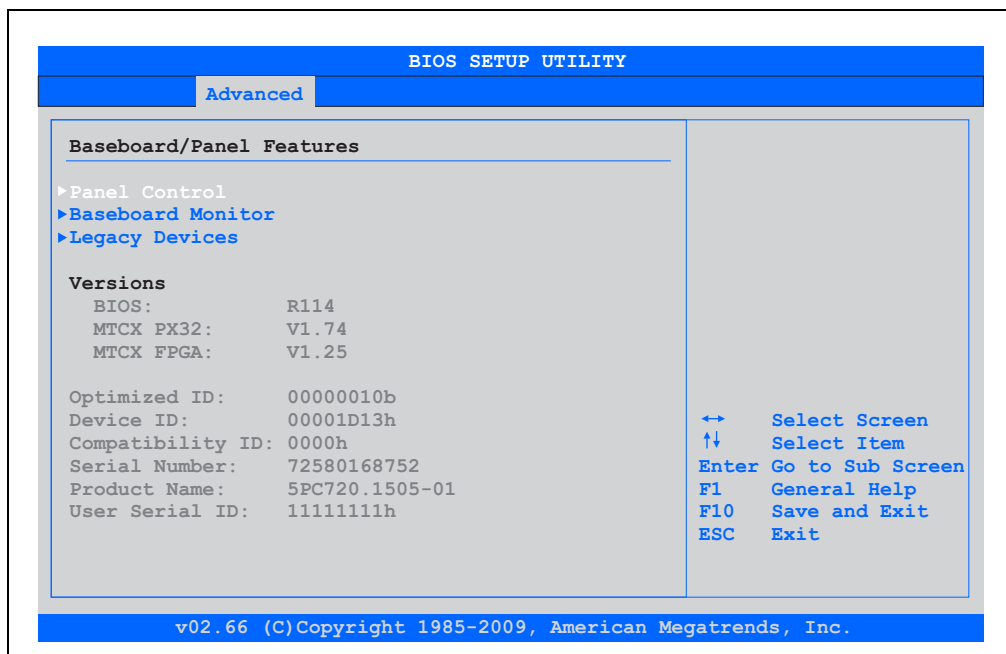

Figure 161: X945 Advanced Baseboard/Panel Features

BIOS setting	Meaning	Setting options	Effect
Panel control	For special setup of connected panels (display units).	Enter	Opens the submenu See "Panel control", on page 282
Baseboard monitor	Display of various temperatures and fan speeds.	Enter	Opens the submenu See "Baseboard monitor", on page 283
Legacy devices	Special settings for the interface can be changed here.	Enter	Opens the submenu See "Legacy devices", on page 284
BIOS	Displays the BIOS version.	None	-

Table 120: X945 Advanced Baseboard/Panel Features setting options

BIOS setting	Meaning	Setting options	Effect
MTCX PX32	Displays the MTCX PX32 firmware version.	None	-
MTCX FPGA	Displays the MTCX FPGA firmware version.	None	-
Optimized ID	Displays the DIP switch setting of the configuration switch.	None	-
Device ID	Displays the hexadecimal value of the hardware device ID.	None	-
Compatibility ID	Displays the version of the device within the same B&R device code. This ID is needed for Automation Runtime.	None	-
Serial number	Displays the B&R serial number.	None	-
Product name	Displays the B&R model number.	None	-
User serial ID	Displays the user serial ID. This 8 digit hex value can be freely assigned by the user (e.g. to give the device a unique ID) and can only be changed with using the "B&R Control Center" via the ADI driver.	None	-

Table 120: X945 Advanced Baseboard/Panel Features setting options (Forts.)

Panel control

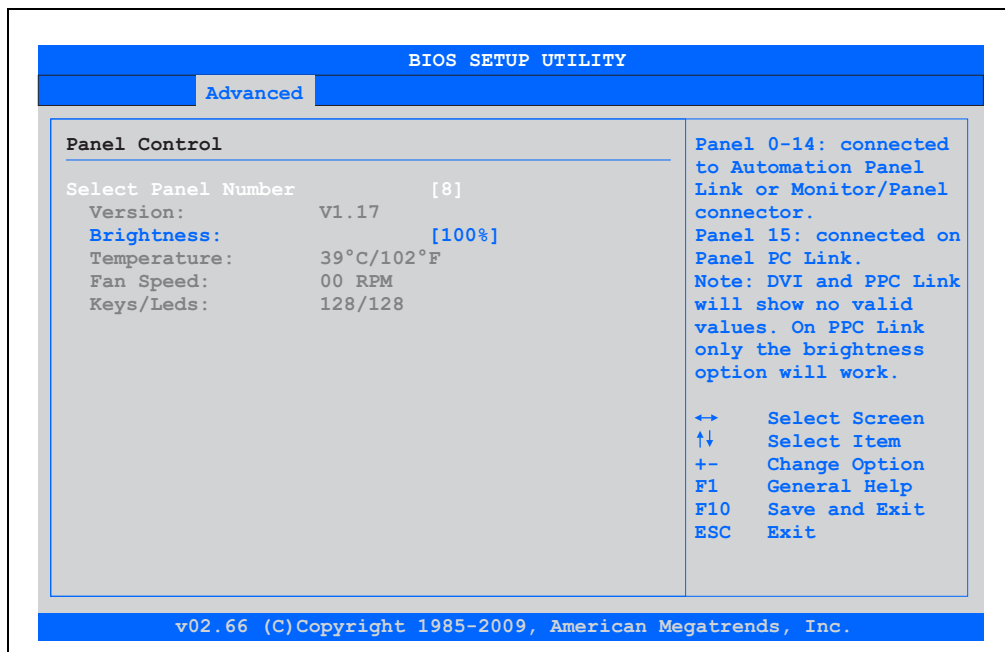

Figure 162: X945 Panel Control

BIOS setting	Meaning	Setting options	Effect
Select panel number	Selection of the panel number for which the values should be read out and/or changed.	0..15	Selection of panel 0 ... 15. Panel 15 is specifically intended for panel PC 700 systems.
Version	Displays the firmware version of the SDLR controller.	None	-
Brightness	For setting the brightness of the selected panel.	0%, 10%, 20%, 30%, 40%, 50%, 60%, 70%, 80%, 90%, 100%	For setting the brightness (in %) of the selected panel. Changes take effect after saving and restarting the system (e.g. by pressing <F10>).
Temperature	Displays the selected panel's temperature (in degrees Celsius and Fahrenheit).	None	-
Fan speed	Displays fan speed for the selected panel.	None	-
Keys/LEDs	Displays the available keys and LEDs on the selected panel.	None	-

Table 121: X945 Panel Control setting options

Baseboard monitor

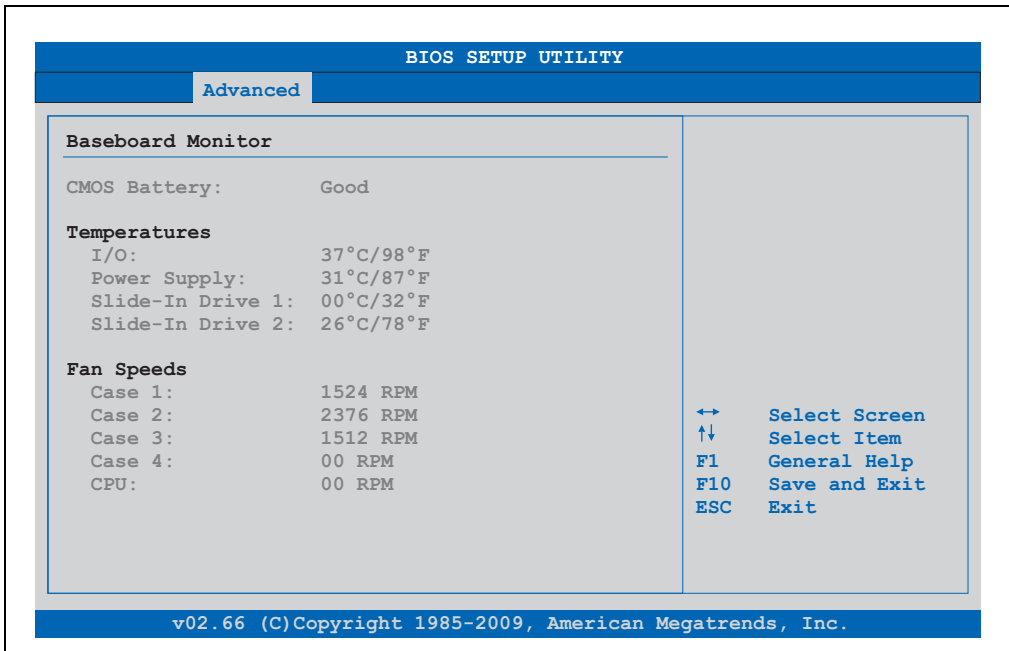

Figure 163: X945 Baseboard Monitor

BIOS setting	Meaning	Setting options	Effect
CMOS battery	Displays the battery status. n.a. - not available Good - Battery is OK Bad - Battery is damaged.	None	-
I/O	Displays the temperature in the I/O area in degrees Celsius and Fahrenheit.	None	-
Power supply	Displays the temperature in the power supply in degrees Celsius and Fahrenheit.	None	-
Slide-in drive 1	Displays the temperature of the slide-in drive 1 in degrees Celsius and Fahrenheit.	None	-
Slide-in drive 2	Displays the temperature of the slide-in drive 2 in degrees Celsius and Fahrenheit.	None	-
Case 1	Displays the fan speed of housing fan 1.	None	-
Case 2	Displays the fan speed of housing fan 2.	None	-
Case 3	Displays the fan speed of housing fan 3.	None	-
Case 4	Displays the fan speed of housing fan 4.	None	-
CPU	Displays the rotational speed of the CPU fan.	None	-

Table 122: X945 Baseboard Monitor setting options

Legacy devices

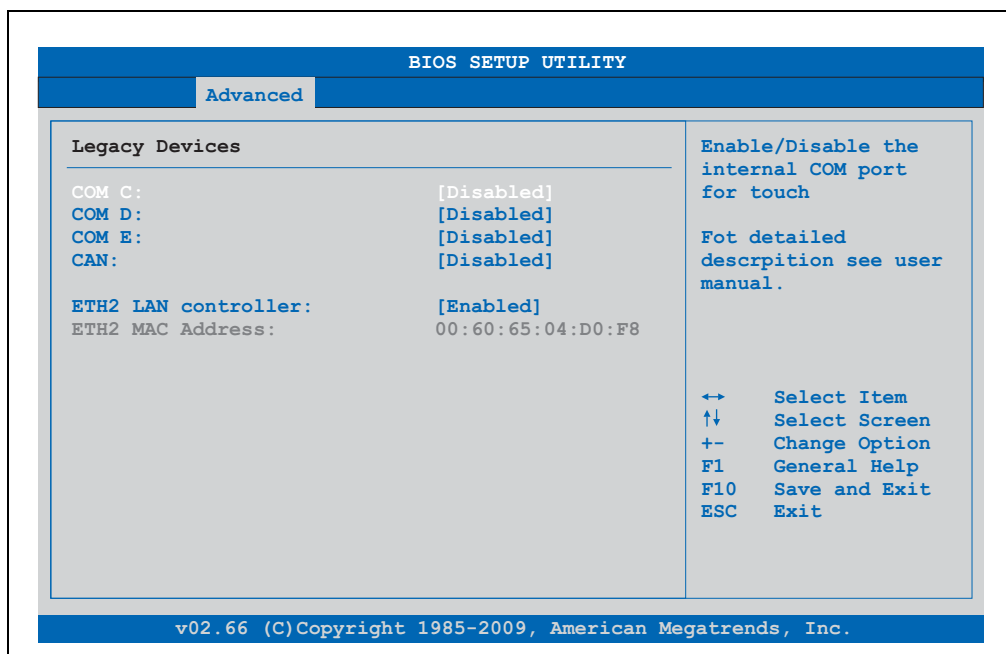

Figure 164: X945 Legacy Devices

BIOS setting	Meaning	Setting options	Effect
COM C	Setting of the COM port for the touch screen on the monitor/panel connector.	Disabled	Disables the interface.
		Enabled	Enables the interface.
Base I/O address	Selection of the base I/O address for the COM port.	238, 2E8, 328, 338, 3E8	Selected base I/O address is assigned.
Interrupt	Selection of the interrupt for the COM port.	IRQ 5, IRQ 6, IRQ 7, IRQ 10, IRQ 11	Selected interrupt is assigned.
COM D	Setting of the COM port for the touch screen on the AP Link connector.	Disabled	Disables the interface.
		Enabled	Enables the interface.
Base I/O address	Selection of the base I/O address for the COM port.	238, 2E8, 328, 338, 3E8	Selected base I/O address is assigned.
Interrupt	Selection of the interrupt for the COM port.	IRQ 5, IRQ 6, IRQ 7, IRQ 10, IRQ 11	Selected interrupt is assigned.
COM E	Configuration of the COM port on the B&R add-on interface 5AC600.485I-00 (IF option).	Disabled	Disables the interface.
		Enabled	Enables the interface.
Base I/O address	Selection of the base I/O address for the COM port.	238, 2E8, 328, 338, 3E8	Selected base I/O address is assigned.

Table 123: X945 Legacy Devices setting options

BIOS setting	Meaning	Setting options	Effect
Interrupt	Selection of the interrupt for the COM port.	IRQ 5, IRQ 6, IRQ 7, IRQ 10, IRQ 11	Selected interrupt is assigned.
CAN	Configuration of the CAN port of the B&R add-on CAN interface card 5AC600.CANI-00 (IF option).	Disabled	Disables the interface.
		Enabled	Enables the interface.
Base I/O address	Selection of the base I/O address for the CAN port.	None	-
Interrupt	Selection of the interrupt for the CAN port.	IRQ 10, NMI	Selected interrupt is assigned.
ETH2 LAN controller	For turning the onboard LAN controller (ETH2) on and off.	Disabled	Disables the controller.
		Enabled	Enables the controller.
ETH2 MAC Address	Displays the Ethernet 2 controller MAC address.	None	-

Table 123: X945 Legacy Devices setting options (Forts.)

1.5 Boot

BIOS SETUP UTILITY

Main Advanced **Boot** Security Power Exit

Boot Priority Selection [Type Based]

Boot Device Priority

1st Boot Device	[Primary Master]
2nd Boot Device	[Primary Slave]
3rd Boot Device	[USB Floppy]
4th Boot Device	[USB Removable Devi]
5th Boot Device	[USB Harddisk]
6th Boot Device	[USB CDROM]
7th Boot Device	[Disabled]
8th Boot Device	[Disabled]

Boot Settings Configuration

Quick Boot	[Enabled]
Quiet Boot	[Disabled]
Automatic Boot List Retry	[Disabled]
AddOn ROM Display Mode	[Keep Current]
Halt On Error	[Disabled]
Hit 'DEL' Message Display	[Enabled]
Interrupt 19 Capture	[Disabled]
PXE Boot to LAN (ETH1)	[Disabled]
Power Loss Control	[Turn On]

↔ Select Screen
 ↑↓ Select Item
 + Change Option
 F1 General Help
 F10 Save and Exit
 ESC Exit

v02.66 (C) Copyright 1985-2009, American Megatrends, Inc.

Figure 165: X945 Boot Menu

Software • BIOS options

BIOS setting	Meaning	Setting options	Effect
Boot Priority Selection	The method for when the drives should be booted can be set here.	Device Based	Only the devices that are recognized by the system are listed. The sequence of this list can be changed.
		Type Based	The boot sequence of a device type list can be changed. Device types that are not connected can also be entered to this list.
1st Boot Device	The boot drives can be set using this option.	Disabled, Primary Master, Primary Slave, Secondary Master, Secondary Slave, Legacy Floppy, USB Floppy, USB Hard disk, USB CDROM, USB Removable Device, Onboard LAN, External LAN, PCI Mass Storage, PCI SCSI Card, Any PCI BEV Device, Third Master, Third Slave, PCI RAID, Local BEV ROM	Select the desired sequence.
2nd Boot Device			
3rd Boot Device			
4th Boot Device			
5th Boot Device			
6th Boot Device			
7th Boot Device			
8th Boot Device			
Quick Boot	This function reduces the boot time by skipping some POST procedures.	Disabled	Disables this function.
		Enabled	Enables this function.
Quiet Boot	Determines if POST message or OEM logo (default = black background) is displayed.	Disabled	POST message display.
		Enabled	OEM logo display instead of POST message.
Automatic Boot List Retry	With this option, the operating system attempts to automatically restart following startup failure.	Disabled	Disables this function.
		Enabled	Enables this function.
Add-On ROM Display Mode	Sets the display mode for the ROM (during the booting procedure).	Force BIOS	An additional BIOS part can be displayed.
		Keep Current	BIOS information is displayed.
Halt On Error	This option sets whether the system should pause the Power On Self Test (POST) when it encounters an error.	Disabled	The system does not pause. All errors are ignored.
		Enabled	The system pauses. The system pauses every time an error is encountered.
Hit 'DEL' Message Display	Settings can be made here for the "Hit 'DEL' Message" display. Information: When quiet boot is activated the message is not displayed.	Disabled	The message is not displayed.
		Enabled	The message is displayed.
Interrupt 19 Capture	This function can be used to incorporate the BIOS interrupt.	Disabled	Disables this function.
		Enabled	Enables this function.
PXE boot to LAN (ETH1)	Enables/disables the function to boot from LAN (ETH1).	Disabled	Disables this function.
		Enabled	Enables this function.
Power Loss Control	Determines if the system is on/off following power loss.	Remain Off	Remains off.
		Turn On	Powers on.
		Last State	Enables the previous state.

Table 124: X945 Boot Menu setting options

1.6 Security

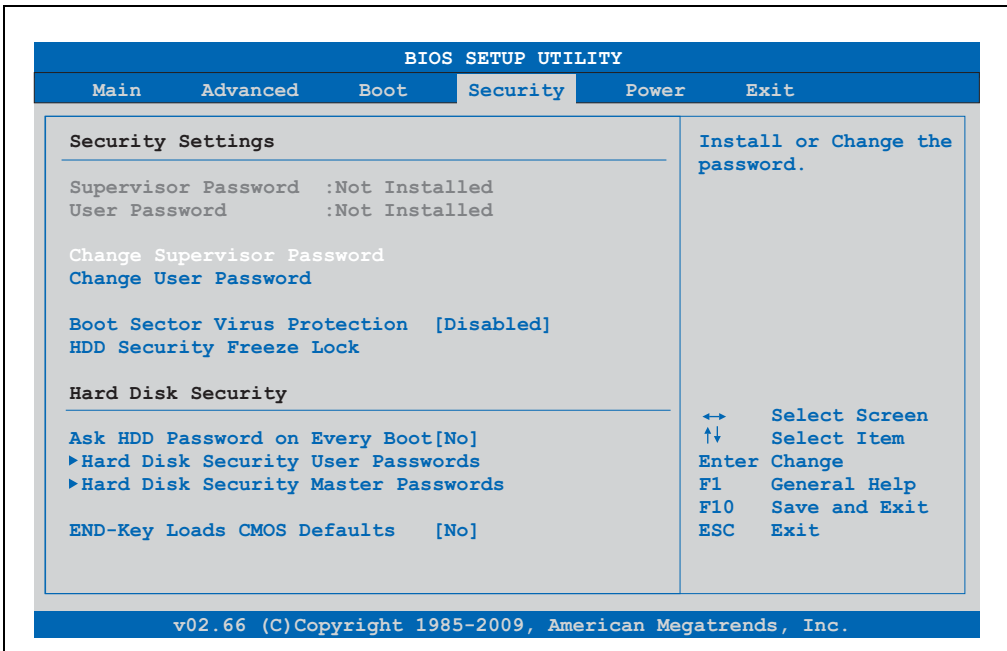

Figure 166: X945 Security Menu

BIOS setting	Meaning	Setting options	Effect
Supervisor Password	Displays whether or not a supervisor password has been set.	None	-
User Password	Displays whether or not a user password has been set.	None	-
Change Supervisor Password	To enter/change a supervisor password. A supervisor password is necessary to edit all BIOS settings.	Enter	Enter password.
Change User Password	To enter/change a user password. A user password allows the user to edit only certain BIOS settings.	Enter	Enter password.
Boot Sector Virus Protection	With this option, a warning is issued when the boot sector is accessed through a program or virus. Information: With this option, only the boot sector is protected, not the entire hard drive.	Disabled	Disables this function.
		Enabled	Enables this function.

Table 125: X945 Security Menu setting options

BIOS setting	Meaning	Setting options	Effect
HDD Security Freeze Lock	This option can be used to define whether the BIOS sends the HDD Security Freeze Lock command to every connected hard disk that supports the Security command. This prevents the setting or changing of a hard disk password after the POST.	Disabled	Deactivates this function.
		Enabled	Activates this function.
Ask HDD Password on Every Boot	This function can be used to select whether the hard disk password must be entered each time the system boots. Information: Can only be used if a hard disk user password has been created.	Yes	Deactivates this function.
		No	Activates this function.
Hard Disk Security User Passwords	The hard disk security user password can be created here.	Enter	Opens the submenu See "Hard disk security user password", on page 288
Hard Disk Security Master Passwords	The hard disk security master password can be created here.	Enter	Opens the submenu See "Hard disk security master password", on page 289
End-Key Load CMOS Defaults	Using this function, CMOS can be loaded by pressing the END key during POST.	No	Disables this function.
		Yes	Enables this function.

Table 125: X945 Security Menu setting options (Forts.)

1.6.1 Hard disk security user password

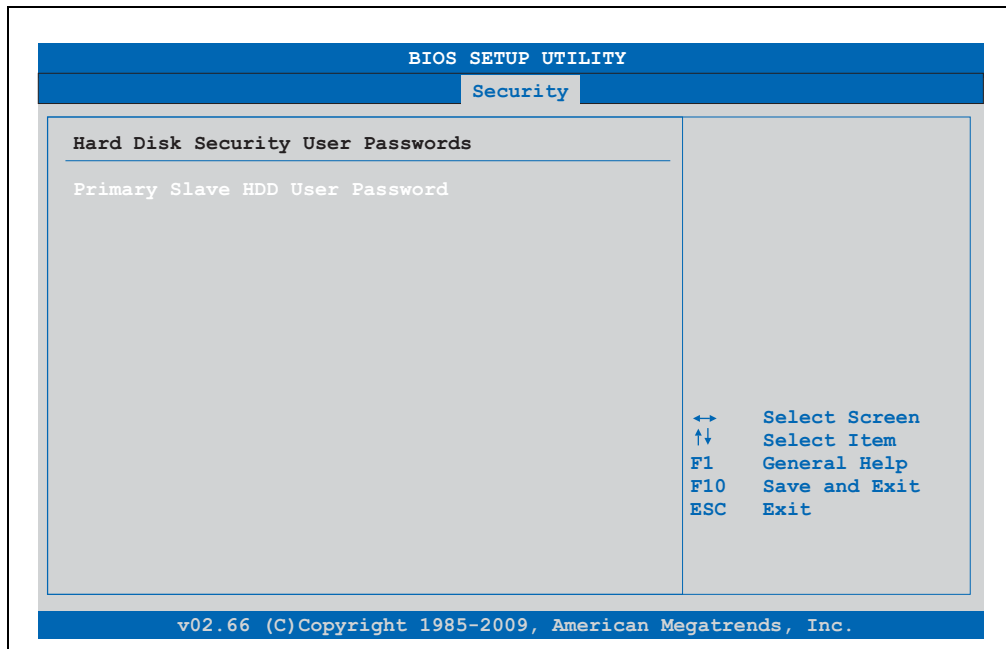

Figure 167: X945 Hard Disk Security User Password

BIOS setting	Meaning	Setting options	Effect
Primary slave HDD user password	This function makes it possible to use the user password to change or configure each hard drive without having to reboot the device. A user password allows the user to edit only certain BIOS settings.	Enter	Enter password.

Table 126: X945 Hard Disk Security User Password

1.6.2 Hard disk security master password

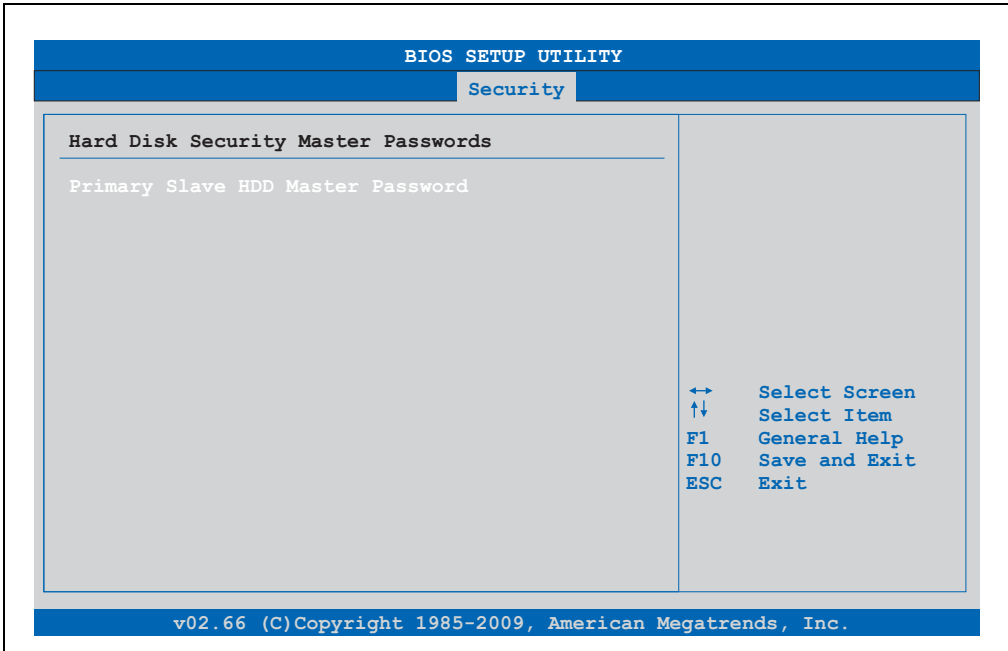

Figure 168: X945 Hard Disk Security Master Password

BIOS setting	Meaning	Setting options	Effect
Primary Slave HDD Master Password	This function makes it possible to use the user password to change or configure each hard drive without having to reboot the device.	Enter	Enter password.

Table 127: X945 Hard Disk Security Master Password

1.7 Power

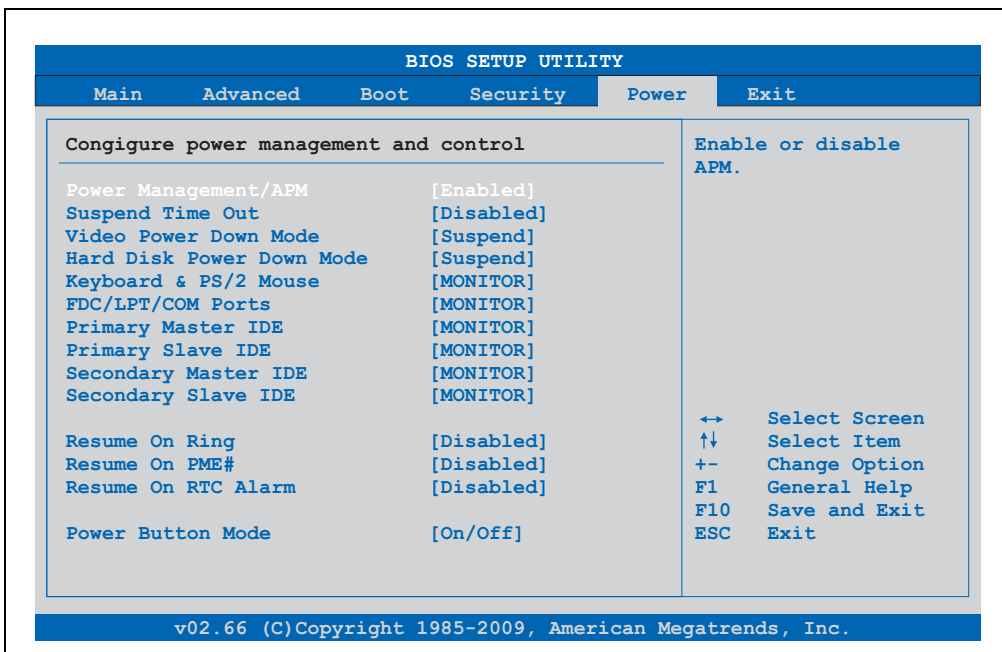

Figure 169: X945 Power Menu

BIOS setting	Meaning	Setting options	Effect
Power Management/APM	This option switches the APM function on or off. This is an advanced plug & play and power management functionality.	Disabled	Disables this function.
		Enabled	Enables this function.
Suspend Time Out	Using this option, you can configure how long the system stays inactive (all components but the CPU are shut off, if possible) before entering suspend mode.	Disabled	Disables this function.
		1 Min, 2 Min, 4 Min, 8 Min, 10 Min, 20 Min, 30 Min, 40 Min, 50 Min, 60 Min;	Value set manually.
Video Power Down Mode	This option allows you to set the energy saving mode for the monitor.	Disabled	Do not switch off the monitor.
		Standby	Monitor goes to standby mode.
		Suspend	Monitor goes to suspend mode.
Hard Disk Power Down Mode	This option allows you to set the energy saving mode for the hard drive.	Disabled	Do not switch off the hard drive.
		Standby	Monitor goes to standby mode.
		Suspend	Hard drive goes to suspend mode.
Keyboard & PS/2 Mouse	The monitoring of activities during power saving mode is determined here.	MONITOR	Keyboard or PS/2 mouse activities return the system to its normal state from a particular energy saving mode.
		IGNORE	Activities are ignored.

Table 128: X945 Power Menu setting options

BIOS setting	Meaning	Setting options	Effect
FDC/LPT/COM ports	The monitoring of activities during power saving mode is determined here.	MONITOR	Activity on the parallel port, the serial 1&2 port, or the floppy port returns the system to its normal state from an energy saving mode.
		IGNORE	Activities are ignored.
Primary Master IDE	The monitoring of activities during power saving mode is determined here.	MONITOR	Activities in the IRQ of specific connections or devices return the system to its normal state from power saving mode.
		IGNORE	Activities are ignored.
Primary Slave IDE	The monitoring of activities during power saving mode is determined here.	MONITOR	Activities in the IRQ of specific connections or devices return the system to its normal state from power saving mode.
		IGNORE	Activities are ignored.
Secondary Master IDE	The monitoring of activities during power saving mode is determined here.	MONITOR	Activities in the IRQ of specific connections or devices return the system to its normal state from power saving mode.
		IGNORE	Activities are ignored.
Secondary Slave IDE	The monitoring of activities during power saving mode is determined here.	MONITOR	Activities in the IRQ of specific connections or devices return the system to its normal state from power saving mode.
		IGNORE	Activities are ignored.
Resume On Ring	When the modem receives an incoming call, the PC is brought out of power saving mode.	Disabled	Disables this function.
		Enabled	Enables this function.
Resume on PME#	With this option, you can switch the PME wakeup function on or off.	Disabled	Disables this function.
		Enabled	Enables this function.
Resume On RTC Alarm	With this option, you can activate the alarm and enter the date and time for the system start.	Disabled	Disables this function.
		Enabled	Enables this function.
Power Button Mode	This function determines the function of the power button.	On/Off	Power button switches on/off.
		Suspend	Suppresses the function.

Table 128: X945 Power Menu setting options (Forts.)

1.8 Exit

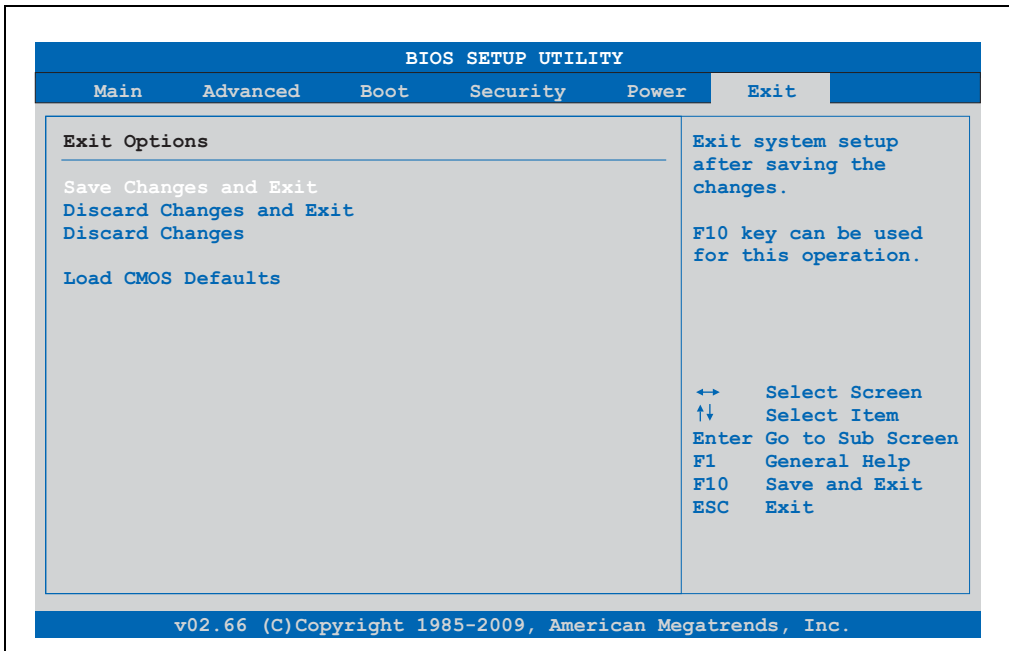

Figure 170: X945 Exit Menu

BIOS setting	Meaning	Setting options	Effect
Save Changes and Exit	BIOS setup is closed with this item. Changes made are saved in CMOS after confirmation, and the system is rebooted.	OK / Cancel	
Discard Changes and Exit	With this item you can close BIOS setup without saving the changes made. The system is then rebooted.	OK / Cancel	
Discard Changes	In the event that settings were made which the user can no longer remember, changes can be reset as long as they haven't been saved.	OK / Cancel	
Load CMOS Defaults	This item loads the CMOS default values, which are defined by the DIP switch settings. These settings are loaded for all BIOS configurations.	OK / Cancel	

Table 129: X945 Exit Menu setting options

1.9 BIOS default settings

If the function "load setup defaults" is chosen in the main BIOS setup menu, or if exit is selected (or <F9> is pressed) in the individual setup screens, the following BIOS default settings are the optimized values that will be used.

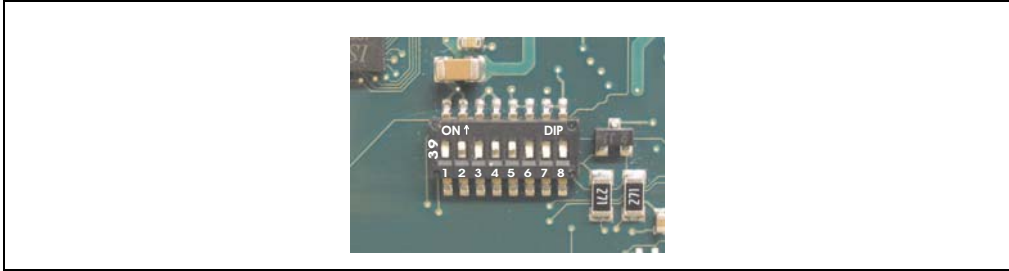

Figure 171: CMOS profile hex switch

Information:

The switch position that is set upon delivery represents the optimum BIOS default values for this system and should therefore not be changed.

The first six DIP switches (1-6) are used to set the profiles. The rest (7,8) are reserved.

Profile number	Optimized for	DIP switch setting							
		1	2	3	4	5	6	7 ¹⁾	8 ¹⁾
Profile 0	Automation PC 620 system units 5PC600.SX01-00.	Off	Off	Off	Off	Off	Off	-	-
Profile 1	Reserved	On	Off	Off	Off	Off	Off	-	-
Profile 2	Automation PC 620 system units 5PC600.SX02-00, 5PC600.SX02-01, 5PC600.SF03-00, 5PC600.SX05-00 and 5PC600.SX05-01.	Off	On	Off	Off	Off	Off	-	-
Profile 3	Panel PC 700 system unit 5PC720.1043-00, 5PC720.1214-00, 5PC720.1505-00, 5PC720.1706-00, 5PC720.1906-00, 5PC781.1043-00, 5PC781.1505-00 and 5PC782.1043-00.	On	On	Off	Off	Off	Off	-	-
Profile 4	Panel PC 700 system unit 5PC720.1043-01, 5PC720.1214-01, 5PC720.1505-01 and 5PC720.1505-02.	Off	Off	On	Off	Off	Off	-	-
Profile 5	Automation PC 620 embedded system units 5PC600.SE00-00 und 5PC600.SE00-01.	On	Off	On	Off	Off	Off	-	-
Profile 6	Panel PC 700 system unit 5PC725.1505-00	Off	On	On	Off	Off	Off	-	-

Table 130: Profile overview

1) Reserved.

The following pages provide an overview of the BIOS default settings for the different DIP switch position. Settings highlighted in yellow are variations from the BIOS default profile (=profile 1).

1.9.1 Main

Setting / View	Profile 0	Profile 1	Profile 2	Profile 3	Profile 4	Profile 5	Profile 6	My setting
System Time	-	-	-	-	-	-	-	
System Date	-	-	-	-	-	-	-	
BIOS ID	-	-	-	-	-	-	-	
Processor	-	-	-	-	-	-	-	
CPU Frequency	-	-	-	-	-	-	-	
System Memory	-	-	-	-	-	-	-	
Product Revision	-	-	-	-	-	-	-	
Serial number	-	-	-	-	-	-	-	
BC Firmware Rev.	-	-	-	-	-	-	-	
MAC Address (ETH1)	-	-	-	-	-	-	-	
Boot Counter	-	-	-	-	-	-	-	
Running Time	-	-	-	-	-	-	-	

Table 131: X945 - Main profile setting overview

1.9.2 Advanced

ACPI configuration

Setting / View	Profile 0	Profile 1	Profile 2	Profile 3	Profile 4	Profile 5	Profile 6	My setting
ACPI Aware O/S	Yes	Yes	Yes	Yes	Yes	Yes	Yes	
ACPI Version Features	ACPI v2.0	ACPI v2.0	ACPI v2.0	ACPI v2.0	ACPI v2.0	ACPI v2.0	ACPI v2.0	
ACPI APIC support	Enabled	Enabled	Enabled	Enabled	Enabled	Enabled	Enabled	
Suspend mode	S1 (POS)	S1 (POS)	S1 (POS)	S1 (POS)	S1 (POS)	S1 (POS)	S1 (POS)	
USB Device Wakeup from S3/S4	Disabled	Disabled	Disabled	Disabled	Disabled	Disabled	Disabled	
Active Cooling Trip Point	Disabled	Disabled	Disabled	Disabled	Disabled	Disabled	Disabled	
Passive Cooling Trip Point	Disabled	Disabled	Disabled	Disabled	Disabled	Disabled	Disabled	
Critical Trip Point	105°C	105°C	105°C	105°C	105°C	105°C	105°C	

Table 132: X945 Advanced - ACPI Configuration profile setting overview

PCI Configuration

Setting / View	Profile 0	Profile 1	Profile 2	Profile 3	Profile 4	Profile 5	Profile 6	My setting
Plug & Play O/S	Yes	No	Yes	Yes	Yes	Yes	Yes	
PCI Latency Timer	64	64	64	64	64	64	64	
Allocate IRQ to PCI VGA	Yes	Yes	Yes	Yes	Yes	Yes	Yes	
Allocate IRQ to SMBUS HC	Yes	Yes	Yes	Yes	Yes	Yes	Yes	
PCI IRQ Resource Exclusion								
IRQ3	Allocated	Allocated	Allocated	Allocated	Allocated	Allocated	Allocated	
IRQ4	Allocated	Allocated	Allocated	Allocated	Allocated	Allocated	Allocated	
IRQ5	Available	Available	Available	Available	Available	Allocated	Available	
IRQ6	Available	Available	Available	Available	Available	Allocated	Available	
IRQ7	Available	Available	Available	Available	Available	Allocated	Available	
IRQ9	Allocated	Allocated	Allocated	Allocated	Allocated	Allocated	Allocated	
IRQ10	Available	Available	Available	Available	Available	Available	Available	
IRQ11	Available	Allocated	Available	Allocated	Allocated	Available	Available	
IRQ12	Available	Allocated	Available	Available	Available	Available	Available	
IRQ14	Allocated	Allocated	Allocated	Allocated	Allocated	Allocated	Allocated	
IRQ15	Available	Available	Available	Available	Available	Available	Available	
PCI Interrupt Routing								
PIRQ A (VGA)	Auto	Auto	Auto	Auto	Auto	Auto	Auto	
PIRQ B (AC97,INTD)	Auto	Auto	Auto	Auto	Auto	7	Auto	
PIRQ C (PATA,INTC)	Auto	Auto	Auto	Auto	Auto	Auto	Auto	
PIRQ D (SATA,UHCI1,SMB)	Auto	Auto	Auto	Auto	Auto	Auto	Auto	
PIRQ E (ETH1)	Auto	Auto	Auto	Auto	Auto	Auto	Auto	
PIRQ F (INTA,ETH2)	Auto	Auto	Auto	Auto	Auto	5	Auto	
PIRQ G (INTB)	Auto	Auto	Auto	Auto	Auto	6	Auto	
PIRQ H (UHCI0,EHCI)	Auto	Auto	Auto	Auto	Auto	Auto	Auto	
1st Exclusive PCI	-	-	-	-	-	5	-	
2nd Exclusive PCI	-	-	-	-	-	6	-	
3rd Exclusive PCI	-	-	-	-	-	7	-	

Table 133: X945 Advanced - PCI Configuration Profile setting overview

Graphics configuration

Setting / View	Profile 0	Profile 1	Profile 2	Profile 3	Profile 4	Profile 5	Profile 6	My setting
Primary Video Device	Internal VGA	Internal VGA	Internal VGA	Internal VGA	Internal VGA	Internal VGA	Internal VGA	
Internal Graphics Mode Select	Enabled, 8MB	Enabled, 8MB	Enabled, 8MB	Enabled, 8MB	Enabled, 8MB	Enabled, 8MB	Enabled, 8MB	
DVMT Mode Select	DVMT Mode	DVMT Mode	DVMT Mode	DVMT Mode	DVMT Mode	DVMT Mode	DVMT Mode	
DVMT/FIXED Memory	128MB	128MB	128MB	128MB	128MB	128MB	128MB	
Boot Display Device	Auto	Auto	Auto	Auto	Auto	Auto	Auto	
Always Try Auto Panel Detect	No	No	No	No	No	No	No	
Local Flat Panel Type	Auto	Auto	Auto	Auto	Auto	Auto	Auto	
Local flat panel scaling	Expand Text & Graphics	Expand Text & Graphics	Expand Text & Graphics	Expand Text & Graphics	Expand Text & Graphics	Expand Text & Graphics	Expand Text & Graphics	
Display Mode Persistence	Enabled	Enabled	Enabled	Enabled	Enabled	Enabled	Enabled	

Table 134: X945 Advanced - Graphics Configuration Profile setting overview

CPU configuration

Setting / View	Profile 0	Profile 1	Profile 2	Profile 3	Profile 4	Profile 5	Profile 6	My setting
Module Version	-	-	-	-	-	-	-	
Manufacturer	-	-	-	-	-	-	-	
Frequency	-	-	-	-	-	-	-	
FSB speed	-	-	-	-	-	-	-	
L1 cache	-	-	-	-	-	-	-	
L2 cache	-	-	-	-	-	-	-	
Ratio Actual Value	-	-	-	-	-	-	-	
MPS Revision	1.4	1.4	1.4	1.4	1.4	1.4	1.4	
Max CPUID value limit	Disabled	Disabled	Disabled	Disabled	Disabled	Disabled	Disabled	
Execute-Disable Bit Capability	Enabled	Enabled	Enabled	Enabled	Enabled	Enabled	Enabled	
Hyper Threading Technology	Enabled	Enabled	Enabled	Enabled	Enabled	Enabled	Enabled	
Intel(R) SpeedStep (tm) tech	Enabled	Enabled	Enabled	Enabled	Enabled	Enabled	Enabled	
Boot CPU Speed On AC	Maximum	Maximum	Maximum	Maximum	Maximum	Maximum	Maximum	
Intel(R) C-STATE tech	Disabled	Disabled	Disabled	Disabled	Disabled	Disabled	Disabled	
Enhanced C-States	Disabled	Disabled	Disabled	Disabled	Disabled	Disabled	Disabled	

Table 135: X945 Advanced - CPU Configuration Profile setting overview

Chipset configuration

Setting / View	Profile 0	Profile 1	Profile 2	Profile 3	Profile 4	Profile 5	Profile 6	My setting
DRAM Frequency	Auto	Auto	Auto	Auto	Auto	Auto	Auto	
DRAM Refresh Rate	Auto	Auto	Auto	Auto	Auto	Auto	Auto	
Memory Hole	Disabled	Disabled	Disabled	Disabled	Disabled	Disabled	Disabled	
DIMM Thermal Control	Disabled	Disabled	Disabled	Disabled	Disabled	Disabled	Disabled	
DT in SPD	Disabled	Disabled	Disabled	Disabled	Disabled	Disabled	Disabled	
TS on DIMM	Disabled	Disabled	Disabled	Disabled	Disabled	Disabled	Disabled	
High Precision Event Timer	Disabled	Disabled	Disabled	Disabled	Disabled	Disabled	Disabled	
IOAPIC	Enabled	Enabled	Enabled	Enabled	Enabled	Enabled	Enabled	
APIC ACPI SCI IRQ	Disabled	Disabled	Disabled	Disabled	Disabled	Disabled	Disabled	
C4 On C3	Disabled	Disabled	Disabled	Disabled	Disabled	Disabled	Disabled	

Table 136: X945 Advanced - Chipset Configuration Profile setting overview

I/O interface configuration

Setting / View	Profile 0	Profile 1	Profile 2	Profile 3	Profile 4	Profile 5	Profile 6	My setting
Onboard AC'97 Audio	Enabled	Enabled	Enabled	Enabled	Enabled	Disabled	Disabled	
Onboard LAN (ETH1)	Enabled	Enabled	Enabled	Enabled	Enabled	Enabled	Enabled	
Serial port 1 configuration	3F8/IRQ4	3F8/IRQ4	3F8/IRQ4	3F8/IRQ4	3F8/IRQ4	3F8/IRQ4	Disabled	
Serial port 2 configuration	2F8/IRQ3	2F8/IRQ3	2F8/IRQ3	2F8/IRQ3	2F8/IRQ3	2F8/IRQ3	2F8/IRQ3	
Serial port 2 mode	Normal	Normal	Normal	Normal	Normal	Normal	Normal	
Parallel port address	378	378	378	378	378	378	Disabled	

Table 137: X945 Advanced - I/O Interface Configuration profile setting overview

Clock Configuration

Setting / View	Profile 0	Profile 1	Profile 2	Profile 3	Profile 4	Profile 5	Profile 6	My setting
Spread spectrum	Disabled	Disabled	Disabled	Disabled	Disabled	Disabled	Disabled	

Table 138: X945 Advanced - Clock Configuration Profile setting overview

IDE Configuration

Setting / View	Profile 0	Profile 1	Profile 2	Profile 3	Profile 4	Profile 5	Profile 6	My setting
ATA/IDE Configuration	Compatible	Compatible	Compatible	Compatible	Compatible	Compatible	Compatible	
Legacy IDE Channels	PATA Only	PATA Only	PATA Only	PATA Only	PATA Only	PATA Only	PATA Only	
Hard disk write protect	Disabled	Disabled	Disabled	Disabled	Disabled	Disabled	Disabled	
PATA Detect Time Out (Sec)	35	35	35	35	35	35	35	

Table 139: X945 Advanced - IDE Configuration Profile setting overview

Software • BIOS options

Setting / View	Profile 0	Profile 1	Profile 2	Profile 3	Profile 4	Profile 5	Profile 6	My setting
SATA Detect Time Out (Sec)	3	3	3	3	3	3	3	
ATA(PI) 80Pin Cable Detection	Host & device	Host & device	Host & device	Host & device	Host & device	Host & device	Host & device	
Primary IDE Master								
Type	Auto	Auto	Auto	Auto	Auto	Auto	Auto	
LBA/Large Mode	Auto	Auto	Auto	Auto	Auto	Auto	Auto	
Block (Multi-Sector Transfer)	Auto	Auto	Auto	Auto	Auto	Auto	Auto	
PIO Mode	Auto	Auto	Auto	Auto	Auto	Auto	Auto	
DMA Mode	Auto	Auto	Auto	Auto	Auto	Auto	Auto	
S.M.A.R.T.	Auto	Auto	Auto	Auto	Auto	Auto	Auto	
32Bit data transfer	Enabled	Enabled	Enabled	Enabled	Enabled	Enabled	Enabled	
Primary IDE slave								
Type	Auto	Auto	Auto	Auto	Auto	Auto	Auto	
LBA/Large Mode	Auto	Auto	Auto	Auto	Auto	Auto	Auto	
Block (Multi-Sector Transfer)	Auto	Auto	Auto	Auto	Auto	Auto	Auto	
PIO Mode	Auto	Auto	Auto	Auto	Auto	Auto	Auto	
DMA Mode	Auto	Auto	Auto	Auto	Auto	Auto	Auto	
S.M.A.R.T.	Auto	Auto	Auto	Auto	Auto	Auto	Auto	
32Bit data transfer	Enabled	Enabled	Enabled	Enabled	Enabled	Enabled	Enabled	

Table 139: X945 Advanced - IDE Configuration Profile setting overview (Forts.)

USB configuration

Setting / View	Profile 0	Profile 1	Profile 2	Profile 3	Profile 4	Profile 5	Profile 6	My setting
USB Function	4 USB Ports	4 USB Ports	4 USB Ports	4 USB Ports	4 USB Ports	6 USB Ports	4 USB Ports	
USB 2.0 Controller	Enabled	Enabled	Enabled	Enabled	Enabled	Enabled	Enabled	
Legacy USB Support	Enabled	Enabled	Enabled	Enabled	Enabled	Enabled	Enabled	
USB Legacy POST-Always	Enabled	Enabled	Enabled	Enabled	Enabled	Enabled	Enabled	
USB Keyboard Legacy Support	Enabled	Enabled	Enabled	Enabled	Enabled	Enabled	Enabled	
USB Mouse Legacy Support	Disabled	Disabled	Disabled	Disabled	Disabled	Disabled	Disabled	
USB Storage Device Support	Enabled	Enabled	Enabled	Enabled	Enabled	Enabled	Enabled	
Port 64/60 Emulation	Disabled	Disabled	Disabled	Disabled	Disabled	Disabled	Disabled	
USB 2.0 Controller Mode	HiSpeed	HiSpeed	HiSpeed	HiSpeed	HiSpeed	HiSpeed	HiSpeed	

Table 140: X945 Advanced - USB Configuration Profile setting overview

Setting / View	Profile 0	Profile 1	Profile 2	Profile 3	Profile 4	Profile 5	Profile 6	My setting
BIOS EHCI Hand-Off	Disabled	Disabled	Disabled	Disabled	Disabled	Disabled	Disabled	
USB Beep Message	Enabled	Enabled	Enabled	Enabled	Enabled	Enabled	Enabled	
USB Stick Default Emulation	Hard disk	Hard disk	Hard disk	Hard disk	Hard disk	Hard disk	Hard disk	
USB Mass Storage Reset Delay	20 Sec	20 Sec	20 Sec	20 Sec	20 Sec	20 Sec	20 Sec	

Table 140: X945 Advanced - USB Configuration Profile setting overview (Forts.)

Keyboard/mouse configuration

Setting / View	Profile 0	Profile 1	Profile 2	Profile 3	Profile 4	Profile 5	Profile 6	My setting
Boot-up Num-lock	On	On	On	On	On	On	On	
Typematic rate	Fast	Fast	Fast	Fast	Fast	Fast	Fast	
PS/2 mouse support	Disabled	Enabled	Disabled	Disabled	Disabled	Disabled	Disabled	

Table 141: X945 Advanced Keyboard/Mouse Configuration profile setting overview

Remote access configuration

Setting / View	Profile 0	Profile 1	Profile 2	Profile 3	Profile 4	Profile 5	Profile 6	My setting
Remote access	Disabled	Disabled	Disabled	Disabled	Disabled	Disabled	Disabled	
Serial port BIOS update	Disabled	Disabled	Disabled	Disabled	Disabled	Disabled	Disabled	

Table 142: X945 Advanced Remote Access Configuration profile setting overview

CPU board monitor

Setting / View	Profile 0	Profile 1	Profile 2	Profile 3	Profile 4	Profile 5	Profile 6	My setting
Board temperature	-	-	-	-	-	-	-	
CPU temperature	-	-	-	-	-	-	-	
DIMM Environment Temp.	-	-	-	-	-	-	-	
Fan1 Speed	-	-	-	-	-	-	-	
VcoreA	-	-	-	-	-	-	-	
VcoreB	-	-	-	-	-	-	-	
+3.3Vin	-	-	-	-	-	-	-	
+5Vin	-	-	-	-	-	-	-	
+5VSB	-	-	-	-	-	-	-	
VRTC	-	-	-	-	-	-	-	

Table 143: X945 Advanced CPU board monitor profile setting overview

Main Board/Panel Features

Setting / View	Profile 0	Profile 1	Profile 2	Profile 3	Profile 4	Profile 5	Profile 6	My setting
BIOS	-	-	-	-	-	-	-	
MTCX PX32	-	-	-	-	-	-	-	
MTCX FPGA	-	-	-	-	-	-	-	
Optimized ID	-	-	-	-	-	-	-	
Device ID	-	-	-	-	-	-	-	
Compatibility ID	-	-	-	-	-	-	-	
Serial number	-	-	-	-	-	-	-	
Product name	-	-	-	-	-	-	-	
User serial ID	-	-	-	-	-	-	-	
Panel control								
Select panel number	-	-	-	-	-	-	-	
Version	-	-	-	-	-	-	-	
Brightness	100%	100%	100%	100%	100%	100%	100%	
Temperature	-	-	-	-	-	-	-	
Fan speed	-	-	-	-	-	-	-	
Keys/LEDs	-	-	-	-	-	-	-	
Baseboard monitor								
CMOS battery	-	-	-	-	-	-	-	
I/O	-	-	-	-	-	-	-	
Power supply	-	-	-	-	-	-	-	
Slide-in drive 1	-	-	-	-	-	-	-	
Slide-in drive 2	-	-	-	-	-	-	-	
Case 1	-	-	-	-	-	-	-	
Case 2	-	-	-	-	-	-	-	
Case 3	-	-	-	-	-	-	-	
Case 4	-	-	-	-	-	-	-	
CPU	-	-	-	-	-	-	-	
Legacy devices								
COM C	Disabled	Enabled	Disabled	Enabled	Enabled	Disabled	Enabled	
Base I/O address	-	3E8	-	3E8	3E8	-	3E8	
Interrupt	-	11	-	11	11	-	11	
COM D	Disabled	Disabled	Disabled	Disabled	Disabled	Disabled	Disabled	
Base I/O address	-	-	-	-	-	-	-	
Interrupt	-	-	-	-	-	-	-	
COM E	Disabled	Disabled	Disabled	Disabled	Disabled	Disabled	Disabled	
Base I/O address	-	-	-	-	-	-	-	

Table 144: X945 Advanced - Baseboard/Panel Features profile setting overview

Setting / View	Profile 0	Profile 1	Profile 2	Profile 3	Profile 4	Profile 5	Profile 6	My setting
BIOS	-	-	-	-	-	-	-	
MTCX PX32	-	-	-	-	-	-	-	
MTCX FPGA	-	-	-	-	-	-	-	
Optimized ID	-	-	-	-	-	-	-	
Device ID	-	-	-	-	-	-	-	
Compatibility ID	-	-	-	-	-	-	-	
Serial number	-	-	-	-	-	-	-	
Product name	-	-	-	-	-	-	-	
User serial ID	-	-	-	-	-	-	-	
Interrupt	-	-	-	-	-	-	-	
CAN	Disabled	Disabled	Disabled	Disabled	Disabled	Disabled	Disabled	
Base I/O address	-	-	-	-	-	-	-	
Interrupt	-	-	-	-	-	-	-	
ETH2 LAN Controller	Enabled	Enabled	Enabled	Enabled	Enabled	Enabled	Enabled	
ETH2 MAC Address	-	-	-	-	-	-	-	

Table 144: X945 Advanced - Baseboard/Panel Features profile setting overview (Forts.)

1.9.3 Boot

Setting / View	Profile 0	Profile 1	Profile 2	Profile 3	Profile 4	Profile 5	Profile 6	My setting
Boot Priority Selection	Type Based	Type Based	Type Based	Type Based	Type Based	Type Based	Type Based	
1st Boot Device	Primary master	Onboard LAN	Primary master	Primary master	Primary master	Primary master	Primary master	
2nd Boot Device	Primary slave	Primary master	Primary slave	Primary slave	Primary slave	Primary slave	Primary slave	
3rd Boot Device	USB floppy	Primary slave	USB floppy	USB floppy	USB floppy	USB floppy	USB floppy	
4th Boot Device	USB removable device	USB floppy	USB removable device	USB removable device	USB removable device	USB removable device	USB removable device	
5th Boot Device	USB hard disk	USB removable device	USB hard disk	USB hard disk	USB hard disk	USB hard disk	USB hard disk	
6th Boot Device	USB CDROM	USB HDD	USB CDROM	USB CDROM	USB CDROM	USB CDROM	USB CDROM	
7th Boot Device	Disabled	Disabled	Disabled	Disabled	Disabled	Disabled	Disabled	
8th Boot Device	Disabled	Disabled	Disabled	Disabled	Disabled	Disabled	Disabled	
Quick Boot	Enabled	Enabled	Enabled	Enabled	Enabled	Enabled	Enabled	
Quiet Boot	Disabled	Disabled	Disabled	Disabled	Disabled	Disabled	Disabled	
Automatic Boot List Retry	Disabled	Disabled	Disabled	Disabled	Disabled	Disabled	Disabled	

Table 145: X945 Boot profile setting overview

Software • BIOS options

Setting / View	Profile 0	Profile 1	Profile 2	Profile 3	Profile 4	Profile 5	Profile 6	My setting
Add-On ROM Display Mode	Keep Current	Keep Current	Keep Current	Keep Current	Keep Current	Keep Current	Keep Current	
Halt On Error	Disabled	Disabled	Disabled	Disabled	Disabled	Disabled	Disabled	
Hit "DEL" Message Display	Enabled	Enabled	Enabled	Enabled	Enabled	Enabled	Enabled	
Interrupt 19 Capture	Disabled	Disabled	Disabled	Disabled	Disabled	Disabled	Disabled	
PXE Boot to LAN	Disabled	Enabled	Disabled	Disabled	Disabled	Disabled	Disabled	
Power Loss Control	Turn On	Turn On	Turn On	Turn On	Turn On	Turn On	Turn On	

Table 145: X945 Boot profile setting overview

1.9.4 Security

Setting / View	Profile 0	Profile 1	Profile 2	Profile 3	Profile 4	Profile 5	Profile 6	My setting
Supervisor Password	-	-	-	-	-	-	-	
User Password	-	-	-	-	-	-	-	
Boot Sector Virus Protection	Disabled	Disabled	Disabled	Disabled	Disabled	Disabled	Disabled	
HDD Security Freeze Lock	Enabled	Enabled	Enabled	Enabled	Enabled	Enabled	Enabled	
Ask HDD Password on Every Boot	No	No	No	No	No	No	No	
Hard disk security user password	-	-	-	-	-	-	-	
Hard disk security master password	-	-	-	-	-	-	-	
END-key loads CMOS defaults	No	No	No	No	No	No	No	

Table 146: X945 Security profile setting overview

1.9.5 Power

Setting / View	Profile 0	Profile 1	Profile 2	Profile 3	Profile 4	Profile 5	Profile 6	My setting
Power Management/APM	Enabled	Enabled	Enabled	Enabled	Enabled	Enabled	Enabled	
Suspend Time Out	Disabled	Disabled	Disabled	Disabled	Disabled	Disabled	Disabled	
Video Power Down Mode	Suspend	Suspend	Suspend	Suspend	Suspend	Suspend	Suspend	
Hard Disk Power Down Mode	Suspend	Suspend	Suspend	Suspend	Suspend	Suspend	Suspend	
Keyboard & PS/2 Mouse	MONITOR	MONITOR	MONITOR	MONITOR	MONITOR	MONITOR	MONITOR	
FDC/LPT/COM ports	MONITOR	MONITOR	MONITOR	MONITOR	MONITOR	MONITOR	MONITOR	
Primary Master IDE	MONITOR	MONITOR	MONITOR	MONITOR	MONITOR	MONITOR	MONITOR	
Primary Slave IDE	MONITOR	MONITOR	MONITOR	MONITOR	MONITOR	MONITOR	MONITOR	
Secondary Master IDE	MONITOR	MONITOR	MONITOR	MONITOR	MONITOR	MONITOR	MONITOR	

Table 147: X945 Power profile setting overview

Setting / View	Profile 0	Profile 1	Profile 2	Profile 3	Profile 4	Profile 5	Profile 6	My setting
Secondary Slave IDE	MONITOR	MONITOR	MONITOR	MONITOR	MONITOR	MONITOR	MONITOR	
Resume On Ring	Disabled	Disabled	Disabled	Disabled	Disabled	Disabled	Disabled	
Resume on PME#	Disabled	Disabled	Disabled	Disabled	Disabled	Disabled	Disabled	
Resume On RTC Alarm	Disabled	Disabled	Disabled	Disabled	Disabled	Disabled	Disabled	
Power Button Mode	On/Off	On/Off	On/Off	On/Off	On/Off	On/Off	On/Off	

Table 147: X945 Power profile setting overview

1.10 BIOS Error signals (beep codes)

While the Panel PC 700 is booting, the following messages and errors can occur with BIOS. These errors are signaled by different beeping codes.

1.10.1 BIOS X945

Beeping code	Meaning	Necessary user action
1 x short	Memory refresh failed.	Load BIOS defaults. In the event that the error persists, send industrial PC to B&R for testing.
2 x short	Parity error: POST error (error in one of the hardware testing procedures)	Load BIOS defaults. In the event that the error persists, send industrial PC to B&R for testing.
3 x short	Base 64 KB memory failure: Basic memory defect, RAM error within the initial 64 KB.	Check the placement of the inserted card. In the event that the error persists, send industrial PC to B&R for testing.
4 x short	Timer not operational: System timer.	Send industrial PC to B&R for checking.
5 x short	Processor error: Processor defect.	Send industrial PC to B&R for checking.
6 x short	8042 gate A20 failure: Keyboard controller defect (block 8042/ A20 gate). Processor cannot switch to protected mode.	Send industrial PC to B&R for checking.
7 x short	Processor exception interrupt error: Virtual mode exception error (CPU generated an interrupt error).	Send industrial PC to B&R for checking.
8 x short	Display memory read/write error: Video memory not accessible; graphic card defect or not built in (no fatal error).	Check inserted graphic card position and eventually exchange. In the event that the error persists, send industrial PC to B&R for testing.

Table 148: BIOS post code messages BIOS X945

1.11 Distribution of resources

1.11.1 RAM address assignment

RAM address	Resource
000000h - 0003FFh	Interrupt vectors
000400h - 09FBFFh	MS-DOS program area
09FC00h - 09FFFFh	Advanced BIOS data
0A0000h - 0CFFFFh	VGA BIOS and memory
0D0000h - 0DFFFFh	Available
0E0000h - 0FFFFFFh	System BIOS (AMI)
100000h - (TOM ¹) - 8MB - 192kB)	SDRAM
(TOM - 8MB - 192kB) - (TOM - 192kB)	VGA frame buffer ²⁾
(TOM - 192kB) - TOM	ACPI reclaim, MPS and NVS area ³⁾

Table 149: RAM address assignment

- 1) T.O.M. = Top of memory = Max. installed DRAM.
- 2) The VGA frame buffer can be reduced to 1 MB in the setup.
- 3) Only if *ACPI Aware OS* is set to *YES* in the setup.

1.11.2 DMA channel assignment

DMA channel	Resource
0	Available
1	Available
2	Floppy disk drive (FDC)
3	LPT (ECP) ¹⁾
4	Reserved (Cascade DMA Controller)
5	Available
6	Available
7	Available

Table 150: DMA channel assignment

- 1) Not available if the parallel port is not used in ECP mode.

1.11.3 I/O address assignment

I/O address	Resource
000h - 01Fh	DMA controller 1
020h - 03Fh	Interrupt controller 1
040h - 05Fh	Timer
060h - 06Fh	Keyboard controller
070h - 071h	Real-time clock, NMI mask, CMOS
080h	Debug port (POST code)
081h - 09Fh	Page register - DMA controller
0A0h - 0BFh	Interrupt controller 2
0C0h - 0DFh	DMA controller 2
0F0h - 0FFh	FPU
170h - 177h	Secondary Hard Disk IDE channel
1F0h - 1F7h	Primary Hard Disk IDE channel
238h - 023F	COM5
278h - 27Fh	Hardware Security Key (LPT2)
2E8h - 2EFh	COM4
2F8h - 2FFh	COM2
376h - 376h	Secondary Hard Disk IDE channel
378h - 37Fh	LPT1 (printer connection)
384h - 385h	CAN controller
3B0h - 3BBh	VGA controller
3BCh - 3BFh	LPT3
3C0h - 3DFh	VGA controller
3E8h - 3EFh	COM3
3F6h - 3F6h	Primary Hard Disk IDE channel
3F0h - 3F7h	FDD controller
3F8h - 3FFh	COM1
LPT1 + 400h	ECP Port, LPT+400h
CF8h - CFBh	PCI config address register
CFCh - CFFh	PCI config data register
4100h - 417Fh	MTCX
FF00h - FF07h	IDE bus master register

Table 151: I/O address assignment

1.11.4 Interrupt assignments in PCI mode

IRQ	0	1	2	3	4	5	6	7	8	9	10	11	12	13	14	15	NMI	NONE
System timer	●																	
Keyboard		●																
IRQ cascade			●															
COM1 (Serial port A)				○	●													
COM2 (Serial port B)				●	○													
LPT1				○	○	○	○	○		○	○	○	○		○			●
LPT2				○	○	○	○	○		○	○	○	○		○			●
LPT3				○	○	○	○	○		○	○	○	○		○			●
PS/2 mouse													●					
ACPI ¹⁾										●								
FDD							●											○
Real-time clock									●									
Coprocessor (FPU)														●				
Primary IDE channel															●			
Secondary IDE channel																○		
B&R	COM3 (COM C)				○	○	○		○		○	○	○					●
	COM4 (COM D)				○	○	○		○		○	○	○					●
	COM5 (COM E)				○	○	○		○		○	○	○					●
	CAN										○						○	●

Table 152: IRQ interrupt assignments in PCI mode

1) Advanced Configuration and Power Interface.

- ... Default setting
- ... Optional setting

1.11.5 Interrupt assignments in APIC mode

A total of 23 IRQs are available in the APIC mode (**A**dvanced **P**rogrammable **I**nterrupt **C**ontroller). The activation of this option is only effective if it takes place before the operating system (Windows XP) is activated. There are then 23 IRQs available.

IRQ	0	1	2	3	4	5	6	7	8	9	10	11	12	13	14	15	16	17	18	19	20	21	22	23	NMI	NONE
System timer	●																									
Keyboard		●																								
IRQ cascade			●																							
COM1 (Serial port A)				○	●																					
COM2 (Serial port B)				●	○																					
LPT1				○	○	○	○	○		○	○	○	○		○											●
LPT2				○	○	○	○	○		○	○	○	○		○											●
PS/2 mouse													●													
ACPI ¹⁾									●																	
FDD						●																				○
Real-time clock								●																		
Coprocessor (FPU)														●												
Primary IDE channel															●											
Secondary IDE channel																○										
B&R	COM3 (COM C)			○	○	○		○		○	○	○														●
	COM4 (COM D)			○	○	○		○		○	○	○														●
	COM5 (COM E)			○	○	○		○		○	○	○														●
	CAN										○														○	●
PIRQ A ²⁾																●										
PIRQ B ³⁾																	●									
PIRQ C ⁴⁾																		●								
PIRQ D ⁵⁾																			●							
PIRQ E ⁶⁾																				●						
PIRQ F ⁷⁾																					●					
PIRQ G ⁸⁾																						●				
PIRQ H ⁹⁾																							●			

Table 153: IRQ interrupt assignments in APIC mode

1) Advanced Configuration and Power Interface.

- 2) PIRQ A: Graphics controller.
- 3) PIRQ B: INTD + AC97 audio controller.
- 4) PIRQ C: INTC + Native IDE.
- 5) PIRQ D: USB UHCI controller #1 + SM bus.
- 6) PIRQ E: LAN controller (ETH1).
- 7) PIRQ F: INTA + ETH2
- 8) PIRQ G: INTB
- 9) PIRQ H: USB EHCI controller + UHCI0.

- ... Default setting
- ... Optional setting

The PCI resources are assigned to fixed IRQ lines when the APIC function is enabled. The following image shows the connections to the individual PCI slots.

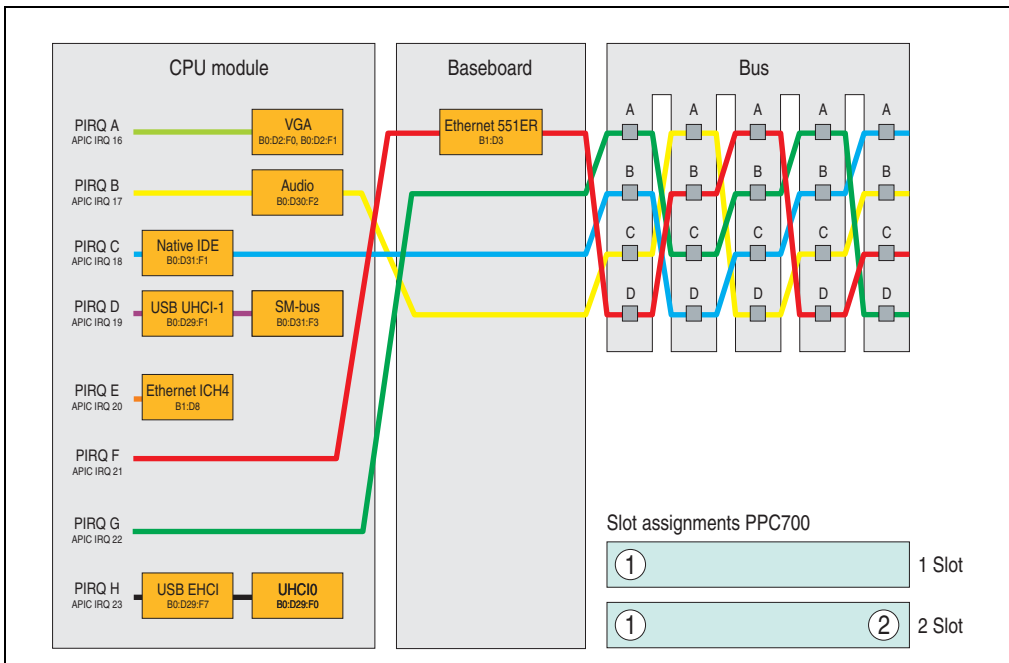

Figure 172: PCI Routing with activated APIC CPU board X945

1.11.6 Inter-IC (I²C) bus

I ² C address	Resource	Note
A0h	EEPROM	EEPROM for CMOS data - cannot be used
B0h	Reserved	Cannot be used
58h	Reserved	Cannot be used

Table 154: Inter-IC (I²C) bus resources

1.11.7 System Management (SM) bus

SM Bus address	SM device	Note
12h	SMART_CHARGER	
14h	SMART_SELECTOR	
16h	SMART_BATTERY	
D2h	Clock Generator	

Table 155: Inter-IC (I²C) bus resources

2. Upgrade information

Warning!

The BIOS and firmware on APC820 systems must be kept up to date. New versions can be downloaded from the B&R homepage (www.br-automation.com).

2.1 BIOS upgrade

An upgrade might be necessary for the following reason:

- To update implemented functions or to add newly implemented functions or components to the BIOS setup (information about changes can be found in the Readme files of the BIOS upgrade).

2.1.1 What information do I need?

Information:

Individually saved BIOS settings are deleted when upgrading the BIOS.

Before you begin the upgrade, it helps to determine the various software versions.

Which BIOS version and firmware are already installed on the PPC700?

This information can be found on the same BIOS setup page for both the X945 CPU boards:

- After switching on the PPC700, you can get to the BIOS Setup by pressing "F2" or "DEL".
- From the BIOS main menu "advanced" (top), select "baseboard/panel features" (bottom):

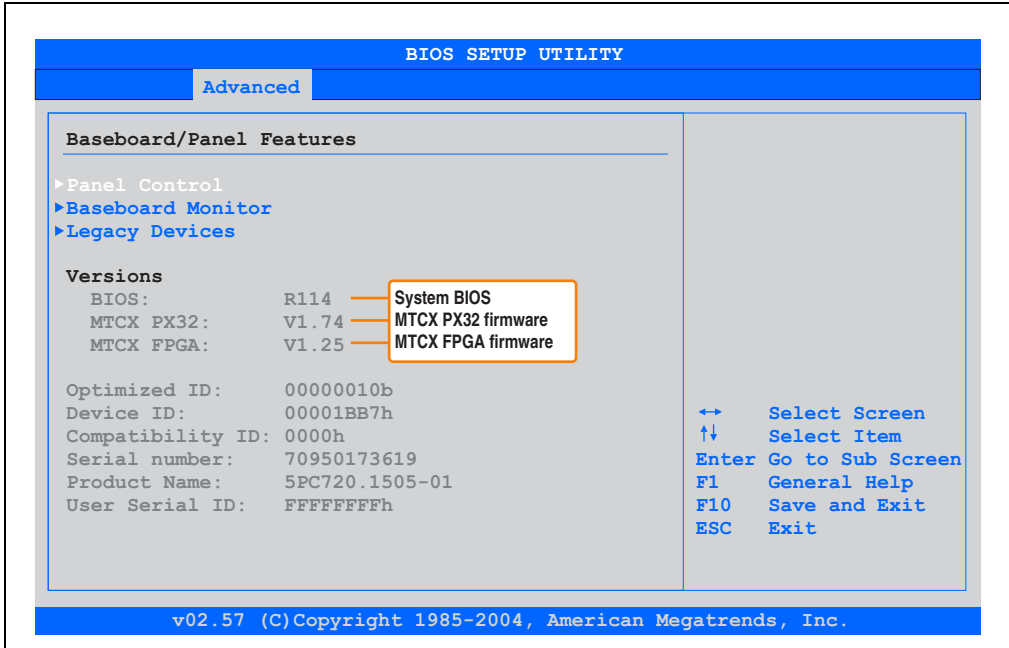

Figure 173: Software versions

Which firmware is installed on the Automation Panel Link Transceiver/Receiver?

This information can be found on the following BIOS setup page:

- After switching on the PPC700, you can get to the BIOS Setup by pressing "F2" or "DEL".
- From the BIOS main menu "advanced" (top), select "baseboard/panel features" (bottom) and then "panel control":

Information:

The version can only be shown if an Automation Panel with Automation Panel Link SDL transceiver (5DLSDL.1000-01) and Automation Panel Link SDL receiver (5DLSDL.1000-00) is connected.

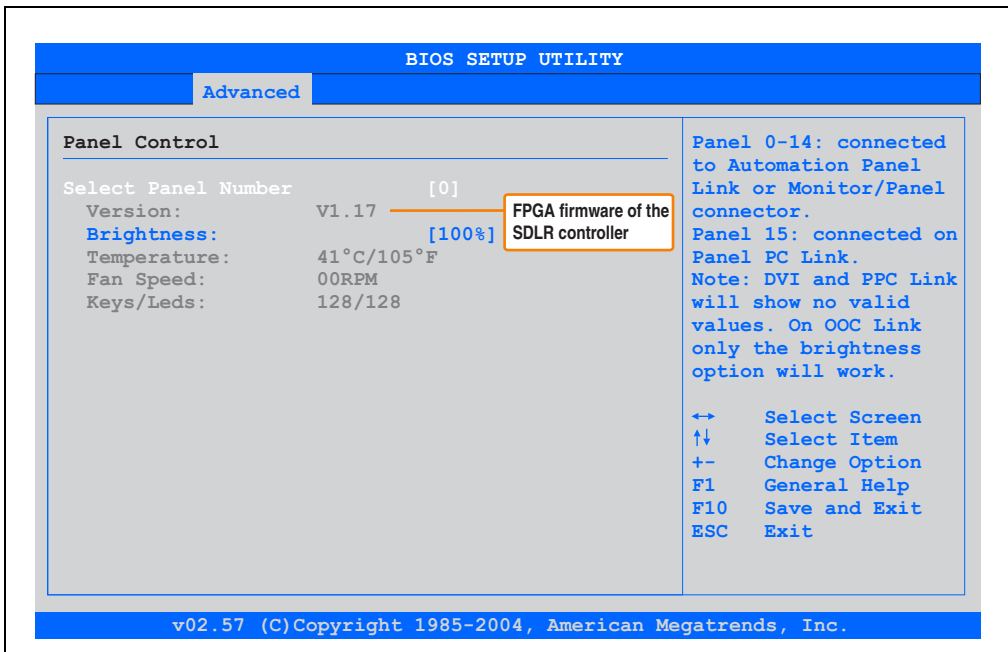

Figure 174: Firmware version of Automation Panel Link SDL transceiver/receiver

2.1.2 Upgrade BIOS for X945

- Download ZIP file from the B&R homepage (www.br-automation.com)
- Create bootable media.

Information:

In MS-DOS, Win95 and Win98, a blank HD disk can be made bootable using the command line command "sys a:" or "format a: /s".

Information concerning creating a bootable diskette in Windows XP can be found on page 321.

Information concerning creating a USB flash drive for a B&R upgrade can be found on page 323.

Information concerning creating a CompactFlash card for a B&R upgrade can be found on page 325.

- Copy the contents of the *.zip file to the bootable media. If the B&R upgrade was already added when the bootable media was created using the B&R Embedded OS Installer, then this step is not necessary.
- Connect the bootable media to the PPC700 and reboot the device.
- The following boot menu will be shown after startup:

1. Upgrade AMI BIOS for X945/N270 (5PC600.X945-xx)
2. Exit to MS-DOS

Concerning item 1:
BIOS is automatically upgraded (default after 5 seconds).

Concerning item 2:
Returns to the shell (MS-DOS).

- The system must be rebooted after a successful upgrade.

Information:

After the system restart, the warning "CMOS checksum BAD" is displayed, but BIOS boots through it. The setup can be opened using the "Del" key and the setup defaults must be loaded again and saved using either the "F9" key or the menu item "Exit" - "Load CMOS defaults".

2.1.3 Windows XP Embedded and BIOS upgrade

If the following error message appears after upgrading BIOS:

```
"Copy Error"
```

```
"Setup cannot copy the file Audio3d.dll"
```

then the audio driver must be reinstalled.

To do this, use the audio driver from the B&R Homepage (www.br-automation.com).

During the installation of the audio driver, the following 2 files must be manually selected from the following directories.

```
ksuser.dll in the directory ...\\Windows\\system32
```

```
ks.sys in the directory ...\\Windows\\system32\\drivers
```

2.2 Upgrading the firmware

With the APC620 / Panel PC 700 firmware upgrade (MTCX, SDLR), the firmware of a number of controllers (MTCX, SDLR) can be updated, depending on the construction of the PPC700 system.

2.2.1 Procedure

- Create bootable media.

Information:

In MS-DOS, Win95 and Win98, a blank HD disk can be made bootable using the command line command "sys a:" or "format a: /s".

Information concerning creating a bootable diskette in Windows XP can be found on page 438.

Information concerning creating a USB flash drive for a B&R upgrade can be found on page 323.

Information concerning creating a CompactFlash card for a B&R upgrade can be found on page 325.

- Copy the contents of the *.zip file to the bootable media. If the B&R upgrade was already added when the bootable media was created using the B&R Embedded OS Installer, then this step is not necessary.
- Connect the bootable media to the Panel PC 700 and reboot the device.

Information:

- **The following boot menu options including descriptions are based on version 1.28 of the APC620 / Panel PC Firmware upgrade (MTCX, SDLR) disk. In some cases, these descriptions might not match the version you are currently using.**

Boot menu options:

1. Upgrade MTCX (APC620/PPC700) PX32 and FPGA
2. Upgrade SDLT (APC620) only
3. Upgrade SDLR (AP800/AP900) on monitor/panel
 - 3.1. Upgrade SDLR on AP 0 (AP800/AP900)
 - 3.2. Upgrade SDLR on AP 1 (AP800/AP900)

- 3.3. Upgrade SDLR on AP 2 (AP800/AP900)
- 3.4. Upgrade SDLR on AP 3 (AP800/AP900)
- 3.5. Upgrade all SDLR (AP800/AP900)
- 3.6. Return to main menu
4. Upgrade SDLR (AP800/AP900) on AP link slot
 - 4.1. Upgrade SDLR on AP 8 (AP800/AP900)
 - 4.2. Upgrade SDLR on AP 9 (AP800/AP900)
 - 4.3. Upgrade SDLR on AP 10 (AP800/AP900)
 - 4.4. Upgrade SDLR on AP 11 (AP800/AP900)
 - 4.5. Upgrade all SDLR (AP800/AP900)
 - 4.6. Return to main menu
5. Upgrade add-on UPS (firmware and battery settings)
 - 5.1. Upgrade Add-On UPS Firmware (5AC600.UPSI-00)
 - 5.2. Upgrade Battery Settings (5AC600.UPSB-00)
 - 5.3. Return to main menu
6. Exit

Concerning item 1:

Automatically upgrade PX32 and FPGA for MTCX (default after 5 seconds).

Concerning item 2:

The FPGA of the SDLT controller on the AP Link slot is automatically updated.

Concerning item 3:

Submenu 1 is opened for upgrading the SDLR controller on the Monitor/Panel plug.

- 3.1. Upgrade SDLR on AP 0 (AP800/AP900) - The SDLR controller on Automation Panel 0 is automatically updated.
- 3.2. Upgrade SDLR on AP 1 (AP800/AP900) - The SDLR controller on Automation Panel 1 is automatically updated.
- 3.3. Upgrade SDLR on AP 2 (AP800/AP900) - The SDLR controller on Automation Panel 2 is automatically updated.
- 3.4. Upgrade SDLR on AP 3 (AP800/AP900) - The SDLR controller on Automation Panel 3 is automatically updated.

Software • Upgrade information

3.5. Upgrade all SDLR (AP800/AP900) - All SDLR controllers on all Automation Panels on the monitor/panel are automatically upgraded (default after 5 sec).

3.6. Return to Main Menu

Concerning item 4:

Submenu 2 is opened for upgrading the SDLR controller on the AP Link slot.

4.1. Upgrade SDLR on AP 8 (AP800/AP900) - The SDLR controller on Automation Panel 8 is automatically updated.

4.2. Upgrade SDLR on AP 9 (AP800/AP900) - The SDLR controller on Automation Panel 9 is automatically updated.

4.3. Upgrade SDLR on AP 10 (AP800/AP900) - The SDLR controller on Automation Panel 10 is automatically updated.

4.4. Upgrade SDLR on AP 11 (AP800/AP900) - The SDLR controller on Automation Panel 11 is automatically updated.

4.5. Upgrade all SDLR (AP800/AP900) - All SDLR controllers on all Automation Panels on the AP Link slot are automatically upgraded (default after 5 sec).

4.6. Return to Main Menu

Concerning item 5:

Submenu 3 for the add-on UPS firmware and upgrade and the battery settings upgrade is opened.

5.1. Upgrade add-on UPS firmware (5AC600.UPSI-00)- The firmware for the add-on UPSI is automatically upgraded.

5.2. Upgrade battery settings (5AC600.UPSB-00) - The battery settings for 5AC600.UPSB-00 are automatically upgraded.

5.3. Return to Main Menu

Concerning item 6:

Returns to the shell (MS-DOS).

Information:

The system must be powered off and on again after a successful controller upgrade.

2.2.2 Possible upgrade problems and version dependencies

1. The SDLR firmware can only be updated if an Automation Panel with Automation Panel Link Transceiver (5DLSDL.1000-01) and Automation Panel Link Receiver (5DLSDL.1000-00) is connected. This update is only permitted in an office environment (clean environment - no disturbances) because a software error in versions older than V0.03 can cause errors. This error

can cause the Automation Panel to remain off after an update. If this error occurs, the Automation Panel Link Transceiver (5DLSDL.1000-01) or Automation Panel Link Receiver (5DLSDL.1000-00) must be exchanged or sent in for repair.

2. Daisy Chain operation of 2 Automation Panel 900 units is supported starting with SDLR version V00.08 or V01.01 and MTCX PX32 V01.33 and MTCX FPGA V01.11 (contents of the MTCX upgrade disk V01.04).

3. Operation of an SDLT adapter in the AP Link slot is supported starting with MTCX PX32 V01.50 and MTCX FPGA V01.12 (contents of the MTCX upgrade disk V01.07).

4. When using a functional SDL connection with an installed SDLR version V00.03 or lower, the SDLR must first be updated to version V00.05 or higher. Only then can the MTCX PX32 and FPGA be updated. If the MTCX PX32 and FPGA is updated first, then the SDLR FW can no longer be updated.

5. Starting with SDLR version V00.05 or V01.01, the MTCX PX32 must be higher than or equal to V01.23 and the MTCX FPGA must higher than or equal to V01.09. Otherwise, full SDL functionality is not possible.

6. SDL with equalizer is first supported starting with SDLR version V01.04 and MTCX PX32 version V01.55 and MTCX FPGA version V01.15. An SDLT with version V00.02 is required on the AP Link slot (contents of the MTCX upgrade disk V01.10). SDL with equalizer allows longer distances (max. 40m) depending on the AP being used. Detailed information for this can be found in the APC620 or PPC700 user's manual.

7. Automation Panel Link transceivers (5DLSDL.1000-01) or Automation Panel Link receivers (5DLSDL.1000-00) with a Firmware version lower than or equal to V00.10 can no longer be combined with Automation Panel Link transceivers (5DLSDL.1000-01) or Automation Panel Link receivers (5DLSDL.1000-00) with a Firmware higher than or equal to V01.04. Daisy Chain mode is not possible with such a combination.

8. The menu items "2. Upgrade MTCX PX32 only" and "3. Upgrade MTCX FPGA only" have been removed from the boat menu starting with MTCX Upgrade Disk V01.13.

9. The menu items "3. Upgrade SDLR on Monitor/Panel" and "4. Upgrade SDLR on AP Link Slot" (starting with MTCX upgrade disk V01.13) for upgrading the Automation Panel 800 series have been expanded.

10. The ID AP8H was changed to SDL8 (AP800 series).

11. Den Menuepunkt "5. Upgrade Add-on UPS (Firmware and Battery Settings)" ab MTCX Upgrade Disk V01.16 eingefuegt.

12. Starting with MTCX upgrade disk V01.16, all firmware files are equipped with an XML header; as a result, the name assignment has changed (compatible with Automation Studio and Automation Runtime).

Software • Upgrade information

13. If a UPS (e.g. 5AC600.UPSI-00) + battery unit (e.g.: 5AC600.UPSB-00) is connected to the system and operable, then after an upgrade of the MTCX or SDLT you must either disconnect the battery or push the Power button (to put the system in Standby mode), before executing the required power off/on. If not, the firmware upgrade will not work because the UPS buffers the system.
14. Starting with UPS firmware V01.10, the APC620/PPC700 ADI driver + Control Center V01.80 should be used in order to configure the new options "configurable LowBatteryShutdownTime" and UL compliant "OverCurrentEnable".
15. The IF option Add-On Module CAN with SJA1000 (5AC600.CANI-01) is only supported starting with MTCX FPGA V01.23 (MTCX Upgrade DISK V01.24).

2.3 Creating an MS-DOS boot diskette in Windows XP

- Place an empty 1.44 MB HD diskette in the disk drive.
- Open Windows Explorer.
- Right-click on the 3½" floppy icon and select "**Format...**".

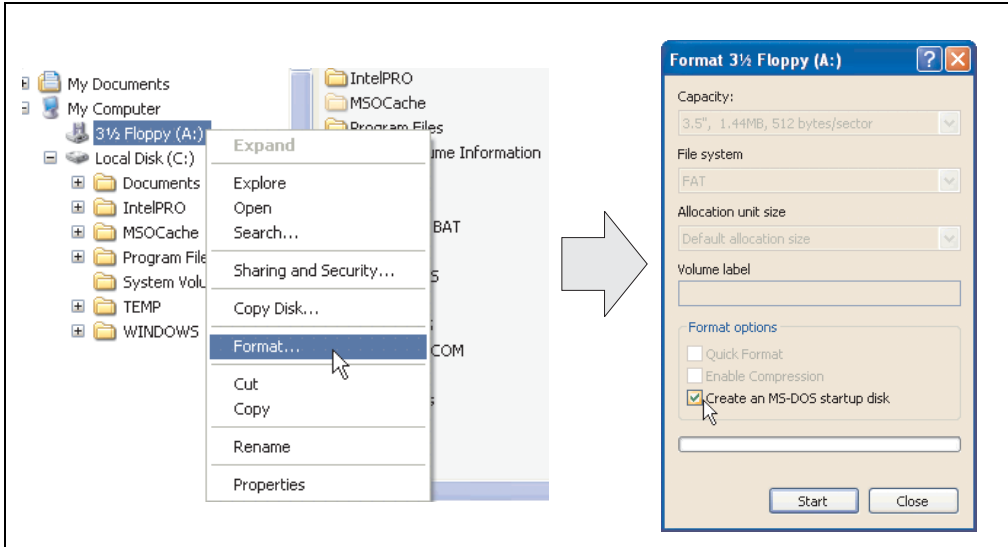

Figure 175: Creating a bootable diskette in Windows XP - step 1

- Then select the checkbox "**Create an MS-DOS startup disk**", press "**Start**" and acknowledge the warning message with "OK".

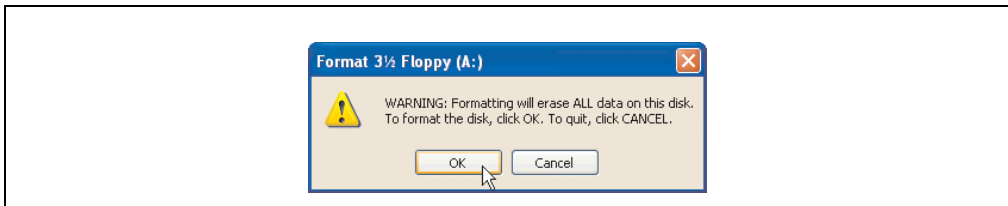

Figure 176: Creating a bootable diskette in Windows XP - step 2

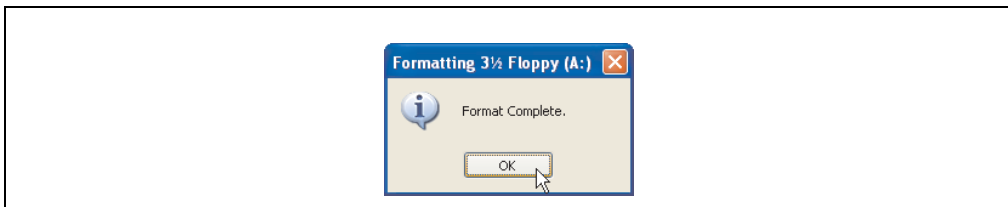

Figure 177: Creating a bootable diskette in Windows XP - step 3

Software • Upgrade information

After creating the startup disk, some of the files must be deleted because of the size of the update.

When doing this, all files (hidden, system files, etc.) must be shown on the diskette.

In Explorer, go to the Tools menu, select Folder Options... and open the View tab. Now deactivate the option Hide protected operating system files (Recommended) (activated by default) and activate the option Show hidden files and folders.

Before				After			
Name	Size	Type	Date Modified	Name	Size	Type	Date Modified
DISPLAY.SYS	17 KB	System file	6/8/2000 5:00 PM	AUTOEXEC.BAT	0 KB	MS-DOS Batch File	3/22/2006 10:08 AM
EGA2.CPI	58 KB	CPI File	6/8/2000 5:00 PM	COMMAND.COM	91 KB	MS-DOS Application	6/8/2000 5:00 PM
EGA3.CPI	58 KB	CPI File	6/8/2000 5:00 PM	CONFIG.SYS	0 KB	System file	3/22/2006 10:08 AM
EGA.CPI	58 KB	CPI File	6/8/2000 5:00 PM	DISPLAY.SYS	17 KB	System file	6/8/2000 5:00 PM
KEYB.COM	22 KB	MS-DOS Application	6/8/2000 5:00 PM	EGA2.CPI	50 KB	CPI File	6/8/2000 5:00 PM
KEYBOARD.SYS	34 KB	System file	6/8/2000 5:00 PM	EGA3.CPI	50 KB	CPI File	6/8/2000 5:00 PM
KEYBRD2.SYS	32 KB	System file	6/8/2000 5:00 PM	EGA.CPI	58 KB	CPI File	6/8/2000 5:00 PM
KEYBRD3.SYS	31 KB	System file	6/8/2000 5:00 PM	IO.SYS	114 KB	System file	5/15/2001 6:57 PM
KEYBRD4.SYS	13 KB	System file	6/8/2000 5:00 PM	KEYB.COM	22 KB	MS-DOS Application	6/8/2000 5:00 PM
MODE.COM	29 KB	MS-DOS Application	6/8/2000 5:00 PM	KEYBOARD.SYS	34 KB	System file	6/8/2000 5:00 PM
				KEYBRD2.SYS	32 KB	System file	6/8/2000 5:00 PM
				KEYBRD3.SYS	31 KB	System file	6/8/2000 5:00 PM
				KEYBRD4.SYS	13 KB	System file	6/8/2000 5:00 PM
				MODE.COM	29 KB	MS-DOS Application	6/8/2000 5:00 PM
				MSDOS.SYS	1 KB	System file	4/7/2001 1:40 PM

Figure 178: Creating a bootable diskette in Windows XP - step 4

Name	Size	Type	Date Modified
AUTOEXEC.BAT	0 KB	MS-DOS Batch File	3/22/2006 10:08 AM
COMMAND.COM	91 KB	MS-DOS Application	6/8/2000 5:00 PM
CONFIG.SYS	0 KB	System file	3/22/2006 10:08 AM
DISPLAY.SYS	17 KB	System file	6/8/2000 5:00 PM
EGA2.CPI	58 KB	CPI File	6/8/2000 5:00 PM
EGA3.CPI	58 KB	CPI File	6/8/2000 5:00 PM
EGA.CPI	58 KB	CPI File	6/8/2000 5:00 PM
IO.SYS	114 KB	System file	5/15/2001 6:57 PM
KEYB.COM	22 KB	MS-DOS Application	6/8/2000 5:00 PM
KEYBOARD.SYS	34 KB	System file	6/8/2000 5:00 PM
KEYBRD2.SYS	32 KB	System file	6/8/2000 5:00 PM
KEYBRD3.SYS	31 KB	System file	6/8/2000 5:00 PM
KEYBRD4.SYS	13 KB	System file	6/8/2000 5:00 PM
MODE.COM	29 KB	MS-DOS Application	6/8/2000 5:00 PM
MSDOS.SYS	1 KB	System file	4/7/2001 1:40 PM

Figure 179: Creating a bootable diskette in Windows XP - step 5

Now all files (marked) except Command.com, IO.sys and MSDOS.sys can be deleted.

2.4 Creating a bootable USB flash drive for B&R upgrade files

When used in connection with a B&R industrial PC, it is possible to upgrade BIOS from one of the USB flash drives available from B&R. To do this, the USB flash drive must be prepared accordingly. This is done with the B&R Embedded OS Installer, which can be downloaded for free from the B&R homepage (www.br-automation.com).

2.4.1 Requirements

The following peripherals are required for creating a bootable USB flash drive:

- B&R USB flash drive
- B&R Industrial PC
- USB Media Drive
- B&R Embedded OS Installer (V3.00 or higher)

2.4.2 Procedure

- Connect the USB flash drive to the PC.
- If the drive list is not refreshed automatically, the list must be updated using the command **Drives > Refresh**.
- Mark the desired USB flash drive in the drive list.
- Change to the **Action** tab and select **Install a B&R Update to a USB flash drive** as type of action.
- Enter the path to the MS-DOS operating system files. If the files are part of a ZIP archive, then click on the button **By ZIP file...**. Falls die Dateien in einem Verzeichnis auf der Festplatte gespeichert sind, auf die Schaltfläche **Aus einem Verzeichnis...** klicken.
- In the **B&R Upgrade** text box, it's also possible to enter the path to the ZIP file for the B&R Upgrade Disk and select the file.
- Click on the **Start action** button in the toolbar.

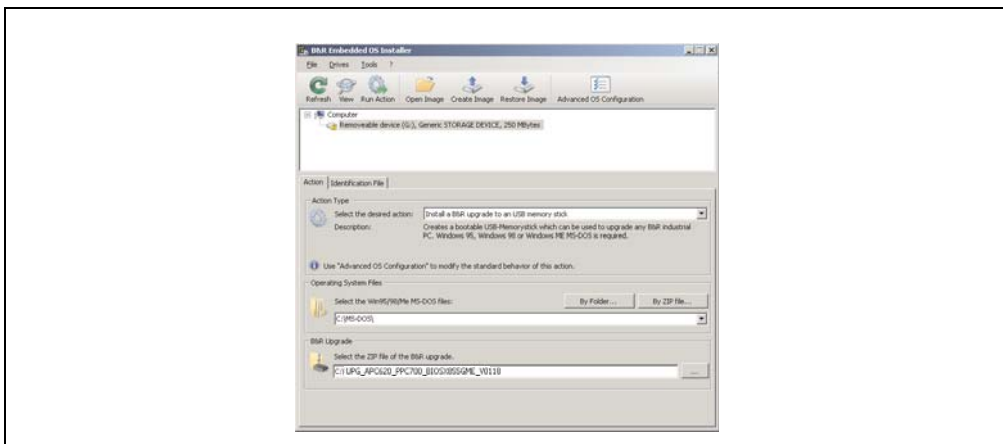

Figure 180: Creating a USB flash drive for B&R upgrade files

2.4.3 Where do I get MS-DOS?

Information concerning creating an MS-DOS boot diskette can be found in section 2.3 "Creating an MS-DOS boot diskette in Windows XP", on page 321. Then the files from the diskette are to be copied to your hard drive.

2.5 Creating a bootable CompactFlash card for B&R upgrade files

When used in connection with a B&R industrial PC, it is possible to upgrade BIOS from one of the CompactFlash cards available from B&R. To do this, the CompactFlash card must be prepared accordingly. This is done with the B&R Embedded OS Installer, which can be downloaded for free from the B&R homepage (www.br-automation.com).

2.5.1 Requirements

The following peripherals are required for creating a bootable CompactFlash card:

- CompactFlash card
- B&R Industrial PC
- B&R Embedded OS Installer (V3.10 or higher)

2.5.2 Procedure

- Insert the CompactFlash card in the CF slot on the industrial PC.
- If the drive list is not refreshed automatically, the list must be updated using the command **Drives > Refresh**.
- Select the desired CompactFlash card from the drive list.
- Change to the **Action** tab and select **Install a B&R Update to a CompactFlash card** as type of action.
- Enter the path to the MS-DOS operating system files. If the files are part of a ZIP archive, then click on the button **By ZIP file...**. Falls die Dateien in einem Verzeichnis auf der Festplatte gespeichert sind, auf die Schaltfläche **Aus einem Verzeichnis...** klicken.
- In the **B&R Upgrade** text box, it's also possible to enter the path to the ZIP file for the B&R Upgrade Disk and select the file.
- Click on the **Start action** button in the toolbar.



Figure 181: Creating a CompactFlash card for B&R upgrade files

2.5.3 Where do I get MS-DOS?

Information concerning creating an MS-DOS boot diskette can be found in section 2.3 "Creating an MS-DOS boot diskette in Windows XP", on page 321. Then the files from the diskette are to be copied to your hard drive.

2.6 Upgrade problems

Potential upgrade problems are listed in the Liesmich.txt or Readme.txt files on the upgrade disks.

3. Panel PC 700 with Automation Runtime

An integral component of Automation Studio™ is Automation Runtime, the software kernel which allows applications to run on a target system. This runtime environment offers numerous important advantages:

- Guaranteed highest possible performance for the hardware being used
- Runs on all B&R target systems
- Makes the application hardware-independent
- Applications can be easily ported between B&R target systems
- Cyclic system guarantees deterministic behavior
- Configurable jitter tolerance in all task classes
- Supports all relevant programming language such as IEC 61131-3 and C
- Extensive function library conforming to IEC 61131-3 as well as the expanded B&R Automation library
- Integrated into Automation NET. Access to all networks and bus systems via function calls or the Automation Studio™ configuration

3.1 ARwin

The system is supported by ARwin with an AS 3.0.80 upgrade.

3.2 ARemb

The system is supported by ARemb with an AS 3.0.90 / AR 4.00 upgrade.

4. Panel PC 700 with Windows XP Professional

Information:

Discontinuation of support for Windows XP by Microsoft:

After April 8th, 2014, Microsoft will no longer be providing any security updates, hotfixes, support (free or paid) or technical resources for Windows XP.



Figure 182: Windows XP Professional Logo

Model number	Short description	Note
5SWWXP.0600-GER	WinXP Professional with SP3, GER Microsoft OEM Windows XP Professional Service Pack 3, CD, German. Only available with a new device.	
5SWWXP.0600-ENG	WinXP Professional with SP3, ENG Microsoft OEM Windows XP Professional Service Pack 3, CD, English. Only available with a new device.	
5SWWXP.0600-MUL	WinXP Professional with SP3, MUL Microsoft OEM Windows XP Professional Service Pack 3, CD, multi-language. Only available with a new device.	
5SWWXP.0500-GER	WinXP Professional with SP 2c, GER Microsoft OEM Windows XP Professional Service Pack 2c, CD, German. Only available with a new device.	
5SWWXP.0500-ENG	WinXP Professional with SP 2c, ENG Microsoft OEM Windows XP Professional Service Pack 2c, CD, English. Only available with a new device.	
5SWWXP.0500-MUL	WinXP Professional with SP 2c, MUL Microsoft OEM Windows XP Professional Service Pack 2c, CD, multi-language. Only available with a new device.	

Table 156: Model numbers - Windows XP Professional

4.1 Installation

Upon request, B&R can pre-install the required Windows XP Professional version on the desired mass memory (add-on hard disk, slide-in hard disk). All of the drivers required for operation (graphics, network, etc.) are also installed when doing so.

4.1.1 Installation auf PCI SATA RAID Controller - 5ACPCI.RAIC-03, 5ACPCI.RAIC-05

The following steps are necessary for installing Windows XP Professional on the PCI SATA RAID controller:

- 1) Download the RAID driver from the B&R homepage (www.br-automation.com) and copy the files to a diskette.
- 2) Connect the Media Drive (5MD900.USB2-01) to the USB port.
- 3) Insert the diskette and Windows XP Professional CD in the the Media Drive and boot from the CD.
- 4) Press the F6 key during setup to install a third-party SCSI or a driver.
- 5) Press the "s" key when asked about installing an additional drive. Insert the disk in the floppy drive. Press "Enter" and select the driver.
- 6) Follow the setup instructions.
- 7) The setup copies the files to the Windows XP Professional folder and restarts the Panel PC 700.

Information:

- Windows XP setup supports not all USB-FDD drives (see Microsoft KB 916196).
- Depending on the system it could be necessary to change the boot order in BIOS.

4.2 Drivers

The latest drivers for all released operating systems can be found in the download area (Service - Material Related Downloads - BIOS / Drivers / Updates) on the B&R homepage (www.br-automation.com).

Information:

Required drivers can only be downloaded from the B&R homepage, not from manufacturers' pages.

5. Panel PC 700 mit Windows 7



Figure 183: Windows 7 Logo

Model number	Short description	Note
5SWWI7.0100-GER	Win7 Pro 32-bit DVD, GER Microsoft OEM Windows 7 Professional 32-bit, DVD, German. Only available with a new device.	
5SWWI7.0100-ENG	Win7 Pro 32-bit DVD, ENG Microsoft OEM Windows 7 Professional 32-bit, DVD, English. Only available with a new device.	
5SWWI7.0300-MUL	Win7 Ult 32-bit DVD, MUL Microsoft OEM Windows 7 Ultimate 32-bit, DVD, Multilanguage. Only available with a new device.	

Table 157: Model numbers - Windows 7

5.1 Installation

Upon request, B&R can pre-install the required Windows 7 version on the desired mass memory (add-on hard disk). All of the drivers required for operation (graphics, network, etc.) are also installed when doing so.

5.1.1 Installation on PCI SATA RAID controller - 5ACPCI.RAIC-03, 5ACPCI.RAIC-05

The following steps are necessary for installing Windows 7 on the PCI SATA RAID controller:

- 1) Download the RAID driver for Windows 7 from the B&R homepage (www.br-automation.com) and copy the data to a folder on a flash drive.
- 2) Boot using the Windows 7 DVD.
- 3) Follow the installation steps until a page appears asking "Where do you want to install Windows?".
- 4) Plug the USB flash drive with the RAID drivers into an available USB port.
- 5) Click on "Load driver", and navigate to the directory containing the RAID drivers. Then click Next to continue.
- 6) Remove the USB flash drive.
- 7) The Windows 7 installation can now be performed as usual.

Information:

Depending on the system it could be necessary to change the boot order in BIOS.

5.2 Drivers

The latest drivers for all released operating systems can be found in the download area (Service - Material Related Downloads - BIOS / Drivers / Updates) on the B&R homepage (www.br-automation.com).

Information:

Required drivers can only be downloaded from the B&R homepage, not from manufacturers' pages.

5.3 Special considerations, limitations:

- Windows 7 system evaluation (system classification) is not currently supported.
- Windows 7 does not contain a Beep.sys file, which means that audible signal is no longer played (i.e. when touching a key or button).

6. Panel PC 700 with Windows XP Embedded



Figure 184: Windows XP Embedded Logo

Model number	Short description	Note
5SWWXP.0429-ENG	WinXPe FP2007 PPC700 945GME XTX Microsoft OEM Windows XP Embedded Feature Pack 2007, English; for PPC700 with CPU board 5PC600.X945-00; order CompactFlash separately (at least 512 MB).	

Table 158: Model numbers - Windows XP Embedded

6.1 General Information

Windows XP embedded is the modular version of the desktop operating system Windows XP Professional. Windows XP embedded is based on the same binary files as Windows XP Professional and is optimally tailored to the hardware being used. In other words, only the functions and modules required by the respective device are included. Windows XP embedded is also based on the same reliable code as Windows XP Professional. It provides industry with leading reliability, improvements in security and performance, and the latest technology for Web browsing and extensive device support.

6.2 Features with FP2007 (Feature Pack 2007)

The feature list shows the most important device functions in Windows XP embedded with Feature Pack 2007 (FP2007).

Function	Present
Enhanced write filter (EWF)	✓
File Based Write Filter	✓
Page file	Configurable
Administrator account	✓
User account	Configurable
Explorer shell	✓
Registry filter	✓
Internet Explorer 6.0 + SP2	✓
Internet information service (IIS)	-
Terminal service	✓

Table 159: Device functions in Windows XP embedded with FP2007

Function	Present
Windows Firewall	✓
MSN-Explorer	-
Outlook Express	-
Administrative Tools	✓
Remote Desktop	✓
Remote Assistance	-
.NET Framework	-
ASP.NET	-
Codepages/User Locale/Keyboard	✓
Disk Management Service	✓
Windows Installer Service	✓
Class Installer	✓
CoDevice Installer	✓
Media Player	-
DirectX	-
Accessories	✓
Number of fonts	89

Table 159: Device functions in Windows XP embedded with FP2007

6.3 Installation

Upon request, Windows XP Embedded can be preinstalled at B&R Austria on a suitable CompactFlash card (min. 512 MB - must be specified when placing order). The system is then automatically configured after it has been switched on for the first time. This procedure takes approximately 30 minutes, and the device will be rebooted a number of times.

Brief instructions for creating your own Windows XP embedded images or a suitable "Target Designer Export Files Guide" can be downloaded from the download area on the B&R homepage (www.br-automation.com).

6.4 Touch screen driver

The touch screen driver (Elo) must be manually installed and calibrated. The driver can be downloaded from the download area on the B&R homepage (www.br-automation.com).

7. Panel PC 700 with Windows Embedded Standard 2009



Figure 185: Windows Embedded Standard 2009 Logo

Model number	Short description	Note
5SWWXP.0729-ENG	WES2009 PPC700 945GME Microsoft OEM Windows Embedded, Standard 2009, English; for PPC700 with CPU board, 5PC600.X945-00; order CompactFlash separately (at least 1 GB).	

Table 160: Model numbers - Windows Embedded Standard 2009

7.1 General Information

Windows XP Embedded Standard 2009 is the modular version of the desktop operating system Windows XP Professional with Service Pack 3. Windows Embedded Standard 2009 is based on the same binary files as Windows XP Professional with Service Pack 3 and is optimally tailored to the hardware being used. In other words, only the functions and modules required by the respective device are included. Windows Embedded Standard 2009 is also based on the same reliable code as Windows XP Professional with SP3. It provides industry with leading reliability, improvements in security and performance, and the latest technology for Web browsing and extensive device support.

7.2 Features mit WES2009 (Windows Embedded Standard 2009)

The feature list shows the most important device functions in Windows Embedded Standard 2009.

Function	Present
Enhanced write filter (EWF)	✓
File Based Write Filter	✓
Page file	Configurable
Administrator account	✓
User account	Configurable
Explorer shell	✓
Registry filter	✓
Internet Explorer 7.0	✓
Internet information service (IIS)	-
Terminal service	✓
Windows Firewall	✓
MSN-Explorer	-
Outlook Express	-
Administrative Tools	✓
Remote Desktop	✓
Remote Assistance	-
.NET Framework	-
ASP.NET	-
Local Network Bridge	✓
Codepages/User Locale/Keyboard	✓
Disk Management Service	✓
Windows Installer Service	✓
Class Installer	✓
CoDevice Installer	✓
Media Player 6.4	✓
DirectX 9.0c	✓
Accessories	✓
Number of fonts	89

Table 161: Device functions in Windows Embedded Standard 2009

7.3 Installation

Upon request, Windows Embedded Standard 2009 can be preinstalled at B&R Austria on a suitable CompactFlash card (min. 1GB). The PPC700 system is then automatically configured after it has been switched on for the first time. This procedure takes approximately 30 minutes, and the device will be rebooted a number of times.

7.4 Drivers

All drivers required for operation are preinstalled on the operating system. If an older driver version is installed, the latest version can be downloaded from the B&R homepage (www.br-automation.com) and installed. A potentially activated "Enhanced Write Filter (EWF)" must be taken into consideration.

7.4.1 Touch screen driver

The touch screen driver must be manually installed in order to operate Automation Panel 800 or Automation Panel 900 touch screen devices. The driver can be downloaded from the download area on the B&R homepage (www.br-automation.com). A potentially activated "Enhanced Write Filter (EWF)" must be taken into consideration.

Information:

Required drivers can only be downloaded from the B&R homepage, not from manufacturers' pages.

8. Panel PC 700 with Windows Embedded Standard 7



Figure 186: Windows Embedded Standard 7 Logo

Model number	Short description	Note
5SWWI7.0529-ENG	Windows Embedded Standard 7 PPC700 945GME Microsoft OEM Windows Embedded, Standard 7 32-bit, English; for PPC700 with CPU board, 5PC600.X945-00; order CompactFlash separately (at least 1 GB).	
5SWWI7.0729-MUL	Windows Embedded Standard 7 Premium PPC700 945GME Microsoft OEM Windows Embedded, Standard 7 Premium 32-bit, Multilanguage; for PPC700 with CPU board, 5PC600.X945-00; order CompactFlash separately (at least 1 GB).	
5SWWI7.0900-MUL	WES7P 32bit Language Pack DVD	

Table 162: Model numbers - Windows Embedded Standard 2009

8.1 General Information

The successor to Windows® XP Embedded has been given the name Windows® Embedded Standard 7. As with previous versions, this embedded operating system offers full system support of Automation PC 620, Automation PC 810, Panel PC 700, Panel PC 800 and Power Panel 500 devices. In addition to brand new features that are also included in Windows® 7 Professional, Windows® Embedded Standard 7 includes embedded components such as Enhanced Write Filter, File-Based Write Filter, Registry Filter and USB Boot. Windows® Embedded Standard 7 is available in two different versions. The main difference between them has to do with multilanguage support. Windows® Embedded Standard 7 is only available in a single language, whereas Windows® Embedded Standard 7 Premium supports the installation of several languages simultaneously.

With Windows® Embedded Standard 7, Microsoft has made substantial improvements in the area of security. The AppLocker program, available in the premium version, can prevent the execution of unknown or potentially unwanted applications that should be installed over a network or from drives that are directly connected. A tiered approach allows the differentiation between scripts (.ps1, .bat, .cmd, .vbs and .js), installer files (.msi, .msp) and libraries (.dll, .ocx). AppLocker can also be configured to record undesired activity and display it in the Event Viewer. Windows® Embedded Standard 7 is available in both 32-bit and 64-bit versions, which ensures that even the most demanding applications have the level of support they need.

8.2 Features with WES7 (Windows Embedded Standard 7)

The feature list shows the most important device functions in Windows Embedded Standard 7.

Function	Windows Embedded Standard 7	Windows Embedded Standard 7 Professional
Enhanced write filter (EWF)	✓	✓
File Based Write Filter	✓	✓
Administrator account	✓	✓
User account	Configurable	Configurable
Windows Explorer Shell	✓	✓
Registry filter	✓	✓
Internet Explorer 8.0	✓	✓
Internet Information Service (IIS) 7.0	✓	✓
AntiMalware (Windows Defender)	-	✓
Add-ons (Snipping tool, Sticky Notes)	-	✓
Windows Firewall	✓	✓
.NET Framework 3.5	✓	✓
Remote Desktop Protocol 7.0	✓	✓
File Compression Utility	✓	✓
Windows Installer Service	✓	✓
Windows XP Mode	-	-
Media Player 12	✓	✓
DirectX	✓	✓
Multilingual User Interface Packs in the same image	-	✓
International Components and Language Services	✓	✓
Language Pack Setup	✓	✓
Windows Update	Configurable	Configurable
Windows PowerShell 2.0	✓	✓
Bitlocker	-	✓
Applocker	-	✓
Tablet PC Support	-	✓
Windows Touch	-	✓
Boot from USB Stick	✓	✓
Accessories	✓	✓
Page file	Configurable	Configurable
Number of fonts	134	134

Table 163: Device functions in Windows Embedded Standard 7

8.3 Installation

Upon request, Windows Embedded Standard 7 can be preinstalled at B&R Austria on a suitable CompactFlash card (min. 8 GB). The PPC700 system is then automatically configured after it has been switched on for the first time. This procedure takes approximately 30 minutes, and the device will be rebooted a number of times.

8.4 Drivers

All drivers required for operation are preinstalled on the operating system. If an older driver version is installed, the latest version can be downloaded from the B&R homepage (www.br-automation.com) and installed. A potentially activated "Enhanced Write Filter (EWF)" must be taken into consideration.

8.4.1 Touch screen driver

A touch screen driver will be automatically installed if a touch controller is detected during the Windows Embedded Standard 7 setup.

The touch screen driver must be installed manually if a touch controller was not detected during the Windows Embedded Standard 7 setup or if an Automation Panel 800/900 has been connected after setup. The driver can be downloaded from the download area on the B&R homepage (www.br-automation.com). A potentially activated "Enhanced Write Filter (EWF)" must be taken into consideration.

Information:

Required drivers can only be downloaded from the B&R homepage, not from manufacturers' pages.

9. Panel PC 700 with Windows CE



Model number	Short description	Note
5SWWCE.0829-ENG	WinCE6.0 Pro PPC700 945GME XT Microsoft OEM Windows CE 6.0 Professional, English; for PPC700 with CPU board 5PC600.X945-00; order CompactFlash separately (at least 128 MB).	

Table 164: Model numbers - Windows CE

9.1 General Information

B&R Windows CE is an operating system which is optimally tailored to B&R's devices. It includes only the functions and modules which are required by each device. This makes this operating system extremely robust and stable. A further advantage of B&R Windows CE compared to other operating systems are the low licensing costs.

9.2 Windows CE 6.0 features

Detailed information about Windows CE for B&R devices can be downloaded in the download area on the B&R homepage (www.br-automation.com).

Features	Windows CE 6.0
Supported screen resolutions	VGA (TFT), SVGA (TFT), XGA (TFT)
Chipset	Intel 945GME
Color depth	16 bit or 65536 colors ¹⁾
Graphics card driver	Intel® embedded graphics driver
Main memory	Automatic detection and use of up to 512 MB RAM
Boot time / Startup time	Approx. 20 seconds
Screen rotation	not supported
Web browser	Internet Explorer
.NET	Compact Framework
Image size	ca. 38 MByte ²⁾ , nicht komprimiert

Table 165: Windows CE 6.0 features

Features	Windows CE 6.0
Custom keys	Supported
PVI	Supported
Automation Device Interface	Supported
Remote Desktop Protocol for thin clients	Supported
B&R VNC Viewer	Supported
B&R Task Manager	Supported
B&R Picture Viewer	Supported
Compatible with zenOn	Yes
Compatible with Wonderware	No
Serial interfaces for any use	3
DirectX	No
Audio ports	"Line OUT" and "MIC" are supported. "Line IN" is not supported.

Table 165: Windows CE 6.0 features

- 1) The color depth depends on the display used.
- 2) Use the function "*Compress Windows CE Image*" in the B&R Embedded OS Installer to reduce the image size.

9.3 Requirements

The device must fulfill the following criteria to be able run the Windows CE operating system.

- At least 128 MB main memory.
- At least one 128 MB CompactFlash card (size should be specified when ordered).

9.4 Installation

Windows CE is usually preinstalled at the B&R plant.

9.4.1 B&R Embedded OS Installer

The B&R Embedded OS Installer allows you to install existing B&R Windows CE images. The four files (NK.BIN, BLDR, LOGOXRES.BMP, and LOGOQVGA.BMP) must be provided from an already functioning B&R Windows CE installation.

The B&R Embedded OS Installer can be downloaded from the download area on the B&R homepage (www.br-automation.com). Further information is available in the online help for the B&R Embedded OS Installer.

10. B&R Automation Device Interface (ADI) driver - Control Center

The ADI (Automation Device Interface) enables access to specific functions of B&R devices. Settings for this device can be read and edited using the B&R Control Center applet in the control panel.

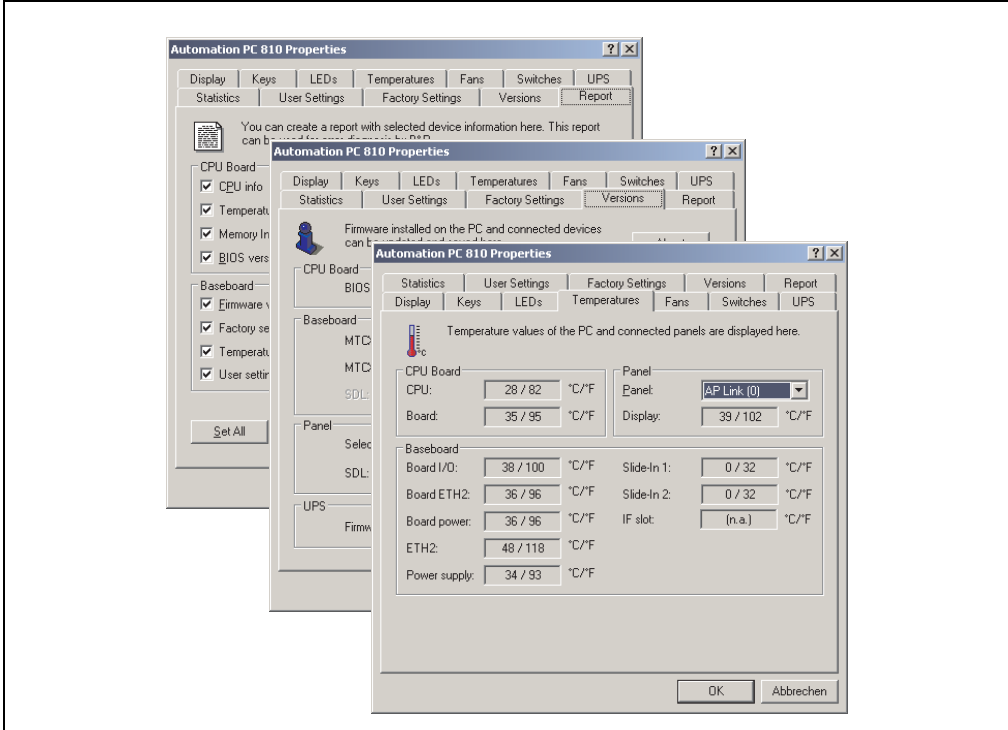

Figure 187: ADI Control Center screenshots - Examples (symbol photo)

Information:

The displayed temperature and voltage values (e.g. CPU temperature, core voltage, battery voltage) on the corresponding ADI page represent uncalibrated information values. These cannot be used to draw any conclusions about any hardware alarms or error conditions. The hardware components used have automatic diagnostics functions that can be applied in the event of error.

10.1 Functions

Information:

The functions provided by the Automation Device Interface (ADI) - Control Center vary according to device series.

- Adjusting the display-specific parameters of connected Panels
- Reading of device-specific keys
- Activation of device specific LEDs on a foil keypad
- Reading temperatures, fan speeds, statistical data, and switch settings
- Reading user settings and factory settings
- Reading software versions
- Updating and securing firmware
- Creating reports about the current system (support assistance)
- Setting the SDL equalizer value for the SDL cable adjustment
- Configuring an optional mounted UPS
- Change the user serial ID.

Supports following systems:

- Automation PC 620
- Automation PC 810
- Automation PC 820
- Panel PC 300
- Panel PC 700
- Panel PC 725
- Panel PC 800
- Power Panel 100/200
- Power Panel 300/400
- Power Panel 500
- Mobile Panel 40/50
- Mobile Panel 100/200
- Automation Panel 800 (in connection with Automation PCs and Panel PCs)
- Automation Panel 900 (in connection with Automation PCs and Panel PCs)

10.2 Installation

A detailed description of the Control Center can be found in the integrated online help. The B&R Automation Device Interface (ADI) driver (also contains Control Center) can be downloaded for free from the download area on the B&R homepage (www.br-automation.com).

1. Download and unzip the ZIP archive
2. Close all applications
3. Run BrSetup.exe (e.g. double-click on it in Explorer).

- or -

1. Right click on BrSetup.inf in explorer and select "Install".

Information:

The ADI driver is already included in the B&R images of embedded operating systems.

If a more current ADI driver version exists (see the B&R homepage download area), it can be installed later. A potentially activated "Enhanced Write Filter (EWF)" must be taken into consideration when installing.

10.3 SDL Equalizer Einstellung

- 1) Start the **Control Center** in the **Control Panel**.
- 2) Then select the **Display** tab.
- 3) Click on **Settings**. This opens the following dialog box:

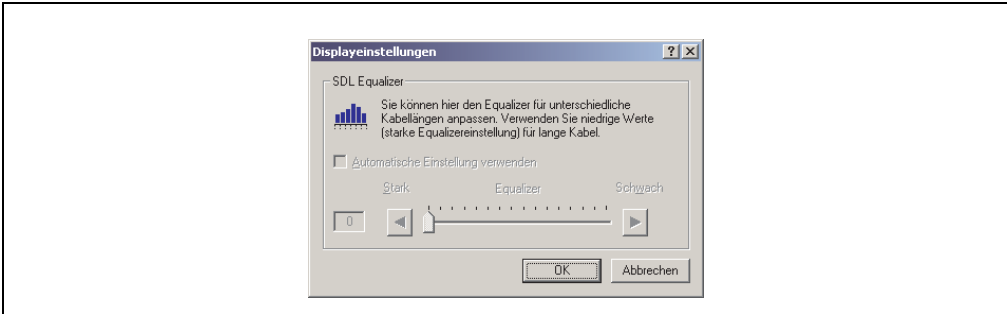

Figure 188: ADI Control Center - SDL equalizer settings

You can change the display's SDL equalizer settings in this dialog box. The equalizer is integrated in the Automation Panel and adapts the DVI signal to various cable lengths. The equalizer value is automatically calculated based on the cable length: You may set a different equalizer value in order to obtain the best possible display quality (e.g. with low-quality cables or poor DVI signal quality).

The value is optimally defined for the cable length when using the "Automatic setting".

The equalizer value can only be changed if the function is supported by Automation Panel 900 (starting with Panel Firmware version 1.04 or higher).

Chapter 5 • Standards and certifications

1. Applicable European directives

- EMC directive 2004/108/EC
- Low-voltage directive 2006/95/EC
- Machine directives 98/37/EC beginning 12/29/2009: 2006/42/EC

2. Overview of standards

Standard	Description
EN 55011 Class A	Electromagnetic compatibility (EMC), radio disturbance product standard, industrial, scientific, and medical high-frequency devices (ISM devices), limit values and measurement procedure; group 1 (devices that do not create HF during material processing) and group 2 (devices that create HF during material processing)
EN 55022 Class A	Electromagnetic compatibility (EMC), radio disturbance characteristics, information technology equipment (ITE devices), limits and methods of measurement
EN 60060-1	High-voltage test techniques - part 1: General specifications and testing conditions
EN 60068-2-1	Environmental testing - part 2: Tests; test A: Dry cold
EN 60068-2-2	Environmental testing - part 2: Tests; test B: Dry heat
EN 60068-2-3	Environmental testing - part 2: Tests; test and guidance: Damp heat, constant
EN 60068-2-6	Environmental testing - part 2: Tests; test: Vibration (sinusoidal)
EN 60068-2-14	Environmental testing - part 2: Tests; test N: Change of temperature
EN 60068-2-27	Environmental testing - part 2: Tests; test and guidance: Shock
EN 60068-2-30	Environmental testing - part 2: Tests; test and guidance: Damp heat, cyclic
EN 60068-2-31	Environmental testing - part 2: Tests; test: Drop and topple, primarily for equipment-type specimens
EN 60068-2-32	Environmental testing - part 2: Tests; test: Free fall
EN 60204-1	Safety of machinery, electrical equipment on machines - part 1: General requirements
EN 60529	Degrees of protection provided by enclosures (IP code)
EN 60721-3-2	Classification of environmental conditions - part 3: Classification of groups of environmental parameters and their severities, section 2: Transport
EN 60721-3-3	Classification of environmental conditions - part 3: Classification of groups of environmental parameters and their severities, section 3: Stationary use at weather-protected locations
EN 61000-4-2	Electromagnetic compatibility (EMC) - part 4-2: Testing and measuring techniques; electrostatic discharge immunity test

Table 166: Overview of standards

Standards and certifications • Overview of standards

Standard	Description
EN 61000-4-3	Electromagnetic compatibility (EMC) - part 4-3: Testing and measuring techniques; radiated radio-frequency electromagnetic field immunity test
EN 61000-4-4	Electromagnetic compatibility (EMC) - part 4-4: Testing and measuring techniques; electrical fast transient/burst immunity test
EN 61000-4-5	Electromagnetic compatibility (EMC) - part 4-5: Testing and measuring techniques; surge immunity test
EN 61000-4-6	Electromagnetic compatibility (EMC) - part 4-6: Testing and measuring techniques; immunity to conducted disturbances, induced by radio-frequency fields
EN 61000-4-8	Electromagnetic compatibility (EMC) - part 4-8: Testing and measuring techniques; power frequency magnetic field immunity test
EN 61000-4-11	Electromagnetic compatibility (EMC) - part 4-11: Testing and measuring techniques; voltage dips, short interruptions and voltage variations immunity tests
EN 61000-4-12	Electromagnetic compatibility (EMC) - part 4-12: Testing and measuring techniques; oscillatory waves immunity test
EN 61000-4-17	Electromagnetic compatibility (EMC) - part 4-12: Testing and measuring techniques; ripple on DC input power port immunity test
EN 61000-6-2	Electromagnetic compatibility (EMC), generic immunity standard - part 2: Industrial environment
EN 61000-6-4	Electromagnetic compatibility (EMC), generic emission standard - part 2: Industrial environment
EN 61131-2 IEC 61131-2	Product standard, programmable logic controllers - part 2: Equipment requirements and tests
UL 508	Industrial control equipment (UL = Underwriters Laboratories)
47 CFR	Federal Communications Commission (FCC), 47 CFR Part 15 Subpart B Class A

Table 166: Overview of standards (Forts.)

3. Emission requirements

Emissions	Test carried out according to	Limits according to
Network-related emissions	EN 55011 / EN 55022	EN 61000-6-4: Generic standard (industrial areas)
		EN 55011: Industrial, scientific, and medical (ISM) radio-frequency equipment, class A (industrial areas)
		EN 55022: Information technology equipment (ITE devices), class A (industrial areas)
		EN 61131-2: Programmable logic controllers
		47 CFR Part 15 Subpart B Class A (FCC)
Emissions, Electromagnetic emissions	EN 55011 / EN 55022	EN 61000-6-4: Generic standard (industrial areas)
		EN 55011: Industrial, scientific, and medical (ISM) radio-frequency equipment, class A (industrial areas)
		EN 55022: Information technology equipment (ITE devices), class A (industrial areas)
		EN 61131-2: Programmable logic controllers
		47 CFR Part 15 Subpart B Class A (FCC)

Table 167: Overview of limits and testing guidelines for emissions

3.1 Network-related emissions

Test carried out according to EN 55011 / EN 55022	Limits according to EN 61000-6-4	Limits according to EN 55011 Class A	Limits according to EN 55022 Class A
Power mains connections 150 kHz - 500 kHz	-	79 dB (µV) Quasi-peak value 66 dB (µV) Average	79 dB (µV) Quasi-peak value 66 dB (µV) Average
Power mains connections 500 kHz - 30 MHz	-	73 dB (µV) Quasi-peak value 60 dB (µV) Average	73 dB (µV) Quasi-peak value 60 dB (µV) Average
AC mains connections 150 kHz - 500 kHz	79 dB (µV) Quasi-peak value 66 dB (µV) Average	-	-
AC mains connections 500 kHz - 30 MHz	73 dB (µV) Quasi-peak value 60 dB (µV) Average	-	-
Other connections 150 kHz - 500 kHz	-	-	97 - 87 dB (µV) und 53 - 43 dB (µA) Quasi-peak value 84 - 74 dB (µV) und 40 - 30 dB (µA) Average
Other connections 500 kHz - 30 MHz	-	-	87 dB (µV) and 43 dB (µA) Quasi-peak value 74 dB (µV) and 30 dB (µA) Average
Tests in accordance with EN 55011 / EN 55022	Limits according to EN 61131-2	Limits according to 47 CFR Part 15 Subpart B class A	
Power mains connections ¹⁾ 150 kHz - 500 kHz	79 dB (µV) Quasi-peak value 66 dB (µV) Average	-	
Power mains connections 500 kHz - 30 MHz	73 dB (µV) Quasi-peak value 60 dB (µV) Average	-	
AC mains connections 150 kHz - 500 kHz	-	79 dB (µV) Quasi-peak value 66 dB (µV) Average	
AC mains connections 500 kHz - 30 MHz	-	73 dB (µV) Quasi-peak value 60 dB (µV) Average	

Table 168: Test requirements - Network-related emissions for industrial areas

Test carried out according to EN 55011 / EN 55022	Limits according to EN 61131-2	Limits according to 47 CFR Part 15 Subpart B class A	
Other connections 150 kHz - 500 kHz	Only informative for cable lengths > 10 m 40 - 30 dB (μA) Quasi-peak value 30 - 20 dB (μA) Average	-	-
Other connections 500 kHz - 30 MHz	Only informative for cable lengths > 10 m 30 dB (μA) Quasi-peak value 20 dB (μA) Average	-	-

Table 168: Test requirements - Network-related emissions for industrial areas (Forts.)

1) AC network connections only with EN 61131-2

3.2 Emissions, electromagnetic emissions

Test carried out according to EN 55011 / EN 55022	Limits according to EN 61000-6-4	Limits according to EN 55011 Class A	Limits according to EN 55022 Class A
30 MHz - 230 MHz measured at a distance of 10 m	< 40 dB (μV/m) Quasi-peak value	< 40 dB (μV/m) Quasi-peak value	< 40 dB (μV/m) Quasi-peak value
230 MHz - 1 GHz measured at a distance of 10 m	< 47 dB (μV/m) Quasi-peak value	< 47 dB (μV/m) Quasi-peak value	< 47 dB (μV/m) Quasi-peak value
Test carried out according to EN 55011 / EN 55022	Limits according to EN 61131-2		
30 MHz - 230 MHz measured at a distance of 10 m	< 40 dB (μV/m) Quasi-peak value		
230 MHz - 1 GHz measured at a distance of 10 m	< 47 dB (μV/m) Quasi-peak value		
Test carried out	Limits according to 47 CFR Part 15 Subpart B class A		
30 MHz - 88 MHz measured at a distance of 10 m	< 90 dB (μV/m) Quasi-peak value		
88 MHz - 216 MHz measured at a distance of 10 m	< 150 dB (μV/m) Quasi-peak value		
216 MHz - 960 MHz measured at a distance of 10 m	< 210 dB (μV/m) Quasi-peak value		
> 960 MHz measured at a distance of 10 m	< 300 dB (μV/m) Quasi-peak value		

Table 169: : Test requirements - Electromagnetic emissions for industrial areas

4. Requirements for immunity to disturbances

Immunity	Test carried out according to	Limits according to
Electrostatic discharge (ESD)	EN 61000-4-2	EN 61000-6-2: Generic standard (industrial areas)
		EN 61131-2: Programmable logic controllers
Immunity against high-frequency electromagnetic fields (HF field)	EN 61000-4-3	EN 61000-6-2: Generic standard (industrial areas)
		EN 61131-2: Programmable logic controllers
Immunity to high-speed transient electrical disturbances (burst)	EN 61000-4-4	EN 61000-6-2: Generic standard (industrial areas)
		EN 61131-2: Programmable logic controllers
Immunity to surge voltages	EN 61000-4-5	EN 61000-6-2: Generic standard (industrial areas)
		EN 61131-2: Programmable logic controllers
Immunity to conducted disturbances	EN 61000-4-6	EN 61000-6-2: Generic standard (industrial areas)
		EN 61131-2: Programmable logic controllers
Immunity against magnetic fields with electrical frequencies	EN 61000-4-8	EN 61000-6-2: Generic standard (industrial areas)
		EN 61131-2: Programmable logic controllers
Immunity to voltage dips, short-term interruptions and voltage fluctuations	EN 61000-4-11	EN 61000-6-2: Generic standard (industrial areas)
		EN 61131-2: Programmable logic controllers
Immunity to damped vibration	EN 61000-4-12	EN 61000-6-2: Generic standard (industrial areas)
		EN 61000-6-2: Generic standard (industrial areas)
		EN 61131-2: Programmable logic controllers

Table 170: Overview of limits and testing guidelines for immunity

Evaluation criteria in accordance with EN 61000-6-2

Criteria A:

The operating equipment must continue to work as intended **during** the test. There should be no interference in the operating behavior and no system failures below a minimum operating quality as defined by the manufacturer.

Criteria B:

The operating equipment must continue to work as directed **after** the test. There should be no interference in the operating behavior and no system failures below a minimum operating quality as defined by the manufacturer.

Criteria C:

A temporary function failure is permitted if the function restores itself, or the function can be restored by activating configuration and control elements.

Criteria D:

Deterioration or failure of the function, which can no longer be established (operating equipment destroyed).

4.1 Electrostatic discharge (ESD)

Test carried out according to EN 61000-4-2	Limits according to EN 61000-6-2	Limits according to EN 61131-2	
Contact discharge to powder-coated and bare metal housing parts	±4 kV, 10 discharges, criteria B	±4 kV, 10 discharges, criteria B	
Discharge through the air to plastic housing parts	±8 kV, 10 discharges, criteria B	±8 kV, 10 discharges, criteria B	

Table 171: Test requirements - Electrostatic discharge (ESD)

4.2 High-frequency electromagnetic fields (HF field)

Test carried out according to EN 61000-4-3	Limits according to EN 61000-6-2	Limits according to EN 61131-2	
Housing, completely wired	80 MHz - 1 GHz, 10 V/m, 80% amplitude modulation with 1 kHz, length 3 seconds, criteria A	2 GHz - 2.7 GHz, 1 V/m, 1.4 GHz - 2 GHz, 3 V/m, 80 MHz - 1 GHz, 10 V/m, 80% amplitude modulation at 1 kHz, duration 3 seconds, criteria A	

Table 172: Test requirements - High-frequency electromagnetic fields (HF field)

4.3 High-speed transient electrical disturbances (burst)

Test carried out according to EN 61000-4-4	Limits according to EN 61000-6-2	Limits according to EN 61131-2	
AC mains inputs/outputs	±2 kV, criteria B	-	
AC power inputs	-	±2 kV, criteria B	
AC power outputs	-	±1 kV, criteria B	
DC power I/O >10 m ¹⁾	±2 kV, criteria B	-	
DC power inputs >10 m	-	±2 kV, criteria B	
DC power outputs >10 m	-	±1 kV, criteria B	
Functional ground connections, signal lines and I/Os >3 m	±1 kV, criteria B	±1 kV, criteria B	
Unshielded AC I/O >3 m	-	±2 kV, criteria B	
Analog I/O	±1 kV, criteria B	±1 kV, criteria B	

Table 173: Test requirements - High-speed transient electrical disturbances (burst)

1) For EN 55024 without length limitation.

4.4 Surges

Test carried out according to EN 61000-4-5	Limits according to EN 61000-6-2	Limits according to EN 61131-2	
AC power I/O, L to L	±1 kV, criteria B	±1 kV, criteria B	
AC power I/O, L to PE	±2 kV, criteria B	±2 kV, criteria B	
DC power I/O, L+ to L-, >10 m	±0.5 kV, criteria B	-	
DC power I/O, L to PE, >10 m	±0.5 kV, criteria B	-	
DC power inputs, L+ to L-	-	±0.5 kV, criteria B	
DC power inputs, L to PE	-	±1 kV, criteria B	
DC power outputs, L+ to L-	-	±0.5 kV, criteria B	
DC power outputs, L to PE	-	±0.5 kV, criteria B	
Signal connections >30 m	±1 kV, criteria B	±1 kV, criteria B	
All shielded cables	-	±1 kV, criteria B	

Table 174: Test requirements - Surge voltages

4.5 Conducted disturbances

Test carried out according to EN 61000-4-6	Limits according to EN 61000-6-2	Limits according to EN 61131-2	
AC mains inputs/outputs	150 kHz - 80 MHz, 10 V, 80% amplitude modulation with 1 kHz, length 3 seconds, criteria A	150 kHz - 80 MHz, 3 V, 80% amplitude modulation with 1 kHz, length 3 seconds, criteria A	

Table 175: Test requirements - Conducted disturbances

Test carried out according to EN 61000-4-6	Limits according to EN 61000-6-2	Limits according to EN 61131-2	
DC mains inputs/outputs	150 kHz - 80 MHz, 10 V, 80% amplitude modulation with 1 kHz, length 3 seconds, criteria A	150 kHz - 80 MHz, 3 V, 80% amplitude modulation with 1 kHz, length 3 seconds, criteria A	
Functional ground connections	0.15 - 80 MHz, 10 V, 80% amplitude modulation with 1 kHz, Length 3 seconds, criteria A	150 kHz - 80 MHz, 3 V, 80% amplitude modulation with 1 kHz, length 3 seconds, criteria A	
Signal connections >3 m	0.15 - 80 MHz, 10 V, 80% amplitude modulation with 1 kHz, Length 3 seconds, criteria A	150 kHz - 80 MHz, 3 V, 80% amplitude modulation with 1 kHz, length 3 seconds, criteria A	

Table 175: Test requirements - Conducted disturbances (Forts.)

4.6 Magnetic fields with electrical frequencies

Test carried out according to EN 61000-4-8	Limits according to EN 61000-6-2	Limits according to EN 61131-2	
Test direction x, test in the field of an induction coil 1 m x 1 m	30 A/m, criteria A	30 A/m, criteria A	
Test direction y, test in the field of an induction coil 1 m x 1 m	30 A/m, criteria A	30 A/m, criteria A	
Test direction z, test in the field of an induction coil 1 m x 1 m	30 A/m, criteria A	30 A/m, criteria A	

Table 176: Test requirements - Magnetic fields with electrical frequencies

4.7 Voltage dips, fluctuations and short-term interruptions

Test carried out according to EN 61000-4-11	Limits according to EN 61000-6-2	Limits according to EN 61131-2	
AC power inputs	Voltage dip 70% (30% reduction), 0.5 periods, criteria B	-	
AC power inputs	Voltage dip 40% (60% reduction), 5 periods, criteria C	-	
AC power inputs	Voltage dip 40% (60% reduction), 50 periods, criteria C	-	
AC power inputs	Voltage interruptions < 5% (> 95% reduction), 250 periods, criteria C	-	
AC power inputs	-	20 interruptions, 0.5 periods, criteria A	
DC power inputs	-	20 interruptions for 10 ms < UN - 15%, criteria A	

Table 177: Test requirements - Voltage dips, fluctuations, and short-term interruptions

4.8 Damped vibration

Test carried out according to EN 61000-4-12	Limits according to EN 61131-2		
Mains inputs/outputs, L to L	± 1 kV, 1 MHz, repeat rate 400/seconds, length 2 seconds, connection lengths 2 m, criteria B		
Power I/O, L to PE	± 2.5 kV, 1 MHz, repeat rate 400/seconds, length 2 seconds, connection lengths 2 m, criteria B		

Table 178: Test requirements - Damped vibration

5. Mechanical conditions

Vibration	Test carried out according to	Limits according to
Vibration operation	EN 60068-2-6	EN 61131-2: Programmable logic controllers
		EN 60721-3-3 class 3M4
Vibration during transport (packaged)	EN 60068-2-6	EN 60721-3-2 class 2M1
		EN 60721-3-2 class 2M2
		EN 60721-3-2 class 2M3
Shock during operation	EN 60068-2-27	EN 61131-2: Programmable logic controllers
		EN 60721-3-3 class 3M4
Shock during transport (packaged)	EN 60068-2-27	EN 60721-3-2 class 2M1
		EN 60721-3-2 class 2M2
		EN 60721-3-2 class 2M3
Toppling (packaged)	EN 60068-2-31	EN 60721-3-2 class 2M1
		EN 60721-3-2 class 2M2
		EN 60721-3-2 class 2M3
Free fall (packaged)	EN 60068-2-32	EN 61131-2: Programmable logic controllers

Table 179: Overview of limits and testing guidelines for vibration

5.1 Vibration operation

Test carried out according to EN 60068-2-6	Limits according to EN 61131-2		Limits according to EN 60721-3-3 class 3M4		
	Frequency	Limit value	Frequency	Limit value	
Vibration during operation: Uninterrupted duty with moveable frequency in all 3 axes (x, y, z), 1 octave per minute	10 sweeps for each axis		10 sweeps for each axis		
	5 - 9 Hz	Amplitude 3.5 mm	2 - 9 Hz	Amplitude 3 mm	
	9 - 150 Hz	Acceleration 1 g	9 - 200 Hz	Acceleration 1 g	

Table 180: Test requirements - Vibration during operation

5.2 Vibration during transport (packaged)

Test carried out according to EN 60068-2-6	Limits according to EN 60721-3-2 class 2M1		Limits according to EN 60721-3-2 class 2M2		Limits according to EN 60721-3-2 class 2M3	
Vibration during transport: Uninterrupted duty with moveable frequency in all 3 axes (x, y, z)	10 sweeps for each axis, packaged		10 sweeps for each axis, packaged		10 sweeps for each axis, packaged	
	Frequency	Limit value	Frequency	Limit value	Frequency	Limit value
	2 - 9 Hz	Amplitude 3.5 mm	2 - 9 Hz	Amplitude 3.5 mm	2 - 8 Hz	Amplitude 7.5 mm
	9 - 200 Hz	Acceleration 1 g	9 - 200 Hz	Acceleration 1 g	8 - 200 Hz	Acceleration 2 g
	200 - 500 Hz	Acceleration 1.5 g	200 - 500 Hz	Acceleration 1.5 g	200 - 500 Hz	Acceleration 4 g

Table 181: Test requirements - Vibration during transport (packaged)

5.3 Shock during operation

Test carried out according to EN 60068-2-27	Limits according to EN 61131-2	Limits according to EN 60721-3-3 class 3M4	
Shock during operation: Pulse (half-sine) stress in all 3 axes (x, y, z)	Acceleration 15 g, length 11 ms, 18 shocks	Acceleration 15 g, Duration 11 ms	

Table 182: Test requirements - Shock during operation

5.4 Shock during transport (packaged)

Test carried out according to EN 60068-2-27	Limits according to EN 60721-3-2 class 2M1	Limits according to EN 60721-3-2 class 2M2	Limits according to EN 60721-3-2 class 2M3
Pulse (half-sine) stress in all 3 axes (x, y, z)	Acceleration 10 g, Duration 11 ms, each 3 shocks, packaged	Acceleration 30 g, Duration 6 ms, each 3 shocks, packaged	Acceleration 100 g, Duration 6 ms, each 3 shocks, packaged

Table 183: Test requirements - Shock during transport

5.5 Toppling

Test carried out according to EN 60068-2-31	Limits according to EN 60721-3-2 class 2M1		Limits according to EN 60721-3-2 class 2M2		Limits according to EN 60721-3-2 class 2M3	
Drop and topple	Devices: Drop/topple on each edge		Devices: Drop/topple on each edge		Devices: Drop/topple on each edge	
	Weight	Required	Weight	Required	Weight	Required
	<20 kg	Yes	<20 kg	Yes	<20 kg	Yes
	20 - 100 kg	-	20 - 100 kg	Yes	20 - 100 kg	Yes
	>100 kg	-	>100 kg	-	>100 kg	Yes

Table 184: Test requirements - Toppling

5.6 Free fall (packaged)

Test carried out according to EN 60068-2-32	Limits according to EN 61131-2		Limits according to EN 60721-3-2 class 2M1		Limits according to EN 60721-3-2 class 2M2		Limits according to EN 60721-3-2 class 2M3	
Free fall	Devices with delivery packaging each with 5 fall tests		Devices packaged		Devices packaged		Devices packaged	
	Weight	Height	Weight	Height	Weight	Height	Weight	Height
	<10 kg	1.0 m	<20 kg	0.25 m	<20 kg	1.2 m	<20 kg	1.5 m
	10 - 40 kg	0.5 m	20 - 100 kg	0.25 m	20 - 100 kg	1.0 m	20 - 100 kg	1.2 m
	> 40 kg	0.25 m	>100 kg	0.1 m	>100 kg	0.25 m	>100 kg	0.5 m
	Devices with product packaging each with 5 fall tests							
	Weight	Height						
	<10 kg	0.3 m						
	10 - 40 kg	0.3 m						
	> 40 kg	0.25 m						

Table 185: Test requirements - Toppling

6. Climate conditions

Temperature / humidity	Test carried out according to	Limits according to
Worst case operation	UL 508	UL 508: Industrial control equipment EN 61131-2: Programmable logic controllers
Dry heat	EN 60068-2-2	EN 61131-2: Programmable logic controllers
Dry cold	EN 60068-2-1	EN 61131-2: Programmable logic controllers
Large temperature fluctuations	EN 60068-2-14	EN 61131-2: Programmable logic controllers
Temperature fluctuations in operation	EN 60068-2-14	EN 61131-2: Programmable logic controllers
Humid heat, cyclic	EN 60068-2-30	EN 61131-2: Programmable logic controllers
Humid heat, constant (storage)	EN 60068-2-3	EN 61131-2: Programmable logic controllers

Table 186: Overview of limits and testing guidelines for temperature and humidity

6.1 Worst case operation

Test carried out according to UL 508	Limits according to UL 508	Limits according to EN 61131-2	
Worst case during operation. Operation of the device with the max. ambient temperature specified in the data sheet at the max. specified load	3 hours at max. ambient temperature (min. +40°C) duration approx. 5 hours	3 hours at max. ambient temperature (min. +40°C) duration approx. 5 hours	

Table 187: Test requirements - Worst case during operation

6.2 Dry heat

Test carried out according to EN 60068-2-2	Limits according to EN 61131-2		
Dry heat	16 hours at +70°C for 1 cycle, then 1 hour acclimatization and function testing, duration approximately 17 hours		

Table 188: Test requirements - Dry heat

6.3 Dry cold

Test carried out according to EN 60068-2-1	Limits according to EN 61131-2		
Dry cold	16 hours at -40°C for 1 cycle, then 1 hour acclimatization and function testing, duration approximately 17 hours		

Table 189: Test requirements - Dry cold

6.4 Large temperature fluctuations

Test carried out according to EN 60068-2-14	Limits according to EN 61131-2		
Large temperature fluctuations	3 hours at -40°C and 3 hours at +70°C, 2 cycles, then 2 hours acclimatization and function testing, duration approximately 14 hours		

Table 190: Test requirements - Large temperature fluctuations

6.5 Temperature fluctuations in operation

Test carried out according to EN 60068-2-14	Limits according to EN 61131-2		
Open devices: These can also have a housing and are installed in control cabinets	3 hours at +5°C and 3 hours at 55°C, 5 cycles, temperature gradient 3°C / min, the unit is occasionally supplied with voltage during testing, duration approximately 30 hours		
Closed devices: These are devices whose data sheet specifies a surrounding housing (enclosure) with the corresponding safety precautions	3 hours at +5°C and 3 hours at +55°C, 5 cycles, temperature gradient 3°C / min, the unit is occasionally supplied with voltage during testing, duration approximately 30 hours		

Table 191: Test requirements - Temperature fluctuations during operation

6.6 Humid heat, cyclic

Test carried out according to EN 60068-2-30	Limits according to EN 61131-2		
Alternating climate	24 hours at +25°C / +55°C and 97% / 83% RH, 2 cycles, then 2 hours acclimatization, function testing and insulation, duration approximately 50 hours		

Table 192: Test requirements - Humid heat, cyclic

6.7 Humid heat, constant (storage)

Test carried out according to EN 60068-2-3	Limits according to EN 61131-2		
Humid heat, constant (storage)	48 hours at +40°C and 92.5% RH, then insulation test within 3 hours, duration approximately 49 hours		

Table 193: Test requirements - Humid heat, constant (storage)

7. Safety

Safety	Test carried out according to	Limits according to
Ground resistance	EN 61131-2	EN 60204-1: Electrical equipment of machines
		EN 61131-2: Programmable logic controllers
Insulation resistance		EN 60204-1: Electrical equipment of machines
High voltage	EN 60060-1	EN 61131-2: Programmable logic controllers
		UL 508: Industrial control equipment
Residual voltage	EN 61131-2	EN 60204-1: Electrical equipment of machines
		EN 61131-2: Programmable logic controllers
Overload	UL 508	EN 61131-2: Programmable logic controllers
		UL 508: Industrial control equipment
Simulation component defect	UL 508	EN 61131-2: Programmable logic controllers
		UL 508: Industrial control equipment
Voltage range		EN 61131-2: Programmable logic controllers

Table 194: Overview of limits and testing guidelines for safety

7.1 Ground resistance

Test carried out according to EN 61131-2	Limits according to EN 60204-1 ¹⁾		Limits according to EN 61131-2
Ground resistance: housing (from any metal part to the ground terminal)	Smallest effective cross section of the protective ground conductor for the branch being tested	Maximum measured voltage drop at a test current of 10 A	Test current 30 A for 2 min, < 0.1 Ω
	1.0 mm ²	3.3 V	
	1.5 mm ²	2.6 V	
	2.5 mm ²	1.9 V	
	4.0 mm ²	1.4 V	
	> 6.0 mm ²	1.0 V	

Table 195: Test requirements - Ground resistance

1) See EN 60204-1:1997 page 62, table 9.

7.2 Insulation resistance

Test carried out	Limits according to EN 60204-1 ¹⁾		
Insulation resistance: main circuits to protective ground conductor	> 1 MΩ at 500 V DC voltage		

Table 196: Test requirements - Insulation resistance

1) See EN 60204-1:1997 page 62, table 9.

7.3 High voltage

Test carried out according to EN 60060-1	Limits according to EN 61131-2 ¹⁾			Limits according to UL 508			
	Input voltage	Test voltage			Input voltage	Test voltage	
		1.2/50 μ s voltage surge peak	AC, 1 min	DC, 1 min		AC, 1 min	DC, 1 min
High voltage: Primary circuit to secondary circuit and to protective ground circuit (transformers, coils, varistors, capacitors and components used to protect against overvoltage can be removed before the test)	0 - 50 VAC 0 - 60 VDC	850 V	510 V	720 V	≤ 50 V	500 V	707 V
	50 - 100 VAC 60 - 100 VDC	1360 V	740 V	1050 V	> 50 V	$1000 \text{ V} + 2 \times U_N$	$(1000 \text{ V} + 2 \times U_N) \times 1.414$
	100 - 150 VAC 100 - 150 VDC	2550 V	1400 V	1950 V			
	150 - 300 VAC 150 - 300 VDC	4250 V	2300 V	3250 V			
	300 - 600 VAC 300 - 600 VDC	6800 V	3700 V	5250 V			
	600 - 1000 VAC 600 - 1000 VDC	10200 V	5550 V	7850 V			

Table 197: Test requirements - High voltage

1) See EN 61131-2:2003 page 104, table 59.

7.4 Residual voltage

Test carried out according to EN 61131-2	Limits according to EN 60204-1	Limits according to EN 61131-2	
Residual voltage after switching off	< 60 V after 5 sec (active parts) < 60 V after 1 sec (plug pins)	< 60 V after 5 sec (active parts) < 60 V after 1 sec (plug pins)	

Table 198: Test requirements - Residual voltage

7.5 Overload

Test carried out according to UL 508	Limits according to EN 61131-2	Limits according to UL 508	
Overload of transistor outputs	50 switches, $1.5 I_N$, 1 sec on / 9 sec off	50 switches, $1.5 I_N$, 1 sec on / 9 sec off	

Table 199: Test requirements - Overload

7.6 Defective component

Test carried out according to UL 508	Limits according to EN 61131-2	Limits according to UL 508	
Simulation of how components in power supply became defective	Non-flammable surrounding cloth No contact with conductive parts	Non-flammable surrounding cloth No contact with conductive parts	

Table 200: Test requirements - Defective component

7.7 Voltage range

Test carried out according to	Limits according to EN 61131-2			
Supply voltage	Measurement value	Tolerance min/max		
	24 VDC 48 VDC 125 VDC	-15% +20%		
	24 VAC 48 VAC 100 VAC 110 VAC 120 VAC 200 VAC 230 VAC 240 VAC 400 VAC	-15% +10%		

Table 201: Test requirements - Voltage range

8. Other tests

Other tests	Test carried out according to	Limits according to
Protection	-	EN 60529: Degrees of protection provided by enclosures (IP code)

Table 202: Overview of limits and testing guidelines for other tests

8.1 Protection

Test carried out according to	Limits according to EN 60529	Limits according to EN 60529	
Protection of the operating equipment	IP2. Protection against large solid foreign bodies =12.5 mm diameter	IP.6 Protection against large solid foreign bodies: Dust-proof	
Protection of personnel	IP2. Protection against touching dangerous parts with finger	IP.6 Protection against touching dangerous parts with conductor	
Protection against water permeation with damaging consequences	IP.0 Not protected	IP.5 Protected against sprayed water	

Table 203: Test requirements - Protection

9. SDL flex cable - test description

9.1 Torsion

9.1.1 Test structure

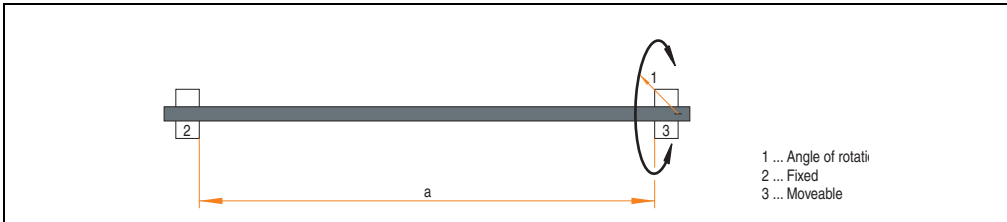

Figure 189: Test structure - torsion

9.1.2 Test conditions

- Distance a: 450 mm
- Rotation angle: $\pm 85^\circ$
- Velocity: 50 cycles / minute
- Special feature: The cable was clamped down twice in the machine.

9.1.3 Individual tests

- Visible pixel errors: At the beginning of the test, the minimum equalizer setting was determined. This is the value between 0-15 at which no more pixel errors are visible. If the equalizer setting is changed due to the mechanical load, this is noted.
- Touch screen for function (with a 21.3" Automation Panel - 5AP920.2138-01)
- USB mouse function
- Hot plug function tested by unplugging the USB plug
- After a test duration of 15000 cycles, the test was ended with a result of "OK".

9.2 Cable drag chain

9.2.1 Test structure

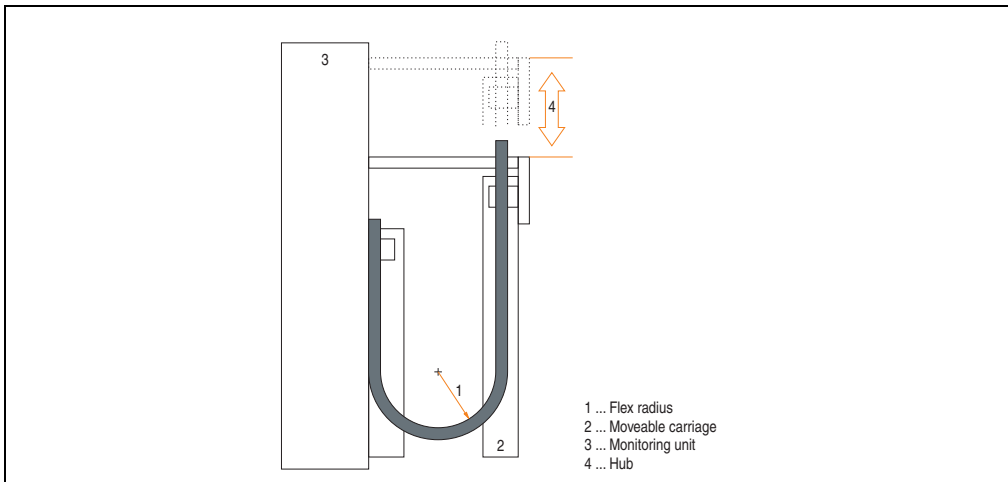

Figure 190: Test structure - Cable drag chain

9.2.2 Test conditions

- Flex radius: 180 mm (= 15 x cable diameter)
- Hub: 460 mm
- Velocity: 4800 cycles / hour
- Special feature: The cable was clamped down twice in the machine.

9.2.3 Individual tests:

- Visible pixel errors: At the beginning of the test, the minimum equalizer setting is determined. This is the value between 0-15 at which no more pixel errors are visible. If the equalizer setting is changed due to the mechanical load, this is noted.
- Touch screen for function (with a 21.3" Automation Panel - 5AP920.2138-01)
- USB mouse function
- Hot plug function tested by unplugging the USB plug
- After a test duration of 30000 cycles, the test was ended with a result of "OK".

10. International certifications

B&R products and services comply with applicable standards. They are international standards from organizations such as ISO, IEC and CENELEC, as well as national standards from organizations such as UL, CSA, FCC, VDE, ÖVE, etc. We give special consideration to the reliability of our products in an industrial environment.



Certifications	
USA and Canada 	All important B&R products are tested and listed by Underwriters Laboratories and checked quarterly by a UL inspector. This mark is valid for the USA and Canada and simplifies certification of your machines and systems in these areas.
Europe 	All harmonized EN standards for the applicable directives are met.

Table 204: International certifications

Chapter 6 • Accessories

1. Overview

Model number	Short description	Note
0AC201.91	Lithium batteries, 4 pcs. Lithium batteries, 4 pcs., 3 V / 950 mAh, button cell	
4A0006.00-000	Lithium battery, 1 pc. Lithium battery, 1 pc., 3 V / 950 mAh, button cell	
0TB103.9	Plug 24V 5.08 3-pin screw clamp 24 VDC 3-pin connector, female. Screw clamps, 2.5 mm ² , protected against vibration by the screw flange	
0TB103.91	Plug 24V 5.08 3-pin cage clamp 24 VDC 3-pin connector, female. Cage clamps, 2.5 mm ² , protected against vibration by the screw flange	
0PS102.0	Power supply, 1-phase, 2.1 A 24 VDC power supply, 1-phase, 2.1 A, input 100-240 VAC, wide range, DIN rail mounting	
0PS104.0	Power supply, 1-phase, 4.2 A 24 VDC power supply, 1 phase, 4.2 A, input 115/230 VAC, auto select, DIN rail mounting	
0PS105.1	Power supply, 1-phase, 5 A 24 VDC power supply, 1 phase, 5 A, input 115/230 VAC, manual select, DIN rail mounting	
0PS105.2	Power supply, 1-phase, 5 A, redundant 24 VDC power supply, 1 phase, 5 A, redundant through parallel operation, input 115/230 VAC, manual select, DIN rail mounting	
0PS110.1	Power supply, 1-phase, 10 A 24 VDC power supply, 1 phase, 10 A, input 115/230 VAC, manual select, DIN rail mounting	
0PS110.2	Power supply, 1-phase, 10 A, redundant 24 VDC power supply, 1 phase, 10 A, redundant through parallel operation, input 115/230 VAC, manual select, DIN rail mounting	
0PS120.1	Power supply, 1-phase, 20 A 24 VDC power supply, 1 phase, 20 A, input 115/230 VAC, auto select, DIN rail mounting	
0PS305.1	Power supply, 3-phase, 5 A 24 VDC power supply, 3-phase, 5 A, input 400..500 VAC (3 phases), wide range, DIN rail mounting	
0PS310.1	Power supply, 3-phase, 10 A 24 VDC power supply, 3-phase, 10 A, input 400..500 VAC (3 phases), wide range, DIN rail mounting	
0PS320.1	Power supply, 3-phase, 20 A 24 VDC power supply, 3-phase, 20 A, input 400..500 VAC (3 phases), wide range, DIN rail mounting	

Table 205: Model numbers - Accessories

Accessories • Overview

Model number	Short description	Note
0PS340.1	Power supply, 3-phase, 40 A 24 VDC power supply, 3-phase, 40 A, input 400..500 VAC (3 phases), wide range, DIN rail mounting	
9A0100.11	UPS 24 VDC 24 VDC input, 24 VDC output, serial interface	
9A0100.14	UPS battery unit type B 24 V; 2.2 Ah; including battery cage	
9A0100.15	UPS battery unit type B (replacement part) 2 x 12 V; 2.2 Ah; for battery unit 9A0100.14	
9A0017.01	RS232 Null Modem Cable, 0.6 m To connect UPS and load system (9-pin DSUB socket - 9-pin DSUB socket)	
9A0017.02	RS232 Null Modem Cable, 1.8 m To connect UPS and load system (9-pin DSUB socket - 9-pin DSUB socket)	
4A0006.00-000	Lithium battery, 1 pc. Lithium battery, 1 pc., 3 V / 950 mAh, button cell	
5A5003.03	Front cover Front cover for the USB 2.0 Media Drive 5MD900.USB2-01.	
5AC600.ICOV-00	Interface covers Interface covers for APC620 and PPC700 devices; 5 pieces	
5AC900.1000-00	Adapter DVI-A/m to CRT DB15HD/f Adapter DVI (plug) to CRT (socket), for connecting a standard monitor DVI-I interface.	
5AC900.104X-00	Legend strip template 10.4" For Panel PC 5PC781.1043-00. For 1 device.	
5AC900.104X-01	Legend strip template 10.4" For Panel PC 5PC782.1043-00. For 1 device.	
5AC900.150X-01	Legend strip template 15" For Panel PC 5PC781.1505-00. For 4 devices.	
5AC900.1200-00	USB port cap (attached) Front side USB port cap (attached) for Automation Panel 900 and Panel PC 700 devices.	
5AC900.1200-01	USB port cap IP65 M20 /2 Front-side USB port cap (attached) knurled, short, not slotted.	
5AC900.1200-02	USB port cap IP65 M20 /3 Front-side USB port cap (attached) knurled, tall, not slotted.	
5AC900.1200-03	USB port cap IP65 M20 /4 Front-side USB port cap (attached) knurled, tall, slotted.	
5CFCRD.0512-06	CompactFlash 512 MB B&R CompactFlash card with 512 MB SLC NAND flash and IDE/ATA interface	
5CFCRD.1024-06	CompactFlash 1024 MB B&R CompactFlash card with 1024 MB SLC NAND flash and IDE/ATA interface	
5CFCRD.2048-06	CompactFlash 2048 MB B&R CompactFlash card with 2048 MB SLC NAND flash and IDE/ATA interface	
5CFCRD.4096-06	CompactFlash 4096 MB B&R CompactFlash card with 4096 MB SLC NAND flash and IDE/ATA interface	
5CFCRD.8192-06	CompactFlash 8192 MB B&R CompactFlash card with 8192 MB SLC NAND flash and IDE/ATA interface	

Table 205: Model numbers - Accessories

Model number	Short description	Note
5CFCRD.016G-06	CompactFlash 16 GB B&R CompactFlash card with 16 GB SLC NAND flash and IDE/ATA interface	
5CFCRD.032G-06	CompactFlash 32 GB B&R CompactFlash card with 32 GB SLC NAND flash and IDE/ATA interface	
5CFCRD.0512-04	CompactFlash 512 MB B&R CompactFlash card with 512 MB SLC NAND flash and IDE/ATA interface	
5CFCRD.1024-04	CompactFlash 1024 MB B&R CompactFlash card with 1024 MB SLC NAND flash and IDE/ATA interface	
5CFCRD.2048-04	CompactFlash 2048 MB B&R CompactFlash card with 2048 MB SLC NAND flash and IDE/ATA interface	
5CFCRD.4096-04	CompactFlash 4096 MB B&R CompactFlash card with 4096 MB SLC NAND flash and IDE/ATA interface	
5CFCRD.8192-04	CompactFlash 8192 MB B&R CompactFlash card with 8192 MB SLC NAND flash and IDE/ATA interface	
5CFCRD.016G-04	CompactFlash 16 GB B&R CompactFlash card with 16 GB SLC NAND flash and IDE/ATA interface	
5CFCRD.0064-03	CompactFlash 64 MB SSI CompactFlash card with 64 MB SLC NAND flash and IDE/ATA interface	
5CFCRD.0128-03	CompactFlash 128 MB SSI CompactFlash card with 128 MB SLC NAND flash and IDE/ATA interface	
5CFCRD.0256-03	CompactFlash 256 MB SSI CompactFlash card with 256 MB SLC NAND flash and IDE/ATA interface	
5CFCRD.0512-03	CompactFlash 512 MB SSI CompactFlash card with 512 MB SLC NAND flash and IDE/ATA interface	
5CFCRD.1024-03	CompactFlash 1024 MB SSI CompactFlash card with 1024 MB SLC NAND flash and IDE/ATA interface	
5CFCRD.2048-03	CompactFlash 2048 MB SSI CompactFlash card with 2048 MB SLC NAND flash and IDE/ATA interface	
5CFCRD.4096-03	CompactFlash 4096 MB SSI CompactFlash card with 4096 MB SLC NAND flash and IDE/ATA interface	
5CFCRD.8192-03	CompactFlash 8192 MB SSI CompactFlash card with 8192 MB SLC NAND flash and IDE/ATA interface	
5MD900.USB2-01	USB 2.0 drive DVD-RW/CD-RW FDD CF USB USB 2.0 drive combination; consists of DVD-R/RW DVD+R/RW, FDD, CompactFlash slot (type II), USB connection (type A front, type B back); 24V DC; (Order OTB103.9 screw clamp or OTB103.91 cage clamps separately).	
5AC600.SRAM-00	APC620/PPC700 SRAM module 512kB 512 KB SRAM module for APC620 and PPC700.	
5MMUSB.2048-00	USB flash drive 2 GB SanDisk USB 2.0 flash drive 2 GB	
5MMUSB.2048-01	USB flash drive 2 GB B&R USB 2.0 flash drive 2 GB	
5SWHMI.0000-00	HMI Drivers & Utilities DVD	
5CADVI.0018-00	DVI-D cable 1.8 m / single Single cable, DVI-D/m:DVI-D/m; length: 1.8 m	

Table 205: Model numbers - Accessories

Accessories • Overview

Model number	Short description	Note
5CADVI.0050-00	DVI-D cable 5 m / single Single cable, DVI-D/m:DVI-D/m; length: 5 m	
5CADVI.0100-00	DVI-D cable 10 m / single Single cable, DVI-D/m:DVI-D/m; length: 10 m	
5CASDL.0018-00	SDL cable 1.8 m SDL cable for a fixed type of layout; length: 1.8 m	
5CASDL.0018-01	SDL cable 1.8 m 45° SDL cable for fixed type of layout with one-sided 45° plug; length: 1.8 m	
5CASDL.0018-03	SDL flex cable 1.8 m SDL cable for fixed and flexible type of layout; length: 1.8 m	
5CASDL.0050-00	SDL cable 5 m SDL cable for a fixed type of layout; length: 5 m	
5CASDL.0050-01	SDL cable 5 m 45° SDL cable for fixed type of layout with one-sided 45° plug; length: 5 m	
5CASDL.0050-03	SDL flex cable 5 m SDL cable for fixed and flexible type of layout; length: 5 m	
5CASDL.0100-00	SDL cable 10 m SDL cable for a fixed type of layout; length: 10 m	
5CASDL.0100-01	SDL cable 10 m 45° SDL cable for fixed type of layout with one-sided 45° plug; length: 10 m	
5CASDL.0100-03	SDL flex cable 10 m SDL cable for fixed and flexible type of layout; length: 10 m	
5CASDL.0150-00	SDL cable 15 m SDL cable for a fixed type of layout; length: 15 m	
5CASDL.0150-01	SDL cable 15 m 45° SDL cable for fixed type of layout with one-sided 45° plug; length: 15 m	
5CASDL.0150-03	SDL flex cable 15 m SDL cable for fixed and flexible type of layout; length: 15 m	
5CASDL.0200-00	SDL cable 20 m SDL cable for a fixed type of layout; length: 20 m	
5CASDL.0200-03	SDL flex cable 20 m SDL cable for fixed and flexible type of layout; length: 20 m	
5CASDL.0250-00	SDL cable 25 m SDL cable for a fixed type of layout; length: 25 m	
5CASDL.0250-03	SDL flex cable 25 m SDL cable for fixed and flexible type of layout; length: 25 m	
5CASDL.0300-00	SDL cable 30 m SDL cable for a fixed type of layout; length: 30 m	
5CASDL.0300-03	SDL flex cable 30 m SDL cable for fixed and flexible type of layout; length: 30 m	
5CASDL.0300-13	SDL flex cable with extender 30 m SDL cable with extender for fixed and flexible type of layout; length: 30 m	
5CASDL.0400-13	SDL flex cable with extender 40 m SDL cable with extender for fixed and flexible type of layout; length: 40 m	
9A0014.02	RS232 cable DB9/f:DB9/m 1.8 m RS232 extension cable for remote operation of a display unit with touch screen; length 1.8 m.	

Table 205: Model numbers - Accessories

Model number	Short description	Note
9A0014.05	RS232 cable DB9/f:DB9/m 5 m RS232 extension cable for remote operation of a display unit with touch screen; length 5 m.	
9A0014.10	RS232 cable DB9/f:DB9/m 10 m RS232 extension cable for remote operation of a display unit with touch screen; length 10 m.	
5CAUSB.0018-00	USB 2.0 cable, A/m:B/m 1.8 m USB 2.0 connection cable; plug type A - type B; length 1.8 m	
5CAUSB.0050-00	USB 2.0 cable, A/m:B/m 5 m USB 2.0 connection cable; plug type A - type B; length 5 m	
5AC700.FA00-00	PPC700 replacement fan filter 0PCI 5 piece For Panel PC 700 10.4", 12.1", 15", 17" and 19" with 0 PCI slots (5PC720.1043-00, 5PC720.1214-00, 5PC720.1505-00, 5PC720.1706-00, 5PC720.1906-00, 5PC781.1043-00, 5PC781.1505-00 and 5PC782.1043-00).	
5AC700.FA02-00	PPC700 replacement fan filter 1.2PCI 5 piece For Panel PC 700 10.4" and 15" with 1 and 2 PCI slots (5PC720.1043-01, 5PC720.1214-01, 5PC720.1505-01 and 5PC720.1505-02).	
5ACPCI.ETH1-01	PCI Ethernet card 10/100 half size PCI Ethernet card, 1 Ethernet connection	
5ACPCI.ETH3-01	PCI Ethernet card 10/100 3port half size PCI Ethernet card, 3 Ethernet connections	

Table 205: Model numbers - Accessories

2. Replacement CMOS batteries

The lithium battery is needed for buffering the BIOS and real-time clock.

The battery is subject to wear and must be replaced when the battery power ("Bad" status) is insufficient (see "Changing the battery", on page 453).

2.1 Order data

Model number	Description	Image
0AC201.91	Lithium batteries, 4 pcs., 3 V / 950 mAh button cell	
4A0006.00-000	Lithium battery, 1 piece, 3 V / 950 mAh button cell	

Table 206: Order data - Lithium batteries

2.2 Technical data

Information:

The following characteristics, features and limit values only apply to this accessory and can deviate those specified for the entire device. For the entire device where this accessory is installed, refer to the data provided specifically for the entire device.

Features	0AC201.91	4A0006.00-000
Capacity	950 mAh	
Voltage	3 V	
Self discharge at 23°C	< 1% per year	
Storage time	Max. 3 years at 30° C	
Environment		
Storage temperature	-20 to +60°C	
Relative humidity	0 to 95% (non-condensing)	

Table 207: Technical data - Lithium batteries

3. Supply voltage connector (TB103 3-pin)

3.1 General Information

This single row 3-pin terminal block is mainly used to connect the supply voltage.

3.2 Order data



Model number	Description	Image
0TB103.9	Plug for the 24 V supply voltage (screw clamps)	 <p>0TB103.9</p>  <p>0TB103.91</p>
0TB103.91	Plug for the 24 V supply voltage (cage clamps)	

Table 208: Order data - TB103

3.3 Technical data

Information:

The following characteristics, features and limit values only apply to this accessory and can deviate those specified for the entire device. For the entire device where this accessory is installed, refer to the data provided specifically for the entire device.

Name	0TB103.9	0TB103.91
Number of pins	3	
Type of terminal	Screw clamps	Cage clamps
Distance between contacts	5.08 mm	

Table 209: TB103 Technical data

Accessories • Supply voltage connector (TB103 3-pin)

Name	0TB103.9	0TB103.91
Resistance between contacts	$\leq 5 \text{ m}\Omega$	
Nominal voltage according to VDE / UL,CSA	250 V / 300 V	
Current load according to VDE / UL,CSA	14.5 A / 10 A per contact	
Terminal size	0.08 mm ² - 3.31 mm ²	
Cable type	Copper wires only (no aluminum wires!)	

Table 209: TB103 Technical data (Forts.)

4. Power supplies

In order to meet demands for complete, comprehensive system solutions, power supplies are available in the B&R product line for mounting rail installation. This extensive spectrum ranges from single-phase power supplies that supply 2.1 A up to three-phase power supplies that supply 40 A. All switching power supplies can handle a wide range of AC and DC input voltages. This input ranges from 100 to 240 VAC or 400 to 500 VAC and from 85 to 375 VDC. Devices are protected against short circuit, overload, and open circuit, which allows them to be operated without functional limitations or derating even when overloads between 15% and 25% occur.



Figure 191: B&R power supplies (examples)

Two mini power supplies (PS102 and PS104) in robust plastic housing are available in the lower performance range. A well-designed cooling concept allows several different mounting orientations. The functional DIN rail allows fast mounting and removal. Wiring is essentially performed in seconds thanks to the spring clamps being used. The compact design, easy mounting and several different mounting orientations make the two smallest power supplies in this product line components that can be used practically anywhere.

4.1 Model numbers and brief technical overview

The technical data listed in the following tables should act as a brief selection guide. For more detailed technical data, data sheets are available for download from production description section of the B&R homepage (www.br-automation.com).

4.1.1 Single-phase power supplies

Features	0PS102.0	0PS104.0	0PS105.1	0PS105.2	0PS110.1	0PS110.2	0PS120.1
Output Power	50 W	100 W	120 W	120 W	240 W	240 W	480 W
AC input voltage	85-264 V	85-132 V 184-264 V	85-132 V 176-264 V	85-132 V 176-264 V	85-132 V 176-264 V	85-132 V 176-264 V	85-132 V 176-264 V
DC input voltage	85-375 V	220-375 V	210-375 V	210-375 V	210-375 V	210-375 V	-
Output voltage	24-28 V	24-28 V	24 V	24 V	24-28 V	24-28 V	24-28 V
Output current at 24 V	2.1 A	4.2 A	5 A	5 A	10 A	10 A	20 A
Parallel operation	No	Yes	Yes	Yes	Yes	Yes	Yes
Current balancing	No	Yes	No	Yes	No	Yes	Yes

Table 210: Single-phase power supplies

4.1.2 Three-phase power supplies

Features	0PS305.1	0PS310.1	0PS320.1	0PS340.1
Output Power	120 W	240 W	490 W	960 W
AC input voltage	340-576 V	340-576 V	340-576 V	340-576 V
DC input voltage	450-820 V	450-820 V	450-820 V	450-820 V
Output voltage	24-28 V	24-28 V	24 V	24 V
Output current at 24 V	5 A	10 A	20 A	40 A
Parallel operation	Yes	Yes	Yes	Yes
Current balancing	No	Yes	Yes	Yes

Table 211: Three-phase power supplies

5. External UPS

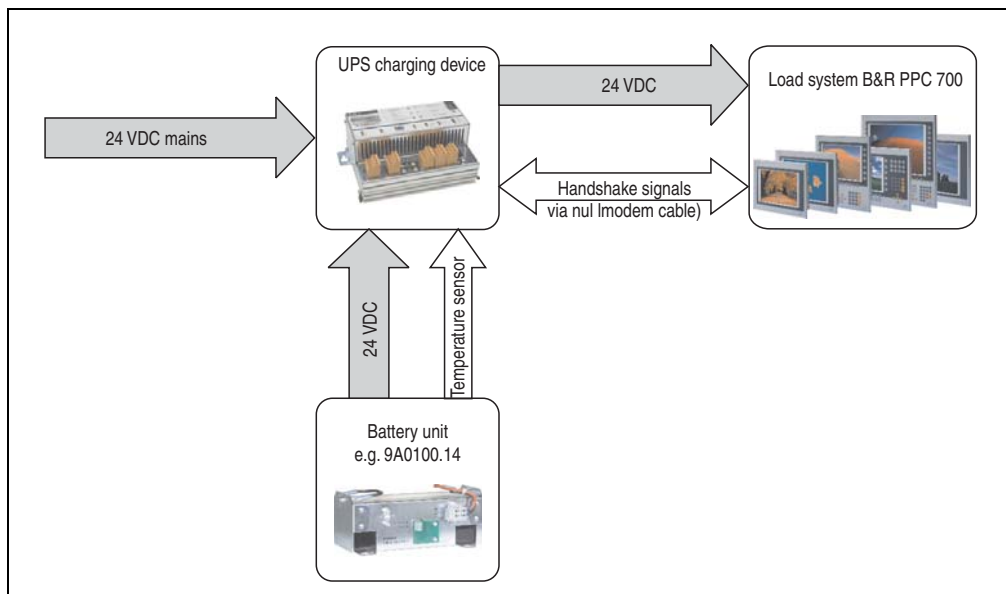

Figure 192: Block diagram of the UPS

5.1 General Information

For supply with an external UPS, a UPS charging unit, a battery unit and a null modem cable are required.

In normal operation, the 24 VDC supply voltage is put straight through to the load system. If the supply voltage fails, the rechargeable UPS batteries power the PC to allow controlled shutdown without loss of data.

Data and commands are exchanged between the UPS and the load system via the handshake signals for an RS232 interface.

More information concerning an external UPS is available in the "UPS manual", which can be downloaded from the B&R homepage (www.br-automation.com).

5.2 Order data

Model number	Description	Note
9A0100.11	UPS 24 VDC 24 VDC input, 24 VDC output, serial interface	
9A0100.14	UPS battery unit type B 24 V; 2.2 Ah; including battery cage	
9A0100.15	UPS battery unit type B (replacement part) 2 x 12 V; 2.2 Ah; for battery unit 9A0100.14	
9A0017.01	RS232 Null Modem Cable, 0.6 m To connect UPS and load system (9-pin DSUB socket - 9-pin DSUB socket)	
9A0017.02	RS232 Null Modem Cable, 1.8 m To connect UPS and load system (9-pin DSUB socket - 9-pin DSUB socket)	

Table 212: UPS - Order data

6. Interface covers 5AC600.ICOV-00

The interface covers protect interfaces from dirt and dust when not in use.

6.1 Order data

Model number	Description	Image
5AC600.ICOV-00	Interface covers Interface covers for APC620 and PPC700 devices; 5 pieces	

Table 213: Order data - PPC700 interface cover

6.2 Contents of delivery

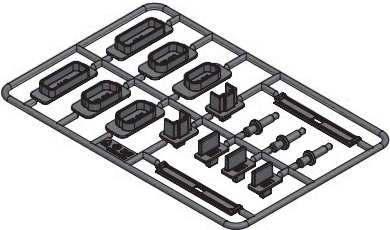
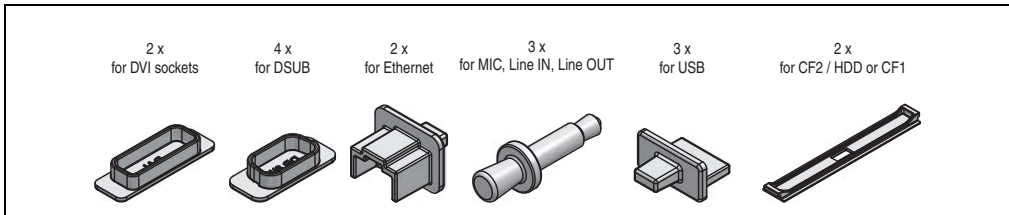

Figure 193: Interface cover - contents of delivery

Information:

The CF card interface cover cannot be used on PPC700 devices.

7. DVI - monitor adapter 5AC900.1000-00

This adapter enables a standard monitor to be connected to the DVI-I interface.

7.1 Order data

Model number	Description	Image
5AC900.1000-00	Adapter DVI-A/m to CRT DB15HD/f Adapter DVI (plug) to CRT (socket), for connecting a standard monitor to a DVI-I interface.	

Table 214: Order data - DVI - CRT adapter

8. USB port cap (attached) - Discontinued

Front side USB port cap (attached) for Automation Panel 900 and Panel PC 700 devices.

8.1 Order data

Model number	Description	Image
5AC900.1200-00	USB port cap (attached) Front side USB port cap (attached) for Automation Panel 900 and Panel PC 700 devices.	

Table 215: Order data - USB port cap (attached)

8.2 Installation

- Remove old cover.
- Feed the USB port cap through the small opening (see red markings).

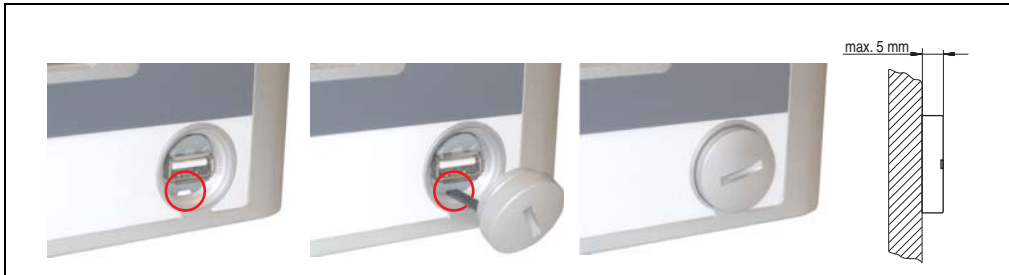

Figure 194: Front side USB port cap - installation

- With the cover screwed on, the front side of the display is raised a maximum of 5 mm.

9. USB port cap (attached)

Front side USB port cap (attached) for Automation Panel 900, Panel PC 700 and Panel PC 800 devices.

9.1 Order data



Model number	Description	Image
5AC900.1200-01	USB port cap IP65 M20 /2 Front-side USB port cap (attached) knurled, short, not slotted.	 <p>5AC900.1200-02</p>  <p>5AC900.1200-03</p>
5AC900.1200-02	USB port cap IP65 M20 /3 Front-side USB port cap (attached) knurled, tall, not slotted.	
5AC900.1200-03	USB port cap IP65 M20 /4 Front-side USB port cap (attached) knurled, tall, slotted.	

Table 216: Order data - USB port cap (attached)

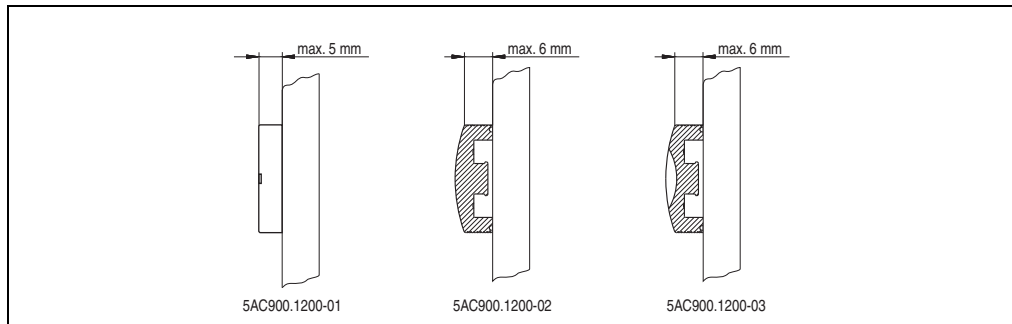

Figure 195: USB port cap (attached) - Height

10. CompactFlash cards 5CFCRD.xxxx-06

10.1 General information

Information:

B&R CompactFlash cards 5CFCRD.xxxx-06 and CompactFlash cards from a different manufacturer cannot be used in the same system at the same time. Due to differences in technology (older vs. newer technologies), problems can occur during system startup that are caused by the different boot times.

See chapter 3 "Commissioning" section 12 "Known problems / issues", on page 247.

Information:

The 5CFCRD.xxxx-06 CompactFlash cards are supported on B&R devices with WinCE Version ≥ 6.0 .

10.2 Order data

Model number	Description	Figure
5CFCRD.0512-06	CompactFlash 512 MB B&R (SLC)	 <p>CompactFlash card</p>
5CFCRD.1024-06	CompactFlash 1 GB B&R (SLC)	
5CFCRD.2048-06	CompactFlash 2 GB B&R (SLC)	
5CFCRD.4096-06	CompactFlash 4 GB B&R (SLC)	
5CFCRD.8192-06	CompactFlash 8 GB B&R (SLC)	
5CFCRD.016G-06	CompactFlash 16 GB B&R (SLC)	
5CFCRD.032G-06	CompactFlash 32 GB B&R (SLC)	

Table 217: Order data - CompactFlash cards

10.3 Technical data

Caution!

A sudden loss of power may result in data loss! In very rare cases, mass memory may also be damaged.

To prevent damage and loss of data, it is recommended to use a UPS device.

Information:

The following characteristics, features and limit values only apply to this accessory and can deviate from those specified for the fully assembled device. The data specifications for the fully assembled device take precedence over those of individual components.

Features	5CFCRD. 0512-06	5CFCRD. 1024-06	5CFCRD. 2048-06	5CFCRD. 4096-06	5CFCRD. 8192-06	5CFCRD. 016G-06	5CFCRD. 032G-06
Capacity	512 MB	1 GB	2 GB	4 GB	8 GB	16 GB	32 GB
MTBF (at 25°C)	>3,000,000 hours (at 25°C)						
Maintenance	None						
Data reliability	< 1 unrecoverable error in 10 ¹⁴ bit read accesses						
Data retention	10 years						
Lifetime monitoring	Yes						
Supported operating modes	PIO Mode 0-6, Multiword DMA Mode 0-4, Ultra DMA Mode 0-4						
Continuous reading							
Typical	33 MB/s	33 MB/s	33 MB/s	33 MB/s	33 MB/s	36 MB/s	36 MB/s
Maximum	35 MB/s	35 MB/s	35 MB/s	34 MB/s	34 MB/s	37 MB/s	37 MB/s
Continuous writing							
Typical	15 MB/s	15 MB/s	15 MB/s	14 MB/s	14 MB/s	28 MB/s	28 MB/s
Maximum	18 MB/s	18 MB/s	18 MB/s	17 MB/s	17 MB/s	30 MB/s	30 MB/s
Endurance							
Guaranteed data volume							
Guaranteed ¹⁾	50 TB	100 TB	200 TB	400 TB	800 TB	1600 TB	3200 TB
Results for 5 years ¹⁾	27.40 GB/day	54.79 GB/day	109.59 GB/day	219.18 GB/day	438.36 GB/day	876.72 GB/day	1753.44 GB/day
Clear/write cycles							
Guaranteed	100,000						
SLC flash	Yes						
Wear leveling	Static						
Error Correction Coding (ECC)	Yes						

Table 218: Technical data - 5CFCRD.xxxx-06 CompactFlash cards

Accessories • CompactFlash cards 5CFCRD.xxxx-06

Endurance	5CFCRD. 0512-06	5CFCRD. 1024-06	5CFCRD. 2048-06	5CFCRD. 4096-06	5CFCRD. 8192-06	5CFCRD. 016G-06	5CFCRD. 032G-06
S.M.A.R.T. Support	Yes						
Support							
Hardware	PP300/400, PP500, PPC300, PPC700, PPC725, PPC800, APC620, APC810, APC820						
Windows XP Professional	No	No	No	Yes	Yes	Yes	Yes
Windows XP Embedded	Yes	Yes	Yes	Yes	Yes	Yes	Yes
Windows Embedded Standard 2009	No	Yes	Yes	Yes	Yes	Yes	Yes
Windows CE 6.0	Yes	Yes	Yes	Yes	Yes	Yes ²⁾	Yes ²⁾
Windows CE 5.0	No	No	No	No	No	No	No
PVI Transfer	≥ V3.2.3.8 (part of PVI Development t Setup ≥ V2.06.00.30 11)	≥ V3.2.3.8 (part of PVI Development t Setup ≥ V2.06.00.30 11)	≥ V3.2.3.8 (part of PVI Development t Setup ≥ V2.06.00.30 11)	≥ V3.2.3.8 (part of PVI Development t Setup ≥ V2.06.00.30 11)	≥ V3.2.3.8 (part of PVI Development t Setup ≥ V2.06.00.30 11)	≥ V3.6.8.40 (part of PVI Development t Setup ≥ V3.0.0.3020)	≥ V4.0.0.8 (part of PVI Development t Setup ≥ V3.0.2.3014)
B&R Embedded OS Installer	≥ V3.10	≥ V3.10	≥ V3.10	≥ V3.10	≥ V3.10	≥ V3.20	≥ V3.21
Mechanical characteristics							
Dimensions Length Width Thickness	36.4 ±0.15 mm 42.8 ±0.10 mm 3.3 ±0.10 mm						
Weight	10 g						
Environmental characteristics							
Ambient temperature Operation Storage Transport	0 to 70°C -65 to 150°C -65 to 150°C						
Relative humidity Operation/Storage/Transport	Max. 85% at 85°C						
Vibration Operation/Storage/Transport	20 G peak, 20- 2000 Hz, 4 in each direction (JEDEC JESD22, method B103) 5.35 G RMS, 15 min per level (IEC 68-2-6)						
Shock Operation/Storage/Transport	1.5k G peak, 0.5 ms 5 times (JEDEC JESD22, method B110) 30 G, 11 ms 1 time (IEC 68-2-27)						
Altitude	Max. 4572 m						

Table 218: Technical data - 5CFCRD.xxxx-06 CompactFlash cards (Forts.)

1) Endurance of B&R CFs (with linear written block size 128 kB)

2) Not supported by B&R Embedded OS installer.

10.3.1 Temperature humidity diagram

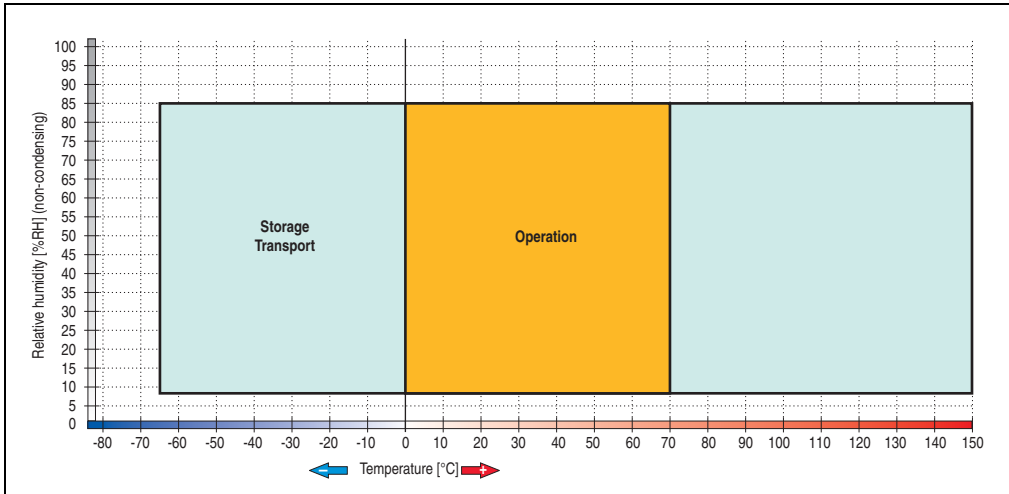

Figure 196: Temperature humidity diagram - CompactFlash cards 5CFCRD.xxxx-06

10.4 Dimensions

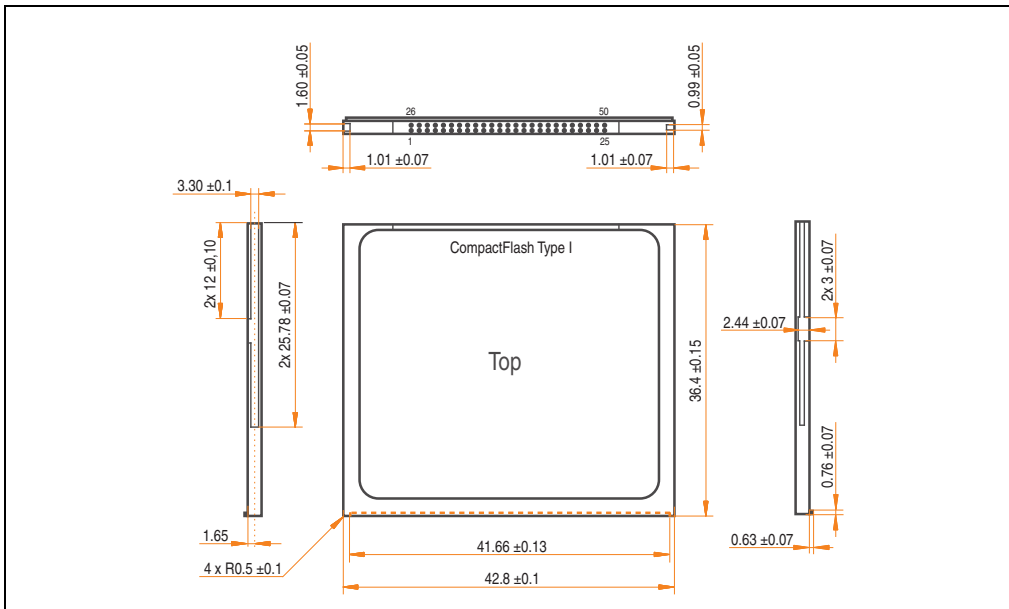

Figure 197: Dimensions - CompactFlash card Type I

10.5 Benchmark

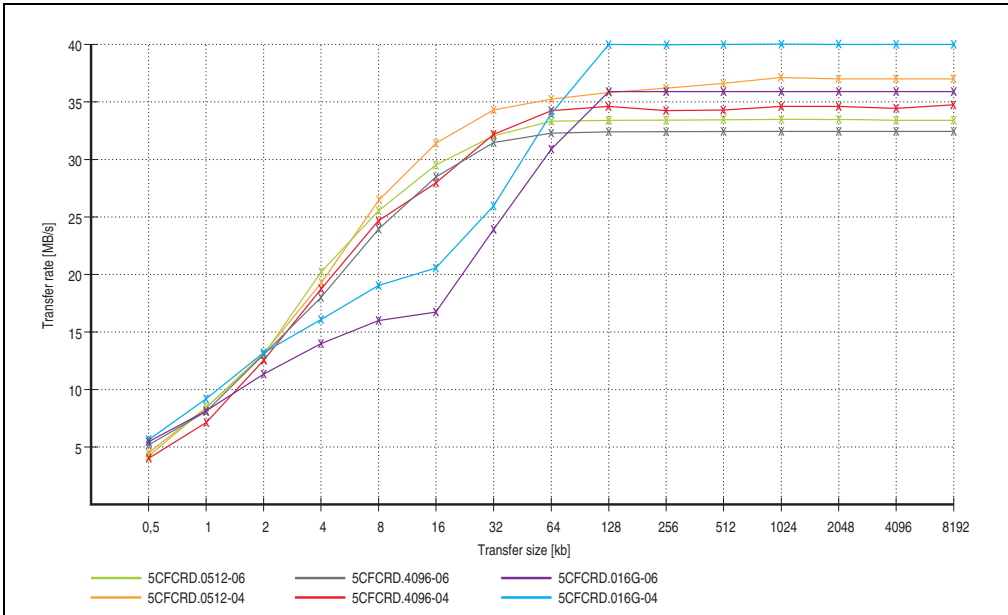

Figure 198: ATTO Benchmark v2.34 comparison when reading - 5CFCRD.xxxx-04 with 5CFCRD.xxxx-06

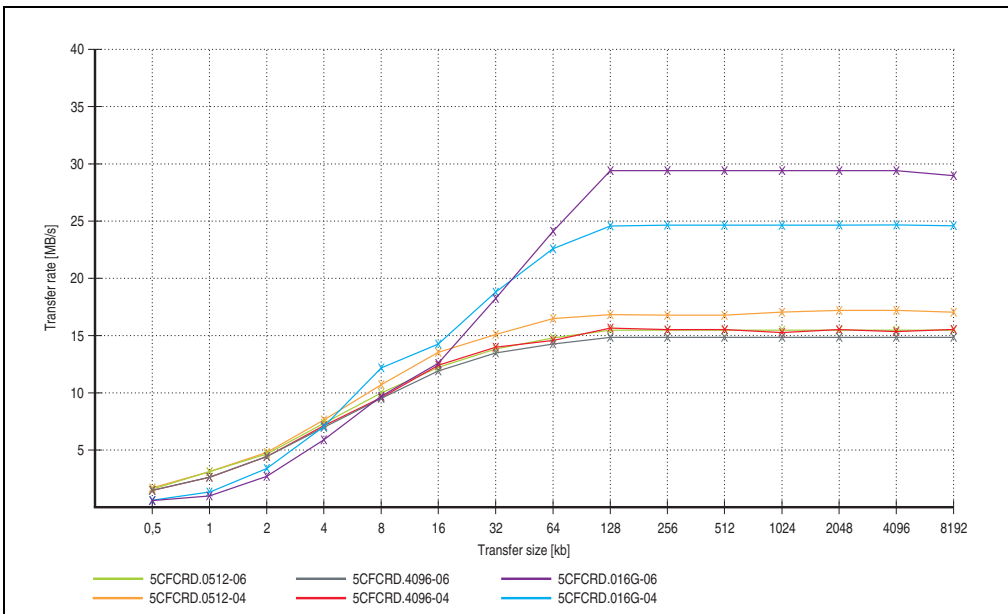

Figure 199: ATTO Benchmark v2.34 comparison when writing - 5CFCRD.xxxx-04 with 5CFCRD.xxxx-06

11. CompactFlash cards 5CFCRD.xxxx-04

11.1 General Information

Information:

B&R CompactFlash cards 5CFCRD.xxxx-04 and CompactFlash cards from a different manufacturer cannot be used in the same system at the same time. Due to differences in technology (older vs. newer technologies), problems can occur during system startup that are caused by the different boot times.

See chapter 3 "Commissioning", section 12 "Known problems / issues", on page 247.

Information:

The 5CFCRD.xxxx-04 CompactFlash cards are supported on B&R devices with WinCE Version 6.0 or higher.

11.2 Order data

Model number	Description	Image
5CFCRD.0512-04	512 MB B&R CompactFlash card	 <p>CompactFlash card</p>
5CFCRD.1024-04	1024 MB B&R CompactFlash card	
5CFCRD.2048-04	2048 MB B&R CompactFlash card	
5CFCRD.4096-04	4096 MB B&R CompactFlash card	
5CFCRD.8192-04	8192 MB B&R CompactFlash card	
5CFCRD.016G-04	16 GB B&R CompactFlash card	

Table 219: Order data - CompactFlash cards

11.3 Technical data

Caution!

A sudden loss of power can cause data to be lost! In very rare cases, the mass memory may also become damaged.

To prevent damage and loss of data, it is recommended to use a UPS device.

Information:

The following characteristics, features and limit values only apply to this accessory and can deviate those specified for the entire device. For the entire device where this accessory is installed, refer to the data provided specifically for the entire device.

Features	5CFCRD.0512-04	5CFCRD.1024-04	5CFCRD.2048-04	5CFCRD.4096-04	5CFCRD.8192-04	5CFCRD.016G-04
MTBF (at 25°C)	> 3,000,000 hours					
Maintenance	None					
Data reliability	< 1 unrecoverable error in 10 ¹⁴ bit read accesses					
Data retention	10 years					
Lifetime monitoring	Yes					
Supported operating modes	PIO Mode 0-6, Multiword DMA Mode 0-4, Ultra DMA Mode 0-4					
Continuous reading	Typically 35 MB/s (240X) ¹⁾²⁾ Max. 37 MB/s (260X) ¹⁾²⁾	Typically 35 MB/s (240X) ¹⁾²⁾ Max. 37 MB/s (260X) ¹⁾²⁾	Typically 35 MB/s (240X) ¹⁾²⁾ Max. 37 MB/s (260X) ¹⁾²⁾	Typically 33 MB/s (220X) ¹⁾²⁾ Max. 34 MB/s (226X) ¹⁾²⁾	Typically 27 MB/s (180X) ¹⁾²⁾ Max. 28 MB/s (186X) ¹⁾²⁾	Typically 36 MB/s (240X) ¹⁾²⁾ Max. 37 MB/s (247X) ¹⁾²⁾
Continuous writing	Typically 17 MB/s (110X) Max. 20 MB/s (133X)	Typically 17 MB/s (110X) Max. 20 MB/s (133X)	Typically 17 MB/s (110X) Max. 20 MB/s (133X)	Typically 16 MB/s (106X) Max. 18 MB/s (120X)	Typically 15 MB/s (100X) Max. 17 MB/s (110X)	Typically 18 MB/s (120X) Max. 19 MB/s (126X)
Endurance						
Guaranteed amount of data ³⁾ Results in 5 years ³⁾	50 TB 27.40 GB/day	100 TB 54.79 GB/day	200 TB 109.59 GB/day	400 TB 219.18 GB/day	800 TB 438.36 GB/day	1600 TB 876.72 GB/day
Clear/write cycles Guaranteed Typical ⁴⁾	100,000 2,000,000					
SLC flash	Yes					
Wear leveling	Static					
Error Correction Coding (ECC)	Yes					

Table 220: Technical data - CompactFlash cards 5CFCRD.xxxx-04

Accessories • CompactFlash cards 5CFCRD.xxxx-04

Support	5CFCRD.0512-04	5CFCRD.1024-04	5CFCRD.2048-04	5CFCRD.4096-04	5CFCRD.8192-04	5CFCRD.016G-04
Hardware	PP300/400, PPC300, PPC700, PPC800, APC620, APC810, APC820					
Windows XP Professional	-	-	-	Yes	Yes	Yes
Windows XP Embedded	Yes	Yes	Yes	Yes	Yes	Yes
Windows CE 6.0	Yes	Yes	Yes	Yes	Yes	Yes ⁵⁾
Windows CE 5.0	-	-	-	-	-	-
PVI Transfer Tool	V3.2.3.8 (part of PVI Development Setup V2.06.00.3011)					-
B&R Embedded OS Installer	V3.10					-
Mechanical characteristics						
Dimensions						
Length	36.4 ±0.15 mm					
Width	42.8 ±0.10 mm					
Thickness	3.3 ±0.10 mm					
Weight	10 g					
Environmental characteristics						
Ambient temperature						
Operation	0 to +70°C					
Storage	-65 to +150°C					
Transport	-65 to +150°C					
Relative humidity						
Operation/Storage/Transport	Max. 85% at 85°C					
Vibration						
Operation/Storage/Transport	20 G peak, 20- 2000 Hz, 4 in each direction (JEDEC JESD22, method B103) 5.35 G RMS, 15 min per level (IEC 68-2-6)					
Shock						
Operation/Storage/Transport	1.5k G peak, 0.5 ms 5 times (JEDEC JESD22, method B110) 30 G, 11 ms 1 time (IEC 68-2-27)					
Altitude	Max. 15,000 feet (4,572 m)					

Table 220: Technical data - CompactFlash cards 5CFCRD.xxxx-04 (Forts.)

- 1) Speed specification with 1X = 150 KB/s. All specifications refer to the Samsung Flash chips, CompactFlash cards in UDMA mode 4, 30 ns cycle time in True-IDE mode with sequential write/read test.
- 2) The file is written/read sequentially in True IDE mode with the DOS program Thruput.exe.
- 3) Endurance of B&R CF cards (linear written block size with 128 kB)
- 4) Depending on the average file size.
- 5) Not supported by B&R Embedded OS installer.

11.3.1 Temperature humidity diagram

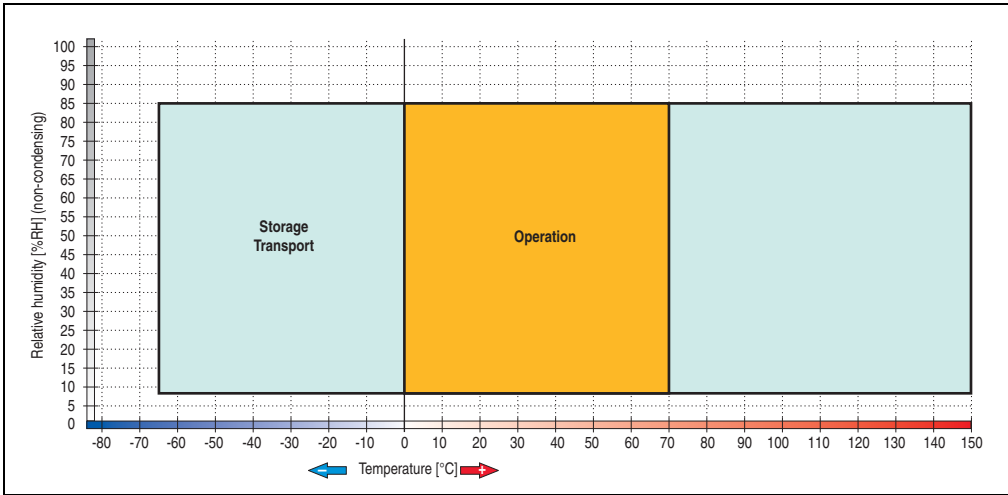

Figure 200: Temperature humidity diagram - CompactFlash cards 5CFCRD.xxxx-04

11.4 Dimensions

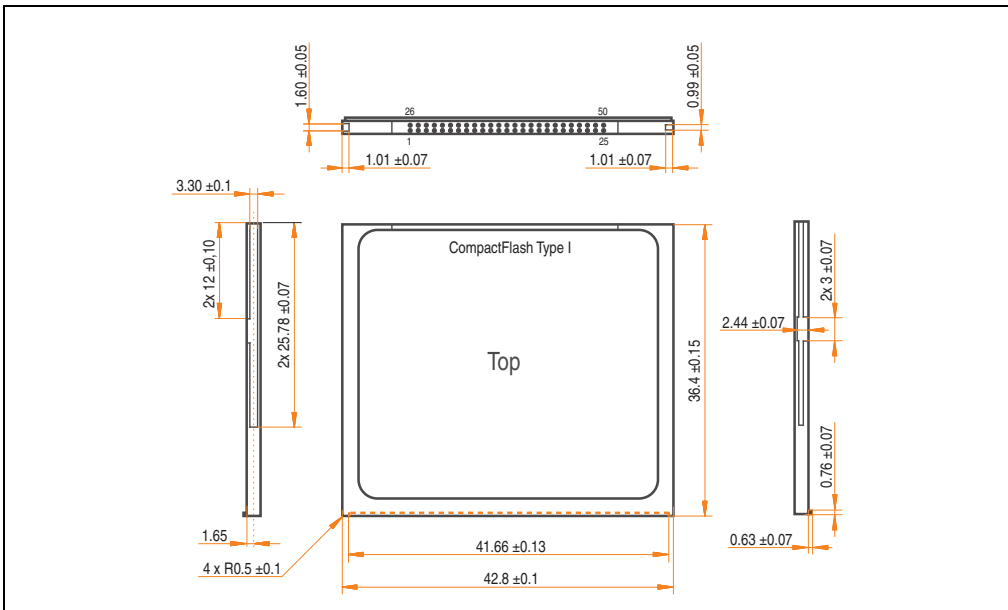

Figure 201: Dimensions - CompactFlash card Type I

11.5 Benchmark

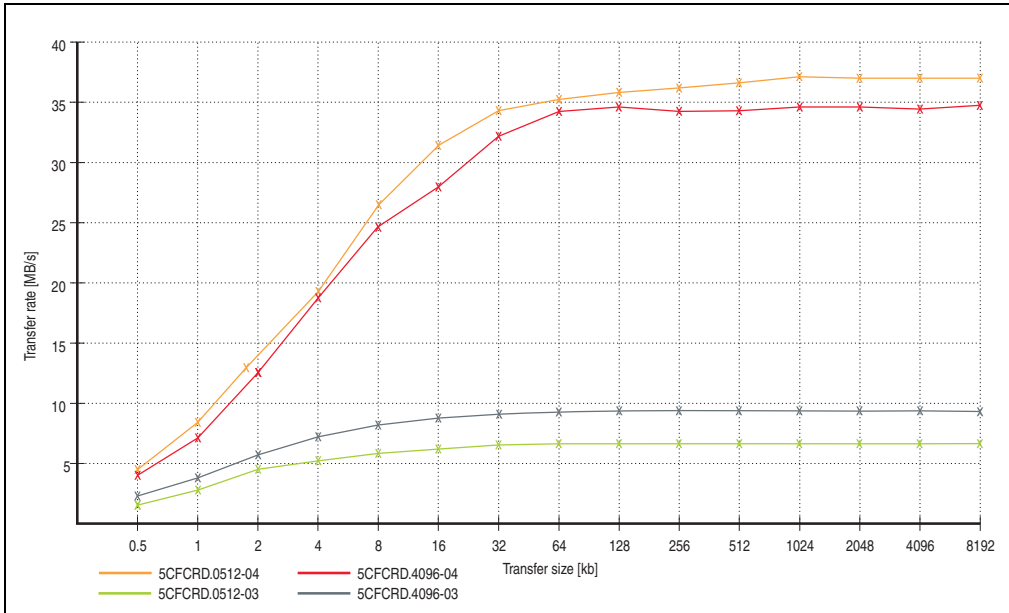

Figure 202: ATTO disk benchmark v2.34 comparison (reading)

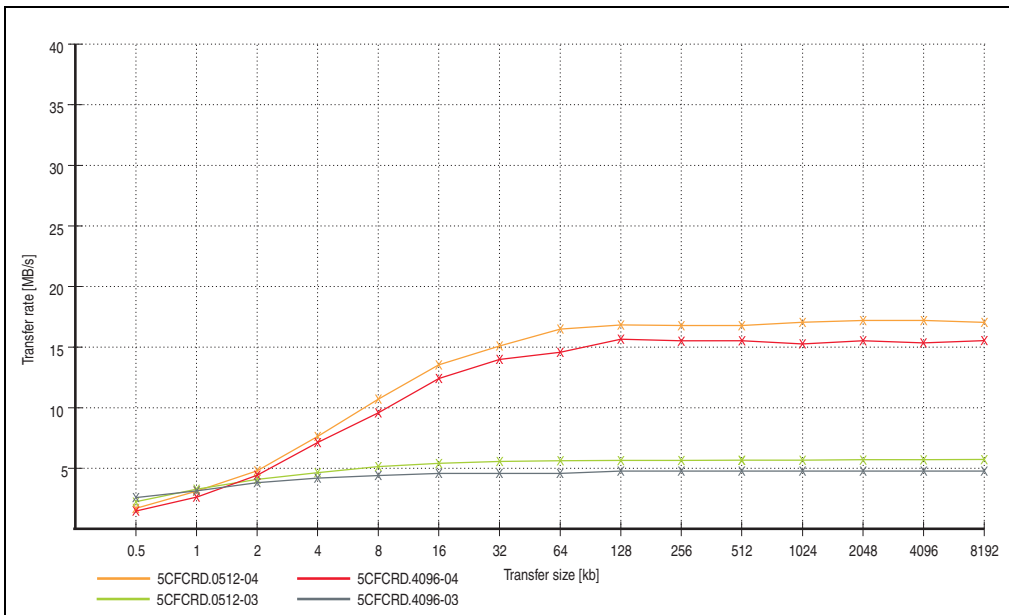

Figure 203: ATTO disk benchmark v2.34 comparison (writing)

12. CompactFlash cards - 5CFCRD.xxxx-03

12.1 General Information

Information:

Silicon Systems CompactFlash cards 5CFCRD.xxxx-03 and CompactFlash cards from a different manufacturer cannot be used in the same system at the same time. Due to differences in technology (older vs. newer technologies), problems can occur during system startup that are caused by the different boot times.

See chapter 3 "Commissioning", section 12 "Known problems / issues", on page 247.

Information:

On Windows CE 5.0 devices, 5CFCRD.xxxx-03 CompactFlash cards up to 1GB are supported.

12.2 Order data

Model number	Description	Image
5CFCRD.0064-03	CompactFlash 64 MB SSI	 <p>CompactFlash card</p>
5CFCRD.0128-03	CompactFlash 128 MB SSI	
5CFCRD.0256-03	CompactFlash 256 MB SSI	
5CFCRD.0512-03	CompactFlash 512 MB SSI	
5CFCRD.1024-03	CompactFlash 1024 MB SSI	
5CFCRD.2048-03	CompactFlash 2048 MB SSI	
5CFCRD.4096-03	CompactFlash 4096 MB SSI	
5CFCRD.8192-03	CompactFlash 8192 MB SSI	

Table 221: Order data - CompactFlash cards

12.3 Technical data

Caution!

A sudden loss of power can cause data to be lost! In very rare cases, the mass memory may also become damaged.

To prevent damage and loss of data, B&R recommends that you use a UPS device.

Information:

The following characteristics, features and limit values only apply to this accessory and can deviate those specified for the entire device. For the entire device where this accessory is installed, refer to the data provided specifically for the entire device.

Features	5CFCRD. 0064-03	5CFCRD. 0128-03	5CFCRD. 0256-03	5CFCRD. 0512-03	5CFCRD. 1024-03	5CFCRD. 2048-03	5CFCRD. 4096-03	5CFCRD. 8192-03
MTBF (at 25°C)	> 4,000,000 hours							
Maintenance	None							
Data reliability	< 1 unrecoverable error in 10 ¹⁴ bit read accesses							
Data retention	10 years							
Lifetime monitoring	Yes							
Supported operating modes	PIO Mode 0-4, Multiword DMA Mode 0-2							
Continuous reading	Typically 8 MB/s							
Continuous writing	Typically 6 MB/s							
Endurance								
Clear/write cycles Typical	> 2,000,000							
SLC flash	Yes							
Wear leveling	Static							
Error Correction Coding (ECC)	Yes							
Support								
Hardware	MP100/200, PP100/200, PP300/400, PPC700, PPC300, Provit 2000, Provit 5000, APC620, APC680, APC810, APC820							
Windows XP Professional	-	-	-	-	-	-	Yes	Yes
Windows XP Embedded	-	-	-	Yes	Yes	Yes	Yes	Yes
Windows CE 6.0	Yes	Yes	Yes	Yes	Yes	Yes	Yes	Yes
Windows CE 5.0	Yes	Yes	Yes	Yes	Yes	-	-	-

Table 222: Technical data - CompactFlash cards 5CFCRD.xxxx-03

Support	5CFCRD. 0064-03	5CFCRD. 0128-03	5CFCRD. 0256-03	5CFCRD. 0512-03	5CFCRD. 1024-03	5CFCRD. 2048-03	5CFCRD. 4096-03	5CFCRD. 8192-03
PVI Transfer Tool	V2.57 (part of PVI Development Setup V2.5.3.3005)							
B&R Embedded OS Installer	V2.21							
Mechanical characteristics								
Dimensions								
Length	36.4 ±0.15 mm							
Width	42.8 ±0.10 mm							
Thickness	3.3 ±0.10 mm							
Weight	11.4 g							
Environmental characteristics								
Ambient temperature								
Operation	0 to +70°C							
Storage	-50 to +100°C							
Transport	-50 to +100°C							
Relative humidity								
Operation/Storage/Transport	8 to 95%, non-condensing							
Vibration								
Operation	Max. 16.3 g (159 m/s ² 0-peak)							
Storage/Transport	Max. 30 g (294 m/s ² 0-peak)							
Shock								
Operation	Max. 1000 g (9810 m/s ² 0-peak)							
Storage/Transport	Max. 3000 g (29430 m/s ² 0-peak)							
Altitude	Maximum 80,000 feet (24,383 meters)							

Table 222: Technical data - CompactFlash cards 5CFCRD.xxxx-03 (Forts.)

12.3.1 Temperature humidity diagram

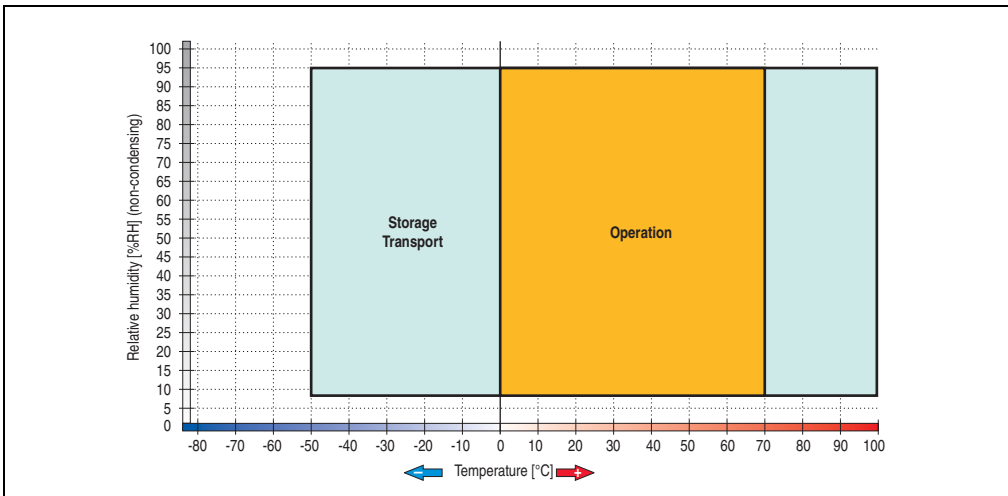

Figure 204: Temperature humidity diagram - CompactFlash cards 5CFCRD.xxxx-03

12.4 Dimensions

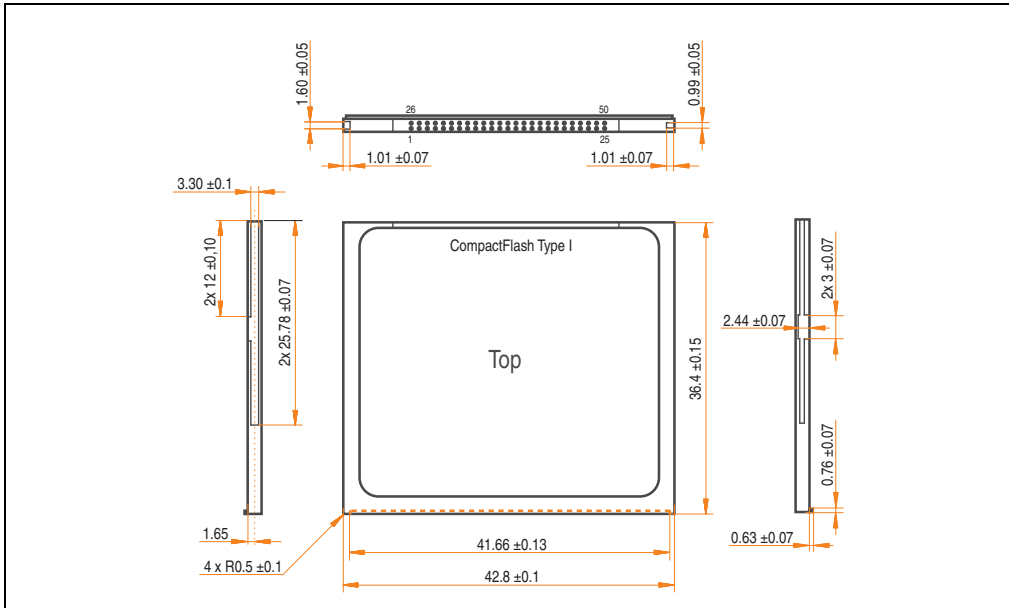

Figure 205: Dimensions - CompactFlash card Type I

13. USB Media Drive - 5MD900.USB2-01



Figure 206: USB Media Drive - 5MD900.USB2-01

13.1 Features

- Desk-top or rack-mount operation (mounting rail brackets)
- Integrated USB diskette drive
- Integrated DVD-RW/CD-RW drive
- Integrated CompactFlash slot IDE/ATAPI (Hot Plug capable)
- Integrated USB 2.0 connection (up to 480 Mbit high speed)
- +24 VDC supply (back side)
- USB/B 2.0 connection (back side)
- Optional front cover (see also section 13.9 "Front cover 5A5003.03 for the USB Media Drive", on page 405)

13.2 Technical data

Information:

The following characteristics, features and limit values only apply to this accessory and can deviate those specified for the entire device. For the entire device where this accessory is installed, refer to the data provided specifically for the entire device.

Features - entire device	5MD900.USB2-01
Transfer rate	Low speed (1.5 Mbit/s), Full Speed (12 Mbit/s) to high speed (480 Mbit/s)
Maximum cable length	5 m (not including hub)
Power supply Rated voltage	24 VDC ±25%
Features - diskette drive	
Data capacity	720 KB / 1.25 MB / 1.44 MB (formatted)
Data transfer rate	250 kbits (720 KB) or 500 kbits (1.25 MB and 1.44 MB)
Rotation speed	Up to 360 rpm
Diskette media	High density (2HD) or normal density (2DD) 3.5" diskettes
MTBF	30000 POH (Power-On Hours)
Features - DVD-RW/CD-RW drive	
Write speed CD-R CD-RW DVD-R DVD-RW DVD-RAM ¹⁾ DVD+R DVD+R (Double Layer) DVD+RW	24x, 16x, 10x and 4x 10x and 4x 8x, 4x and 2x 4x and 2x 3x and 2x 8x, 4x and 2x 2x, 4x 4x and 2x
Reading rate CD DVD	24x 8x
Data transfer rate	Max. 33.3 MB/s
Access time (average) CD / DVD	130 ms (24x) / 130 ms (8x)
Revolution speed	Max. 5090 rpm ± 1%
Starting time (0 rpm to read access) CD DVD	14 seconds (maximum) 15 seconds (maximum)
Host interface	IDE (ATAPI)
Readable media CD DVD	CD/CD-ROM (12 cm, 8 cm), CD-R, CD-RW DVD-ROM, DVD-R, DVD-RW. DVD-RAM, DVD+R, DVD+R (double layer), DVD+RW

Table 223: Technical data - USB Media Drive 5MD900.USB2-01

Accessories • USB Media Drive - 5MD900.USB2-01

Features - DVD-RW/CD-RW drive	5MD900.USB2-01
Non-write protected media CD DVD	CD-R, CD-RW DVD-R/RW, DVD-RAM (4.7 GB), DVD+R/RW, DVD+R (double layer)
Compatible formats	CD-DA, CD-ROM mode 1/mode 2 CD-ROM XA mode 2 (form 1, form 2) Photo CD (single/multi-session), Enhanced CD, CD text DVD-ROM, DVD-R, DVD-RW, DVD-Video DVD-RAM (4.7 GB, 2.6 GB) DVD+R, DVD+R (double layer), DVD+RW
Write-methods CD DVD	Disk at once, session at once, packet write, track at once Disk at once, incremental, over-write, sequential, multi-session
Laser class	Class 1 laser
Data buffer capacity	8 MB
Noise level (complete read access)	Approx. 48 dBA at 50 cm
Service life Opening/closing the drawer	60000 POH (Power-On Hours) > 10000 times
CompactFlash slot layout	
CompactFlash Type Amount Connection	Type I 1 slot IDE/ATAPI
CompactFlash LED	Signals read or write access to an inserted CompactFlash card
Hot Plug capable	Yes
Features - USB connections	
USB A on the front side Power supply Type Transfer rate	Connection of further peripheral devices Max. 500 mA 2.0 Low speed (1.5 Mbit/s), full speed (12 Mbit/s), to high speed (480 Mbit/s)
USB B back side	Connection to the system
Mechanical characteristics	
Outer dimensions (without slide-in) Width Length Height	70 mm 100 mm 9.5 mm
Weight	Approx. 1.1 kg (without front cover)
Environmental characteristics	
Ambient temperature Operation Storage Transport	+5 to +45°C -20 to +60°C -40 to +60°C
Relative humidity Operation Storage Transport	20 to 80%, non-condensing 5 to 90%, non-condensing 5 to 95%, non-condensing

Table 223: Technical data - USB Media Drive 5MD900.USB2-01 (Forts.)

Environmental characteristics	5MD900.USB2-01
Vibration Operation Storage Transport	5 - 500 Hz: 0.3 g (2.9 m/s ² 0-peak) 10 - 100 Hz: 2 g (19.6 m/s ² 0-peak) 10 - 100 Hz: 2 g (19.6 m/s ² 0-peak)
Shock Operation Storage Transport	Max. 5 g (49 m/s ² 0-peak) and 11 ms duration Max. 60 g (588 m/s ² 0-peak) and 11 ms duration Max. 60 g (588 m/s ² 0-peak) and 11 ms duration
Altitude	Max. 3000 meters

Table 223: Technical data - USB Media Drive 5MD900.USB2-01 (Forts.)

1) DVD RAM drivers are not provided by the manufacturer. Support of DVD RAM function by the burning software "Nero" (model number 5SWUTI.0000-00) or other burning software packages and drivers from third party providers.

13.3 Dimensions

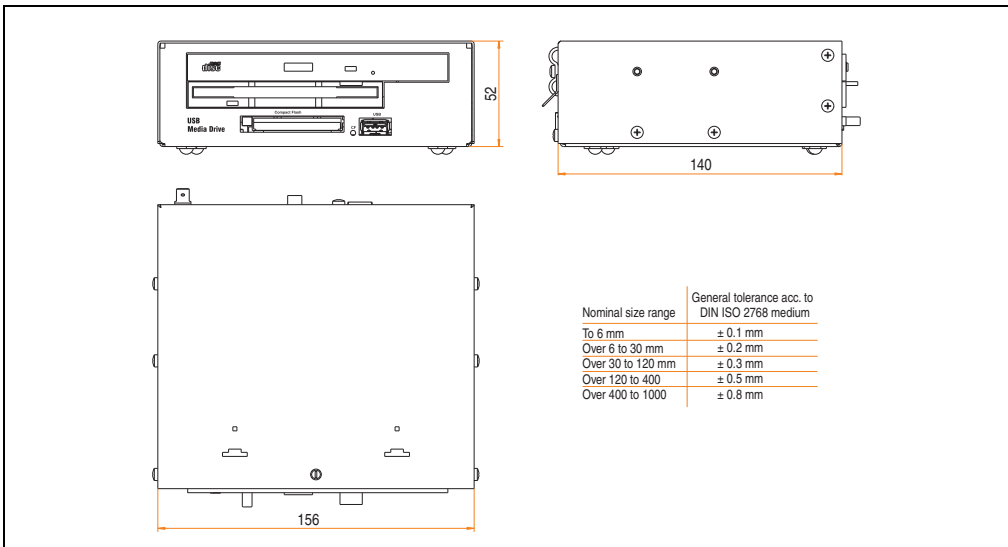

Figure 207: Dimensions - 5MD900.USB2-01

13.4 Dimensions with front cover

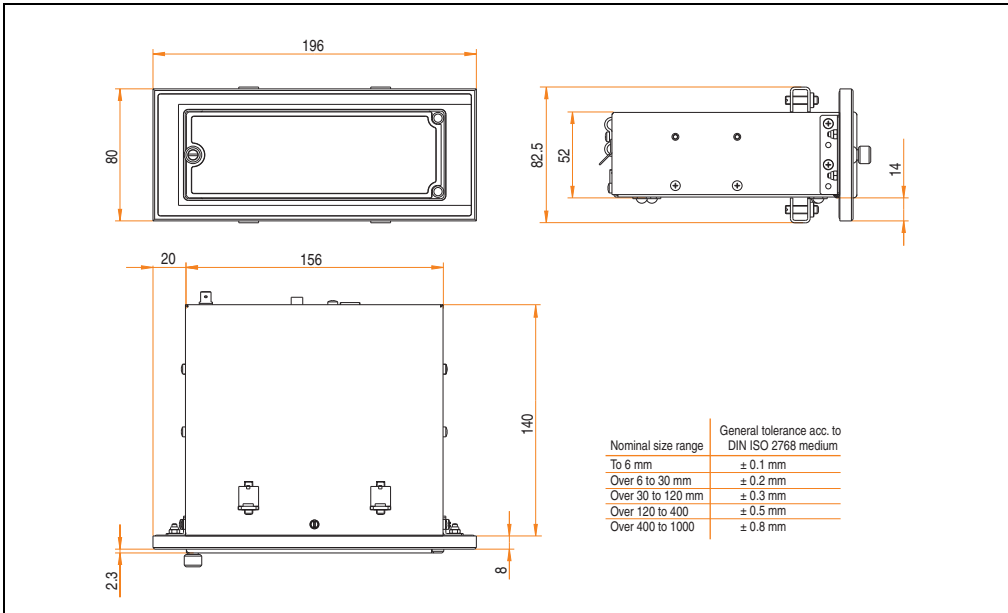

Figure 208: Dimensions - USB Media Drive with front cover

13.5 Cutout installation

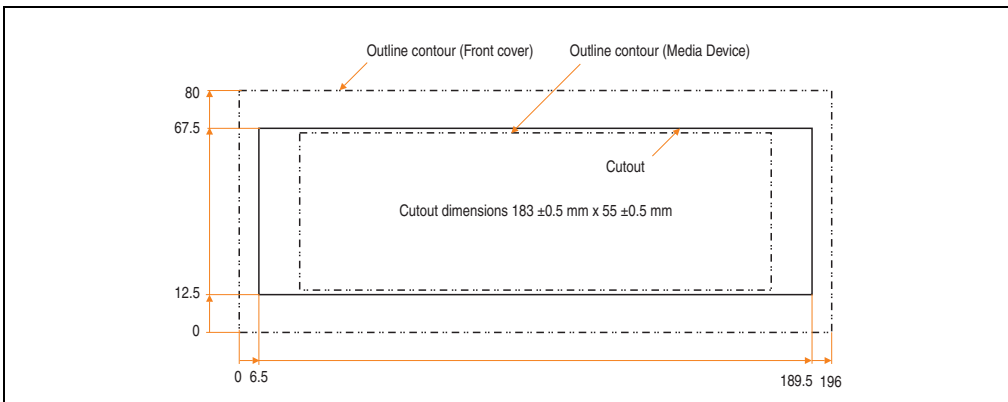

Figure 209: Installation cutout - USB Media Drive with front cover

13.6 Contents of delivery

Amount	Component
1	USB Media Drive complete unit
2	Mounting rail brackets

Table 224: Contents of delivery - USB Media Drive - 5MD900.USB2-01

13.7 Interfaces

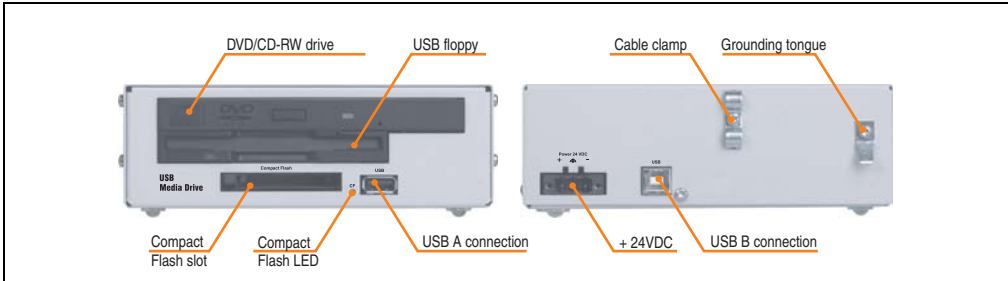

Figure 210: Interfaces - 5MD900.USB2-01

13.8 Installation

The USB Media Drive can be operated as a desk-top device (rubber feet) or as a rack-mount device (2 mounting rail brackets included).

13.8.1 Mounting orientation

Because of limits to the mounting orientation with the components used (floppy, DVD-CDRW drive), the USB media drive is only permitted to be mounted and operated as shown in the following figure.

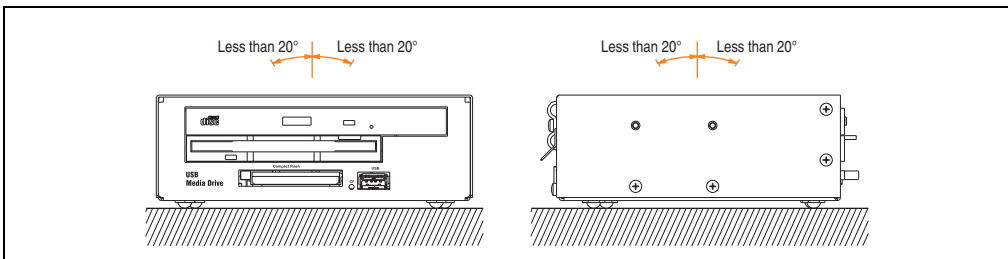

Figure 211: Mounting orientation - 5MD900.USB2-01

13.9 Front cover 5A5003.03 for the USB Media Drive

This front cover can also be mounted on the front of the USB media drive (model number 5MD900.USB2-00 or 5MD900.USB2-01) to protect the interface.

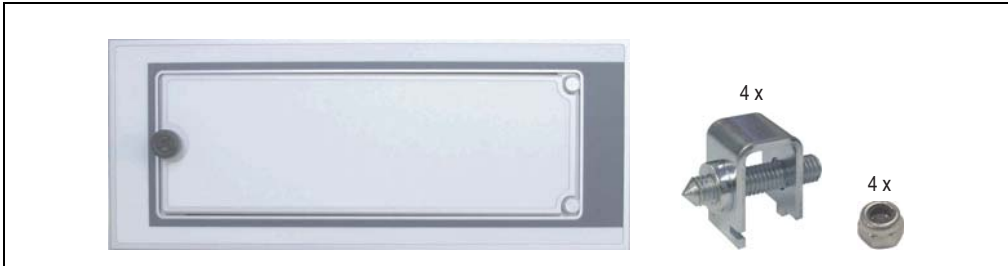

Figure 212: Front cover 5A5003.03

13.9.1 Technical data

Features	5A5003.03
Front cover design / colors Dark gray border around the cover Light gray background	Pantone 432CV Pantone 427CV

Table 225: Technical data - 5A5003.03

13.9.2 Dimensions

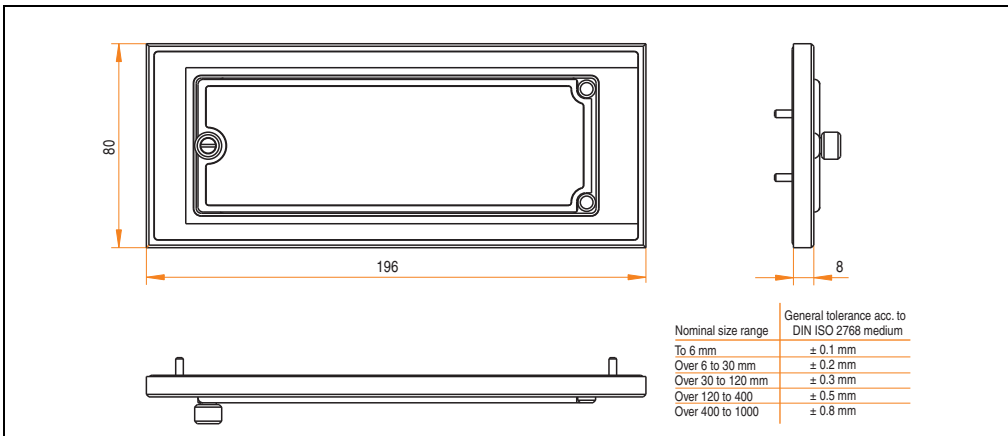

Figure 213: Dimensions - 5A5003.03

13.9.3 Installation

The front cover is attached with 2 mounting rail brackets (included with USB Media Drive) and 4 M3 locknuts. The USB media drive and front cover can be mounted as a whole in (for example) a control cabinet door.

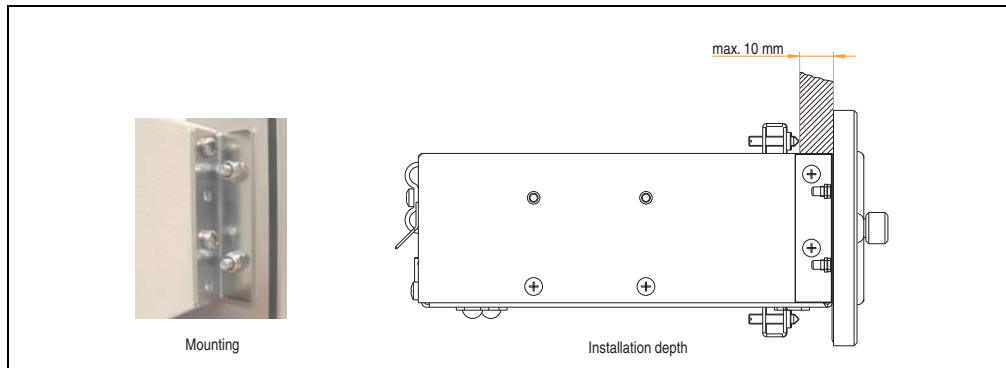

Figure 214: Front cover mounting and installation depth

14. USB flash drive

Information:

We reserve the right to supply alternative products due to the vast quantity of flash drives available on the market and their corresponding short product lifecycle. Therefore, the following measures might be necessary in order to boot from these flash drives (e.g. the SanDisk Cruzer Micro flash drive with 512 MB):

- The flash drive must be reformatted or in some cases even re-partitioned (set active partition).
- The flash drive must be at the top of the BIOS boot order, or alternatively the IDE controllers can also be deactivated in the BIOS. This can be avoided in most cases if a "`fdisk /mbr`" command is also executed on the USB flash drive.

14.1 General Information

USB flash drives are easy-to-exchange storage media. Because of the fast data transfer (USB 2.0), the USB flash drives are ideal for use as a portable memory medium. Without requiring additional drivers ("Hot Plug & Play" - except with Windows 98SE), the USB flash drive can be converted immediately into an additional drive where data can be read or written.

14.2 Order data



Model number	Description	Image
5MMUSB.2048-00	USB flash drive 2 GB SanDisk Cruzer Micro	
5MMUSB.2048-01	USB flash drive 2 GB B&R USB 2.0 flash drive 2 GB	

Table 226: Order data - USB flash drives

14.3 Technical data - 5MMUSB.2048-00

Information:

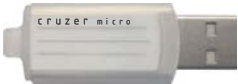
The following characteristics, features and limit values only apply to this accessory and can deviate those specified for the entire device. For the entire device where this accessory is installed, refer to the data provided specifically for the entire device.

Features	5MMUSB.2048-00
LED	1 LED (green), signals data transfer (send and receive)
Power supply Power consumption	Via the USB port 650 µA in sleep mode, 150 mA read/write
Interface Type Transfer rate Sequential reading Sequential writing Connection	USB specification 2.0 high speed device, mass storage class, USB-IF and WHQL certified USB 1.1 and 2.0 compatible Up to 480 Mbit (high speed) Max. 8.7 MB/second Max. 1.7 MB/second To each USB type A interface
MTBF (at 25°C)	100000 hours
Data retention	10 years
Maintenance	None
Operating system support	Windows CE 4.2, CE 5.0, ME, 2000, XP and Mac OS 9.1.x+, OS X v10.1.2+
Mechanical characteristics	
Dimensions Length Width Thickness	52.2 mm 19 mm 7.9 mm
Environmental characteristics	
Ambient temperature Operation Storage Transport	0 to +45°C -20 to +60°C -20 to +60°C
Relative humidity Operation Storage Transport	10 to 90%, non-condensing 5 to 90%, non-condensing 5 to 90%, non-condensing
Vibration Operation Storage Transport	at 10 - 500 Hz: 2 g (19,6 m/s ² 0-peak), oscillation rate 1/minute At 10 - 500 Hz: 4 g (39,2 m/s ² 0-peak), oscillation rate 1/minute At 10 - 500 Hz: 4 g (39,2 m/s ² 0-peak), oscillation rate 1/minute
Shock Operation Storage Transport	Max. 40 g (392 m/s ² 0-peak) and 11 ms duration Max. 80 g (784 m/s ² 0-peak) and 11 ms duration Max. 80 g (784 m/s ² 0-peak) and 11 ms duration

Table 227: Technical data - USB flash drive 5MMUSB.2048-00

Environmental characteristics	5MMUSB.2048-00
Altitude	
Operation	3,048 meters
Storage	12,192 meters
Transport	12,192 meters

Table 227: Technical data - USB flash drive 5MMUSB.2048-00 (Forts.)

14.3.1 Temperature humidity diagram

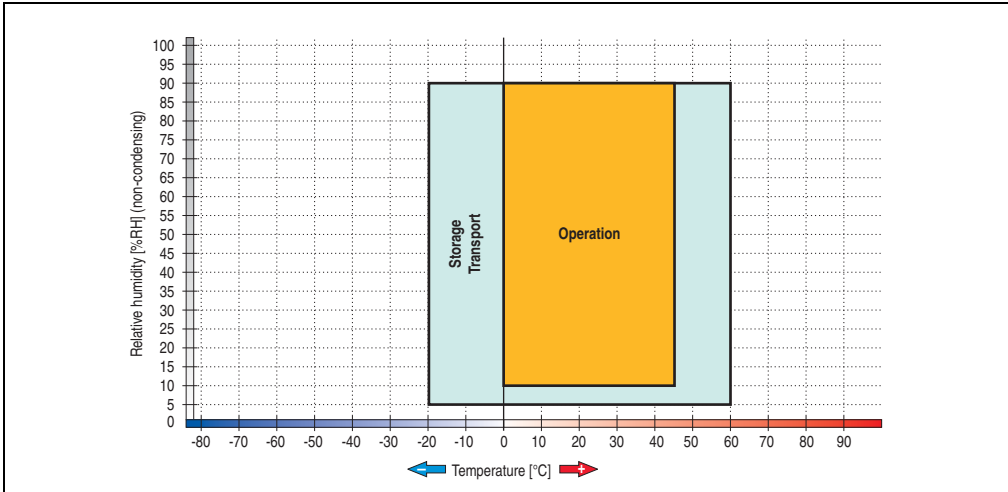

Figure 215: Temperature humidity diagram - USB flash drive - 5MMUSB.2048-00

Temperature data is for operation at 500 meters. Derating the max. ambient temperature - typically 1°C per 1000 meters (from 500 meters above sea level).

14.4 Technical data - 5MMUSB.2048-01

Information:

The following characteristics, features and limit values only apply to this accessory and can deviate those specified for the entire device. For the entire device where this accessory is installed, refer to the data provided specifically for the entire device.

Features	5MMUSB.2048-01
LED	1 LED (green), signals data transfer (send and receive)
Power supply Power consumption	Via the USB port max. 500 µA sleep mode, max. 120 mA read/write
Interface Type Transfer rate Sequential reading Sequential writing Connection	USB specification 2.0 high speed device, mass storage class, USB-IF and WHQL certified USB 1.1 and 2.0 compatible Up to 480 Mbit (high speed) Max. 31 MB/second Max. 30 MB/second To each USB type A interface
MTBF	> 3,000,000 hours
Data retention	> 10 years
Maintenance	None
Operating system support	Windows CE, ME, 2000, XP, Vista und Mac OS 9 or newer, Linux 2.4 or newer
Mechanical characteristics	
Dimensions Length Width Thickness	67.85 mm 17.97 mm 8.35 mm
Environmental characteristics	
Ambient temperature Operation Storage Transport	0 to +70°C -50 to +100°C -50 to +100°C
Relative humidity Operation Storage Transport	85%, non-condensing 85%, non-condensing 85%, non-condensing
Vibration Operation Storage Transport	At 20 - 2000 Hz: 20 g (peak) At 20 - 2000 Hz: 20 g (peak) At 20 - 2000 Hz: 20 g (peak)
Shock Operation Storage Transport	max. 1500 g (peak) max. 1500 g (peak) max. 1500 g (peak)

Table 228: Technical data - USB flash drive 5MMUSB.2048-01

Environmental characteristics	5MMUSB.2048-01
Altitude	
Operation	3,048 meters
Storage	12,192 meters
Transport	12,192 meters

Table 228: Technical data - USB flash drive 5MMUSB.2048-01 (Forts.)

14.4.1 Temperature humidity diagram

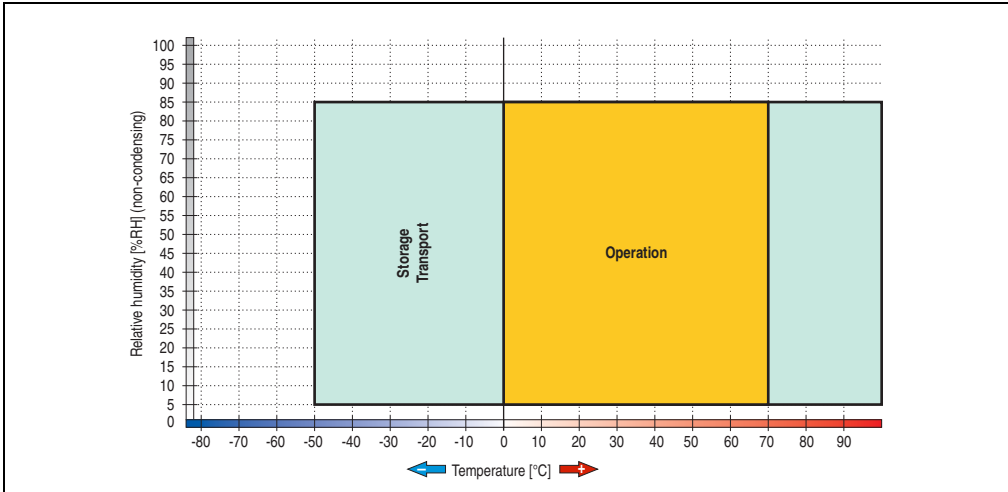

Figure 216: Temperature humidity diagram - USB flash drive - 5MMUSB.2048-01

Temperature data is for operation at 500 meters. Derating the max. ambient temperature - typically 1°C per 1000 meters (from 500 meters above sea level).

15. HMI Drivers & Utilities DVD 5SWHMI.0000-00



Figure 217: HMI Drivers & Utilities DVD 5SWHMI.0000-00

Model number	Short description	Note
5SWHMI.0000-00	HMI Drivers & Utilities DVD	

Table 229: Model number - HMI Drivers & Utilities DVD

This DVD contains drivers, utilities, software upgrades and user's manuals for B&R Panel system products (see B&R homepage www.br-automation.com – Industrial PCs, Visualization and Operation).

At the time of its creation, the content on the DVD is identical to the files found in the download area of the B&R homepage (under Service – “Material Related Downloads”).

BIOS upgrades for the products

- Automation PC 620 / Panel PC 700 CPU Board 815E und 855GME BIOS
- Automation PC 620 / Panel PC 700 CPU Board X855GME BIOS
- Automation PC 620 / Panel PC 700 CPU Board 945GME N270 BIOS
- Automation PC 680
- Automation PC 810 / Automation PC 820 / Panel PC 800 B945GME BIOS
- Automation PC 810 / Panel PC 800 945GME N270 CPU Board BIOS
- Automation PC 810 / Panel PC 800 GM45 CPU Board BIOS
- Provit 2000 products - IPC2000/2001/2002

- Provit 5000 products - IPC5000/5600/5000C/5600C
- Power Panel 100 BIOS devices
- Mobile Panel 100 BIOS devices
- Power Panel 100 / Mobile Panel 100 User Boot Logo
- Power Panel 100 / Mobile Panel 100 REMHOST Utility
- Power Panel 300/400 BIOS devices
- Power Panel 300/400 BIOS User Boot Logo
- Panel PC 310

Drivers for the devices

- Automation Device Interface (ADI)
- Audio
- Chipset
- CD-ROM
- LS120
- Graphics
- Network
- PCI / SATA RAID controller
- Touch screen
- Touchpad
- Interfacecard

Firmware Upgrades

- Automation PC 620 / Panel PC 700 (MTCX, SDLR, SDLT)
- Automation PC 810 (MTCX, SDLR, SDLT)
- Automation PC 820 (MTCX, SDLR, SDLT)
- Mobile Panel 100 (SMCX)
- Panel PC 300 (MTCX)
- Power Panel 100 (aPCI)
- Power Panel 300/400 (aPCI)
- Power Panel 300/400 (MTCX)
- Panel PC 800 (MTCX, SDLR, SDLT)
- UPS firmware

Utilities / Tools

- B&R Embedded OS Installer
- Windows CE Tools
- User Boot Logo Conversion Utility
- SATA RAID Installations Utility
- Automation Device Interface (ADI)
- CompactFlash endurance calculator (Silicon Systems)
- Miscellaneous
- MTC Utilities
- Key Editor
- MTC & Mkey Utilities
- Mkey Utilities
- UPS configuration software
- ICU ISA configuration
- Intel PCI NIC Boot ROM
- Diagnostic Utilities

Windows

- Windows CE 6.0
- Windows CE 5.0
- Windows CE 4.2
- Windows CE 4.1
- Windows CE Tools
- Windows Embedded Standard 2009
- Thin Client
- Windows NT Embedded
- Windows XP Embedded
- VNC Viewer

MCAD templates for

- Industrial PCs
- Operator Interface devices
- Legend Strips templates
- Customized designs

ECAD templates for

- Industrial PCs
- Automation PCs
- Automation Panel 900
- Panel (Power Panel)

Documentation for

- Automation PC 620
- Automation PC 680
- Automation PC 810
- Automation PC 820
- Automation Panel 800
- Automation Panel 900
- Panel PC 310
- Panel PC 700
- Panel PC 725
- Panel PC 800
- Power Panel 15/21/35/41
- Power Panel 100/200
- Power Panel 300/400
- Mobile Panel 40/50
- Mobile Panel 100/200
- Mobile Panel connection box
- Provit 2000
- Provit 3030
- Provit 4000
- Provit 5000
- Provit Benchmark
- Provit Mkey
- Windows CE 5.0 help
- Windows CE 6.0 help
- Windows NT Embedded application guide
- Windows XP Embedded application guide
- UPS - uninterruptible power supply

- Implementation instructions
- B&R Hilscher fieldbus cards (CANopen, DeviceNet, PROFIBUS, PROFINET)

Service tools

- Acrobat Reader 5.0.5 (freeware in German, English and French)
- Power Archiver 6.0 (freeware in German, English and French)
- Internet Explorer 5.0 (German and English)
- Internet Explorer 6.0 (German and English)

16. Cables

16.1 DVI cable 5CADVI.0xxx-00

The DVI cables 5CADVI.0xxx-00 are designed for fixed layout.

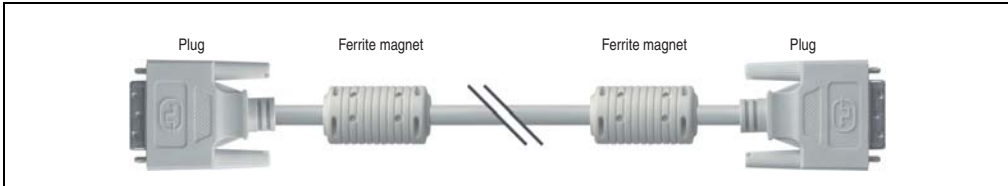

Figure 218: DVI extension cable - 5CADVI.0xxx-00 (similar)

Caution!

DVI cables can only be plugged in and unplugged when the device is turned off.

16.1.1 Order data

Model number	Description	Note
5CADVI.0018-00	DVI-D cable 1.8 m / single Single cable, DVI-D/m:DVI-D/m; length: 1.8 m	
5CADVI.0050-00	DVI-D cable 5 m / single Single cable, DVI-D/m:DVI-D/m; length: 5 m	
5CADVI.0100-00	DVI-D cable 10 m / single Single cable, DVI-D/m:DVI-D/m; length: 10 m	

Table 230: Model numbers - DVI cables

16.1.2 Technical data

Features	5CADVI.0018-00	5CADVI.0050-00	5CADVI.0100-00
Length Tolerance	1.8 m ±50 mm	5 m ±80 mm	10 m ±100 mm
Cable diameter Maximum	8.5 mm		
Shielding	Individual cable pairs and entire cable		
Connector type Connection cycles	2x DVI-D (18+1), male 100		
Wire cross section	AWG 28		
Line resistance	Max. 237 Ω/km		
Insulation resistance	Min. 100 MΩ/km		
Flexibility	Limited flexibility; valid for ferrite magnet - ferrite magnet (tested 100 cycles with 5x cable diameter, 20 cycles / minute)		
Flex radius Fixed layout	See figure "Flex radius specification", on page 418 5 x cable diameter (plug - ferrite magnet and ferrite magnet - ferrite magnet)		
Weight	Approx. 260 g	Approx. 460 g	Approx. 790 g

Table 231: Technical data - DVI cable 5CADVI.0xxx-00

Flex radius specification

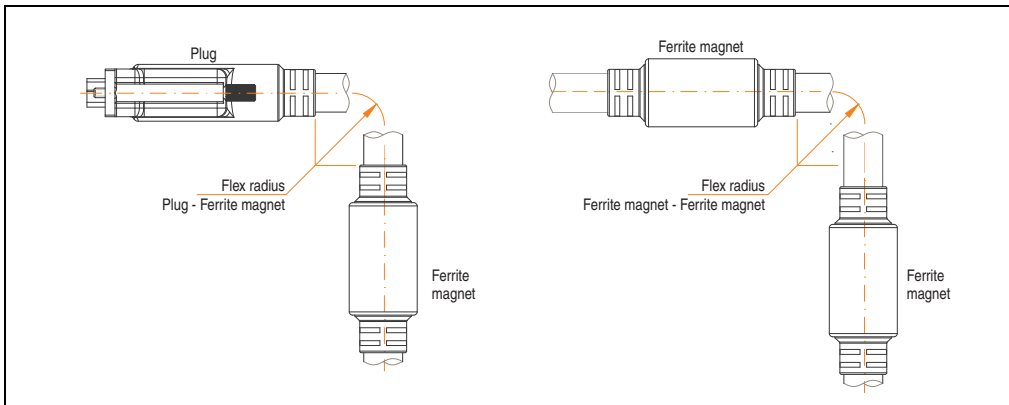

Figure 219: Flex radius specification

Dimensions

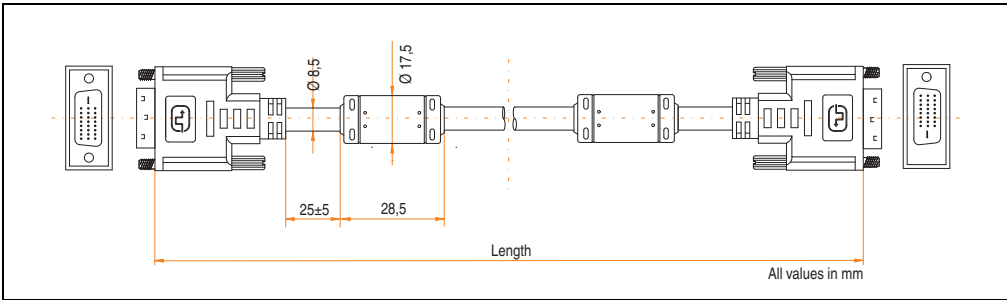

Figure 220: Dimensions - DVI cable 5CADVI.0xxx-00

Contents of delivery

Amount	Component
1	DVI cable in desired length, plug covers are attached at the cable ends.

Table 232: Contents of delivery - DVI cable 5CADVI.0xxx-00

16.1.3 Cable specifications

The following figure shows the pin assignments for the DVI cable available at B&R. If you want to build a suitable cable yourself, it should be wired according to these specifications.

Warning!

If a self-built cable is used, B&R cannot guarantee that it will function properly.

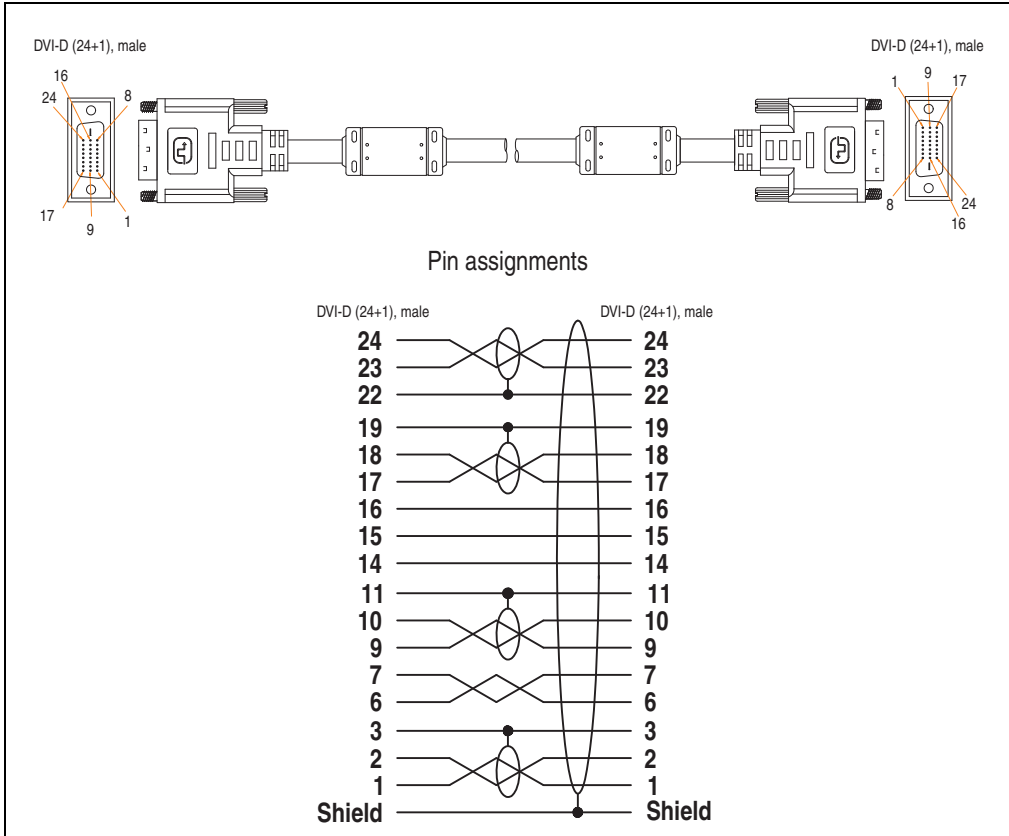

Figure 221: Pin assignments - DVI cable

16.2 SDL cable 5CASDL.0xxx-00

The SDL cables 5CASDL.0xxx-00 are designed for fixed layout. Use of the SDL flex cable 5CASDL.0xxx-03 is required for a flexible installation (e.g. in swing arm systems).

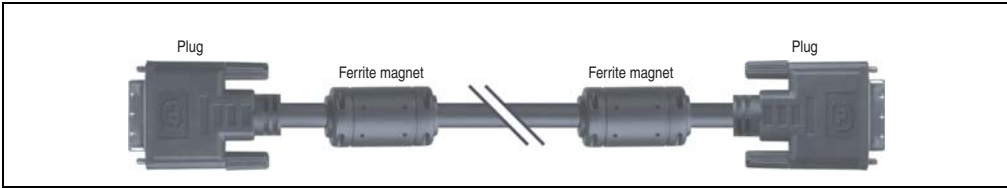

Figure 222: SDL cable 5CASDL.0xxx-00 (similar)

Caution!

SDL cables can only be plugged in and unplugged when the device is turned off.

16.2.1 Order data

Model number	Description	Note
5CASDL.0018-00	SDL cable 1.8 m SDL cable for a fixed type of layout; length: 1.8 m	
5CASDL.0050-00	SDL cable 5 m SDL cable for a fixed type of layout; length: 5 m	
5CASDL.0100-00	SDL cable 10 m SDL cable for a fixed type of layout; length: 10 m	
5CASDL.0150-00	SDL cable 15 m SDL cable for a fixed type of layout; length: 15 m	
5CASDL.0200-00	SDL cable 20 m SDL cable for a fixed type of layout; length: 20 m	
5CASDL.0250-00	SDL cable 25 m SDL cable for a fixed type of layout; length: 25 m	
5CASDL.0300-00	SDL cable 30 m SDL cable for a fixed type of layout; length: 30 m	

Table 233: Model numbers - SDL cables

16.2.2 Technical data

Features	5CASDL.0018-00	5CASDL.0050-00	5CASDL.0100-00	5CASDL.0150-00	5CASDL.0200-00	5CASDL.0250-00	5CASDL.0300-00
Length Tolerance	1.8 m ±30 mm	5 m ±30 mm	10 m ±50 mm	15 m ±100 mm	20 m ±100 mm	25 m ±100 mm	30 m ±100 mm
Cable diameter Typical Maximum	8.6 ±0.2 mm 9 mm		11 ±0.2 mm 11.5 mm				
Shielding	Individual cable pairs and entire cable						
Connector type Connection cycles	2x DVI-D (24+1), male 100						
Wire cross section	AWG 28			AWG 24			
Line resistance	Max. 237 Ω/km			Max. 93 Ω/km			
Insulation resistance	Min. 10 MΩ/km						
Flexibility	Limited flexibility; valid for ferrite magnet - ferrite magnet (tested 100 cycles with 5x cable diameter, 20 cycles / minute)						
Flex radius Fixed layout	See figure "Flex radius specification", on page 422 5 x cable diameter (plug - ferrite magnet and ferrite magnet - ferrite magnet)						
Weight	Approx. 300 g	Approx. 580 g	Approx. 1500 g	Approx. 2250 g	Approx. 2880 g	Approx. 4800 g	Approx. 5520 g

Table 234: Technical data - SDL cables 5CASDL.0xxx-00

Flex radius specification

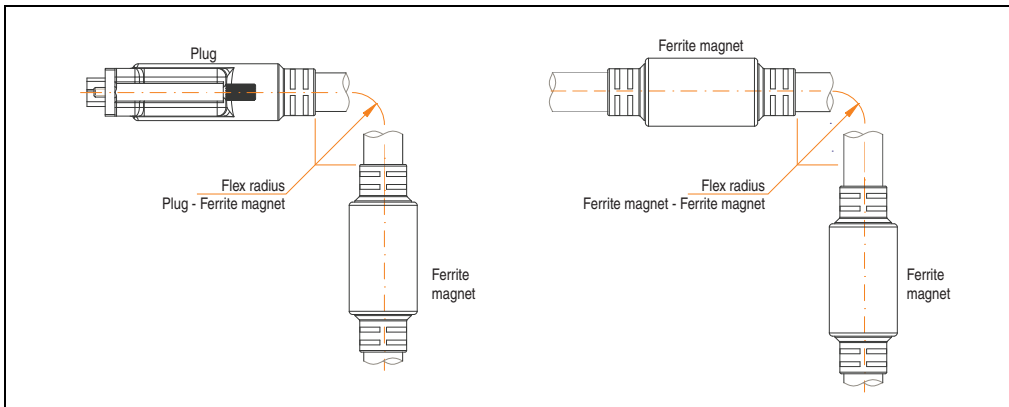

Figure 223: Flex radius specification

Dimensions

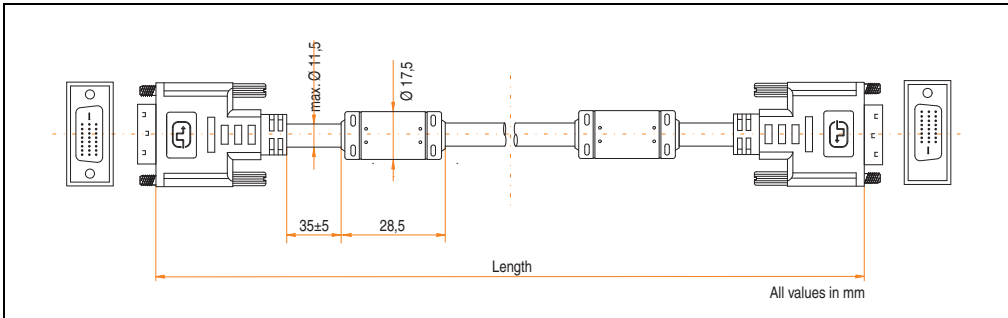

Figure 224: Dimensions - SDL cable 5CASDL.0xxx-00

Contents of delivery

Amount	Component
1	SDL cable in desired length, plug covers are attached at the cable ends.

Table 235: Contents of delivery - SDL cable 5CASDL.0xxx-00

16.2.3 Cable specifications

The following figure shows the pin assignments for the SDL cable available at B&R. If you want to build a suitable cable yourself, it should be wired according to these specifications.

Warning!

If a self-built cable is used, B&R cannot guarantee that it will function properly.

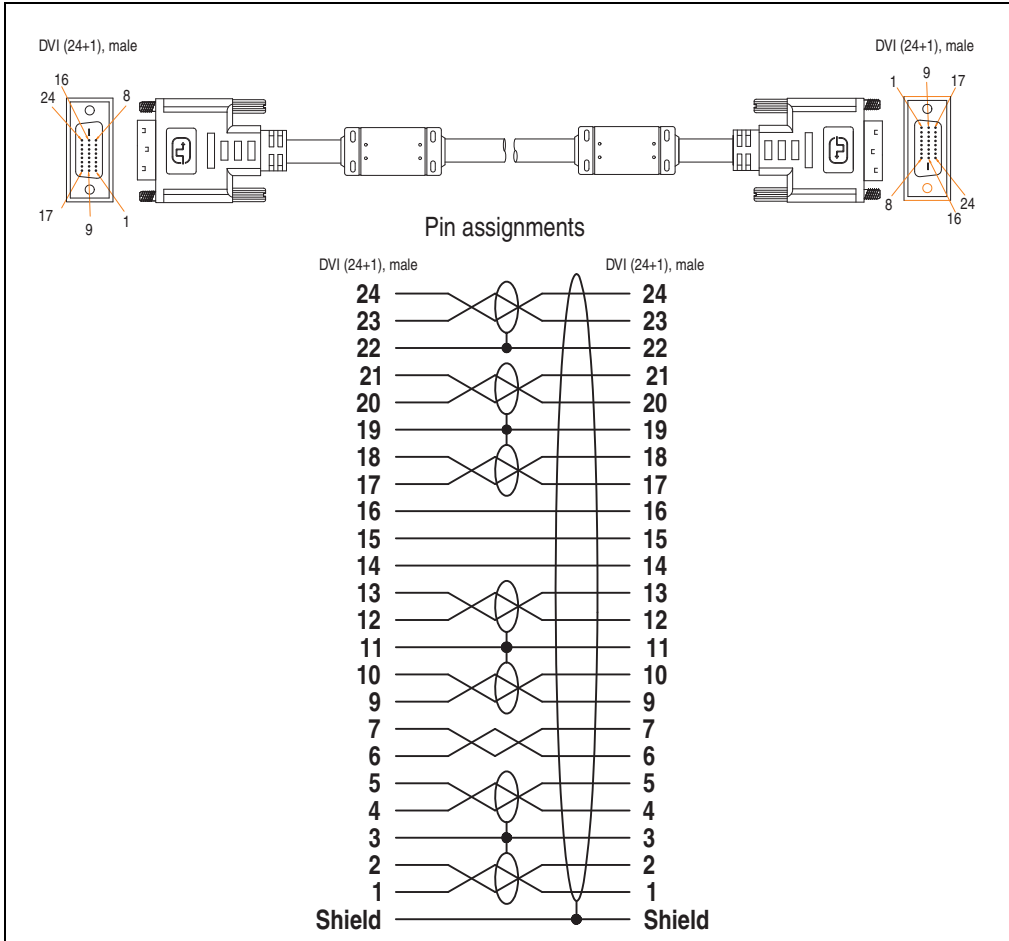

Figure 225: Pin assignments - SDL cable 5CASDL.0xxx-00

16.3 SDL cable with 45° plug 5CASDL.0xxx-01

The SDL cables 5CASDL.0xxx-01 are designed for fixed layout.

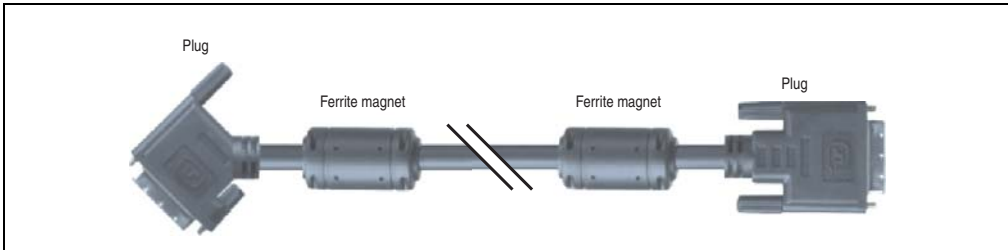

Figure 226: SDL cable with 45° plug (similar)

Caution!

SDL cables can only be plugged in and unplugged when the device is turned off.

16.3.1 Order data

Model number	Description	Note
5CASDL.0018-01	SDL cable 1.8 m 45° SDL cable for fixed type of layout with one-sided 45° plug; length: 1.8 m	
5CASDL.0050-01	SDL cable 5 m 45° SDL cable for fixed type of layout with one-sided 45° plug; length: 5 m	
5CASDL.0100-01	SDL cable 10 m 45° SDL cable for fixed type of layout with one-sided 45° plug; length: 10 m	
5CASDL.0150-01	SDL cable 15 m 45° SDL cable for fixed type of layout with one-sided 45° plug; length: 15 m	

Table 236: Model numbers - SDL cables with 45° plug

16.3.2 Technical data

Features	5CASDL.0018-01	5CASDL.0050-01	5CASDL.0100-01	5CASDL.0150-01
Length Tolerance	1.8 m ±30 mm	5 m ±50 mm	10 m ±100 mm	15 m ±100 mm
Cable diameter Maximum	9 mm		11.5 mm	
Shielding	Individual cable pairs and entire cable			
Connector type Connection cycles	2x DVI-D (24+1), male 100			
Wire cross section	AWG 28		AWG 24	
Line resistance	Max. 237 Ω/km		Max. 93 Ω/km	
Insulation resistance	Min. 10 MΩ/km			
Flexibility	Limited flexibility; valid for ferrite magnet - ferrite magnet (tested 100 cycles with 5x cable diameter, 20 cycles / minute)			
Flex radius Fixed layout	See figure "Flex radius specification", on page 426 5 x cable diameter (plug - ferrite magnet and ferrite magnet - ferrite magnet)			
Weight	Approx. 300 g	Approx. 590 g	Approx. 2800 g	Approx. 2860 g

Table 237: Technical data - SDL cable with 45° plug 5CASDL.0xxx-01

Flex radius specification

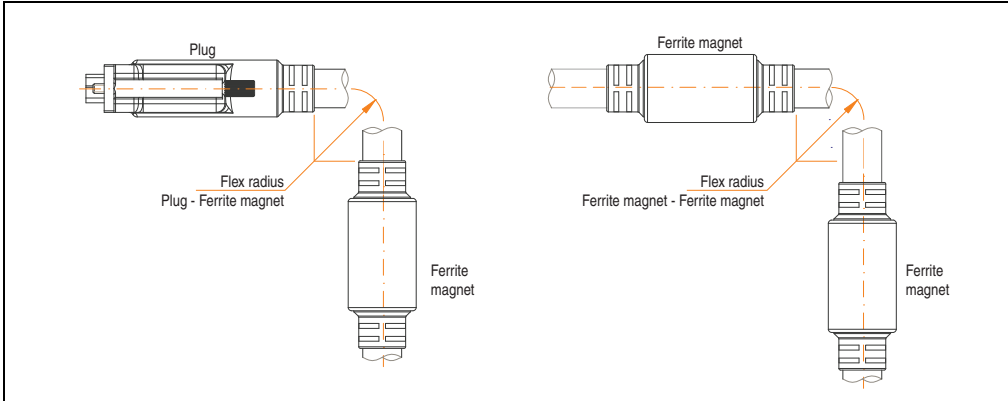

Figure 227: Flex radius specification

Dimensions

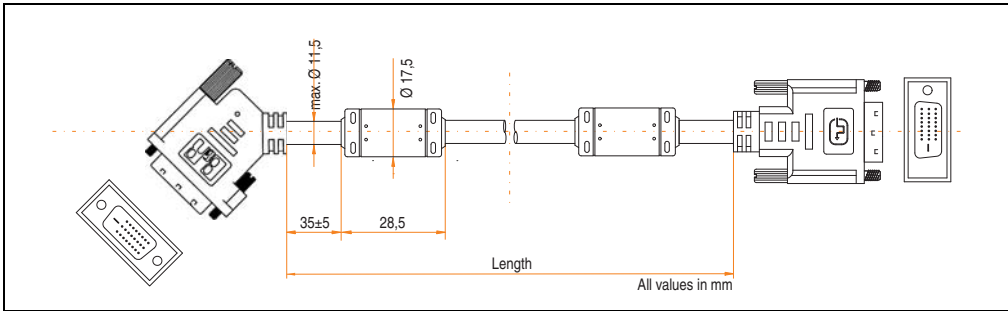

Figure 228: Dimensions - SDL cable with 45° plug 5CASDL.0xxx-01

Contents of delivery

Amount	Component
1	SDL cable with 45° plug in desired length, plug covers are attached at the cable ends.

Table 238: Contents of delivery - SDL cable with 45° plug 5CASDL.0xxx-01

16.3.3 Cable specifications

The following figure shows the pin assignments for the SDL cable available at B&R. If you want to build a suitable cable yourself, it should be wired according to these specifications.

Warning!

If a self-built cable is used, B&R cannot guarantee that it will function properly.

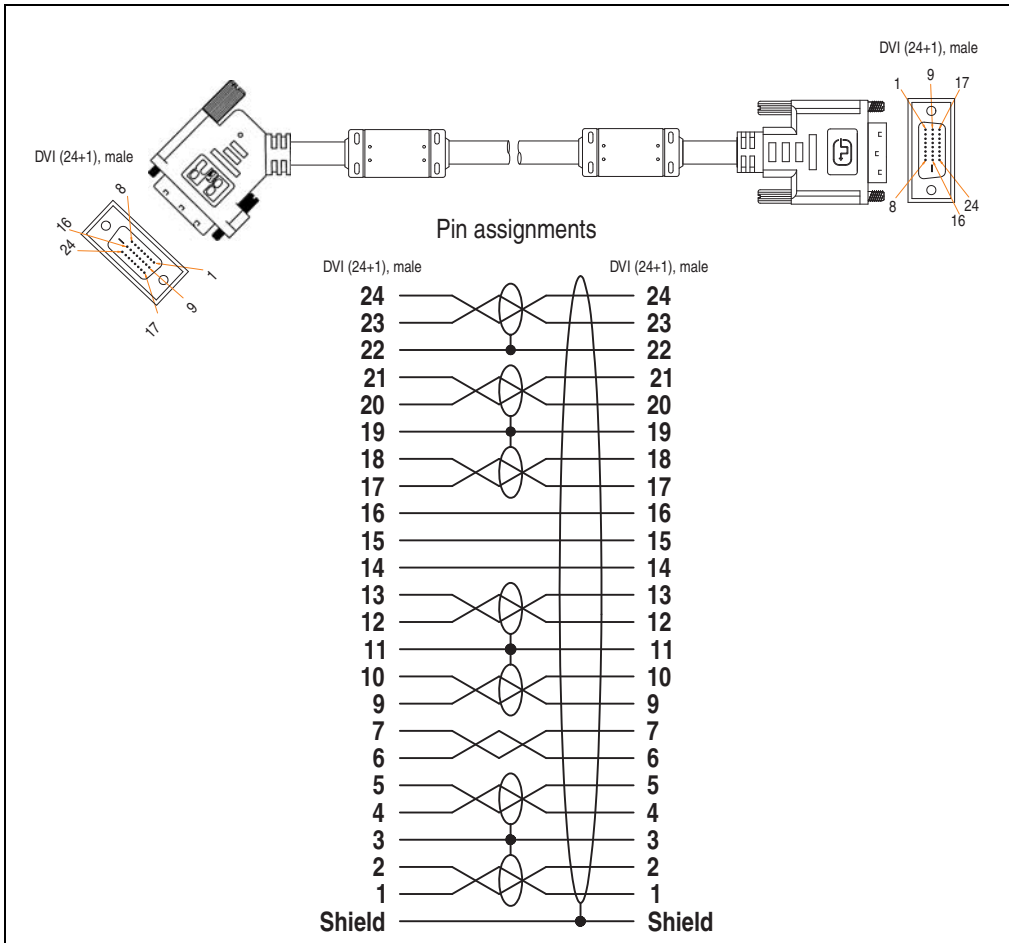

Figure 229: Pin assignments - SDL cable with 45° plug 5CASDL.0xxx-01

16.4 SDL flex cable 5CASDL.0xxx-03

The SDL flex cables 5CASDL.0xxx-03 are designed for both fixed and flexible installations (e.g. in swing arm systems).

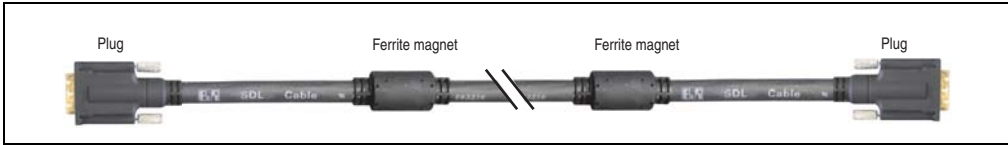

Figure 230: SDL cable 5CASDL.0xxx-03 (similar)

Caution!

SDL cables can only be plugged in and unplugged when the device is turned off.

16.4.1 Order data

Model number	Description	Note
5CASDL.0018-03	SDL flex cable 1.8 m SDL cable for fixed and flexible type of layout; length: 1.8 m	
5CASDL.0050-03	SDL flex cable 5 m SDL cable for fixed and flexible type of layout; length: 5 m	
5CASDL.0100-03	SDL flex cable 10 m SDL cable for fixed and flexible type of layout; length: 10 m	
5CASDL.0150-03	SDL flex cable 15 m SDL cable for fixed and flexible type of layout; length: 15 m	
5CASDL.0200-03	SDL flex cable 20 m SDL cable for fixed and flexible type of layout; length: 20 m	
5CASDL.0250-03	SDL flex cable 25 m SDL cable for fixed and flexible type of layout; length: 25 m	
5CASDL.0300-03	SDL flex cable 30 m SDL cable for fixed and flexible type of layout; length: 30 m	

Table 239: Model numbers - SDL cable 5CASDL.0xxx-03

16.4.2 Technical data

Mechanical characteristics	5CASDL.0018-03	5CASDL.0050-03	5CASDL.0100-03	5CASDL.0150-03	5CASDL.0200-03	5CASDL.0250-03	5CASDL.0300-03
Length Tolerance	1.8 m ±20 mm	5 m ±45 mm	10 m ±90 mm	15 m ±135 mm	20 m ±180 mm	25 m ±225 mm	30 m ±270 mm
Cable diameter Maximum	12 mm						
Shielding	Individual cable pairs and entire cable						
Connector type Connection cycles Contacts Mechanical protection	2x DVI-D (24+1), male Min. 200 Gold plated Metal cover with crimped stress relief						
Max. tension During installation During operation	≤ 400 N ≤ 50 N						
Materials Cable shield Color	RoHS compliant Aluminum foil clad + tinned copper mesh Black (similar to RAL 9005)						
Flexibility	Flexible; valid for ferrite magnet - ferrite magnet (tested 300,000 cycles with 15x cable diameter, 4800 cycles / hour)						
Flex radius Fixed layout flexible installation	See figure "Flex radius specification", on page 431 6 x cable diameter (from plug to ferrite magnet) 10x cable diameter (of ferrite magnet - ferrite magnet) 15x cable diameter (of ferrite magnet - ferrite magnet)						
Weight	Approx. 460 g	Approx. 1020 g	Approx. 1940 g	Approx. 2840 g	Approx. 3740 g	Approx. 4560 g	Approx. 5590 g
Electrical properties (at +20°C)							
Wire cross section	24 AWG (control wires) 26 AWG (DVI, USB, data)						
Line resistance 24 AWG 26 AWG	≤ 95 Ω/km ≤ 145 Ω/km						
Insulation resistance	> 200 MΩ/km						
Wave impedance	100 ±10 Ω						
Test voltage Wire / wire Wire / shield	1 kV _{eff} 0.5 kV _{eff}						
Operating voltage	≤ 30 V						
Environmental characteristics							
Temperature resistance Fixed installation Moving Storage	-20 to +80°C -5 to +60°C -20 to +80°C						
Standards and certifications							
Torsion load	100000 cycles (tested angle of rotation: ±85° speed: 50 cycles / minute)						

Table 240: Technical data - SDL cable 5CASDL.0xxx-03

Standards and certifications	5CASDL.0018-03	5CASDL.0050-03	5CASDL.0100-03	5CASDL.0150-03	5CASDL.0200-03	5CASDL.0250-03	5CASDL.0300-03
Cable drag chain	300,000 cycles Tested flex radius: 180 mm; 15x cable diameter; hub: 460 mm; speed: 4800 cycles / hour						
Approbation	UL AWM 20236 80°C 30 V						
Oil and hydrolysis resistance	According to VDE 0282-10						

Table 240: Technical data - SDL cable 5CASDL.0xxx-03 (Forts.)

Flex radius specification

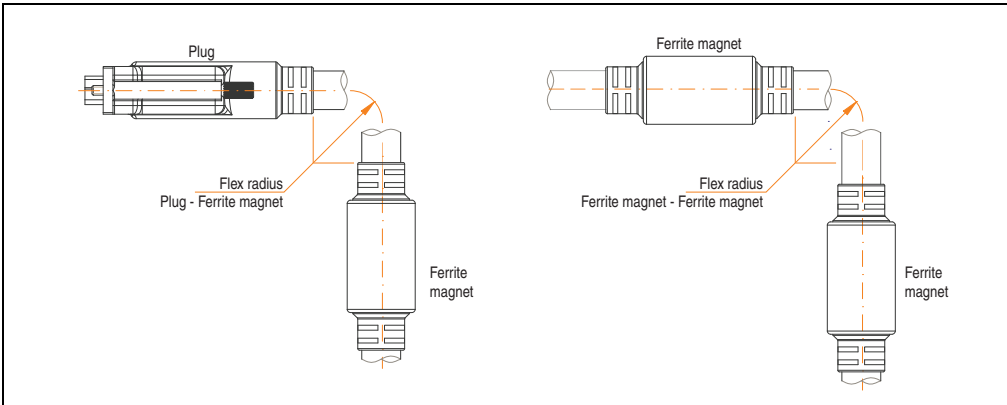

Figure 231: Flex radius specification

Dimensions

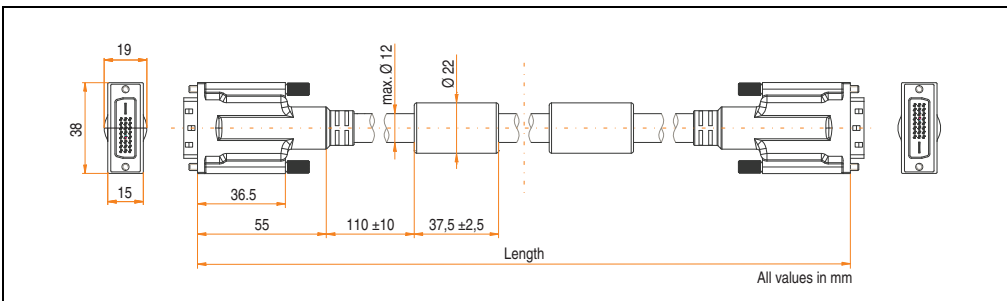

Figure 232: Dimensions - SDL cable 5CASDL.0xxx-03

Contents of delivery

Amount	Component
1	SDL flex cable in desired length, plug covers are attached at the cable ends.

Table 241: Contents of delivery - SDL flex cable 5CASDL.0xxx-03

Construction

Element	Assignment	Cross section	
DVI	TMDS data 0	26 AWG	 <p>Schematic display</p>
	TMDS data 1	26 AWG	
	TMDS data 2	26 AWG	
	TMDS cycle	26 AWG	
USB	XUSB0	26 AWG	
	XUSB1	26 AWG	
Data	SDL	26 AWG	
Control wires	DDC cycle	24 AWG	
	DDC data	24 AWG	
	+5 V	24 AWG	
	mass	24 AWG	
	Hot Plug detect	24 AWG	

Table 242: Structure - SDL cable 5CASDL.0xxx-03

16.4.3 Cable specifications

The following figure shows the pin assignments for the SDL cable available at B&R. If you want to build a suitable cable yourself, it should be wired according to these specifications.

Warning!

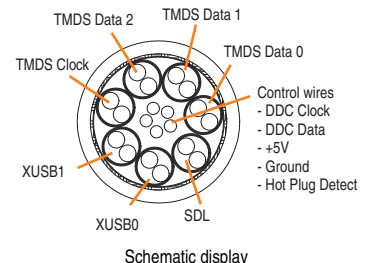
If a self-built cable is used, B&R cannot guarantee that it will function properly.

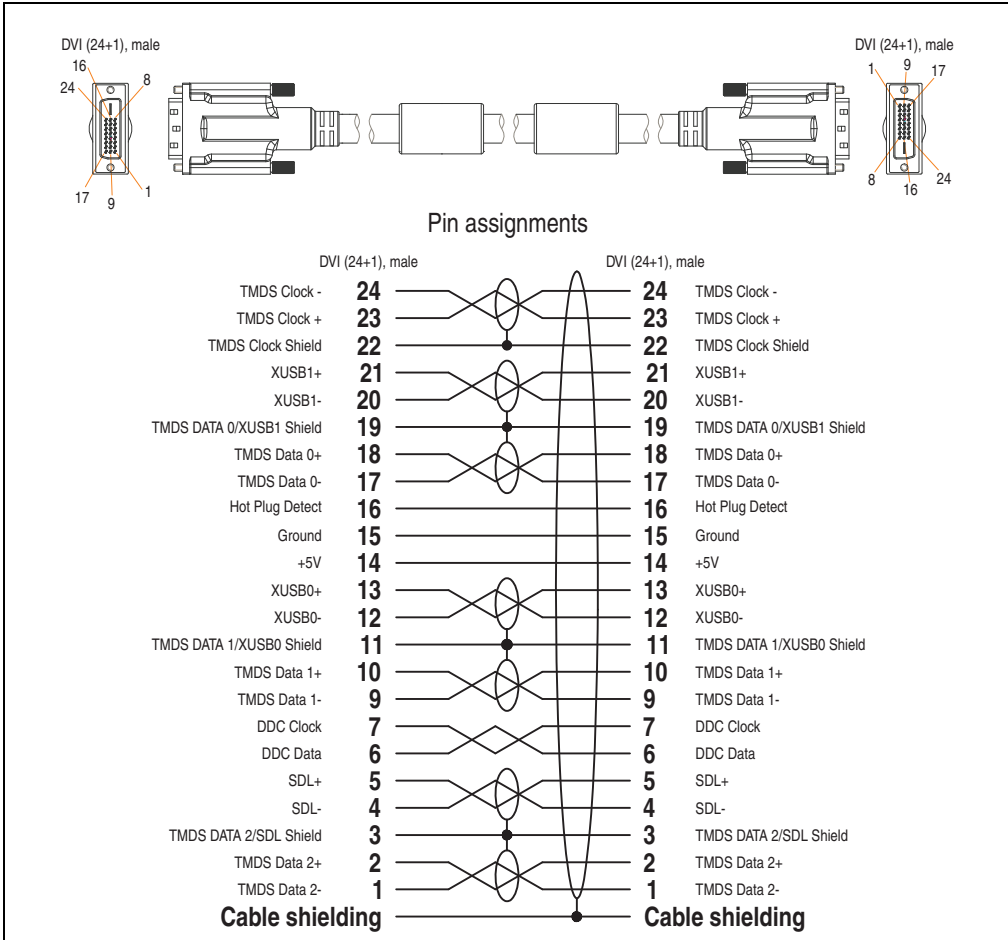

Figure 233: Pin assignments - SDL cable 5CASDL.0xxx-03

16.5 SDL flex cable with extender 5CASDL.0xx0-13

The SDL flex cables (with extender) 5CASDL.0xx0-13 are designed for both fixed and flexible installations (e.g. in swing arm systems).

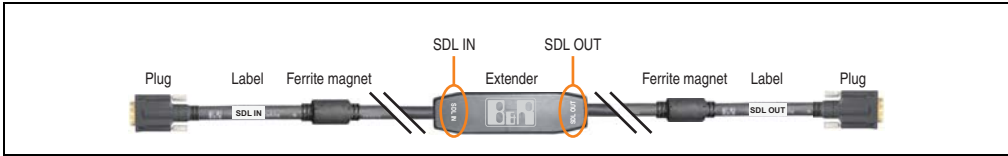

Figure 234: SDL flex cable with extender - 5CASDL.0xx0-13 (similar)

Caution!

SDL cables with extender can only be plugged in and unplugged when the device is turned off. The correct direction of connection (SDL IN, SDL OUT) for the wiring is illustrated on the middle of the extender and between the ferrite magnet and plug (with a sticker).

16.5.1 Order data

Model number	Description	Note
5CASDL.0300-13	SDL flex cable with extender 30 m SDL cable with extender for fixed and flexible type of layout; length: 30 m	
5CASDL.0400-13	SDL flex cable with extender 40 m SDL cable with extender for fixed and flexible type of layout; length: 40 m	
5CASDL.0430-13	SDL flex cable with extender 43 m SDL cable with extender for fixed and flexible type of layout; length: 43 m	

Table 243: Model numbers - SDL flex cable with extender 5CASDL.0xx0-13

16.5.2 Technical data

Features	5CASDL.0300-13	5CASDL.0400-13	5CASDL.0430-13
Length Tolerance	30 m ±280 mm	40 m ±380 mm	43 m ±410 mm
Dimensions - Extender box Height Width Length		18.5 mm 35 mm 125 mm	
Cable diameter Maximum		12 mm	
Shielding		Individual cable pairs and entire cable	
Connector type Connection cycles Contacts Mechanical protection		2x DVI-D (24+1), male Min. 200 Gold plated Metal cover with crimped stress relief	
Max. tension During installation During operation		≤ 400 N ≤ 50 N	
Materials Cable shield Color		RoHS compliant Aluminum foil clad + tinned copper mesh Black (similar to RAL 9005)	
Flexibility	Flexible; valid for ferrite magnet - ferrite magnet (tested 300,000 cycles with 15x cable diameter, 4800 cycles / hour)		
Flex radius Fixed layout flexible installation	See figure "Flex radius specification", on page 436 6 x cable diameter (from plug to ferrite magnet) 10 x cable diameter (of ferrite magnet - extender) 15x cable diameter (of ferrite magnet - ferrite magnet)		
Weight	Approx. 5430 g	Approx. 7200 g	Approx. 7790 g
Electrical properties (at +20°C)			
Wire cross section	24 AWG (control wires) 26 AWG (DVI, USB, data)		
Line resistance 24 AWG 26 AWG	≤ 95 Ω/km ≤ 145 Ω/km		
Insulation resistance	> 200 MΩ/km		
Wave impedance	100 ± 10 Ω		
Test voltage Wire / wire Wire / shield	1 kV _{eff} 0.5 kV _{eff}		
Operating voltage	≤ 30 V		
Environmental characteristics			
Ambient temperatures Fixed installation Moving Storage	-20 to +60°C -5 to +60°C -20 to +60°C		

Table 244: Technical data - SDL flex cable with extender 5CASDL.0xx0-13

Accessories • Cables

Standards and certifications	5CASDL.0300-13	5CASDL.0400-13	5CASDL.0430-13
Torsion load	100000 cycles (tested angle of rotation: $\pm 85^\circ$ speed: 50 cycles / minute)		
Cable drag chain	300,000 cycles Tested flex radius: 180 mm; 15x cable diameter; hub: 460 mm; speed: 4800 cycles / hour		
Approbation	UL AWM 20236 +80°C 30 V		
Oil and hydrolysis resistance	According to VDE 0282-10		

Table 244: Technical data - SDL flex cable with extender 5CASDL.0xx0-13 (Forts.)

Flex radius specification

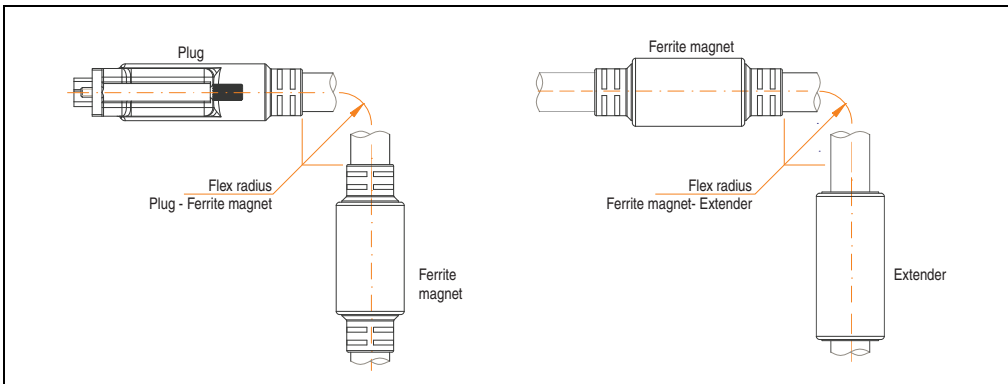

Figure 235: Flex radius specification

Dimensions

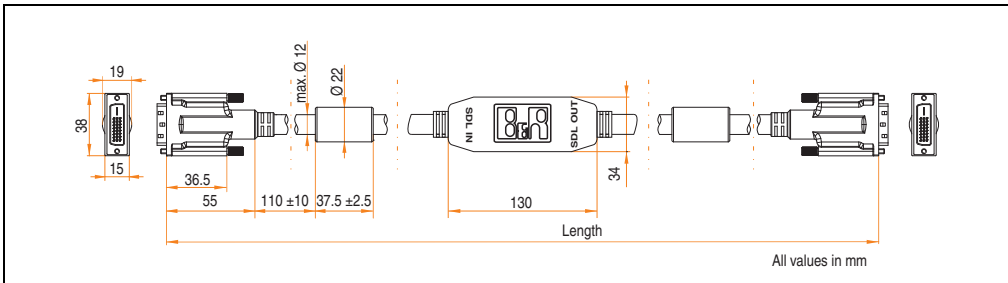

Figure 236: Dimensions - SDL flex cable with extender 5CASDL.0xx0-13

Contents of delivery

Amount	Component
1	SDL flex cable with extender in desired length, plug covers are attached at the cable ends.

Table 245: Contents of delivery - SDL flex cable with extender 5CASDL.0xx0-13

16.5.3 Cable connection

The SDL flex cable with extender must be connected between the Industrial PC and Automation Panel 900 display unit in the correct direction. The signal direction is indicated on the extender unit for this purpose:

- Connect the end labeled "SDL IN" with the video output of the APC 620 / APC 810 or Panel PC 700 (monitor/panel output) or Panel OUT of an AP900 AP Link card.
- The "SDL OUT" end should be connected to the display unit (e.g. Automation Panel 900) via the Automation Panel Link insert card (Panel IN).

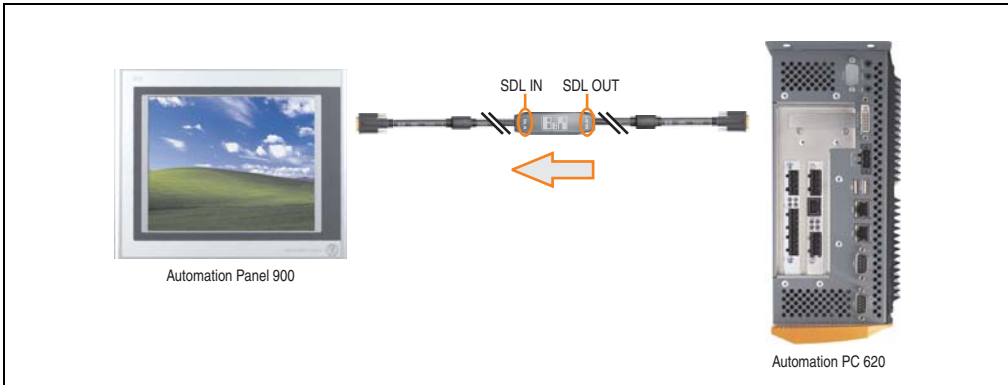

Figure 237: Example of the signal direction for the SDL flex cable with extender - APC620

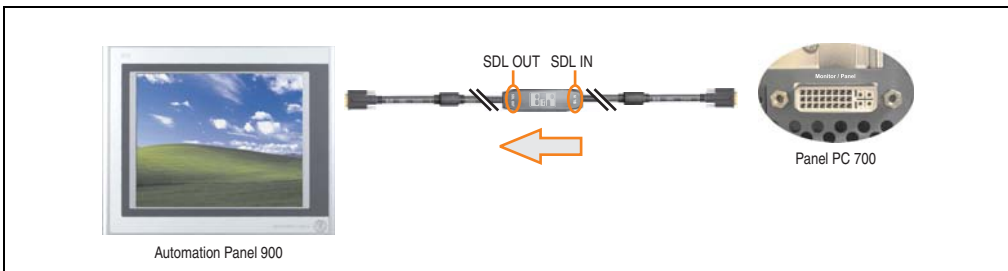

Figure 238: Example of signal direction for the SDL flex cable with extender - PPC700

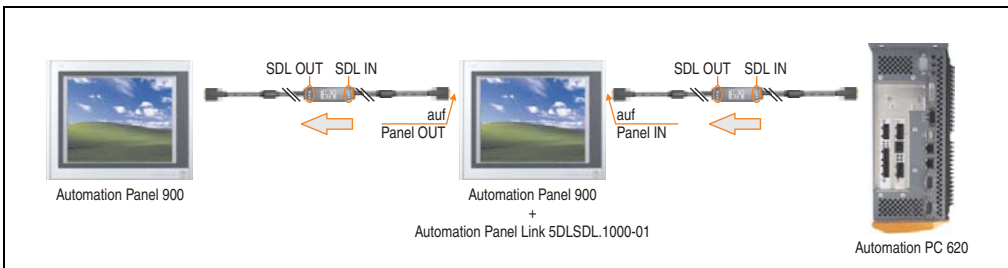

Figure 239: Example of signal direction display - SDL flex cable with extender

16.5.4 Cable specifications

The following figure shows the pin assignments for the SDL flex cable with extender available at B&R.

Information:

Only B&R SDL flex cables with extender can be used.

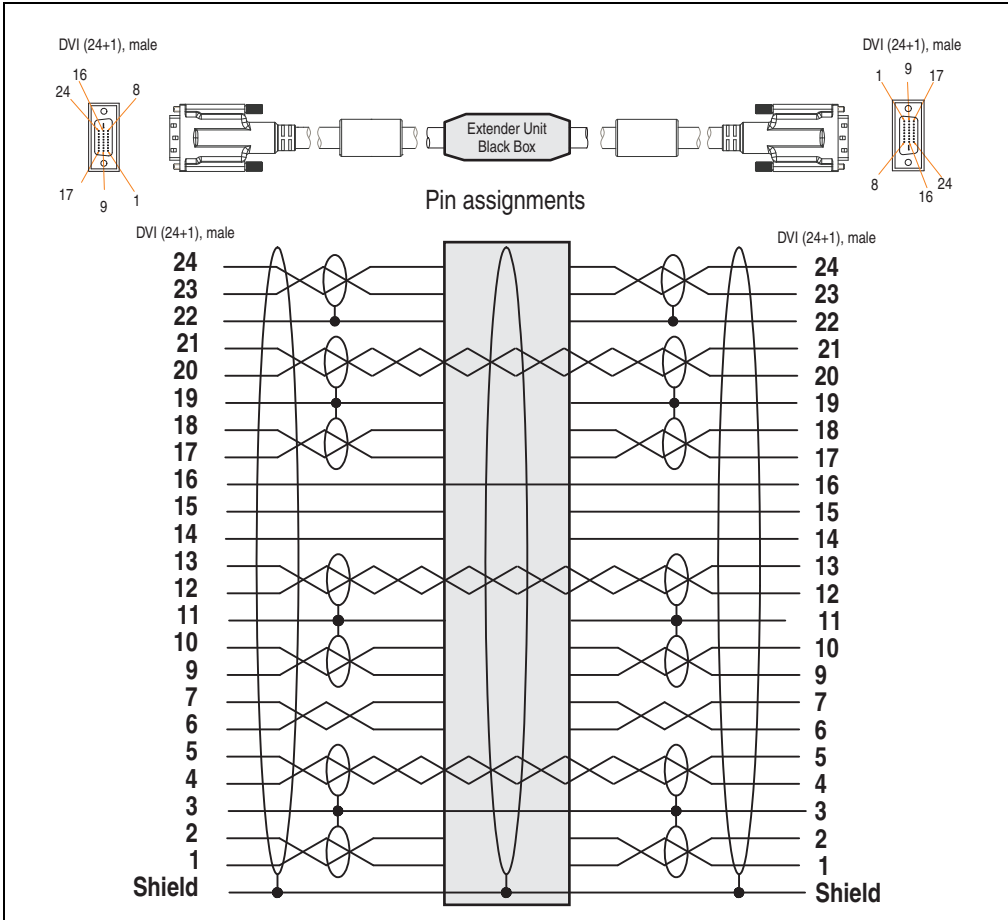

Figure 240: Pin assignments - SDL flex cable with extender 5CASDL.0xx0-13

16.6 RS232 cable 9A0014.xx

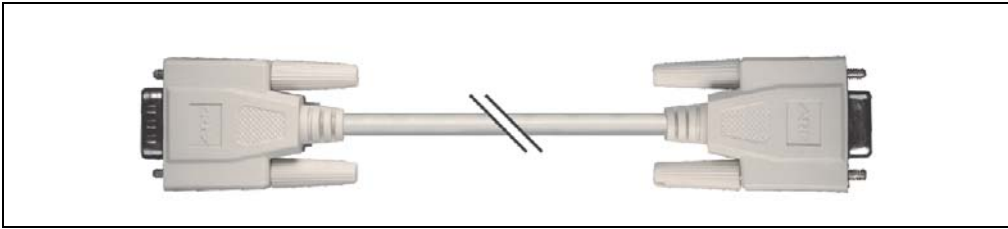

Figure 241: RS232 extension cable (similar)

16.6.1 Order data

Model number	Description	Note
9A0014.02	RS232 cable DB9/f:DB9/m 1.8 m RS232 extension cable for remote operation of a display unit with touch screen, length 1.8 m.	
9A0014.05	RS232 cable DB9/f:DB9/m 5 m RS232 extension cable for remote operation of a display unit with touch screen, length 5 m.	
9A0014.10	RS232 cable DB9/f:DB9/m 10 m RS232 extension cable for remote operation of a display unit with touch screen, length 10 m.	

Table 246: Model numbers - RS232 cables

16.6.2 Technical data

Features	9A0014.02	9A0014.05	9A0014.10
Length	1.8 m \pm 50 mm	5 m \pm 80 mm	10 m \pm 100 mm
Outer diameter	Max. 5 mm		
Shielding	Entire cable		
Connector type	DSUB (9-pin), male / female		
Wire cross section	AWG 26		
Flexibility	Flexible		
Flex radius	Min. 70 mm		

Table 247: Technical data - RS232 cables

Contents of delivery

Amount	Component
1	RS232 cable in desired length

Table 248: Contents of delivery - RS232 cables 9A0014.xx

16.6.3 Cable specifications

The following figure shows the pin assignments for the RS232 cable available at B&R. If you want to build a suitable cable yourself, it should be wired according to these specifications.

Warning!

If a self-built cable is used, B&R cannot guarantee that it will function properly.

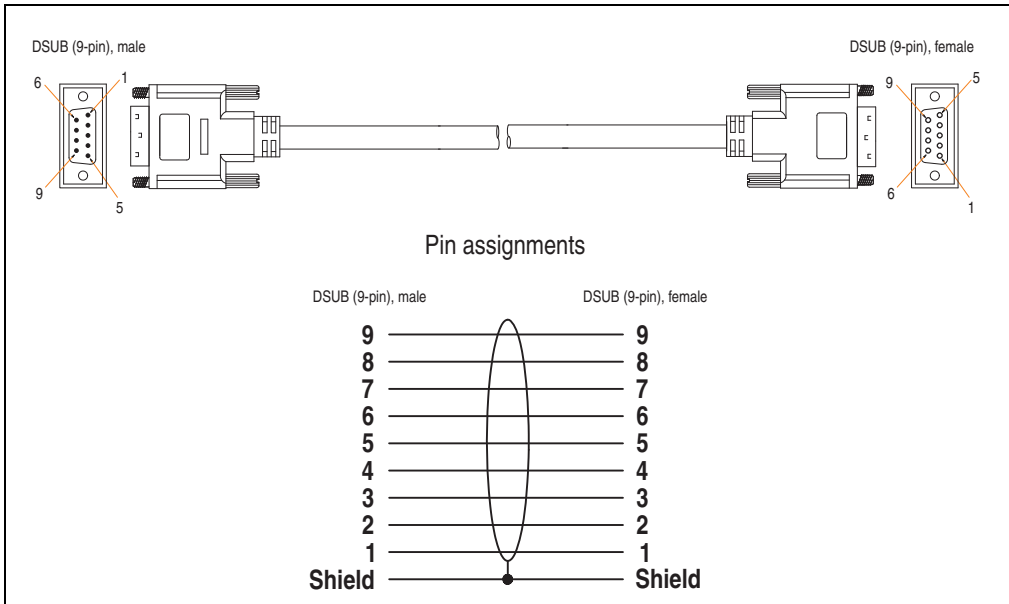

Figure 242: Pin assignments - RS232 cable

16.7 USB cable 5CAUSB.00xx-00



Figure 243: USB extension cable (similar)

16.7.1 Order data

Model number	Description	Note
5CAUSB.0018-00	USB 2.0 cable, A/m:B/m 1.8 m USB 2.0 connection cable; plug type A - type B; length 1.8 m	
5CAUSB.0050-00	USB 2.0 cable, A/m:B/m 5 m USB 2.0 connection cable; plug type A - type B; length 5 m	

Table 249: Model numbers - USB cables

16.7.2 Technical data

Features	5CAUSB.0018-00	5CAUSB.0050-00
Length	1.8 m ±30 mm	5 m ±50 mm
Outer diameter	Max. 5 mm	
Shielding	Entire cable	
Connector type	USB type A male and USB type B male	
Wire cross section	AWG 24, 28	
Flexibility	Flexible	
Flex radius	Min. 100 mm	

Table 250: Technical data - USB cables

Contents of delivery

Amount	Component
1	USB cable in desired length

Table 251: Contents of delivery - USB cable

16.7.3 Cable specifications

The following figure shows the pin assignments for the USB cable available at B&R. If you want to build a suitable cable yourself, it should be wired according to these specifications.

Warning!

If a self-built cable is used, B&R cannot guarantee that it will function properly.

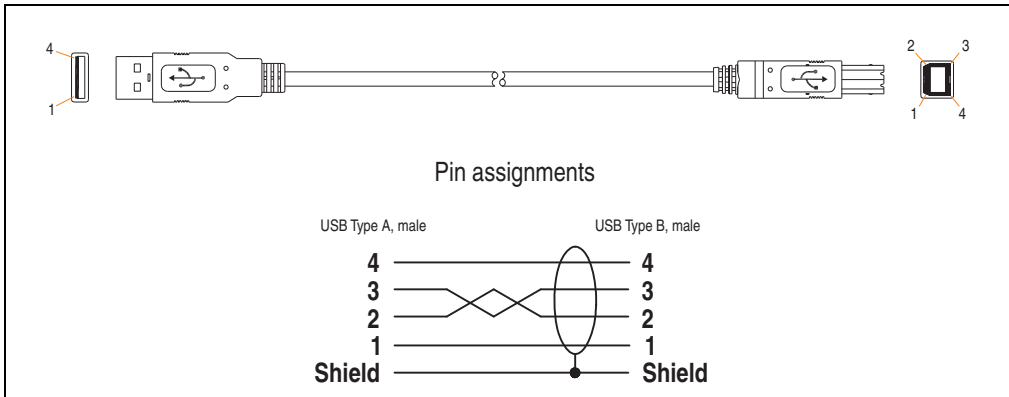

Figure 244: Pin assignments - USB cable

17. Legend strip templates

Panel PC 700 devices with keys are delivered with partially pre-labeled key legend strips (F1, F2, etc.). The key legend strip slots are accessible on the back of the Panel PC 700 device (above and below).

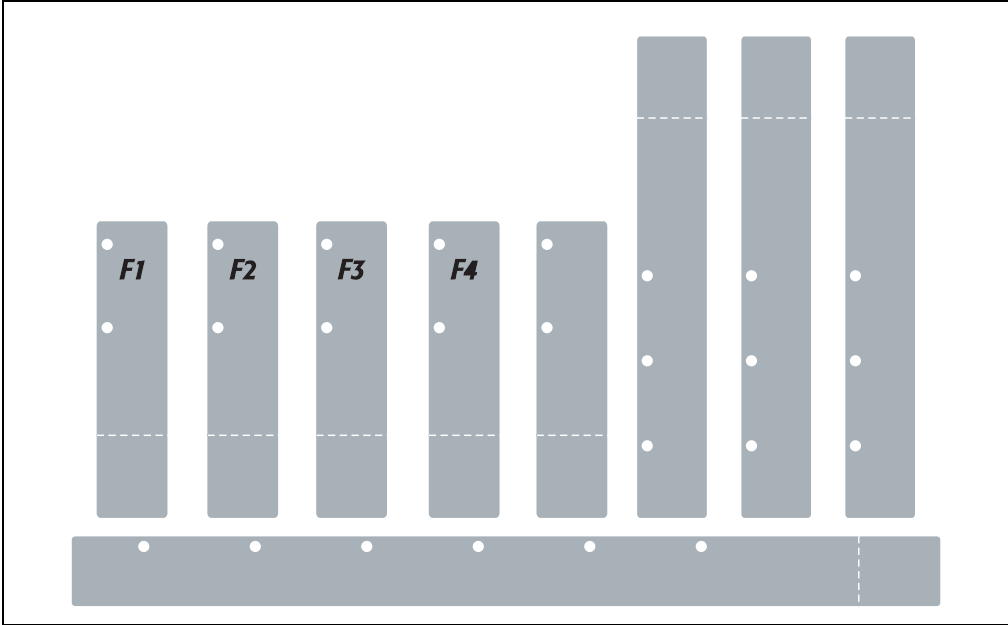

Figure 245: Legend strip templates

Printable legend strips (A4 format) can be ordered from B&R (see table 18 "Model numbers - Other items", on page 33). They can be printed using a standard laser printer (b/w or color) in a temperature range from -40°C to +125°C. A print template (available for Corel Draw version 7, 9 and 10) for the respective legend strip template can be downloaded from the B&R homepage (www.br-automation.com). The print templates can also be found on the HMI Drivers & Utilities DVD (model number 5SWHMI.0000-00).

17.1 Order data

Model number	Description	Image
5AC900.104X-00	Legend strip template 10.4" portrait format Legend strip template for Panel PC 700 system unit 5PC781.1043-00. For 1 device.	Examples of legend strip templates 
5AC900.104X-01	Legend strip template 10.4" landscape format Legend strip template for Panel PC 700 system unit 5PC782.1043-00. For 1 device.	
5AC900.150X-01	Legend strip template 15" Legend strip template for Panel PC 700 system unit 5PC781.1505-00. For 4 devices.	

Table 252: Order data - Legend strip templates

18. Replacement fan

Information:

The fan filters are subject to wear, and should be checked with appropriate frequency to determine whether the air flow provides sufficient cooling. An exchange or cleaning of the filter kit is appropriate at that time.

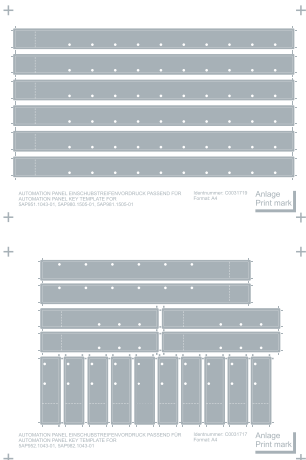
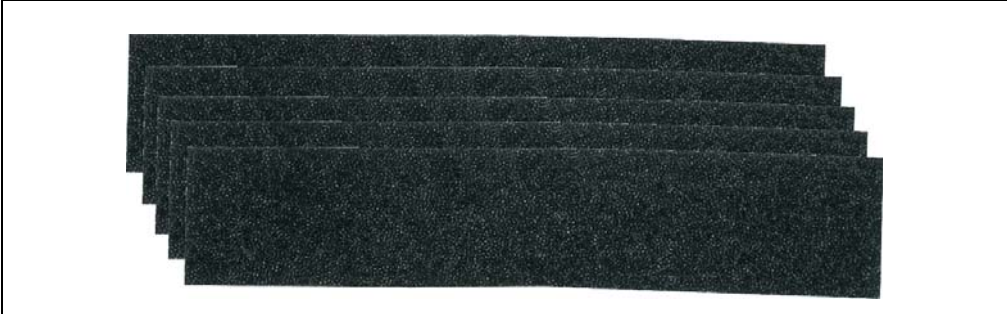

Figure 246: Replacement fan

18.1 5AC700.FA00-00

This fan filter can be used as an option for 10.4", 12.1", 15", 17" and 19" Panel PC 700 system units with 0 PCI slots (5PC720.1043-00, 5PC720.1214-00, 5PC720.1505-00, 5PC720.1706-00, 5PC720.1906-00, 5PC781.1043-00, 5PC781.1505-00 and 5PC782.1043-00).

18.2 5AC700.FA02-00

This fan filter can be used as an option for 10.4", 12.1" or 15" Panel PC 700 system units with 1 and 2 PCI slots (PC720.1043-01, 5PC720.1214-01, 5PC720.1505-01 and 5PC720.1505-02).

19. SRAM module - 5AC600.SRAM-00

The 512 KB SRAM module increases PPC700 application possibilities. It is inserted internally on the baseboard (depending on revision) and doesn't require a PCI slot. Nonvolatile data can be stored on it. The module is backed up by the PPC700 battery.

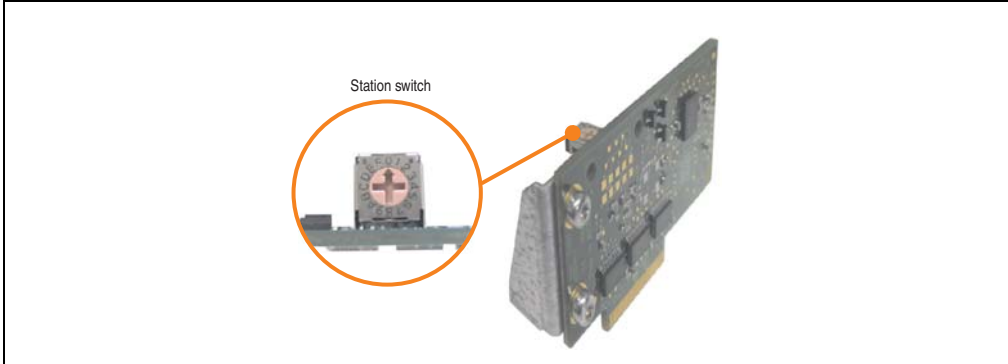

Figure 247: SRAM module - 5AC600.SRAM-00

The following system unit hardware revisions are required before mounting the SRAM module:

- 5PC720.1043-01 starting with Rev. I0
- 5PC720.1214-01 starting with Rev. D0
- 5PC720.1505-01 starting with Rev. L0
- 5PC720.1505-02 starting with Rev. K0

19.1 Technical data

Features	5AC600.SRAM-00
Connection to system	via the PCI bus (PCI PnP)
Memory Size Battery-buffered Remanent variables for AR (Automation Runtime) in power fail mode	SRAM 512 kB Yes 256 kB with CPU board 5PC600.E855-xx and 5PC600.X855-xx 192 kB with CPU board 5PC600.X945-00
Station switch	16 digits (0-F)
Data rate	Up to 31 MB/s for write access Up to 25 MB/s for read access

Table 253: Technical data - 5AC600.SRAM-00

Features	5AC600.SRAM-00	
PCI configuration space	Value	Meaning
Vendor ID Device ID Status HeaderType	1677h A085h 0200h 00h	B & R 5AC600.SRAM-00 DEVSEL timing medium Single function device
The card is registered in the PCI Configuration Space as Single Function Device	Value	Meaning
Device 0 Base class Sub class Command IRQ BAR0 BAR1	 05h 00h 0000h - 512 4	 Memory controller RAM Bus master (not used) Not used kByte memory area Byte I/O area

Table 253: Technical data - 5AC600.SRAM-00

19.2 Driver support

The module is presently only supported in an Automation Runtime environment. Driver for other operating systems (e.g. Windows XP) are available upon request.

19.3 Installation

- Remove the side cover of the PPC700.
- Screw on the M3x5 Torx included in the delivery to the baseboard of the module.

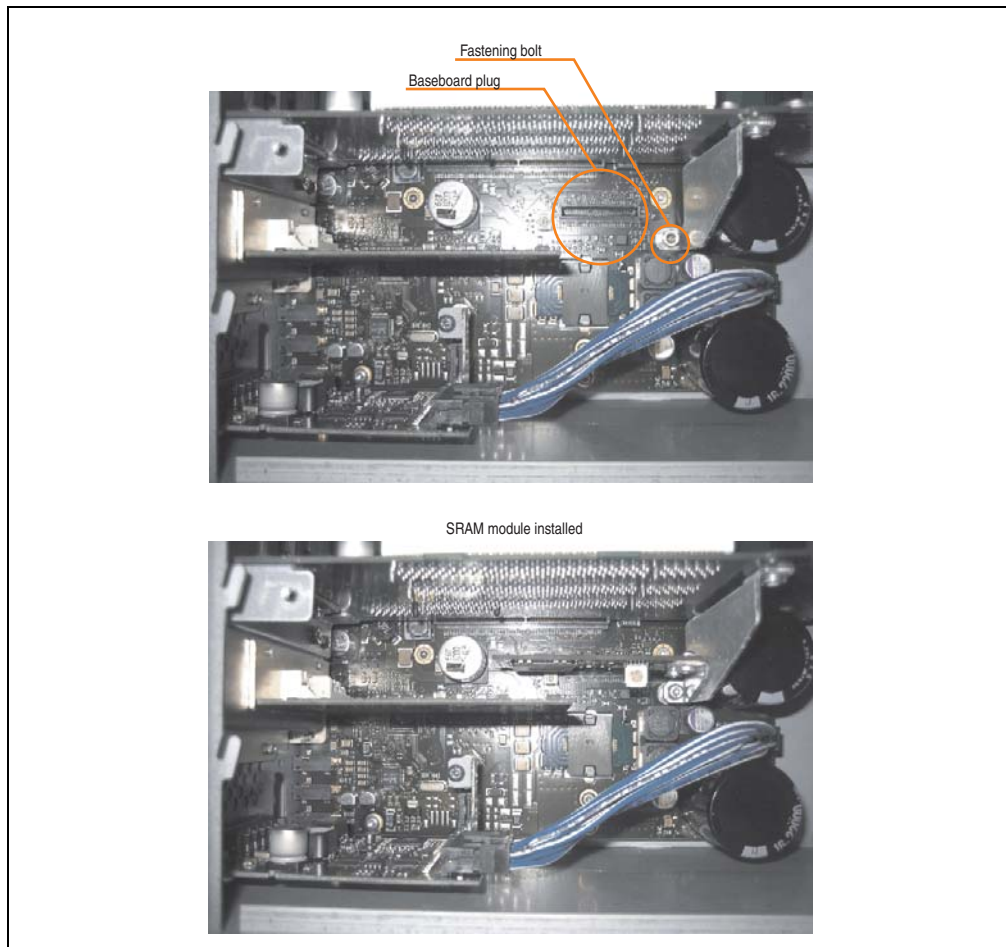

Figure 248: SRAM module installation

20. Ethernet PCI interface cards

20.1 PCI Ethernet card 10/100 - 5ACPCI.ETH1-01

The universal (3.3 V and 5 V) half-size PCI Ethernet card has a 10/100 Mbit/s network connection and can be inserted in a 16-bit PCI slot and operated as an additional network interface.

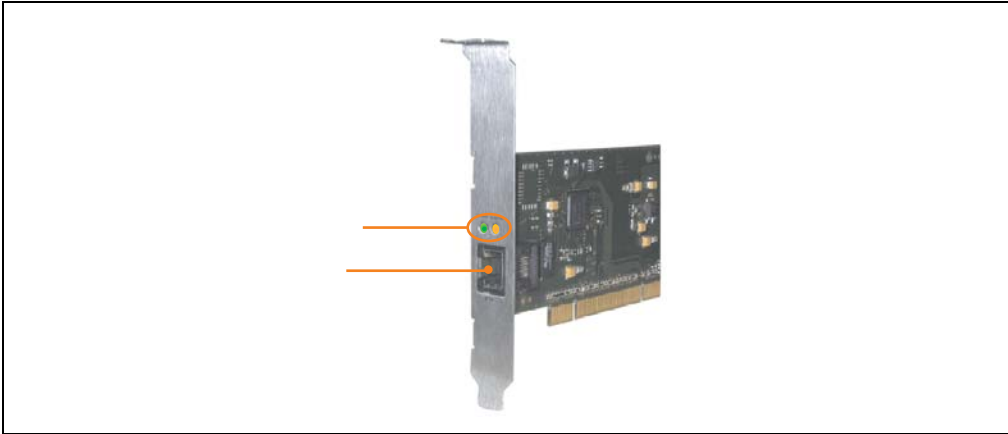

Figure 249: PCI Ethernet card 10/100 - 5ACPCI.ETH1-01

20.1.1 Technical data

Ethernet connection		
Controller	Intel 82551ER	
Power supply	Universal card (2 notches) for 3.3 V or 5 V	
Cabling	S/STP (Cat5e)	
Transfer rate	10/100 Mbit/s ¹⁾	
Cable length	max. 100 m (min. Cat5e)	
LED	On	Off
Green	100 Mbit/s	10 Mbit/s
Orange	Link (Ethernet network connection available)	Activity (blinking) (Data transfer in progress)

RJ45 twisted pair (10BaseT/100BaseT), female

Table 254: Ethernet connection ETH

1) Both operating modes possible. Switching takes place automatically.

20.1.2 Driver support

A special driver is necessary for operating the Intel Ethernet controller 82551ER. Drivers for Windows XP Professional, Windows XP Embedded, and DOS are available for download on the B&R Homepage in the download area (www.br-automation.com).

Information:

Required drivers can only be downloaded from the B&R homepage, not from manufacturers' pages.

20.1.3 Dimensions

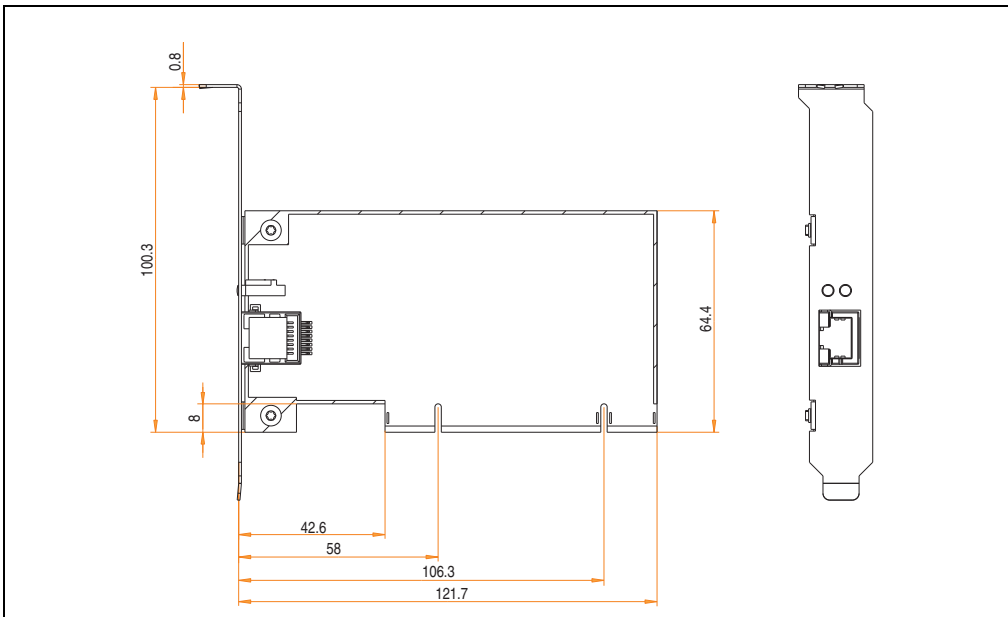

Figure 250: Dimensions - 5ACPCI.ETH1-01

20.2 PCI Ethernet card 10/100 - 5ACPCI.ETH3-01

The universal (3.3 V and 5 V) half-size PCI Ethernet card has three 10/100 Mbit/s network connections and can be inserted in a 16-bit PCI slot and operated as an additional network interface.

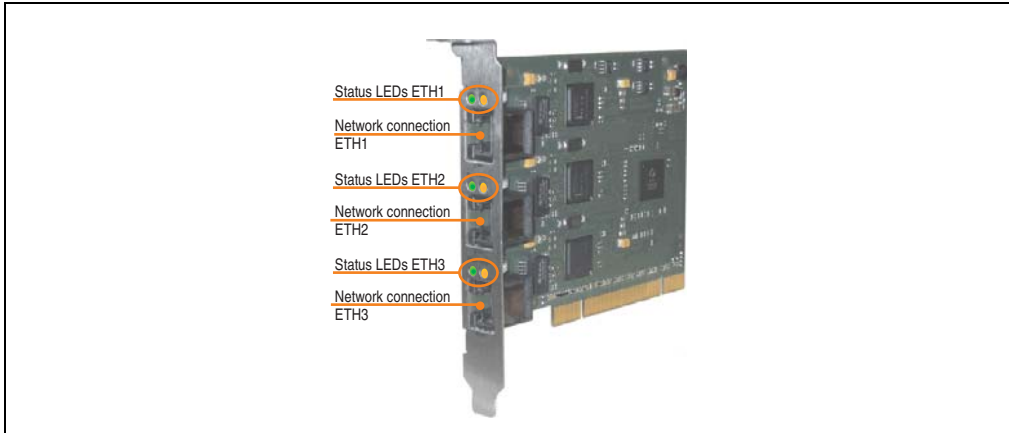

Figure 251: PCI Ethernet card 10/100 - 5ACPCI.ETH3-01

20.2.1 Technical data

Ethernet connections		
Controller	each with Intel 82551ER	
Power supply	Universal card (2 notches) for 3.3 V or 5 V	
Cabling	each S/STP (Cat5e)	
Transfer rate	each 10/100 Mbit/s ¹⁾	
Cable length	each max. 100 m (min. Cat5e)	
LED	On	Off
Green	100 Mbit/s	10 Mbit/s
Orange	Link (Ethernet network connection available)	Activity (blinking) (Data transfer in progress)

3 x RJ45 twisted pair (10BaseT/100BaseT), female

Table 255: Ethernet connections ETH1, ETH2, ETH3

¹⁾ Both operating modes possible. Switching takes place automatically.

20.2.2 Driver support

A special driver is necessary for operating the Intel Ethernet controller 82551ER. Drivers for Windows XP Professional, Windows XP Embedded, and DOS are available for download on the B&R Homepage in the download area (www.br-automation.com).

Information:

Required drivers can only be downloaded from the B&R homepage, not from manufacturers' pages.

20.2.3 Dimensions

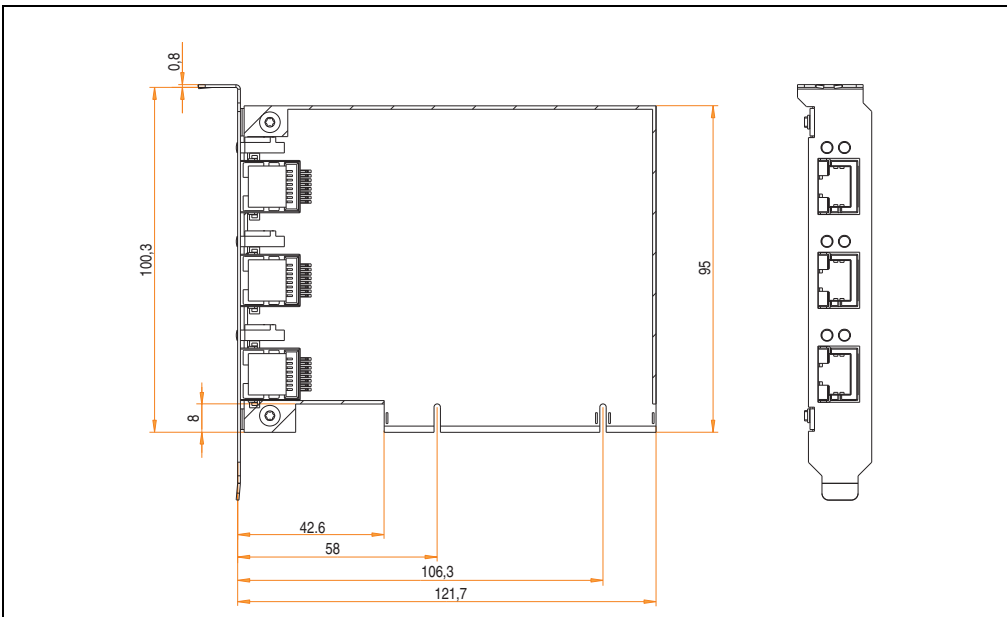

Figure 252: Dimensions - 5ACPCI.ETH3-01

Chapter 7 • Maintenance / Servicing

The following section describes service/maintenance work which can be carried out by a trained, qualified user.

1. Changing the battery

The lithium battery buffers the internal real-time clock (RTC) and the CMOS data. The buffer duration of the battery is at least 4 years (at 50°C, 8.5 µA current requirements of the supplied components and a self discharge of 40%).

1.1 Battery check

The battery status (good or bad) is checked every time the device is turned on, as well as every 24 hours. The check involves applying a load to the battery for a short time (approx. 1 second), followed by an evaluation. The evaluated battery status is displayed in the BIOS Setup pages and in the B&R Control Center (ADI driver), but can also be read in a customer application via the ADI Library.

Battery status	Meaning
OK	Data buffering is guaranteed
Bad	Data buffering is guaranteed for approx. another 500 hours from the point in time that the battery capacity is determined to be BAD (insufficient).

Table 256: Meaning of battery status OK - Bad

From the point when battery capacity is recognized as insufficient, data buffering is guaranteed for approximately another 500 hours. When changing the battery, data is buffered for approximately another 10 minutes by a gold leaf capacitor.

The following replacement lithium batteries are available:

- 4A0006.00-000 (1 piece)
- 0AC201.91 (4 pcs.)

Information:

- The product design allows the battery to be changed with the PPC700 switched either on or off. In some countries, safety regulations do not allow batteries to be changed while the module is switched on.
- Any BIOS settings that have been made will remain when the battery is changed with the power turned off (stored in non-volatile EEPROM). The date and time must be reset later because this data is lost when the battery is changed.
- The battery should only be changed by qualified personnel.

1.2 Procedure

- Disconnect the power supply to the Panel PC 700 (also see information on page 453).
- Touch the housing or ground connection (not the power supply!) in order to discharge any electrostatic charge from your body.
- Remove the black plastic cover from the battery compartment and carefully pull out the battery using the removal strips.



Figure 253: Battery removal

- Insert the new battery with correct polarity. The battery should not be held by its edges. Insulated tweezers may also be used for inserting the battery.

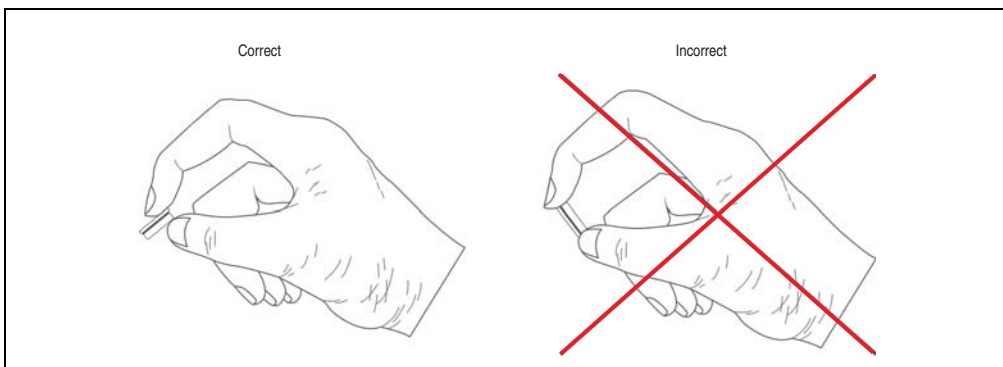

Figure 254: Battery handling

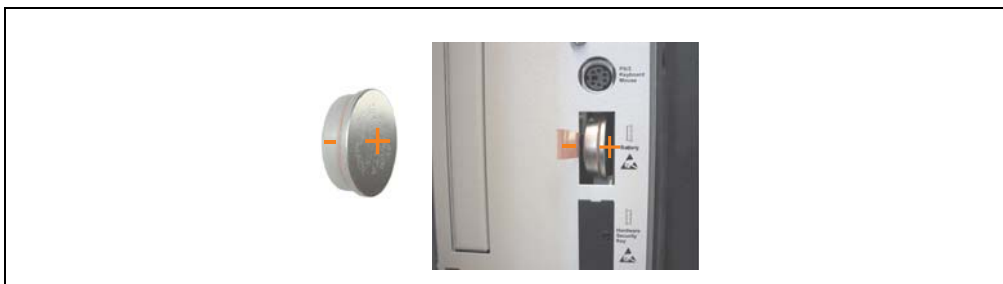

Figure 255: Battery polarity

- To make the next battery change easier, be sure the removal strip is in place when inserting battery.
- Reconnect the power supply to the Panel PC 700 by plugging the power cable back in and pressing the power button (also see information on page 453).
- Reset the data and time in BIOS (see information on page 453).

Warning!

Lithium batteries are considered hazardous waste. Used batteries should be disposed of according to local requirements.

2. Fan kit installation and replacement

2.1 Procedure - PPC700 without PCI slots

The procedure for devices without PCI slots (5PC720.1043-00, 5PC720.1214-00, 5PC720.1505-00, 5PC720.1706-00, 5PC720.1906-00, 5PC781.1043-00, 5PC781.1505-00, 5PC782.1043-00) is explained step-by-step in the following example (5PC720.1505-00).

- Disconnect the power supply to the Panel PC 700.
- Touch the housing or ground connection (not the power supply!) in order to discharge any electrostatic charge from your body.
- Loosen the nuts on the clamp (using hex key) and lift the clamp to remove. Loosen the screws on the fan kit cover (using Torx screw driver size 10) and remove the cover.



Figure 256: Removing the fan kit cover

- There are two arrows on the fans that indicate the direction of air flow and the direction of fan rotation.

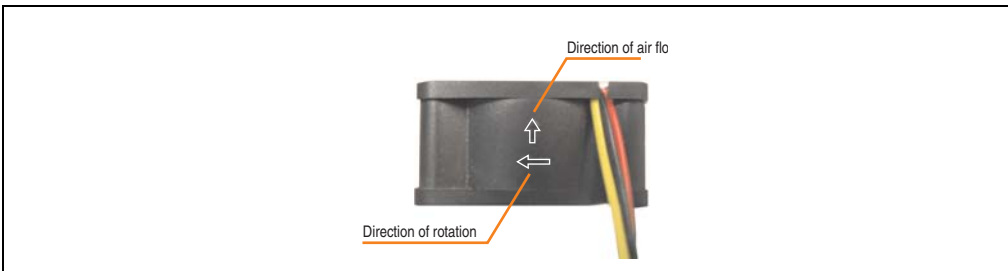

Figure 257: Marking for direction of airflow / fan rotation

Warning!

The fans must be installed so that the air flows toward the inside of the housing.

- Align fans over the fastening bolts (see arrows). Feed cables through the opening in the housing (see square) into the main board of the PPC700.

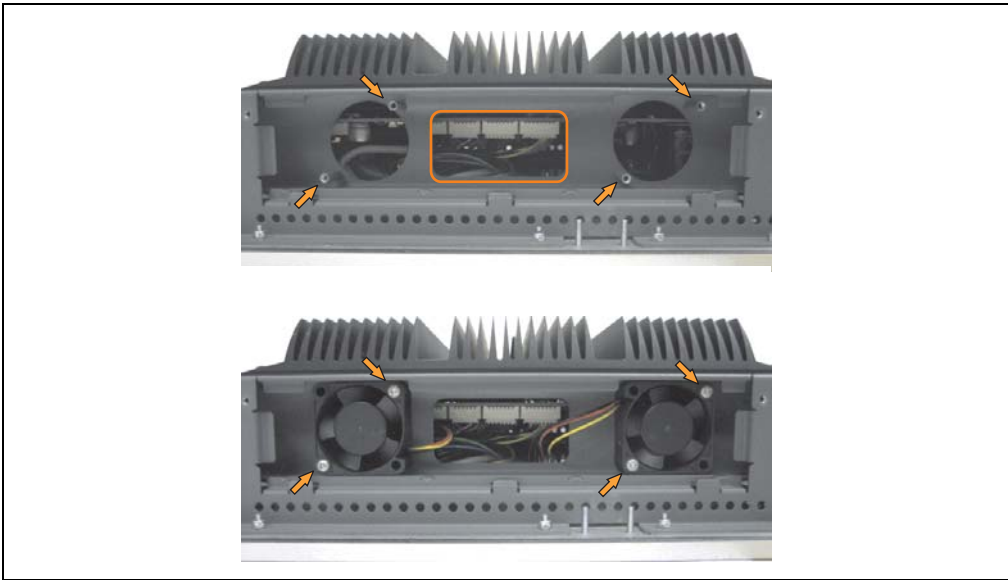

Figure 258: Fan Installation

- Secure fans with the 4 included Torx (T10) screws.
- Loosen the marked nuts (using hex key) and open the cover (open carefully because of cable).

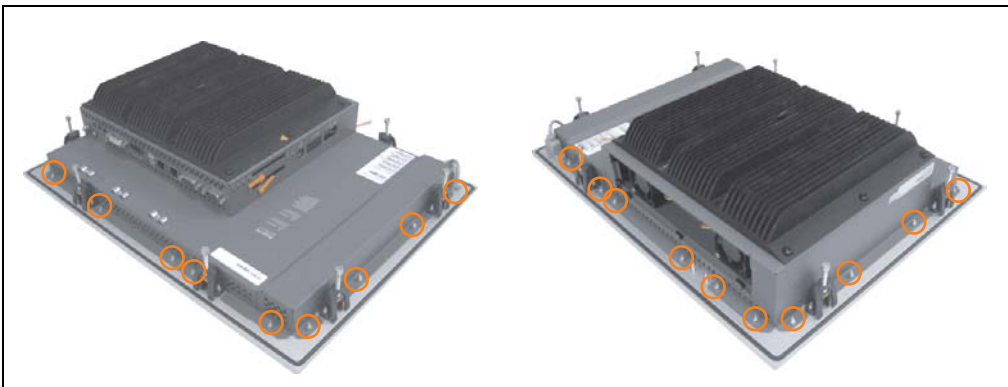

Figure 259: Removing the cover

- The fan connection cable must be connected to the main circuit board at the right position (fan 1 at position 1, fan 2 at position 2).

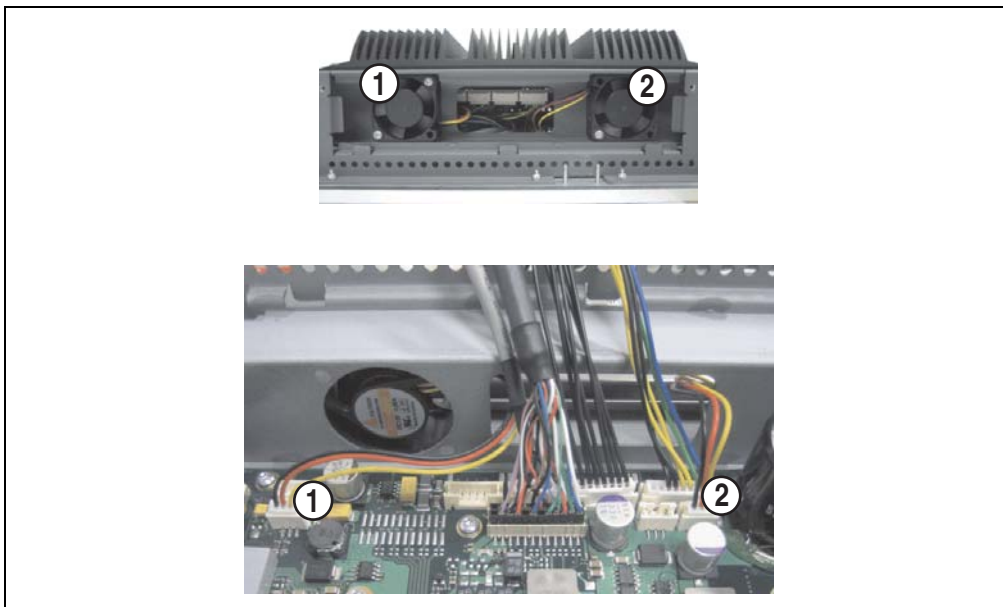

Figure 260: Fan cable connection on the main board

- Place dust filter in the fan kit cover and replace removed components (cover, filter kit cover) in reverse order.

2.2 Procedure - PPC700 with 1 and 2 PCI slots

The procedure for devices with 2 PCI slots (5PC720.1043-01, 5PC720.1214-01, 5PC720.1505-01, 5PC720.1505-02) is explained step-by-step in the following example (5PC720.1505-01).

- Disconnect the power supply to the Panel PC 700.
- Touch the housing or ground connection (not the power supply!) in order to discharge any electrostatic charge from your body.
- Loosen the screws on the fan kit cover (using Torx screw driver size 10) and remove the cover.

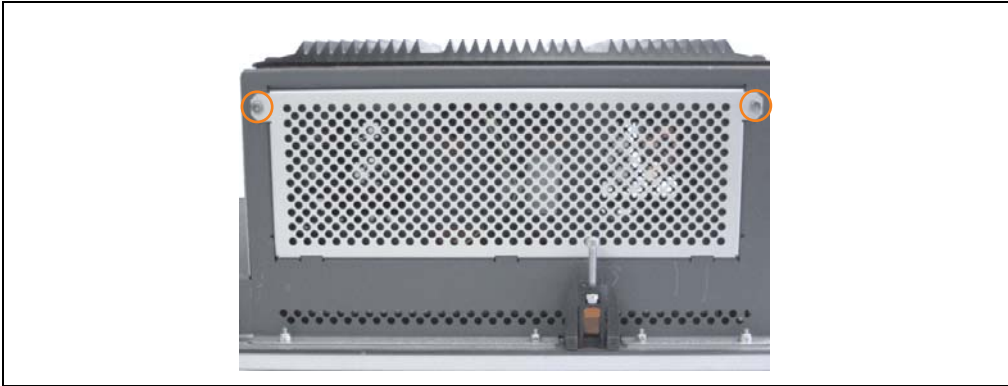

Figure 261: Removing the fan kit cover

- If a PCI card is in place, it must be removed before moving on to the next step.
- There are two arrows on the fans that indicate the direction of air flow and the direction of fan rotation.

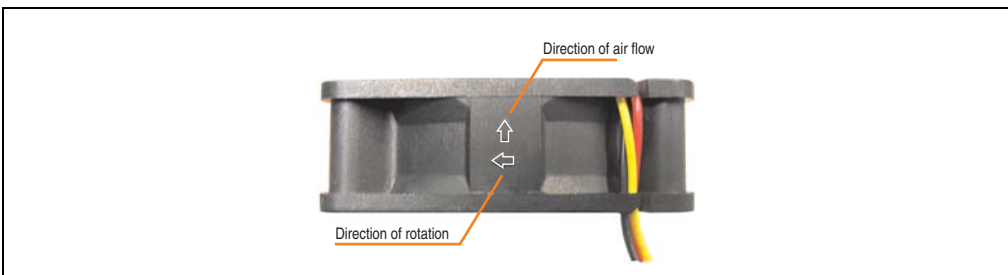

Figure 262: Marking for direction of airflow / fan rotation

Warning!

The fans must be inserted so that the air flows toward the inside of the housing.

Maintenance / Servicing • Fan kit installation and replacement

- Remove the clamp screw (see circle). Align fans over the fastening bolts (see arrows). Feed cables through the opening in the housing (see square) into the main board of the PPC700.

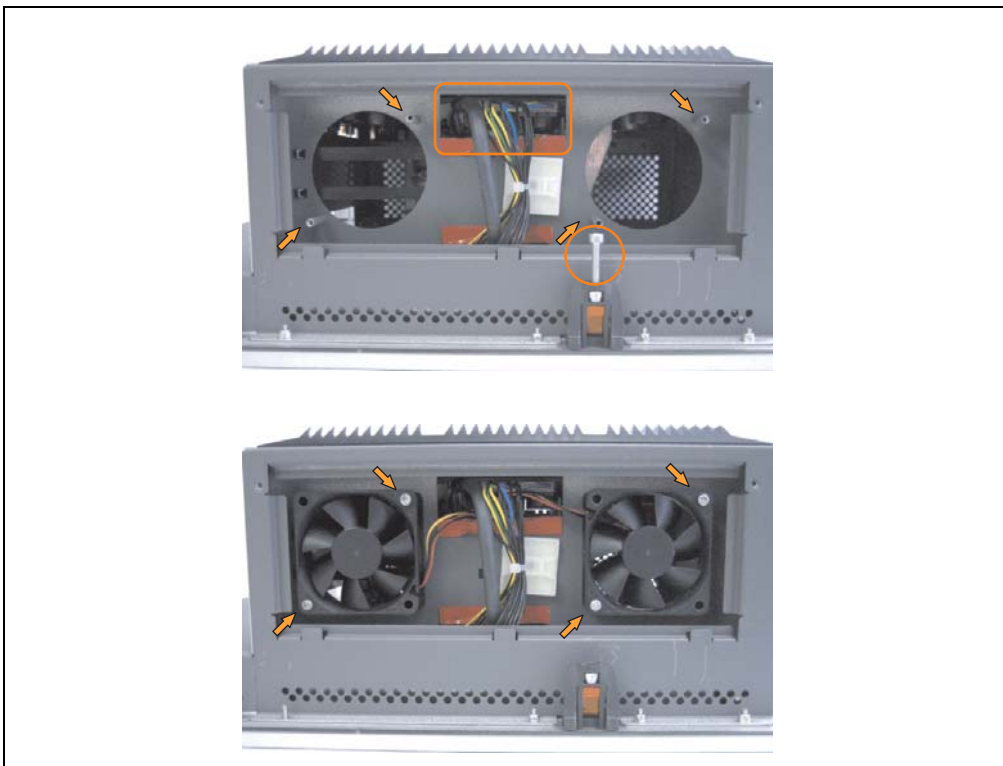

Figure 263: Fan Installation

- Secure fans with the 4 included Torx (T10) screws.

- Loosen the screws on the side cover (using Torx screw driver size 10) and remove the cover.



Figure 264: Removing the side cover

- The fan connection cable must be connected to the main circuit board at the right position (fan 1 at position 1, fan 2 at position 2).

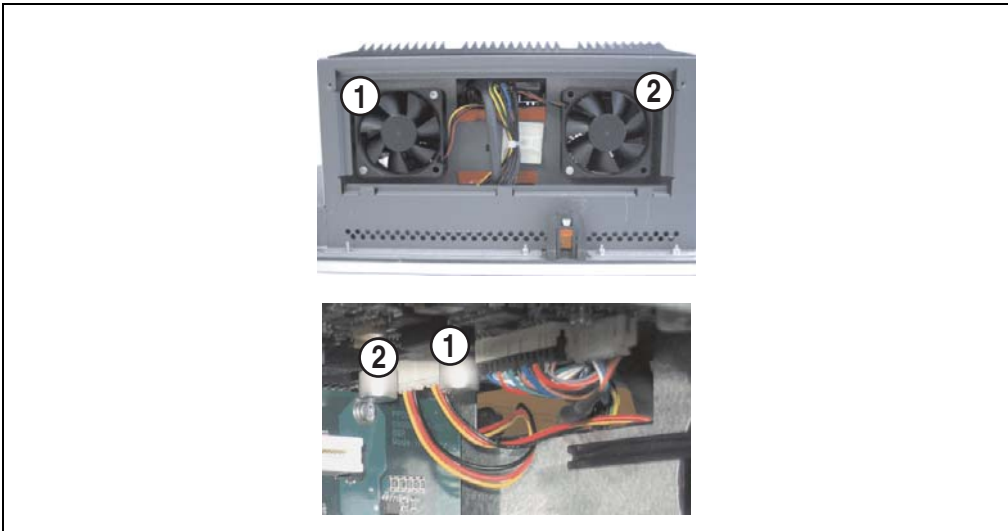

Figure 265: Fan cable connection on the main board

- If a PCI card was previously in place, it can now be re-inserted.
- Place dust filter in the fan kit cover and replace removed components (filter kit cover, side cover) in reverse order.

3. Slide-in drive - installation and exchange

A slide-in drive can be installed and exchanged in system units with 1 or 2 PCI slots.

3.1 Installation procedure

- Disconnect the power supply to the Panel PC 700.
- Touch the housing or ground connection (not the power supply!) in order to discharge any electrostatic charge from your body.
- Remove the light-gray side cover. This generally requires removing 5 Torx screws (T10).

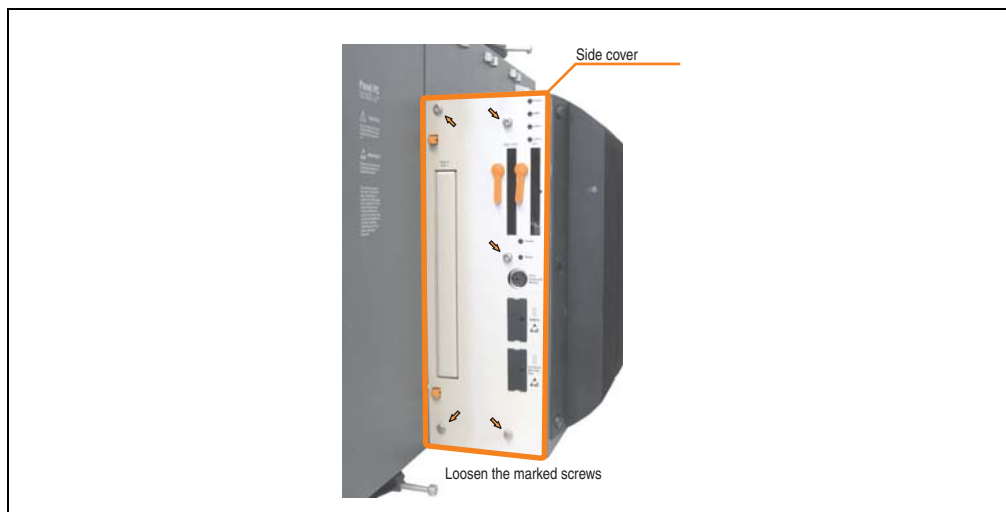

Figure 266: Example - Side cover removal on the system unit 5PC720.1505-02

- Remove the slide-in dummy module.



Figure 267: Removing the slide-in dummy module

- Insert the slide-in drive.



Figure 268: Installing the slide-in drive

- Attach the side cover.

3.2 Exchange procedure

- Disconnect the power supply to the Panel PC 700.
- Touch the housing or ground connection (not the power supply!) in order to discharge any electrostatic charge from your body.
- Remove the light-gray side cover. This generally requires removing 5 Torx screws (T10).

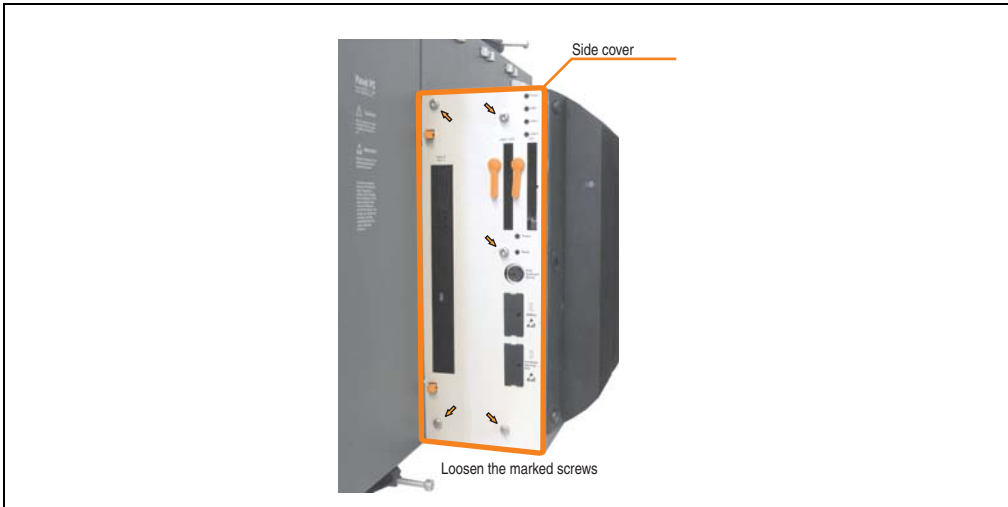

Figure 269: Example - Side cover removal on the system unit 5PC720.1505-02

- Remove both slide-in slot releasing mechanisms outwards. The slide-in drive is pushed a few mm upwards for easy removal.

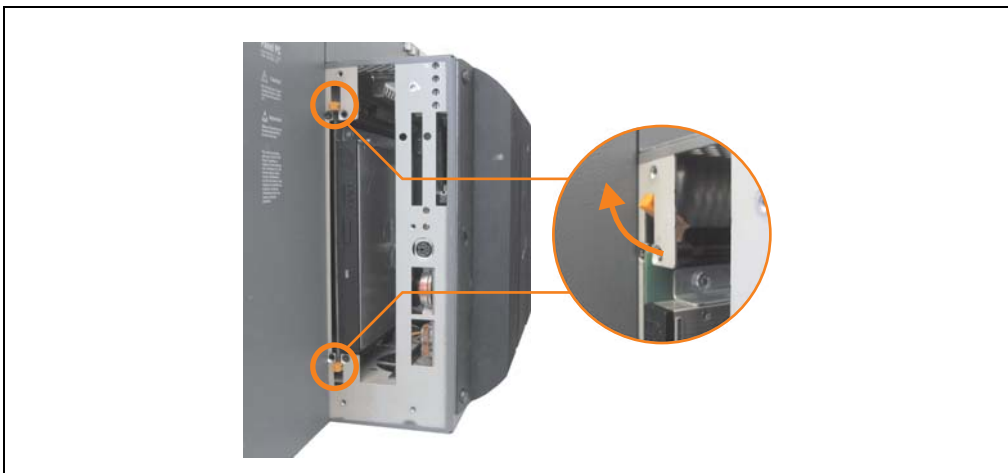

Figure 270: Release the slide-in slot releasing mechanisms

- Removing the slide-in drive.
- Move the slide-in slot releasing mechanism to the start position and insert the new slide-in drive.



Figure 271: Installing the slide-in drive

- Attach the side cover.

4. Exchanging the legend strips

The function keys can be individually labeled by simply exchanging the legend strips (see "Legend strip templates", on page 443). The designated slots for the legend strips can be accessed on the back of the PPC700 device.

4.1 Procedure

- 1) Place the Panel PC on a clean, even surface with the display facing down.
- 2) Remove blank legend strips and replace with printed ones.

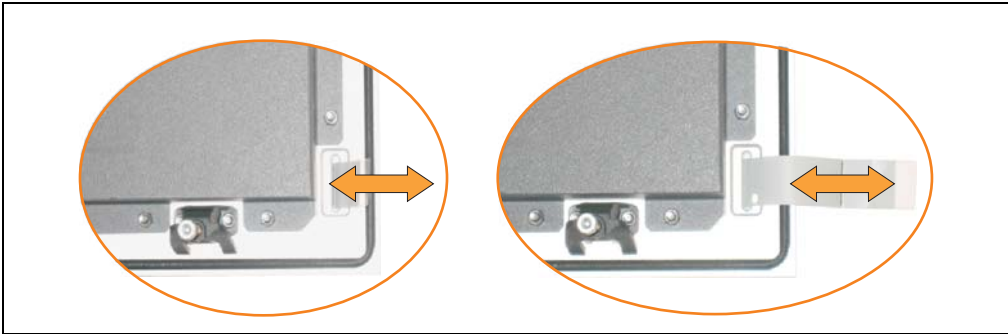

Figure 272: Exchange legend strips

5. Preventing after-image effect in LCD/TFT monitors

Burn-in effect (after images, display memory effect, image retention or also image sticking) occurs in LCD/TFT monitors when a static image is displayed for a long period of time. This static screen content causes the build-up of parasitic capacities within the LCD components that prevent the liquid crystal molecules from returning to their original states. This condition may arise, is not predictable and depends on the following factors:

- Type of image displayed
- Color composition of the image
- Length of image output
- Ambient temperature

5.1 What measures can be taken against this?

There is no total solution, however, measures can be taken to significantly reduce this effect:

- Avoid static pictures or screen content
- Use screen savers (moving) when the display is not in use
- Frequent picture change
- Shut off the display when not in use

Turning off the background lighting (backlight) does not influence the prevention of the after-image effect.

6. Exchanging a PCI SATA RAID hard disk

In the example, the assumption is made that the secondary hard disk (HDD1) is defective. A size 10 Torx screwdriver is needed for exchanging the hard disk.

Exchange procedure:

- Remove the power supply to the device (Automation PC 620 / Panel PC 700).
- Touch the housing or ground connection (not the power supply!) in order to discharge any electrostatic charge from your body.
- Remove the side cover.
- Remove the SATA RAID insert.
- Loosen the 4 appropriate mounting screws (M3x5) - see Figure 273 "Screw assignment on the back side of the SATA RAID controller", on page 468.

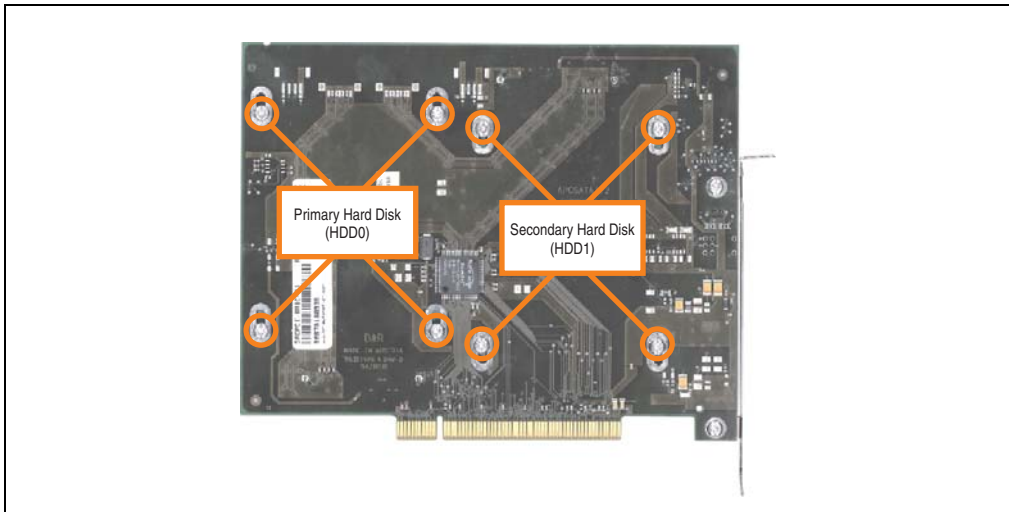

Figure 273: Screw assignment on the back side of the SATA RAID controller

- On the front side, slide the hard disk down and away (image 1).
- Carefully plug the new hard disk into the connector (image 2).

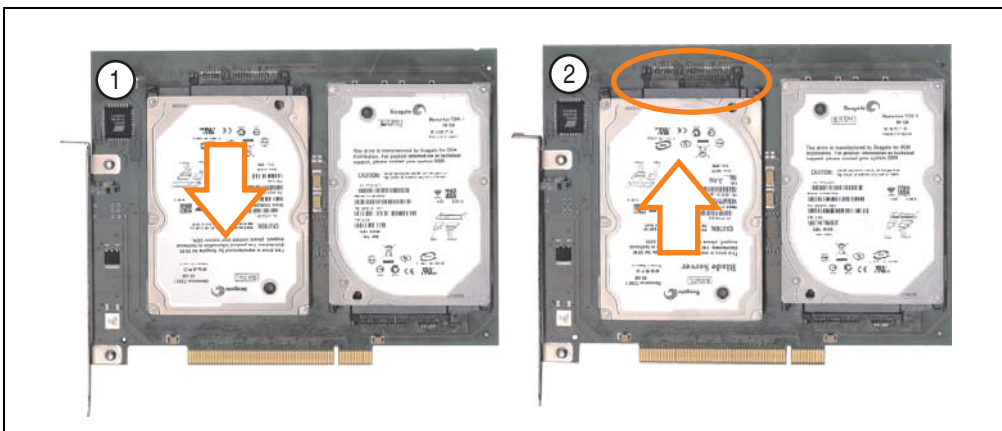

Figure 274: Hard disk exchange

- Re-secure the hard disk using the 4 fastening screws (M3x5) used earlier.
- Reassemble device in the reverse order.
- An error message is output by the RAID BIOS after starting the system "RAID1 set is in Critical status - press any key to enter Configuration Utility".

A rebuild must be executed in the SATA RAID BIOS - for more information on this, see the section "Rebuild mirrored set", on page 234.

Appendix A

1. Temperature sensor locations

Sensors monitor temperature values at different locations in the PPC700 (inside CPU, CPU board, power supply, slide-in drive 1, slide-in drive 2, I/O). The temperatures¹⁾ can be read in BIOS (menu item "Advanced" - Baseboard/panel features - Baseboard monitor) or in Microsoft Windows XP/Embedded, using the B&R Control Center²⁾.

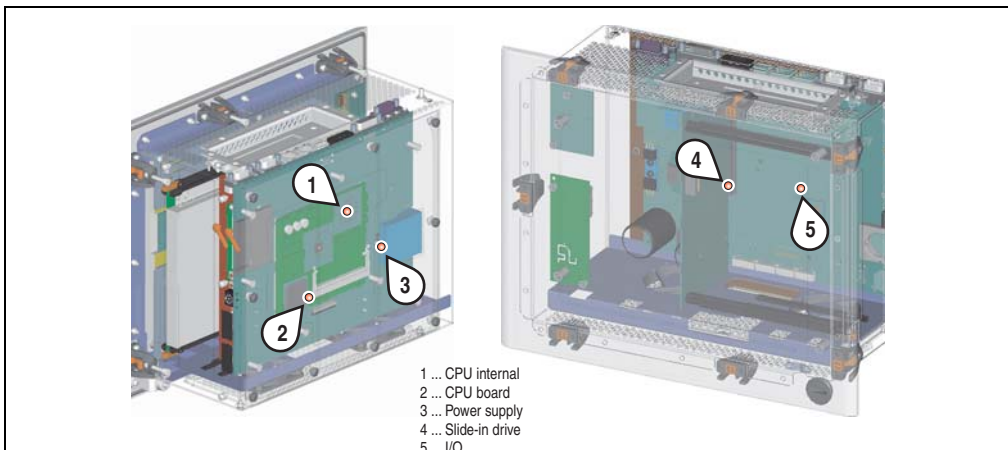

Figure 275: Temperature sensor locations

Position	Measurement point for	Monitoring	Max. specified
1	CPU internal	Processor temperature (sensor integrated on the processor).	90°C
2	CPU board	CPU board temperature (sensor integrated in the CPU board).	95°C
3	Power supply	Power supply temperature (sensor on the power supply).	95°C
4	Slide-in drive 1/2	Temperature of a slide-in drive (the sensor is integrated on the slide-in drive).	Drive dependent
5	I/O	Temperature under an add-on drive (sensor on the baseboard).	Max. 85°C Drive dependent

Table 257: Temperature sensor locations

1) The measured temperature is a guideline for the immediate ambient temperature, but can be influenced by neighboring components.

2) The B&R Control Center - ADI driver - can be downloaded for free from the download area on the B&R homepage (www.br-automation.com).

2. Maintenance Controller Extended (MTCX)

The MTCX controller (FPGA processor) is located on the main board (part of every system unit) of Automation PC 620 and Panel PC 700 devices.

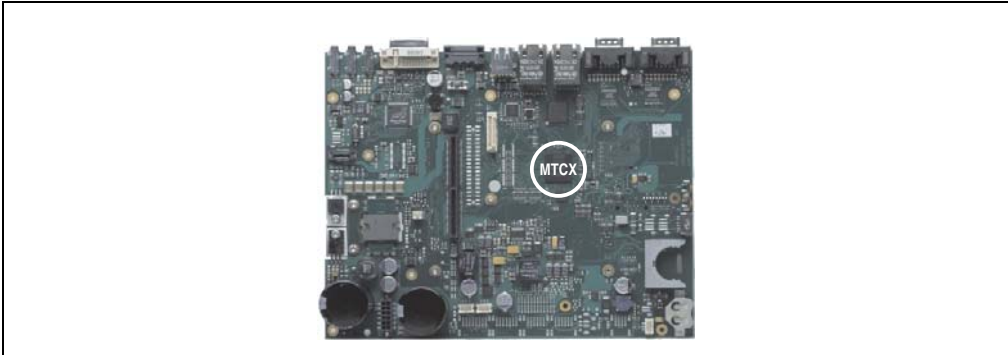

Figure 276: MTCX controller location

The MTCX is responsible for the following monitoring and control functions:

- Power on (power OK sequencing) and power fail logic
- Watchdog handling (NMI and reset handling)
- Temperature monitoring (I/O area, power supply, slide-in drive 1/2)
- Fan control (3 housing fans)
- Key handling / coordination (matrix keyboard on Automation Panel 900 devices configurable using B&R Key Editor, PS/2 keyboard)
- LED handling (matrix keyboard with LEDs on Automation Panel 900 devices configurable using B&R Key Editor)
- Advanced desktop operation (keys, USB forwarding)
- Daisy chain display operation (touch screen, USB forwarding)
- Panel locking mechanism (configurable using B&R Control Center - ADI driver)
- Backlight control for a connected B&R display
- Statistical data recording (power cycles - each power on, power on and fan hours are recorded - every full hour is counted e.g. 50 minutes no increase)
- SDL data transfer (display, matrix keyboard, touch screen, service data, USB)
- Status LEDs (HDD, panel lock, Link 1)

The functions of the MTCX can be expanded via Firmware upgrade¹⁾. The version can be read in BIOS (menu item "advanced" - baseboard/panel features) or in Microsoft Windows XP/embedded, using B&R Control Center.

1) Can be downloaded from the download area on the B&R homepage (www.br-automation.com).

2.1 Temperature monitoring - Fan control

The MTCX constantly monitors the temperature using temperature sensors (see section 1 "Temperature sensor locations", on page 471), which directly determine how the fan is controlled. The RPM depends on the temperature measured. The limit values depend on the MTCX firmware version being used.

Sensor range	Start-up temperature	Max fan speed at:
CPU	+39°C	+55°C
Power supply	+39°C	+55°C
Slide-in drive 1/2	+39°C	+55°C
I/O	+39°C	+55°C

Table 258: Temperature limits for fan control

The fans stop again when the temperature drops below +37°C.

3. B&R Key Editor

On display units, it is often necessary to adjust the function keys and LEDs for the application software being used. The B&R Key Editor makes it quick and easy to adapt the application to a unique configuration.

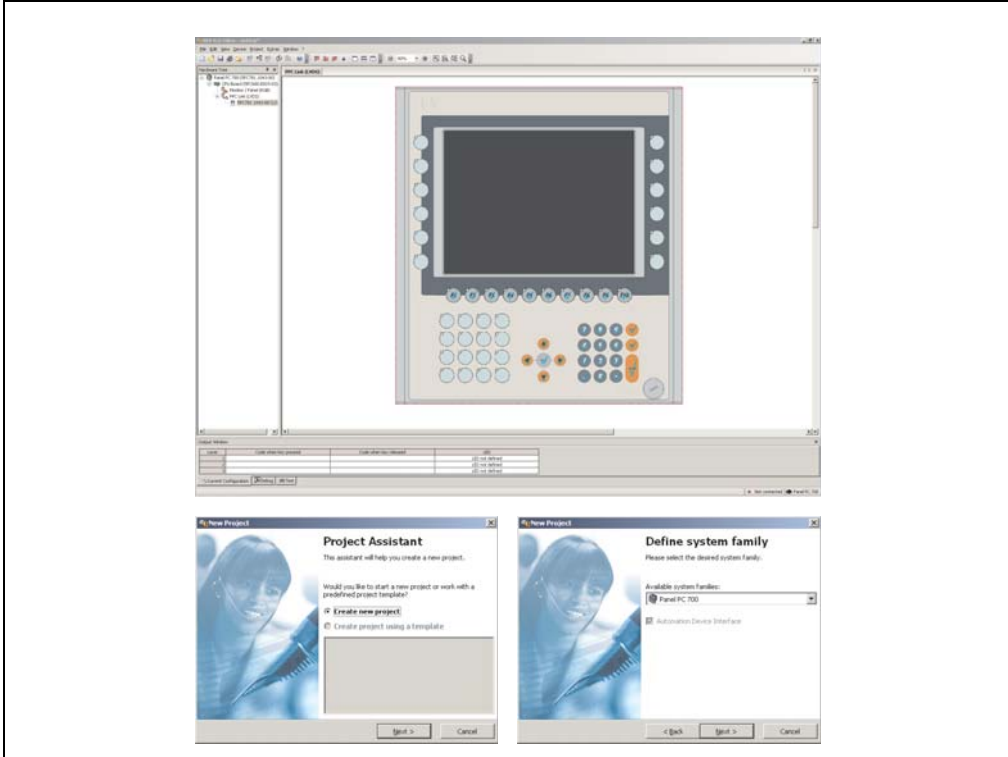

Figure 277: B&R Key Editor screenshots Version 3.10 (representation picture)

Features:

- Configuration of normal keys like on a keyboard (A, B, C, etc.)
- Keyboard shortcuts (CTRL+C, SHIFT+DEL, etc.) on one key
- Special key functions (change brightness, etc.)
- Assign functions to LEDs (HDD access, power, etc.)
- 4 assignments per key possible (using layer function)
- Configuration of panel locking time when multiple Automation Panel 900 devices are connected to Automation PCs and Panel PCs devices.

Supports following systems (Version 3.10):

- Automation PC 620
- Automation PC 810
- Automation PC 820
- Automation Panel 800
- Automation Panel 900
- IPC2000, IPC2001, IPC2002
- IPC5000, IPC5600
- IPC5000C, IPC5600C
- Mobile Panel 40/50
- Mobile Panel 100/200
- Panel PC 300
- Panel PC 700
- Panel PC 800
- Power Panel 100/200
- Power Panel 300/400
- Power Panel 500 (the Key Editor device file must be downloaded separately from the B&R homepage)

A detailed guide for configuring keys and LEDs can be found in the B&R Key Editor's online help.

The B&R Key Editor can be downloaded for free from the download area on the B&R homepage (www.br-automation.com). Additionally, it can also be found on the B&R HMI Drivers & Utilities DVD (model number 5SWHMI.0000-00).

4. B&R Automation Device Interface (ADI) development kit

This software can be used to activate functions of the B&R Automation Device Interface (ADI) from Windows applications, which, for example, were created using the following development tools:

- Microsoft Visual C++ 6.0
- Microsoft Visual Basic 6.0
- Microsoft eMbedded Visual C++ 4.0
- Microsoft Visual Studio 2005 (or newer)

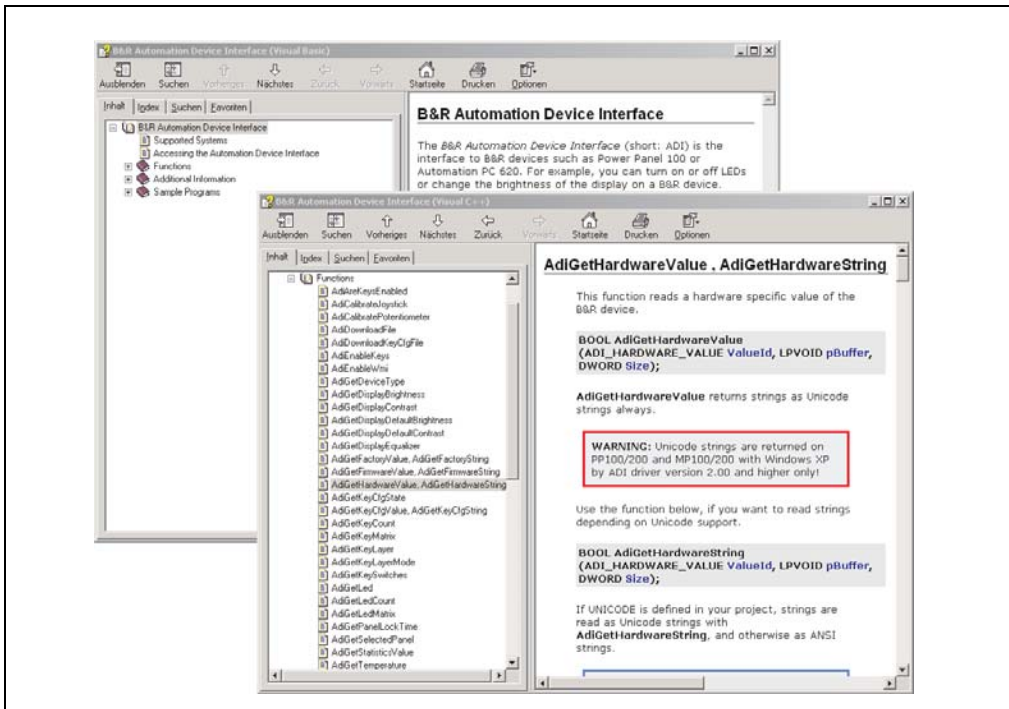

Figure 278: ADI development kit screenshots (Version 3.10)

Features:

- One Microsoft Visual Basic module with declarations for the ADI functions.
- Header files and import libraries for Microsoft Visual C++.
- Help files for Visual Basic and Visual C++.
- Sample projects for Visual Basic and Visual C++.
- ADI DLL (for testing the applications, if no ADI driver is installed).

Supports following systems (Version 3.10 and higher):

- Automation PC 620
- Automation PC 810
- Automation PC 820
- Mobile Panel 40/50
- Mobile Panel 100/200
- Panel PC 300
- Panel PC 700
- Panel PC 800
- Power Panel 100/200
- Power Panel 300/400
- Power Panel 500

The ADI driver suitable for the device must be installed on the stated product series. The ADI driver is already included in the B&R images of embedded operating systems.

A detailed description of using the ADI functions can be found in the integrated online help.

The B&R Automation Device Interface (ADI) development kit can be downloaded for free from the download area on the B&R homepage (www.br-automation.com).

5. B&R Automation Device Interface (ADI) .NET SDK

This software can be used to activate functions of the B&R Automation Device Interface (ADI) from .NET applications, which were created using Microsoft Visual Studio 2005 (or newer).

Supported programming languages:

- Visual Basic
- Visual C++
- Visual C#
- Visual J#

System requirements:

- Development system: PC with Windows XP/7 with
 - Microsoft Visual Studio 2005 or newer
 - Microsoft .NET Framework 2.0 and / or Microsoft .NET Compact Framework 2.0 or newer

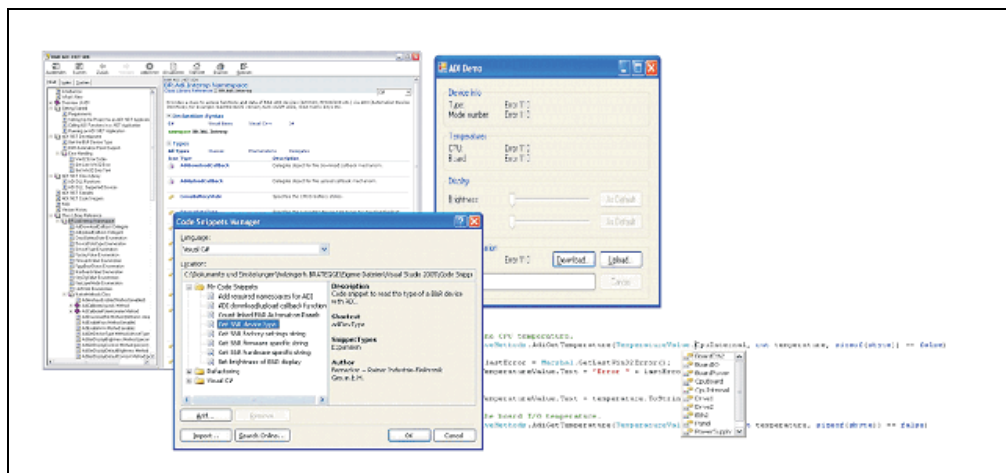

Figure 279: ADI .NET SDK Screenshots (Version 1.50)

Features:

- ADI .NET Class Library.
- Help files in HTML Help 1.0 format (.chm file) and MS Help 2.0 format (.HxS file).
- Sample projects and code snippets for Visual Basic, Visual C++, Visual C# and Visual J#.
- ADI DLL (for testing the applications, if no ADI driver is installed).

Supports following systems (Version 1.50 and higher):

- Automation PC 620
- Automation PC 810
- Automation PC 820
- Mobile Panel 40/50
- Mobile Panel 100/200
- Panel PC 300
- Panel PC 700
- Panel PC 800
- Power Panel 100/200
- Power Panel 300/400
- Power Panel 500

The ADI driver suitable for the device must be installed on the stated product series. The ADI driver is already included in the B&R images of embedded operating systems.

A detailed description of using the ADI functions can be found in the integrated online help.

The ADI .NET SDK can be downloaded for free from the download area on the B&R homepage (www.br-automation.com).

6. Touch Screen - Elo Accu Touch

Information:

The following characteristics, features, and limit values only apply to this individual component and can deviate from those specified for the entire device. For the entire device in which this individual component is used, refer to the data given specifically for the entire device.

Elo Accu touch screen	Specifications
Manufacturer	Elo
Accuracy For < 18" diagonals For > 18" diagonals	Typically < than 0.080 inches (2.032 mm) Maximum error in all directions 0.180 inches (4.752 mm) Maximum 1% of the diagonal for the active area of the touch screens
Response time	< 10 ms
Release pressure	< 113 grams
Resolution	4096 x 4096 touch points
Light permeability	Up to 80% ± 5%
Temperature Operation Storage Transport	- 10°C to + 50°C - 40°C to + 71°C - 40°C to + 71°C
Relative humidity Operation Storage Transport	Max. 90% at max. 35°C Max. 90% at max. 35°C for 240 hours, non-condensing Max. 90% at max. 35°C for 240 hours, non-condensing
Waterproofing	IP65
Service life	35 million touch operations on the same point
Chemical resistance ¹⁾	Acetone, ammonia-based glass cleaner, normal food and drinks, hexane, methylene chloride, methyl ethyl ketone, mineral spirits, turpentine, isopropyl alcohol
Activation	Finger, pointer, credit card, glove
Drivers	Touch screen drivers can be downloaded from the download area on the B&R homepage (www.br-automation.com). Additionally, they can also be found on the B&R HMI Drivers and Utilities DVD (Mod. No. 5SWHMI.0000-00).

Table 259: Technical data - Elo Accu Touch

1) The active area of the touch screen is resistant to these chemicals for a timeframe of one hour at 21°C.

6.1 Temperature humidity diagram

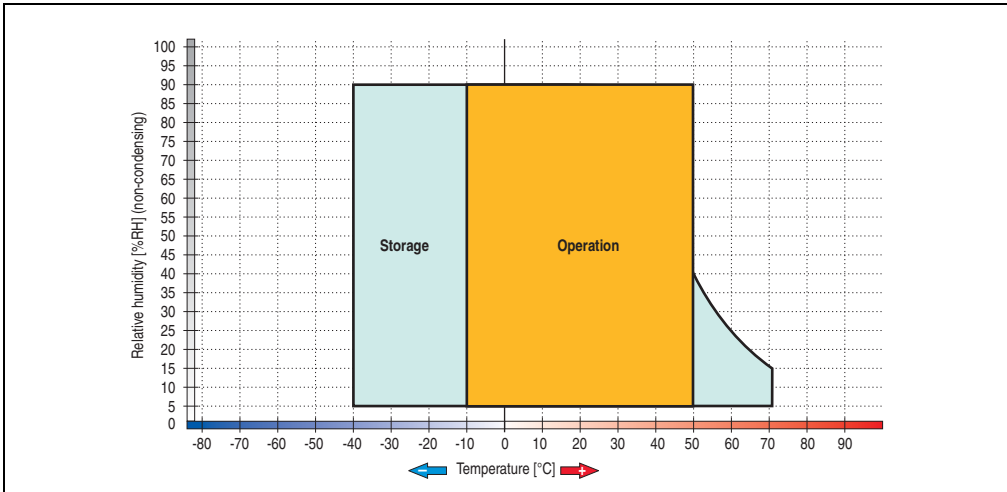

Figure 280: Temperature humidity diagram - Elo Accu touch screen 5-wire

Temperature data is for operation at 500 meters. Derating the max. ambient temperature - typically 1°C per 1000 meters (from 500 meters above sea level).

6.2 Cleaning

The touch screen should be cleaned with a moist lint-free cloth. When moistening the cloth, use only water with detergent, screen cleaning agent, or alcohol (ethanol). The cleaning agent should be applied to the cloth beforehand and not sprayed directly onto the touch screen itself. Never use aggressive solvents, chemicals, or scouring agents.

7. Touch Screen - AMT

Information:

The following characteristics, features, and limit values only apply to this individual component and can deviate from those specified for the entire device. For the entire device in which this individual component is used, refer to the data given specifically for the entire device.

Elo Accu touch screen	Specifications
Manufacturer	AMT
Release pressure	< 1 N
Light permeability	Up to 81% \pm 3%
Temperature Operation Bearings Transport	-20 to 70°C -40 to 80°C -40 to 80°C
Relative humidity Operation Bearings Transport	Max. 90% at max. 50°C Max. 90% at max. 60°C for 504 hours, non-condensing Max. 90% at max. 60°C for 504 hours, non-condensing
Lifespan	36 million touch operations at the same position (release pressure: 250 g, interval: 2x per second)
Activation	Finger, pointer, credit card, glove
Drivers	Touch screen drivers can be downloaded from the download area on the B&R homepage (www.br-automation.com).

Table 260: Technical data - AMT Touch

7.1 Temperature humidity diagram

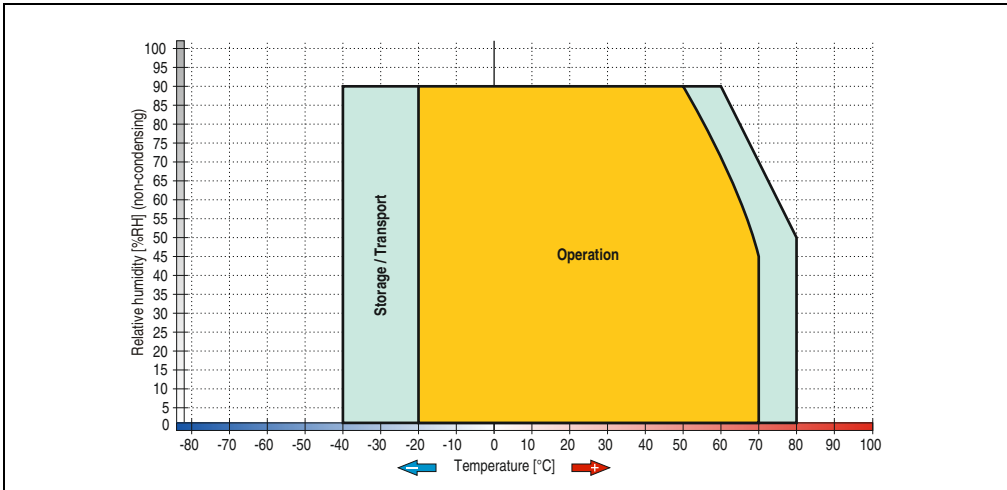

Figure 281: Temperature humidity diagram - AMT touch screen

Temperature data is for operation at 500 meters. Derating the max. ambient temperature - typically 1°C per 1000 meters (from 500 meters above sea level).

7.2 Cleaning

The touch screen should be cleaned with a moist lint-free cloth. When moistening the cloth, use only water with detergent, screen cleaning agent, or alcohol (ethanol). The cleaning agent should be applied to the cloth beforehand and not sprayed directly onto the touch screen itself. Never use aggressive solvents, chemicals, or scouring agents.

8. Membrane

The décor foil conforms to DIN 42115 (section 2). This means it is resistant to exposure to the following chemicals for a 24-hour period with no visible signs of damage:

Information:

The following characteristics, features, and limit values only apply to this individual component and can deviate from those specified for the entire device.

Ethanol Cyclohexanol Diacetone alcohol Glycol Isopropanol Glycerine Methanol Triacetin Dowandol DRM/PM	Formaldehyde 37 - 42% Acetaldehyde Aliphatic hydrocarbons Toluene Xylene White spirits	Trichloroethane Ethyl acetate Diethyl ether N-Butyl acetate Amyl acetate Butylcellosolve Ether
Acetone Methyl ethyl ketone Dioxan Cyclohexanone MIBK Isophorone	Formic acid <50% Acetic acid <50% Phosphoric acid <30% Hydrochloric acid <36% Nitric acid <10% Trichloroacetic acid <50% Sulphuric acid <10%	Sodium hypochlorite <20% Hydrogen peroxide <25% Potassium carbonate Washing agents Tenside Fabric conditioner Ferrous chloride (FeCl ₂) Ferrous chloride (FeCl ₃) Dibutyl phthalate Diocetyl phthalate Sodium carbonate
Ammonia <40% Caustic soda <40% Potassium hydroxide Alkali carbonate Bichromate Potassium Acetonitrile Sodium bisulphate	Cutting oil Diesel oil Linseed oil Paraffin oil Blown castor oil Silicon oil Turpentine oil substitute Universal brake fluid Aviation fuel Gasoline Water Sea water Decon	

Table 261: Chemical resistance of the décor foil

The décor foil conforms to DIN 42115 section 2 for exposure to glacial acetic acid for less than one hour without visible damage.

9. Viewing angles

The viewing angle information of the display types (R, L, U, D) can be seen in the technical data for the individual components.

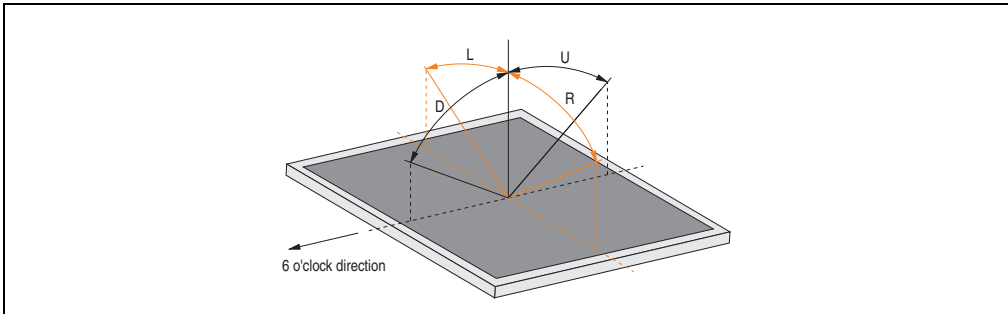

Figure 282: Viewing angle definition

10. Glossary

A

ACPI

Abbreviation for "**A**dvanced **C**onfiguration and **P**ower Interface". Configuration interface that enables the operating system to control the power supply for each device connected to the PC. With ACPI, the computer's BIOS is only responsible for the details of communication with the hardware.

ADI

Abbreviation for »Automation Device Interface« The ADI interface allows access to specific functions (e.g. brightness control, firmware updates, static value read) of B&R devices. The settings can be read or changed in the Control Panel with the B&R Control Center Applet (already included in the B&R embedded operating system).

APC

An abbreviation for "**A**utomation **P**C".

API

Abbreviation for "**A**pplication **P**rogram Interface" The interface, which allows applications to communicate with other applications or with the operating system.

Automation Runtime

A uniform runtime system for all B&R automation components.

B

Baud rate

Measurement unit for data transfer speed. It indicates the number of states for a transferred signal per second and is measured using the baud unit of measurement. 1 baud = 1 bit/sec or 1 bps.

BIOS

An abbreviation for "**B**asic **I**nput/**O**utput **S**ystem". Core software for computer systems with essential routines for controlling input and output processes on hardware components, for performing tests after system start and for loading the operating system. Although BIOS is used to configure a system's performance, the user does not usually come into contact with it.

Bit

Binary digit > binary position, binary character, smallest discrete unit of information. A bit can have the value 0 or 1.

Bit rate

The number of bits that can be transferred within a specified time unit. 1 bit/sec = 1 baud.

Bootstrap loader

A program that automatically runs when the computer is switched on or restarted. After some basic hardware tests have been carried out, the bootstrap loader starts a larger loader and hands over control to it, which in turn boots the operating system. The bootstrap loader is typically found in ROM on the computer.

Byte

Data format [1 byte = 8 bits] and a unit for characterizing information amounts and memory capacity. The following units are the commonly used units of progression: KB, MB, GB.

B&R Automation Runtime

Windows-based program for creating installation disks to install B&R Automation Runtime™ on the target system.

C**Cache**

Background memory, also known as non-addressable memory or fast buffer memory. It is used to relieve the fast main memory of a computer. For example, data that should be output to slower components by the working memory (e.g. disk storage, printers) is stored temporarily in cache memory and output from there at an appropriate speed for the target devices.

CAN

An abbreviation for "**C**ontroller **A**rea **N**etwork" (serial bus system). Structure according to ISO 11898; Bus medium: twisted pair. Good transfer properties in short distances less than 40 m with a 1 Mbit/sec data transfer rate. Maximum number of stations: Theoretically unlimited, but practically limited up to 64. Real-time capable (i.e. defined maximum latency times for messages with high priority). High reliability using error detection, error handling, troubleshooting. Hamming distance.

CD-ROM

Abbreviation for "**C**ompact **D**isc **R**ead-**O**nly **M**emory". A removable data medium with a capacity of ~700 MB. CD-ROMs are optically scanned.

CE mark

A CE mark for a product. It consists of the letters "CE" and indicates conformity to all EU guidelines for the labeled product. It indicates that the individual or corporate body who has performed or attached the label assures that the product conforms to all EU guidelines for complete harmonization. It also indicates that all mandatory conformity evaluation procedures have taken place.

CMOS

"CMOS" is a battery powered memory area where fundamental parameters of an IBM (or compatible) personal computer are stored. Information such as the type of hard drive, size of the working memory and the current date and time are required when booting the computer. As the name suggests, the memory is based on CMOS technology standards.

COM

A device name used to access serial ports in MS-DOS. The first serial port can be accessed under COM1, the second under COM2, etc. A modem, mouse, or serial printer is typically connected to a serial port.

COM1

Device name for the first serial port in a PC system. The input/output area for COM1 is usually found at address 03F8H. Generally, the COM1 port is assigned to IRQ 4. In many systems, an RS232 serial mouse is connected to COM1.

COM2

Device name for the second serial port in a PC system. The input/output area for COM2 is usually found at address 02F8H. Generally, the COM2 port is assigned to IRQ 3. In many systems, a modem is connected to COM2.

COM3

Device name for a serial port in a PC system. The input/output area for COM3 is usually found at address 03E8H. Generally, the COM3 port is assigned to IRQ 4. In many systems, COM3 is used as an alternative for COM1 or COM2 if peripheral devices are already connected to COM1 and COM2.

CompactFlash®

CompactFlash memory cards [CF cards] are exchangeable nonvolatile mass memory systems with very small dimensions [43 x 36 x 3.3 mm, approximately half the size of a credit card]. In addition to the flash memory chips, the controller is also present on the cards. CF cards provide complete PC card / ATA functionality and compatibility. A 50-pin CF card can be simply inserted in a passive 68-pin type II adapter card. It conforms to all electrical and mechanical PC card interface specifications. CF cards were launched by SanDisk back in 1994. Currently, memory capacities reach up to 64 GB per unit. Since 1995, CompactFlash Association [CFA] has been looking after standardization and the worldwide distribution of CF technology

CPU

An abbreviation for "**C**entral **P**rocessing **U**nit". Interprets and executes commands. It is also known as a "microprocessor" or "processor" for short. A processor is able to receive, decode and execute commands, as well as transfer information to and from other resources via the computer bus.

CTS

An abbreviation for "**C**lear **T**o **S**end". A signal used when transferring serial data from modem to computer, indicating its readiness to send the data. CTS is a hardware signal which is transferred via line number 5 in compliance with the RS-232-C standard.

D

DCD

An abbreviation for "**D**ata **C**arrier **D**etected". A signal used in serial communication that is sent by the modem to the computer it is connected to, indicating that it is ready for transfer.

Dial-up

Data is transferred over the telephone network using a modem or an ISDN adapter.

DIMM

"Double In-line Memory Module" consisting of one or more RAM chips on a small circuit board that is connected with the motherboard of a computer.

DMA

Direct **M**emory **A**ccess > Accelerated direct access to a computer's RAM by bypassing the CPU.

DRAM

An abbreviation for "**D**ynamic **R**andom **A**ccess **M**emory". Dynamic RAM consists of an integrated semiconductor circuit that stores information based on the capacitor principle. Capacitors lose their charge in a relatively short time. Therefore, dynamic RAM circuit boards must contain a logic that allows continual recharging of RAM chips. Since the processor cannot access dynamic RAM while it is being recharged, one or more waiting states can occur when reading or writing data. Although it is slower, dynamic RAM is used more often than static RAM since the simple design of the circuits means that it can store four times more data than static RAM.

DSR

An abbreviation for "**Data Set Ready**". A signal used in serial data transfer, which is sent by the modem to the computer it is connected to, indicating its readiness for processing. DSR is a hardware signal which is sent via line number 6 in compliance with the RS-232-C standard.

DTR

An abbreviation for "**Data Terminal Ready**". A signal used in serial data transfer that is sent by the computer to the modem it is connected to, indicating the computer's readiness to accept incoming signals.

DVD

An abbreviation for "**Digital Versatile Disc**". The next generation of optical data carrier technology is able to store a higher volume of data than conventional CDs. Standard DVDs, which have a single layer, can hold 4.7 GB. Dual-layer DVDs can hold 8.5 GB. Double-sided DVDs can therefore hold up to 17 GB. A special drive is needed for DVDs. Conventional CDs can also be played on DVD drives.

DVI

Abbreviation for "**Digital Visual Interface**" An interface for the digital transfer of video data.

DVI-A

Analog only

DVI-D

Digital only

DVI-I

Integrated, i.e. analog and digital

E

EDID data

Abbreviation for "**Extended Display Identification Data**". EDID data contains the characteristics of monitors / TFT displays transferred as 128 KB data blocks to the graphics card via the Display Data Channel (DDC). This EDID data can be used to set the graphics card to the monitor properties.

EIDE

An abbreviation for "**Enhanced Integrated Drive Electronics**". An expansion of the IDE standard. Enhanced IDE is considered the standard for hardware interfaces. This interface is designed for drives with an integrated drive controller.

EMC

"**Electromagnetic Compatibility**" The ability of a device or a system to function satisfactorily in its electromagnetic environment without introducing intolerable electromagnetic disturbances to anything in that environment [IEV 161-01-07].

EPROM

Erasable PROM > (completely with ultraviolet light).

Ethernet

An IEEE 802.3 standard for networks. Ethernet uses bus or star topology and controls the traffic on communication lines using the access procedure CSMA/CD (Carrier Sense Multiple Access with Collision Detection). Network nodes are connected using coaxial cables, fiber optic cables or twisted pair cabling. Data transfer on an Ethernet network takes place in frames of variable lengths that consist of supply and controller information as well as 1500 bytes of data. The Ethernet standard provides base band transfers at 10 megabit and 100 megabit per second.

Ethernet POWERLINK

An enhancement of standard Ethernet. It enables data exchange under strict real-time conditions with cycle times down to 200 μ s and jitter under 1 μ s. This makes Ethernet power available on all communication levels of automation technology – from control levels to I/O. Ethernet POWERLINK was initiated by the company B&R Industrie-Elektronik and is now managed by the open end user and vendor association, EPSG - Ethernet POWERLINK Standardization Group (www.ethernet-powerlink.org).

F

FDD

Abbreviation for "**Floppy Disk Drive**". Reading device for removable magnetic memory from the early days of PC technology. Due to their sensitivity and moving components, FDDs have been almost completely replaced by CompactFlash memory in modern automation solutions.

Fiber optics

Fiber optic cable

FIFO

An abbreviation for "**First In First Out**". A queuing organization method whereby elements are removed in the same order as they were inserted. The first element inserted is the first one removed. Such an organization method is typical for a list of documents that are waiting to be printed.

Firmware

Programs stored permanently in read-only memory. Firmware is software used to operate computer-controlled devices that generally stays in the device throughout its lifespan or over a long period of time. Such software includes operating systems for CPUs and application

Appendix A • Glossary

programs for industrial PCs as well as programmable logic controllers (e.g. the software in a washing machine controller). This software is written in read-only memory (ROM, PROM, EPROM) and cannot be easily replaced.

Floppy

Also known as a diskette. A round plastic disk with an iron oxide coating that can store a magnetic field. When the floppy disk is inserted in a disk drive, it rotates so that the different areas (or sectors) of the disk's surface are moved under the read/write head. This allows the magnetic orientation of the disk's surface to be modified and recorded. Orientation in one direction represents binary 1, while the reverse orientation represents binary 0.

FPC

An abbreviation for "**Flat Panel Controller**".

FPD

An abbreviation for "**Flat Panel Display**".

FTP

"**File Transfer Protocol**" Rules for transferring data over a network from one computer to another computer. This protocol is based on TCP/IP, which has established itself as the standard for transferring data over Ethernet networks. FTP is one of the most used protocols on the Internet. It is defined in RFC 959 in the official regulations for Internet communication.

G

GB

Gigabyte (1 GB = 230 or 1,073,741,824 Bytes)

H

Handshake

Method of synchronization for data transfer when data is sent at irregular intervals. The sender signals that data can be sent, and the receiver signals when new data can be received.

HDD

An abbreviation for "**Hard Disk Drive**". Fixed magnetic mass memory with high capacities, e.g. 120 GB.

I

IDE

An abbreviation for "**Integrated Drive Electronics**". A drive interface where the controller electronics are integrated in the drive.

Interface

From the hardware point of view, an interface is the connection point between two modules/devices/systems. The units on both sides of the interface are connected by the interface lines so that data, addresses, and control signals can be exchanged. The term interface includes all functional, electrical and constructive conditions [encoding, signal level, pin assignments] that characterize the connection point between the modules, devices, or systems. Depending on the type of data transfer, a differentiation is made between parallel [e.g. Centronics, IEEE 488] and serial interfaces [e.g. V.24, TTY, RS232, RS422, RS485], which are set up for different transfer speeds and transfer distances. From the point of view of software, the term "interface" describes the transfer point between program modules using specified rules for transferring the program data.

ISA

An abbreviation for "Industry **S**tandard **A**rchitecture". A term given for the bus design which allows expansion of the system with plug-in cards that can be inserted in PC expansion slots.

ISO

International Organization for Standardization > Worldwide federation of national standardization institutions from over 130 countries. ISO is not an acronym for the name of the organization; it is derived from the Greek word "isos", meaning "equal" (www.iso.ch).

J

Jitter

Jitter is a term that describes time deviations of cyclic events. If, for example, an event should take place every 200is and it actually occurs every 198 to 203is, then the jitter is 5is. Jitter has many causes. It originates in the components and transfer media of networks because of noise, crosstalk, electromagnetic interference and many other random occurrences. In automation technology, jitter is a measure of the quality of synchronization and timing.

Jumper

A small plug or wire link for adapting the hardware configuration used to connect the different points of an electronic circuit.

L

LCD

An abbreviation for "**L**iquid **C**rystal **D**isplay". A display type, based on liquid crystals that have a polarized molecular structure and are enclosed between two transparent electrodes as a thin layer. If an electrical field is applied to the electrodes, the molecules align themselves with the field and form crystalline arrangements that polarize the light passing through. A polarization filter, which is arranged using lamellar electrodes, blocks the polarized light. In this way, a cell

(pixel) containing liquid crystals can be switched on using electrode gates, thus coloring this pixel black. Some LCD displays have an electroluminescent plate behind the LCD screen for lighting. Other types of LCD displays can use color.

LED

An abbreviation for "**L**ight **E**mitting **D**iode". A semiconductor diode which converts electrical energy into light. LEDs work on the principle of electroluminescence. They are highly efficient because they do not produce much heat in spite of the amount of light they emit. For example, "operational status indicators" on floppy disk drives are LEDs.

LPT

Logical device name for line printers. In MS-DOS, names are reserved for up to three parallel printer ports with the names LPT1, LPT2 and LPT3. The first parallel port (LPT1) is usually identical to the primary parallel output device PRN (in MS-DOS the logical device name for the printer). The abbreviation LPT stands for "Line Printer Terminal".

M

MB

Megabyte (1 MB = 220 or 1,048,576 bytes).

Microprocessor

Highly integrated circuit with the functionality of a CPU, normally housed on a single chip. It comprises a control unit, arithmetic and logic unit, several registers and a link system for connecting memory and peripheral components. The main performance features are the internal and external data bus and address bus widths, the command set and the clock frequency. Additionally, a choice can be made between CISC and RISC processors. The first commercially available worldwide microprocessor was the Intel 4004. It came on the market in 1971.

MIPS

Million instructions per second > Measurement for the computing speed of computers.

Motherboard

A circuit board that houses the main components of a computer such as the CPU switching circuit, co-processors, RAM, ROM for firmware, interface circuits, and expansion slots for hardware expansions.

MTBF

An abbreviation for "**M**ean **t**ime **b**etween **f**ailure". The average time which passes before a hardware component fails and repair is needed. This time is usually expressed in thousands or ten thousands of hours, sometimes known as power-on hours (POH).

MTC

An abbreviation for "**Maintenance Controller**". The MTC is an independent processor system that provides additional functions for a B&R industrial PC that are not available with a normal PC. The MTC communicates with the B&R industrial PC via the ISA bus (using a couple register).

MTCX

An abbreviation for »**Maintenance Controller EXTended**«. The MTCX is an independent processor system that provides additional functions for a B&R industrial PC that are not available with a normal PC. The MTC communicates with the B&R industrial PC via the ISA bus (using a couple register).

Multitasking

Multitasking is an operating mode in an operating system that allows several computer tasks to be executed virtually simultaneously.

O

OEM

Abbreviation for "**Original Equipment Manufacturer**"; A company that integrates third-party and in-house manufactured components into their own product range and then distributes these products under its own name.

OPC

OLE for Process Control > A communication standard for components in the area of automation. The goal of OPC development is to provide an open interface that builds on Windows-based technologies such as OLE, COM and DCOM. It allows problem-free standardized data transfer between controllers, operating and monitoring systems, field devices and office applications from different manufacturers. This development is promoted by the OPC Foundation, which is made up of over 200 companies from around the world, including Microsoft and other leading companies. Nowadays, OPC is also interpreted as a synonym for Openness, Productivity and Connectivity, symbolizing the new possibilities that this standard opens up.

OPC server

The missing link between connection modules for the Interbus and the visualization application. It communicates serially with the connection modules via the ISA or PCI bus or Ethernet.

P

Panel

A common term for B&R display units (with or without keys).

PCI Bus

Abbreviation for "**P**eripheral **C**omponent **I**nterconnect **b**us". Developed by Intel as an intermediary/local bus for the latest PC generations. It is basically a synchronous bus. The main clock of the CPU is used for synchronization. The PCI bus is microprocessor-independent, 32-bit and 64-bit compatible, and supports both 3.3 V and 5 V cards and devices.

PCMCIA

An abbreviation for "**P**ersonal **C**omputer **M**emory **C**ard **I**nternational **A**ssociation". An association of manufacturers and dealers who are dedicated to the cultivation and further development of common standards for peripheral devices based on PC cards with a slot for such cards. PC cards are mainly used for laptops, palmtops (and other portable computers), and intelligent electronic devices. Version 1 of the PCMCIA standard was introduced in 1990.

PLC

Programmable Logic Controller; Computer-based control device that functions using an application program. The application program is relatively easy to create using standardized programming languages [IL, FBD, LAD, AS, ST]. Because of its serial functionality, reaction times are slower compared to connection-oriented control. Today, PLCs are available in device families with matched modular components for all levels of an automation hierarchy.

PnP

An abbreviation for "**P**lug and **P**lay". Specifications developed by Intel. Using Plug and Play allows a PC to automatically configure itself so that it can communicate with peripheral devices (e.g. monitors, modems, and printers). Users can connect a peripheral device (plug) and it immediately runs (play) without having to manually configure the system. A Plug and Play PC requires a BIOS that supports Plug and Play and a respective expansion card.

POH

An abbreviation for "**P**ower **O**n **H**ours". See MTBF.

POST

An abbreviation for "**P**ower-**O**n **S**elf **T**est". A set of routines that are stored in ROM on the computer and that test different system components, e.g. RAM, disk drive and the keyboard in order to determine that the connection is operating correctly and ready for operation. POST routines notify the user of problems that occur. This is done using several signal tones or by displaying a message that frequently accompanies a diagnosis value on the standard output or standard error devices (generally the monitor). If the POST runs successfully, control is transferred over to the system's bootstrap loader.

POWERLINK

See "Ethernet POWERLINK".

PROFIBUS-DP

PROFIBUS for "decentralized peripherals". PROFIBUS DP can be used to allow simple digital and analog I/O modules as well as intelligent signal and data processing units to be installed in the machine room, which among other things can significantly reduce cabling costs. Often used for time-critical factory automation applications.

Q

QVGA

Abbreviation for "**Q**uarter **V**ideo **G**raphics **A**rray". Usually a screen resolution of 320 × 240 pixels.

QUXGA

Abbreviation for "**Q**uad **U**ltra **E**xtended **G**raphics **A**rray". Generally a screen resolution of 3200 × 2400 pixels (4:3). Quad implies the 4x greater pixel resolution compared to the UXGA.

QWUXGA

Abbreviation for "**Q**uad **W**UXGA"; Generally a screen resolution of 3840 × 2400 pixels (8:5, 16:10).

R

RAM

An abbreviation for "**R**andom **A**ccess **M**emory". Semiconductor memory which can be read or written to by the microprocessor or other hardware components. Memory locations can be accessed in any order. The various ROM memory types do allow random access, but they cannot be written to. The term RAM refers to a more temporary memory that can be written to as well as read.

Real time

A system is operating in real time or has real-time capability if the input sizes (e.g. signals, data) are received and processed in a defined time period, and the results are made available in real time for a partner system or the system environment. See also "real-time demands" and "real-time system".

ROM

An abbreviation for "**R**ead-**O**nly **M**emory". Semiconductor memory where programs or data were permanently stored during the production process.

RS232

Recommended Standard Number 232. Oldest and most widespread interface standard, also called a V.24 interface. All signals are referenced to ground making this an unbalanced interface. High level: -3 to -30 V, low level: +3 to +30 V; cable lengths up to 15 m, transfer rates up to 20 kbit/s; for point-to-point connections between 2 stations.

RS422

Recommended Standard Number 422. Interface standard, balanced operation, increased immunity to disturbances. High level: 2 to -6 V, low level: +2 to +6 V; four-line connection [inverted/non-inverted], permissible cable length up to 1200 m, transfer rates up to 10 MBit/s, 1 sender can transfer simplex with up to 10 receivers.

RS485

Recommended Standard Number 485. Interface standard upgraded from RS422. High level: 1.5 to -6 V, low level: +1.5 to +6 V; two-line connection [half-duplex mode] or four-line connection [full-duplex mode]; permissible cable length up to 1200 m, transfer rates up to 10 Mbit/s. Up to 32 stations (sender/receiver) can be connected to an RS485 bus.

RTS

An abbreviation for "**Request To Send**". A signal used in serial data transfer for requesting send permission. For example, it is sent from a computer to the modem connected to it. The RTS signal is assigned to pin 4 according to the hardware specifications of the RS-232-C standard.

RXD

An abbreviation for "**Receive (RX) Data**". A line for transferring serial data received from one device to another, e.g. from a modem to a computer. For connections complying with the RS-232-C standard, the RXD is connected to pin 3 of the plug.

S

SDRAM

An abbreviation for "**Synchronous Dynamic Random Access Memory**". A construction of dynamic semiconductor components (DRAM) that can operate with higher clock rates than conventional DRAM switching circuits. This is made possible using block access. For each access, the DRAM determines the next memory addresses to be accessed.

SFC

Sequential function chart > Graphic input language for PLCs used to represent sequential control.

Slot PLC

PC insert card that has full PLC functionality. On the PC, it is coupled via a DPR with the process using a fieldbus connection. It is programmed externally or using the host PC.

SoftPLC

Synonym for SoftPLC.

SUXGA

Abbreviation for **Super Ultra Extended Graphics Array**; Generally a screen resolution of 2048 × 1536 pixels (4:3). An alternative name is QXGA (**Quad Extended Graphics Array**), which is 4x the pixel resolution of XGA.

SVGA

Abbreviation for "**Super Video Graphics Array**"; Graphics standard with a resolution of at least 800×600 pixels and at least 256 colors.

Switch

Device, similar to a hub, that takes data packets received in a network and, unlike a hub, does not pass them on to all network nodes, instead only to the respective addressee. Unlike a hub, a switch provides targeted communication within a network that only takes place between sender and receiver. Other network nodes are not involved.

SXGA

Abbreviation for Super Extended Graphics Array. Graphics standard with a screen resolution of 1280 × 1024 pixels (aspect ratio 5:4).

SXGA+

Abbreviation for SXGA Plus; Generally 1400 × 1050 pixels.

System units

Provit system units consist of a mainboard (without processor), slots for RAM modules, VGA controller, serial and parallel interfaces, and connections for the FPD, monitor, PS/2 AT keyboard, PS/2 mouse, USB, Ethernet (for system units with Intel Celeron and Pentium III processors), Panelware keypad modules and external FDD.

T

Task

Program unit that is assigned a specific priority by the real-time operating system. It contains a complete process and can consist of several modules.

TCP/IP

Transmission Control Protocol/Internet Suit of Protocols. Network protocol that has become the generally accepted standard for data exchange in heterogeneous networks. TCP/IP is used both in local networks for communication between various computer and also for LAN to WAN access.

TFT display

LCD (Liquid Crystal Display) technology where the display consists of a large grid of LCD cells. Each pixel is represented by a cell, whereby electrical fields produced in the cells are supported by thin film transistors (TFT) that result in an active matrix. In its simplest form, there is exactly one thin film transistor per cell. Displays with an active matrix are generally used in laptops and notebooks because they are thin, offer high-quality color displays and can be viewed from all angles.

Touch screen

Screen with touch sensors for selecting options in a displayed menu using the tip of the finger.

TXD

An abbreviation for "Transmit (**TX**) Data". A line for the transfer of serial data sent from one device to another, e.g. from a computer to a modem. For connections complying with the RS-232-C standard, the TXD is connected to pin 2 of the plug.

U

UART

An abbreviation for "**U**niversal **A**synchronous **R**eceiver-**T**ransmitter". A module generally consisting of a single integrated circuit that combines the circuits required for asynchronous serial communication for both sending and receiving. UART represents the most common type of circuit in modems for connecting to a personal computer.

UDMA

An abbreviation for "**U**ltra **D**irect **M**emory **A**ccess". A special IDE data transfer mode that allows high data transfer rates for drives. There have been many variations in recent times.

UDMA33 mode transfers 33 megabytes per second.

UDMA66 mode transfers 66 megabytes per second.

UDMA100 mode transfers 100 megabytes per second.

Both the mainboard and the hard drive must support the specification to implement modifications.

UPS

Abbreviation for "**U**ninterruptible **P**ower **S**upply". See "UPS".

USB

An abbreviation for "**U**niversal **S**erial **B**us" A serial bus with a bandwidth of up to 12 megabits per second (Mbit/s) for connecting a peripheral device to a microcomputer. Up to 127 devices can be connected to the system using a single multipurpose connection, the USB bus (e.g. external CD drives, printers, modems as well as the mouse and keyboard). This is done by connecting the devices in a row. USB allows devices to be changed when the power supply is switched on (hot plugging) and multi-layered data flow.

UPS

An abbreviation for "**U**ninterruptible **P**ower **S**upply". The UPS supplies power to systems that cannot be connected directly to the power mains for safety reasons because a power failure could lead to loss of data. The UPS allows the PC to be shut down securely without losing data if a power failure occurs.

UXGA

Abbreviation for "**U**ltra **E**xtended **G**raphics **A**rray" Generally a screen resolution of 1600 × 1200 pixels (aspect ratio 4:3, 12:9).

V

VGA

An abbreviation for "**V**ideo **G**raphics **A**dapter". A video adapter which can handle all EGA (Enhanced Graphics Adapter) video modes and adds several new modes.

W

Windows CE

Compact 32-bit operating system with multitasking and multithreading that Microsoft developed especially for the OEM market. It can be ported for various processor types and has a high degree of real-time capability. The development environment uses proven, well-established development tools. It is an open and scalable Windows operating system platform for many different devices. Examples of such devices are handheld PCs, digital wireless receivers, intelligent mobile phones, multimedia consoles, etc. In embedded systems, Windows CE is also an excellent choice for automation technology.

WSXGA

Wide SXGA, generally 1600 × 900 pixels (16:9).

WUXGA

Wide UXGA, generally 1920 × 1200 pixels (16:10).

WXGA

Wide XGA, generally 1280 × 768 pixels.

X

XGA

An abbreviation for "**E**Xtended **G**raphics **A**rray". An expanded standard for graphics controllers and monitors that was introduced by IBM in 1990. This standard supports 640x480 resolution with 65,536 colors or 1024x768 resolution with 256 colors. This standard is generally used in workstation systems.

Figure 1:	Typical topologies.....	36
Figure 2:	Configuration - Basic system.....	40
Figure 3:	Configuration of optional components.....	41
Figure 4:	Example of worst-case conditions for temperature measurement	43
Figure 5:	Ambient temperatures for 5PC720.1043-00 with an X945 CPU board	44
Figure 6:	Ambient temperatures for 5PC720.1043-01 with an X945 CPU board	45
Figure 7:	Ambient temperatures for 5PC720.1214-00 with an X945 CPU board	46
Figure 8:	Ambient temperatures for 5PC720.1214-01 with an X945 CPU board	47
Figure 9:	Ambient temperatures for 5PC720.1505-00 with an X945 CPU board	48
Figure 10:	Ambient temperatures for 5PC720.1505-01 with an X945 CPU board	49
Figure 11:	Ambient temperatures for 5PC720.1505-02 with an X945 CPU board	50
Figure 12:	Ambient temperatures for 5PC720.1706-00 with an X945 CPU board	51
Figure 13:	Ambient temperatures for 5PC720.1906-00 with an X945 CPU board	52
Figure 14:	Ambient temperatures for 5PC781.1043-00 with an X945 CPU board	53
Figure 15:	Ambient temperatures for 5PC781.1505-00 with an X945 CPU board	54
Figure 16:	Ambient temperatures for 5PC782.1043-00 with an X945 CPU board	55
Figure 17:	Block diagram - supply voltage	58
Figure 18:	Power calculation for 10.4" Panel PC 700 system units	59
Figure 19:	Power calculation for 12.1" Panel PC 700 system units	60
Figure 20:	Power calculation for 15" Panel PC 700	61
Figure 21:	Power calculation for 17" Panel PC 700	62
Figure 22:	Power calculation for 19" Panel PC 700	63
Figure 23:	Block diagram - supply voltage	64
Figure 24:	Power management - 10.4" Panel PC 700	66
Figure 25:	Power management - 12.1" Panel PC 700	67
Figure 26:	Power management - 15" Panel PC 700	68
Figure 27:	Power management - 17" Panel PC 700	69
Figure 28:	Power management - 19" Panel PC 700	70
Figure 29:	Supply voltage connection	78
Figure 30:	Ground connection	79
Figure 31:	Monitor / Panel interface	80
Figure 32:	Dimensions - Standard half-size PCI cards.....	83
Figure 33:	PCI connector type: 5 volt	84
Figure 34:	Serial number sticker for PPC700 assembly (back).....	93
Figure 35:	Serial number stickers for individual PPC700 components.....	93
Figure 36:	Example of serial number search: 72580168752.....	94
Figure 37:	Front view 5PC720.1043-00.....	95
Figure 38:	Rear view 5PC720.1043-00	95
Figure 39:	Dimensions - 5PC720.1043-00	96
Figure 40:	Cutout installation - 5PC720.1043-00	100
Figure 41:	Front view 5PC720.1043-01	101
Figure 42:	Rear view 5PC720.1043-01	101
Figure 43:	Dimensions - 5PC720.1043-01	102
Figure 44:	Cutout installation - 5PC720.1043-01	106
Figure 45:	Front view 5PC720.1214-00.....	107
Figure 46:	Rear view 5PC720.1214-00	107
Figure 47:	Dimensions - 5PC720.1214-00	108

Figure index

Figure 48:	Cutout installation - 5PC720.1214-00	112
Figure 49:	Front view 5PC720.1214-01	113
Figure 50:	Rear view - 5PC720.1214-01	113
Figure 51:	Dimensions - 5PC720.1214-01	114
Figure 52:	Cutout installation - 5PC720.1214-01	118
Figure 53:	Front view 5PC720.1505-00	119
Figure 54:	Rear view 5PC720.1505-00	119
Figure 55:	Dimensions - 5PC720.1505-00	120
Figure 56:	Cutout installation - 5PC720.1505-00	124
Figure 57:	Front view 5PC720.1505-01	125
Figure 58:	Rear view 5PC720.1505-01	125
Figure 59:	Dimensions - 5PC720.1505-01	126
Figure 60:	Cutout installation - 5PC720.1505-01	130
Figure 61:	Front view 5PC720.1505-02	131
Figure 62:	Rear view 5PC720.1505-02	131
Figure 63:	Dimensions - 5PC720.1505-02	132
Figure 64:	Cutout installation - 5PC720.1505-02	136
Figure 65:	Front view 5PC720.1706-00	137
Figure 66:	Rear view 5PC720.1706-00	137
Figure 67:	Dimensions - 5PC720.1706-00	138
Figure 68:	Cutout installation - 5PC720.1706-00	142
Figure 69:	Front view 5PC720.1906-00	143
Figure 70:	Rear view 5PC720.1906-00	143
Figure 71:	Dimensions - 5PC720.1906-00	144
Figure 72:	Cutout installation - 5PC720.1906-00	148
Figure 73:	Front view 5PC781.1043-00	149
Figure 74:	Rear view 5PC781.1043-00	149
Figure 75:	Dimensions - 5PC781.1043-00	150
Figure 76:	Cutout installation - 5PC781.1043-00	154
Figure 77:	Front view 5PC781.1505-00	155
Figure 78:	Rear view 5PC781.1505-00	155
Figure 79:	Dimensions - 5PC781.1505-00	156
Figure 80:	Cutout installation - 5PC781.1505-00	160
Figure 81:	Front view 5PC782.1043-00	161
Figure 82:	Rear view 5PC782.1043-00	161
Figure 83:	Dimensions - 5PC782.1043-00	162
Figure 84:	Cutout installation - 5PC782.1043-00	166
Figure 85:	X945 CPU board	167
Figure 86:	Heat sink	169
Figure 87:	Main memory module	170
Figure 88:	Add-on SSD 128 GB - 5AC600.SSDI-00 £ D0	171
Figure 89:	Add-on SSD 128 GB - 5AC600.SSDI-00 ³ E0	171
Figure 90:	Temperature humidity diagram - Add-on SSD 128 GB - 5AC600.SSDI-00 £ D0 173	
Figure 91:	Temperature humidity diagram - Add-on SSD 128 GB - 5AC600.SSDI-00 ³ E0. 174	
Figure 92:	Replacement SSD 128 GB - 5MMSSD.0128-00 £ D0	175

Figure 93:	Replacement SSD 128 GB - 5MMSSD.0128-00 ³ E0	175
Figure 94:	Temperature humidity diagram - Replacement SSD 128 GB - 5MMSSD.0128-00 £ D0	177
Figure 95:	Temperature humidity diagram - Replacement SSD 128 GB - 5MMSSD.0128-00 ³ E0	178
Figure 96:	Add-on hard disk 40 GB - 5AC600.HDDI-05	179
Figure 97:	Temperature humidity diagram - Add-on hard disk 5AC600.HDDI-05	181
Figure 98:	Add-on hard disk 80 GB - 5AC600.HDDI-06	182
Figure 99:	Temperature humidity diagram - Add-on hard disk 5AC600.HDDI-06	184
Figure 100:	Add-on CompactFlash slot - 5AC600.CFSI-00	185
Figure 101:	Slide-in USB FDD - 5AC600.FDDS-00	186
Figure 102:	Temperature humidity diagram - Slide-in USB diskette drive 5AC600.FDDS-00188	188
Figure 103:	RAID 1 system schematic	189
Figure 104:	PCI SATA RAID controller - 5ACPCI.RAIC-03	190
Figure 105:	Temperature humidity diagram - SATA RAID hard disk 5ACPCI.RAIC-03 ..	192
Figure 106:	Replacement SATA HDD 160 GB - 5ACPCI.RAIC-04	195
Figure 107:	Temperature humidity diagram - SATA RAID hard disk 5ACPCI.RAIC-04 ..	197
Figure 108:	PCI SATA RAID controller - 5ACPCI.RAIC-05	198
Figure 109:	Temperature humidity diagram - SATA RAID Hard Disk - 5ACPCI.RAIC-05	200
Figure 110:	Replacement SATA HDD 250 GB - 5MMHDD.0250-00	202
Figure 111:	Temperature humidity diagram - SATA RAID hard disk - 5MMHDD.0250-00	204
Figure 112:	Terminating resistor - Add-on CAN interface 5AC600.CANI-00	208
Figure 113:	Contents of the delivery / mounting material - 5AC600.CANI-00	208
Figure 114:	Add-on RS232/422/485 interface - operated in RS485 mode	211
Figure 115:	Contents of the delivery / mounting material 5AC600.485I-00	213
Figure 116:	Fan kit 5PC700.FA00-01	214
Figure 117:	Fan kit 5PC700.FA02-00	215
Figure 118:	Fan kit 5PC700.FA02-01	217
Figure 119:	Terminal block	219
Figure 120:	Spaces for air circulation	221
Figure 121:	Flex radius - Cable connection	223
Figure 122:	Grounding concept	224
Figure 123:	Configuration - An analog CRT device on the monitor/panel connector	227
Figure 124:	Local connection of USB peripheral devices on the PPC 700	228
Figure 125:	Open the RAID Configuration Utility	229
Figure 126:	RAID Configuration Utility - Menu	229
Figure 127:	RAID Configuration Utility - Menu	230
Figure 128:	RAID Configuration Utility - Create RAID set - Striped	231
Figure 129:	RAID Configuration Utility - Create RAID set - Mirrored	232
Figure 130:	RAID Configuration Utility - Delete RAID set	233
Figure 131:	RAID Configuration Utility - Rebuild mirrored set	234
Figure 132:	RAID Configuration Utility - Resolve conflicts	235
Figure 133:	RAID Configuration Utility - Low level format	236
Figure 134:	Example - Hardware number in the B&R Key Editor or in the B&R Control Center	236

	237	
Figure 135:	Display - Keys and LEDs in the matrix	237
Figure 136:	Hardware numbers - 5PC781.1043-00	238
Figure 137:	Hardware numbers - 5PC782.1043-00	239
Figure 138:	Hardware numbers - 5PC781.1505-00	240
Figure 139:	B&R Control Center.....	243
Figure 140:	Settings for Passmark BurnIn Pro V4 with an APC810 2-slot with DVD	244
Figure 141:	Test overview of an APC810 2-slot with DVD	245
Figure 142:	X945 - BIOS diagnostics screen	250
Figure 143:	X945 BIOS Main Menu.....	252
Figure 144:	X945 Advanced Menu	253
Figure 145:	X945 Advanced ACPI configuration	254
Figure 146:	X945 Advanced PCI Configuration.....	256
Figure 147:	X945 Advanced PCI IRQ Resource Exclusion.....	257
Figure 148:	X945 Advanced PCI Interrupt Routing	258
Figure 149:	X945 Advanced Graphics configuration	260
Figure 150:	X945 Advanced CPU Configuration	262
Figure 151:	X945 Advanced Chipset Configuration	264
Figure 152:	X945 Advanced I/O Interface Configuration.....	266
Figure 153:	X945 Advanced Clock Configuration.....	267
Figure 154:	X945 Advanced IDE Configuration.....	268
Figure 155:	X945 Primary IDE Master.....	270
Figure 156:	X945 Primary IDE Slave.....	272
Figure 157:	X945 Advanced USB Configuration	274
Figure 158:	X945 Advanced Keyboard/Mouse Configuration	276
Figure 159:	X945 Advanced Remote Access Configuration	277
Figure 160:	X945 Advanced CPU board monitor	279
Figure 161:	X945 Advanced Baseboard/Panel Features	280
Figure 162:	X945 Panel Control	282
Figure 163:	X945 Baseboard Monitor.....	283
Figure 164:	X945 Legacy Devices.....	284
Figure 165:	X945 Boot Menu	285
Figure 166:	X945 Security Menu	287
Figure 167:	X945 Hard Disk Security User Password.....	288
Figure 168:	X945 Hard Disk Security Master Password	289
Figure 169:	X945 Power Menu.....	290
Figure 170:	X945 Exit Menu	292
Figure 171:	CMOS profile hex switch	293
Figure 172:	PCI Routing with activated APIC CPU board X945.....	309
Figure 173:	Software versions.....	312
Figure 174:	Firmware version of Automation Panel Link SDL transceiver/receiver	313
Figure 175:	Creating a bootable diskette in Windows XP - step 1	321
Figure 176:	Creating a bootable diskette in Windows XP - step 2	321
Figure 177:	Creating a bootable diskette in Windows XP - step 3	321
Figure 178:	Creating a bootable diskette in Windows XP - step 4	322
Figure 179:	Creating a bootable diskette in Windows XP - step 5	322
Figure 180:	Creating a USB flash drive for B&R upgrade files.....	324

Figure 181:	Creating a CompactFlash card for B&R upgrade files	326
Figure 182:	Windows XP Professional Logo	328
Figure 183:	Windows 7 Logo.....	330
Figure 184:	Windows XP Embedded Logo.....	332
Figure 185:	Windows Embedded Standard 2009 Logo.....	334
Figure 186:	Windows Embedded Standard 7 Logo.....	337
Figure 187:	ADI Control Center screenshots - Examples (symbol photo).....	342
Figure 188:	ADI Control Center - SDL equalizer settings.....	345
Figure 189:	Test structure - torsion	366
Figure 190:	Test structure - Cable drag chain	367
Figure 191:	B&R power supplies (examples)	377
Figure 192:	Block diagram of the UPS	379
Figure 193:	Interface cover - contents of delivery	381
Figure 194:	Front side USB port cap - installation.....	383
Figure 195:	USB port cap (attached) - Height	384
Figure 196:	Temperature humidity diagram - CompactFlash cards 5CFCRD.xxxx-06 ...	388
Figure 197:	Dimensions - CompactFlash card Type I	388
Figure 198:	ATTO Benchmark v2.34 comparison when reading - 5CFCRD.xxxx-04 with 5CFCRD.xxxx-06	389
Figure 199:	ATTO Benchmark v2.34 comparison when writing - 5CFCRD.xxxx-04 with 5CFCRD.xxxx-06	389
Figure 200:	Temperature humidity diagram - CompactFlash cards 5CFCRD.xxxx-04 ...	393
Figure 201:	Dimensions - CompactFlash card Type I	393
Figure 202:	ATTO disk benchmark v2.34 comparison (reading).....	394
Figure 203:	ATTO disk benchmark v2.34 comparison (writing)	394
Figure 204:	Temperature humidity diagram - CompactFlash cards 5CFCRD.xxxx-03 ...	397
Figure 205:	Dimensions - CompactFlash card Type I	398
Figure 206:	USB Media Drive - 5MD900.USB2-01	399
Figure 207:	Dimensions - 5MD900.USB2-01	402
Figure 208:	Dimensions - USB Media Drive with front cover	403
Figure 209:	Installation cutout - USB Media Drive with front cover	403
Figure 210:	Interfaces - 5MD900.USB2-01	404
Figure 211:	Mounting orientation - 5MD900.USB2-01	404
Figure 212:	Front cover 5A5003.03.....	405
Figure 213:	Dimensions - 5A5003.03	405
Figure 214:	Front cover mounting and installation depth	406
Figure 215:	Temperature humidity diagram - USB flash drive - 5MMUSB.2048-00.....	409
Figure 216:	Temperature humidity diagram - USB flash drive - 5MMUSB.2048-01.....	411
Figure 217:	HMI Drivers & Utilities DVD 5SWHMI.0000-00	412
Figure 218:	DVI extension cable - 5CADVI.0xxx-00 (similar).....	417
Figure 219:	Flex radius specification.....	418
Figure 220:	Dimensions - DVI cable 5CADVI.0xxx-00	419
Figure 221:	Pin assignments - DVI cable	420
Figure 222:	SDL cable 5CASDL.0xxx-00 (similar)	421
Figure 223:	Flex radius specification	422
Figure 224:	Dimensions - SDL cable 5CASDL.0xxx-00	423
Figure 225:	Pin assignments - SDL cable 5CASDL.0xxx-00.....	424

Figure index

Figure 226:	SDL cable with 45° plug (similar)	425
Figure 227:	Flex radius specification	426
Figure 228:	Dimensions - SDL cable with 45° plug 5CASDL.0xxx-01	427
Figure 229:	Pin assignments - SDL cable with 45° plug 5CASDL.0xxx-01	428
Figure 230:	SDL cable 5CASDL.0xxx-03 (similar)	429
Figure 231:	Flex radius specification	431
Figure 232:	Dimensions - SDL cable 5CASDL.0xxx-03	431
Figure 233:	Pin assignments - SDL cable 5CASDL.0xxx-03	433
Figure 234:	SDL flex cable with extender - 5CASDL.0xx0-13 (similar)	434
Figure 235:	Flex radius specification	436
Figure 236:	Dimensions - SDL flex cable with extender 5CASDL.0xx0-13	436
Figure 237:	Example of the signal direction for the SDL flex cable with extender - APC620 . 437	
Figure 238:	Example of signal direction for the SDL flex cable with extender - PPC700	437
Figure 239:	Example of signal direction display - SDL flex cable with extender	437
Figure 240:	Pin assignments - SDL flex cable with extender 5CASDL.0xx0-13	438
Figure 241:	RS232 extension cable (similar)	439
Figure 242:	Pin assignments - RS232 cable	440
Figure 243:	USB extension cable (similar)	441
Figure 244:	Pin assignments - USB cable	442
Figure 245:	Legend strip templates	443
Figure 246:	Replacement fan	445
Figure 247:	SRAM module - 5AC600.SRAM-00	446
Figure 248:	SRAM module installation	448
Figure 249:	PCI Ethernet card 10/100 - 5ACPCI.ETH1-01	449
Figure 250:	Dimensions - 5ACPCI.ETH1-01	450
Figure 251:	PCI Ethernet card 10/100 - 5ACPCI.ETH3-01	451
Figure 252:	Dimensions - 5ACPCI.ETH3-01	452
Figure 253:	Battery removal	454
Figure 254:	Battery handling	455
Figure 255:	Battery polarity	455
Figure 256:	Removing the fan kit cover	456
Figure 257:	Marking for direction of airflow / fan rotation	456
Figure 258:	Fan Installation	457
Figure 259:	Removing the cover	457
Figure 260:	Fan cable connection on the main board	458
Figure 261:	Removing the fan kit cover	459
Figure 262:	Marking for direction of airflow / fan rotation	459
Figure 263:	Fan Installation	460
Figure 264:	Removing the side cover	461
Figure 265:	Fan cable connection on the main board	461
Figure 266:	Example - Side cover removal on the system unit 5PC720.1505-02	462
Figure 267:	Removing the slide-in dummy module	463
Figure 268:	Installing the slide-in drive	463
Figure 269:	Example - Side cover removal on the system unit 5PC720.1505-02	464
Figure 270:	Release the slide-in slot releasing mechanisms	464
Figure 271:	Installing the slide-in drive	465

Figure 272:	Exchange legend strips	466
Figure 273:	Screw assignment on the back side of the SATA RAID controller	468
Figure 274:	Hard disk exchange.....	469
Figure 275:	Temperature sensor locations.....	471
Figure 276:	MTCX controller location	472
Figure 277:	B&R Key Editor screenshots Version 3.10 (representation picture).....	474
Figure 278:	ADI development kit screenshots (Version 3.10)	476
Figure 279:	ADI .NET SDK Screenshots (Version 1.50)	478
Figure 280:	Temperature humidity diagram - Elo Accu touch screen 5-wire.....	481
Figure 281:	Temperature humidity diagram - AMT touch screen	483
Figure 282:	Viewing angle definition.....	485

Table 1:	Manual history.....	19
Table 2:	Environmentally-friendly separation of materials.....	24
Table 3:	Organization of safety notices.....	25
Table 4:	Model numbers - system units.....	26
Table 5:	Model numbers - X945 CPU boards.....	27
Table 6:	Model numbers - Heat sinks.....	27
Table 7:	Model numbers - Main memory.....	27
Table 8:	Model numbers - Drives.....	28
Table 9:	Model numbers - Interfaces.....	28
Table 10:	Model numbers - Fan kits.....	28
Table 11:	Model numbers - Batteries.....	29
Table 12:	Model numbers - Supply voltage connectors.....	29
Table 13:	Model numbers - CompactFlash cards.....	29
Table 14:	Model numbers - USB flash drives.....	30
Table 15:	Model numbers - Cables.....	30
Table 16:	Model numbers - Power supplies.....	32
Table 17:	Model numbers for Ethernet PCI interface cards.....	33
Table 18:	Model numbers - Other items.....	33
Table 19:	Model numbers - Software.....	34
Table 20:	Overview of humidity specifications for individual components.....	57
Table 21:	Revision dependent block diagram.....	58
Table 22:	Revision dependent 10.4" Panel PC 700.....	59
Table 23:	Revision dependent 12.1" Panel PC 700.....	60
Table 24:	Revision dependent 15" Panel PC 700.....	61
Table 25:	Revision dependent 17" Panel PC 700.....	62
Table 26:	Revision dependent 19" Panel PC 700.....	63
Table 27:	Revision dependent block diagram.....	64
Table 28:	Pin assignments - COM1.....	72
Table 29:	COM1 - I/O address and IRQ.....	72
Table 30:	Pin assignments - COM2.....	73
Table 31:	COM2 - I/O address and IRQ.....	73
Table 32:	Ethernet connection (ETH1).....	74
Table 33:	Ethernet cable lengths when using X945 CPU boards.....	75
Table 34:	Ethernet connection (ETH2).....	76
Table 35:	USB port - back.....	77
Table 36:	Power supply.....	78
Table 37:	MIC, Line IN and Line OUT ports.....	81
Table 38:	Add-on interface slot.....	82
Table 39:	Technical data - PCI bus.....	83
Table 40:	Status LEDs.....	84
Table 41:	CompactFlash slot (CF1).....	85
Table 42:	Hard disk / CompactFlash slot (HDD/CF2).....	86
Table 43:	Power button.....	87
Table 44:	Reset button.....	87
Table 45:	Connection for external keyboard/mouse (PS/2).....	88
Table 46:	Battery.....	89
Table 47:	Meaning of battery status.....	89

Table index

Table 48:	Hardware security key.....	91
Table 49:	Hardware security key - I/O address and IRQ	91
Table 50:	Slide-in slot 1	92
Table 51:	Technical data - 5PC720.1043-00	97
Table 52:	Technical data - 5PC720.1043-01	103
Table 53:	Technical data - 5PC720.1214-00	109
Table 54:	Technical data - 5PC720.1214-01	115
Table 55:	Technical data - 5PC720.1505-00	121
Table 56:	Technical data - 5PC720.1505-01	127
Table 57:	Technical data - 5PC720.1505-02	133
Table 58:	Technical data - 5PC720.1706-00	139
Table 59:	Technical data - 5PC720.1906-00	145
Table 60:	Technical data - 5PC781.1043-00	151
Table 61:	Technical data - 5PC781.1505-00	157
Table 62:	Technical data - 5PC782.1043-00	163
Table 63:	Technical data - CPU board X945	167
Table 64:	Technical data - Heat sink.....	169
Table 65:	Technical data - Main memory	170
Table 66:	Technical data - Add-on SSD - 5AC600.SSDI-00	172
Table 67:	Technical data - Replacement SSD - 5MMSSD.0128-00	176
Table 68:	Technical data - Add-on hard disk 5AC600.HDDI-05	179
Table 69:	Technical data - add-on hard disk - 5AC600.HDDI-06.....	182
Table 70:	Technical data - Add-on CompactFlash slot 5AC600.CFSI-00	185
Table 71:	Technical data - Slide-in USB diskette drive - 5AC600.FDDS-00.....	187
Table 72:	Technical data - RAID hard disk - 5ACPCI.RAIC-03.....	191
Table 73:	Technical data - RAID hard disk - 5ACPCI.RAIC-04.....	195
Table 74:	Technical data - RAID Hard Disk - 5ACPCI.RAIC-05	199
Table 75:	Technical data - RAID hard disk - 5MMHDD.0250-00	202
Table 76:	Add-on CAN interface - 5AC600.CANI-00	205
Table 77:	Technical data - Add-on CAN interface - 5AC600.CANI-00.....	205
Table 78:	Pin assignments - CAN	206
Table 79:	Add-on CAN - I/O Adresse und IRQ	206
Table 80:	CAN address register	206
Table 81:	Bus length and transfer rate - CAN	207
Table 82:	CAN cable requirements	207
Table 83:	Add-on RS232/422/485 interface - 5AC600.485I-00	209
Table 84:	Pin assignments - RS232/RS422.....	209
Table 85:	Add-on RS232/422/485 - I/O address and IRQ	210
Table 86:	RS232 - Bus length and transfer rate.....	210
Table 87:	RS232 - Cable requirements.....	210
Table 88:	RS422 - Bus length and transfer rate.....	211
Table 89:	RS422 - Cable requirements.....	211
Table 90:	RS485 - Bus length and transfer rate.....	212
Table 91:	RS485 - Cable requirements.....	212
Table 92:	Technical data - 5PC700.FA00-01	214
Table 93:	Technical data - 5PC700.FA02-00	216
Table 94:	Technical data - 5PC700.FA02-01	217

Table 95:	Mounting orientation.....	222
Table 96:	Possible combinations of system unit and CPU board	227
Table 97:	BIOS-relevant keys in the RAID Configuration Utility.....	229
Table 98:	Evaluation example using an APC810 2-slot	247
Table 99:	X945 bios-relevant keys at POST	250
Table 100:	X945 bios-relevant keys in the BIOS menu	251
Table 101:	X945 - Overview of BIOS menu items	251
Table 102:	X945 Main Menu setting options.....	252
Table 103:	X945 Advanced Menu setting options.....	253
Table 104:	X945 Advanced ACPI configuration setting options.....	255
Table 105:	X945 Advanced PCI configuration setting options	256
Table 106:	X945 Advanced PCI IRQ Resource Exclusion setting options	257
Table 107:	X945 Advanced PCI Interrupt Routing setting options.....	258
Table 108:	X945 Advanced Graphics configuration setting options.....	260
Table 109:	X945 Advanced CPU Configuration setting options.....	262
Table 110:	X945 Advanced Chipset setting options	264
Table 111:	X945 Advanced I/O Interface Configuration setting options	266
Table 112:	X945 Advanced Clock Configuration setting options	267
Table 113:	X945 Advanced IDE Configuration setting options	268
Table 114:	X945 Primary IDE Master setting options	270
Table 115:	X945 Primary IDE Slave setting options	272
Table 116:	X945 Advanced USB Configuration setting options.....	274
Table 117:	X945 Advanced Keyboard/Mouse Configuration setting options	276
Table 118:	X945 Advanced Remote Access Configuration setting options	277
Table 119:	X945 Advanced Remote Access Configuration setting options	279
Table 120:	X945 Advanced Baseboard/Panel Features setting options.....	280
Table 121:	X945 Panel Control setting options.....	282
Table 122:	X945 Baseboard Monitor setting options	283
Table 123:	X945 Legacy Devices setting options	284
Table 124:	X945 Boot Menu setting options	286
Table 125:	X945 Security Menu setting options.....	287
Table 126:	X945 Hard Disk Security User Password.....	289
Table 127:	X945 Hard Disk Security Master Password	289
Table 128:	X945 Power Menu setting options	290
Table 129:	X945 Exit Menu setting options.....	292
Table 130:	Profile overview	293
Table 131:	X945 - Main profile setting overview	294
Table 132:	X945 Advanced - ACPI Configuration profile setting overview	294
Table 133:	X945 Advanced - PCI Configuration Profile setting overview	295
Table 134:	X945 Advanced - Graphics Configuration Profile setting overview.....	296
Table 135:	X945 Advanced - CPU Configuration Profile setting overview.....	296
Table 136:	X945 Advanced - Chipset Configuration Profile setting overview	297
Table 137:	X945 Advanced - I/O Interface Configuration profile setting overview	297
Table 138:	X945 Advanced - Clock Configuration Profile setting overview	297
Table 139:	X945 Advanced - IDE Configuration Profile setting overview	297
Table 140:	X945 Advanced - USB Configuration Profile setting overview.....	298
Table 141:	X945 Advanced Keyboard/Mouse Configuration profile setting overview.....	299

Table index

Table 142:	X945 Advanced Remote Access Configuration profile setting overview.....	299
Table 143:	X945 Advanced CPU board monitor profile setting overview.....	299
Table 144:	X945 Advanced - Baseboard/Panel Features profile setting overview	300
Table 145:	X945 Boot profile setting overview	301
Table 146:	X945 Security profile setting overview	302
Table 147:	X945 Power profile setting overview	302
Table 148:	BIOS post code messages BIOS X945.....	304
Table 149:	RAM address assignment	305
Table 150:	DMA channel assignment	305
Table 151:	I/O address assignment	306
Table 152:	IRQ interrupt assignments in PCI mode.....	307
Table 153:	IRQ interrupt assignments in APIC mode	308
Table 154:	Inter-IC (I ² C) bus resources	309
Table 155:	Inter-IC (I ² C) bus resources	310
Table 156:	Model numbers - Windows XP Professional	328
Table 157:	Model numbers - Windows 7.....	330
Table 158:	Model numbers - Windows XP Embedded	332
Table 159:	Device functions in Windows XP embedded with FP2007.....	332
Table 160:	Model numbers - Windows Embedded Standard 2009.....	334
Table 161:	Device functions in Windows Embedded Standard 2009	335
Table 162:	Model numbers - Windows Embedded Standard 2009.....	337
Table 163:	Device functions in Windows Embedded Standard 7	338
Table 164:	Model numbers - Windows CE.....	340
Table 165:	Windows CE 6.0 features.....	340
Table 166:	Overview of standards	347
Table 167:	Overview of limits and testing guidelines for emissions	349
Table 168:	Test requirements - Network-related emissions for industrial areas	350
Table 169:	: Test requirements - Electromagnetic emissions for industrial areas.....	351
Table 170:	Overview of limits and testing guidelines for immunity.....	352
Table 171:	Test requirements - Electrostatic discharge (ESD)	353
Table 172:	Test requirements - High-frequency electromagnetic fields (HF field)	353
Table 173:	Test requirements - High-speed transient electrical disturbances (burst)	354
Table 174:	Test requirements - Surge voltages	354
Table 175:	Test requirements - Conducted disturbances	354
Table 176:	Test requirements - Magnetic fields with electrical frequencies	355
Table 177:	Test requirements - Voltage dips, fluctuations, and short-term interruptions	356
Table 178:	Test requirements - Damped vibration	356
Table 179:	Overview of limits and testing guidelines for vibration.....	357
Table 180:	Test requirements - Vibration during operation.....	357
Table 181:	Test requirements - Vibration during transport (packaged).....	358
Table 182:	Test requirements - Shock during operation	358
Table 183:	Test requirements - Shock during transport.....	358
Table 184:	Test requirements - Toppling	358
Table 185:	Test requirements - Toppling	359
Table 186:	Overview of limits and testing guidelines for temperature and humidity	360
Table 187:	Test requirements - Worst case during operation	360
Table 188:	Test requirements - Dry heat	360

Table 189:	Test requirements - Dry cold.....	360
Table 190:	Test requirements - Large temperature fluctuations	361
Table 191:	Test requirements - Temperature fluctuations during operation	361
Table 192:	Test requirements - Humid heat, cyclic.....	361
Table 193:	Test requirements - Humid heat, constant (storage).....	361
Table 194:	Overview of limits and testing guidelines for safety	362
Table 195:	Test requirements - Ground resistance.....	362
Table 196:	Test requirements - Insulation resistance	362
Table 197:	Test requirements - High voltage	363
Table 198:	Test requirements - Residual voltage	363
Table 199:	Test requirements - Overload	363
Table 200:	Test requirements - Defective component	364
Table 201:	Test requirements - Voltage range.....	364
Table 202:	Overview of limits and testing guidelines for other tests	365
Table 203:	Test requirements - Protection.....	365
Table 204:	International certifications	368
Table 205:	Model numbers - Accessories.....	369
Table 206:	Order data - Lithium batteries	374
Table 207:	Technical data - Lithium batteries	374
Table 208:	Order data - TB103	375
Table 209:	TB103 Technical data	375
Table 210:	Single-phase power supplies	378
Table 211:	Three-phase power supplies.....	378
Table 212:	UPS - Order data	380
Table 213:	Order data - PPC700 interface cover.....	381
Table 214:	Order data - DVI - CRT adapter.....	382
Table 215:	Order data - USB port cap (attached)	383
Table 216:	Order data - USB port cap (attached)	384
Table 217:	Order data - CompactFlash cards.....	385
Table 218:	Technical data - 5CFCRD.xxxx-06 CompactFlash cards.....	386
Table 219:	Order data - CompactFlash cards.....	390
Table 220:	Technical data - CompactFlash cards 5CFCRD.xxxx-04.....	391
Table 221:	Order data - CompactFlash cards.....	395
Table 222:	Technical data - CompactFlash cards 5CFCRD.xxxx-03.....	396
Table 223:	Technical data - USB Media Drive 5MD900.USB2-01	400
Table 224:	Contents of delivery - USB Media Drive - 5MD900.USB2-01	404
Table 225:	Technical data - 5A5003.03	405
Table 226:	Order data - USB flash drives	407
Table 227:	Technical data - USB flash drive 5MMUSB.2048-00	408
Table 228:	Technical data - USB flash drive 5MMUSB.2048-01	410
Table 229:	Model number - HMI Drivers & Utilities DVD.....	412
Table 230:	Model numbers - DVI cables.....	417
Table 231:	Technical data - DVI cable 5CADVI.0xxx-00	418
Table 232:	Contents of delivery - DVI cable 5CADVI.0xxx-00	419
Table 233:	Model numbers - SDL cables.....	421
Table 234:	Technical data - SDL cables 5CASDL.0xxx-00.....	422
Table 235:	Contents of delivery - SDL cable 5CASDL.0xxx-00	423

Table index

Table 236:	Model numbers - SDL cables with 45° plug	425
Table 237:	Technical data - SDL cable with 45° plug 5CASDL.0xxx-01	426
Table 238:	Contents of delivery - SDL cable with 45° plug 5CASDL.0xxx-01	427
Table 239:	Model numbers - SDL cable 5CASDL.0xxx-03	429
Table 240:	Technical data - SDL cable 5CASDL.0xxx-03	430
Table 241:	Contents of delivery - SDL flex cable 5CASDL.0xxx-03.....	432
Table 242:	Structure - SDL cable 5CASDL.0xxx-03	432
Table 243:	Model numbers - SDL flex cable with extender 5CASDL.0xx0-13	434
Table 244:	Technical data - SDL flex cable with extender 5CASDL.0xx0-13	435
Table 245:	Contents of delivery - SDL flex cable with extender 5CASDL.0xx0-13	436
Table 246:	Model numbers - RS232 cables	439
Table 247:	Technical data - RS232 cables	439
Table 248:	Contents of delivery - RS232 cables 9A0014.xx	439
Table 249:	Model numbers - USB cables	441
Table 250:	Technical data - USB cables	441
Table 251:	Contents of delivery - USB cable	441
Table 252:	Order data - Legend strip templates	444
Table 253:	Technical data - 5AC600.SRAM-00	446
Table 254:	Ethernet connection ETH	449
Table 255:	Ethernet connections ETH1, ETH2, ETH3	451
Table 256:	Meaning of battery status OK - Bad	453
Table 257:	Temperature sensor locations.....	471
Table 258:	Temperature limits for fan control	473
Table 259:	Technical data - Elo Accu Touch	480
Table 260:	Technical data - AMT Touch	482
Table 261:	Chemical resistance of the décor foil	484

0

0AC201.91	29, 89, 369, 374
0PS102.0	32, 369, 378
0PS104.0	32, 369, 378
0PS105.1	32, 369, 378
0PS105.2	32, 369, 378
0PS110.1	32, 369, 378
0PS110.2	32, 369, 378
0PS120.1	32, 369, 378
0PS305.1	32, 369, 378
0PS310.1	32, 369, 378
0PS320.1	32, 369, 378
0PS340.1	32, 370, 378
0TB103.9	29, 369, 375
0TB103.91	29, 369, 375

4

4A0006.00-000	29, 89, 369, 370, 374
---------------------	-----------------------

5

5A5003.03	33, 370, 405
5AC600.485I-00	28, 209
5AC600.CANI-00	28, 205
5AC600.CFSI-00	28, 86, 185
5AC600.FDDS-00	28, 92, 187
5AC600.HDDI-05	28, 86, 179
5AC600.HDDI-06	28, 86, 182
5AC600.ICOV-00	33, 370, 381
5AC600.SRAM-00	34, 371
5AC600.SSDI-00	28, 86, 171
5AC700.FA00-00	34, 373, 445
5AC700.FA02-00	34, 373
5AC700.HS01-03	27, 169
5AC900.1000-00	33, 370, 382
5AC900.104X-00	33, 370, 444
5AC900.104X-01	33, 370, 444
5AC900.1200-00	33, 370, 383
5AC900.1200-01	33, 370, 384
5AC900.1200-02	33, 370, 384
5AC900.1200-03	33, 370, 384
5AC900.150X-01	33, 370, 444
5ACPCI.ETH1-01	33, 373, 449
5ACPCI.ETH3-01	33, 373, 451
5ACPCI.RAIC-03	28, 190, 191, 199

5ACPCI.RAIC-04	28, 195, 196, 203
5ACPCI.RAIC-05	28, 198
5CADVI.0018-00	30, 371, 417
5CADVI.0050-00	31, 372, 417
5CADVI.0100-00	31, 372, 417
5CASDL.0018-00	31, 372, 421
5CASDL.0018-01	31, 372, 425
5CASDL.0018-03	31, 372, 429
5CASDL.0050-00	31, 372, 421
5CASDL.0050-01	31, 372, 425
5CASDL.0050-03	31, 372, 429
5CASDL.0100-00	31, 372, 421
5CASDL.0100-01	31, 372, 425
5CASDL.0100-03	31, 372, 429
5CASDL.0150-00	31, 372, 421
5CASDL.0150-01	31, 372, 425
5CASDL.0150-03	31, 372, 429
5CASDL.0200-00	31, 372, 421
5CASDL.0200-03	31, 372, 429
5CASDL.0250-00	31, 372, 421
5CASDL.0250-03	31, 372, 429
5CASDL.0300-00	31, 372, 421
5CASDL.0300-03	31, 372, 429
5CASDL.0300-13	31, 372, 434
5CASDL.0400-13	31, 372, 434
5CASDL.0430-13	434
5CAUSB.0018-00	31, 373, 441
5CAUSB.0050-00	32, 373, 441
5CFCRD.0064-03	30, 85, 86, 371, 395
5CFCRD.0128-03	30, 85, 86, 371, 395
5CFCRD.016G-04	30, 371, 390
5CFCRD.016G-06	29, 85, 86, 371, 385
5CFCRD.0256-03	30, 85, 86, 371, 395
5CFCRD.032G-06	29, 85, 86, 371, 385
5CFCRD.0512-03	30, 85, 86, 371, 395
5CFCRD.0512-04	30, 371, 390
5CFCRD.0512-06	29, 85, 86, 370, 385
5CFCRD.1024-03	30, 85, 86, 371, 395
5CFCRD.1024-04	30, 371, 390
5CFCRD.1024-06	29, 85, 86, 370, 385
5CFCRD.2048-03	30, 85, 86, 371, 395
5CFCRD.2048-04	30, 371, 390
5CFCRD.2048-06	29, 85, 86, 370, 385
5CFCRD.4096-03	30, 85, 86, 371, 395
5CFCRD.4096-04	30, 371, 390
5CFCRD.4096-06	29, 85, 86, 370, 385
5CFCRD.8192-03	30, 85, 86, 371, 395

Model number index

5FCFRD.8192-04	30, 371, 390	5SWWCE.0829-ENG	35, 340
5FCFRD.8192-06	29, 85, 86, 370, 385	5SWWI7.0100-ENG	34, 330
5MD900.USB2-01	33, 371, 399	5SWWI7.0100-GER	34, 330
5MMDDR.0512-01	170	5SWWI7.0300-MUL	34, 330
5MMDDR.1024-01	170	5SWWI7.0529-ENG	35, 337
5MMDDR.2048-01	170	5SWWI7.0729-MUL	35, 337
5MMHDD.0250-00	28, 202	5SWWI7.0900-MUL	35, 337
5MMSSD.0128-00	28, 175	5SWWXP.0429-ENG	35, 332
5MMUSB	407	5SWWXP.0500-ENG	34, 328
5MMUSB.2048-00	30, 371, 407	5SWWXP.0500-GER	34, 328
5MMUSB.2048-01	30, 371, 407	5SWWXP.0500-MUL	34, 328
5PC600.X945-00	27, 167	5SWWXP.0600-ENG	34, 328
5PC700.FA00-01	28, 214	5SWWXP.0600-GER	34, 328
5PC700.FA02-00	28, 216	5SWWXP.0600-MUL	34, 328
5PC700.FA02-01	29, 217	5SWWXP.0729-ENG	35, 334
5PC720.1043-00	26, 95		
5PC720.1043-01	26, 101	9	
5PC720.1214-00	26, 107	9A0014.02	32, 372, 439
5PC720.1214-01	26, 113	9A0014.05	32, 373, 439
5PC720.1505-00	26, 119	9A0014.10	32, 373, 439
5PC720.1505-01	26, 125	9A0017.01	33, 370, 380
5PC720.1505-02	26, 131	9A0017.02	33, 370, 380
5PC720.1706-00	26, 137	9A0100.11	32, 370, 380
5PC720.1906-00	26, 143	9A0100.14	33, 370, 380
5PC781.1043-00	27, 149	9A0100.15	33, 370, 380
5PC781.1505-00	27, 155	9S0000.01-010	34
5PC782.1043-00	27, 161	9S0000.01-020	34
5SWHMI.0000-00	34, 371, 412		

A

AC97 sound	38, 81
ACPI	307, 308, 486
Add-on	82
Add-on CAN interface	205
Add-on CompactFlash slot	185
Add-on RS232/422/485 interface	209
Address register	206
ADI	342, 472, 486
.NET SDK	478
Development kit	476
Drivers	342
After-images	467
APC	486
API	486
ATX power supply	87
Automation Runtime	327, 447, 486

B

B&R Automation Device Interface	342
B&R Automation Runtime	487
B&R Embedded OS Installer	341
B&R Key Editor	474
Backlight	241
Backup battery	89
Barcodes	93
Battery	89
Battery status	89
Baud rate	486
Beep codes	304
Beeping code	304
BIOS	486
BIOS default settings	293
BIOS Error signals	304
BIOS Error Signals X945	304
BIOS Extension ROM	194
BIOS upgrade	311
BIOS X945	
ACPI configuration	254
Advanced	253
Baseboard monitor	283
BIOS setup keys	250
Boot	285
Chipset configuration	264
Clock Configuration	267

CPU board monitor	279
CPU configuration	262
Exit	292
Graphics configuration	260
Hard disk security master password	289
Hard disk security user password	288
I/O interface configuration	266
IDE Configuration	268
Keyboard/mouse configuration	276
Legacy devices	284
Main	252
Main Board/Panel Features	280
Panel control	282
PCI Configuration	256
Power	290
Remote access configuration	277
Security	287
USB configuration	274
Bit	487
Bit rate	487
Bootstrap loader	487
Buffer duration	89
Burn-in effect	241, 467
Burst	354
Bus length	207
Bus structure	208
Byte	487

C

Cable drag chain	367
Cable type	207, 210, 211, 212
Cache	167, 487
Cage clamps	78
CAN	38, 487
Bus length	207
Cable type	207
CAN address register	206
CAN controller	205
CD-ROM	487
CE mark	488
Certifications	368
Climate conditions	360
CMOS	488
CMOS battery	374
COM	488
COM1	72, 488

Index

- COM2 73, 488
 - COM3 488
 - CompactFlash 390, 488
 - Dimensions 388, 393, 398
 - General Information 390, 395
 - General information 385
 - Order data 385, 390, 395
 - Technical data 386, 391, 396
 - CompactFlash slot 85, 86
 - Conducted disturbances 354
 - Construction 39
 - Control Center 471
 - CPU 489
 - Creating a CompactFlash card for B&R upgrade files 325
 - CTS 489
- ### D
- Damp heat, constant 361
 - Damped vibration 356
 - Data loss 87, 88, 501
 - Data register 206
 - DCD 489
 - Defective component 364
 - Development kit 476
 - Device ID 447
 - Dial-up 489
 - Dimension standards 25
 - DIMM 489
 - Display lifespan 241
 - Display memory effect 467
 - Disposal 24
 - Distribution of resources 305
 - DMA channel assignment 305
 - I/O address assignment 306
 - Interrupt assignments 307, 308
 - RAM address assignment 305
 - DMA 489
 - Dongle 91
 - DOS boot diskette 321
 - DRAM 489
 - Drives 171
 - Dry cold 360
 - Dry heat 360
 - DS1425 91
 - DSR 490
 - DTR 490
 - DVD 490
 - DVI 490
 - DVI - CRT adapter 382
 - DVI cable 417
 - DVI-A 490
 - DVI-D 490
 - DVI-I 490
- ### E
- EDID 490, 491
 - EIDE 490
 - Electromagnetic emissions 351
 - Electrostatic discharge 353
 - Embedded OS Installer 341
 - EMC 491
 - Emissions 349, 351
 - EPROM 491
 - Error signals 304
 - ESD 21, 353
 - Electrical components with housing 21
 - Electrical components without housing .. 21
 - Individual components 22
 - Packaging 21
 - Proper handling 21
 - ETH1 74
 - ETH2 76
 - Ethernet 38, 491
 - ETHERNET Powerlink 491
 - European directives 347
 - Exchanging the legend strips 466
 - Extended desktop 472
- ### F
- Fan kit installation 456
 - Fan kit replacement 456
 - Fan kits 214
 - Fastening torque 219
 - FDD 491
 - Features 38
 - Fiber optics 491
 - FIFO 491
 - Firmware 316, 491
 - Flex radius 439, 441

Floating Point Unit	167	Insulation resistance	362
Floppy	492	Interface	493
FPC	492	Interrupt assignments	307, 308
FPD	492	ISA	493
Free fall	359	ISO	493
Front cover	405		
FTP	492	J	
Full Speed	77	Jitter	493
		Jumper	493
G			
GB	492	K	
Graphics	168	Key editor	474
Ground resistance	362	Keyboard	88
Grounding concept	224		
		L	
H		L1 cache	167
Half-size	38	L2 cache	167
Handshake	492	LCD	493
Hard disk	86	LED	84, 494
Hardware security key	91	Line IN	81
HDD	84, 492	Line OUT	81
Heat sink	169	Lithium battery	89
HF field	353	Low speed	77
Hibernate	84	LPT	494
High speed	77		
High voltage	363	M	
High-frequency electromagnetic fields	353	Magnetic fields with electrical frequencies	355
High-speed transient elect. disturbance value	354	Main memory	170
Hot Plug	88	Maintenance Controller Extended	472
Humid heat, cyclic	361	Manual history	19
Humidity specifications	57	MAXIM	91
		Maximum memory capacity	170
I		MB	494
I/O address assignment	306	Mechanical conditions	357
IDE	492	Memory capacity	170
Identification	93	Messages	304
Image retention	467	MIC	81
Image sticking	241, 467	Microprocessor	494
Immunity	352	MIPS	494
Individual components		Mkey	494
RAID system	189	Model numbers	26
X945 CPU boards	167		

Index

- Monitor / Panel 80
Motherboard 494, 495
Mounting orientation 222
Mounting rail brackets 399
Mouse 88
MS-DOS Boot diskette 321
MTBF 494
MTC 495
MTCX 87, 472, 495
Multitasking 495
- ### N
- Network-related emissions 350
NMI 205
- ### O
- OEM 495
OPC 495
OPC server 495
Overload 78, 363
- ### P
- Panel 495
Parallel port 91
Part subject to wear 89
PCI 496
PCI configuration space 447
PCI Ethernet card 449, 451
PCI slot 83
PCMCIA 496
PLC 496
PnP 496
POH 496
POST 496
Post codes 304
Power 84
Power button 87
Power supply 377
Powerlink 496
pre calibration 225
PROFIBUS 497
PROFIBUS-DP 497
Protection 365
- PS/2 88
 Keyboard 88
 Mouse 88
 Y-cable 88
- ### Q
- QUXGA 497
QVGA 497
QWUXGA 497
QXGA 499
- ### R
- RAID 190, 198
RAID controller 329
RAM 497
Real time 497
Real-time clock 38, 89, 167
Replacement fan filter 5AC700.FA00-00 . 445
Replacement PCI SATA RAID HDD 202
Replacing the main memory 170
Requirements for emissions 349
Requirements for immunity to disturbances .. 352
Reset button 87
Residual voltage 363
Reverse polarity protection 78
ROM 497
RS232 210, 498
 Bus length 210
 Cable type 210
RS232 cable 439
RS422 211, 498
 Bus length 211
 Cable type 211
RS485 211, 498
 Bus length 212
 Cable type 212
RTC 38, 89, 167
RTS 498
RXD 498
- ### S
- Safety 362

Safety notices	21	Supply voltage	38, 78
Dust, humidity, aggressive gases	23	Supply voltage connectors	375
Environmentally-friendly disposal	24	Surge	354
Installation	23	Surge voltages	354
Intended use	21	Suspend-to-disk	84
Operation	23	SUXGA	499
Organization	25	SVGA	499
Policy and procedures	22	Switch	499
Programs	24	Switching power supply	377
Protection against electrostatic discharge ..	21	SXGA	499
Touching electrical parts	23	SXGA+	499
Transport and storage	22	System units	499
Viruses	24		
SATA	189, 190, 198	T	
Screw clamps	78	Task	499
SDL cable with 45° plug	425	TCP/IP	499
SDL cables	420, 429	Temperature	471
SDL equalizer	345	Temperature fluctuations	361
SDL flex cable with extender	434	Operation	361
SDRAM	498	Temperature monitoring	56
Security Key	91	Temperature sensor	471
Self discharging	89	Temperature sensor locations	471
Sequential Function Chart	498	Terminal block	219
Serial number	93	TFT display	500
SFC	498	Three-phase power supplies	378
Shock during operation	358	Toppling	358
Shock during transport	358	Torsion	366
Short-term interruptions	356	Touch screen	500
Single-phase power supplies	378	Touch screen calibration	225
Slide-in slot 1	92	Automation Runtime	225
Slide-in USB FDD	186	Visual Components	225
Slot PLC	498	Windows CE	225
Soft-off	84	Windows XP embedded	225
SoftPLC	499	Windows XP Professional	225
Software	249	TXD	500
SRAM module			
Driver support	447	U	
Technical data	446	UART	500
Standard keypad module	499	UDMA	500
Standards	347	Upgrade information	311
Overview	347	UPS	500, 501
Status LED	84	USB	500
HDD	84	USB 2.0	77
Link 1	84	USB cable	441
Link 2	84		
Power	84		

Index

USB flash drive	407
General Information	407
Order data	407
Technical data	408
USB flash drive for B&R update files	323
USB Media Drive	399
Dimensions	402
Dimensions with front cover	403
Installation	404
Interfaces	404
Mounting orientation	404
Technical data	400
USB port cap	384
USB ports	77
UXGA	501

V

Vendor ID	447
VGA	501
Vibration during transport	358
Vibration operation	357
Viewing angles	485
Voltage dips	356
Voltage fluctuations	356
Voltage range	364

W

WES2009	334
WES7	338
Windows 7	330
Windows CE	340, 501
eMbedded OS Installer	341
General Information	340
Installation	341
Windows CE 6.0	
Features	340
Windows Embedded Standard 2009	334
Windows Embedded Standard 7	337
Windows XP Embedded	
General Information	332
Installation	333
Touch screen driver	333, 336, 339
Windows XP Professional	
Installation	330
Worst case	360
WSXGA	501
WUXGA	501
WXGA	501

X

X945 CPU board	167
XGA	501