



Benchmark Test

Industrial PCs

Date: August 29, 2018

Project Number:

We reserve the right to change the content of this manual without prior notice. The information contained herein is believed to be accurate as of the date of publication, however, B&R makes no warranty, expressed or implied, with regards to the products or the documentation contained within this document. B&R shall not be liable in the event of incidental or consequential damages in connection with or arising from the furnishing, performance or use of these products. The software names, hardware names and trademarks used in this document are registered by the respective companies.

I Versions

Version	Date	Comment	Edited by
2.0	06/08/2005	First edition	GIA
2.1	09/26/2005	Document upgrade with B&R Automation Runtime (AR010 Version E2.82) tests	GIA
2.2	11/29/2005	Document upgrade with B&R Automation Runtime (AR106 Version B2.83) tests	GIA
2.3	03/19/2008	<ul style="list-style-type: none"> Document changeover to BrManualTech V2.6 guideline Document upgrade with APC810 (SiSoft Sandra 2007) tests 	EBB
2.4	02/06/2009	<ul style="list-style-type: none"> Benchmark enhancements with PP300/400 (LX800-500) 	MIK
2.5	04/28/2009	<ul style="list-style-type: none"> Benchmark enhancements with APC810 (Intel Atom N270 + 945GME) Benchmark enhancements with APC810 (Intel T9400 + GM45). 	MIK
2.6	05/20/2009	<ul style="list-style-type: none"> Benchmark enhancements with APC810 (Intel Atom N270 + 945GME) Upgrade the document with Sisoft Sandra Pro Business 2007 benchmarkresults „Removeable Storage“. 	RAM
2.7	06/23/2009	<ul style="list-style-type: none"> Benchmark enhancements with APC620 (Intel Atom N270 + 945GME) 	MIK
2.8	08/11/2009	<ul style="list-style-type: none"> Benchmark enhancements with APC810 (Intel P8400 + GM45). 	MIK
2.9	10/16/2009	<ul style="list-style-type: none"> Benchmark enhancements with INTEL Evalboard (Intel Z530 + US15W Chipset). 	MIK
3.0	09/20/2010	<ul style="list-style-type: none"> Benchmark enhancements with PP500 (Intel Z520 + US15W Chipset). 	MIK
3.1	08/31/2011	<ul style="list-style-type: none"> Benchmark enhancements with PP500 (Intel Z510 and Z530 + US15W Chipset). 	MIK
3.2	06/22/2012	<ul style="list-style-type: none"> Benchmark enhancements with APC910 (Intel i7, i5, i3 and Celeron processors with SiSoft Sandra 2011 and Passmark Performance test) 	BEM
3.3	10/16/2012	<ul style="list-style-type: none"> Benchmark enhancements with PPC800 (Intel Dual Core Atom N2800 + NM10 Chipset). 	MIK
3.4	07/04/2013	<ul style="list-style-type: none"> Benchmark enhancements with APC910 (C-1020E 2,2GHz and C-1047UE 1,4GHz) 	MIK
3.5	11/04/2014	<ul style="list-style-type: none"> Benchmark enhancements with APC2100/PPC2100 	MIK
3.6	09/29/2016	<ul style="list-style-type: none"> Benchmark enhancements with APC2100/PPC2100 equipped with 2x4GB DRAM (5xPC2100.BY48-00x) 	MIK
3.7	11/07/2016	<ul style="list-style-type: none"> Benchmark enhancements with APC910 (i5-6440EQ, i3-6100E and C-G3900E) 	MIK
3.8	05/16/2017	<ul style="list-style-type: none"> Benchmark enhancements with APC910 (E3-1515MV5) Benchmark enhancements with APC3100/PPC3100 	MIK
3.9	02/19/2018	<ul style="list-style-type: none"> Switched to new Corporate Design Benchmark enhancements with APC910 (i7-6820EQ) 	MIK
4.0	08/28/2018	<ul style="list-style-type: none"> Benchmark enhancements with APC2200/PPC2200 	MIK

Table 1: Versions

II Distribution

This Application Note is intended for technically qualified staff.

III Safety Notices

Safety notices in this document are organized as follows:

Safety notice	Description
Danger!	Disregarding the safety regulations and guidelines can be life-threatening.
Warning!	Disregarding the safety regulations and guidelines can result in severe injury or heavy damage to material.
Caution!	Disregarding the safety regulations and guidelines can result in injury or damage to material.
Information:	Important information used to prevent errors.

Table 2: Safety notices

IV Test Locations

No.	Company	Street	Post Code	Place	Phone	Contact
1	B&R Industrial Automation	B&R Straße 1	A-5142	Eggelsberg	+43/7748/6586-0	

Table 3: Test locations

V Table of Contents

1 Introduction.....	6
2 Hardware	7
2.1 Devices being tested.....	7
2.2 Hard disks / removeable devices	10
3 Software	11
3.1 Benchmark programs.....	11
3.2 Operating system	11
4 Results.....	12
4.1 Sisoft Sandra 2002 Prof	12
4.1.1 CPU arithmetic.....	12
4.1.2 CPU multimedia	14
4.1.3 Memory bandwidth.....	16
4.2 Sisoft Sandra 2005 SR1	18
4.2.1 CPU arithmetic.....	18
4.2.2 CPU multimedia	20
4.2.3 Memory bandwidth.....	22
4.3 PCMark2002	24
4.4 PCMark04	26
4.5 WinBench99.....	28
4.5.1 CPUMark99	28
4.5.2 FPUWinMark.....	30
4.5.3 Direct Draw	32
4.5.4 Disk Inspection Test.....	34
4.5.5 High End Disk WinMark99	36
4.5.6 Business Disk WinMark99	38
4.6 HDTACH Version 2.70.....	39
4.6.1 HDTACH read speed	39
4.6.2 HDTACH access time measurement	40
4.7 3D Mark 2000.....	41
4.8 3D Mark 2001SE.....	43
4.9 B&R Automation Runtime AR010 Version E2.82	45
4.10 B&R Automation Runtime AR106 Version B2.83	47
4.10.1 Structure of the test.....	47
4.10.1.1 Automation Panel AP920.1505-01	47
4.10.1.2 36 ACOPOS 1045 axes	47
4.10.1.3 26 X20IOs	47
4.10.2 Test procedure	47
4.10.3 Results	48
4.11 Sisoft Sandra Pro Business 2007	49
4.11.1 CPU arithmetic.....	49
4.11.2 CPU multimedia	51
4.11.3 Memory bandwidth.....	53
4.11.4 Cache and memory bandwidth	55
4.11.5 Physical devices / removeable devices	57
4.12 SiSoft Sandra 2011 Lite	59
4.12.1 APC910/PPC900	59
4.12.1.1 CPU Arithmetic.....	59
4.12.1.2 Processor Multi-media.....	62
4.12.1.3 Multi-Core Efficiency	65
4.12.1.4 Cryptography.....	67
4.12.1.5 Video Rendering	70
4.12.1.6 Video Memory Bandwidth	77
4.12.1.7 Memory Bandwidth.....	82

4.12.1.8 Memory Latency.....	85
4.12.1.9 Cache and Memory.....	89
4.12.2 APC2100/PPC2100.....	92
4.12.2.1 CPU Arithmetic.....	92
4.12.2.2 Processor Multi-media.....	93
4.12.2.3 Multi-Core Efficiency.....	94
4.12.2.4 Cryptography.....	95
4.12.2.5 Video Rendering.....	96
4.12.2.6 Video Memory Bandwidth.....	99
4.12.2.7 Memory Bandwidth.....	102
4.12.2.8 Memory Latency.....	103
4.12.2.9 Cache and Memory.....	105
4.12.3 Comparison APC910/PPC900 and APC2100/PPC2100.....	106
4.13 Passmark Performance Test 7.0.....	108
4.13.1 APC910/PPC900.....	108
4.13.1.1 Passmark Rating.....	108
4.13.1.2 CPU Mark.....	110
4.13.1.3 2D Graphics Mark.....	112
4.13.1.4 3D Graphics Mark.....	114
4.13.1.5 Memory Mark.....	116
4.13.1.6 Disk Mark.....	118
4.13.2 APC910.....	120
4.13.2.1 Passmark Rating.....	120
4.13.2.2 CPU Mark.....	122
4.13.2.3 2D Graphics Mark.....	124
4.13.2.4 3D Graphics Mark.....	126
4.13.2.5 Memory Mark.....	128
4.13.2.6 Disk Mark.....	130
4.13.3 APC2100/PPC2100.....	132
4.13.3.1 Passmark Rating.....	132
4.13.3.2 CPU Mark.....	133
4.13.3.3 2D Graphics Mark.....	134
4.13.3.4 3D Graphics Mark.....	135
4.13.3.5 Memory Mark.....	136
4.13.3.6 Disk Mark.....	137
4.13.4 APC3100/PPC3100.....	138
4.13.4.1 Passmark Rating.....	138
4.13.4.2 CPU Mark.....	139
4.13.4.3 2D Graphics Mark.....	140
4.13.4.4 3D Graphics Mark.....	141
4.13.4.5 Memory Mark.....	142
4.13.4.6 Disk Mark.....	143
4.13.5 APC2200/PPC2200.....	144
4.13.5.1 Passmark Rating.....	144
4.13.5.2 CPU Mark.....	145
4.13.5.3 2D Graphics Mark.....	146
4.13.5.4 3D Graphics Mark.....	147
4.13.5.5 Memory Mark.....	148
4.13.5.6 Disk Mark.....	149
4.13.6 Comparison PP500, APC810/PPC800, APC910/PPC900, APC2100/PPC2100, APC3100/PPC3100 and APC2200/PPC2200.....	150
5 Figure Index.....	153
6 Table Index.....	156
7 Index.....	158

1 Introduction

This document is meant to show how the performance of different B&R industrial PCs compare to each other.

The setup of information provided was based on a setup used by many popular magazines and web pages (e.g. Tecchannel).

Information:

All results provided cannot be interpreted and used as absolute values. They should be considered as comparison values that can vary slightly depending on the operating system and computer being used.

2 Hardware

The following hardware was used for the benchmark tests:

2.1 Devices being tested

#	CPU	RAM	VGA controller	Manuf.
Power Panel 100/200 (5PP120.1505-37)				
1	Geode SC2200 266 MHz	128 MB SD RAM	Geode SC2200 4MB (Shared)	B&R
IPC2001				
2	AMD 486DX2-66 MHz	8 MB DRAM	Chips & Technologies 65535 1MB	B&R
3	AMD 486DX5-133 MHz	32 MB DRAM	Chips & Technologies 65535 1MB	B&R
IPC5000C				
4	Intel Celeron 3 566 MHz 66 MHz FSB	256 MB SDRAM 100 MHz	Chips & Technologies 69000 2MB	B&R
5	Intel Celeron 3 850 MHz 66 MHz FSB	256 MB SDRAM 100 MHz	Chips & Technologies 69000 2MB	B&R
6	Intel Pentium 3 600 MHz 100 MHz FSB	256 MB SDRAM 100 MHz	Chips & Technologies 69000 2MB	B&R
7	Intel Pentium 3 850 MHz 100 MHz FSB	256 MB SDRAM 100 MHz	ATI Rage Mobility 4MB	B&R
APC680				
8	Intel Celeron 3 850 MHz 100 MHz FSB	256 MB SDRAM 133 MHz	Intel 815E Graphics Controller 32 MB	B&R
9	Intel Pentium 3 1.26 GHz 133 MHz FSB	512 MB SDRAM 133 MHz	Intel 815E Graphics Controller 32 MB	B&R
APC620 with INTEL 815E chipset				
10	Intel Celeron 3 400 MHz 100 MHz FSB	256 MD SDRAM 133 MHz	Intel 82815 Graphics Controller 32 MB	B&R
11	Intel Celeron 3 733 MHz 133 MHz FSB	512 MB SDRAM 133 MHz	Intel 82815 Graphics Controller 32 MB	B&R
12	Intel Celeron 3 1000 MHz 133 MHz FSB	512 MB SDRAM 133 MHz	Intel 82815 Graphics Controller 32 MB	B&R
APC620 with INTEL 855GME chipset				
13	Intel Celeron M 600 MHz 400 MHz FSB	256 MB DDR-SDRAM PC2700 333 MHz	Intel 82855 GME Graphic Controller 64 MB	B&R
14	Intel Celeron M 1000 MHz 400 MHz FSB	256 MB DDR-SDRAM PC2700 333MHz	Intel 82855 GME Graphic Controller 64 MB	B&R
15	Intel Pentium M 1.1 GHz 400 MHz FSB	1 GB DDR-SDRAM PC2700 333 MHz	Intel 82855 GME Graphic Controller 64 MB	B&R
16	Intel Pentium M 1.4 GHz 400 MHz FSB	512 MB DDR-SDRAM PC2700 333 MHz	Intel 82855 GME Graphic Controller 64 MB	B&R
17	Intel Pentium M 1.6 GHz 400 MHz FSB	1 GB DDR-SDRAM PC2700 333 MHz	Intel 82855 GME Graphic Controller 64 MB	B&R
18	Intel Pentium M 1.8 GHz 400 MHz FSB	512 MB DDR-SDRAM PC2700 333 MHz	Intel 82855 GME Graphic Controller 64 MB	B&R
Other test computers				
19	Intel Pentium 4 2.4 GHz 533 MHz FSB	512 MB DDR-SDRAM 333 MHz	Intel 82865G Graphics Controller 96 MB	HP
20	Intel Pentium 4 2.6 GHz 533 MHz FSB	512 MB DDR-SDRAM 333 MHz	Sapphire ATI Radeon 9600 Atlantis 256 MB DDR	HP
APC810 with INTEL 945GME chipset				
21	Celeron M 1.06 GHz 533 MHz FSB	512MB DDR2-SDRAM	Intel Graphics Media Accelerator 950 max. 224MB	B&R
22	Celeron M 1.06 GHz 533 MHz FSB	2x512MB DDR2-SDRAM	Intel Graphics Media Accelerator 950 max. 224MB	B&R
23	Core 2 Duo 1.06 GHz 533 MHz FSB	2x1024MB DDR2-SDRAM	Intel Graphics Media Accelerator 950 max. 224MB	B&R

#	CPU	RAM	VGA controller	Manuf.
24	Core 2 Duo 1.50 GHz 667MHz FSB	2x512MB DDR2-SDRAM	Intel Graphics Media Accelerator 950 max. 224MB	B&R
25	Core Duo 1.66 GHz 667MHz FSB	2x1024MB DDR2-SDRAM	Intel Graphics Media Accelerator 950 max. 224MB	B&R
26	Core 2 Duo 2.16 GHz 667MHz FSB	1024MB DDR2-SDRAM	Intel Graphics Media Accelerator 950 max. 224MB	B&R
27	Core 2 Duo 2.16 GHz 667MHz FSB	2x1024MB DDR2-SDRAM	Intel Graphics Media Accelerator 950 max. 224MB	B&R
Power Panel 300/400 (5PP320.1214-39)				
28	AMD Geode LX800-500	256MB DDR-SDRAM 333MHz	AMD Geode LX800 4MB	B&R
APC810 with Intel 945GME chipset + Intel Atom N270				
29	Intel Atom N270 1,6GHz, 533MHz FSB, 512KB Cache	2 x 2048MB DDR2-SDRAM	Intel Graphics Media Accelerator 950 max. 224MB	B&R
APC810 with Intel GM45 chipset + Intel T9400				
30	Core 2 Duo 2,53GHz, 1066 MHz FSB, 6MB Cache	2 x 2048MB DDR3-SODIMM	Intel GM45	B&R
APC620 with Intel 945GME chipset + Intel Atom N270				
31	Intel Atom N270 1,6GHz, 533MHz FSB, 512KB Cache	1024MB DDR2-SDRAM	Intel Graphics Media Accelerator 950 max. 224MB	B&R
APC810 with Intel GM45 chipset + Intel P8400				
32	Core 2 Duo 2,26GHz, 1066 MHz FSB, 3MB Cache	2 x 2048MB DDR3-SODIMM	Intel GM45	B&R
INTEL Evalboard with INTEL US15W Chipsatz + INTEL Atom Z530				
33	Intel Atom Z530 1,6GHz, 533MHz FSB, 512KB Cache	1024MB DDR2-SDRAM	Intel US15W	INTEL
Power Panel 500 (5PP520.1505-00 + 5PP5CP.US15-01)				
34	Intel Atom Z520 1,33GHz, 533MHz FSB, 512KB Cache	2048MB DDR2-SDRAM	Intel US15W	B&R
Power Panel 500 (5PP520.1505-00 + 5PP5CP.US15-02)				
35	Intel Atom Z530 1,6GHz, 533MHz FSB, 512KB Cache	2048MB DDR2-SDRAM	Intel US15W	B&R
Power Panel 500 (5PP520.1505-00 + 5PP5CP.US15-00)				
36	Intel Atom Z510 1,1GHz, 400MHz FSB, 512KB Cache	2048MB DDR2-SDRAM	Intel US15W	B&R
APC910 with Intel QM77 Chipset				
37	i7-3615QE 4C 2.3/1.6GHz 6MB 45W	2 x 4096MB DDR3-SODIMM 1067MHz	Intel HD 4000	B&R
38	i7-3615QE 4C 2.3/1.6GHz 6MB 45W	2 x 4096MB DDR3-SODIMM 1600MHz	Intel HD 4000	B&R
39	i7-3612QE 4C 2.1/1.6GHz 6MB 35W	2 x 4096MB DDR3-SODIMM 1067MHz	Intel HD 4000	B&R
40	i7-3612QE 4C 2.1/1.6GHz 6MB 35W	2 x 4096MB DDR3-SODIMM 1600MHz	Intel HD 4000	B&R
41	i7-3555LE 2C 2.5/1.6GHz 4MB 25W	4096MB DDR3-SODIMM 1067MHz	Intel HD 4000	B&R
42	i7-3555LE 2C 2.5/1.6GHz 4MB 25W	4096MB DDR3-SODIMM 1600MHz	Intel HD 4000	B&R
43	i7-3555LE 2C 2.5/1.6GHz 4MB 25W	2 x 2048MB DDR3-SODIMM 1067MHz	Intel HD 4000	B&R
44	i7-3555LE 2C 2.5/1.6GHz 4MB 25W	2 x 4096MB DDR3-SODIMM 1600MHz	Intel HD 4000	B&R
45	i7-3517UE 2C 1.7/1.6GHz 4MB 17W	2 x 2048MB DDR3-SODIMM 1067MHz	Intel HD 4000	B&R

#	CPU	RAM	VGA controller	Manuf.
46	i7-3517UE 2C 1.7/1.6GHz 4MB 17W	2 x 4096MB DDR3-SODIMM 1600MHz	Intel HD 4000	B&R
47	i5-3610ME 2C 2.7/1.6GHz 3MB 35W	2 x 2048MB DDR3-SODIMM 1067MHz	Intel HD 4000	B&R
48	i5-3610ME 2C 2.7/1.6GHz 3MB 35W	2 x 4096MB DDR3-SODIMM 1600MHz	Intel HD 4000	B&R
49	i3-3120ME 2C 2.4/1.6GHz 3MB 35W	2 x 2048MB DDR3-SODIMM 1067MHz	Intel HD 4000	B&R
50	i3-3120ME 2C 2.4/1.6GHz 3MB 35W	2 x 4096MB DDR3-SODIMM 1600MHz	Intel HD 4000	B&R
51	i3-3217UE 2C 1.6/1.6GHz 3MB 17W	2 x 2048MB DDR3-SODIMM 1067MHz	Intel HD 4000	B&R
52	i3-3217UE 2C 1.6/1.6GHz 3MB 17W	2 x 4096MB DDR3-SODIMM 1600MHz	Intel HD 4000	B&R
APC910 with Intel HM76 Chipset				
53	C-847 2C 1.1/1.3GHz 2MB 17W	2 x 2048MB DDR3-SODIMM 1067MHz	Intel HD 4000	B&R
54	C-847 2C 1.1/1.3GHz 2MB 17W	2 x 4096MB DDR3-SODIMM 1333MHz	Intel HD 4000	B&R
55	C-827E 1C 1.4/1.3GHz 1.5MB 17W	2 x 2048MB DDR3-SODIMM 1067MHz	Intel HD 4000	B&R
56	C-827E 1C 1.4/1.3GHz 1.5MB 17W	2 x 4096MB DDR3-SODIMM 1333MHz	Intel HD 4000	B&R
PPC800 with Intel NM10 Chipset + Intel Dual Core Atom N2800				
57	Intel Dual Core Atom N2800 1,86GHz, 533MHz FSB, 1MB Cache	4096MB DDR3-SODIMM 1067MHz	Intel Graphics Media Accelerator 3600	B&R
APC910 with Intel HM76 Chipset				
58	C-1047UE 2C 1.4/1.6GHz 2MB 17W	2 x 4096MB DDR3-SODIMM 1600MHz	Intel HD Graphics	B&R
59	C-1020E 2C 2.2/1.6GHz 2MB 35W	2 x 4096MB DDR3-SODIMM 1600MHz	Intel HD Graphics	B&R
APC2100/PPC2100 with Intel Bay Trail				
60	E3815 1C 1.46GHz 512kB 5W 1GB	1 x 1024 MB DDR3L-1067	Intel HD Graphics (BayTrail)	B&R
61	E3825 2C 1.33GHz 1MB 6W 1GB	1 x 1024 MB DDR3L-1067	Intel HD Graphics (BayTrail)	B&R
62	E3826 2C 1.46GHz 1MB 7W 2GB	1 x 2048 MB DDR3L-1067	Intel HD Graphics (BayTrail)	B&R
63	E3827 2C 1.75GHz 1MB 8W 4GB	1 x 4096 MB DDR3L-1333	Intel HD Graphics (BayTrail)	B&R
64	E3845 4C 1.91GHz 2MB 10W 4GB	1 x 4096 MB DDR3L-1333	Intel HD Graphics (BayTrail)	B&R
65	E3845 4C 1.91GHz 2MB 10W 8GB	2 x 4096 MB DDR3L-1333	Intel HD Graphics (BayTrail)	B&R
APC910 with Intel QM170 Chipset				
66	i5-6440EQ 4C 2.7GHz 6MB 45W	2 x 4096 MB DDR4 2133MHz	Intel HD Graphics 530	B&R
67	i7-6820EQ 4C 2.8GHz 8MB 45W	2 x 8192 MB DDR4 2133MHz	Intel HD Graphics 530	B&R
APC910 with Intel HM170 Chipset				
68	i3-6100E 2C 2.7GHz 3MB 35W	2 x 4096 MB DDR4 2133MHz	Intel HD Graphics 530	B&R
69	i3-6100E 2C 1.9GHz 3MB 35W	2 x 8192 MB DDR4 2133MHz	Intel HD Graphics 530	B&R
70	C-G3900E 2C 2.4GHz 2MB 35W	2 x 8192 MB DDR4 2133MHz	Intel HD Graphics 510	B&R
71	C-G3900E 2C 1.7GHz 2MB 35W	2 x 8192 MB DDR4 2133MHz	Intel HD Graphics 510	B&R
APC910 with Intel CM236 Chipset				
72	E3-1515MV5 4C 2,8GHz 8MB 45W	2 x 8192 MB DDR4 2133MHz	Intel Iris Pro Graphics 580	B&R
APC3100/PPC3100 with Intel Kabylake-U				
73	C-3965U 2C 2.2GHz 2MB 15W	2 x 8192 MB DDR4 2133MHz	Intel HD Graphics 610	B&R
74	i3-7100U 2C 2.4GHz 3MB 15W	2 x 8192 MB DDR4 2133MHz	Intel HD Graphics 620	B&R

#	CPU	RAM	VGA controller	Manuf.
75	i5-7300U 2C 2.6GHz 3MB 15W	2 x 8192 MB DDR4 2133MHz	Intel HD Graphics 620	B&R
76	i7-7600U 2C 2.8GHz 4MB 15W	2 x 8192 MB DDR4 2133MHz	Intel HD Graphics 620	B&R
APC2200/PPC2200 with Intel Apollo Lake				
77	E3930 2C 1.30GHz 2MB 6.5W 2GB	1 x 2048 MB LPDDR4 2133MHz	Intel HD Graphics (IGFXGen9)	B&R
78	E3930 2C 1.30GHz 2MB 6.5W 4GB	1 x 4096 MB LPDDR4 2133MHz	Intel HD Graphics (IGFXGen9)	B&R
79	E3940 4C 1.60GHz 2MB 9.5W 4GB	1 x 4096 MB LPDDR4 2133MHz	Intel HD Graphics (IGFXGen9)	B&R
80	E3940 4C 1.60GHz 2MB 9.5W 8GB	2 x 4096 MB LPDDR4 2133MHz	Intel HD Graphics (IGFXGen9)	B&R

Table 4: Devices being tested

2.2 Hard disks / removable devices

#	Name	Storage capacity	Rotary speed / cache	Manufacturer
ICP5000C hard disks				
1	Slide-In HD MHK2060AT	5.6 GB	4200 (rpm) / 512 KB	Fujitsu/B&R
APC620 hard disks				
2	Add-On HD MHT2020AC	20 GB	4200 (rpm) / 2MB	Fujitsu/B&R
3	Add-On HD MHT2030AR	30 GB	4200 (rpm) / 2 MB	Fujitsu/B&R
4	Slide-In HD MHT2020AC	20 GB	4200 (rpm) / 2 MB	Fujitsu/B&R
5	Slide-In HD MHT2030AR	30 GB	4200 (rpm) / 2 MB	Fujitsu/B&R
6	Travelstar	40 GB	7200 (rpm) / 8 MB	Hitachi
Reference hard disk				
7	ST340014A	40 GB	7200 (rpm) / 2 MB	Seagate
APC810 hard disks				
8	ST940817SM	40GB	5400 (U/min) / 8 MB	Seagate
Compact Flash cards				
9	5CFCRD.1024-03	1 GB	-	B&R
10	5CFCRD.1043-04	1 GB	-	B&R
APC910/PPC900 SSD				
11	5AC901.CSSD-01	60GB	-	INTEL
12	5AC901.CSSD-04	128GB	-	Toshiba
ACP2100/PPC2100 CFast				
13	5CFAST.064G-10	64GB	-	Innodisk
ACP3100/PPC3100 CFast				
14	5CFAST.032G-10	32GB	-	Swissbit

Table 5: Hard disks and removable devices used

3 Software

The following software products were used for the tests:

3.1 Benchmark programs

#	Name	Manufacturer	WEB link
1	Sandra 2002 Prof	Sisoft	http://www.sisoftware.net/
2	Sandra 2005 SR1 Lite	Sisoft	http://www.sisoftware.net/
3	PCMark2002	MadOnion.com Inc.	http://www.futuremark.com/
4	PCMark04	Futuremark Coperation	http://www.futuremark.com/
5	WinBench99	ZD Net/Ziff-Davis	http://www.zdnet.de/
6	HDTACH V2.70	Simpli Software	http://www.simplisoftware.com/
7	3D Mark 2000	MadOnion.com Inc.	http://www.futuremark.com/
8	3D Mark 2001SE	MadOnion.com Inc.	http://www.futuremark.com/
9	B&R Automation Runtime	B&R	http://www.br-automation.com
10	B&R Automation Runtime AR106	B&R	http://www.br-automation.com
11	Sandra Pro Business 2007	Sisoft	http://www.sisoftware.net/
12	Sandra 2011 Lite	SiSoft	http://www.sisoftware.net/
13	Performance Test 7.0	Passmark	http://www.passmark.com

Table 6: Benchmark programs used and the corresponding WEB links

3.2 Operating system

- Windows 98 was used as the operating system for IPC2001 computers.
- Microsoft Windows XP Professional SP2 or SP3 was used for all other computers.
- Microsoft Windows 7 Ultimate (32 or 64Bit, depending on the CPU) was used for the Sisoft Sandra 2011 and Passmark Performance Test 7 on APC910/PPC900.
- Microsoft Windows 8.1 Industry (32 or 64Bit, depending on the CPU or rather memory size) was used for the Sisoft Sandra 2011 and Passmark Performance Test 7 on APC2100/PPC2100.
- Microsoft Windows 10 LTSC 2016 64Bit was used for the Passmark Performance Test 7 on APC3100/PPC3100 and APC2200/PPC2200.

4 Results

4.1 Sisoft Sandra 2002 Prof

Sisoft Sandra provides many different tests.

For this reason, Sandra has become a very popular benchmark program and is used in nearly all performance tests.

4.1.1 CPU arithmetic

Here, the program determines the maximum number of operations per second. The result is output in MIPS (Million Instructions per Second).

At the same time, the maximum number of floating point operations per second is also determined. The result is shown in MFLOPS (Million Floating Point Operations per Second).

#	Test device	Dhrystone ALU (MIPS)	Whetstone FPU (MFLOPS)
VIA CPUs			
	VIA M6000, 600MHz	771 ¹	210 ¹
	VIA M10000, 1000 MHz	1592 ¹	367 ¹
Power Panel 100/200			
15	Geode 266 MHz, 128 MB RAM	329	202
IPC2001 computer			
16	AMD 486DX2 66 MHz 8 MB DRAM	85	30
17	AMD 486DX5 133 MHz 32 MB DRAM	169	60
IPC5000C computer			
18	Celeron 3 566 MHz, 256 MB SDRAM	1513	765
19	Celeron 3 850 MHz, 256 MB SDRAM	2267	1149
20	Pentium 3 600 MHz, 256 MB SDRAM	1614	810
21	Pentium 3 850 MHz, 256 MB SDRAM	2267	1149
APC680 with INTEL 815E chipset			
22	Celeron 3 850 MHz, 256 MB SDRAM	2283	1147
23	Pentium 3 1.26 GHz, 256 MB SDRAM	3482	1697
APC620 with INTEL 815E chipset			
24	Celeron 3 400 MHz, 256 MB SDRAM	1086	529
25	Celeron 3 733 MHz, 512 MB SDRAM	2002	976
26	Celeron 3 1 GHz, 256 MB SDRAM	2751	1340
APC620 with INTEL 855GME chipset			
27	Celeron M 600 MHz, 256 MB DDR-SDRAM	2008	1170
28	Celeron M 1 GHz, 256 MB DDR-SDRAM	3533	1948
29	Pentium M 1.1 GHz, 1GB DDR-SDRAM	4580	2149
30	Pentium M 1.4 GHz, 512 MB DDR-SDRAM	4945	2732
31	Pentium M 1.6 GHz, 1GB DDR-SDRAM	5363	3124
32	Pentium M 1.8 GHz, 512 MB DDR-SDRAM	6370	3511
Other test computers			
33	Pentium 4 2.4 GHz, 512 MB DDR-SDRAM	4634	2955
34	Pentium 4 2.6 GHz, 512 MB DDR-SDRAM	5168	3305
Power Panel 300/400			

¹ Source: Tolly Group

#	Test device	Dhystone ALU (MIPS)	Whetstone FPU (MFLOPS)
28	AMD Geode LX800, 256 MB DDR-SDRAM	792	291

Table 7: Results for Sisoft Sandra 2002 Prof CPU arithmetic

Sisoft Sandra 2002 Prof. CPU Arithmetic Test

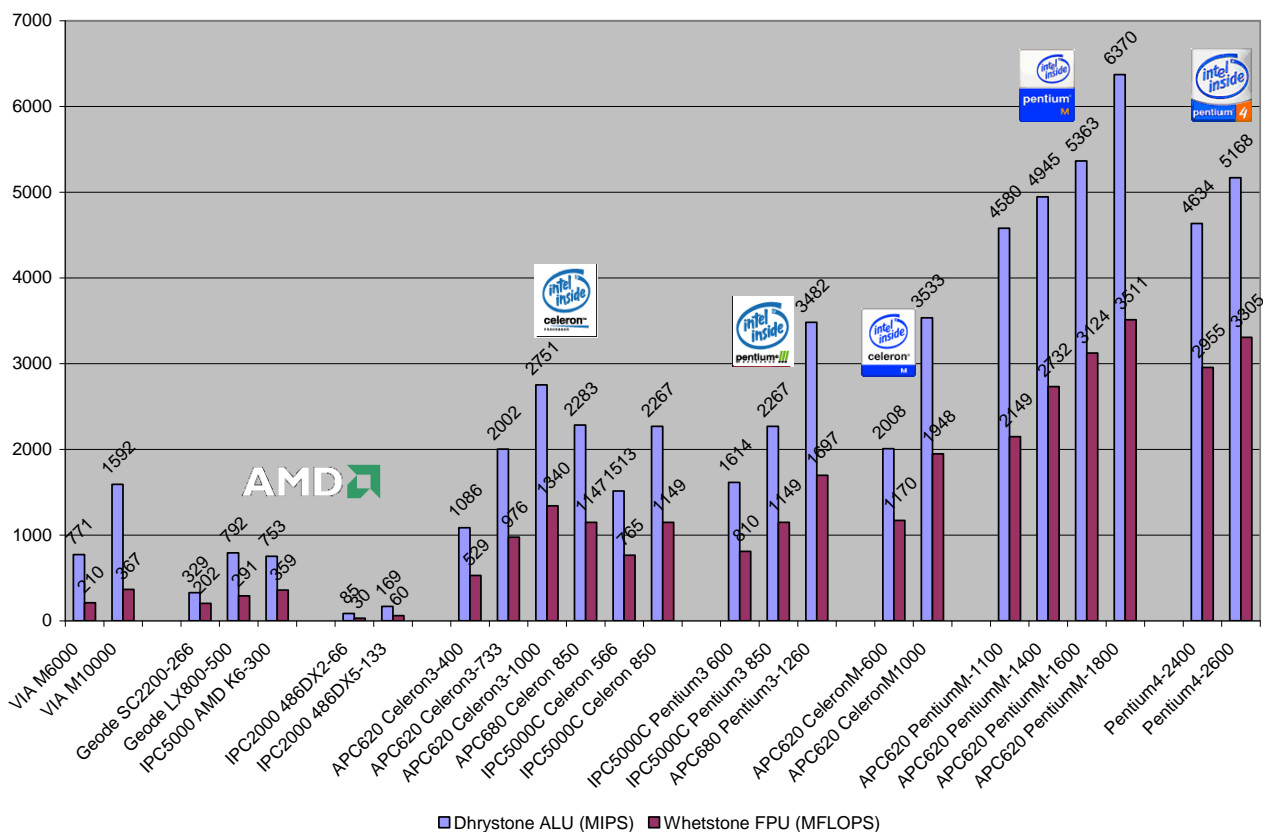

Figure 1 - Results for Sisoft Sandra 2002 Prof CPU arithmetic

4.1.2 CPU multimedia

This test determines the multimedia performance of the CPU. During this test, the speed and performance are checked for the technologies used, such as MMX, SSE, SSE2 (depending on the processor).

#	Test device	Integer (it/s)	Floating Point (it/s)
VIA CPUs			
	VIA M6000, 600MHz	874 ²	1196 ²
	VIA M10000, 1000 MHz	2255 ²	1196 ²
Power Panel 100/200			
1	Geode 266 MHz, 128 MB RAM	412	118
IPC2001 computer			
2	AMD 486DX2 66 MHz 8 MB DRAM	22	18
3	AMD 486DX5 133 MHz 32 MB DRAM	44	36
IPC5000C computer			
4	Celeron 3 566 MHz, 256 MB SDRAM	3084	3772
5	Celeron 3 850 MHz, 256 MB SDRAM	4628	5661
6	Pentium 3 600 MHz, 256 MB SDRAM	3265	3995
7	Pentium 3 850 MHz, 256 MB SDRAM	4629	5663
APC680 with INTEL 815E chipset			
8	Celeron 3 850 MHz, 256 MB SDRAM	4621	5654
9	Pentium 3 1.26 GHz, 256 MB SDRAM	6884	8545
APC620 with INTEL 815E chipset			
10	Celeron 3 400 MHz, 256 MB SDRAM	2147	2665
11	Celeron 3 733 MHz, 512 MB SDRAM	3957	4913
12	Celeron 3 1 GHz, 256 MB SDRAM	4652	6153
APC620 with INTEL 855GME chipset			
13	Celeron M 600 MHz, 256 MB DDR-SDRAM	2662	3839
14	Celeron M 1 GHz, 256 MB DDR-SDRAM	4284	6381
15	Pentium M 1.1 GHz, 1GB DDR-SDRAM	4814	7038
16	Pentium M 1.4 GHz, 512 MB DDR-SDRAM	6009	8951
17	Pentium M 1.6 GHz, 1GB DDR-SDRAM	7002	10254
18	Pentium M 1.8 GHz, 512 MB DDR-SDRAM	7724	11504
Other test computers			
19	Pentium 4 2.4 GHz, 512 MB DDR-SDRAM	9386	11608
20	Pentium 4 2.6 GHz, 512 MB DDR-SDRAM	10400	12905
Power Panel 300/400			
28	AMD Geode LX800, 256 MB DDR-SDRAM	777	950

Table 8: Results for Sisoft Sandra 2002 Prof CPU multimedia

² Source: Tolly Group

Sisoft Sandra 2002 Prof. CPU Multimedia

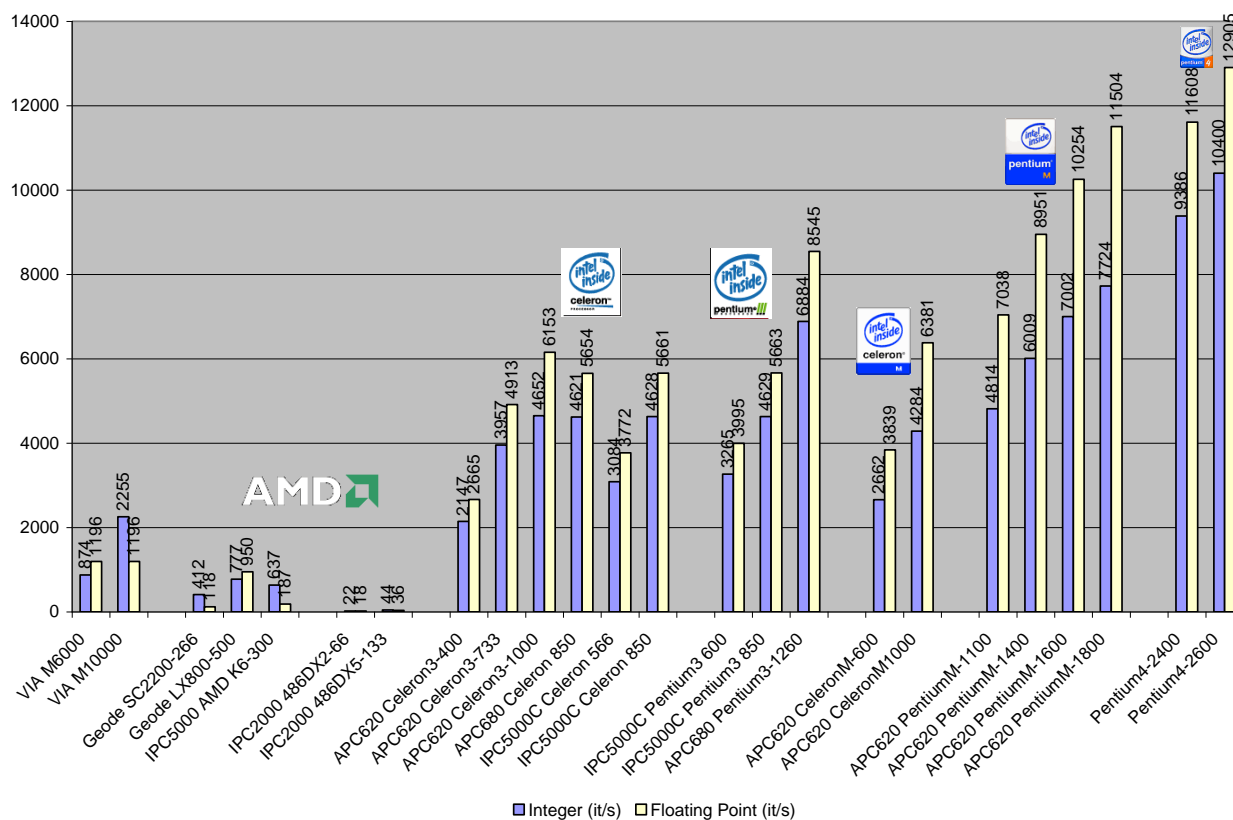

Figure 2 – Results for Siisoft Sandra 2002 Prof CPU multimedia

4.1.3 Memory bandwidth

The performance of the system memory (main memory) is determined here. This is done by transferring a large amount of data. The result is the maximum "memory throughput" in MB/s.

#	Test device	RAM Bandwidth ALU (MB/s)	RAM Bandwidth FPU (MB/s)
VIA CPUs			
	VIA M6000, 600MHz	215 ³	243 ³
	VIA M10000, 1000 MHz	215 ³	243 ³
Power Panel 100/200			
1	Geode 266 MHz, 128 MB RAM	101	95
IPC2001 Rechner			
2	AMD 486DX2 66 MHz 8 MB DRAM	29	30
3	AMD 486DX5 133 MHz 32 MB DRAM	35	37
IPC5000C computer			
4	Celeron 3 566 MHz, 256 MB SDRAM	429	455
5	Celeron 3 850 MHz, 256 MB SDRAM	428	428
6	Pentium 3 600 MHz, 256 MB SDRAM	427	428
7	Pentium 3 850 MHz, 256 MB SDRAM	558	428
APC680 with INTEL 815E chipset			
8	Celeron 3 850 MHz, 256 MB SDRAM	584	570
9	Pentium 3 1.26 GHz, 256 MB SDRAM	762	752
APC620 with INTEL 815E chipset			
10	Celeron 3 400 MHz, 256 MB SDRAM	409	401
11	Celeron 3 733 MHz, 512 MB SDRAM	675	664
12	Celeron 3 1 GHz, 256 MB SDRAM	650	646
APC620 with INTEL 855GME chipset			
13	Celeron M 600 MHz, 256 MB DDR-SDRAM	1326	1340
14	Celeron M 1 GHz, 256 MB DDR-SDRAM	1395	1401
15	Pentium M 1.1 GHz, 1GB DDR-SDRAM	1353	1372
16	Pentium M 1.4 GHz, 512 MB DDR-SDRAM	1396	1401
17	Pentium M 1.6 GHz, 1GB DDR-SDRAM	1439	1411
18	Pentium M 1.8 GHz, 512 MB DDR-SDRAM	1601	1600
Other test computers			
19	Pentium 4 2.4 GHz, 512 MB DDR-SDRAM	1973	1948
20	Pentium 4 2.6 GHz, 512 MB DDR-SDRAM	3201	3206
Power Panel 300/400			
28	AMD Geode LX800, 256 MB DDR-SDRAM	404	334

Table 9: Results for Sisoft Sandra 2002 Prof CPU memory bandwidth

³ Source: Tolly Group

Sisoft Sandra 2002 Prof. Memory Bandwidth

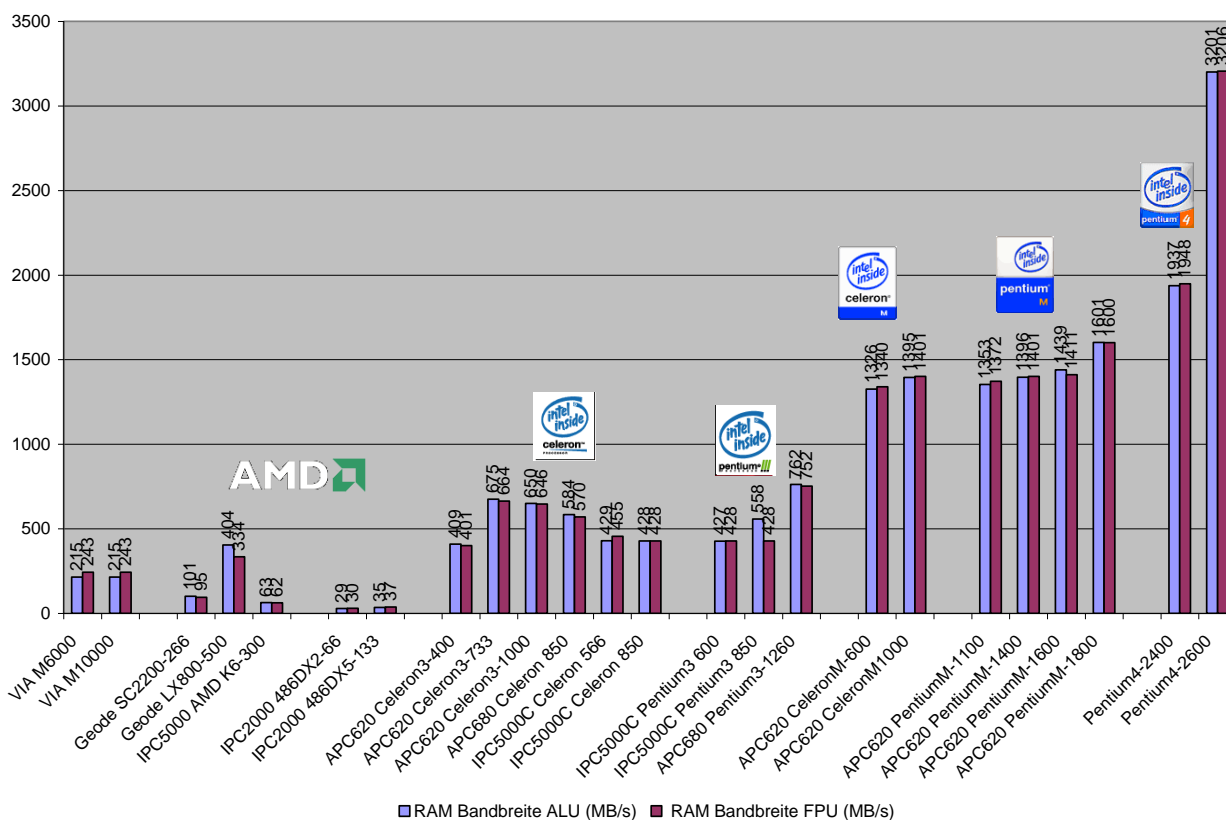

Figure 3 – Results for Siisoft Sandra 2002 Prof memory bandwidth

4.2 Sisoft Sandra 2005 SR1

Sisoft Sandra 2005 is the most current version of Sandra and supports the newest technologies (such as SSE3).

4.2.1 CPU arithmetic

Here, the program determines the maximum number of operations per second. The result is output in MIPS (Million Instructions per Second).

At the same time, the maximum number of floating point operations per second is also determined. The result is shown in MFLOPS (Million Floating Point Operations per Second).

#	Test device	Dhrystone ALU (MIPS)	Whetstone FPU (MFLOPS)
Power Panel 100/200			
1	Geode 266 MHz, 128 MB RAM	407	170
IPC5000C computer			
4	Celeron 3 566 MHz, 256 MB SDRAM	1928	743
5	Celeron 3 850 MHz, 256 MB SDRAM	2896	1122
6	Pentium 3 600 MHz, 256 MB SDRAM	2019	788
7	Pentium 3 850 MHz, 256 MB SDRAM	2913	1128
APC680 with INTEL 815E chipset			
8	Celeron 3 850 MHz, 256 MB SDRAM	2901	1119
9	Pentium 3 1.26 GHz, 256 MB SDRAM	4348	1731
APC620 with INTEL 815E chipset			
10	Celeron 3 400 MHz, 256 MB SDRAM	1344	536
11	Celeron 3 733 MHz, 512 MB SDRAM	2483	989
12	Celeron 3 1 GHz, 256 MB SDRAM	3432	1367
APC620 with INTEL 855GME chipset			
13	Celeron M 600 MHz, 256 MB DDR-SDRAM	2481	1064
14	Celeron M 1 GHz, 256 MB DDR-SDRAM	4304	1776
15	Pentium M 1.1 GHz, 1GB DDR-SDRAM	4580	1532
16	Pentium M 1.4 GHz, 512 MB DDR-SDRAM	6035	1947
17	Pentium M 1.6 GHz, 1GB DDR-SDRAM	6566	2844
18	Pentium M 1.8 GHz, 512 MB DDR-SDRAM	7758	3204
Other test computers			
19	Pentium 4 2.4 GHz, 512 MB DDR-SDRAM	6325	3212
20	Pentium 4 2.6 GHz, 512 MB DDR-SDRAM	7044	3577
Power Panel 300/400			
28	AMD Geode LX800, 256 MB DDR-SDRAM	1022	277

Table 10: Results for Sisoft Sandra 2005 SR1 CPU arithmetic

Sisoft Sandra 2005 SR1 CPU Arithmetic

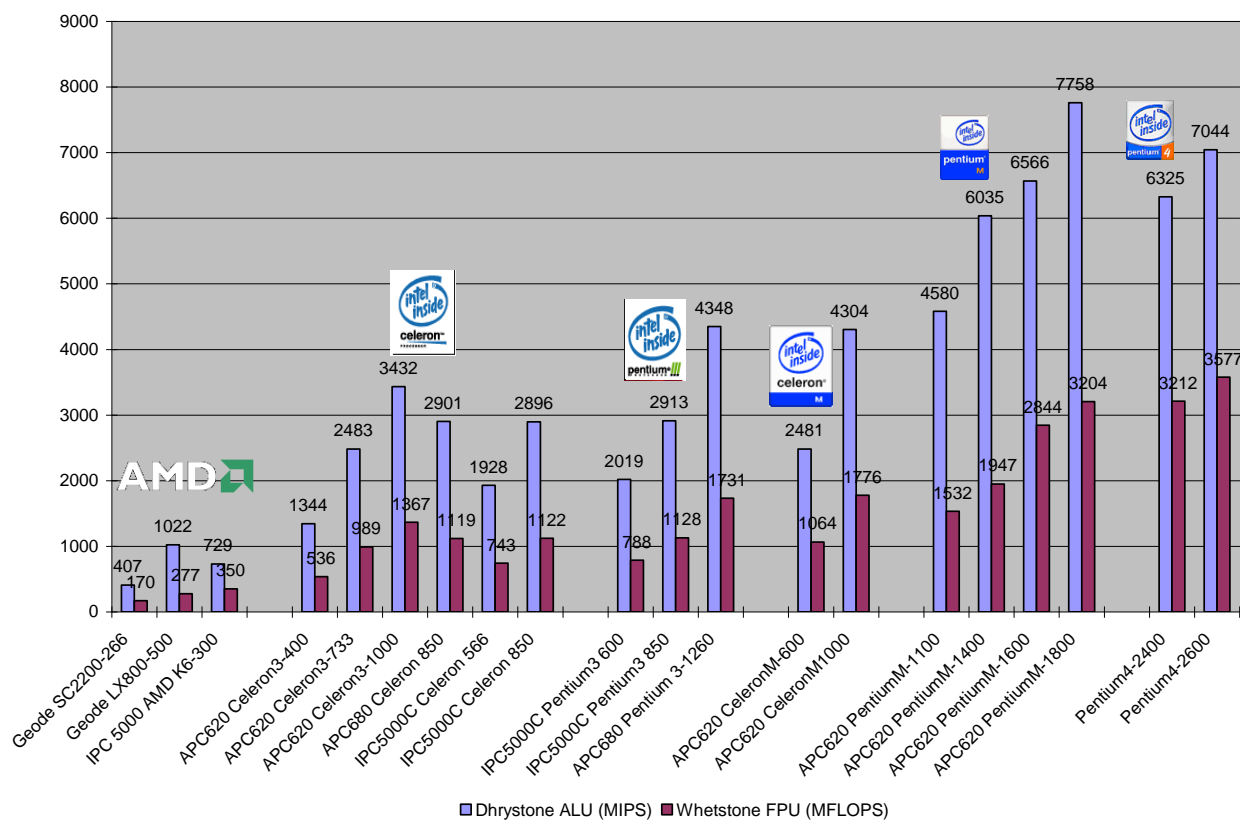

Figure 4 – Results for Sisoft Sandra 2005 SR1 CPU arithmetic

Information:

IPC2001 computers are not included in this test because Sisoft Sandra 2005 SR1 is not supported by Windows 98.

4.2.2 CPU multimedia

This test determines the multimedia performance of the CPU. During this test, the speed and performance are checked for the technologies used, such as MMX, SSE, SSE2, SSE3 (depending on the processor).

#	Test device	Integer (it/s)	Floating Point (it/s)
Power Panel 100/200			
1	Geode 266 MHz, 128 MB RAM	733	156
IPC5000C computer			
4	Celeron 3 566 MHz, 256 MB SDRAM	4621	5820
5	Celeron 3 850 MHz, 256 MB SDRAM	6959	8755
6	Pentium 3 600 MHz, 256 MB SDRAM	4910	6159
7	Pentium 3 850 MHz, 256 MB SDRAM	6985	8789
APC680 with INTEL 815E chipset			
8	Celeron 3 850 MHz, 256 MB SDRAM	6978	8788
9	Pentium 3 1.26 GHz, 256 MB SDRAM	11053	13311
APC620 with INTEL 815E chipset			
10	Celeron 3 400 MHz, 256 MB SDRAM	3419	4118
11	Celeron 3 733 MHz, 512 MB SDRAM	6314	7601
12	Celeron 3 1 GHz, 256 MB SDRAM	8721	10502
APC620 with INTEL 855GME chipset			
13	Celeron M 600 MHz, 256 MB DDR-SDRAM	5696	6258
14	Celeron M 1 GHz, 256 MB DDR-SDRAM	9523	10490
15	Pentium M 1.1 GHz, 1GB DDR-SDRAM	10475	11522
16	Pentium M 1.4 GHz, 512 MB DDR-SDRAM	13349	14707
17	Pentium M 1.6 GHz, 1GB DDR-SDRAM	15228	16755
18	Pentium M 1.8 GHz, 512 MB DDR-SDRAM	17159	18904
Other test computers			
19	Pentium 4 2.4 GHz, 512 MB DDR-SDRAM	14676	18351
20	Pentium 4 2.6 GHz, 512 MB DDR-SDRAM	16464	20635
Power Panel 300/400			
28	AMD Geode LX800, 256 MB DDR-SDRAM	1323	1721

Table 11: Results for Sisoft Sandra 2005 SR1 CPU multimedia

Sisoft Sandra 2005 SR1 CPU Multimedia

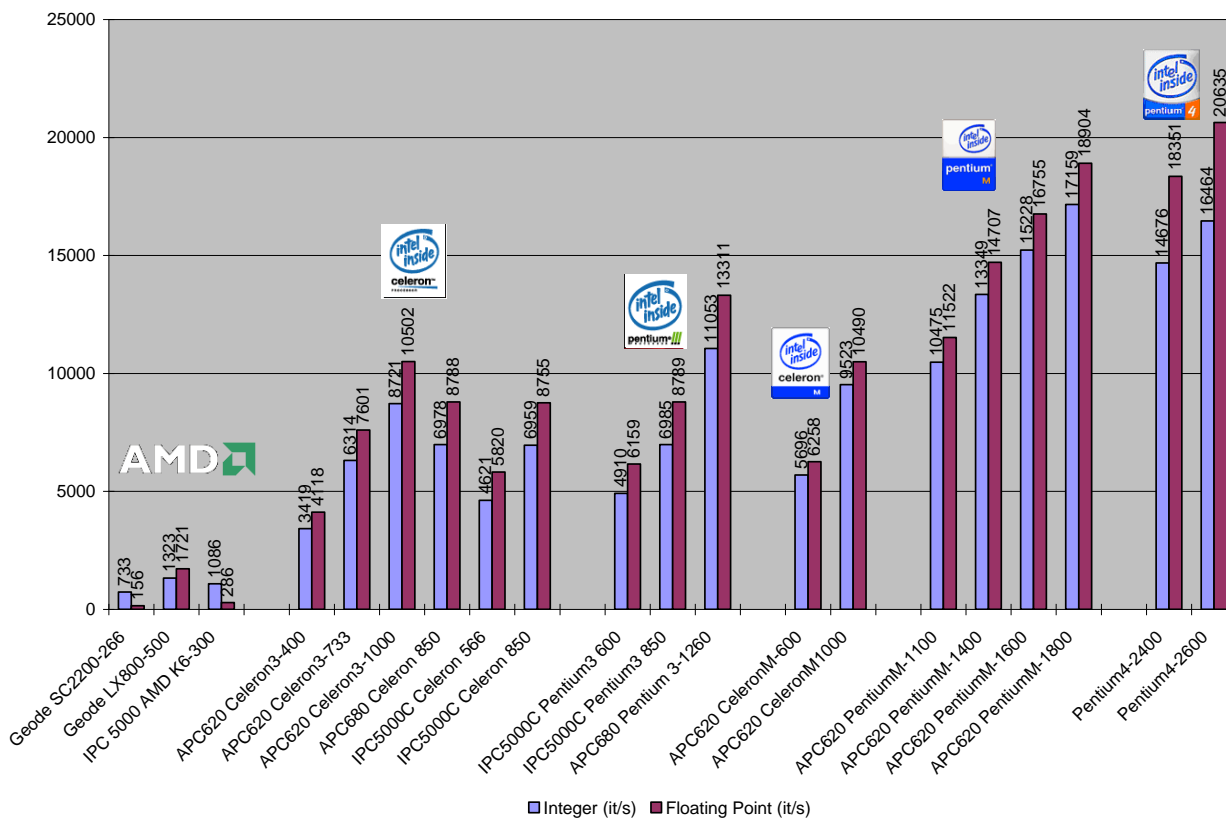

Figure 5 – Results for Sisoft Sandra 2005 SR1 CPU multimedia

Information:

IPC2001 computers are not included in this test because Sisoft Sandra 2005 SR1 is not supported by Windows 98.

4.2.3 Memory bandwidth

The performance of the system memory (main memory) is determined here. This is done by transferring a large amount of data. The result is the maximum "memory throughput" in MB/s.

#	Test device	RAM Bandwidth ALU (MB/s)	RAM Bandwidth FPU (MB/s)
Power Panel 100/200			
1	Geode 266 MHz, 128 MB RAM	96	92
IPC5000C computer			
4	Celeron 3 566 MHz, 256 MB SDRAM	425	449
5	Celeron 3 850 MHz, 256 MB SDRAM	558	428
6	Pentium 3 600 MHz, 256 MB SDRAM	503	428
7	Pentium 3 850 MHz, 256 MB SDRAM	428	429
APC680 with INTEL 815E chipset			
8	Celeron 3 850 MHz, 256 MB SDRAM	585	570
9	Pentium 3 1.26 GHz, 256 MB SDRAM	753	742
APC620 with INTEL 815E chipset			
10	Celeron 3 400 MHz, 256 MB SDRAM	407	401
11	Celeron 3 733 MHz, 512 MB SDRAM	610	601
12	Celeron 3 1 GHz, 256 MB SDRAM	700	694
APC620 with INTEL 855GME chipset			
13	Celeron M 600 MHz, 256 MB DDR-SDRAM	1761	1761
14	Celeron M 1 GHz, 256 MB DDR-SDRAM	1751	1754
15	Pentium M 1.1 GHz, 1GB DDR-SDRAM	1713	1705
16	Pentium M 1.4 GHz, 512 MB DDR-SDRAM	1824	1820
17	Pentium M 1.6 GHz, 1GB DDR-SDRAM	1942	1949
18	Pentium M 1.8 GHz, 512 MB DDR-SDRAM	1977	1977
Other test computers			
19	Pentium 4 2.4 GHz, 512 MB DDR-SDRAM	1983	1987
20	Pentium 4 2.6 GHz, 512 MB DDR-SDRAM	3204	3211
Power Panel 300/400			
28	AMD Geode LX800, 256 MB DDR-SDRAM	633	506

Table 12: Results for Sisoft Sandra 2005 SR1 CPU memory bandwidth

Sisoft Sandra 2005 SR1 Memory Bandwidth

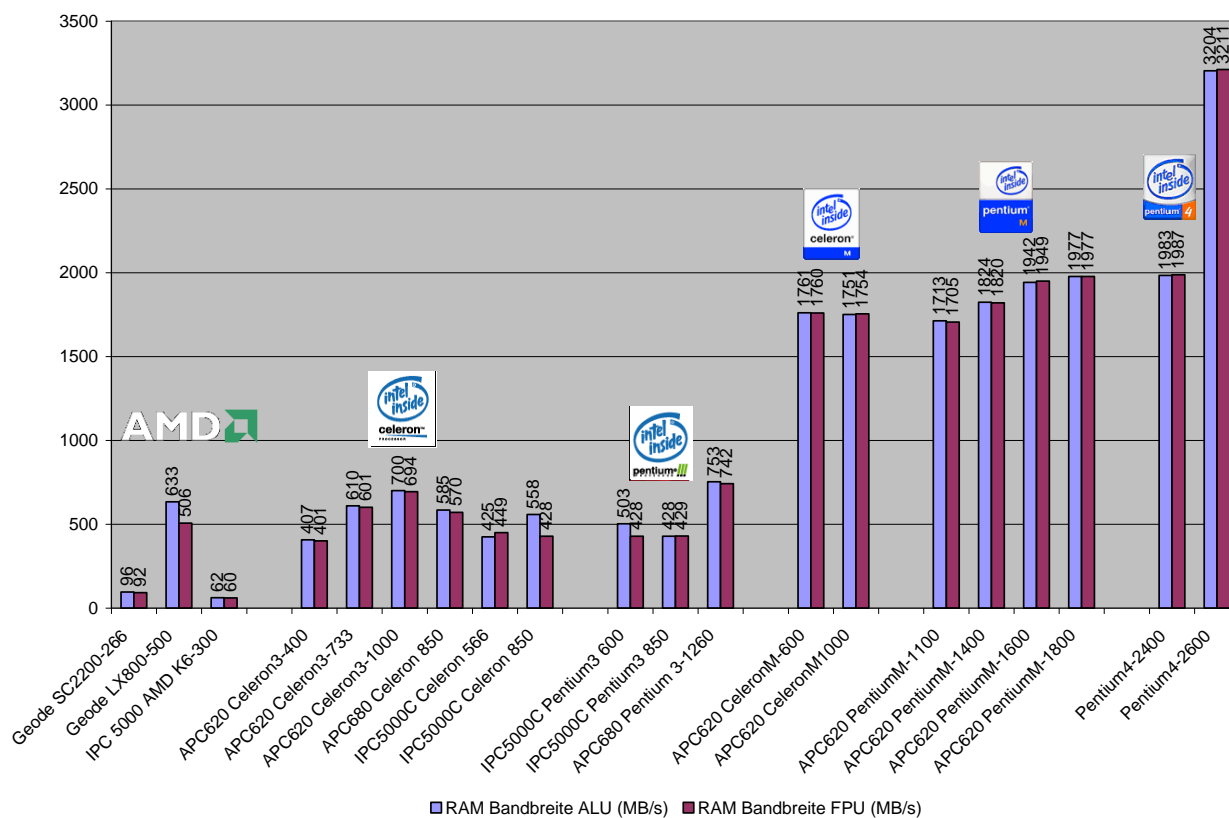

Figure 6 – Results for Sisoft Sandra 2005 SR1 Memory bandwidth

Information:

IPC2001 computers are not included in this test because Sisoft Sandra 2005 SR1 is not supported by Windows 98.

4.3 PCMark2002

PCMark2002 is a current benchmark that has many users and is therefore very good for comparing PC systems. It supports both new and older processors and, for this reason, provides a very good overview of the performance of various systems.

PCMark2002 tests the following system components:

- The CPU => both Integer and FPU
- Memory subsystems => main memory, L1 & L2 cache
- Graphics card => graphics card memory and AGP bus
- Hard drive
- Microsoft Windows XP GUI (Graphic User Interface)
- Video performance and quality
- Laptop battery (if PC Mark is being used on a laptop)

#	Test device	CPU (points)	Memory (points)
VIA CPUs			
	VIA M6000, 600MHz	584 ⁴	677 ⁴
	VIA M10000, 1000 MHz	1119 ⁴	869 ⁴
Power Panel			
1	Geode 266 MHz, 128 MB RAM	284	354
IPC5000C computer			
4	Celeron 3 566 MHz, 256 MB SDRAM	1480	737
5	Celeron 3 850 MHz, 256 MB SDRAM	2142	1045
6	Pentium 3 600 MHz, 256 MB SDRAM	1649	991
7	Pentium 3 850 MHz, 256 MB SDRAM	2256	1145
APC680 with INTEL 815E chipset			
8	Celeron 3 850 MHz, 256 MB SDRAM	1992	958
9	Pentium 3 1.26 GHz, 256 MB SDRAM	3892	2036
APC620 with INTEL 815E chipset			
10	Celeron 3 400 MHz, 256 MB SDRAM	1227	762
11	Celeron 3 733 MHz, 512 MB SDRAM	2225	1126
12	Celeron 3 1 GHz, 256 MB SDRAM	2968	1187
APC620 with INTEL 855GME chipset			
13	Celeron M 600 MHz, 256 MB DDR-SDRAM	1964	2593
14	Celeron M 1 GHz, 256 MB DDR-SDRAM	3314	3201
15	Pentium M 1.1 GHz, 1GB DDR-SDRAM	3572	3710
16	Pentium M 1.4 GHz, 512 MB DDR-SDRAM	4705	4694
17	Pentium M 1.6 GHz, 1GB DDR-SDRAM	5246	4727
18	Pentium M 1.8 GHz, 512 MB DDR-SDRAM	6070	6121
Other test computers			
19	Pentium 4 2.4 GHz, 512 MB DDR-SDRAM	5772	4849
20	Pentium 4 2.6 GHz, 512 MB DDR-SDRAM	6519	6678

Table 13: Results for PCMark2002

⁴ Source: Tolly Group

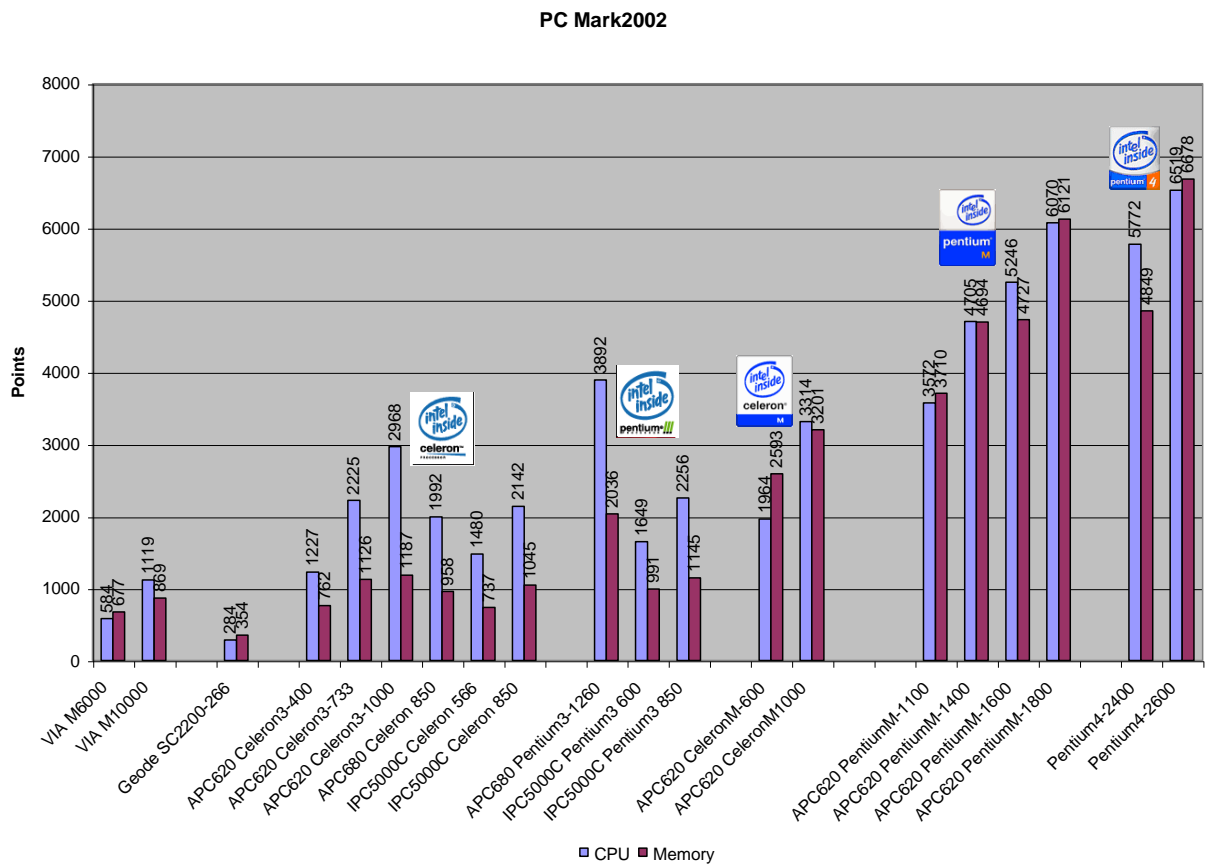

Figure 7 – Results for PCMark2002

Information:

IPC2001 computers are not included in this test because PCMark2002 requires at least a CPU with MMX technology.

4.4 PCMark04

PCMark04 is a benchmark from the newest generation. This program tests and supports the newest technologies (e.g. HT, SSE3) and takes the system to the limit of its performance.

The test criteria for PCMark04 are similar to the ones for PCMark2002.

All components tested with PCMark2002 are also tested with PCMark2004, however PCMark2004 determines the results with the help of coding and decoding processes for the individual media codecs (e.g. DivX, WMV Codec, etc.)

The manufacturer explicitly states that the test results from PCMark2002 and PCMark04 are not (!!!) comparable!

In addition, all systems can no longer be tested with this program.

The system must meet the following requirements (and others):

- Intel or AMD processor > 1 GHz
- At least 128 MB RAM
- Full DirectX 7 compatible graphics card
- Windows Media Player 9.0 + MS Encoder 9.0
- Microsoft Internet Explorer 6

#	Test device	Points
Power Panel		
1	Geode 266 MHz, 128 MB RAM	Not supported
IPC5000C computer		
4	Celeron 3 566 MHz, 256 MB SDRAM	Not supported
5	Celeron 3 850 MHz, 256 MB SDRAM	Not supported
6	Pentium 3 600 MHz, 256 MB SDRAM	Not supported
7	Pentium 3 850 MHz, 256 MB SDRAM	Not supported
APC680 computer		
8	Celeron 3 850 MHz, 256 MB SDRAM	Not supported
9	Pentium 3 1.26 GHz, 256 MB SDRAM	Not supported
APC620 with INTEL 815 E chipset		
10	Celeron 3 400 MHz, 256 MB SDRAM	Not supported
11	Celeron 3 733 MHz, 512 MB SDRAM	Not supported
12	Celeron 3 1000 MHz, 256 MB SDRAM	Not supported
APC620 with INTEL 855GME chipset		
13	Celeron M 600 MHz, 256 MB DDR-SDRAM	1326
14	Celeron M 1 GHz, 256 MB DDR-SDRAM	1826
15	Pentium M 1.1 GHz, 1 GB DDR-SDRAM	1961
16	Pentium M 1.4 GHz, 512 MB DDR-SDRAM	2461
17	Pentium M 1.6 GHz, 1GB DDR-SDRAM	2640
18	Pentium M 1.8 GHz, 512 MB DDR-SDRAM	2993
Other test computers		
19	Pentium 4 2.4 GHz, 512 MB DDR-SDRAM	2608
20	Pentium 4 2.6 GHz, 512 MB DDR-SDRAM	3452

Table 14: Results for PCMark04

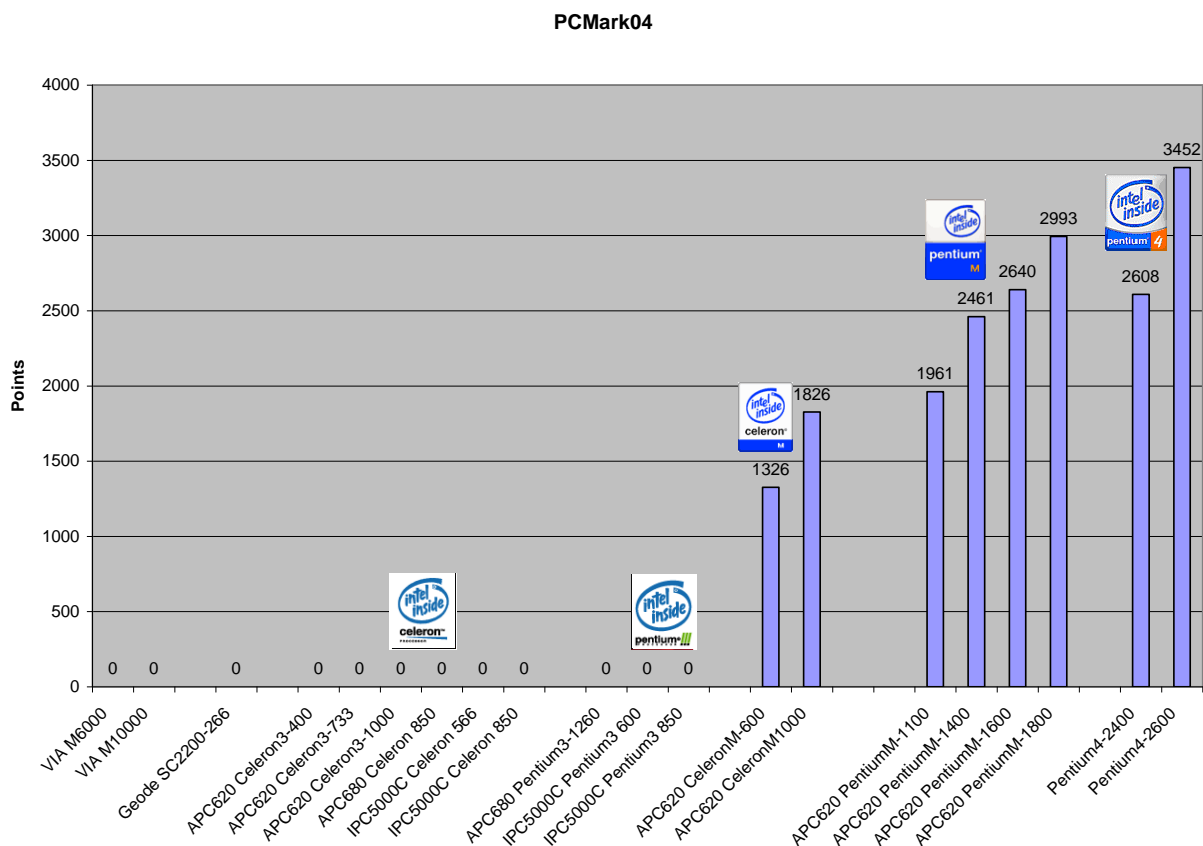

Figure 8 – Results for PCMark04

Information:

PCMark04 requires a graphics card that is fully DirectX7 compatible. This requirement is only met by the APC620 computers with an Intel 855GME chipset. Therefore there are no test results for Power Panel, IPC2001, IPC5000C, APC680 and APC620 (with Intel 815 E).

4.5 WinBench99

WinBench99 was developed together with ZD Net. However, the development was stopped in the middle of 2000.

Up to that point, WinBench was an important tool for comparing the performance measurements of PC systems. WinBench99 offers many subprograms that analyze certain aspects of the systems.

This program was used to create comparison values for "older" systems.

4.5.1 CPUMark99

CPUMark99 is a test that determines the computing power of the CPU. All arithmetic units on the CPU. As a result, the program calculates a number of points that can be used for further comparison.

#	Test device	Points
Power Panel		
1	Geode 266 MHz, 128 MB RAM	7.08
IPC2001 computer		
2	AMD 486DX2 66MHz, 8MB DRAM	3.21
3	AMD 486DX5 133 MHz, 32 MB DRAM	4.19
IPC5000C computer		
4	Celeron 3 566 MHz, 256 MB SDRAM	43.6
5	Celeron 3 850 MHz, 256 MB SDRAM	64.7
6	Pentium 3 600 MHz, 256 MB SDRAM	56.9
7	Pentium 3 850 MHz, 256 MB SDRAM	76.1
APC680 computer		
8	Celeron 3 850 MHz, 256 MB SDRAM	57.2
9	Pentium 3 1.26 GHz, 256 MB SDRAM	112
APC620 with INTEL 815 E chipset		
10	Celeron 3 400 MHz, 256 MB SDRAM	37.3
11	Celeron 3 733 MHz, 512 MB SDRAM	64.1
12	Celeron 3 1000 MHz, 256 MB SDRAM	85.8
APC620 with INTEL 855GME chipset		
13	Celeron M 600 MHz, 256 MB DDR-SDRAM	66.4
14	Celeron M 1 GHz, 256 MB DDR-SDRAM	111
15	Pentium M 1.1 GHz, 1 GB DDR-SDRAM	127
16	Pentium M 1.4 GHz, 512 MB DDR-SDRAM	171
17	Pentium M 1.6 GHz, 1GB DDR-SDRAM	184
18	Pentium M 1.8 GHz, 512 MB DDR-SDRAM	220
Other test computers		
19	Pentium 4 2.4 GHz, 512 MB DDR-SDRAM	Not supported
20	Pentium 4 2.6 GHz, 512 MB DDR-SDRAM	Not supported

Table 15: Results for WinBench99 CPUMark99

Winbench99 CPUMark99

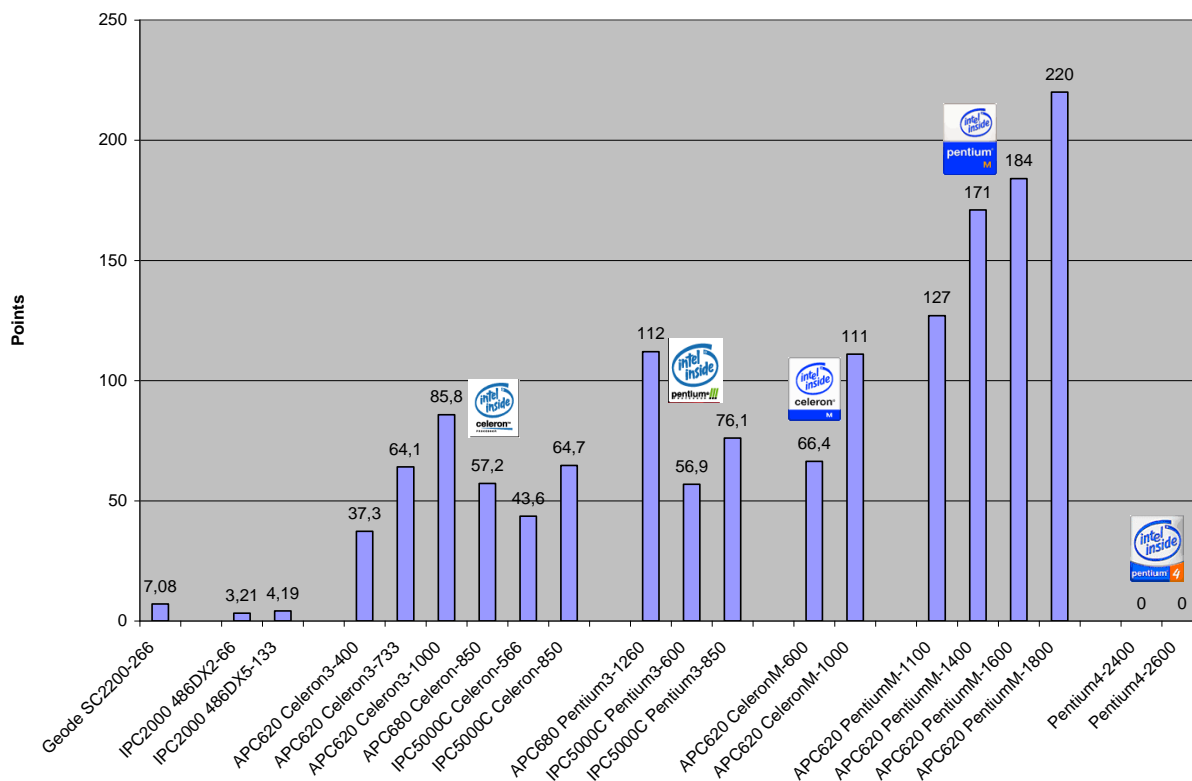

Figure 9 – Results for WinBench99 CPUMark99

Information:

Winbench99 could not be executed on Pentium 4 systems because the program had a problem with the CPU frequency.

4.5.2 FPUWinMark

As a special feature, FPUWinMark tests the FPU of the CPU being used. The speed and computing power, among other things, are determined. As a test result, the program calculates a number of points that can be used for further comparison.

#	Test device	Points
Power Panel		
1	Geode 266 MHz, 128 MB RAM	488
IPC2001 computer		
2	AMD 486DX2 66MHz, 8MB DRAM	93.5
3	AMD 486DX5 133 MHz, 32 MB DRAM	180
IPC5000C computer		
4	Celeron 3 566 MHz, 256 MB SDRAM	3000
5	Celeron 3 850 MHz, 256 MB SDRAM	4410
6	Pentium 3 600 MHz, 256 MB SDRAM	3190
7	Pentium 3 850 MHz, 256 MB SDRAM	4510
APC680 computer		
8	Celeron 3 850 MHz, 256 MB SDRAM	4510
9	Pentium 3 1.26 GHz, 256 MB SDRAM	6890
APC620 with INTEL 815E chipset		
10	Celeron 3 400 MHz, 256 MB SDRAM	2160
11	Celeron 3 733 MHz, 512 MB SDRAM	3950
12	Celeron 3 1000 MHz, 256 MB SDRAM	5430
APC620 with INTEL 855GME chipset		
13	Celeron M 600 MHz, 256 MB DDR-SDRAM	3310
14	Celeron M 1 GHz, 256 MB DDR-SDRAM	5590
15	Pentium M 1.1 GHz, 1 GB DDR-SDRAM	6100
16	Pentium M 1.4 GHz, 512 MB DDR-SDRAM	7830
17	Pentium M 1.6 GHz, 1GB DDR-SDRAM	8870
18	Pentium M 1.8 GHz, 512 MB DDR-SDRAM	10100
Other test computers		
19	Pentium 4 2.4 GHz, 512 MB DDR-SDRAM	Not supported
20	Pentium 4 2.6 GHz, 512 MB DDR-SDRAM	Not supported

Table 16: Results for WinBench99 FPUWinMark

WinBench99 FPUWinMark

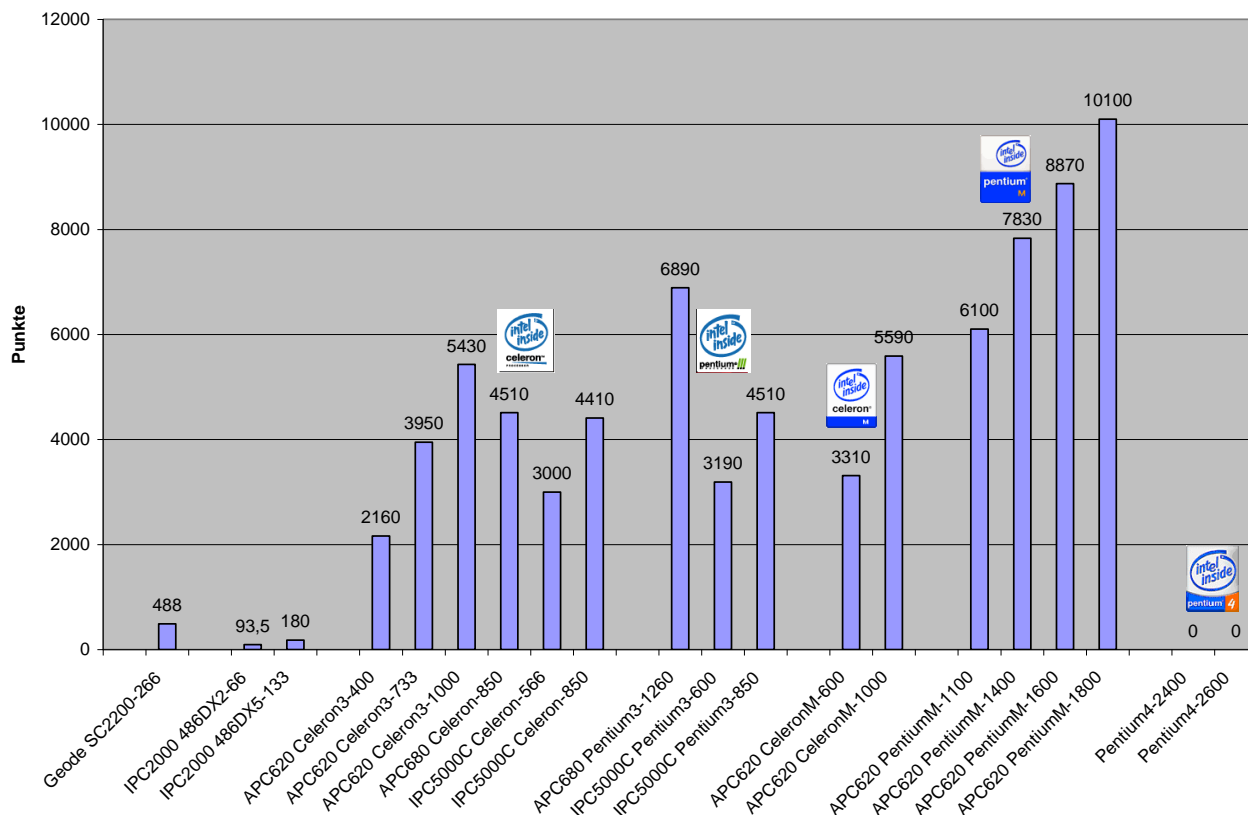

Figure 10 – Results for WinBench99 FPUWinMark

Information:

Winbench99 could not be executed on Pentium 4 systems because the program had a problem with the CPU frequency.

4.5.3 Direct Draw

With this test, the system is continually checked to determine how fast and how correct moving 2D/3D graphics are animated. All supported resolutions and color depths are determined and tested. The frames per second are measured. The maximum value reached is recorded at the end of the test report.

#	Test device	Direct Draw resolution 640x480	Direct Draw resolution 800x600
Power Panel			
1	Geode 266 MHz, 128 MB RAM	38.8	38.3
IPC2001 computer			
2	AMD 486DX2 66 MHz 8 MB DRAM	11.2	9.3
3	AMD 486DX5 133 MHz 32 MB DRAM	12.9	10.3
IPC5000C computer			
4	Celeron 3 566 MHz, 256 MB SDRAM	84.5	83
5	Celeron 3 850 MHz, 256 MB SDRAM	85.2	84.1
6	Pentium 3 600 MHz, 256 MB SDRAM	85.4	83.7
7	Pentium 3 850 MHz, 256 MB SDRAM	141	138
APC680 with INTEL 815E chipset			
8	Celeron 3 850 MHz, 256 MB SDRAM	273	265
9	Pentium 3 1.26 GHz, 256 MB SDRAM	292	288
APC620 with INTEL 815E chipset			
10	Celeron 3 400 MHz, 256 MB SDRAM	268	256
11	Celeron 3 733 MHz, 512 MB SDRAM	354	338
12	Celeron 3 1 GHz, 256 MB SDRAM	359	345
APC620 with INTEL 855GME chipset			
13	Celeron M 600 MHz, 256 MB DDR-SDRAM	542	538
14	Celeron M 1 GHz, 256 MB DDR-SDRAM	946	900
15	Pentium M 1.1 GHz, 1GB DDR-SDRAM	1190	1200
16	Pentium M 1.4 GHz, 512 MB DDR-SDRAM	1290	1290
17	Pentium M 1.6 GHz, 1GB DDR-SDRAM	1439	1411
18	Pentium M 1.8 GHz, 512 MB DDR-SDRAM	1410	1390
Other test computers			
19	Pentium 4 2.4 GHz, 512 MB DDR-SDRAM	Not supported	Not supported
20	Pentium 4 2.6 GHz, 512 MB DDR-SDRAM	Not supported	Not supported

Table 17: Results for WinBench99 Direct Draw

WinBench99 Direct Draw Test

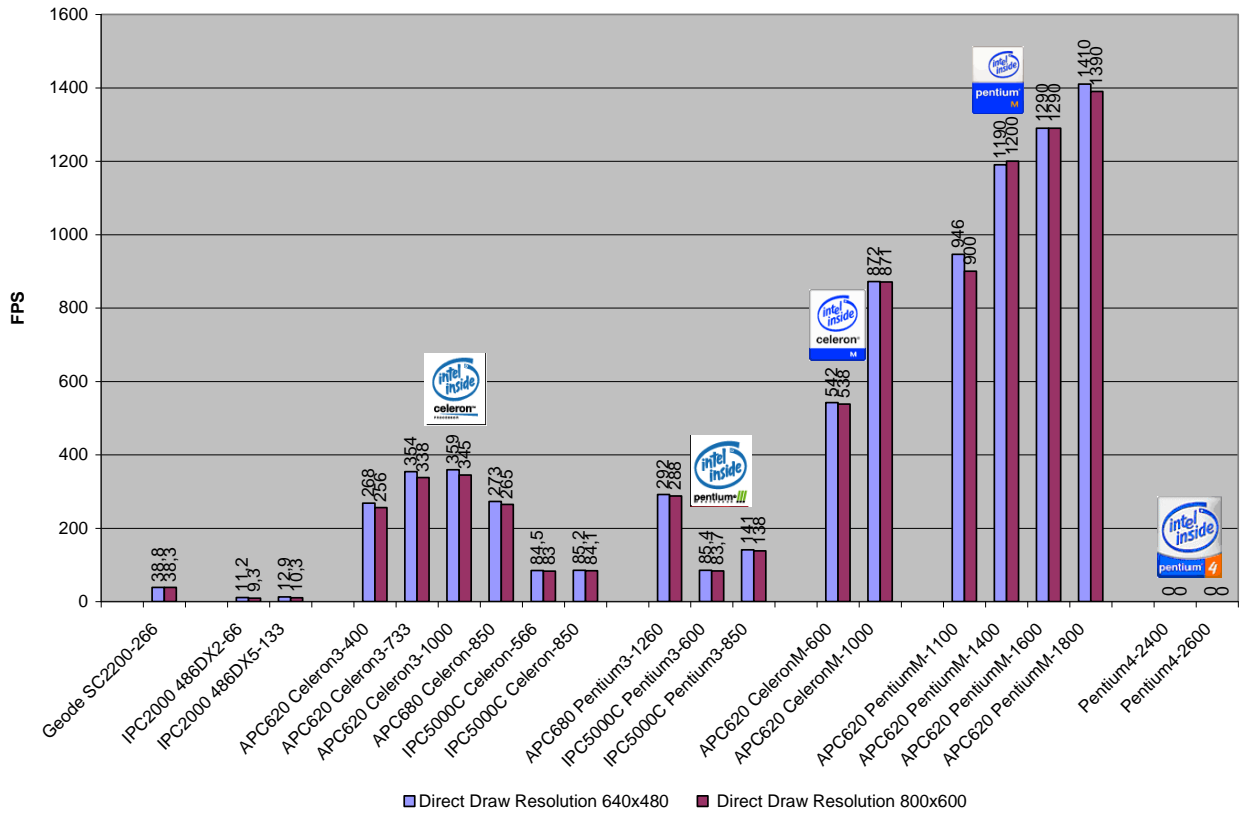

Figure 11 – Results for WinBench99 Direct Draw

Information:

Winbench99 could not be executed on Pentium 4 systems because the program had a problem with the CPU frequency.

4.5.4 Disk Inspection Test

During this test, the speed of the memory media being used (hard disk, CF, etc.) is determined. When doing this, the program writes a large amount of data to the memory and determines the data transfer rates in the individual sectors. The transfer rates reached are shown in a diagram during the test. The final result contains the maximum and the minimum data transfer rate as well as the average access time.

#	Test device	Data rate - start (MB/s)	Data rate - end (MB/s)	Access time (ms)
ICP5000C hard disks				
1	5.6 GB Fujitsu Slide-In (4200 rpm)	15.3	9.3	20.6
APC620 hard disks				
2	20 GB Fujitsu ADD ON (4200 rpm)	20.4	17.9	16
3	30 GB Fujitsu ADD ON (4200 rpm)	24.9	13.2	20
4	20 GB Fujitsu Slide-In (4200 rpm)	20.3	14	18.8
5	30 GB Fujitsu Slide-In (4200 rpm)	24.9	13.3	19.6
6	40 GB Hitachi Travelstar (7200 rpm)	60.3	31.2	13.2
Reference HDD				
7	40 GB Seagate ST340014A (7200 rpm)	Not supported	Not supported	Not supported

Table 18: Results for WinBench99 Disk Inspection Test

WinBench99 Disk Inspection Test

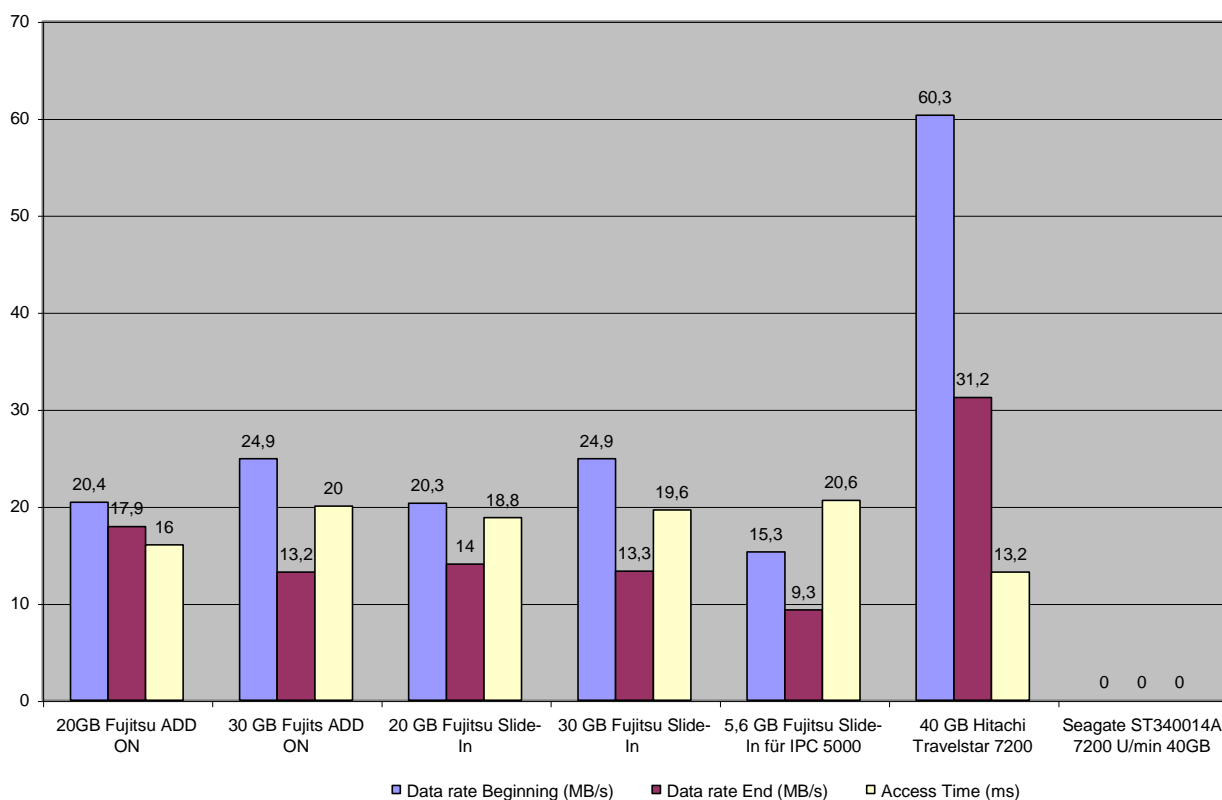

Figure 12 - Results for WinBench99 Disc Inspection Test

Information:

There are no results for the reference HDD because WinBench99 had a problem with the CPU frequency for the computer. Therefore the test could not be completed.

4.5.5 High End Disk WinMark99

This test determines the performance of the memory media under certain conditions. The program simulates individual applications (e.g. Frontpage98, VisualC++ 5.0, etc.) and determines the maximum data transfer rate in the individual environments.

As test result, the program provides the average of the data transfer rates achieved. These values can be used for comparison.

#	Test device	KBytes/s
ICP5000C hard disks		
1	5.6 GB Fujitsu Slide-In (4200 rpm)	5640
APC620 hard disks		
2	20 GB Fujitsu ADD ON (4200 rpm)	10400
3	30 GB Fujitsu ADD ON (4200 rpm)	12400
4	20 GB Fujitsu Slide-In (4200 rpm)	12400
5	30 GB Fujitsu Slide-In (4200 rpm)	13400
6	40 GB Hitachi Travelstar (7200 rpm)	22200
Reference HDD		
7	40 GB Seagate ST340014A (7200 rpm)	Not supported

Table 19: Results for WinBench99 High End Disk WinMark99

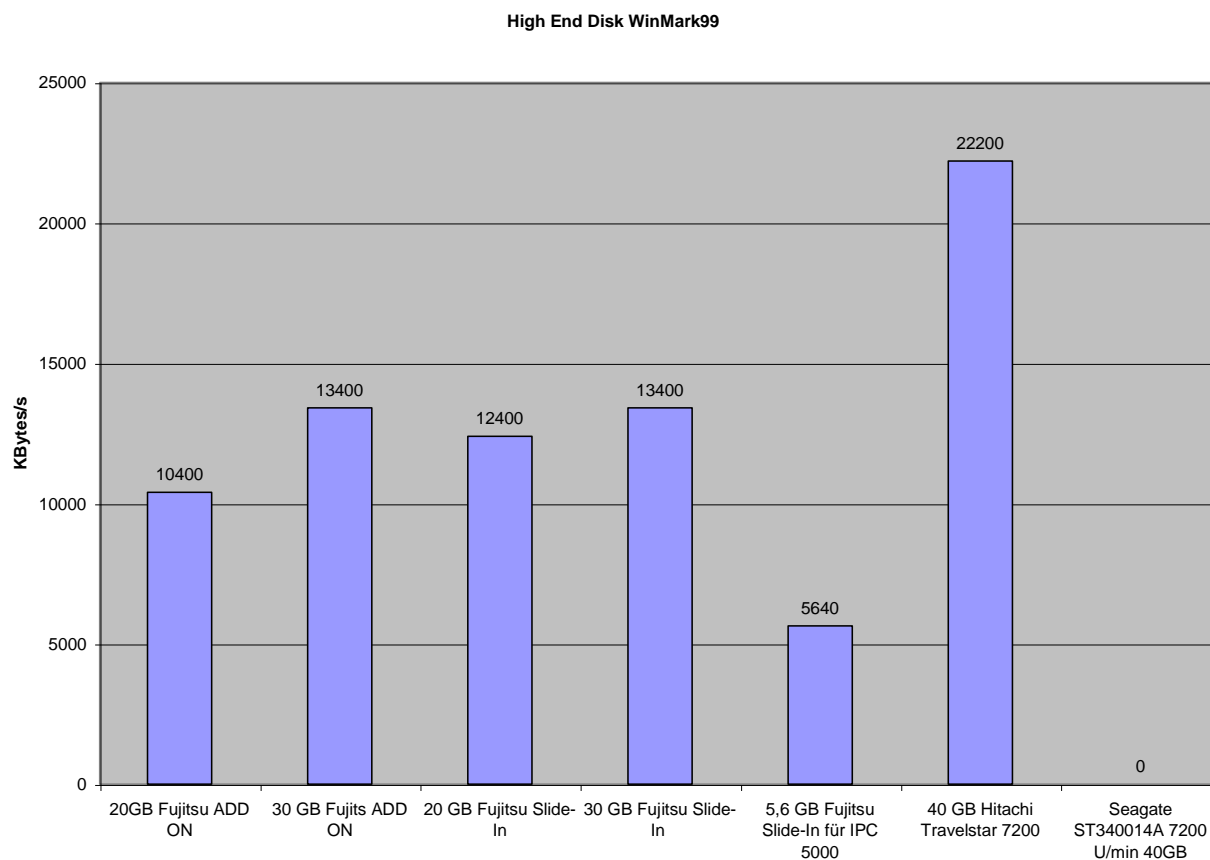

Figure 13 – Results for WinBench99 High End Disk WinMark99

Information:

There are no results for the reference HDD because WinBench99 had a problem with the CPU frequency for the computer. Therefore the test could not be completed.

4.5.6 Business Disk WinMark99

During this test, the memory media is tested especially for the performance for office and business application. As a result, an average data rate is determined that can be used for comparison.

#	Test device	KBytes/s
ICP5000C hard disks		
1	5.6 GB Fujitsu Slide-In (4200 rpm)	1730
APC620 hard disks		
2	20 GB Fujitsu ADD ON (4200 rpm)	3370
3	30 GB Fujitsu ADD ON (4200 rpm)	3370
4	20 GB Fujitsu Slide-In (4200 rpm)	3920
5	30 GB Fujitsu Slide-In (4200 rpm)	3920
6	40 GB Hitachi Travelstar (7200 rpm)	4800
Reference HDD		
7	40 GB Seagate ST340014A (7200 rpm)	Not supported

Table 20: Results for WinBench99 Business Disk Winmark99

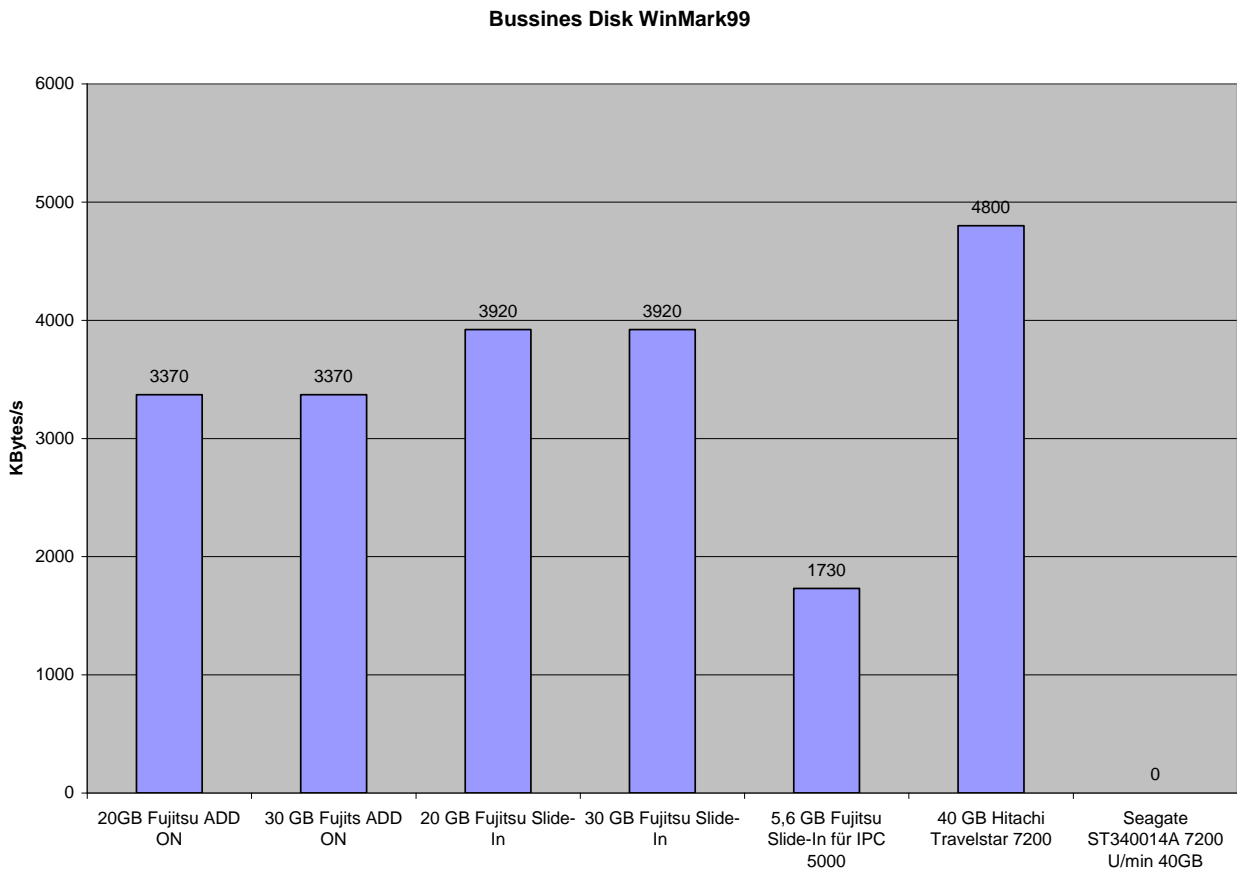

Figure 14 – Results for WinBench99 Business Disk WinMark99

Information:

There are no results for the reference HDD because WinBench99 had a problem with the CPU frequency for the computer. Therefore the test could not be completed.

4.6 HDTACH Version 2.70

HDTACH is a tool that can be used to determine the data transfer rate of memory media (e.g. hard disk). When doing this, the data is read from the media and the maximum, minimum and average data rate is output as the result.

4.6.1 HDTACH read speed

#	Test device	Maximum data rate (MB/s)	Average data rate (MB/s)	Minimum data rate (MB/s)
ICP5000C hard disks				
1	5.6 GB Fujitsu Slide-In (4200 rpm)	16	12.4	2.3
APC620 hard disks				
2	20 GB Fujitsu ADD ON (4200 rpm)	20.6	17.5	13.5
3	30 GB Fujitsu ADD ON (4200 rpm)	26	20.4	12.1
4	20 GB Fujitsu Slide-In (4200 rpm)	20.6	17.6	13.3
5	30 GB Fujitsu Slide-In (4200 rpm)	26	20.3	12.1
6	40 GB Hitachi Travelstar (7200 rpm)	39.9	34.5	26.7
Reference HDD				
7	40 GB Seagate ST340014A (7200 rpm)	62.2	47.1	30.4

Table 21: Results for HDTACH 2.70 read speed

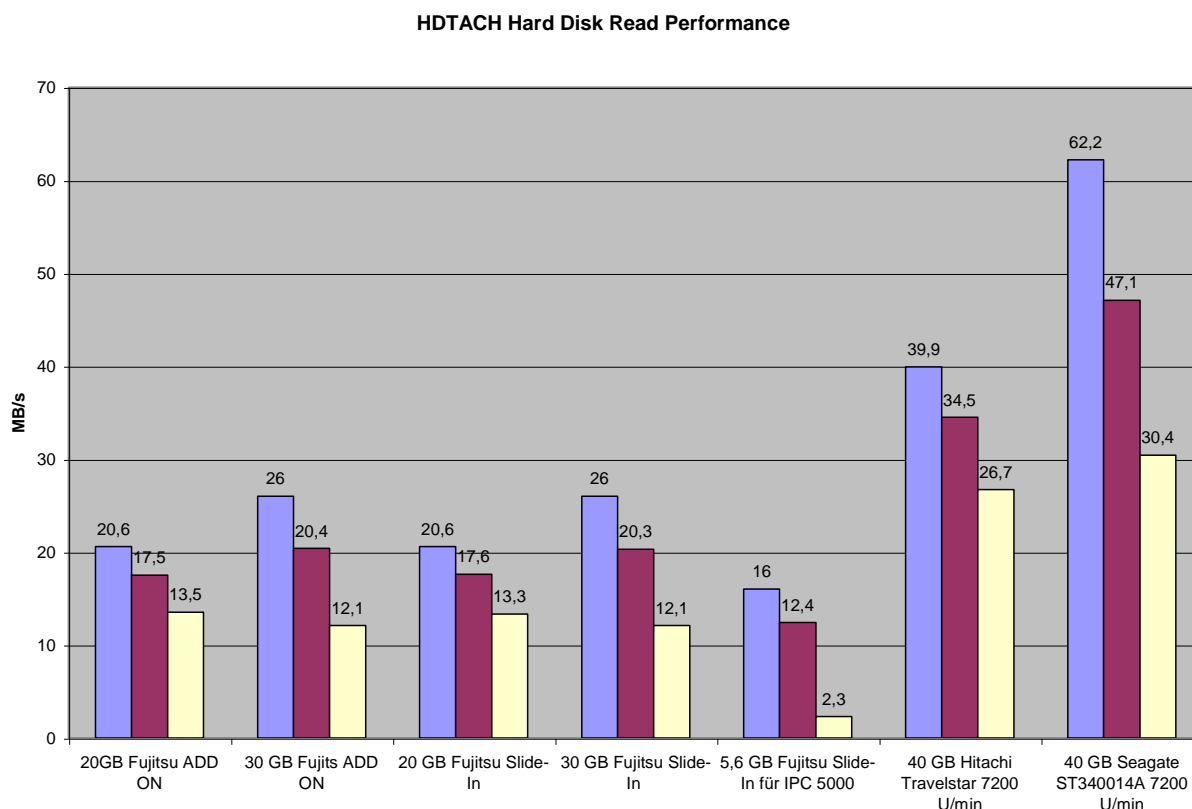

Figure 15 – Results for HDTACH read speed

4.6.2 HDTACH access time measurement

#	Test device	Access time (ms)
ICP5000C hard disks		
1	5.6 GB Fujitsu Slide-In (4200 rpm)	20.4
APC620 hard disks		
2	20 GB Fujitsu ADD ON (4200 rpm)	18.3
3	30 GB Fujitsu ADD ON (4200 rpm)	19.9
4	20 GB Fujitsu Slide-In (4200 rpm)	18.4
5	30 GB Fujitsu Slide-In (4200 rpm)	18.5
6	40 GB Hitachi Travelstar (7200 rpm)	16.7
Reference HDD		
7	40 GB Seagate ST340014A (7200 rpm)	12.5

Table 22: Results for HDTACH access time measurement

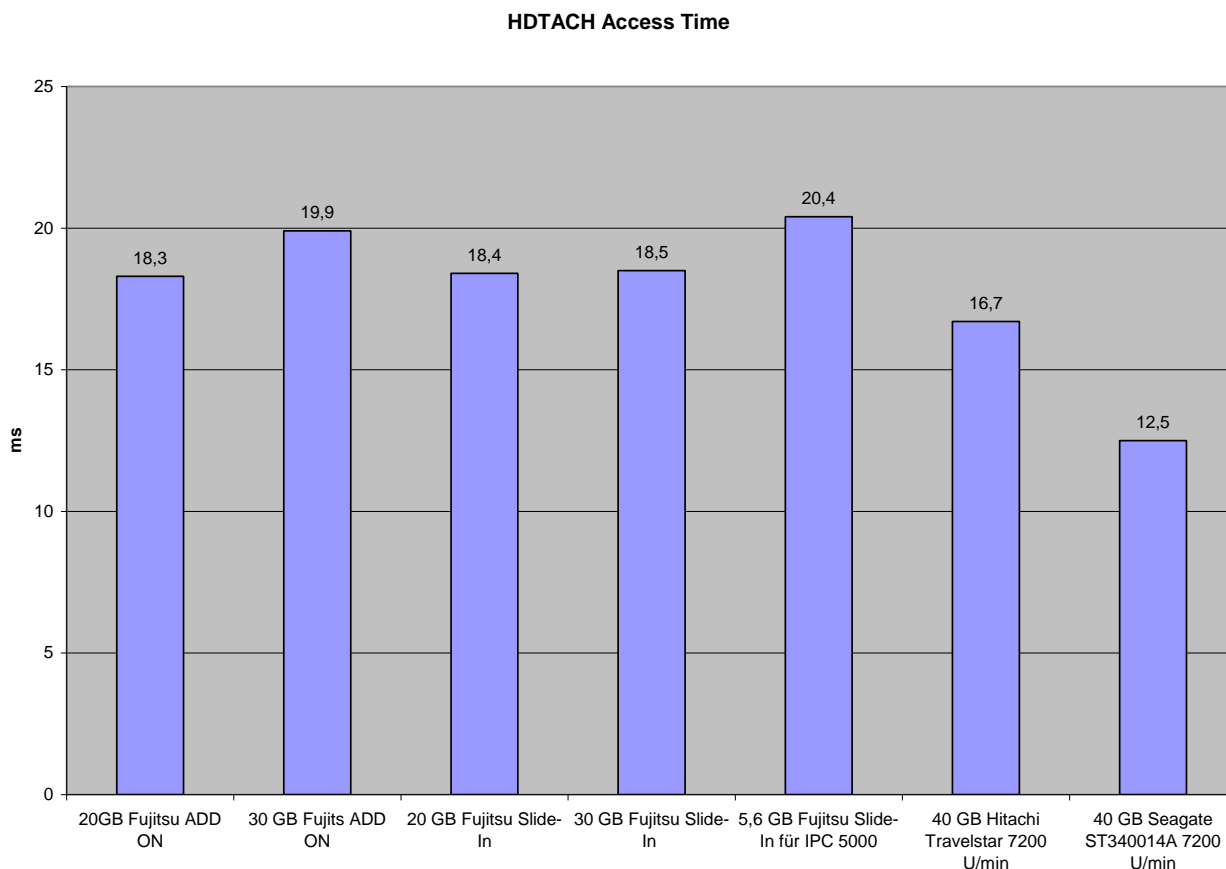

Figure 16 – Results for HDTACH access time measurement

4.7 3D Mark 2000

Originally, 3D Mark 2000 (like all later 3D Mark versions) was a benchmark that specialized on the performance of 3D games on PC systems.

However, this benchmark generally provides a very good representation of the 3D performance of a system.

For this reason, the 3D Mark line was also included in this performance test.

3D Mark 2000 does not have any special requirements (except for MMX technology) and supports a wide range of systems. This makes it possible to compare many systems and system types

#	Test device	Points
Power Panel		
1	Geode 266 MHz, 128 MB RAM	Not supported
IPC5000C computer		
4	Celeron 3 566 MHz, 256 MB SDRAM	Not supported
5	Celeron 3 850 MHz, 256 MB SDRAM	Not supported
6	Pentium 3 600 MHz, 256 MB SDRAM	Not supported
7	Pentium 3 850 MHz, 256 MB SDRAM	737
APC680 computer		
8	Celeron 3 850 MHz, 256 MB SDRAM	773
9	Pentium 3 1.26 GHz, 256 MB SDRAM	851
APC620 with INTEL 815E chipset		
10	Celeron 3 400 MHz, 256 MB SDRAM	739
11	Celeron 3 733 MHz, 512 MB SDRAM	790
12	Celeron 3 1000 MHz, 256 MB SDRAM	796
APC620 with INTEL 855GME chipset		
13	Celeron M 600 MHz, 256 MB DDR-SDRAM	3622
14	Celeron M 1 GHz, 256 MB DDR-SDRAM	4013
15	Pentium M 1.1 GHz, 1 GB DDR-SDRAM	4467
16	Pentium M 1.4 GHz, 512 MB DDR-SDRAM	4520
17	Pentium M 1.6 GHz, 1GB DDR-SDRAM	4610
18	Pentium M 1.8 GHz, 512 MB DDR-SDRAM	4768
Other test computers		
19	Pentium 4 2.4 GHz, 512 MB DDR-SDRAM	4674
20	Pentium 4 2.6 GHz, 512 MB DDR-SDRAM	11364

Table 23: Results for 3D Mark 2000

3D Mark 2000

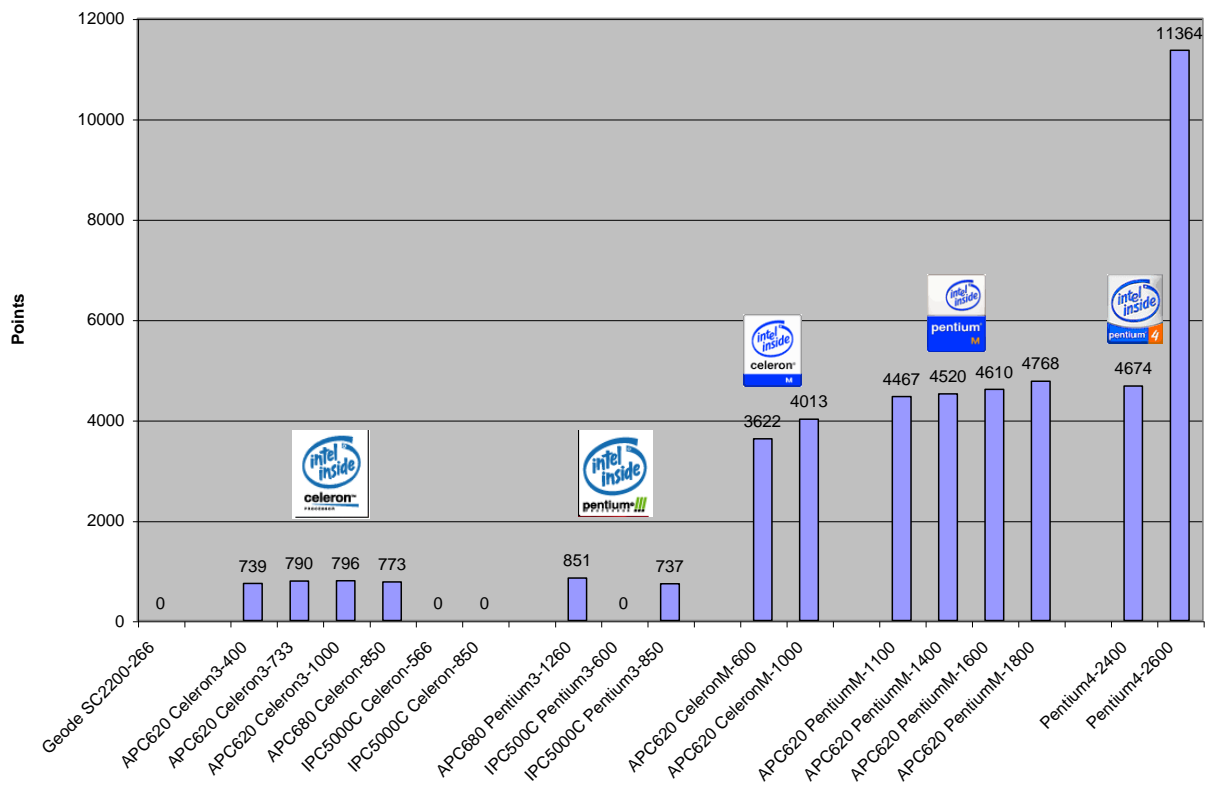

Figure 17 – Results for 3D Mark 2000

Information:

On computers without test results, the graphics controller does not meet the minimum requirements.

4.8 3D Mark 2001SE

3D Mark2001 SE is a further development of 3D Mark 2000 and supports newer technologies (SSE2) and processors (P4, etc.). The test specializes on these new technologies and therefore the benchmark cannot be used for all systems.

The results achieved provide a good comparison of the 3D performance as compared to current systems (systems with Pentium 4, Pentium M, AMD AthlonXP, etc.).

#	Test device	Points
Power Panel		
1	Geode 266 MHz, 128 MB RAM	Not supported
IPC5000C computer		
4	Celeron 3 566 MHz, 256 MB SDRAM	Not supported
5	Celeron 3 850 MHz, 256 MB SDRAM	Not supported
6	Pentium 3 600 MHz, 256 MB SDRAM	Not supported
7	Pentium 3 850 MHz, 256 MB SDRAM	Not supported
APC680 computer		
8	Celeron 3 850 MHz, 256 MB SDRAM	503
9	Pentium 3 1.26 GHz, 256 MB SDRAM	651
APC620 with INTEL 815E chipset		
10	Celeron 3 400 MHz, 256 MB SDRAM	438
11	Celeron 3 733 MHz, 512 MB SDRAM	557
12	Celeron 3 1000 MHz, 256 MB SDRAM	565
APC620 with INTEL 855GME chipset		
13	Celeron M 600 MHz, 256 MB DDR-SDRAM	1627
14	Celeron M 1 GHz, 256 MB DDR-SDRAM	1731
15	Pentium M 1.1 GHz, 1 GB DDR-SDRAM	1947
16	Pentium M 1.4 GHz, 512 MB DDR-SDRAM	2120
17	Pentium M 1.6 GHz, 1GB DDR-SDRAM	2250
18	Pentium M 1.8 GHz, 512 MB DDR-SDRAM	2383
Other test computers		
19	Pentium 4 2.4 GHz, 512 MB DDR-SDRAM	2225
20	Pentium 4 2.6 GHz, 512 MB DDR-SDRAM	9389

Table 24: Results for 3D Mark 2001SE

3D Mark 2001SE

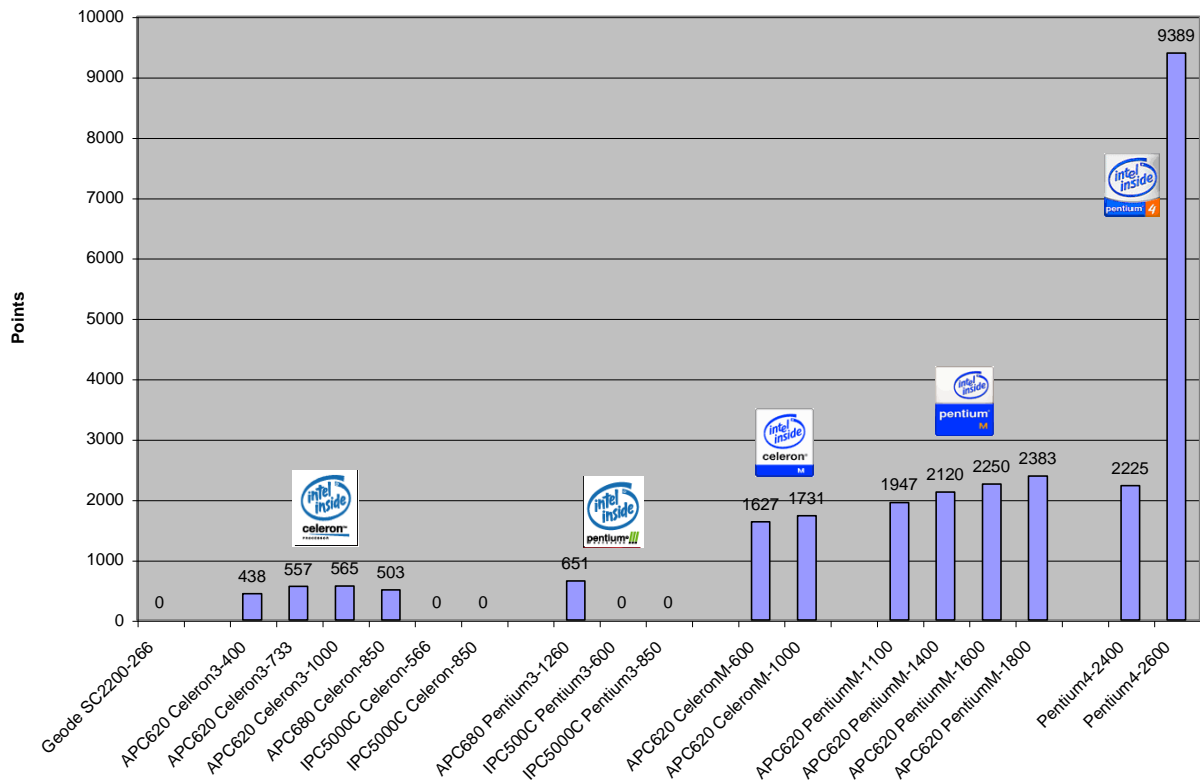

Figure 18 – Results for 3D Mark 2001SE

Information:

On computers without test results, the graphics controller does not meet the minimum requirements.

4.9 B&R Automation Runtime AR010 Version E2.82

Since the APC620 is not only used as a Windows computer, it was necessary to determine the performance using Automation Runtime. The Windows-based system AR010 Version E2.82 was used. To determine the performance of the computer, a project was created containing intensive integer and floating point operations. A visualization application was also created, which was executed in a high priority class. All tasks were executed without(!) tolerance times. This way, system overloads are recognized immediately.

The APC620 with Intel Celeron 3, 400 MHz was used as the reference device. The application was adjusted so that the computer ran at nearly 100% system load. In order to determine the system load, the B&R Profiler was used.

After the recording, only the hardware was exchanged, and the project was left the same. This allows the measurements to be easily compared with each other.

#	Test device	CPU load in percent (%)
APC620 with INTEL 815E chipset		
10	Celeron 3 400 MHz, 256 MB SDRAM	99.72
11	Celeron 3 733 MHz, 512 MB SDRAM	58.75
12	Celeron 3 1000 MHz, 256 MB SDRAM	49.08
APC620 with INTEL 855GME chipset		
13	Celeron M 600 MHz, 256 MB DDR-SDRAM	85.25
14	Celeron M 1 GHz, 256 MB DDR-SDRAM	50.53
15	Pentium M 1.1 GHz, 1 GB DDR-SDRAM	41.84
16	Pentium M 1.4 GHz, 512 MB DDR-SDRAM	37.58
17	Pentium M 1.6 GHz, 1GB DDR-SDRAM	32.96
18	Pentium M 1.8 GHz, 512 MB DDR-SDRAM	28.96

Table 25: Results for AR010 Version E2.82

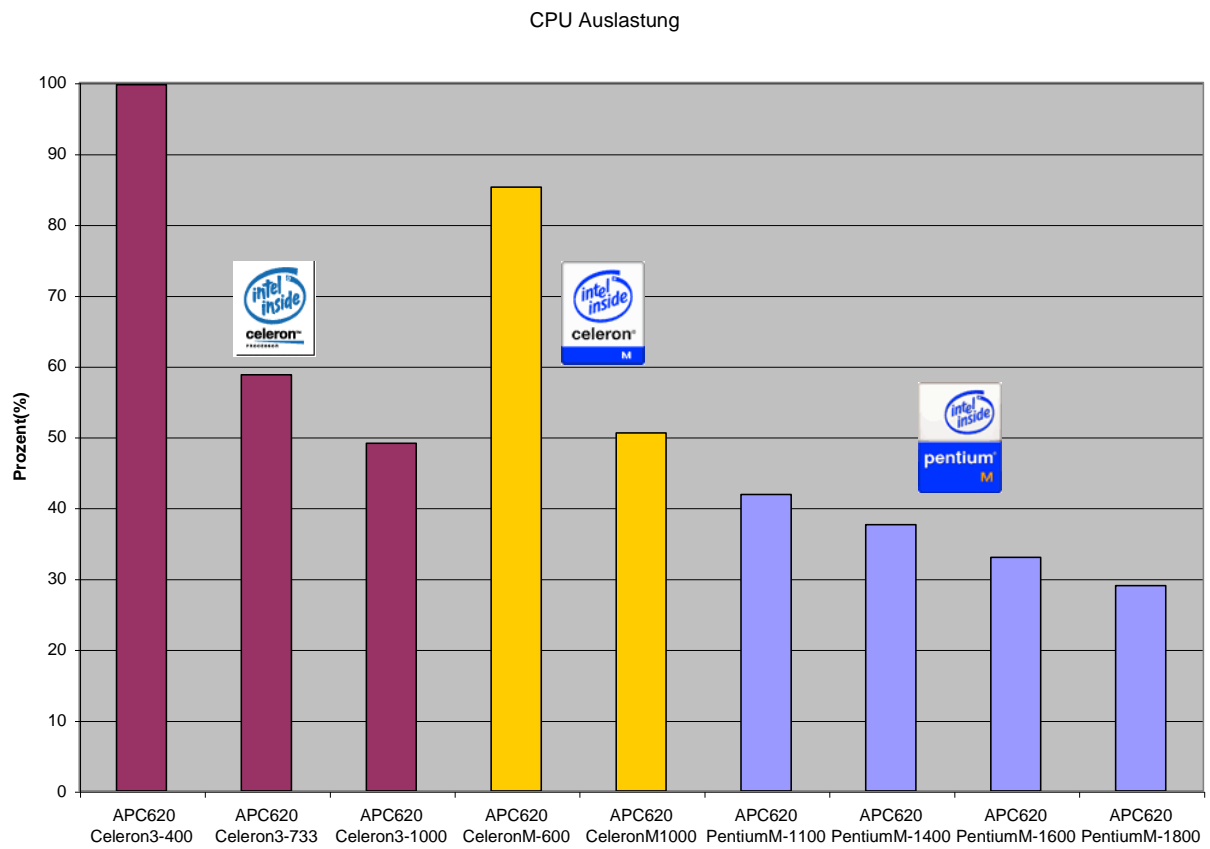
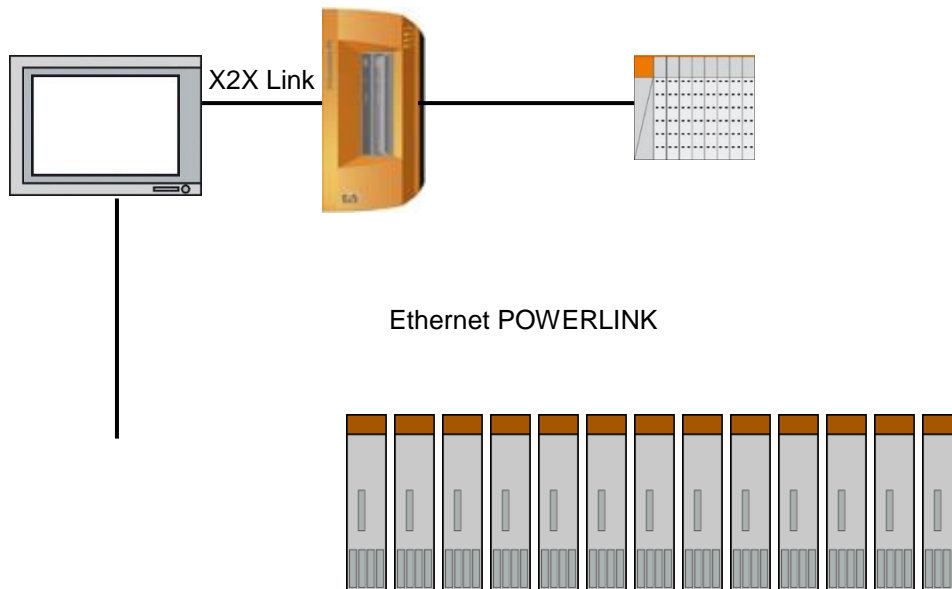

Figure 19 – B&R Automation Runtime AR010 Version E2.82

4.10 B&R Automation Runtime AR106 Version B2.83

4.10.1 Structure of the test



The following elements were used for the test:

4.10.1.1 Automation Panel AP920.1505-01

The panel was used to check that the visualization was displayed correctly

4.10.1.2 36 ACOPOS 1045 axes

To create a high computation load, 36 ACOPOS axes were operated simultaneously. Ethernet POWERLINK was used as the bus system

4.10.1.3 26 X20IOs

Since real-time applications require operation of large numbers of I/Os, the X20 I/O system was used in order to make the test realistic. All available modules were used. These included analog/digital inputs and outputs, temperature modules, and encoder/counter modules.

4.10.2 Test procedure

During this test, emphasis was placed on demonstrating the performance of the APC series as realistically as possible. An application was created that reflects realistic demands placed on a system in the field.

Not only computational performance is important, but also a large number of accesses to individual subsystems must also take place (e.g. PCI access for operating bus systems).

To create a complex load on the computer, 5 different task classes with different timings were used. Various cyclic programs were executed. The cycle times ranged from 1.6 ms in the highest priority task class #1 to 200 ms in task class #5.

A visualization application was also created containing a large number of pages.

As an additional load on the system, 36 ACOPOS axes were operated simultaneously via Ethernet POWERLINK.

The size of the project was adjusted in such a way that an APC620 with an INTEL Celeron3 400 MHz reaches a load of approximately 90%. Once the project is activated, a profiler measurement was started for a duration of one minute. Then the results of the measurement were evaluated and saved.

After the test, the CF was removed and another target system was connected. The project was left unchanged (same structure, same software) in order to achieve consistent results (the project „APC620p.pgp“ used can be found here in the benchmark folder).

4.10.3 Results

#	Test device	CPU load in percent (%)
APC620 with INTEL 815E chipset		
10	Celeron 3 400 MHz, 256 MB SDRAM	84.39
11	Celeron 3 733 MHz, 512 MB SDRAM	60.8
12	Celeron 3 1000 MHz, 256 MB SDRAM	54.35
APC620 with INTEL 855GME chipset		
13	Celeron M 600 MHz, 256 MB DDR-SDRAM	48.69
14	Celeron M 1 GHz, 256 MB DDR-SDRAM	42.07
15	Pentium M 1.1 GHz, 1 GB DDR-SDRAM	34.43
16	Pentium M 1.4 GHz, 512 MB DDR-SDRAM	33.29
17	Pentium M 1.6 GHz, 1GB DDR-SDRAM	30.14
18	Pentium M 1.8 GHz, 512 MB DDR-SDRAM	29.15

Table 26: Results for B&R AR106 Version B2.83

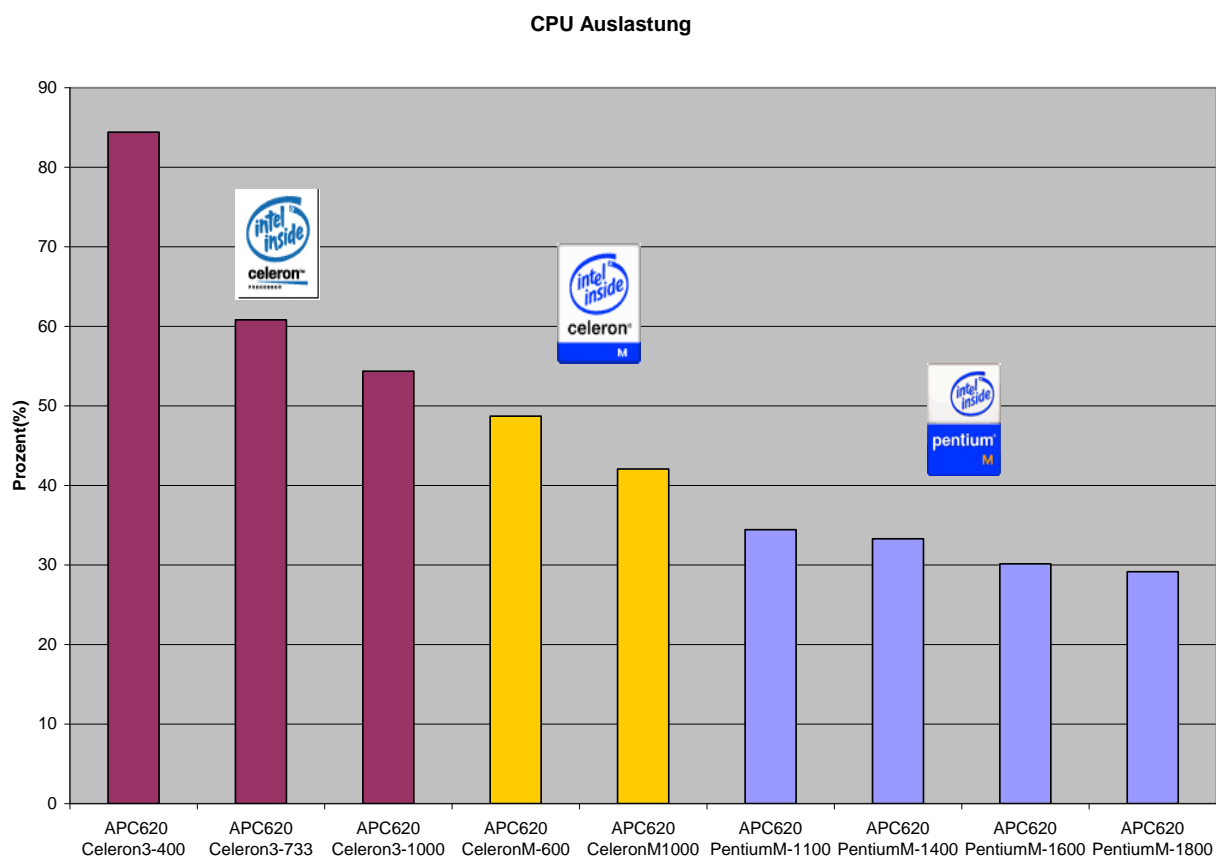

Figure 20 – B&R Automation Runtime AR106 Version B2.83

4.11 Sisoft Sandra Pro Business 2007

4.11.1 CPU arithmetic

Here, the program determines the maximum number of operations per second. The result is output in MIPS (Million Instructions per Second).

At the same time, the maximum number of floating point operations per second is also determined. The result is shown in MFLOPS (Million Floating Point Operations per Second).

#	Test device	Dhrystone ALU (MIPS)	Whetstone FPU (MFLOPS)
APC620 with INTEL 855GME chipset			
13	Celeron M 600 MHz, 512MB DDR-SDRAM	1956	1456
14	Celeron M 1000 MHz, 512MB DDR-SDRAM	3250	2429
15	Pentium M 1.1 GHz, 512MB DDR-SDRAM	3623	2697
16	Pentium M 1,4 GHz, 512MB DDR-SDRAM	4563	3409
18	Pentium M 1.8 GHz, 1024MB DDR-SDRAM	5845	4383
APC810 with INTEL 945GME chipset			
21	Celeron M 1.06 GHz, 512MB DDR2-SDRAM	3636	2680
22	Celeron M 1.06 GHz, 2x512MB DDR2-SDRAM	3636	2681
23	Core 2 Duo 1.06 GHz, 2x1024MB DDR2-SDRAM	9800	6800
24	Core 2 Duo 1.50 GHz, 2x512MB DDR2-SDRAM	13764	9554
25	Core Duo 1.66 GHz, 2x1024MB DDR2-SDRAM	11348	8398
26	Core 2 Duo 2.16 GHz, 1024MB DDR2-SDRAM	19846	13778
27	Core 2 Duo 2.16 GHz, 2x1024MB DDR2-SDRAM	19919	13795
29	Atom N270 1,6GHz, 2x2048MB DDR2-SDRAM	4035	3370
APC810 with INTEL GM45 chipset			
30	Core 2 Duo 2,53 GHz, 2x2048MB DDR3-SODIMM	23349	18754
32	Core 2 Duo 2,26 GHz, 2x2048MB DDR3-SODIMM	20881	16755
APC620 with INTEL 945GME chipset			
31	Atom N270 1,6GHz, 1024MB DDR2-SDRAM	4039	3361
INTEL Evalboard with INTEL US15W Chipsatz			
33	Atom Z530 1,6GHz, 1024MB DDR2-SDRAM	3998	3345
PP500 (5PP520.1505-00 + 5PP5CP.US15-01)			
34	Atom Z520 1,33GHz, 2048MB DDR2-SDRAM	3363	2809
PP500 (5PP520.1505-00 + 5PP5CP.US15-02)			
35	Atom Z530 1,6GHz, 2048MB DDR2-SDRAM	4050	3376
PP500 (5PP520.1505-00 + 5PP5CP.US15-00)			
36	Atom Z510 1,1GHz, 2048MB DDR2-SDRAM	2778	2322
PPC800 with INTEL NM10 Chipsatz			
57	Dual Core Atom N2800 1,86GHz, 4096MB DDR3-SODIMM	9530	7887

Table 27: Results for Sisoft Sandra Pro Business 2007, CPU Arithmetic

SiSoft Sandra 2007 CPU Arithmetic

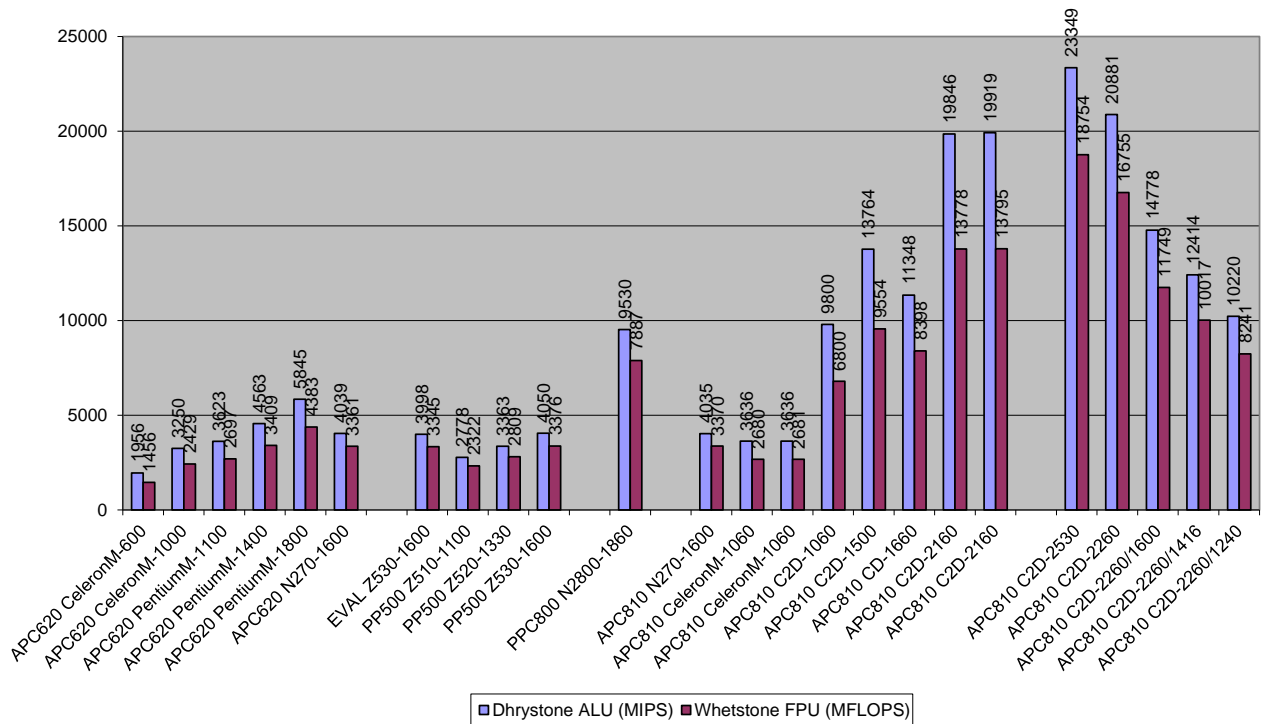

Figure 21 - Results for Sisoft Sandra Pro Business 2007 CPU Arithmetic

4.11.2 CPU multimedia

This test determines the multimedia performance of the CPU. During this test, the speed and performance are checked for the technologies used, such as MMX, SSE, SSE2 (depending on the processor).

#	Test device	Integer (it/s)	Floating Point (it/s)
APC620 with INTEL 855GME chipset			
13	Celeron M 600 MHz, 512MB DDR-SDRAM	5559	6288
14	Celeron M 1000 MHz, 512MB DDR-SDRAM	9300	10513
15	Pentium M 1.1 GHz, 512MB DDR-SDRAM	10287	11639
16	Pentium M 1,4 GHz, 512MB DDR-SDRAM	13044	14753
18	Pentium M 1.8 GHz, 1024MB DDR-SDRAM	16782	18953
APC810 with INTEL 945GM chipset			
21	Celeron M 1.06 GHz, 512MB DDR2-SDRAM	8324	11311
22	Celeron M 1.06 GHz, 2x512MB DDR2-SDRAM	8322	11294
23	Core 2 Duo 1.06 GHz, 2x1024MB DDR2-SDRAM	58703	31642
24	Core 2 Duo 1.50 GHz, 2x512MB DDR2-SDRAM	82474	44468
25	Core Duo 1.66 GHz, 2x1024MB DDR2-SDRAM	25981	35376
26	Core 2 Duo 2.16 GHz, 1024MB DDR2-SDRAM	119063	64213
27	Core 2 Duo 2.16 GHz, 2x1024MB DDR2-SDRAM	119128	64224
29	Atom N270 1,6GHz, 2x2048MB DDR2-SDRAM	29487	19806
APC810 with INTEL GM45 chipset			
30	Core 2 Duo 2,53 GHz, 2x2048MB DDR3-SODIMM	140199	75771
32	Core 2 Duo 2,26 GHz, 2x2048MB DDR3-SODIMM	125342	67757
APC620 with INTEL 945GME chipset			
31	Atom N270 1,6GHz, 1024MB DDR2-SDRAM	29569	19880
INTEL Evalboard with INTEL US15W Chipsatz			
33	Atom Z530 1,6GHz, 1024MB DDR2-SDRAM	29249	19650
PP500 (5PP520.1505-00 + 5PP5CP.US15-01)			
34	Atom Z520 1,33GHz, 2048MB DDR2-SDRAM	24634	16550
PP500 (5PP520.1505-00 + 5PP5CP.US15-02)			
35	Atom Z530 1,6GHz, 2048MB DDR2-SDRAM	29587	19883
PP500 (5PP520.1505-00 + 5PP5CP.US15-00)			
36	Atom Z510 1,1GHz, 2048MB DDR2-SDRAM	20311	13644
PPC800 with INTEL NM10 Chipsatz			
57	Dual Core Atom N2800 1,86GHz, 4096MB DDR3-SODIMM	69462	46347

Table 28: Results for Sisoft Sandra Pro Business 2007, CPU MultiMedia

SiSoft Sandra 2007 CPU MultiMedia

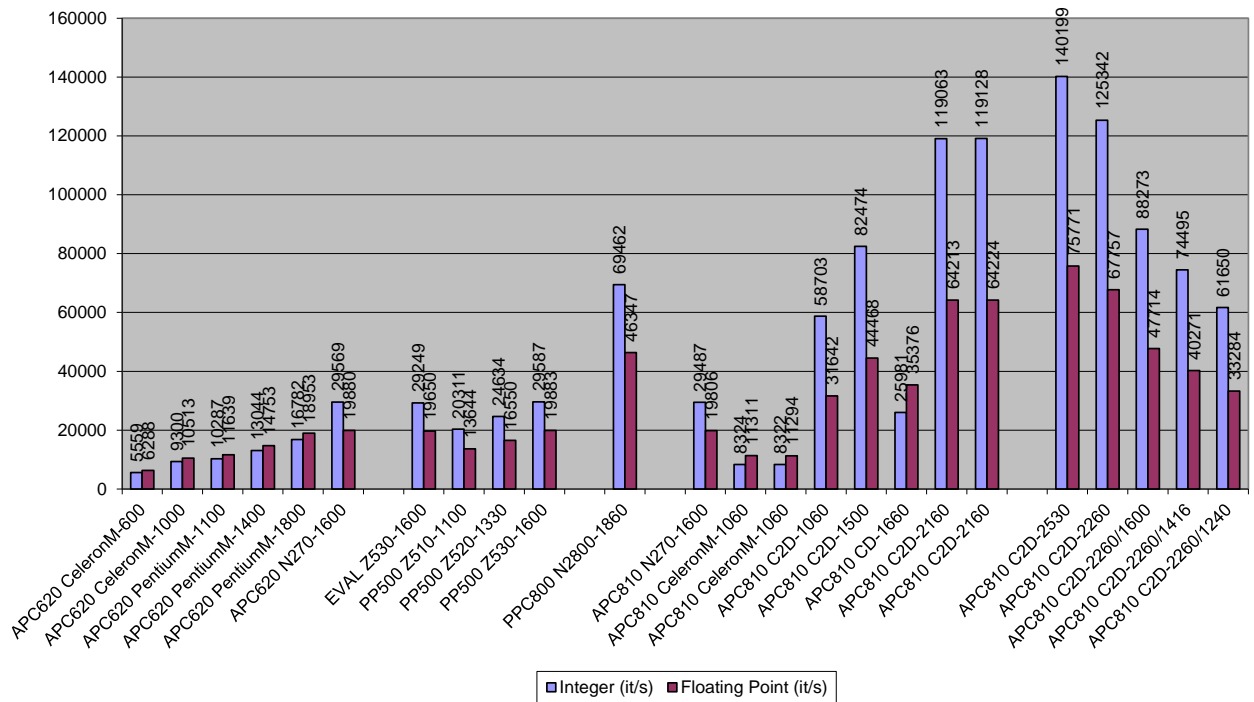

Figure 22 - Results for Sisoft Sandra Pro Business 2007, CPU MultiMedia

4.11.3 Memory bandwidth

The performance of the system memory (main memory) is determined here. This is done by transferring a large amount of data. The result is the maximum "memory throughput" in MB/s.

#	Test device	RAM Bandwidth ALU (MB/s)	RAM Bandwidth FPU (MB/s)
APC620 with INTEL 855GME chipset			
13	Celeron M 600 MHz, 512MB DDR-SDRAM	1701	1836
14	Celeron M 1000 MHz, 512MB DDR-SDRAM	2072	2077
15	Pentium M 1.1 GHz, 512MB DDR-SDRAM ¹	2057	2057
16	Pentium M 1,4 GHz, 512MB DDR-SDRAM	1681	1694
18	Pentium M 1.8 GHz, 1024MB DDR-SDRAM ¹	1541	1549
APC810 with INTEL 945GM chipset			
21	Celeron M 1.06 GHz, 512MB DDR2-SDRAM	2548	2545
22	Celeron M 1.06 GHz, 2x512MB DDR2-SDRAM	2694	2692
23	Core 2 Duo 1.06 GHz, 2x1024MB DDR2-SDRAM	2912	2921
24	Core 2 Duo 1.50 GHz, 2x512MB DDR2-SDRAM	3531	3533
25	Core Duo 1.66 GHz, 2x1024MB DDR2-SDRAM	3644	3616
26	Core 2 Duo 2.16 GHz, 1024MB DDR2-SDRAM	3712	3716
27	Core 2 Duo 2.16 GHz, 2x1024MB DDR2-SDRAM	3972	3978
29	Atom N270 1,6GHz, 2x2048MB DDR2-SDRAM	3224	2792
APC810 with INTEL GM45 chipset			
30	Core 2 Duo 2,53 GHz, 2x2048MB DDR3-SODIMM	5966	5957
32	Core 2 Duo 2,26 GHz, 2x2048MB DDR3-SODIMM	5819	5830
APC620 with INTEL 945GME chipset			
31	Atom N270 1,6GHz, 1024MB DDR2-SDRAM	2931	2587
INTEL Evalboard with INTEL US15W Chipsatz			
33	Atom Z530 1,6GHz, 1024MB DDR2-SDRAM	2863	2468
PP500 (5PP520.1505-00 + 5PP5CP.US15-01)			
34	Atom Z520 1,33GHz, 2048MB DDR2-SDRAM	2752	2407
PP500 (5PP520.1505-00 + 5PP5CP.US15-02)			
35	Atom Z530 1,6GHz, 2048MB DDR2-SDRAM	2927	2621
PP500 (5PP520.1505-00 + 5PP5CP.US15-00)			
36	Atom Z510 1,1GHz, 2048MB DDR2-SDRAM	2203	1930
PPC800 with INTEL NM10 Chipsatz			
57	Dual Core Atom N2800 1,86GHz, 4096MB DDR3-SODIMM	4237	3582

1) See information

Table 29: Results for Sisoft Sandra Pro Business 2007, CPU Memory Bandwidth

SiSoft Sandra 2007 Memory Bandwidth

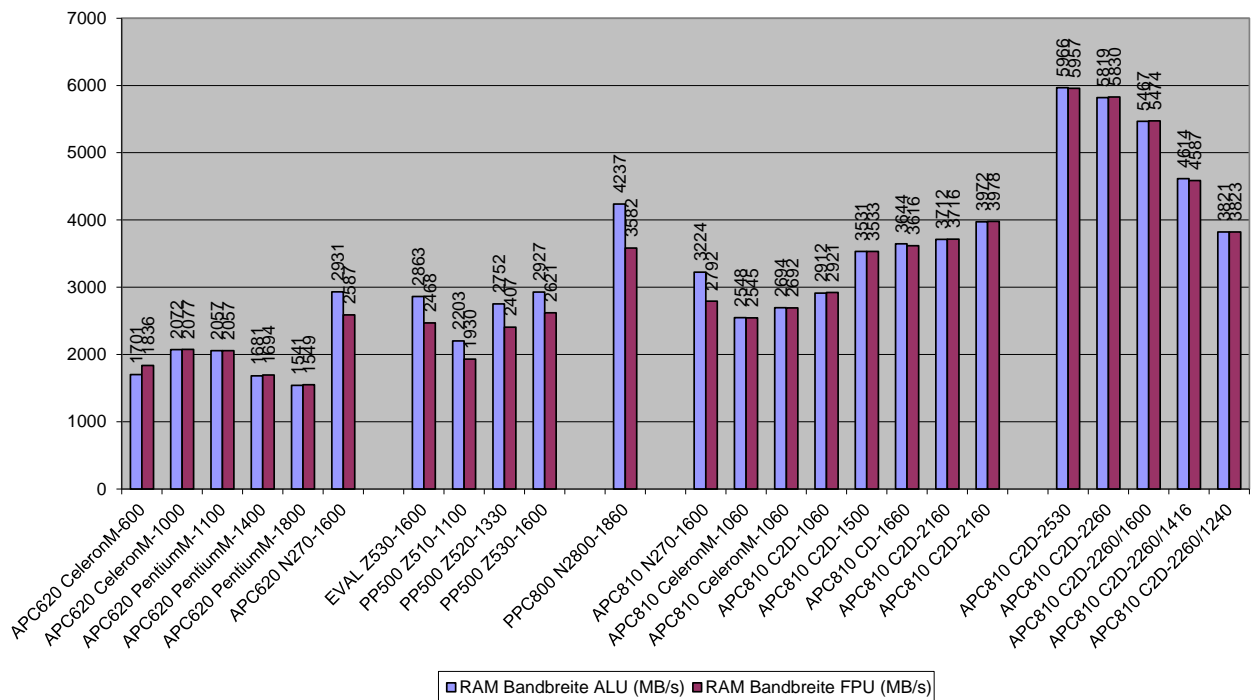

Figure 23 - Results for Sisoft Sandra Pro Business 2007, CPU Memory Bandwidth

Information:

The memory bandwidth test for the APC620 with PM-1100, PM-1400 and PM-1800 returns values that are "not plausible", since according to this test the PM-1100 would be faster than the PM-1400 and PM-1800. With the benchmark tests with Sisoft Sandra 2002 and 2005 the values are correct.

4.11.4 Cache and memory bandwidth

#	Test device	Combined index (MB/s)	Speed factor
APC620 with INTEL 855GME chipset			
13	Celeron M 600 MHz, 512MB DDR-SDRAM	2597	8,2
14	Celeron M 1000 MHz, 512MB DDR-SDRAM	3315	13,3
15	Pentium M 1.1 GHz, 512MB DDR-SDRAM	3517	19,0
16	Pentium M 1,4 GHz, 512MB DDR-SDRAM	4310	19,8
18	Pentium M 1.8 GHz, 1024MB DDR-SDRAM	4229	36,3
APC810 with INTEL 945GM chipset			
21	Celeron M 1.06 GHz, 512MB DDR2-SDRAM	4819	9,0
22	Celeron M 1.06 GHz, 2x512MB DDR2-SDRAM	5247	7,4
23	Core 2 Duo 1.06 GHz, 2x1024MB DDR2-SDRAM	10944	32,6
24	Core 2 Duo 1.50 GHz, 2x512MB DDR2-SDRAM	15753	39,7
25	Core Duo 1.66 GHz, 2x1024MB DDR2-SDRAM	11501	17,4
26	Core 2 Duo 2.16 GHz, 1024MB DDR2-SDRAM	18528	66,7
27	Core 2 Duo 2.16 GHz, 2x1024MB DDR2-SDRAM	20465	51,9
29	Atom N270 1,6GHz, 2x2048MB DDR2-SDRAM	4844	4,9
APC810 with INTEL GM45 chipset			
30	Core 2 Duo 2,53 GHz, 2x2048MB DDR3-SODIMM	26899	39
32	Core 2 Duo 2,26 GHz, 2x2048MB DDR3-SODIMM	24064	35,2
APC620 with INTEL 945GME chipset			
31	Atom N270 1,6GHz, 1024MB DDR2-SDRAM	4299	6,2
INTEL Evalboard with INTEL US15W Chipsatz			
33	Atom Z530 1,6GHz, 1024MB DDR2-SDRAM	3766	7,4
PP500 (5PP520.1505-00 + 5PP5CP.US15-01)			
34	Atom Z520 1,33GHz, 2048MB DDR2-SDRAM	3714	6
PP500 (5PP520.1505-00 + 5PP5CP.US15-02)			
35	Atom Z530 1,6GHz, 2048MB DDR2-SDRAM	3971	7,3
PP500 (5PP520.1505-00 + 5PP5CP.US15-00)			
36	Atom Z510 1,1GHz, 2048MB DDR2-SDRAM	3086	5,7
PPC800 with INTEL NM10 Chipsatz			
57	Dual Core Atom N2800 1,86GHz, 4096MB DDR3-SODIMM	8097	10,9

Table 30: Results for Sisoft Sandra Pro Business 2007, cache and memory bandwidth

SiSoft Sandra 2007 Cache and Memory Bandwidth

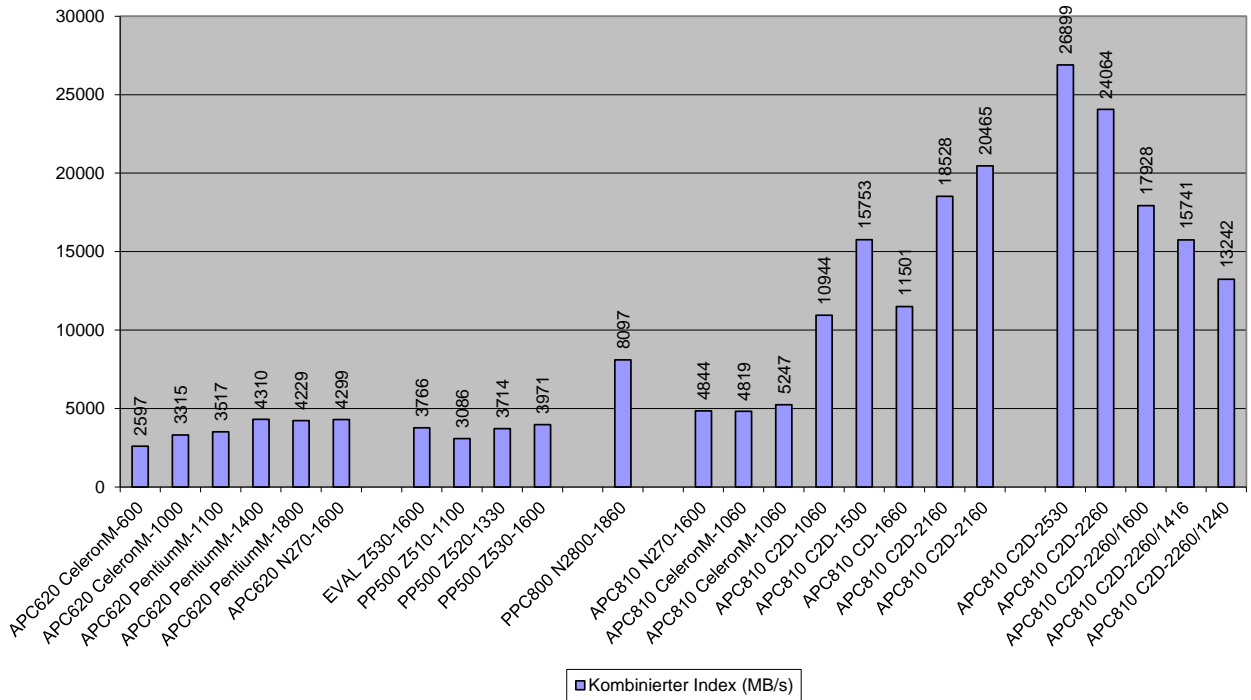

Figure 24 - Results for Sisoft Sandra Pro Business 2007, cache and memory bandwidth

SiSoft Sandra 2007 Cache and Memory Bandwidth

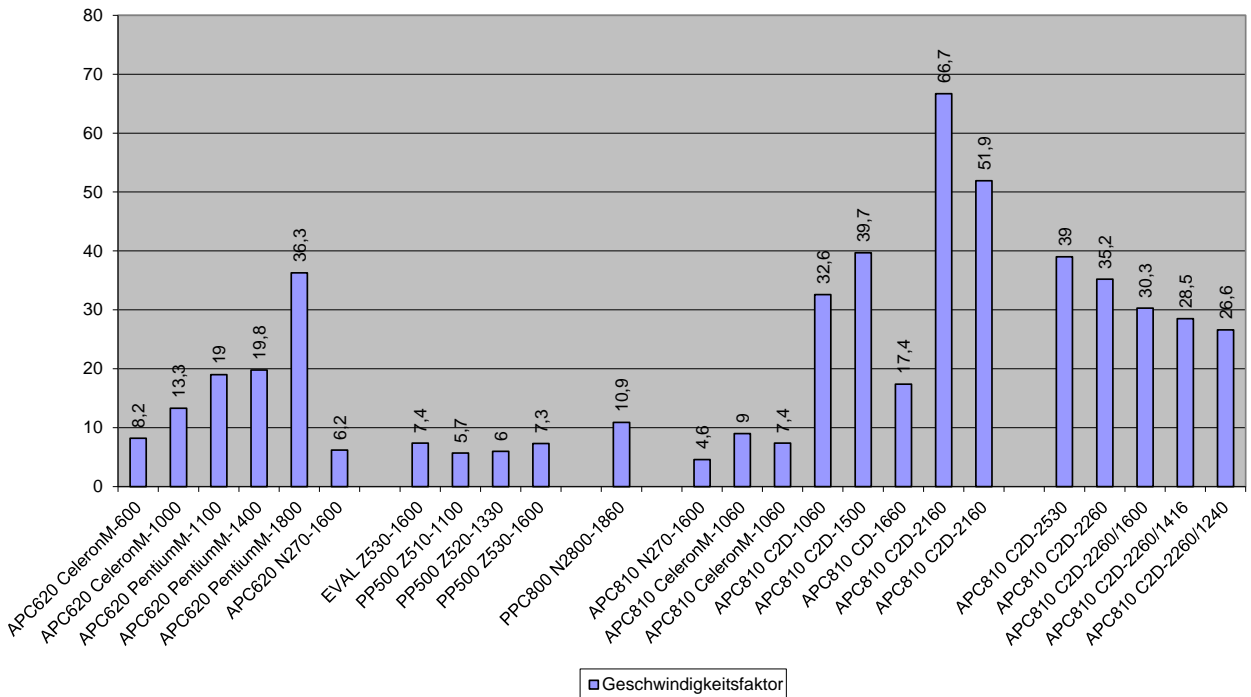

Figure 25 - Results for Sisoft Sandra Pro Business 2007, cache and memory bandwidth

4.11.5 Physical devices / removeable devices

This test determines the performance of physical devices (HDD) and removeable devices (compact flash, USB memory stick). Therefore big datapackages are being transferd (reading speed / writing speed). The result ist the maximal performance in MB/s.

#	Test device	Reading speed (MB/s)	Writing speed (MB/s)
APC620 with INTEL 855GME chipset			
30	Pentium M 1,4 GHz, 1024MB DDR-SDRAM Siliconsystems INC 1 GB card (NTFS)	9,83	4,36
30	Pentium M 1,4 GHz, 1024MB DDR-SDRAM B&R Compact Flash 1 GB card (NTFS)	37,13	9,83
APC810 with INTEL GM45 chipset			
29	Core 2 Duo 2,53 GHz, 2x2048MB DDR3-SODIMM Siliconsystems INC 1 GB card (NTFS)	9,83	4,36
29	Core 2 Duo 2,53 GHz, 2x2048MB DDR3-SODIMM B&R Compact Flash 1 GB card (NTFS)	37,13	9,83
APC810 with INTEL 945GME chipset			
24	Core 2 Duo 1,50 GHz, 2x512MB DDR2-SDRAM Siliconsystems INC 1 GB card (NTFS)	9,83	4,36
24	Core 2 Duo 1,50 GHz, 2x512MB DDR2-SDRAM B&R Compact Flash 1 GB card (NTFS)	37,13	9,83
24	Core 2 Duo 1,50 GHz, 2x512MB DDR2-SDRAM Compact Slide In SATA 40 GB HDD (NTFS)	41,52	38,23
24	Core 2 Duo 1,50 GHz, 2x512MB DDR2-SDRAM USB 2.0 Memory Stick 1 GB (5MMUSB.1024-01)	18,57	6,55

Table 31: Results for Sisoft Sandra Pro Business 2007, physical devices / removeable devices

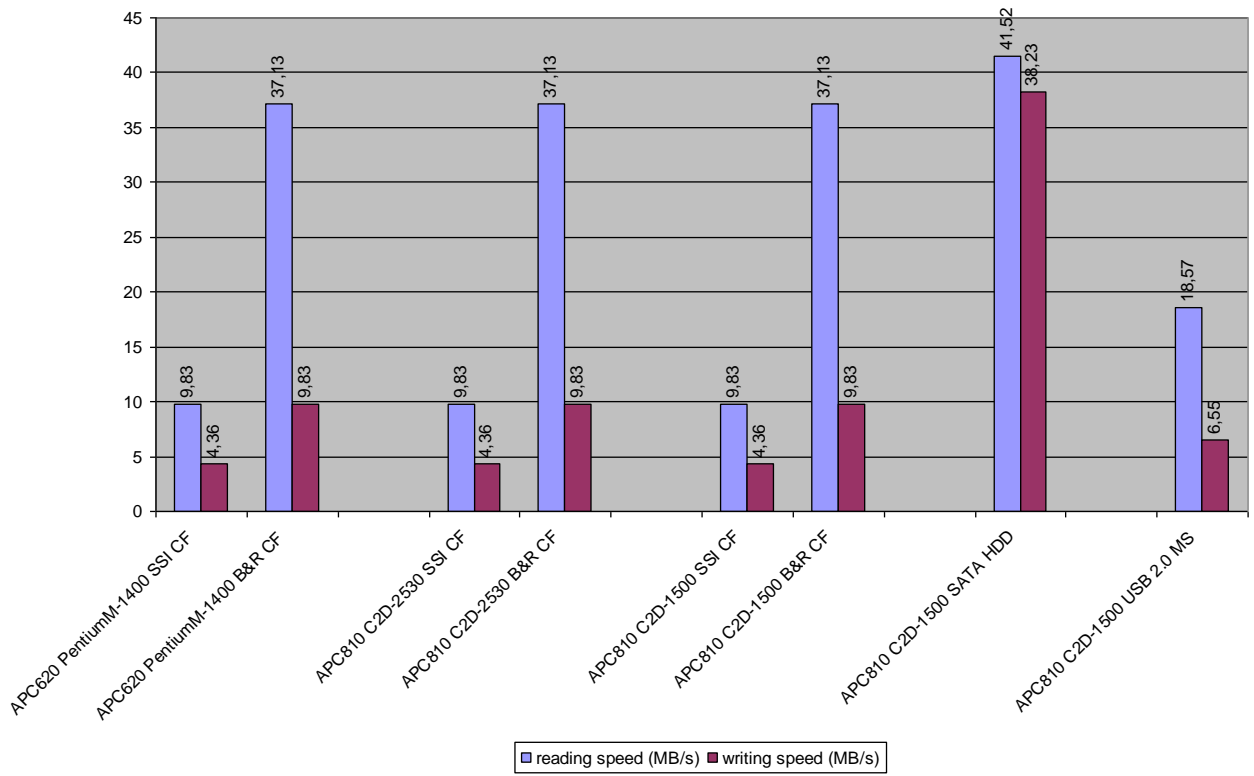

Figure 26 – Results for Sisoft Sandra Pro Business 2007, physical devices / removeable devices

4.12 SiSoft Sandra 2011 Lite

4.12.1 APC910/PPC900

4.12.1.1 CPU Arithmetic

Benchmarks the ALU and FPU processor units. Shows how your processors handle arithmetic and floating point instructions in comparison to other typical processors. Such operations are used by software in typical tasks.

Higher scores are better

#	Test device	Arithmetic Performance (GOPS)	Dhrystone iSSE4.2 (GIPS)	Whetstone iSSE3 (GFLOPS)
APC910 with INTEL QM77 Chipset				
37	i7-3615QE 4C 2.3/1.6GHz 6MB 45W 2x4096MB DDR3-SODIMM 1067MHz	94,58	118,74	75,33
38	i7-3615QE 4C 2.3/1.6GHz 6MB 45W 2x4096MB DDR3-SODIMM 1600MHz	95,55	120,59	75,71
39	i7-3612QE 4C 2.1/1.6GHz 6MB 35W, 2x4096MB DDR3-SODIMM 1067MHz	85,69	107,54	68,28
40	i7-3612QE 4C 2.1/1.6GHz 6MB 35W, 2x4096MB DDR3-SODIMM 1600MHz	85,43	107,31	68
41	i7-3555LE 2C 2.5/1.6GHz 4MB 25W, 4096MB DDR3-SODIMM 1067MHz	46	57,31	36,86
42	i7-3555LE 2C 2.5/1.6GHz 4MB 25W, 4096MB DDR3-SODIMM 1600MHz	45,9	57,28	36,78
43	i7-3555LE 2C 2.5/1.6GHz 4MB 25W, 2x2048MB DDR3-SODIMM 1067MHz	46	57,52	36,7
44	i7-3555LE 2C 2.5/1.6GHz 4MB 25W, 2x4096MB DDR3-SODIMM 1600MHz	45,83	57,5	36,52
45	i7-3517UE 2C 1.7/1.6GHz 4MB 17W, 2x2048MB DDR3-SODIMM 1067MHz	40,29	51	31,83
46	i7-3517UE 2C 1.7/1.6GHz 4MB 17W, 2x4096MB DDR3-SODIMM 1600MHz	39,83	50	31,75
47	i5-3610ME 2C 2.7/1.6GHz 3MB 35W, 2x2048MB DDR3-SODIMM 1067MHz	47,89	59,28	38
48	i5-3610ME 2C 2.7/1.6GHz 3MB 35W, 2x4096MB DDR3-SODIMM 1600MHz	47,39	59,42	37,8
49	i3-3120ME 2C 2.4/1.6GHz 3MB 35W, 2x2048MB DDR3-SODIMM 1067MHz	38,4	48,15	30,61
50	i3-3120ME 2C 2.4/1.6GHz 3MB 35W, 2x4096MB DDR3-SODIMM 1600MHz	38,38	48	30,71
51	i3-3217UE 2C 1.6/1.6GHz 3MB 17W, 2x2048MB DDR3-SODIMM 1067MHz	24,77	31,33	19,59
52	i3-3217UE 2C 1.6/1.6GHz 3MB 17W, 2x4096MB DDR3-SODIMM 1600MHz	24,8	31,33	19,64
APC910 with INTEL HM76 Chipset				
53	C-847E 2C 1.1/1.3GHz 2MB 17W 2x2048MB DDR3-SODIMM 1067MHz	11,39	16,43	7,9
54	C-847E 2C 1.1/1.3GHz 2MB 17W 2x4096MB DDR3-SODIMM 1333MHz	11,39	16,43	7,9
55	C-827E 1C 1.4/1.3GHz 1.5MB 17W 2x2048MB DDR3-SODIMM 1067MHz	7,18	10,46	5
56	C-827E 1C 1.4/1.3GHz 1.5MB 17W 2x4096MB DDR3-SODIMM 1333MHz	7,18	10,46	5

58	C-1047UE 2C 1.4/1.6GHz 2MB 17W 2x4096MB DDR3-SODIMM 1600MHz	14,68	20,87	10,32
59	C-1020E 2C 2.2/1.6GHz 2MB 35W 2x4096MB DDR3-SODIMM 1600MHz	23,2	32,9	16,36

Table 32: Results for SiSoft Sandra 2011, CPU Arithmetic – APC910/PPC900

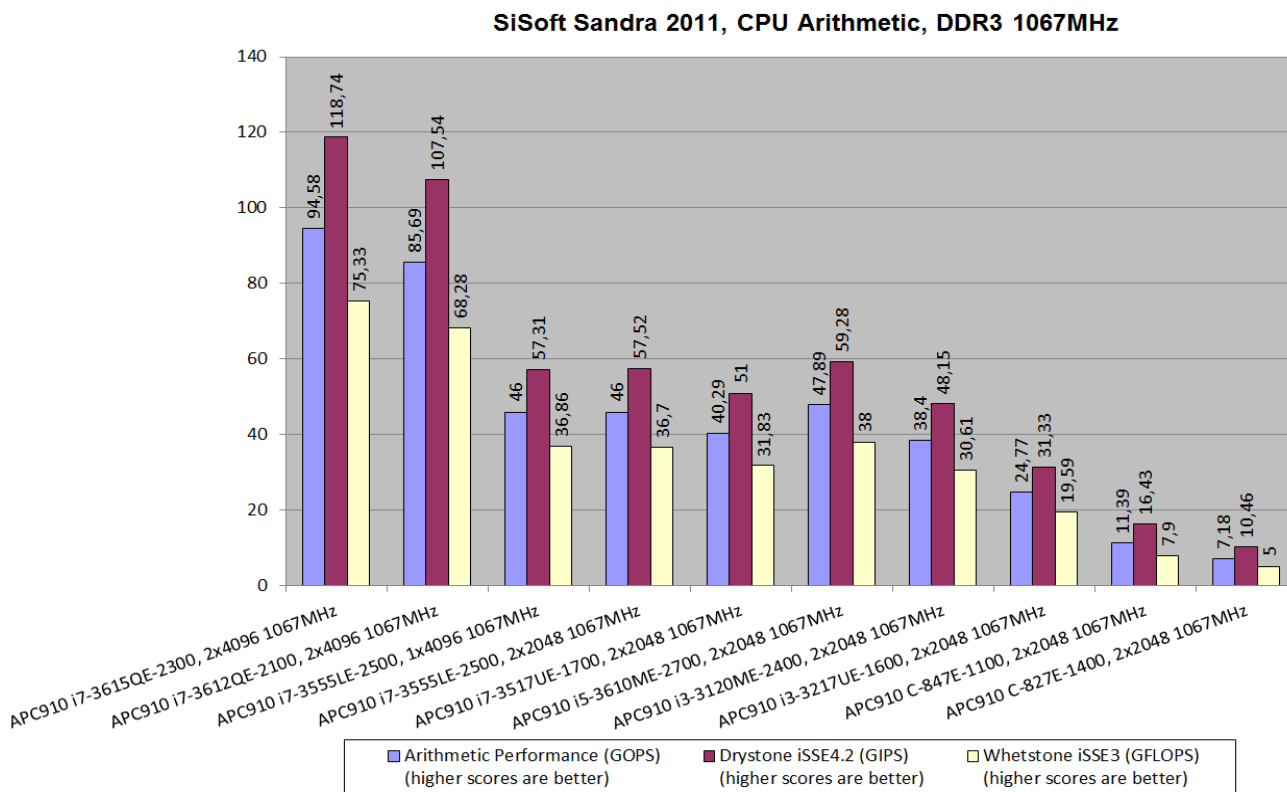

Figure 27: Results for SiSoft Sandra 2011, CPU Arithmetic, DDR3 1067MHz – APC910/PPC900

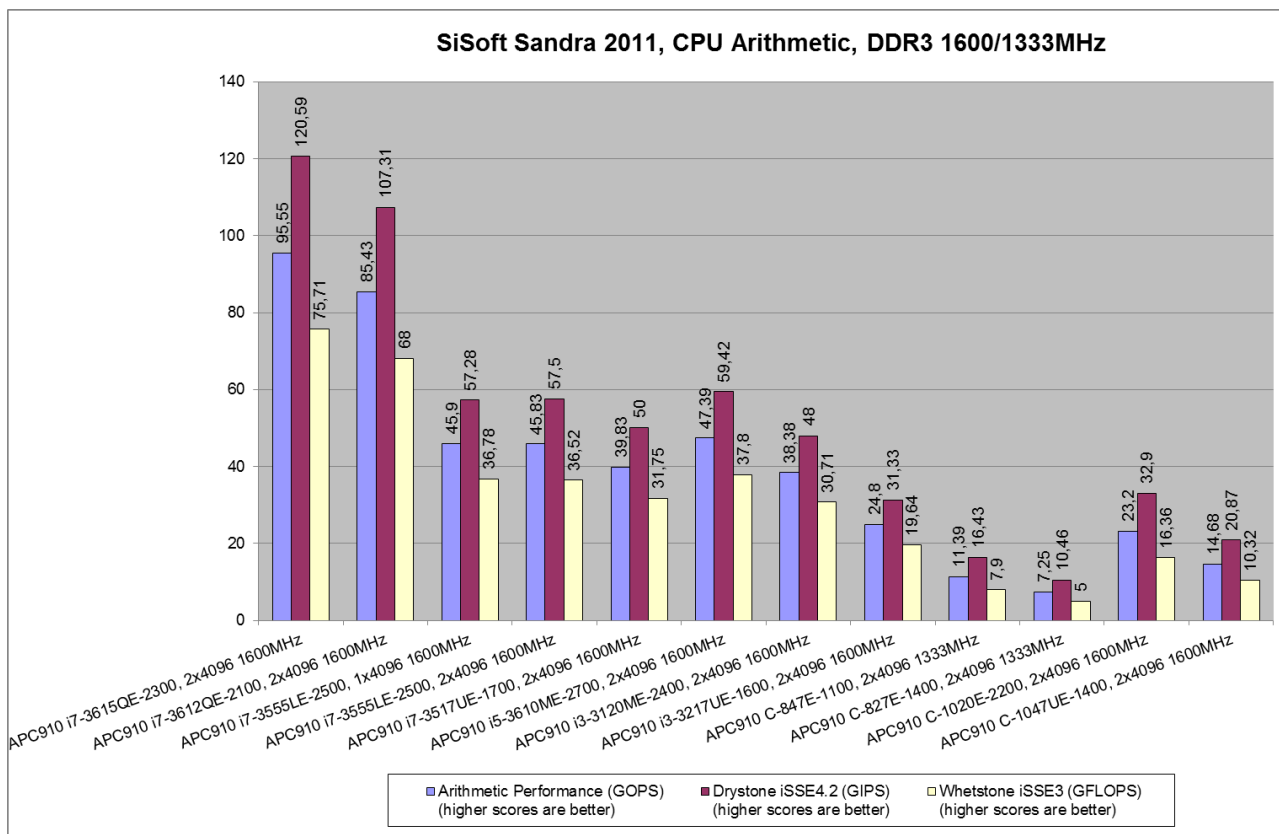

Figure 28: Results for SiSoft Sandra 2011, CPU Arithmetic, DDR3 1600/1333MHz – APC910/PPC900

4.12.1.2 Processor Multi-media

Benchmark the SIMD processor units. Shows how your processors handle multi-media instructions and data in comparison to other typical processors. Such operations are used by more specialized software, e.g. image manipulation, video decoders/encoders and games.

Higher scores are better

#	Test device	Multimedia Performance (MPixel/s)	Integer x32 iAVX (MPixel/s)	Float x16 iAVX (MPixel/s)	Multimedia Double x8 iAVX (MPixel/s)
APC910 with INTEL QM77 Chipset					
37	i7-3615QE 4C 2.3/1.6GHz 6MB 45W 2x4096MB DDR3-SODIMM 1067MHz	219,1	186,32	257,66	145,1
38	i7-3615QE 4C 2.3/1.6GHz 6MB 45W 2x4096MB DDR3-SODIMM 1600MHz	219,26	186,57	257,67	145,2
39	i7-3612QE 4C 2.1/1.6GHz 6MB 35W, 2x4096MB DDR3-SODIMM 1067MHz	198	168,53	232,5	131,15
40	i7-3612QE 4C 2.1/1.6GHz 6MB 35W, 2x4096MB DDR3-SODIMM 1600MHz	197,75	168,42	232,2	131
41	i7-3555LE 2C 2.5/1.6GHz 4MB 25W, 4096MB DDR3-SODIMM 1067MHz	105,26	88,8	124,79	70,28
42	i7-3555LE 2C 2.5/1.6GHz 4MB 25W, 4096MB DDR3-SODIMM 1600MHz	105,27	88,83	124,75	70,28
43	i7-3555LE 2C 2.5/1.6GHz 4MB 25W, 2x2048MB DDR3-SODIMM 1067MHz	105,3	88,83	124,82	70,28
44	i7-3555LE 2C 2.5/1.6GHz 4MB 25W, 2x4096MB DDR3-SODIMM 1600MHz	105,28	88,79	124,83	70,2
45	i7-3517UE 2C 1.7/1.6GHz 4MB 17W, 2x2048MB DDR3-SODIMM 1067MHz	91,24	77	108,15	60,9
46	i7-3517UE 2C 1.7/1.6GHz 4MB 17W, 2x4096MB DDR3-SODIMM 1600MHz	91,21	77	108	60,84
47	i5-3610ME 2C 2.7/1.6GHz 3MB 35W, 2x2048MB DDR3-SODIMM 1067MHz	108,68	91,63	128,29	72,55
48	i5-3610ME 2C 2.7/1.6GHz 3MB 35W, 2x4096MB DDR3-SODIMM 1600MHz	108,81	91,79	129	72,63
49	i3-3120ME 2C 2.4/1.6GHz 3MB 35W, 2x2048MB DDR3-SODIMM 1067MHz	87,71	74	104	58,58
50	i3-3120ME 2C 2.4/1.6GHz 3MB 35W, 2x4096MB DDR3-SODIMM 1600MHz	87,66	74	103,86	58,58
51	i3-3217UE 2C 1.6/1.6GHz 3MB 17W, 2x2048MB DDR3-SODIMM 1067MHz	56	47,33	66,5	37,43
52	i3-3217UE 2C 1.6/1.6GHz 3MB 17W, 2x4096MB DDR3-SODIMM 1600MHz	56	47,32	66,41	37,41
		Multimedia Performance (MPixel/s)	Integer x16 iSSSE4.1 (MPixel/s)	Float x8 iSSE2 (MPixel/s)	Multimedia Double x4 iSSE2 (MPixel/s)
APC910 with INTEL HM76 Chipset					
53	C-847E 2C 1.1/1.3GHz 2MB 17W 2x2048MB DDR3-SODIMM 1067MHz	20,65	24,44	17,45	9,33
54	C-847E 2C 1.1/1.3GHz 2MB 17W 2x4096MB DDR3-SODIMM 1333MHz	20,64	24,44	17,43	9,33
55	C-827E 1C 1.4/1.3GHz 1.5MB 17W 2x2048MB DDR3-SODIMM 1067MHz	13,16	15,59	11,11	6

56	C-827E 1C 1.4/1.3GHz 1.5MB 17W 2x4096MB DDR3-SODIMM 1333MHz	13,17	15,61	11,11	6
58	C-1047UE 2C 1.4/1.6GHz 2MB 17W 2x4096MB DDR3-SODIMM 1600MHz	27,37	32,24	23,25	12,37
59	C-1020E 2C 2.2/1.6GHz 2MB 35W 2x4096MB DDR3-SODIMM 1600MHz	43	50,69	36,63	19,46

Table 33: Results for SiSoft Sandra 2011, Processor Multi-Media – APC910/PPC900

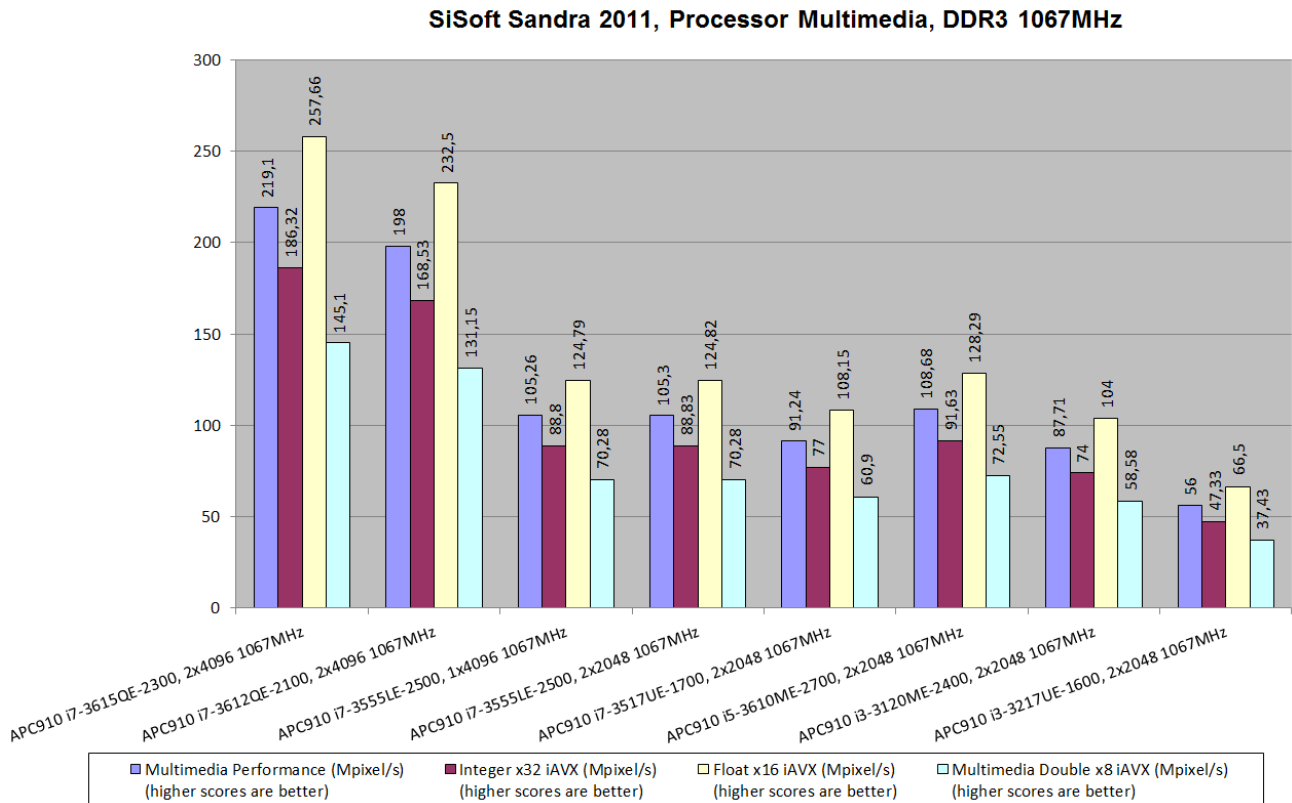

Figure 29: Results for SiSoft Sandra 2011, Processor Multi-Media (HM77 Chipset), DDR3 1067MHz – APC910/PPC900

SiSoft Sandra 2011, Processor Multimedia, DDR3 1600MHz

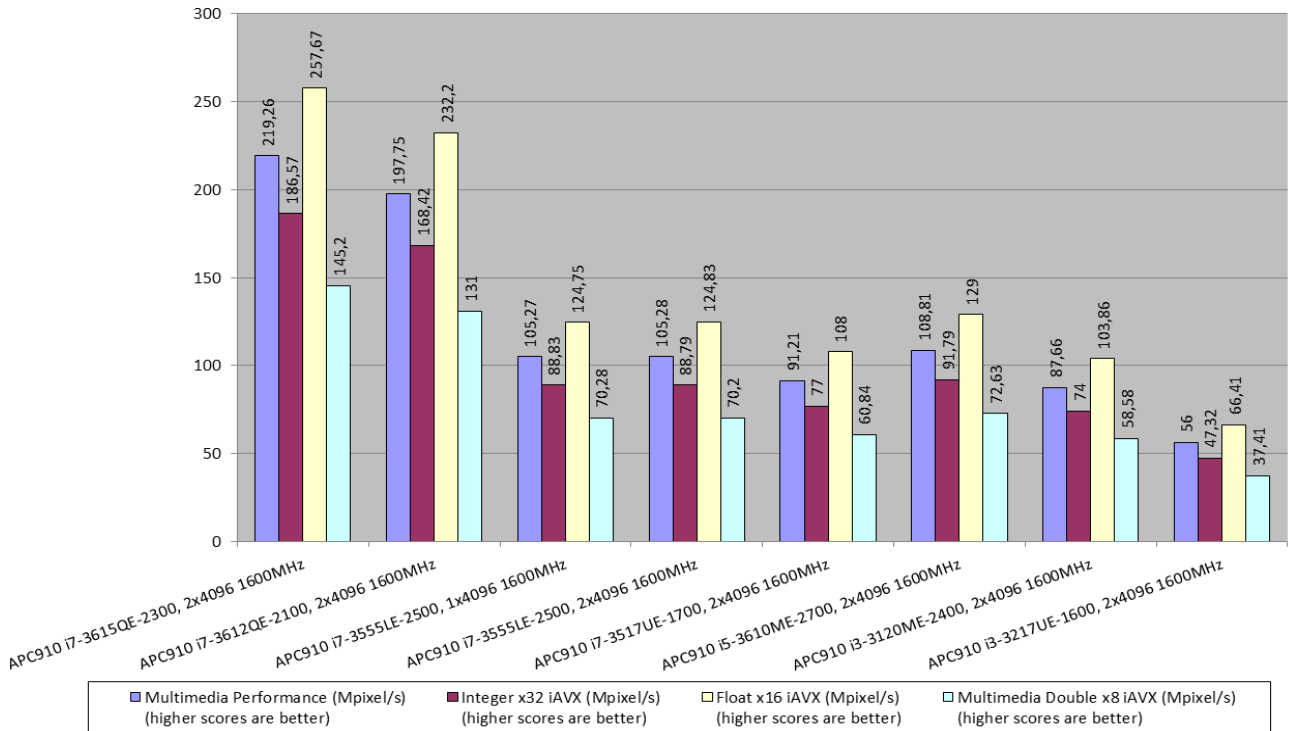

Figure 30: Results for SiSoft Sandra 2011, Processor Multi-Media (HM77 Chipset), DDR3 1600MHz – APC910/PPC900

SiSoft Sandra 2011, Processor Multimedia (HM76 Chipsatz), DDR3 1067/1333/1600MHz

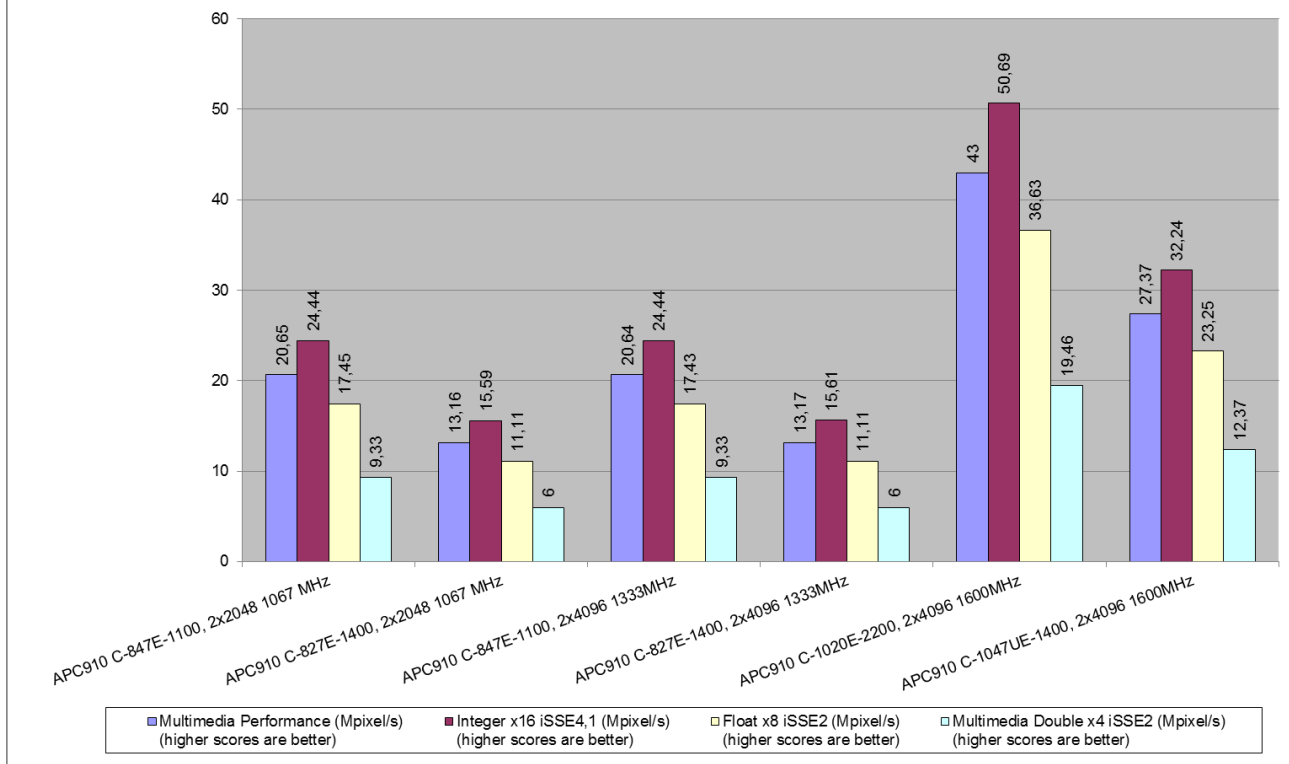

Figure 31: Results for SiSoft Sandra 2011, Processor Multi-Media (HM76 Chipset), DDR3 1067/1333/1600MHz – APC910/PPC900

4.12.1.3 Multi-Core Efficiency

Benchmark the multi-core efficiency of the processors. Shows how efficient the processor cores and their inter – connects are in comparison to other types to other typical processors. The ability of the cores to process data blocks and pass them to another core for processing of different sizes and different chain sizes is measured. The efficiency of the inter – connect between cores is thus benchmarked. The number of cores also counts as more data buffers can be processed simultaneously.

#	Test device	Inter-Core Bandwidth (GB/s) (higher scores are better)	Inter-Core Latency (ns) (lower scores are better)
APC910 with INTEL QM77 Chipset			
37	i7-3615QE 4C 2.3/1.6GHz 6MB 45W 2x4096MB DDR3-SODIMM 1067MHz	18,35	45,5
38	i7-3615QE 4C 2.3/1.6GHz 6MB 45W 2x4096MB DDR3-SODIMM 1600MHz	20,58	51
39	i7-3612QE 4C 2.1/1.6GHz 6MB 35W, 2x4096MB DDR3-SODIMM 1067MHz	16,87	42,2
40	i7-3612QE 4C 2.1/1.6GHz 6MB 35W, 2x4096MB DDR3-SODIMM 1600MHz	19,42	51,1
41	i7-3555LE 2C 2.5/1.6GHz 4MB 25W, 4096MB DDR3-SODIMM 1067MHz	9,33	37,4
42	i7-3555LE 2C 2.5/1.6GHz 4MB 25W, 4096MB DDR3-SODIMM 1600MHz	10,36	37,5
43	i7-3555LE 2C 2.5/1.6GHz 4MB 25W, 2x2048MB DDR3-SODIMM 1067MHz	11,34	33,7
44	i7-3555LE 2C 2.5/1.6GHz 4MB 25W, 2x4096MB DDR3-SODIMM 1600MHz	12,89	34,9
45	i7-3517UE 2C 1.7/1.6GHz 4MB 17W, 2x2048MB DDR3-SODIMM 1067MHz	10,23	50,1
46	i7-3517UE 2C 1.7/1.6GHz 4MB 17W, 2x4096MB DDR3-SODIMM 1600MHz	11,56	43,9
47	i5-3610ME 2C 2.7/1.6GHz 3MB 35W, 2x2048MB DDR3-SODIMM 1067MHz	11,16	35,5
48	i5-3610ME 2C 2.7/1.6GHz 3MB 35W, 2x4096MB DDR3-SODIMM 1600MHz	13	34,3
49	i3-3120ME 2C 2.4/1.6GHz 3MB 35W, 2x2048MB DDR3-SODIMM 1067MHz	9,85	52,4
50	i3-3120ME 2C 2.4/1.6GHz 3MB 35W, 2x4096MB DDR3-SODIMM 1600MHz	11	45,7
51	i3-3217UE 2C 1.6/1.6GHz 3MB 17W, 2x2048MB DDR3-SODIMM 1067MHz	7,22	67,3
52	i3-3217UE 2C 1.6/1.6GHz 3MB 17W, 2x4096MB DDR3-SODIMM 1600MHz	8	71,2
APC910 with INTEL HM76 Chipset			
53	C-847E 2C 1.1/1.3GHz 2MB 17W 2x2048MB DDR3- SODIMM 1067MHz	2	133,2
54	C-847E 2C 1.1/1.3GHz 2MB 17W 2x4096MB DDR3- SODIMM 1333MHz	2	141,4
55	C-827E 1C 1.4/1.3GHz 1.5MB 17W 2x2048MB DDR3-SODIMM 1067MHz	-	-
56	C-827E 1C 1.4/1.3GHz 1.5MB 17W 2x4096MB DDR3-SODIMM 1333MHz	-	-
58	C-1047UE 2C 1.4/1.6GHz 2MB 17W 2x4096MB DDR3-SODIMM 1600MHz	2,57	101
59	C-1020E 2C 2.2/1.6GHz 2MB 35W 2x4096MB DDR3-SODIMM 1600MHz	3,72	59,2

Table 34: Results for SiSoft Sandra 2011, Multi-Core Efficiency – APC910/PPC900

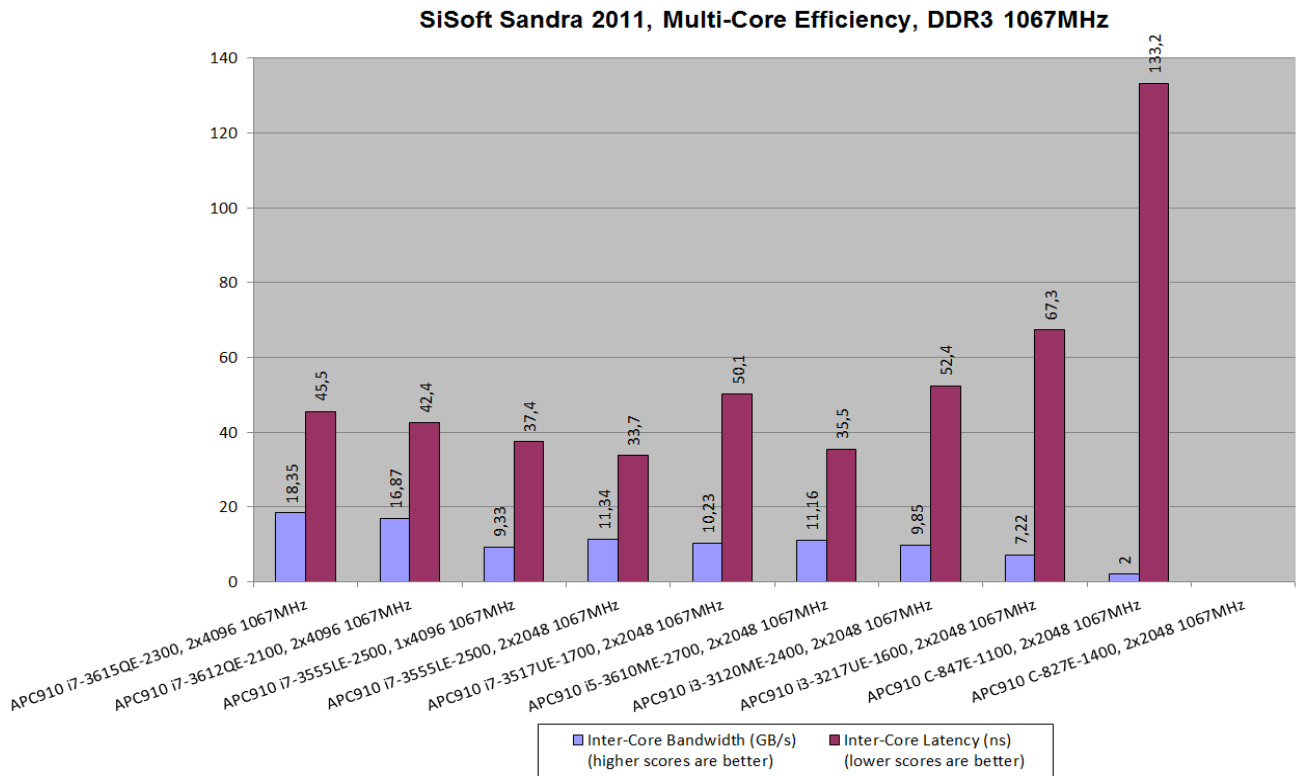

Figure 32: Results for SiSoft Sandra 2011, Multi-Core Efficiency, DDR3 1067MHz – APC910/PPC900

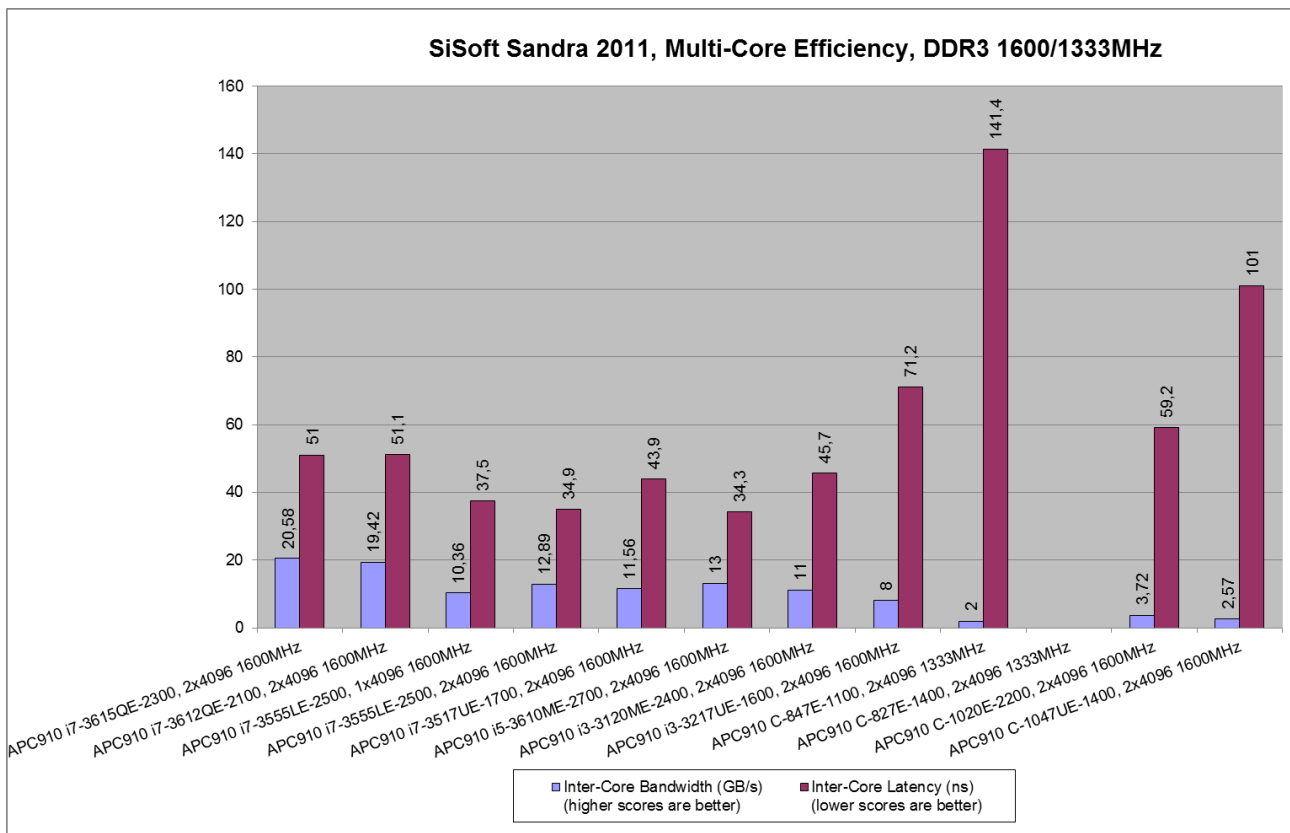

Figure 33: Results for SiSoft Sandra 2011, Multi-Core Efficiency, DDR3 1600/1333MHz – APC910/PPC900

4.12.1.4 Cryptography

Measures the cryptography efficiency of the processor units: encryption, decryption and hashing. Shows how your processors handle cryptographic operations in comparison to other typical processors. Such operations are used by software in most operations that handle sensitive data.

Higher scores are better

#	Test device	Cryptographic Bandwidth (GB/s)	AES256-ECB iAES Cryptographic Bandwidth (GB/s)	SHA256 iAVX Hashing Bandwidth (GB/s)
APC910 with INTEL QM77 Chipset				
37	i7-3615QE 4C 2.3/1.6GHz 6MB 45W 2x4096MB DDR3-SODIMM 1067MHz	2,22	4,72	1
38	i7-3615QE 4C 2.3/1.6GHz 6MB 45W 2x4096MB DDR3-SODIMM 1600MHz	2,62	6,58	1
39	i7-3612QE 4C 2.1/1.6GHz 6MB 35W, 2x4096MB DDR3-SODIMM 1067MHz	2	4,4	0,961
40	i7-3612QE 4C 2.1/1.6GHz 6MB 35W, 2x4096MB DDR3-SODIMM 1600MHz	2,48	6,57	0,962
41	i7-3555LE 2C 2.5/1.6GHz 4MB 25W, 4096MB DDR3-SODIMM 1067MHz	1,1	2,44	0,515
42	i7-3555LE 2C 2.5/1.6GHz 4MB 25W, 4096MB DDR3-SODIMM 1600MHz	1,33	3,53	0,515
43	i7-3555LE 2C 2.5/1.6GHz 4MB 25W, 2x2048MB DDR3-SODIMM 1067MHz	1,47	4,32	0,515
44	i7-3555LE 2C 2.5/1.6GHz 4MB 25W, 2x4096MB DDR3-SODIMM 1600MHz	1,78	6,31	0,515
45	i7-3517UE 2C 1.7/1.6GHz 4MB 17W, 2x2048MB DDR3-SODIMM 1067MHz	1,37	4,3	0,447
46	i7-3517UE 2C 1.7/1.6GHz 4MB 17W, 2x4096MB DDR3-SODIMM 1600MHz	1,63	6	0,477
47	i5-3610ME 2C 2.7/1.6GHz 3MB 35W, 2x2048MB DDR3-SODIMM 1067MHz	1,5	4,33	0,532
48	i5-3610ME 2C 2.7/1.6GHz 3MB 35W, 2x4096MB DDR3-SODIMM 1600MHz	1,8	6,33	0,524
49	i3-3120ME 2C 2.4/1.6GHz 3MB 35W, 2x2048MB DDR3-SODIMM 1067MHz	1,34	4,3	0,429
50	i3-3120ME 2C 2.4/1.6GHz 3MB 35W, 2x4096MB DDR3-SODIMM 1600MHz	1,57	6	0,429
51	i3-3217UE 2C 1.6/1.6GHz 3MB 17W, 2x2048MB DDR3-SODIMM 1067MHz	1	3,77	0,274
52	i3-3217UE 2C 1.6/1.6GHz 3MB 17W, 2x4096MB DDR3-SODIMM 1600MHz	1	3,83	0,274
		Cryptographic Bandwidth (GB/s)	AES256-ECB ALU Cryptographic Bandwidth (GB/s)	SHA256 iSSE4 Hashing Bandwidth (GB/s)
APC910 with INTEL HM76 Chipset				
53	C-847E 2C 1.1/1.3GHz 2MB 17W 2x2048MB DDR3-SODIMM 1067MHz	0,129	0,129	0,13
54	C-847E 2C 1.1/1.3GHz 2MB 17W 2x4096MB DDR3-SODIMM 1333MHz	0,129	0,129	0,129
55	C-827E 1C 1.4/1.3GHz 1.5MB 17W 2x2048MB DDR3-SODIMM 1067MHz	0,082	0,082	0,082
56	C-827E 1C 1.4/1.3GHz 1.5MB 17W 2x4096MB DDR3-SODIMM 1333MHz	0,082	0,082	0,083

#	Test device	Cryptographic Bandwidth (GB/s)	AES256-ECB iAES Cryptographic Bandwidth (GB/s)	SHA256 iAVX Hashing Bandwidth (GB/s)
58	C-1047UE 2C 1.4/1.6GHz 2MB 17W 2x4096MB DDR3-SODIMM 1600MHz	0,203	0,184	0,225
59	C-1020E 2C 2.2/1.6GHz 2MB 35W 2x4096MB DDR3-SODIMM 1600MHz	0,32	0,29	0,353

Table 35: Results for SiSoft Sandra 2011, Cryptography – APC910/PPC900

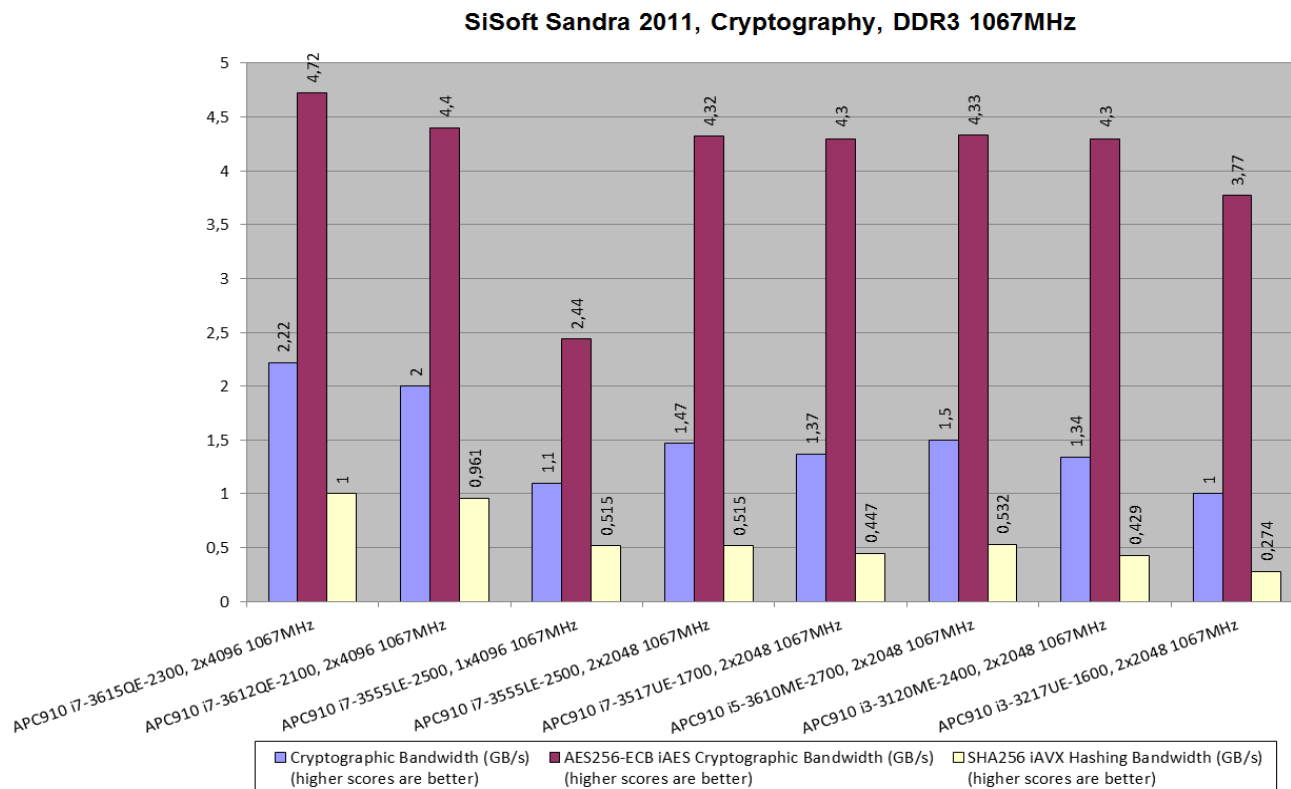

Figure 34: Results for SiSoft Sandra 2011, Cryptography, DDR3 1067MHz – APC910/PPC900

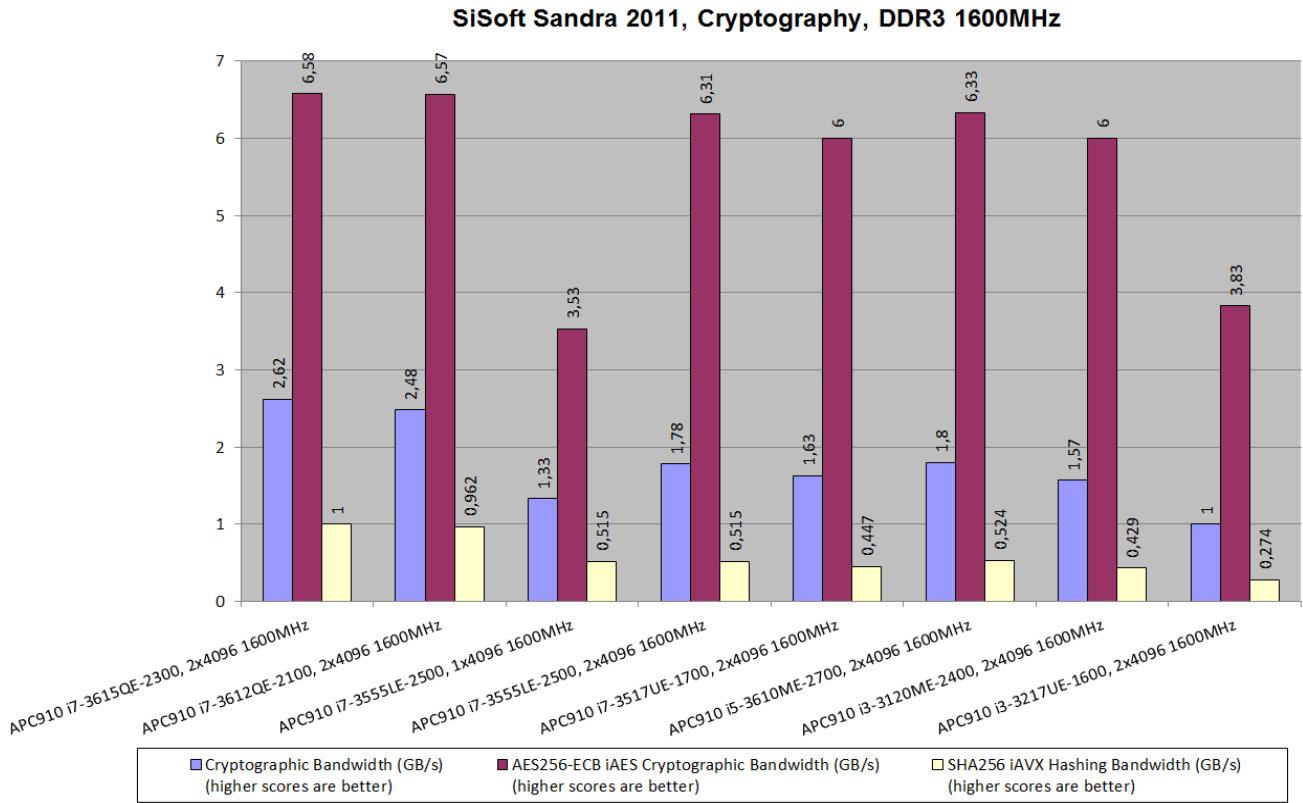

Figure 35: Results for SiSoft Sandra 2011, Cryptography, DDR3 1600MHz – APC910/PPC900

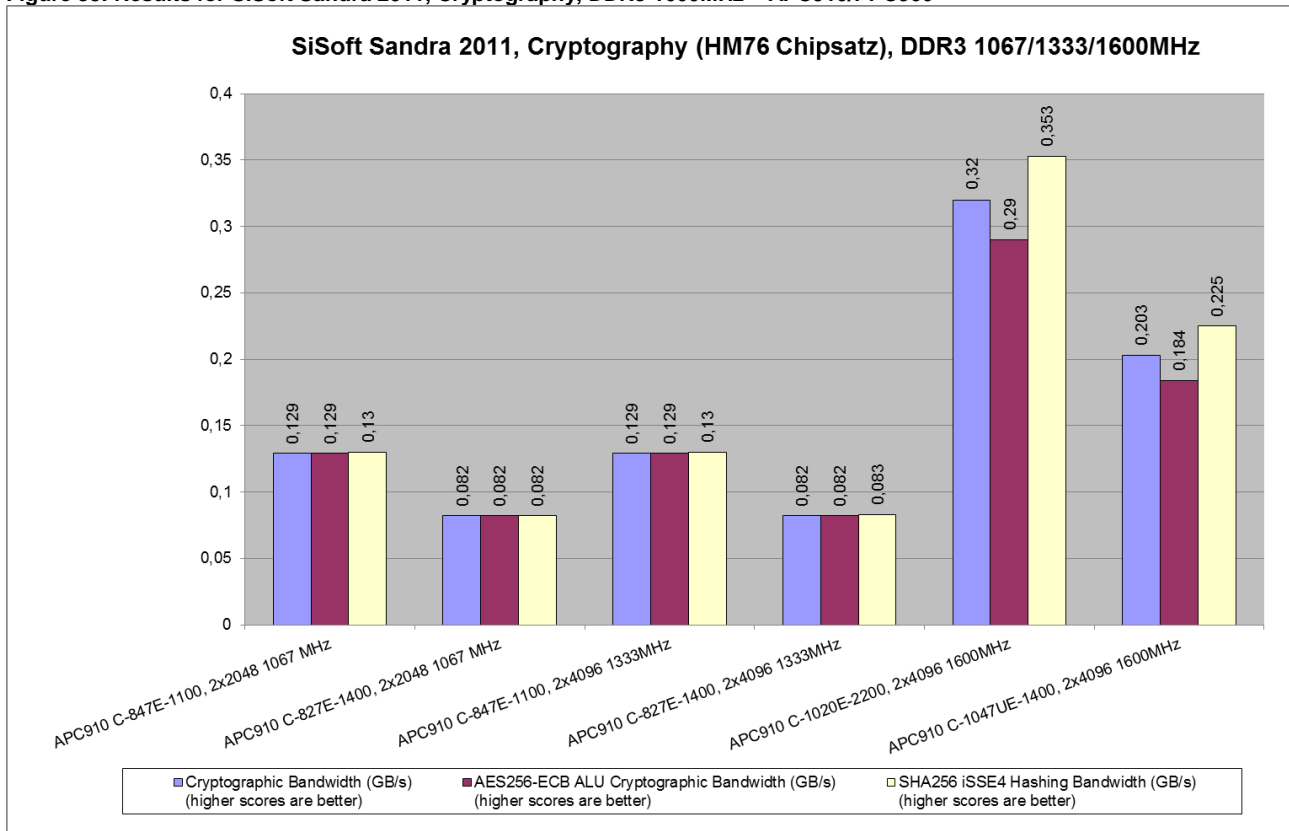

Figure 36: Results for SiSoft Sandra 2011, Cryptography (HM76 Chipset), DDR3 1067/1333/1600MHz – APC910/PPC900

4.12.1.5 Video Rendering

Benchmark the graphics performance of the video adapters (GFXs). Shows how your graphics processors handle rendering in comparison to other typical graphics processors. Such operations are used by all graphics software, image manipulation, video decoders/encoders, games and modern operating systems.

Higher scores are better

#	Test Device	Direct3D 9c			Direct3D 10		
		Shader Performance (MPixel/s)	Native Float Shader (MPixel/s)	Emulated Double Shader (MPixel/s)	Shader Performance (MPixel/s)	Native Float Shader (MPixel/s)	Emulated Double Shader (MPixel/s)
APC910 with INTEL QM77 Chipset							
37	i7-3615QE 4C 2.3/1.6GHz 6MB 45W 2x4096MB DDR3-SODIMM 1067MHz	55,74	144,13	21,56	53,42	131,54	21,7
38	i7-3615QE 4C 2.3/1.6GHz 6MB 45W 2x4096MB DDR3-SODIMM 1600MHz	56,1	145,87	21,58	53,69	132,54	21,5
39	i7-3612QE 4C 2.1/1.6GHz 6MB 35W, 2x4096MB DDR3-SODIMM 1067MHz	55,66	143,83	21,54	53,36	131,24	21,7
40	i7-3612QE 4C 2.1/1.6GHz 6MB 35W, 2x4096MB DDR3-SODIMM 1600MHz	56	145,73	21,57	53,72	132,7	21,75
41	i7-3555LE 2C 2.5/1.6GHz 4MB 25W, 4096MB DDR3-SODIMM 1067MHz	51,63	131	20,35	47,62	112	20,24
42	i7-3555LE 2C 2.5/1.6GHz 4MB 25W, 4096MB DDR3-SODIMM 1600MHz	52,54	135	20,43	49	117,3	20,4
43	i7-3555LE 2C 2.5/1.6GHz 4MB 25W, 2x2048MB DDR3-SODIMM 1067MHz	53	137,2	20,48	49,74	121	20,45
44	i7-3555LE 2C 2.5/1.6GHz 4MB 25W, 2x4096MB DDR3-SODIMM 1600MHz	53,37	138,84	20,52	50,55	124,19	20,57
45	i7-3517UE 2C 1.7/1.6GHz 4MB 17W, 2x2048MB DDR3-SODIMM 1067MHz	50,32	130,47	19,4	47,38	115,28	19,47
46	i7-3517UE 2C 1.7/1.6GHz 4MB 17W, 2x4096MB DDR3-SODIMM 1600MHz	50,52	131,17	19,46	48	117,9	19,58
47	i5-3610ME 2C 2.7/1.6GHz 3MB 35W, 2x2048MB DDR3-SODIMM 1067MHz	53	137	20,46	49,57	120,2	20,44
48	i5-3610ME 2C 2.7/1.6GHz 3MB 35W, 2x4096MB DDR3-SODIMM 1600MHz	53,38	139	20,51	50,53	124	20,58
49	i3-3120ME 2C 2.4/1.6GHz 3MB 35W, 2x2048MB DDR3-SODIMM 1067MHz	50,43	131	19,4	47,2	114,76	19,4
50	i3-3120ME 2C 2.4/1.6GHz 3MB 35W, 2x4096MB DDR3-SODIMM 1600MHz	50,87	133	19,45	48	117,75	19,53
51	i3-3217UE 2C 1.6/1.6GHz 3MB 17W, 2x2048MB DDR3-SODIMM 1067MHz	50,3	130,38	19,4	47	114	19,4
52	i3-3217UE 2C 1.6/1.6GHz 3MB 17W, 2x4096MB DDR3-SODIMM 1600MHz	50,5	131	19,45	47,61	116,36	19,48
APC910 with INTEL HM76 Chipset							
53	C-847E 2C 1.1/1.3GHz 2MB 17W 2x2048MB DDR3-SODIMM 1067MHz	9,49	26,24	3,43	9,4	25,54	3,46
54	C-847E 2C 1.1/1.3GHz 2MB 17W 2x4096MB DDR3-SODIMM 1333MHz	9,5	26,31	3,43	9,4	25,53	3,46
55	C-827E 1C 1.4/1.3GHz 1.5MB 17W 2x2048MB DDR3-SODIMM 1067MHz	9,46	26,23	3,41	9,4	25,35	3,48
56	C-827E 1C 1.4/1.3GHz 1.5MB 17W 2x4096MB DDR3-SODIMM 1333MHz	9,46	26,26	3,41	9,4	25,34	3,49
58	C-1047UE 2C 1.4/1.6GHz 2MB 17W 2x4096MB DDR3-SODIMM 1600MHz	17,76	43,53	7,24	18	43,7	7,4

59	C-1020E 2C 2.2/1.6GHz 2MB 35W 2x4096MB DDR3-SODIMM 1600MHz	19,74	48,36	8	20,1	49	8,23
----	---------------------------------------------------------------	-------	-------	---	------	----	------

Table 36: Results for SiSoft Sandra 2011, Video Rendering (Direct3D 9c/10 Devices) – APC910/PPC900

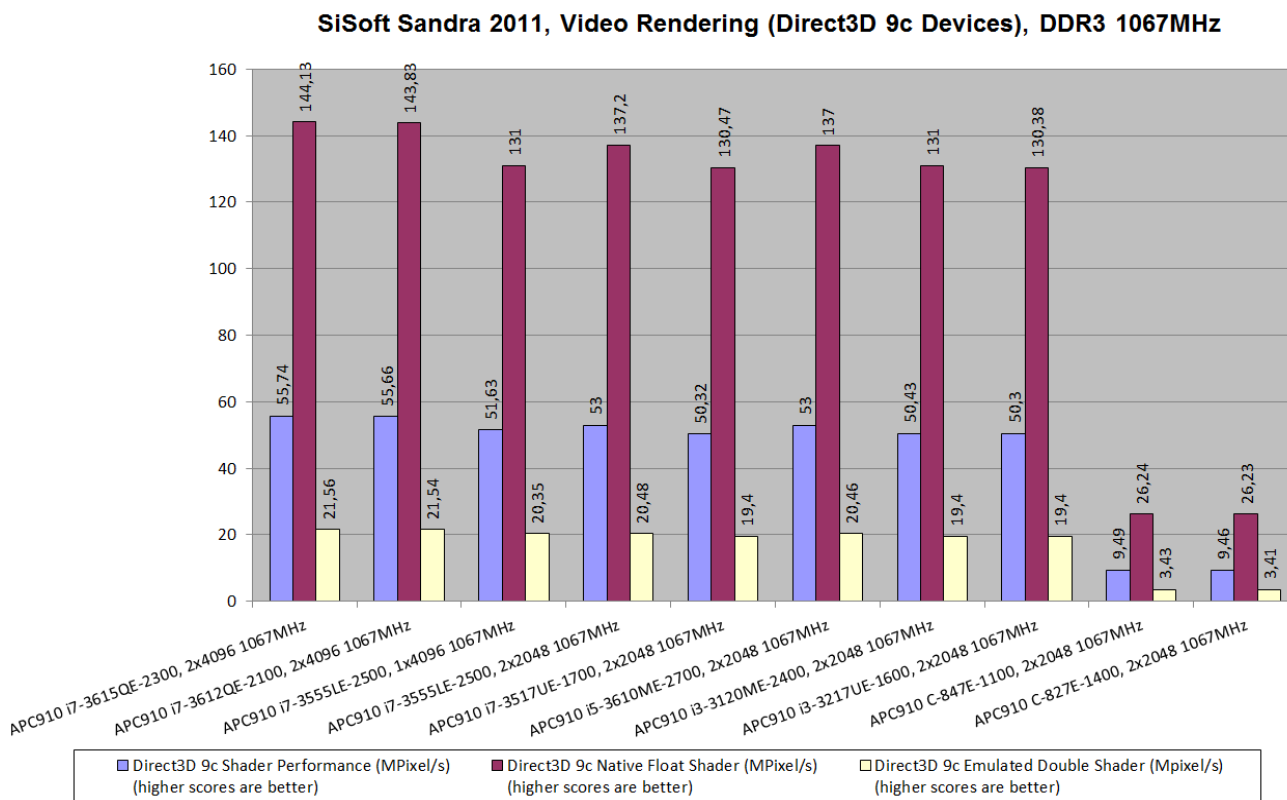

Figure 37: Results for SiSoft Sandra 2011, Video Rendering (Direct3D 9c Devices), DDR3 1067MHz – APC910/PPC900

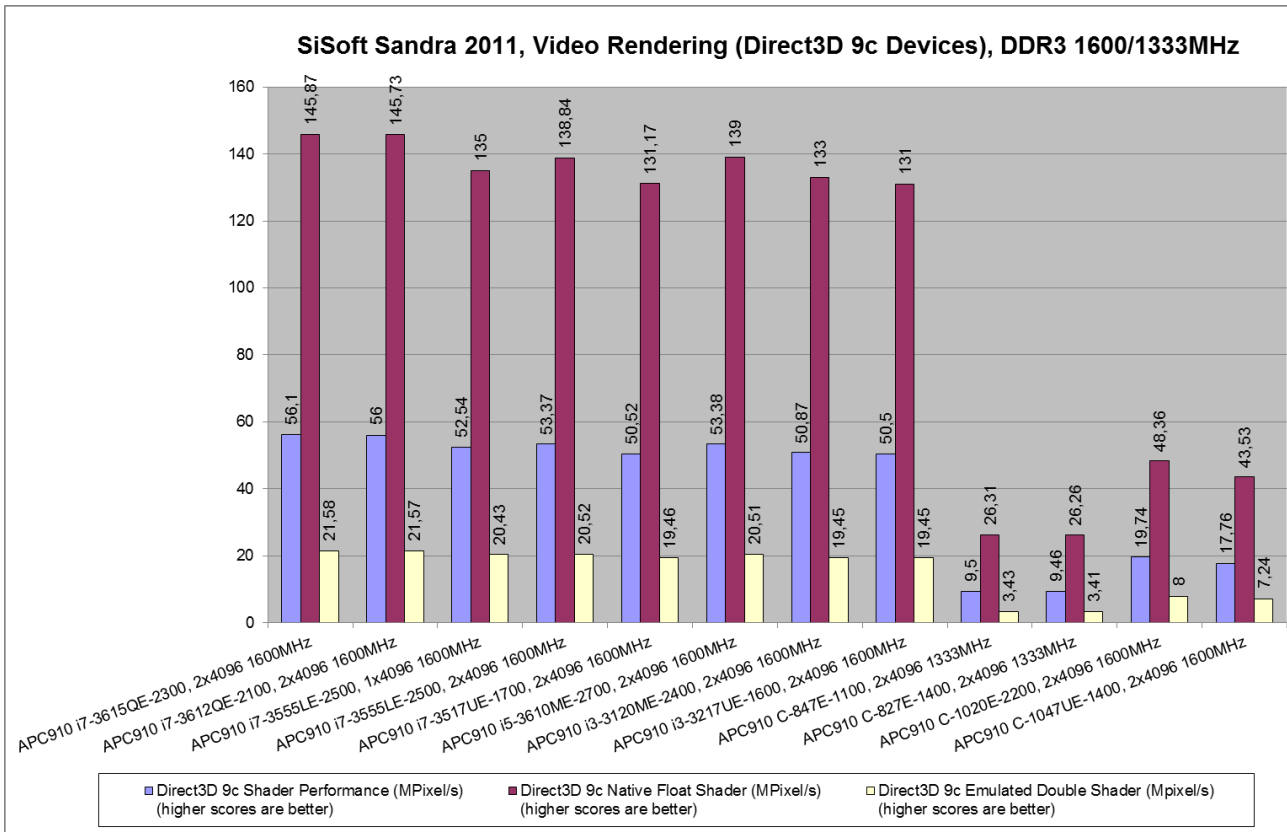

Figure 38: Results for SiSoft Sandra 2011, Video Rendering (Direct3D 9c Devices), DDR3 1600/1333MHz – APC910/PPC900

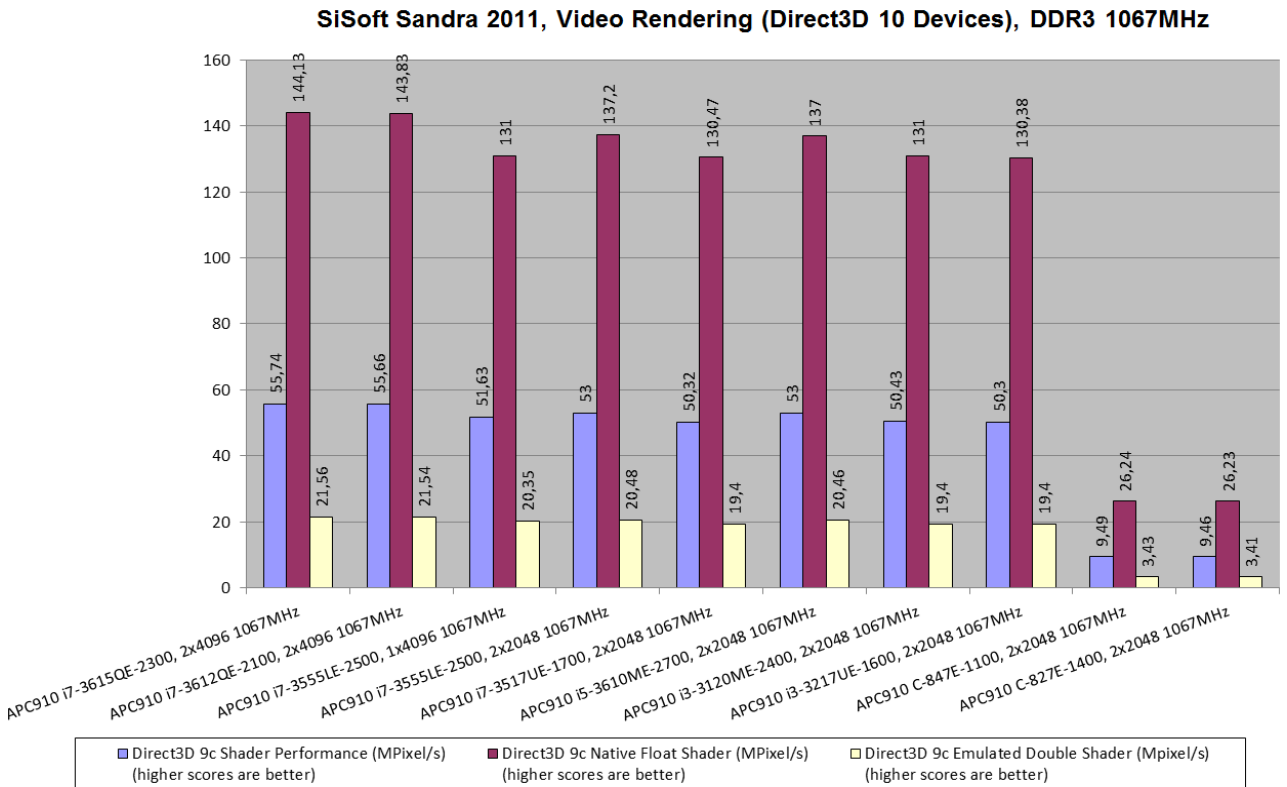

Figure 39: Results for SiSoft Sandra 2011, Video Rendering (Direct3D 10 Devices), DDR3 1067MHz – APC910/PPC900

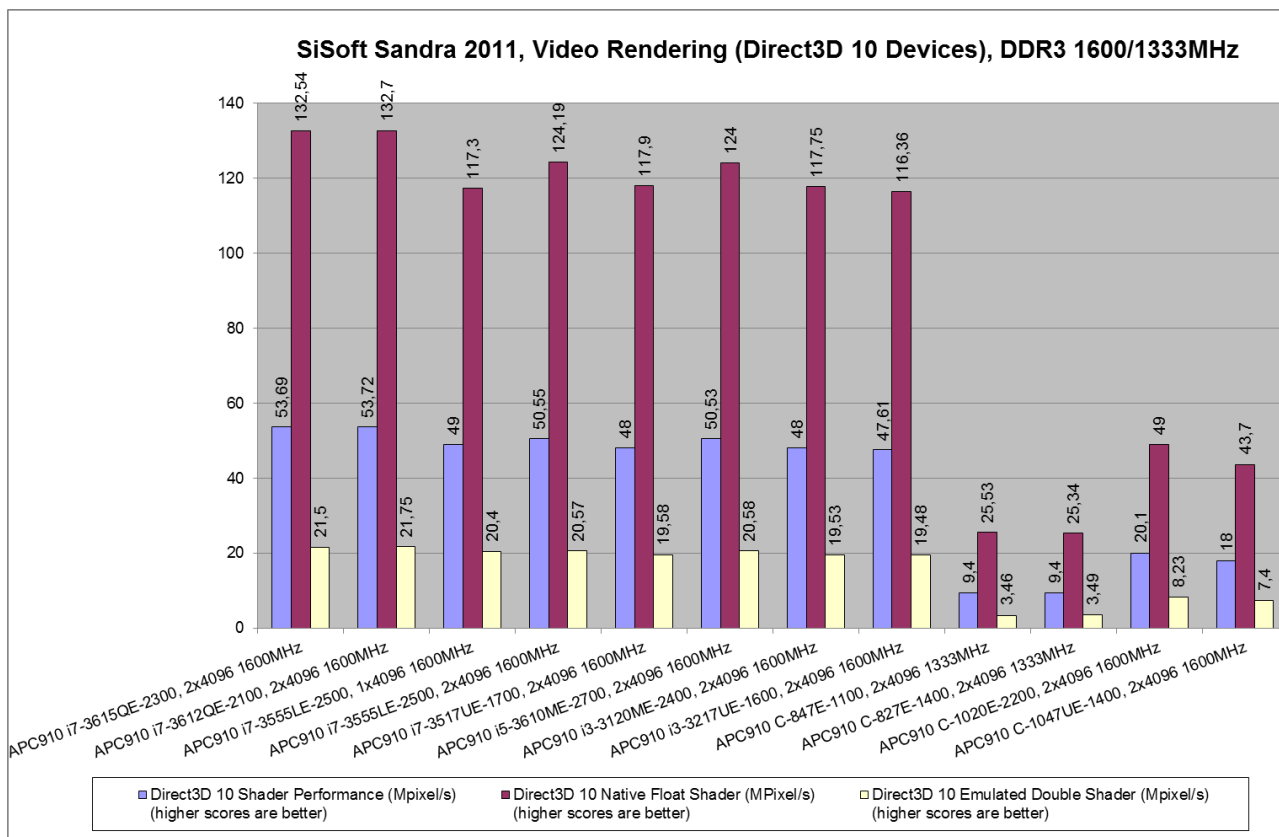

Figure 40: Results for SiSoft Sandra 2011, Video Rendering (Direct3D 10 Devices), DDR3 1600/1333MHz – APC910/PPC900

Higher scores are better

#	Test Device	Direct3D 10.1			Direct3D 11		
		Shader Performance (MPixel/s)	Native Float Shader (MPixel/s)	Emulated Double Shader (MPixel/s)	Shader Performance (MPixel/s)	Native Float Shader (MPixel/s)	Emulated Double Shader (MPixel/s)
APC910 with INTEL QM77 Chipset							
37	i7-3615QE 4C 2.3/1.6GHz 6MB 45W 2x4096MB DDR3-SODIMM 1067MHz	53,48	131,88	21,69	69,53	131	36,89
38	i7-3615QE 4C 2.3/1.6GHz 6MB 45W 2x4096MB DDR3-SODIMM 1600MHz	53,73	132,77	21,75	70,22	133	37
39	i7-3612QE 4C 2.1/1.6GHz 6MB 35W, 2x4096MB DDR3-SODIMM 1067MHz	53,37	131,4	21,68	69,33	130,83	36,74
40	i7-3612QE 4C 2.1/1.6GHz 6MB 35W, 2x4096MB DDR3-SODIMM 1600MHz	53,7	132,7	21,73	70,16	132,85	37
41	i7-3555LE 2C 2.5/1.6GHz 4MB 25W, 4096MB DDR3-SODIMM 1067MHz	47,64	112	20,26	61,53	112,14	33,76
42	i7-3555LE 2C 2.5/1.6GHz 4MB 25W, 4096MB DDR3-SODIMM 1600MHz	49	117,34	20,4	63,6	117,38	34,46
43	i7-3555LE 2C 2.5/1.6GHz 4MB 25W, 2x2048MB DDR3-SODIMM 1067MHz	49,77	121	20,47	65	121,16	34,87
44	i7-3555LE 2C 2.5/1.6GHz 4MB 25W, 2x4096MB DDR3-SODIMM 1600MHz	50,56	124,2	20,58	66	124,24	35
45	i7-3517UE 2C 1.7/1.6GHz 4MB 17W, 2x2048MB DDR3-SODIMM 1067MHz	47,35	115,3	19,44	61,88	115,6	33,13

46	i7-3517UE 2C 1.7/1.6GHz 4MB 17W, 2x4096MB DDR3-SODIMM 1600MHz	48	117,88	19,58	62,63	118	33,25
47	i5-3610ME 2C 2.7/1.6GHz 3MB 35W, 2x2048MB DDR3-SODIMM 1067MHz	49,63	120,46	20,44	64,74	120,66	34,74
48	i5-3610ME 2C 2.7/1.6GHz 3MB 35W, 2x4096MB DDR3-SODIMM 1600MHz	50,52	124	20,56	66	124,23	35
49	i3-3120ME 2C 2.4/1.6GHz 3MB 35W, 2x2048MB DDR3-SODIMM 1067MHz	47,2	114,71	19,42	61,4	114,86	32,81
50	i3-3120ME 2C 2.4/1.6GHz 3MB 35W, 2x4096MB DDR3-SODIMM 1600MHz	48	117,76	19,53	62,53	117,83	33,18
51	i3-3217UE 2C 1.6/1.6GHz 3MB 17W, 2x2048MB DDR3-SODIMM 1067MHz	47	114	19,4	61,25	114,29	32,82
52	i3-3217UE 2C 1.6/1.6GHz 3MB 17W, 2x4096MB DDR3-SODIMM 1600MHz	47,63	116,43	19,48	62,19	116,62	33,16
APC910 with INTEL HM76 Chipset							
53	C-847E 2C 1.1/1.3GHz 2MB 17W 2x2048MB DDR3-SODIMM 1067MHz	9,4	25,52	3,46	-	-	-
54	C-847E 2C 1.1/1.3GHz 2MB 17W 2x4096MB DDR3-SODIMM 1333MHz	9,4	25,55	3,46	-	-	-
55	C-827E 1C 1.4/1.3GHz 1.5MB 17W 2x2048MB DDR3-SODIMM 1067MHz	9,35	25,33	3,45	-	-	-
56	C-827E 1C 1.4/1.3GHz 1.5MB 17W 2x4096MB DDR3-SODIMM 1333MHz	9,38	25,24	3,49	-	-	-
58	C-1047UE 2C 1.4/1.6GHz 2MB 17W 2x4096MB DDR3-SODIMM 1600MHz	18	43,72	7,4	23,7	43,74	12,85
59	C-1020E 2C 2.2/1.6GHz 2MB 35W 2x4096MB DDR3-SODIMM 1600MHz	20	49	8,23	26,5	49,1	14,3

Table 37: Results for SiSoft Sandra 2011, Video Rendering (Direct3D 10.1/11 Devices) – APC910/PPC900

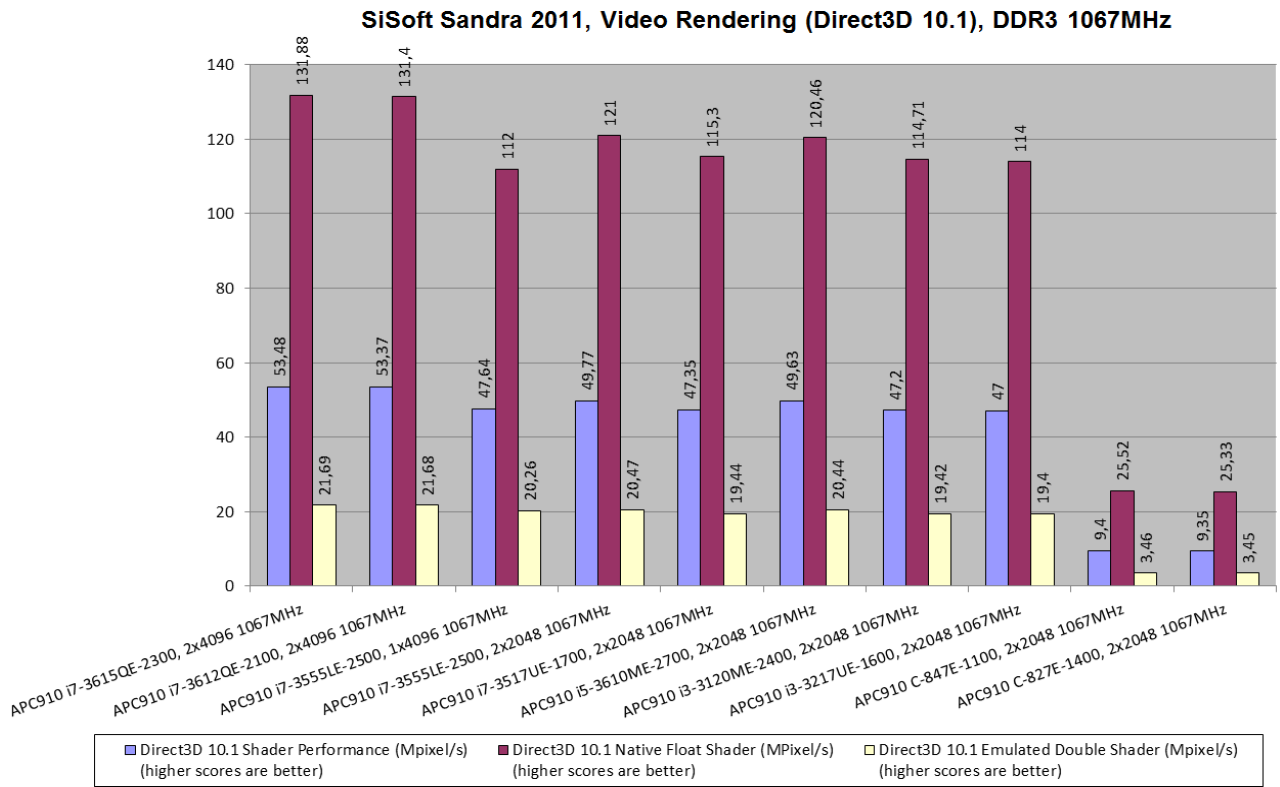

Figure 41: Results for SiSoft Sandra 2011, Video Rendering (Direct3D 10.1 Devices), DDR3 1067MHz – APC910/PPC900

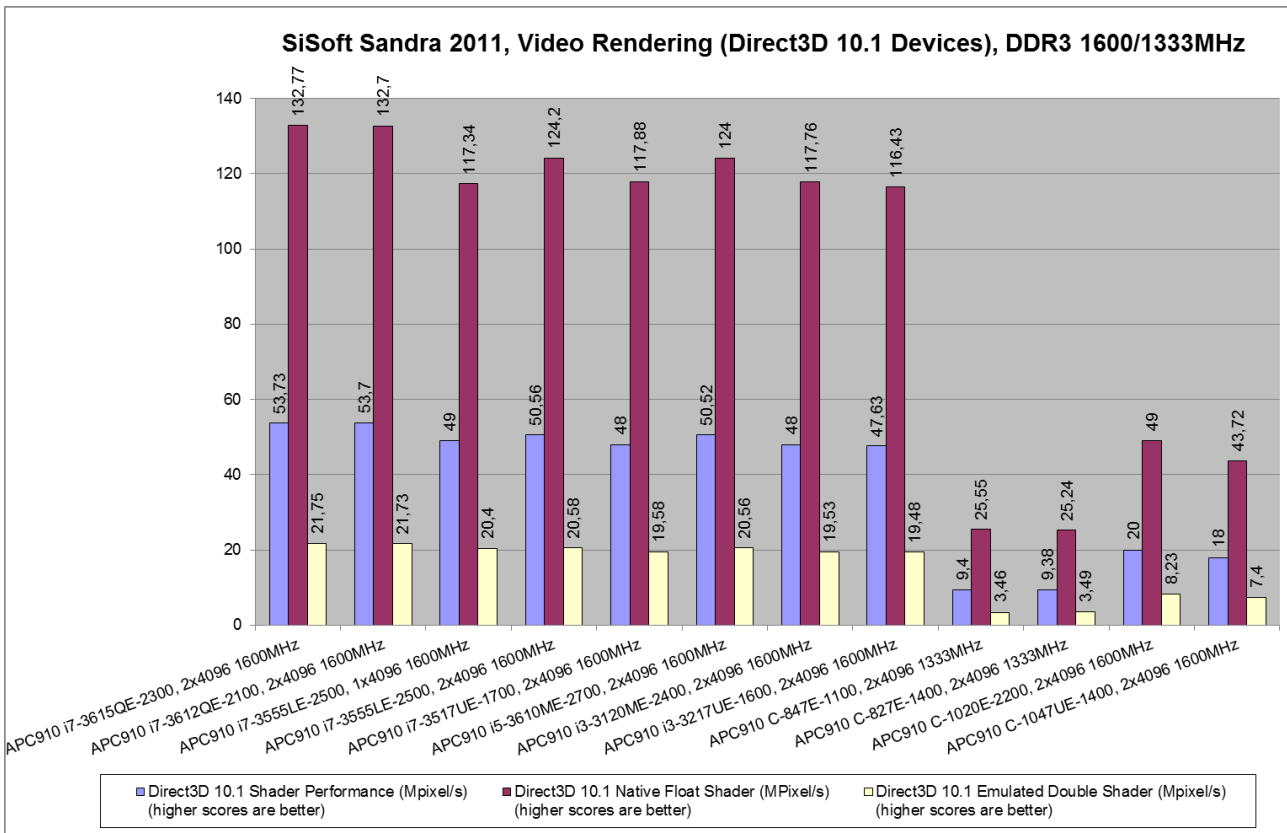

Figure 42: Results for SiSoft Sandra 2011, Video Rendering (Direct3D 10.1 Devices), DDR3 1600/1333MHz – APC910/PPC900

SiSoft Sandra 2011, Video Rendering (Direct3D 11 Devices), DDR3 1067MHz

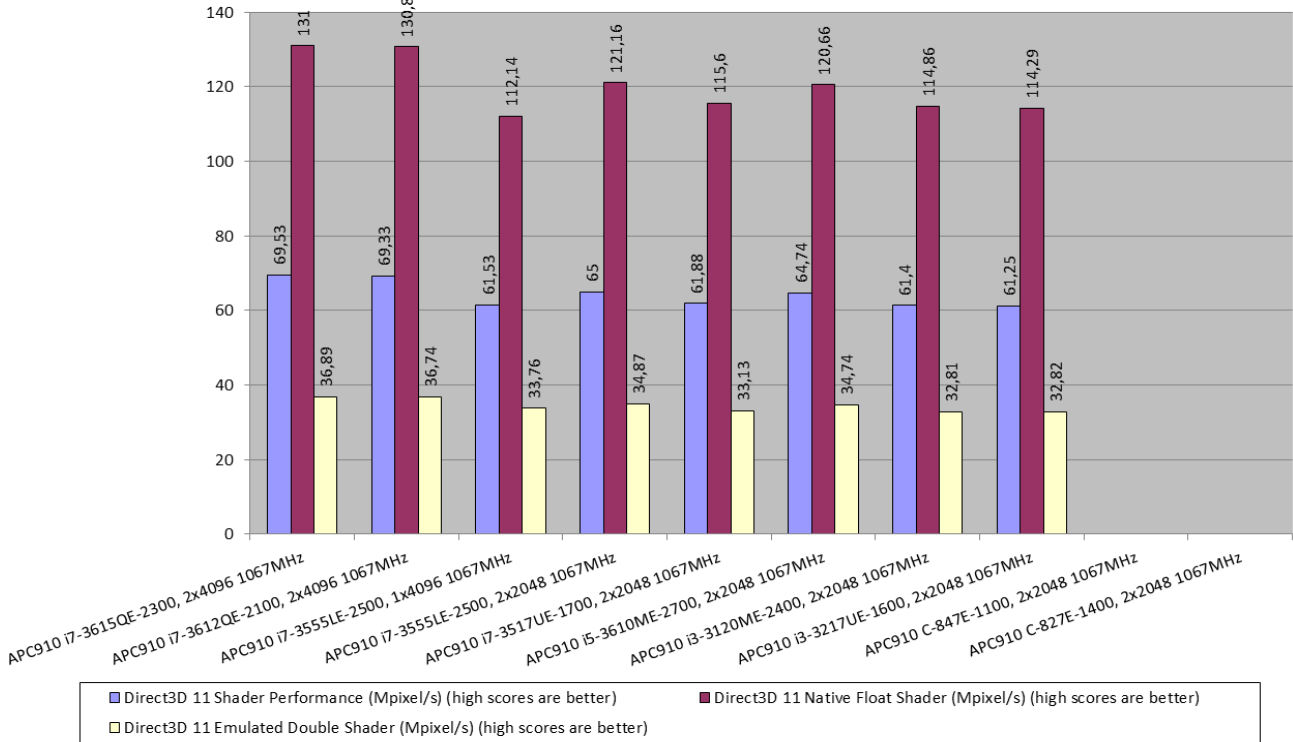

Figure 43: Results for SiSoft Sandra 2011, Video Rendering (Direct3D 11 Devices), DDR3 1067MHz – APC910/PPC900

SiSoft Sandra 2011, Video Rendering (Direct3D 11 Devices), DDR3 1600MHz

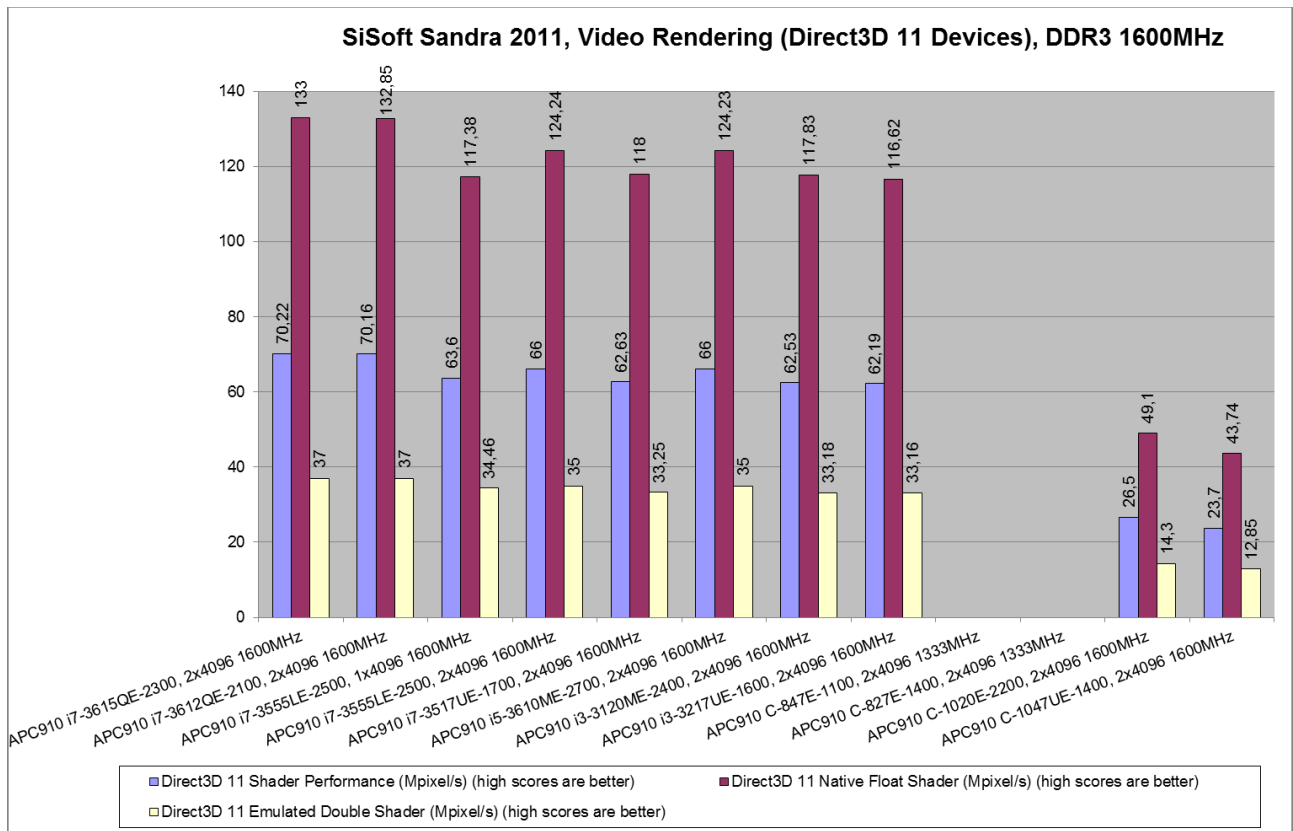

Figure 44: Results for SiSoft Sandra 2011, Video Rendering (Direct3D 11 Devices), DDR3 1600MHz – APC910/PPC900

4.12.1.6 Video Memory Bandwidth

Benchmark the bandwidth of the memory of the video adapters (GFXs) and the bandwidth of the bus that connects them to your computer. Shows how your video adapters' memory bandwidth compares to other video sub-systems in terms of bandwidth.

Higher scores are better

#	Test device	Direct3D 10			Direct3D 10.1		
		Performance (GB/s)	Bandwidth internal Memory (GB/s)	Data Transfer (GB/s)	Performance (GB/s)	Bandwidth internal Memory (GB/s)	Data Transfer (GB/s)
APC910 with INTEL QM77 Chipset							
37	i7-3615QE 4C 2.3/1.6GHz 6MB 45W 2x4096MB DDR3-SODIMM 1067MHz	8,5	15,39	4,7	8,47	15,24	4,7
38	i7-3615QE 4C 2.3/1.6GHz 6MB 45W 2x4096MB DDR3-SODIMM 1600MHz	10,4	20,44	5,29	10,36	20,68	5,18
39	i7-3612QE 4C 2.1/1.6GHz 6MB 35W, 2x4096MB DDR3-SODIMM 1067MHz	8	14,14	4,46	8	14,22	4,44
40	i7-3612QE 4C 2.1/1.6GHz 6MB 35W, 2x4096MB DDR3-SODIMM 1600MHz	10,24	20,17	5,2	10,26	20,18	5,21
41	i7-3555LE 2C 2.5/1.6GHz 4MB 25W, 4096MB DDR3-SODIMM 1067MHz	4	6,86	2,3	4	6,85	2,33
42	i7-3555LE 2C 2.5/1.6GHz 4MB 25W, 4096MB DDR3-SODIMM 1600MHz	5,4	9	3,2	5,4	9,17	3,2
43	i7-3555LE 2C 2.5/1.6GHz 4MB 25W, 2x2048MB DDR3-SODIMM 1067MHz	7	12	4,17	7	12	4,13
44	i7-3555LE 2C 2.5/1.6GHz 4MB 25W, 2x4096MB DDR3-SODIMM 1600MHz	9	17,37	4,76	8,87	16,4	4,8
45	i7-3517UE 2C 1.7/1.6GHz 4MB 17W, 2x2048MB DDR3-SODIMM 1067MHz	7	12,17	4	7	12,2	4
46	i7-3517UE 2C 1.7/1.6GHz 4MB 17W, 2x4096MB DDR3-SODIMM 1600MHz	8,88	17	4,64	8,81	16,75	4,64
47	i5-3610ME 2C 2.7/1.6GHz 3MB 35W, 2x2048MB DDR3-SODIMM 1067MHz	7,12	12,15	4,17	7	12	4
48	i5-3610ME 2C 2.7/1.6GHz 3MB 35W, 2x4096MB DDR3-SODIMM 1600MHz	9	16,87	4,81	9,16	17	5
49	i3-3120ME 2C 2.4/1.6GHz 3MB 35W, 2x2048MB DDR3-SODIMM 1067MHz	7	12	4	6,9	12	4
50	i3-3120ME 2C 2.4/1.6GHz 3MB 35W, 2x4096MB DDR3-SODIMM 1600MHz	8,67	16,22	4,36	8,72	16,67	4,56
51	i3-3217UE 2C 1.6/1.6GHz 3MB 17W, 2x2048MB DDR3-SODIMM 1067MHz	6,52	11,3	3,77	6,5	11,3	3,74
52	i3-3217UE 2C 1.6/1.6GHz 3MB 17W, 2x4096MB DDR3-SODIMM 1600MHz	7,56	13,58	4,2	7,53	13,59	4,18
APC910 with INTEL HM76 Chipset							
53	C-847E 2C 1.1/1.3GHz 2MB 17W 2x2048MB DDR3-SODIMM 1067MHz	3,1	6,47	1,5	3,13	6,54	1,5
54	C-847E 2C 1.1/1.3GHz 2MB 17W 2x4096MB DDR3-SODIMM 1333MHz	3,17	6,63	1,52	3,16	6,62	1,51
55	C-827E 1C 1.4/1.3GHz 1.5MB 17W 2x2048MB DDR3-SODIMM 1067MHz	2,76	5,12	1,49	2,77	5,13	1,49
56	C-827E 1C 1.4/1.3GHz 1.5MB 17W 2x4096MB DDR3-SODIMM 1333MHz	2,82	5,23	1,52	2,82	5,25	1,52
58	C-1047UE 2C 1.4/1.6GHz 2MB 17W 2x4096MB DDR3-SODIMM 1600MHz	6,15	11,89	3,18	6,18	12	3,2

59	C-1020E 2C 2.2/1.6GHz 2MB 35W 2x4096MB DDR3-SODIMM 1600MHz	8	16,5	3,8	7,9	16,47	3,79
----	---------------------------------------------------------------	---	------	-----	-----	-------	------

Table 38: Results for SiSoft Sandra 2011, Video Memory Bandwidth (Direct3D 10/10.1 Devices) – APC910/PPC900

Higher scores are better

#	Test device	Direct3D 11 Performance (GB/s)	Direct3D 11 Bandwidth internal Memory (GB/s)	Direct3D 11 Data Transfer (GB/s)
APC910 with INTEL QM77 Chipset				
37	i7-3615QE 4C 2.3/1.6GHz 6MB 45W 2x4096MB DDR3-SODIMM 1067MHz	8,68	15,4	4,9
38	i7-3615QE 4C 2.3/1.6GHz 6MB 45W 2x4096MB DDR3-SODIMM 1600MHz	10,52	20,44	5,4
39	i7-3612QE 4C 2.1/1.6GHz 6MB 35W, 2x4096MB DDR3-SODIMM 1067MHz	8	14,1	4,6
40	i7-3612QE 4C 2.1/1.6GHz 6MB 35W, 2x4096MB DDR3-SODIMM 1600MHz	10,39	20,15	5,35
41	i7-3555LE 2C 2.5/1.6GHz 4MB 25W, 4096MB DDR3-SODIMM 1067MHz	4	6,89	2,34
42	i7-3555LE 2C 2.5/1.6GHz 4MB 25W, 4096MB DDR3-SODIMM 1600MHz	5,47	9,2	3,2
43	i7-3555LE 2C 2.5/1.6GHz 4MB 25W, 2x2048MB DDR3-SODIMM 1067MHz	7,16	12	4,26
44	i7-3555LE 2C 2.5/1.6GHz 4MB 25W, 2x4096MB DDR3-SODIMM 1600MHz	9	16,46	4,89
45	i7-3517UE 2C 1.7/1.6GHz 4MB 17W, 2x2048MB DDR3-SODIMM 1067MHz	7	12,15	4,26
46	i7-3517UE 2C 1.7/1.6GHz 4MB 17W, 2x4096MB DDR3-SODIMM 1600MHz	9	16,86	4,7
47	i5-3610ME 2C 2.7/1.6GHz 3MB 35W, 2x2048MB DDR3-SODIMM 1067MHz	7,18	12,23	4,22
48	i5-3610ME 2C 2.7/1.6GHz 3MB 35W, 2x4096MB DDR3-SODIMM 1600MHz	9,14	16,83	5
49	i3-3120ME 2C 2.4/1.6GHz 3MB 35W, 2x2048MB DDR3-SODIMM 1067MHz	7	12	4
50	i3-3120ME 2C 2.4/1.6GHz 3MB 35W, 2x4096MB DDR3-SODIMM 1600MHz	8,77	16,6	4,63
51	i3-3217UE 2C 1.6/1.6GHz 3MB 17W, 2x2048MB DDR3-SODIMM 1067MHz	6,55	11,28	3,8
52	i3-3217UE 2C 1.6/1.6GHz 3MB 17W, 2x4096MB DDR3-SODIMM 1600MHz	7,68	13,59	4,34
APC910 with INTEL HM76 Chipset				
53	C-847E 2C 1.1/1.3GHz 2MB 17W 2x2048MB DDR3-SODIMM 1067MHz	3,14	6,56	1,49
54	C-847E 2C 1.1/1.3GHz 2MB 17W 2x4096MB DDR3-SODIMM 1333MHz	3,19	6,64	1,51
55	C-827E 1C 1.4/1.3GHz 1.5MB 17W 2x2048MB DDR3-SODIMM 1067MHz	2,8	5,14	1,52
56	C-827E 1C 1.4/1.3GHz 1.5MB 17W 2x4096MB DDR3-SODIMM 1333MHz	2,84	5,28	1,52
58	C-1047UE 2C 1.4/1.6GHz 2MB 17W 2x4096MB DDR3-SODIMM 1600MHz	6,27	12	3,3
59	C-1020E 2C 2.2/1.6GHz 2MB 35W 2x4096MB DDR3-SODIMM 1600MHz	8	16,66	3,87

Table 39: Results SiSoft Sandra 2011, Video Memory Bandwidth (Direct3D 11 Devices) – APC910/PPC900

SiSoft Sandra 2011, Video Memory Bandwidth (Direct3D 10 Devices), DDR3 1067MHz

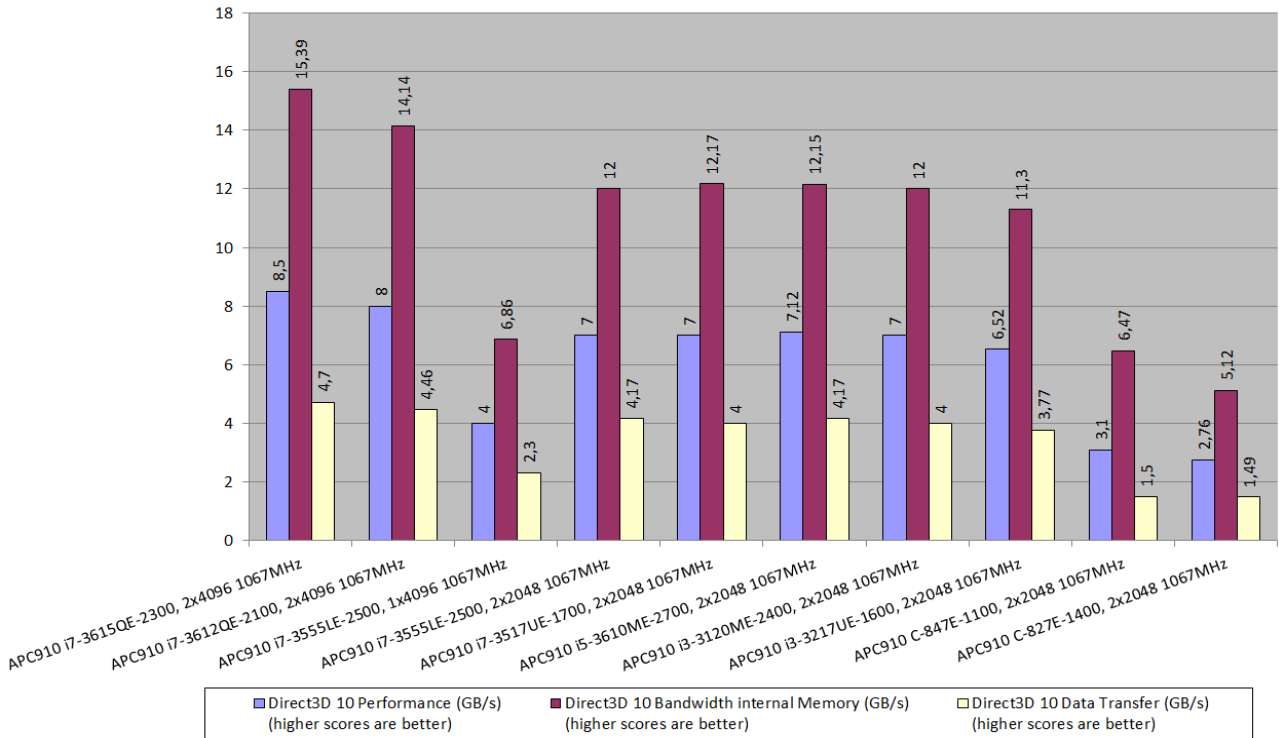

Figure 45: Results for SiSoft Sandra 2011, Video Memory Bandwidth (Direct3D 10 Devices), DDR3 1067MHz – APC910/PPC900

SiSoft Sandra 2011, Video Memory Bandwidth (Direct3D 10 Devices), DDR3 1600/1333MHz

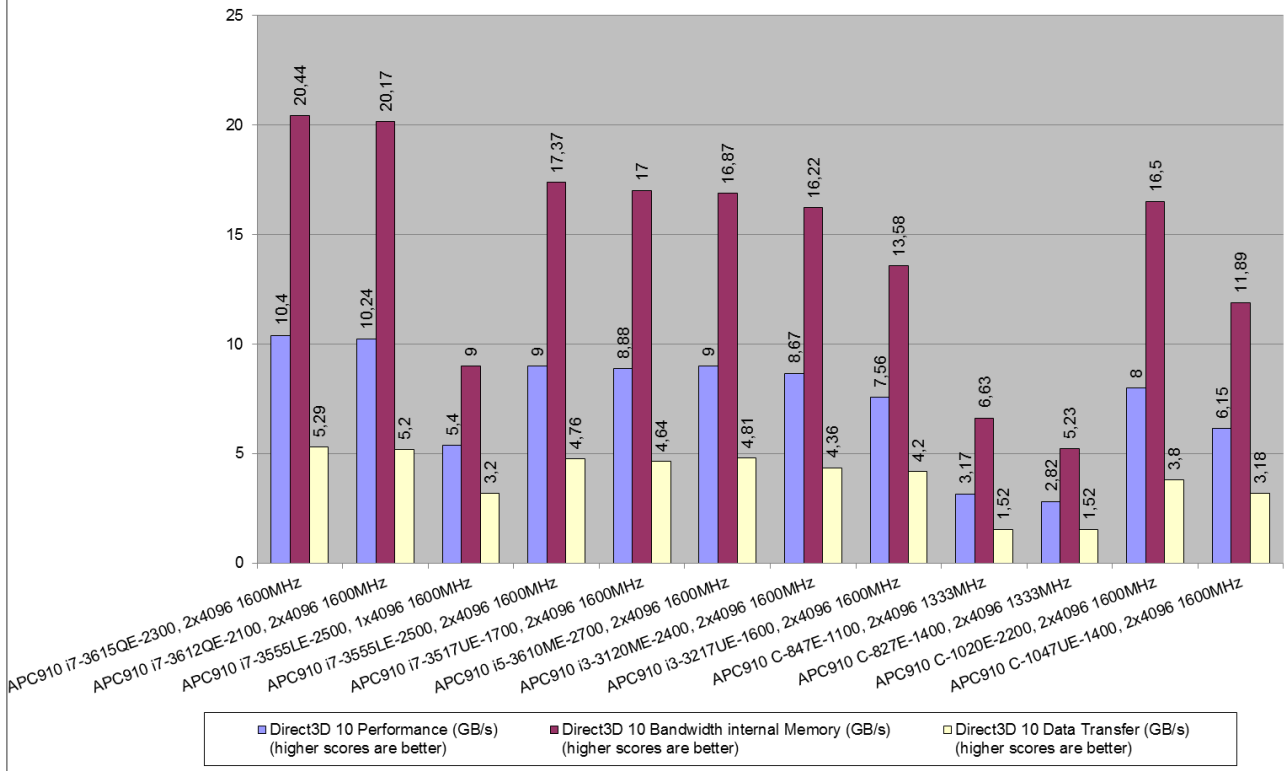

Figure 46: Results for SiSoft Sandra 2011, Video Memory Bandwidth (Direct3D 10 Devices), DDR3 1600/1333MHz – APC910/PPC900

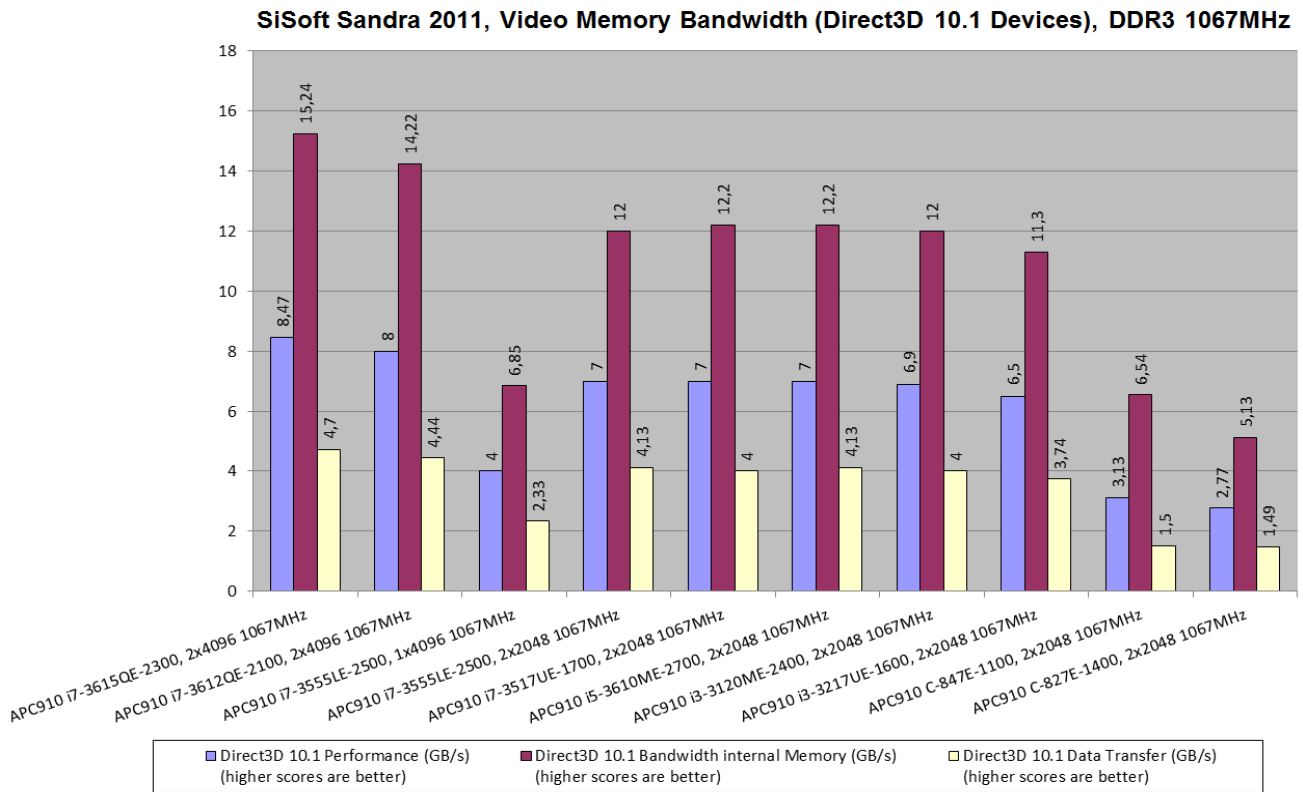

Figure 47: Results SiSoft Sandra 2011, Video Memory Bandwidth (Direct3D 10.1 Devices), DDR3 1067MHz – APC910/PPC900

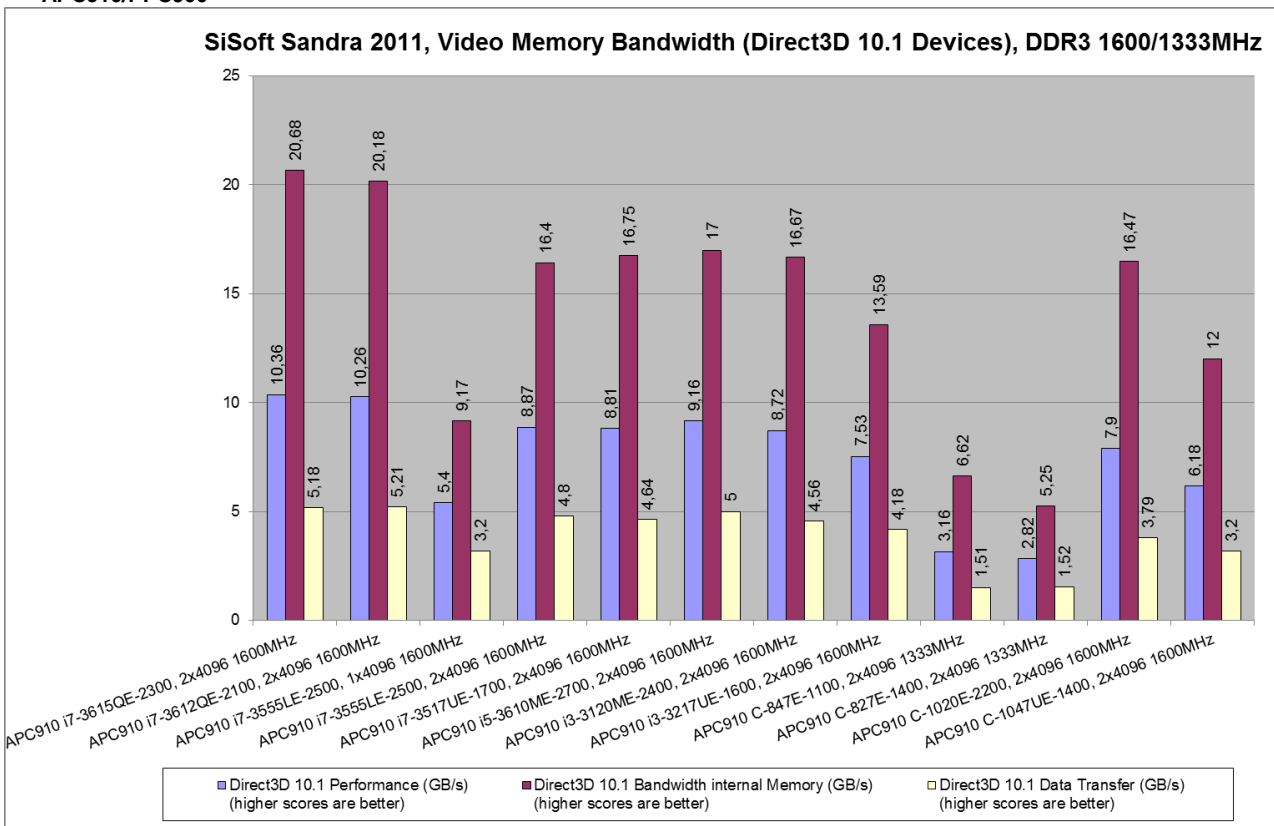

Figure 48: Results for SiSoft Sandra 2011, Video Memory Bandwidth (Direct3D 10.1 Devices), DDR3 1600/1333MHz – APC910/PPC900

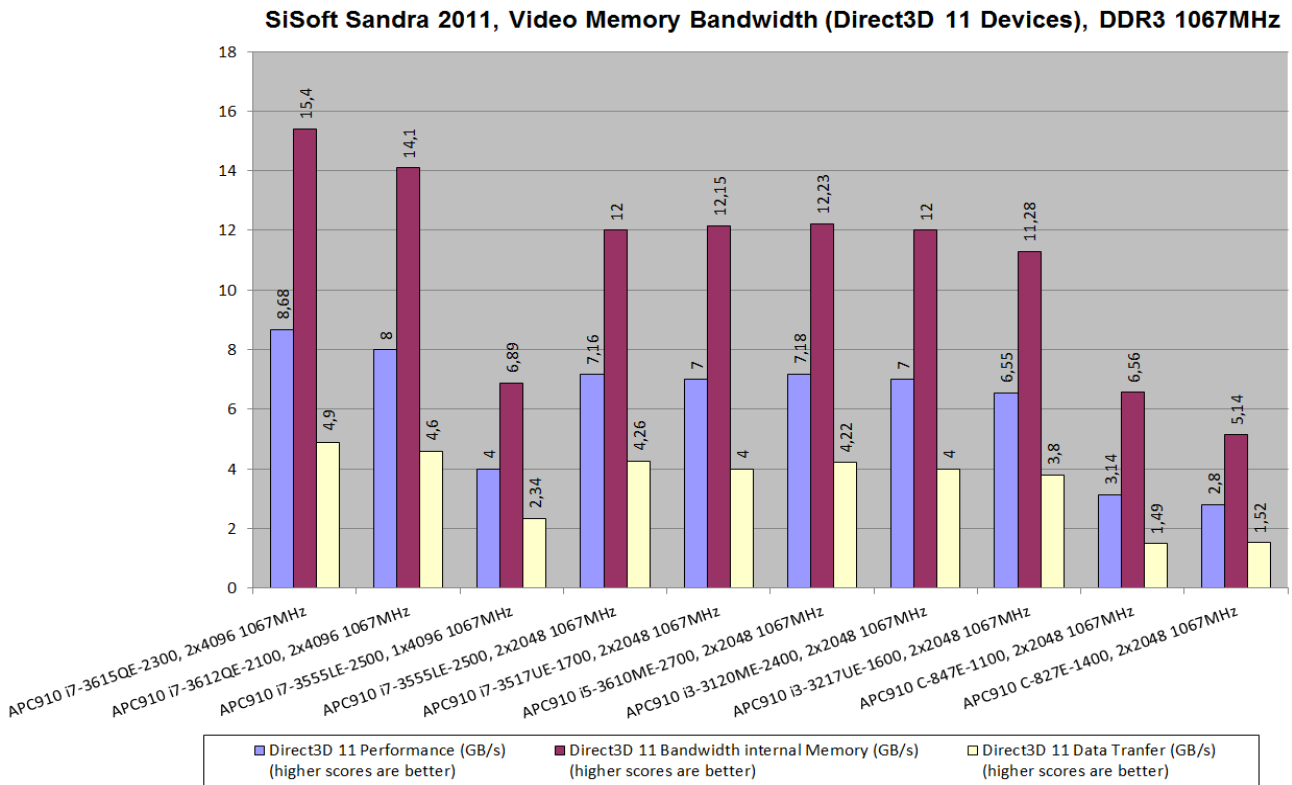

Figure 49: Results for SiSoft Sandra 2011, Video Memory Bandwidth (Direct3D 11 Devices), DDR3 1067MHz – APC910/PPC900

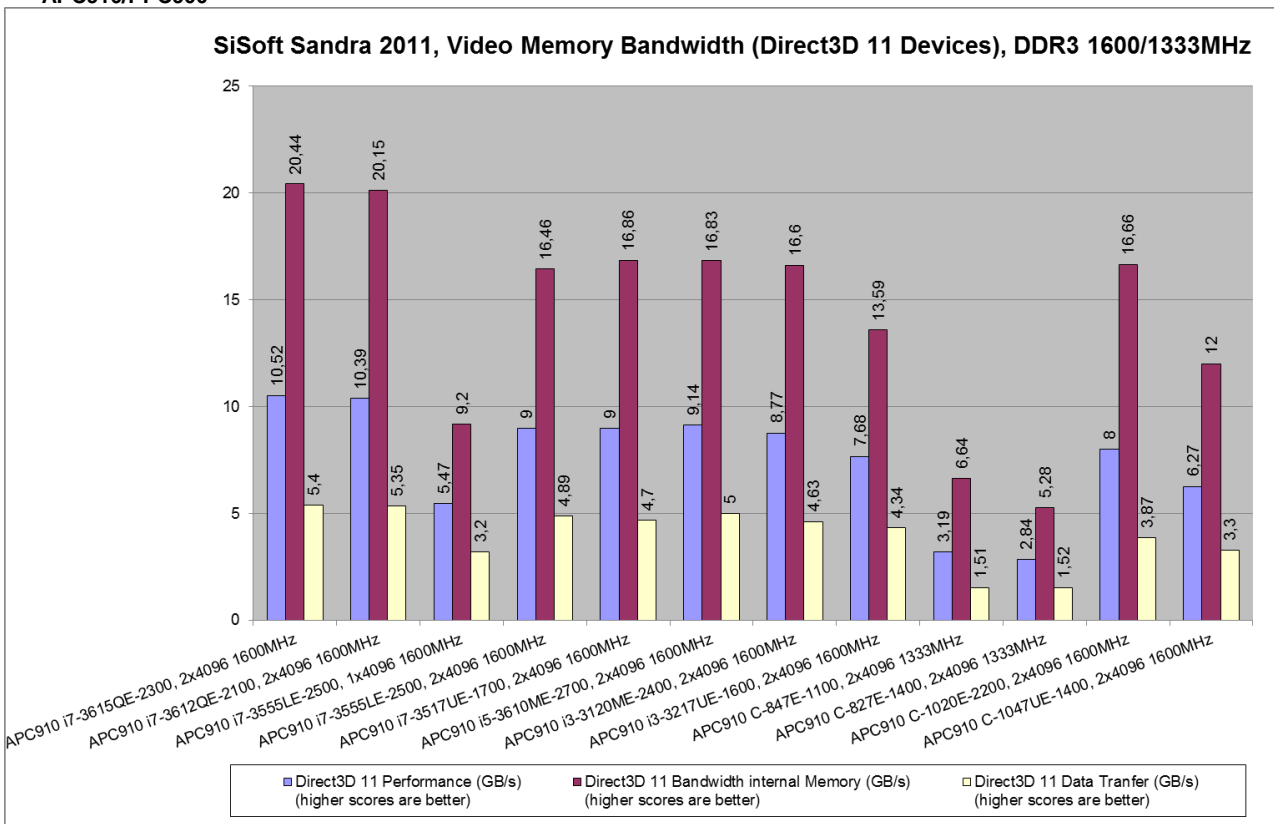

Figure 50: Results for SiSoft Sandra 2011, Video Memory Bandwidth (Direct3D 11 Devices), DDR3 1600/1333MHz – APC910/PPC900

4.12.1.7 Memory Bandwidth

Benchmark the memory bandwidth of your computer. Shows how your memory sub-systems compare to other computers in terms of bandwidth.

Higher scores are better

#	Test device	Memory Performance (GB/s)	Integer B/F iAVX/128 Memory Bandwidth (GB/s)	Float B/F iAVX/128 Memory Bandwidth (GB/s)
APC910 with INTEL QM77 Chipset				
37	i7-3615QE 4C 2.3/1.6GHz 6MB 45W 2x4096MB DDR3-SODIMM 1067MHz	14,18	14,18	14,19
38	i7-3615QE 4C 2.3/1.6GHz 6MB 45W 2x4096MB DDR3-SODIMM 1600MHz	20,1	20,1	20,1
39	i7-3612QE 4C 2.1/1.6GHz 6MB 35W, 2x4096MB DDR3-SODIMM 1067MHz	13,39	13,39	13,39
40	i7-3612QE 4C 2.1/1.6GHz 6MB 35W, 2x4096MB DDR3-SODIMM 1600MHz	20	20	20
41	i7-3555LE 2C 2.5/1.6GHz 4MB 25W, 4096MB DDR3-SODIMM 1067MHz	7,23	7,22	7,24
42	i7-3555LE 2C 2.5/1.6GHz 4MB 25W, 4096MB DDR3-SODIMM 1600MHz	10,66	10,66	10,66
43	i7-3555LE 2C 2.5/1.6GHz 4MB 25W, 2x2048MB DDR3-SODIMM 1067MHz	13,4	13,42	13,38
44	i7-3555LE 2C 2.5/1.6GHz 4MB 25W, 2x4096MB DDR3-SODIMM 1600MHz	20,27	20,25	20,28
45	i7-3517UE 2C 1.7/1.6GHz 4MB 17W, 2x2048MB DDR3-SODIMM 1067MHz	13,42	13,41	13,43
46	i7-3517UE 2C 1.7/1.6GHz 4MB 17W, 2x4096MB DDR3-SODIMM 1600MHz	20,19	20,2	20,19
47	i5-3610ME 2C 2.7/1.6GHz 3MB 35W, 2x2048MB DDR3-SODIMM 1067MHz	13,38	13,36	13,4
48	i5-3610ME 2C 2.7/1.6GHz 3MB 35W, 2x4096MB DDR3-SODIMM 1600MHz	20,28	20,28	20,27
49	i3-3120ME 2C 2.4/1.6GHz 3MB 35W, 2x2048MB DDR3-SODIMM 1067MHz	13,3	13,3	13,3
50	i3-3120ME 2C 2.4/1.6GHz 3MB 35W, 2x4096MB DDR3-SODIMM 1600MHz	19,72	19,75	19,68
51	i3-3217UE 2C 1.6/1.6GHz 3MB 17W, 2x2048MB DDR3-SODIMM 1067MHz	13	13	13
52	i3-3217UE 2C 1.6/1.6GHz 3MB 17W, 2x4096MB DDR3-SODIMM 1600MHz	15,73	16	15,42
		Memory Performance (GB/s)	Integer B/F iSSE2 Memory Bandwidth (GB/s)	Float B/F iSSE2 Memory Bandwidth (GB/s)
APC910 with INTEL HM76 Chipset				
53	C-847E 2C 1.1/1.3GHz 2MB 17W 2x2048MB DDR3-SODIMM 1067MHz	10	10	10
54	C-847E 2C 1.1/1.3GHz 2MB 17W 2x4096MB DDR3-SODIMM 1333MHz	10,26	10,26	10,26
55	C-827E 1C 1.4/1.3GHz 1.5MB 17W 2x2048MB DDR3-SODIMM 1067MHz	6,28	6,28	6,27
56	C-827E 1C 1.4/1.3GHz 1.5MB 17W 2x4096MB DDR3-SODIMM 1333MHz	6,38	6,37	6,38
58	C-1047UE 2C 1.4/1.6GHz 2MB 17W 2x4096MB DDR3-SODIMM 1600MHz	13,66	13,65	13,66

#	Test device	Memory Performance (GB/s)	Integer B/F iAVX/128 Memory Bandwidth (GB/s)	Float B/F iAVX/128 Memory Bandwidth (GB/s)
59	C-1020E 2C 2.2/1.6GHz 2MB 35W 2x4096MB DDR3-SODIMM 1600MHz	19	19	19

Table 40: Results for SiSoft Sandra 2011, Memory Bandwidth – APC910/PPC900

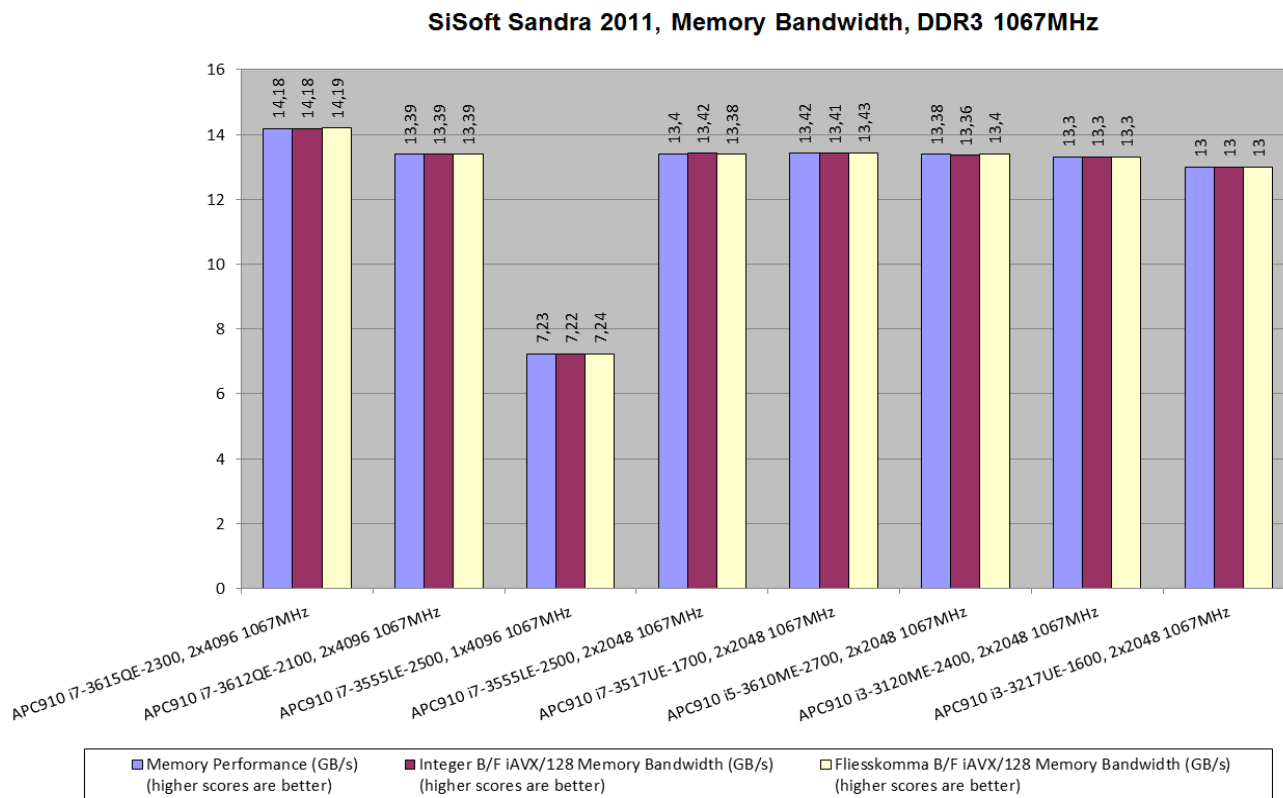

Figure 51: Results for SiSoft Sandra 2011, Memory Bandwidth (QM77 Chipset), DDR3 1067MHz – APC910/PPC900

SiSoft Sandra 2011, Memory Bandwidth, DDR3 1600MHz

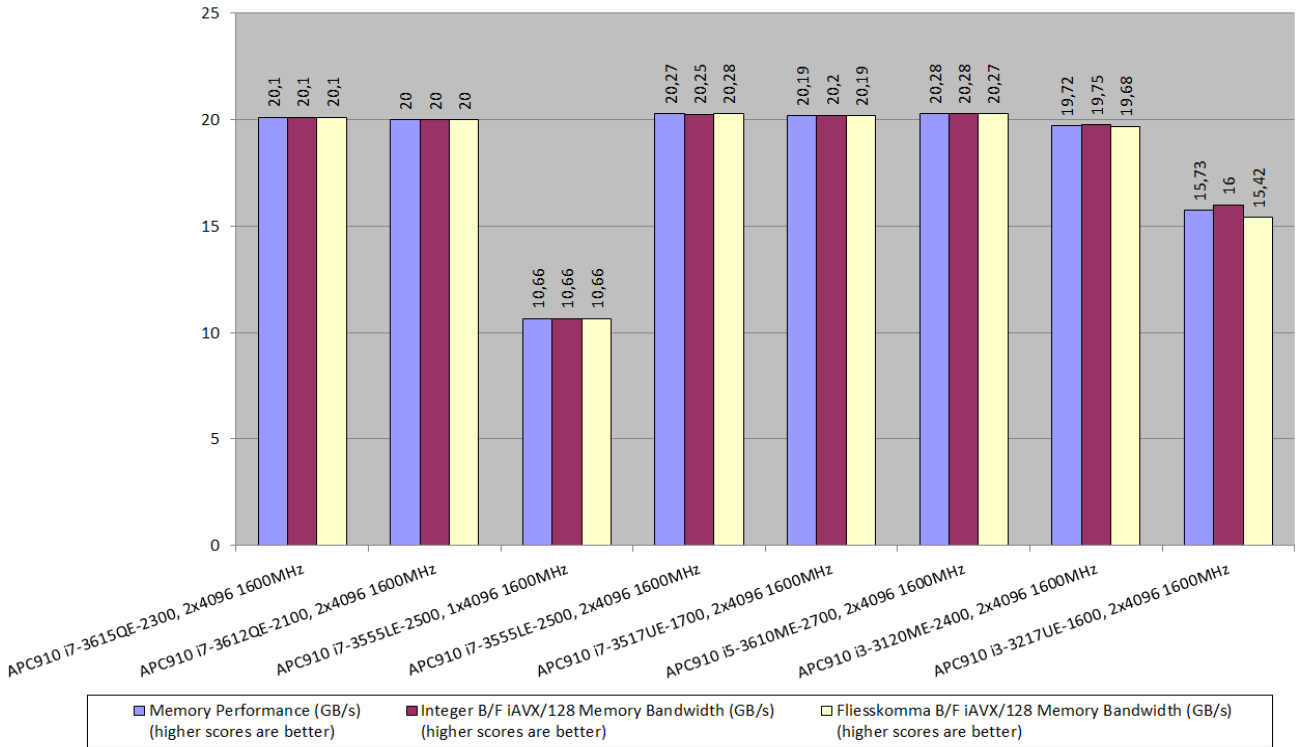

Figure 52: Results for SiSoft Sandra 2011, Memory Bandwidth (QM77 Chipset), DDR3 1600MHz – APC910/PPC900

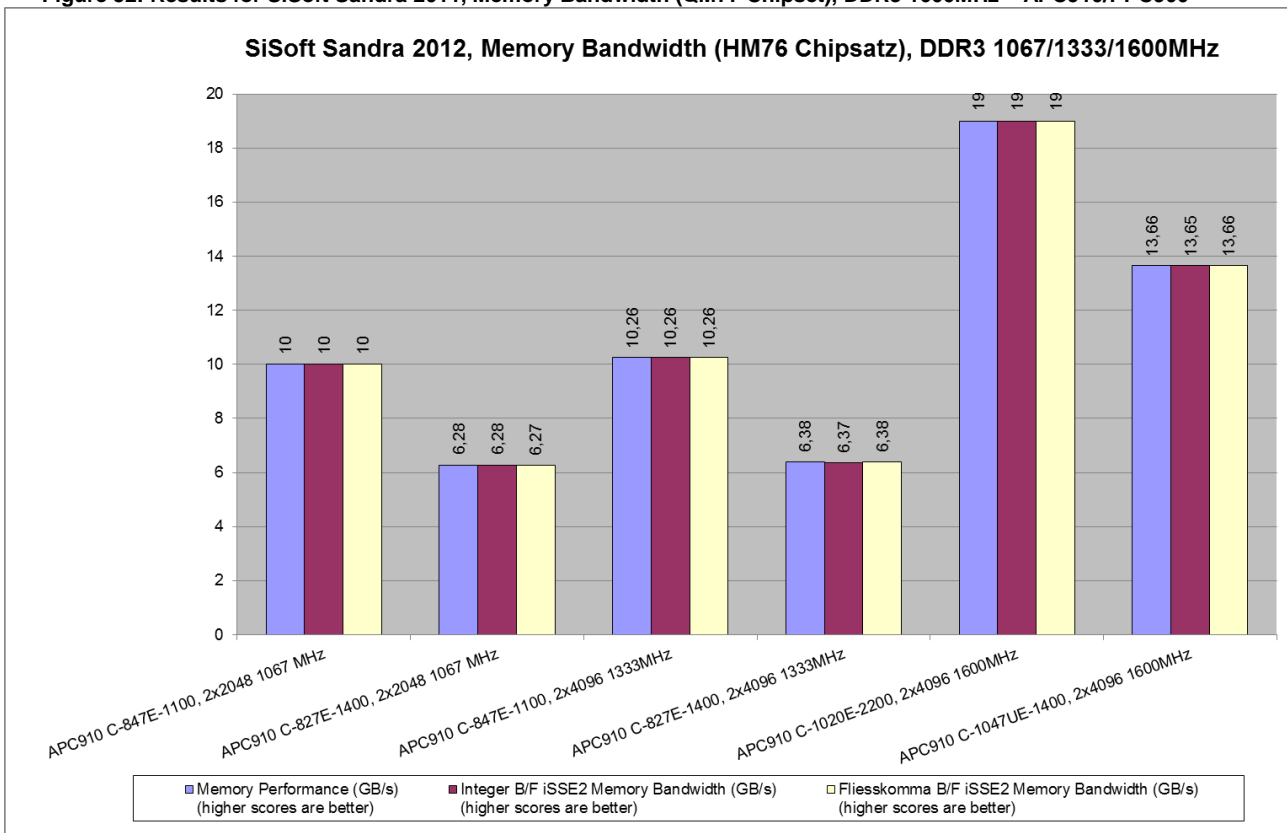

Figure 53: Results for SiSoft Sandra 2011, Memory Bandwidth (HM76 Chipset), DDR3 1067/1333/1600MHz – APC910/PPC900

4.12.1.8 Memory Latency

Benchmark the latency (response time) of processors' caches and memory. Shows how your processors' caches and memory sub-systems compare to other computers in terms of latency. The latency of caches is measured in processor clocks (i.e. how many clocks it takes for the data to be ready) as it is dependent on the processor clock speed. The latency of memory is measured in nanoseconds as it is typically independent on processor clock speed.

Lower scores are better

#	Test device	CPU1 Memory Latency Random (ns)	CPU1 Speed Factor Random (ns)	CPU1 Memory Latency Linear (ns)	CPU1 Speed Factor Linear (ns)
APC910 with INTEL QM77 Chipset					
37	i7-3615QE 4C 2.3/1.6GHz 6MB 45W 2x4096MB DDR3-SODIMM 1067MHz	92,2	74,1	6,2	5
38	i7-3615QE 4C 2.3/1.6GHz 6MB 45W 2x4096MB DDR3-SODIMM 1600MHz	81,4	65,3	5,7	4,6
39	i7-3612QE 4C 2.1/1.6GHz 6MB 35W, 2x4096MB DDR3-SODIMM 1067MHz	91,2	68,5	6,5	4,9
40	i7-3612QE 4C 2.1/1.6GHz 6MB 35W, 2x4096MB DDR3-SODIMM 1600MHz	82,2	62,2	5,9	4,5
41	i7-3555LE 2C 2.5/1.6GHz 4MB 25W, 4096MB DDR3-SODIMM 1067MHz	85,4	66,7	8,5	6,6
42	i7-3555LE 2C 2.5/1.6GHz 4MB 25W, 4096MB DDR3-SODIMM 1600MHz	80,7	61	6,4	4,8
43	i7-3555LE 2C 2.5/1.6GHz 4MB 25W, 2x2048MB DDR3-SODIMM 1067MHz	88,6	69,2	6,1	4,8
44	i7-3555LE 2C 2.5/1.6GHz 4MB 25W, 2x4096MB DDR3-SODIMM 1600MHz	83,8	63,8	5,9	4,4
45	i7-3517UE 2C 1.7/1.6GHz 4MB 17W, 2x2048MB DDR3-SODIMM 1067MHz	97	63,5	7	4,6
46	i7-3517UE 2C 1.7/1.6GHz 4MB 17W, 2x4096MB DDR3-SODIMM 1600MHz	86,8	57,2	6,5	4,3
47	i5-3610ME 2C 2.7/1.6GHz 3MB 35W, 2x2048MB DDR3-SODIMM 1067MHz	92,9	72,3	6,2	4,8
48	i5-3610ME 2C 2.7/1.6GHz 3MB 35W, 2x4096MB DDR3-SODIMM 1600MHz	79,7	64,6	5,5	4,5
49	i3-3120ME 2C 2.4/1.6GHz 3MB 35W, 2x2048MB DDR3-SODIMM 1067MHz	93,1	61	6,9	4,5
50	i3-3120ME 2C 2.4/1.6GHz 3MB 35W, 2x4096MB DDR3-SODIMM 1600MHz	87,9	55,1	6,7	4,2
51	i3-3217UE 2C 1.6/1.6GHz 3MB 17W, 2x2048MB DDR3-SODIMM 1067MHz	106,3	42,4	10	4
52	i3-3217UE 2C 1.6/1.6GHz 3MB 17W, 2x4096MB DDR3-SODIMM 1600MHz	112,3	41,1	10,5	3,9
APC910 with INTEL HM76 Chipset					
53	C-847E 2C 1.1/1.3GHz 2MB 17W 2x2048MB DDR3-SODIMM 1067MHz	125,7	34,3	16,8	4,6
54	C-847E 2C 1.1/1.3GHz 2MB 17W 2x4096MB DDR3-SODIMM 1333MHz	132,2	36,1	16,8	4,6
55	C-827E 1C 1.4/1.3GHz 1.5MB 17W 2x2048MB DDR3-SODIMM 1067MHz	121,7	37,8	15,6	4,8
56	C-827E 1C 1.4/1.3GHz 1.5MB 17W 2x4096MB DDR3-SODIMM 1333MHz	117,2	36,2	15,2	4,7
58	C-1047UE 2C 1.4/1.6GHz 2MB 17W 2x4096MB DDR3-SODIMM 1600MHz	126,2	44	11,1	3,9

#	Test device	CPU1 Memory Latency Random (ns)	CPU1 Speed Factor Random (ns)	CPU1 Memory Latency Linear (ns)	CPU1 Speed Factor Linear (ns)
APC910 with INTEL QM77 Chipset					
59	C-1020E 2C 2.2/1.6GHz 2MB 35W 2x4096MB DDR3-SODIMM 1600MHz	87,1	47,4	7,4	4

Table 41: Results for SiSoft Sandra 2011, Memory Latency CPU1 – APC910/PPC900

#	Test device	CPU2 Memory Latency Random (ns)	CPU2 Speed Factor Random (ns)	CPU2 Memory Latency Linear (ns)	CPU2 Speed Factor Linear (ns)
APC910 with INTEL QM77 Chipset					
37	i7-3615QE 4C 2.3/1.6GHz 6MB 45W 2x4096MB DDR3-SODIMM 1067MHz	92,2	74,1	6,2	5
38	i7-3615QE 4C 2.3/1.6GHz 6MB 45W 2x4096MB DDR3-SODIMM 1600MHz	81,3	65,4	5,6	4,5
39	i7-3612QE 4C 2.1/1.6GHz 6MB 35W, 2x4096MB DDR3-SODIMM 1067MHz	91	68,3	6,4	4,8
40	i7-3612QE 4C 2.1/1.6GHz 6MB 35W, 2x4096MB DDR3-SODIMM 1600MHz	82	62,2	5,9	4,4
41	i7-3555LE 2C 2.5/1.6GHz 4MB 25W, 4096MB DDR3-SODIMM 1067MHz	89,3	67,5	8,7	6,5
42	i7-3555LE 2C 2.5/1.6GHz 4MB 25W, 4096MB DDR3-SODIMM 1600MHz	80,6	61	6,3	4,8
43	i7-3555LE 2C 2.5/1.6GHz 4MB 25W, 2x2048MB DDR3-SODIMM 1067MHz	88,7	69,4	6,1	4,7
44	i7-3555LE 2C 2.5/1.6GHz 4MB 25W, 2x4096MB DDR3-SODIMM 1600MHz	83,8	63,8	5,8	4,4
45	i7-3517UE 2C 1.7/1.6GHz 4MB 17W, 2x2048MB DDR3-SODIMM 1067MHz	96,9	63,3	6,9	4,5
46	i7-3517UE 2C 1.7/1.6GHz 4MB 17W, 2x4096MB DDR3-SODIMM 1600MHz	86,8	57,1	6,4	4,2
47	i5-3610ME 2C 2.7/1.6GHz 3MB 35W, 2x2048MB DDR3-SODIMM 1067MHz	92,8	71,6	6,2	4,8
48	i5-3610ME 2C 2.7/1.6GHz 3MB 35W, 2x4096MB DDR3-SODIMM 1600MHz	83,5	64,9	5,7	4,4
49	i3-3120ME 2C 2.4/1.6GHz 3MB 35W, 2x2048MB DDR3-SODIMM 1067MHz	93,1	61,1	6,8	4,4
50	i3-3120ME 2C 2.4/1.6GHz 3MB 35W, 2x4096MB DDR3-SODIMM 1600MHz	87,8	55,6	6,7	4,1
51	i3-3217UE 2C 1.6/1.6GHz 3MB 17W, 2x2048MB DDR3-SODIMM 1067MHz	116,5	43	10,7	3,9
52	i3-3217UE 2C 1.6/1.6GHz 3MB 17W, 2x4096MB DDR3-SODIMM 1600MHz	111,3	41	10,4	3,8
APC910 with INTEL HM76 Chipset					
53	C-847E 2C 1.1/1.3GHz 2MB 17W 2x2048MB DDR3-SODIMM 1067MHz	140,9	35,4	18,3	4,6
54	C-847E 2C 1.1/1.3GHz 2MB 17W 2x4096MB DDR3-SODIMM 1333MHz	133,8	32,8	18,4	4,5
55	C-827E 1C 1.4/1.3GHz 1.5MB 17W 2x2048MB DDR3-SODIMM 1067MHz	-	-	-	-
56	C-827E 1C 1.4/1.3GHz 1.5MB 17W 2x4096MB DDR3-SODIMM 1333MHz	-	-	-	-
58	C-1047UE 2C 1.4/1.6GHz 2MB 17W 2x4096MB DDR3-SODIMM 1600MHz	130,4	41,5	12	3,8

#	Test device	CPU2 Memory Latency Random (ns)	CPU2 Speed Factor Random (ns)	CPU2 Memory Latency Linear (ns)	CPU2 Speed Factor Linear (ns)
APC910 with INTEL QM77 Chipset					
59	C-1020E 2C 2.2/1.6GHz 2MB 35W 2x4096MB DDR3-SODIMM 1600MHz	91,7	48,2	7,7	4

Table 42: Results for SiSoft Sandra 2011, Memory Latency CPU2 – APC910/PPC900

SiSoft Sandra 2011, Memory Latency CPU 1, DDR3 1067MHz

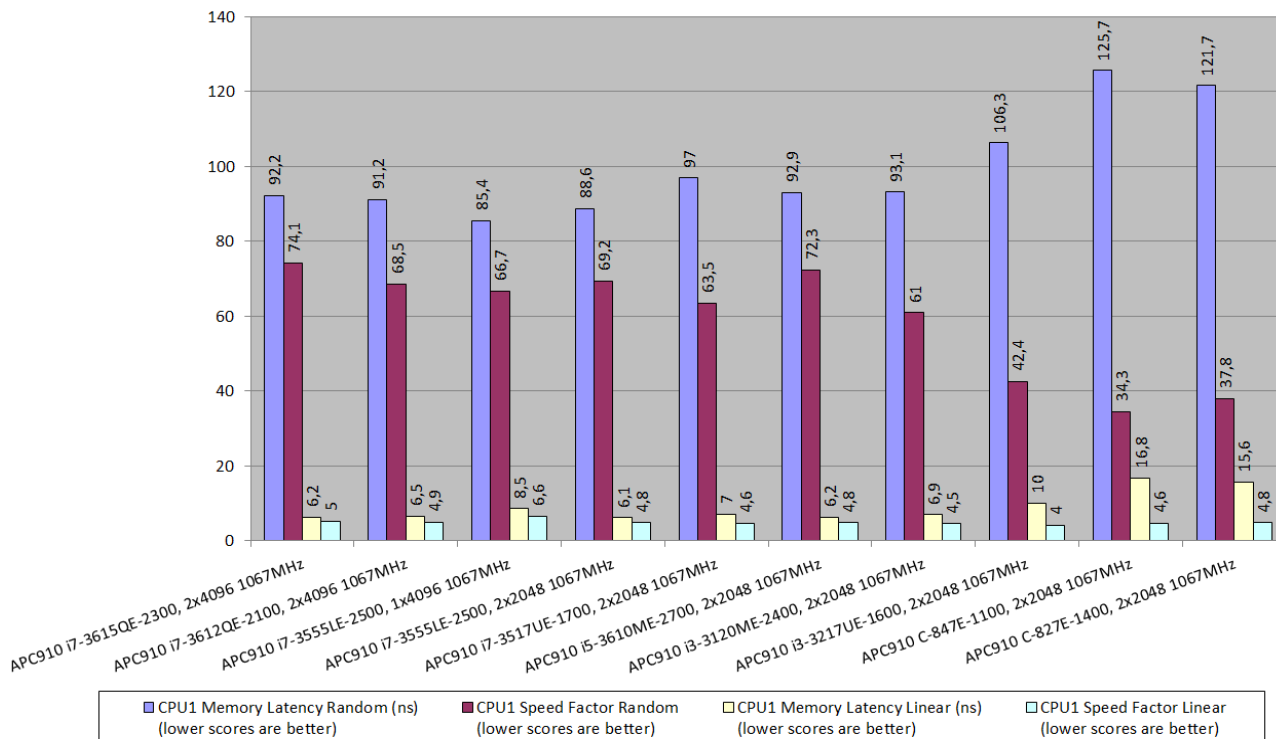

Figure 54: Results for SiSoft Sandra 2011, Memory Latency CPU1, DDR3 1067MHz – APC910/PPC900

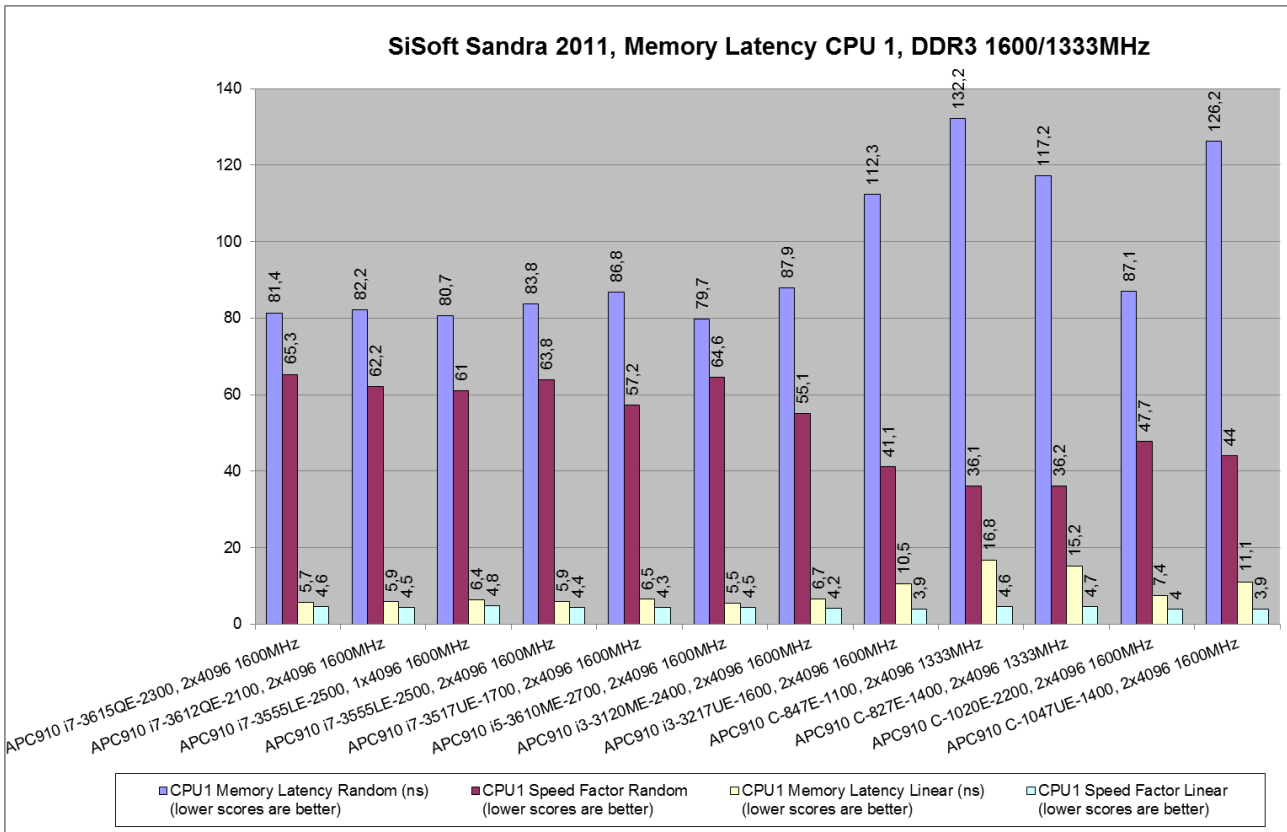

Figure 55: Results for SiSoft Sandra 2011, Memory Latency CPU1, DDR3 1600/1333MHz – APC910/PPC900

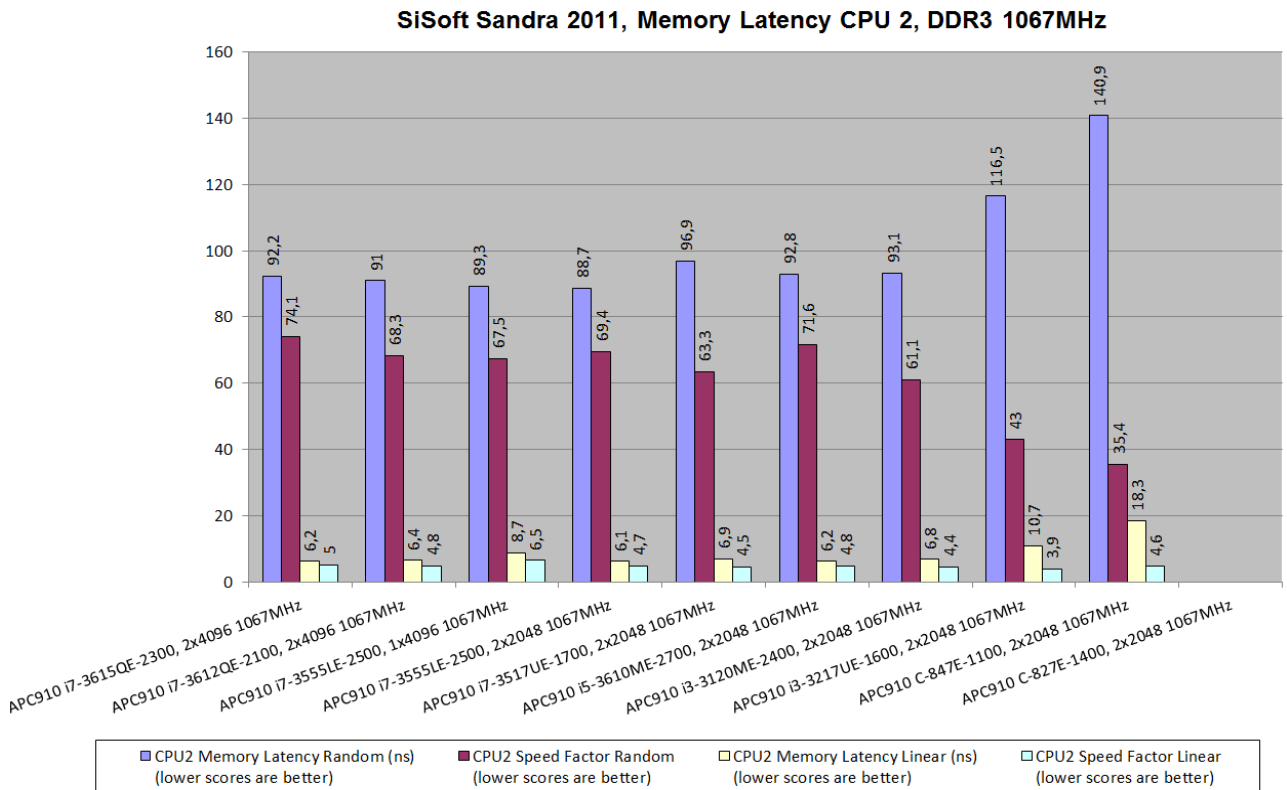

Figure 56: Results for SiSoft Sandra 2011, Memory Latency CPU2, DDR3 1067MHz – APC910/PPC900

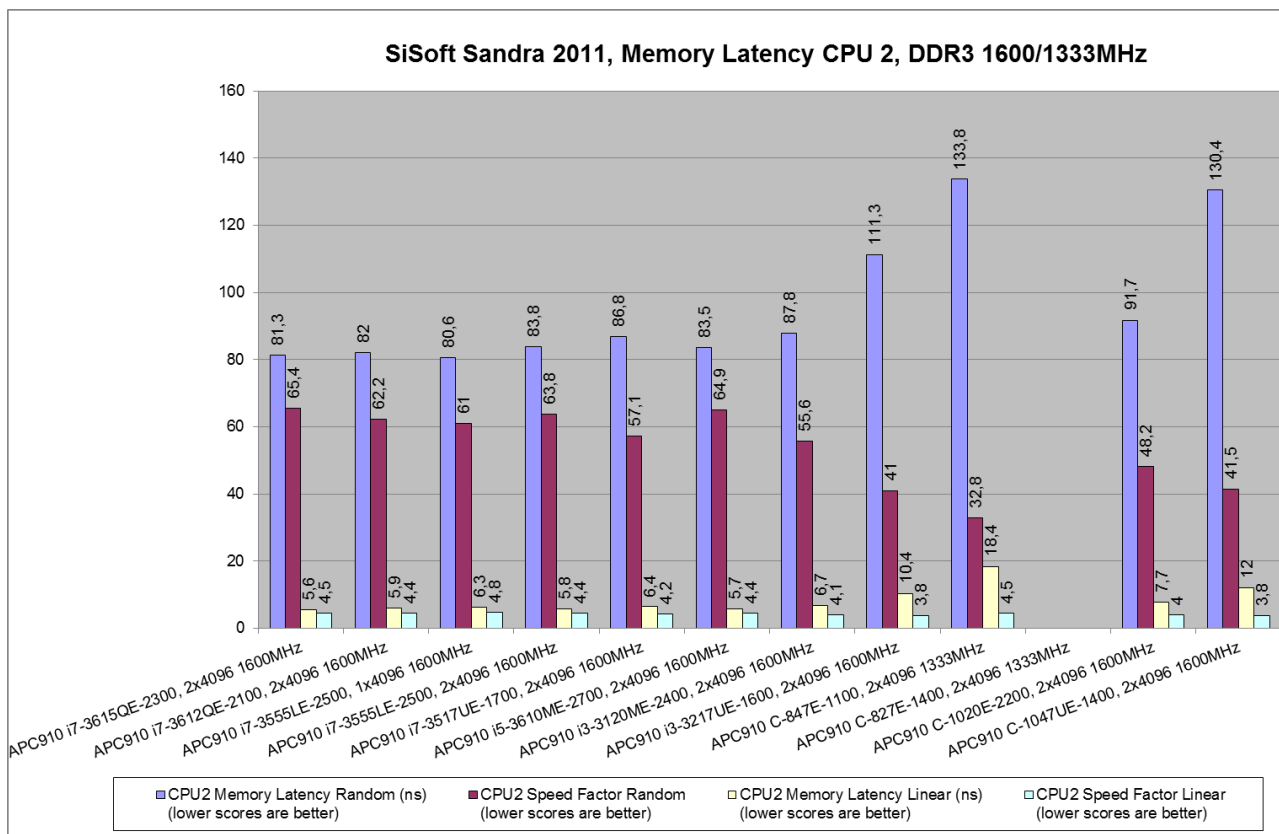

Figure 57: Results for SiSoft Sandra 2011, Memory Latency CPU2, DDR3 1600/1333MHz – APC910/PPC900

4.12.1.9 Cache and Memory

Benchmark the processors' caches and memory access (transfer speed). Shows how your processors' caches and memory sub-systems compare to other computers in terms of access.

#	Test device	Cache/Memory Bandwidth (GB/s) (higher scores are better)	Speed Factor (lower scores are better)
APC910 with INTEL QM77 Chipset			
37	i7-3615QE 4C 2.3/1.6GHz 6MB 45W 2x4096MB DDR3-SODIMM 1067MHz	87,8	42,8
38	i7-3615QE 4C 2.3/1.6GHz 6MB 45W 2x4096MB DDR3-SODIMM 1600MHz	101	30,1
39	i7-3612QE 4C 2.1/1.6GHz 6MB 35W, 2x4096MB DDR3-SODIMM 1067MHz	80,23	41,4
40	i7-3612QE 4C 2.1/1.6GHz 6MB 35W, 2x4096MB DDR3-SODIMM 1600MHz	94,9	27,3
41	i7-3555LE 2C 2.5/1.6GHz 4MB 25W, 4096MB DDR3-SODIMM 1067MHz	40,63	41,2
42	i7-3555LE 2C 2.5/1.6GHz 4MB 25W, 4096MB DDR3-SODIMM 1600MHz	47,58	27,8
43	i7-3555LE 2C 2.5/1.6GHz 4MB 25W, 2x2048MB DDR3-SODIMM 1067MHz	51,65	22,6
44	i7-3555LE 2C 2.5/1.6GHz 4MB 25W, 2x4096MB DDR3-SODIMM 1600MHz	60,44	15,2
45	i7-3517UE 2C 1.7/1.6GHz 4MB 17W, 2x2048MB DDR3-SODIMM 1067MHz	47,16	19,6

#	Test device	Cache/Memory Bandwidth (GB/s) (higher scores are better)	Speed Factor (lower scores are better)
46	i7-3517UE 2C 1.7/1.6GHz 4MB 17W, 2x4096MB DDR3-SODIMM 1600MHz	55	13,4
47	i5-3610ME 2C 2.7/1.6GHz 3MB 35W, 2x2048MB DDR3-SODIMM 1067MHz	50,78	23,3
48	i5-3610ME 2C 2.7/1.6GHz 3MB 35W, 2x4096MB DDR3-SODIMM 1600MHz	60,24	15,7
49	i3-3120ME 2C 2.4/1.6GHz 3MB 35W, 2x2048MB DDR3-SODIMM 1067MHz	45	19
50	i3-3120ME 2C 2.4/1.6GHz 3MB 35W, 2x4096MB DDR3-SODIMM 1600MHz	52,82	13
51	i3-3217UE 2C 1.6/1.6GHz 3MB 17W, 2x2048MB DDR3-SODIMM 1067MHz	34	12,5
52	i3-3217UE 2C 1.6/1.6GHz 3MB 17W, 2x4096MB DDR3-SODIMM 1600MHz	38,58	9,3
APC910 with INTEL HM76 Chipset			
53	C-847E 2C 1.1/1.3GHz 2MB 17W 2x2048MB DDR3-SODIMM 1067MHz	23,8	9,5
54	C-847E 2C 1.1/1.3GHz 2MB 17W 2x4096MB DDR3-SODIMM 1333MHz	14,48	9,1
55	C-827E 1C 1.4/1.3GHz 1.5MB 17W 2x2048MB DDR3-SODIMM 1067MHz	24,36	8,8
56	C-827E 1C 1.4/1.3GHz 1.5MB 17W 2x4096MB DDR3-SODIMM 1333MHz	14,33	8,9
58	C-1047UE 2C 1.4/1.6GHz 2MB 17W 2x4096MB DDR3-SODIMM 1600MHz	31,88	8,6
59	C-1020E 2C 2.2/1.6GHz 2MB 35W 2x4096MB DDR3-SODIMM 1600MHz	45,32	11,1

Table 43: Results for SiSoft Sandra 2011, Cache and Memory – APC910/PPC900

SiSoft Sandra 2011, Cache and Memory, DDR3 1067MHz

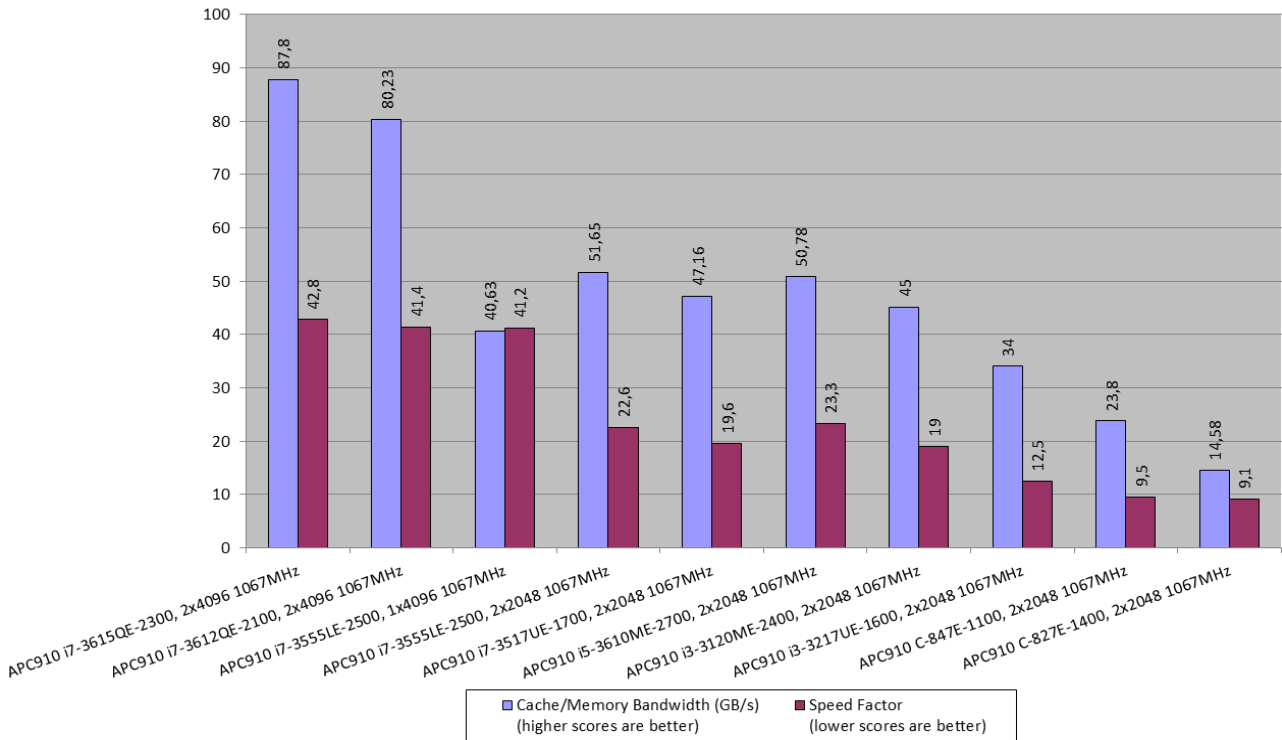

Figure 58: Results for SiSoft Sandra 2011, Cache and Memory, DDR3 1067MHz – APC910/PPC900

SiSoft Sandra 2011, Cache and Memory, DDR3 1600/1333MHz

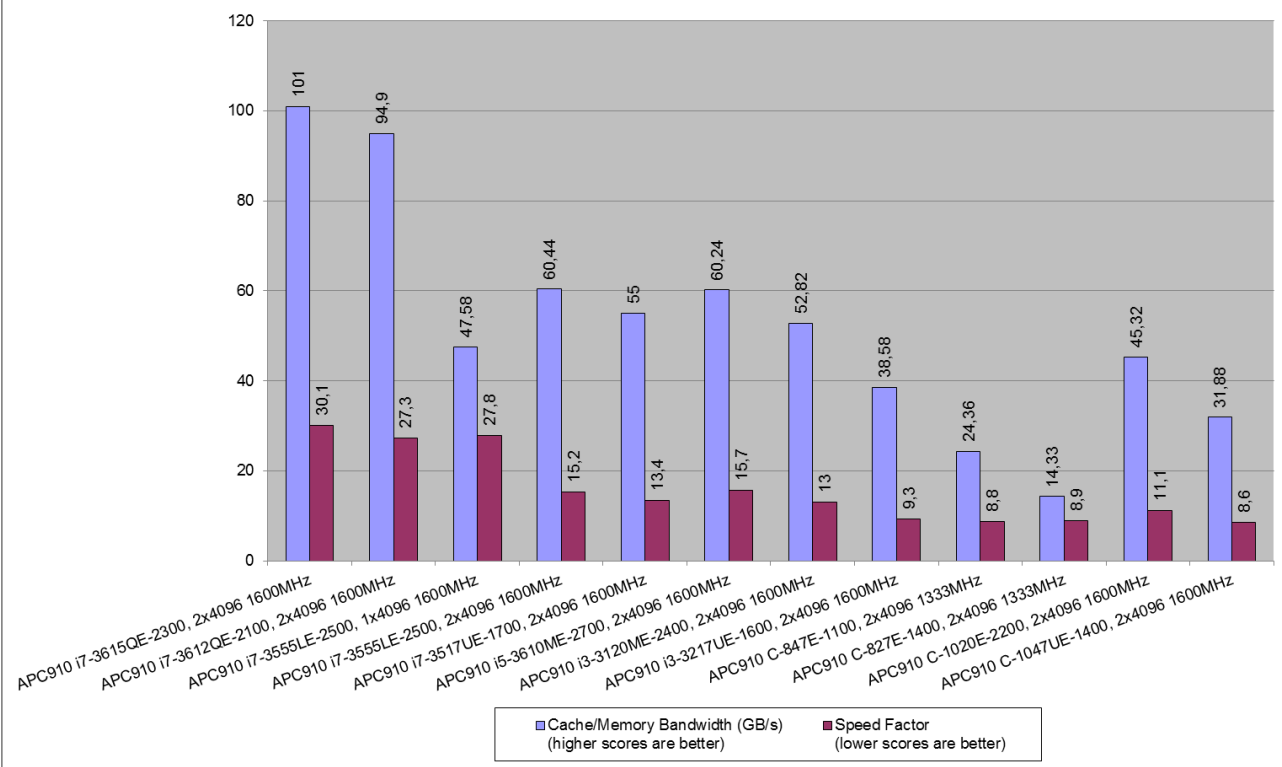

Figure 59: Results for SiSoft Sandra 2011, Cache and Memory, DDR3 1600/1333MHz – APC910/PPC900

4.12.2 APC2100/PPC2100

4.12.2.1 CPU Arithmetic

Benchmarks the ALU and FPU processor units. Shows how your processors handle arithmetic and float-ing point instructions in comparison to other typical processors. Such operations are used by software in typical tasks.

Higher scores are better

#	Test device	Arithmetic Perfor- mance (GOPS)	Dhrystone iSSE4.2 (GIPS)	Whetstone iSSE3 (GFLOPS)
APC2100/PPC2100 with INTEL Bay Trail				
60	E3815 1C 1.46GHz 512kB 5W, 1GB-1067MHz	3,9	4,46	3,41
61	E3825 2C 1.33GHz 1MB 6W, 1GB-1067MHz	7	8	6,2
62	E3826 2C 1.46GHz 1MB 7W, 2GB-1067MHz	7,8	9,64	6,3
63	E3827 2C 1.75GHz 1MB 8W, 4GB-1333MHz	9,3	11,52	7,5
64	E3845 4C 1.91GHz 2MB 10W, 4GB-1333MHz	20,36	25,18	16,46
65	E3845 4C 1.91GHz 2MB 10W, 8GB-1333MHz	20,3	25,1	16,43

Table 44: Results for SiSoft Sandra 2011, CPU Arithmetic – APC2100/PPC2100

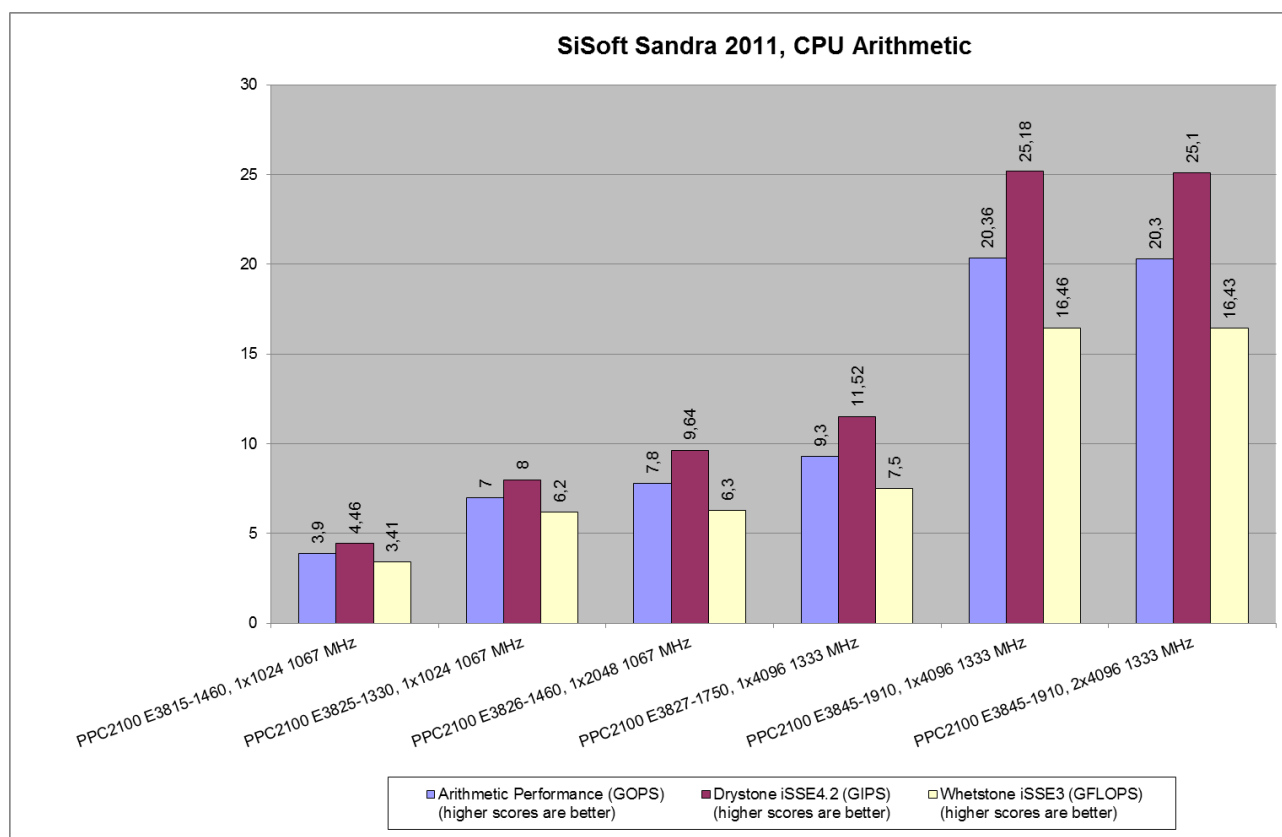

Figure 60: Results for SiSoft Sandra 2011, CPU Arithmetic – APC2100/PPC2100

4.12.2.2 Processor Multi-media

Benchmark the SIMD processor units. Shows how your processors handle multi-media instructions and data in comparison to other typical processors. Such operations are used by more specialized software, e.g. image manipulation, video decoders/encoders and games.

Higher scores are better

#	Test device	Multimedia Performance (MPixel/s)	Integer x8 iSSE4.1 (MPixel/s)	Float x4 iSSE2 (MPixel/s)	Multimedia Double x2 iSSE2 (MPixel/s)
APC2100/PPC2100 with INTEL Bay Trail					
60	E3815 1C 1.46GHz 512kB 5W, 1GB-1067MHz	6	7	5	2,12
61	E3825 2C 1.33GHz 1MB 6W, 1GB-1067MHz	10,78	12,52	9,28	3,85
#	Test device	Multimedia Performance (MPixel/s)	Integer x16 iSSE4.1 (MPixel/s)	Float x8 iSSE2 (MPixel/s)	Multimedia Double x4 iSSE2 (MPixel/s)
APC2100/PPC2100 with INTEL Bay Trail					
62	E3826 2C 1.46GHz 1MB 7W, 2GB-1067MHz	16	17,2	14,7	5,16
63	E3827 2C 1.75GHz 1MB 8W, 4GB-1333MHz	19	20,53	17,7	6,17
64	E3845 4C 1.91GHz 2MB 10W, 4GB-1333MHz	42,57	46,7	38,8	13,5
65	E3845 4C 1.91GHz 2MB 10W, 8GB-1333MHz	42,47	46,7	38,62	13,52

Table 45: Results for SiSoft Sandra 2011, Processor Multi-Media – APC2100/PPC2100

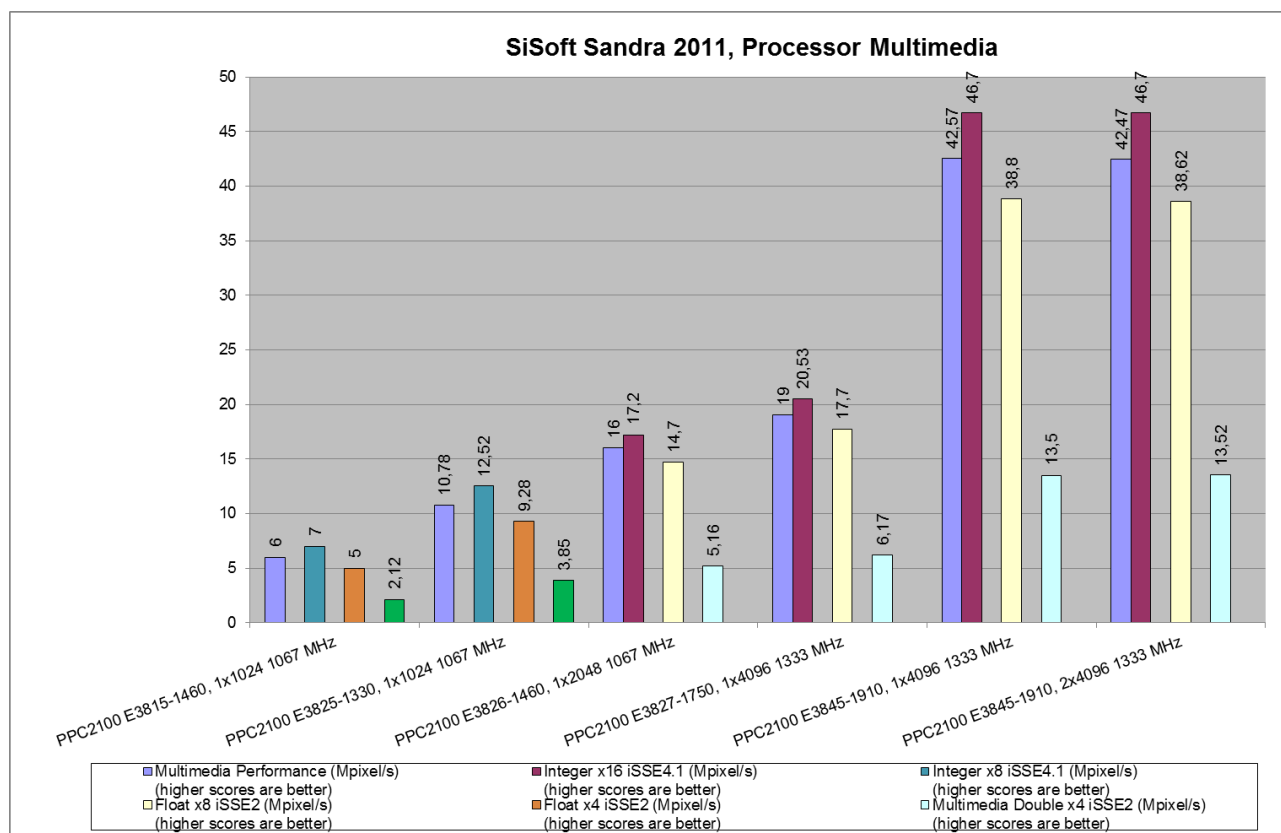

Figure 61: Results for SiSoft Sandra 2011, Processor Multi-Media – APC2100/PPC2100

4.12.2.3 Multi-Core Efficiency

Benchmark the multi-core efficiency of the processors. Shows how efficient the processor cores and their inter – connects are in comparison to other types to other typical processors. The ability of the cores to process data blocks and pass them to another core for processing of different sizes and different chain sizes is measured. The efficiency of the inter – connect between cores is thus benchmarked. The number of cores also counts as more data buffers can be processed simultaneously.

#	Test device	Inter-Core Bandwidth (GB/s) (higher scores are better)	Inter-Core Latency (ns) (lower scores are better)
APC2100/PPC2100 with INTEL Bay Trail			
60	E3815 1C 1.46GHz 512kB 5W, 1GB-1067MHz	-	-
61	E3825 2C 1.33GHz 1MB 6W, 1GB-1067MHz	0,92	199,5
62	E3826 2C 1.46GHz 1MB 7W, 2GB-1067MHz	0,935	314,7
63	E3827 2C 1.75GHz 1MB 8W, 4GB-1333MHz	1	156,8
64	E3845 4C 1.91GHz 2MB 10W, 4GB-1333MHz	1,68	154,1
65	E3845 4C 1.91GHz 2MB 10W, 8GB-1333MHz	1,76	164

Table 46: Results for SiSoft Sandra 2011, Multi-Core Efficiency – APC2100/PPC2100

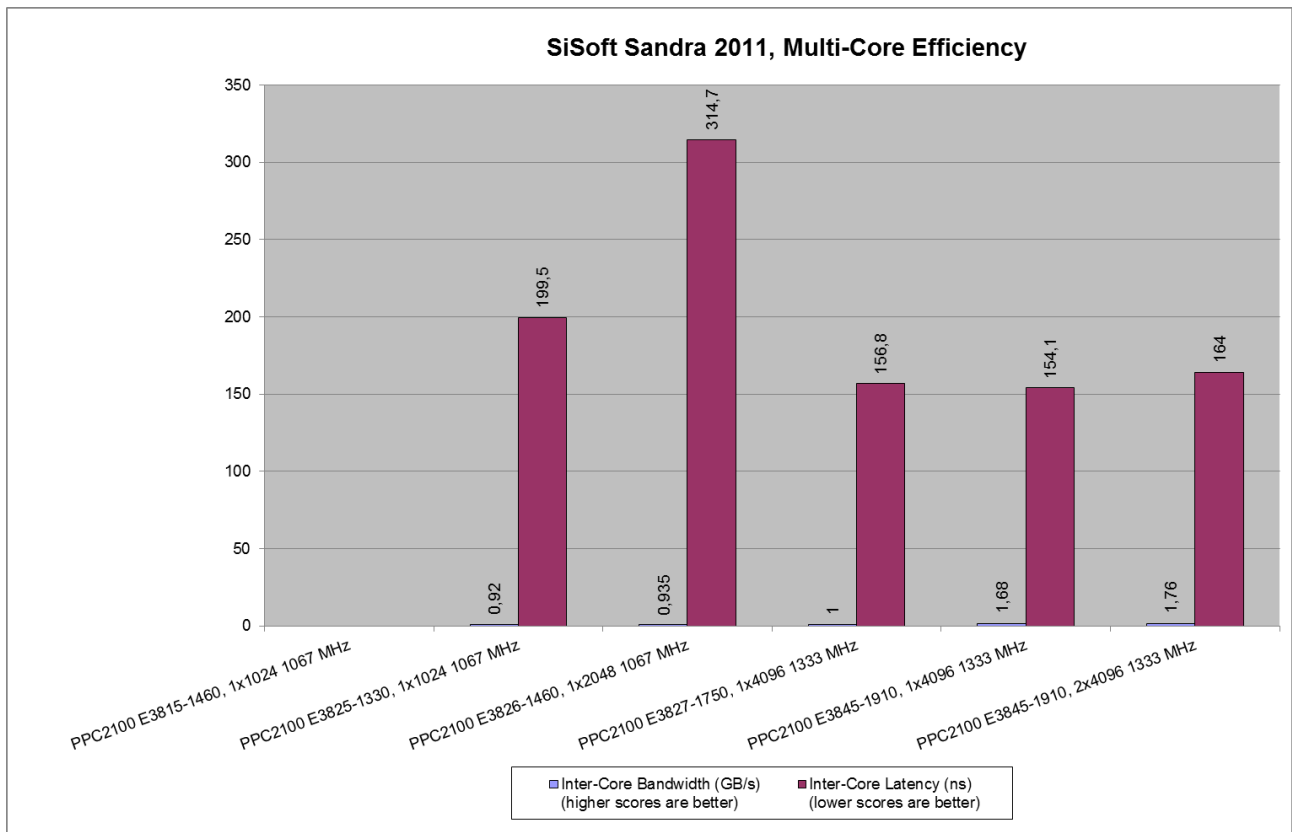

Figure 62: Results for SiSoft Sandra 2011, Multi-Core Efficiency – APC2100/PPC2100

4.12.2.4 Cryptography

Measures the cryptography efficiency of the processor units: encryption, decryption and hashing. Shows how your processors handle cryptographic operations in comparison to other typical processors. Such operations are used by software in most operations that handle sensitive data.

Higher scores are better

#	Test device	Cryptographic Bandwidth (GB/s)	AES256-ECB iAES Cryptographic Bandwidth (GB/s)	SHA256 iAVX Hashing Bandwidth (GB/s)
APC2100/PPC2100 with INTEL Bay Trail				
60	E3815 1C 1.46GHz 512kB 5W, 1GB-1067MHz	0,035	0,034	0,036
61	E3825 2C 1.33GHz 1MB 6W, 1GB-1067MHz	0.062	0.061	0.064
62	E3826 2C 1.46GHz 1MB 7W, 2GB-1067MHz	0,095	0,1	0,096
63	E3827 2C 1.75GHz 1MB 8W, 4GB-1333MHz	0.117	0,12	0,115
64	E3845 4C 1.91GHz 2MB 10W, 4GB-1333MHz	0,25	0,254	0,245
65	E3845 4C 1.91GHz 2MB 10W, 8GB-1333MHz	0,256	0,262	0,251

Table 47: Results for SiSoft Sandra 2011, Cryptography – APC2100/PPC2100

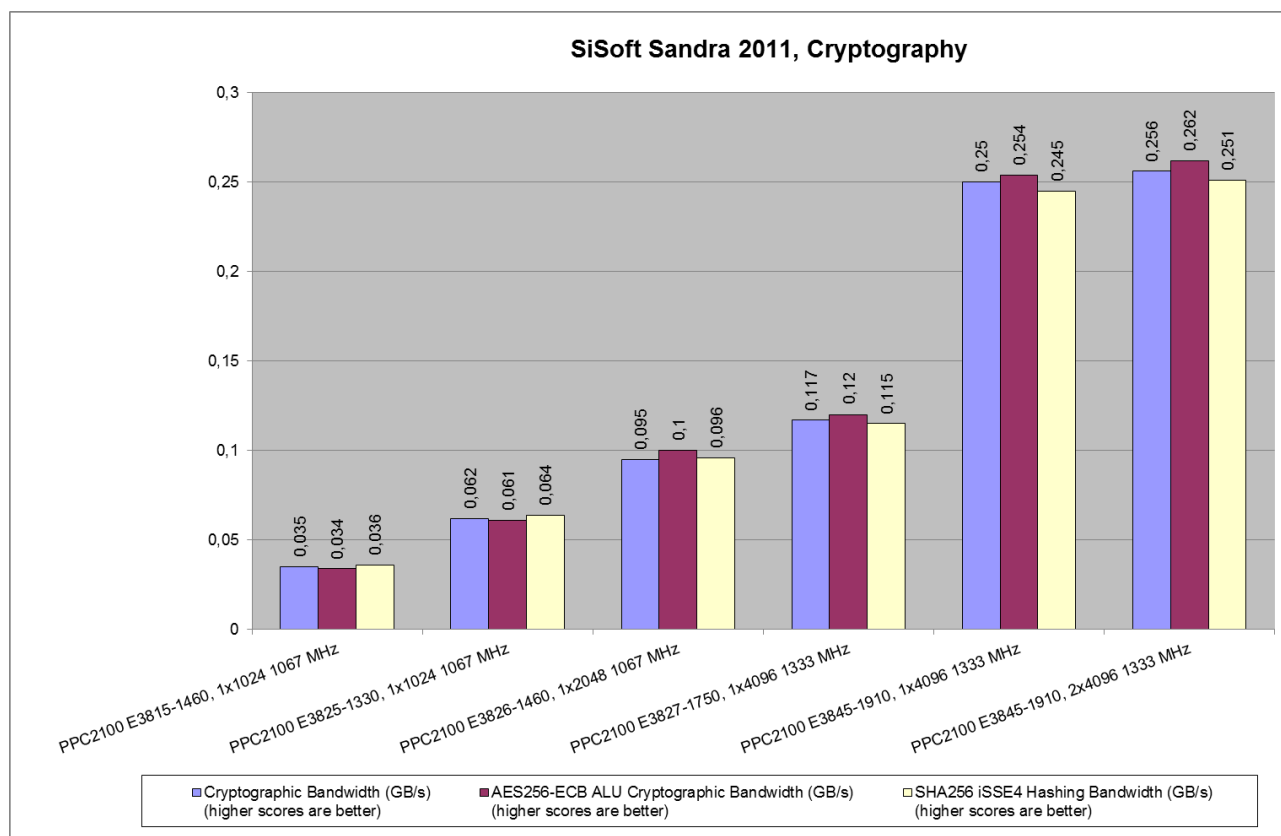

Figure 63: Results for SiSoft Sandra 2011, Cryptography – APC2100/PPC2100

4.12.2.5 Video Rendering

Benchmark the graphics performance of the video adapters (GFXs). Shows how your graphics processors handle rendering in comparison to other typical graphics processors. Such operations are used by all graphics software, image manipulation, video decoders/encoders, games and modern operating systems.

Higher scores are better

#	Test Device	Direct3D 9c			Direct3D 10		
		Shader Performance (MPixel/s)	Native Float Shader (MPixel/s)	Emulated Double Shader (MPixel/s)	Shader Performance (MPixel/s)	Native Float Shader (MPixel/s)	Emulated Double Shader (MPixel/s)
APC2100/PPC2100 with INTEL Bay Trail							
60	E3815 1C 1.46GHz 512kB 5W, 1GB-1067MHz	6,2	16,42	2,33	6,58	18	2,42
61	E3825 2C 1.33GHz 1MB 6W, 1GB-1067MHz	8,22	21,85	3	8,63	23,68	3,15
62	E3826 2C 1.46GHz 1MB 7W, 2GB-1067MHz	10	26,8	3,74	10,48	29	3,8
63	E3827 2C 1.75GHz 1MB 8W, 4GB-1333MHz	12	31,65	4,5	12,44	34,27	4,51
64	E3845 4C 1.91GHz 2MB 10W, 4GB-1333MHz	11,83	31,5	4,44	12,42	34,33	4,5
65	E3845 4C 1.91GHz 2MB 10W, 8GB-1333MHz	12	32	4,48	12,53	34,73	4,52

Table 48: Results for SiSoft Sandra 2011, Video Rendering (Direct3D 9c/10 Devices) – APC2100/PPC2100

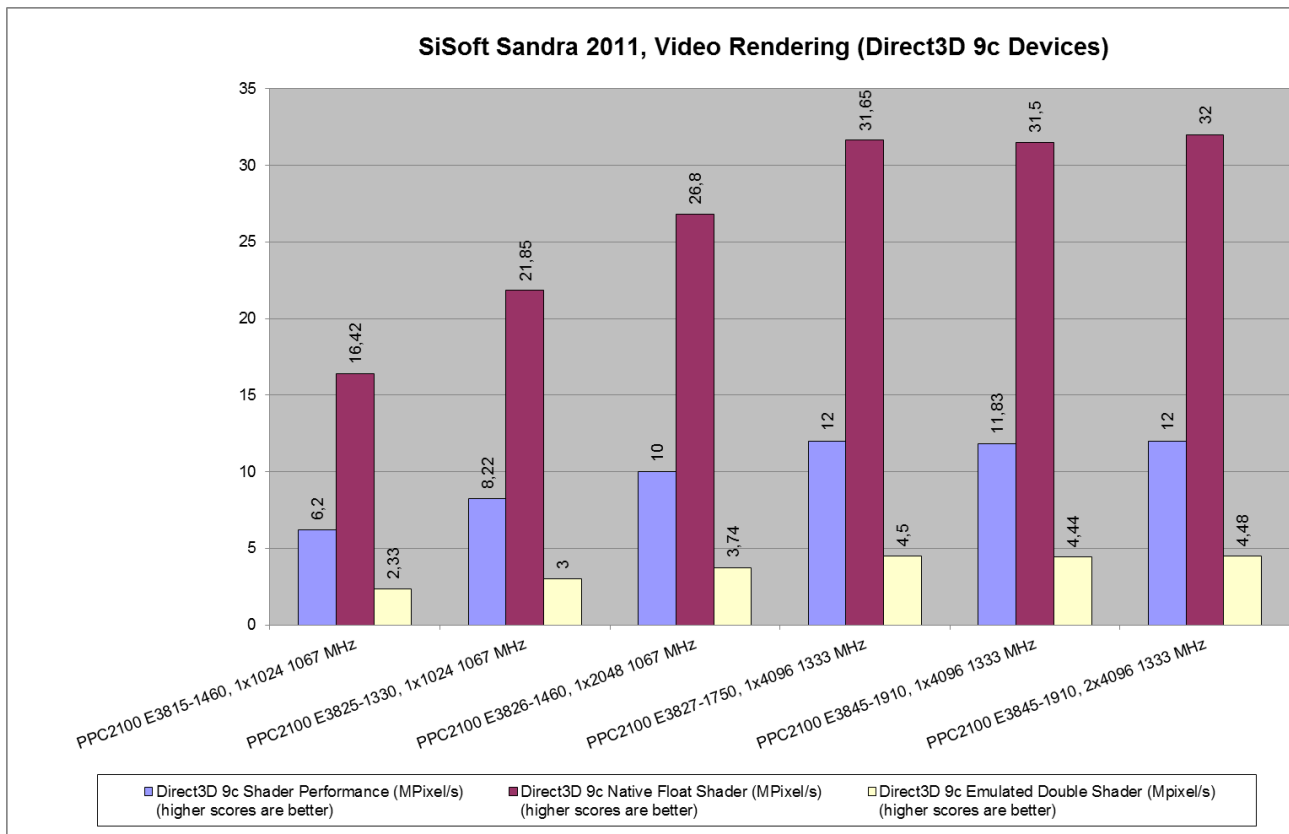

Figure 64: Results for SiSoft Sandra 2011, Video Rendering (Direct3D 9c Devices) – APC2100/PPC2100

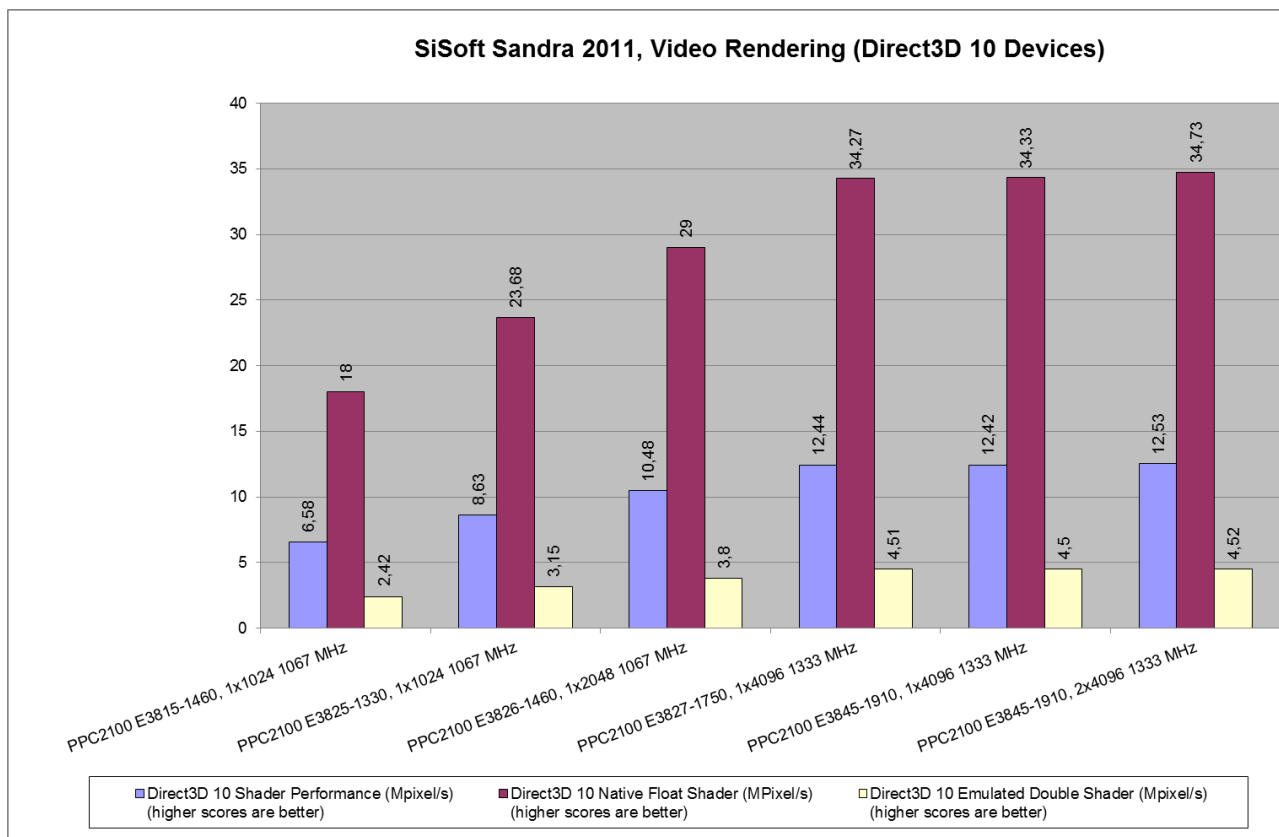

Figure 65: Results for SiSoft Sandra 2011, Video Rendering (Direct3D 10 Devices) – APC2100/PPC2100

Higher scores are better

#	Test Device	Direct3D 10.1			Direct3D 11		
		Shader Performance (MPixel/s)	Native Float Shader (MPixel/s)	Emulated Double Shader (MPixel/s)	Shader Performance (MPixel/s)	Native Float Shader (MPixel/s)	Emulated Double Shader (MPixel/s)
APC2100/PPC2100 with INTEL Bay Trail							
60	E3815 1C 1.46GHz 512kB 5W, 1GB-1067MHz	6,59	18	2,42	8,54	17,86	4
61	E3825 2C 1.33GHz 1MB 6W, 1GB-1067MHz	8,63	23,67	3,15	11,3	23,66	5,39
62	E3826 2C 1.46GHz 1MB 7W, 2GB-1067MHz	10,48	29	3,8	13,82	29	6,6
63	E3827 2C 1.75GHz 1MB 8W, 4GB-1333MHz	12,43	34,24	4,51	16,4	34,26	7,86
64	E3845 4C 1.91GHz 2MB 10W, 4GB-1333MHz	12,42	34,32	4,5	16,38	34,34	7,82
65	E3845 4C 1.91GHz 2MB 10W, 8GB-1333MHz	12,55	34,74	4,53	16,55	34,75	7,88

Table 49: Results for SiSoft Sandra 2011, Video Rendering (Direct3D 10.1/11 Devices) – APC2100/PPC2100

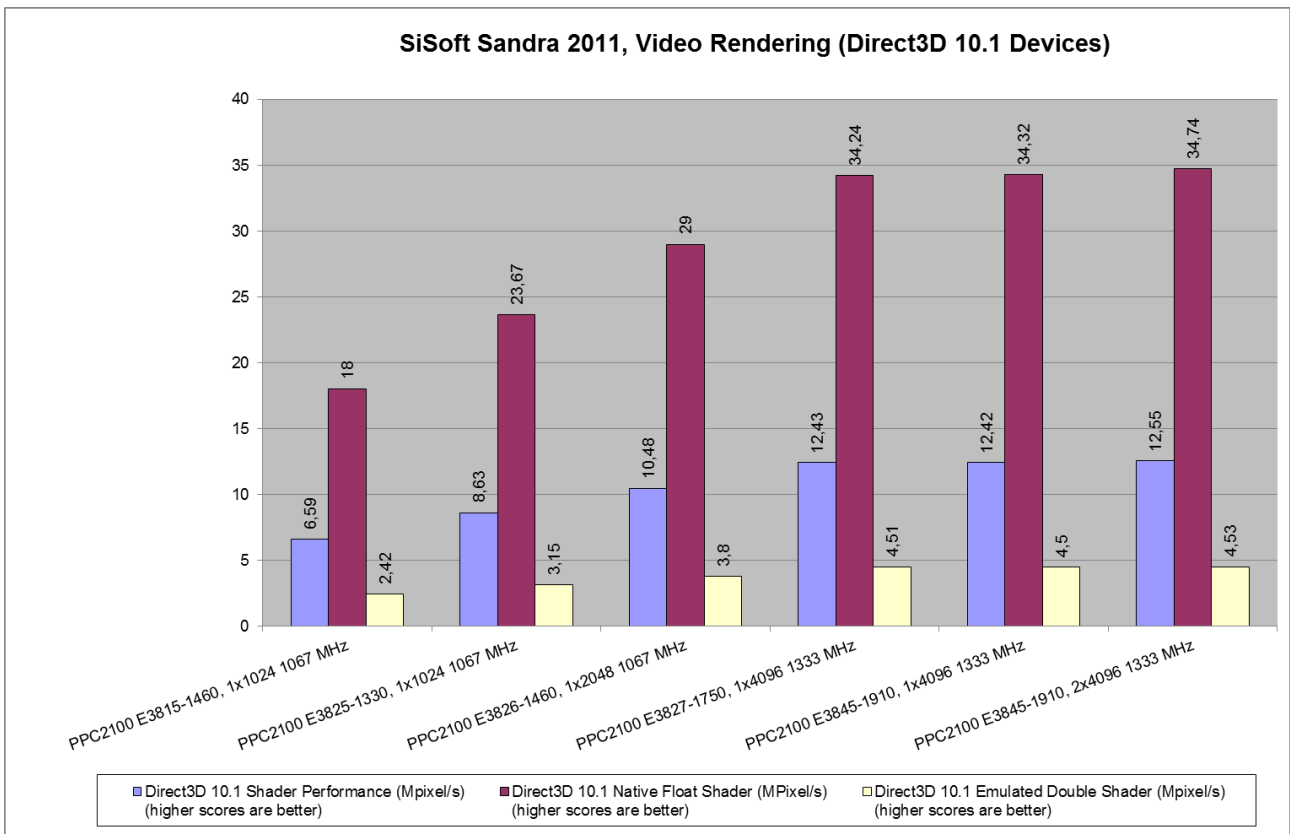

Figure 66: Results for SiSoft Sandra 2011, Video Rendering (Direct3D 10.1 Devices) – APC2100/PPC2100

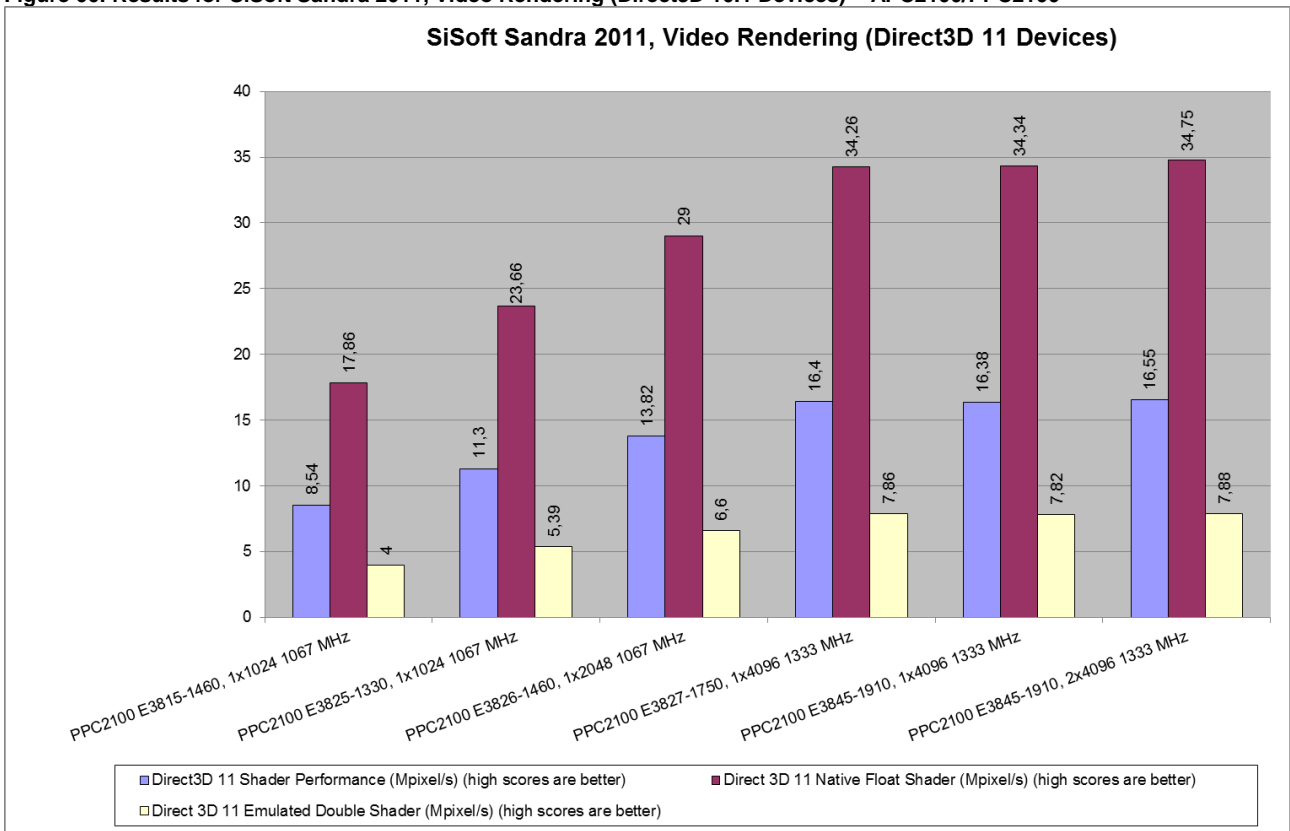

Figure 67: Results for SiSoft Sandra 2011, Video Rendering (Direct3D 11 Devices) – APC2100/PPC2100

4.12.2.6 Video Memory Bandwidth

Benchmark the bandwidth of the memory of the video adapters (GFXs) and the bandwidth of the bus that connects them to your computer. Shows how your video adapters' memory bandwidth compares to other video sub-systems in terms of bandwidth.

Higher scores are better

#	Test device	Direct3D 10			Direct3D 10.1		
		Performance (GB/s)	Bandwidth internal Memory (GB/s)	Data Transfer (GB/s)	Performance (GB/s)	Bandwidth internal Memory (GB/s)	Data Transfer (GB/s)
APC2100/PPC2100 with INTEL Bay Trail							
60	E3815 1C 1.46GHz 512kB 5W, 1GB-1067MHz	3,18	5,58	1,8	3,17	5,58	1,8
61	E3825 2C 1.33GHz 1MB 6W, 1GB-1067MHz	3,43	5,67	2	3,45	5,67	2
62	E3826 2C 1.46GHz 1MB 7W, 2GB-1067MHz	3,66	5,75	2,33	3,67	5,75	2,34
63	E3827 2C 1.75GHz 1MB 8W, 4GB-1333MHz	4,22	6,7	2,65	4,24	6,75	2,67
64	E3845 4C 1.91GHz 2MB 10W, 4GB-1333MHz	4,28	6,83	2,69	4,3	6,84	2,7
65	E3845 4C 1.91GHz 2MB 10W, 8GB-1333MHz	5,8	9,66	3,47	5,78	9,65	3,47

Table 50: Results for SiSoft Sandra 2011, Video Memory Bandwidth (Direct3D 10/10.1 Devices) – APC2100/PPC2100

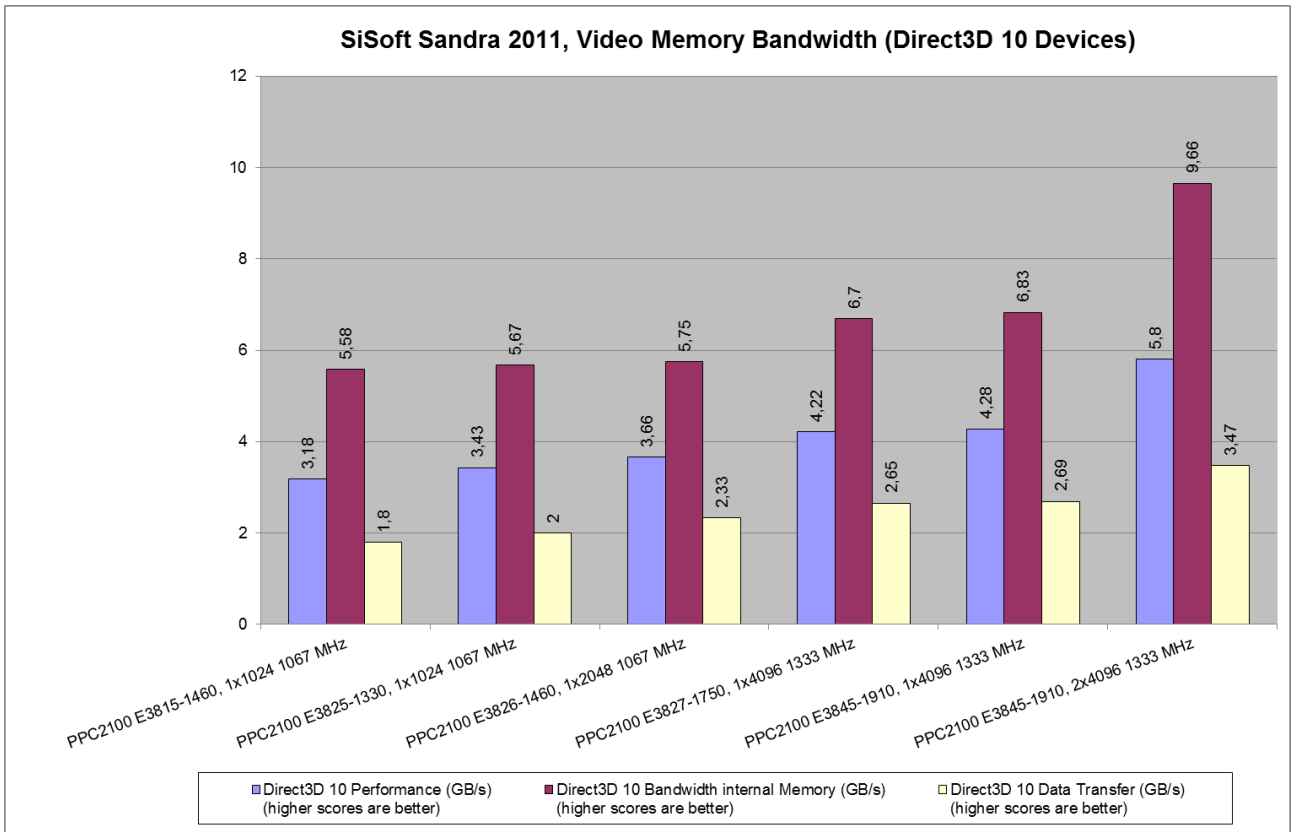

Figure 68: Results for SiSoft Sandra 2011, Video Memory Bandwidth (Direct3D 10 Devices) – APC2100/PPC2100

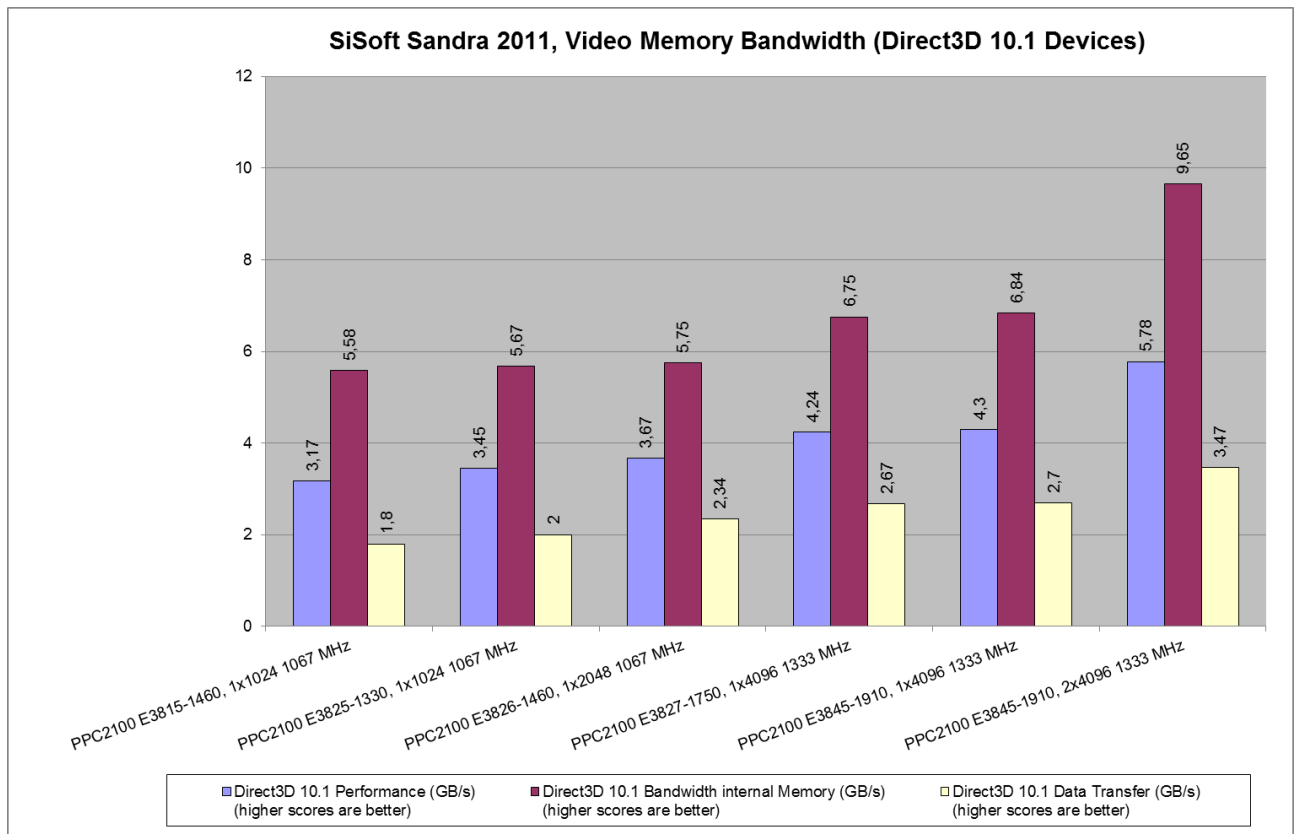

Figure 69: Results for SiSoft Sandra 2011, Video Memory Bandwidth (Direct3D 10.1 Devices) – APC2100/PPC2100

Higher scores are better

#	Test device	Direct3D 11 Performance (GB/s)	Direct3D 11 Bandwidth internal Memory (GB/s)	Direct3D 11 Data Transfer (GB/s)
APC2100/PPC2100 with INTEL Bay Trail				
60	E3815 1C 1.46GHz 512kB 5W, 1GB-1067MHz	3,14	5,59	1,77
61	E3825 2C 1.33GHz 1MB 6W, 1GB-1067MHz	3,49	5,78	2,1
62	E3826 2C 1.46GHz 1MB 7W, 2GB-1067MHz	3,68	5,77	2,34
63	E3827 2C 1.75GHz 1MB 8W, 4GB-1333MHz	4,24	6,74	2,67
64	E3845 4C 1.91GHz 2MB 10W, 4GB-1333MHz	4,3	6,83	2,7
65	E3845 4C 1.91GHz 2MB 10W, 8GB-1333MHz	5,79	9,69	3,46

Table 51: Results SiSoft Sandra 2011, Video Memory Bandwidth (Direct3D 11 Devices) – APC2100/PPC2100

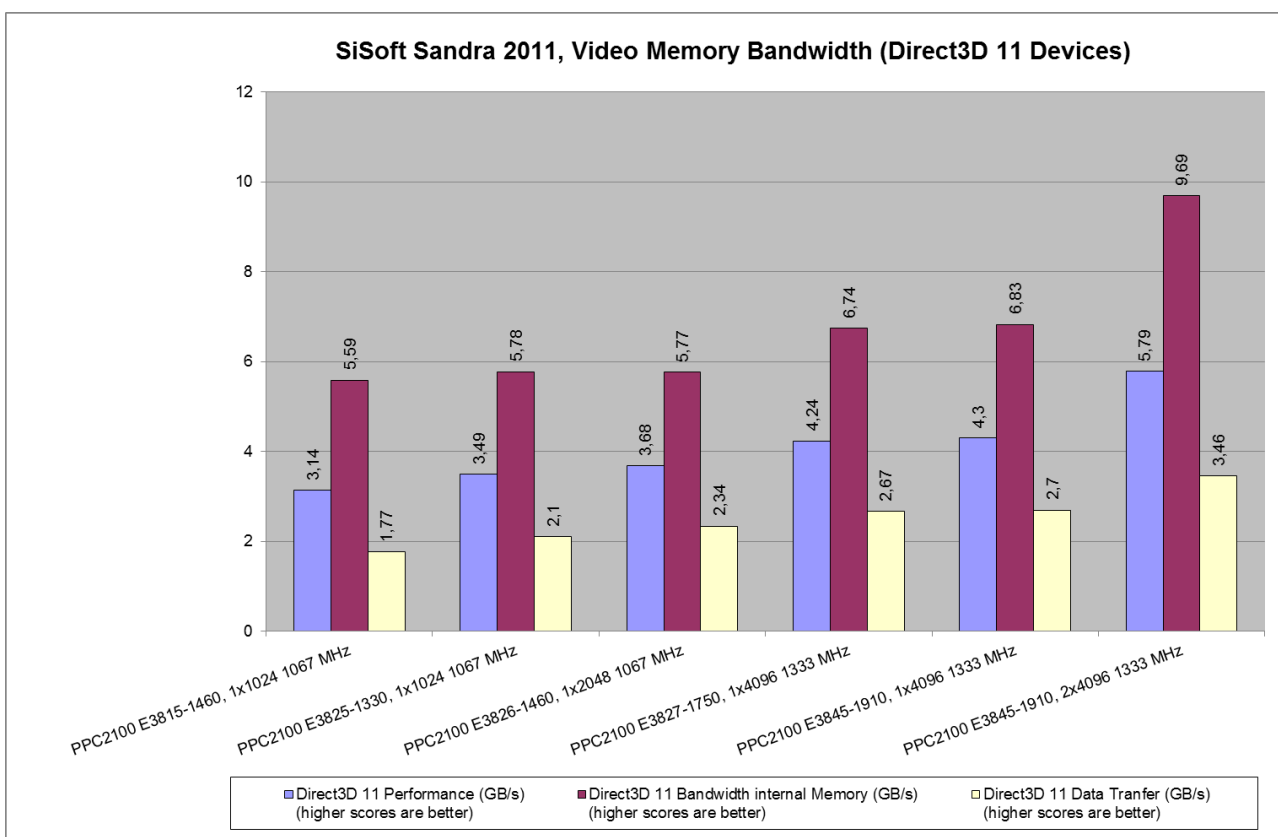

Figure 70: Results for SiSoft Sandra 2011, Video Memory Bandwidth (Direct3D 11 Devices) – APC2100/PPC2100

4.12.2.7 Memory Bandwidth

Benchmark the memory bandwidth of your computer. Shows how your memory sub-systems compare to other computers in terms of bandwidth.

Higher scores are better

#	Test device	Memory Performance (GB/s)	Integer B/F iAVX/128 Memory Bandwidth (GB/s)	Float B/F iAVX/128 Memory Bandwidth (GB/s)
APC2100/PPC2100 with INTEL Bay Trail				
60	E3815 1C 1.46GHz 512kB 5W, 1GB-1067MHz	4,22	4,13	4,3
61	E3825 2C 1.33GHz 1MB 6W, 1GB-1067MHz	4,2	4,2	4,2
62	E3826 2C 1.46GHz 1MB 7W, 2GB-1067MHz	4	4	4
63	E3827 2C 1.75GHz 1MB 8W, 4GB-1333MHz	4,7	4,74	4,67
64	E3845 4C 1.91GHz 2MB 10W, 4GB-1333MHz	5,33	5,34	5,32
65	E3845 4C 1.91GHz 2MB 10W, 8GB-1333MHz	6,18	6,2	6,17

Table 52: Results for SiSoft Sandra 2011, Memory Bandwidth – APC2100/PPC2100

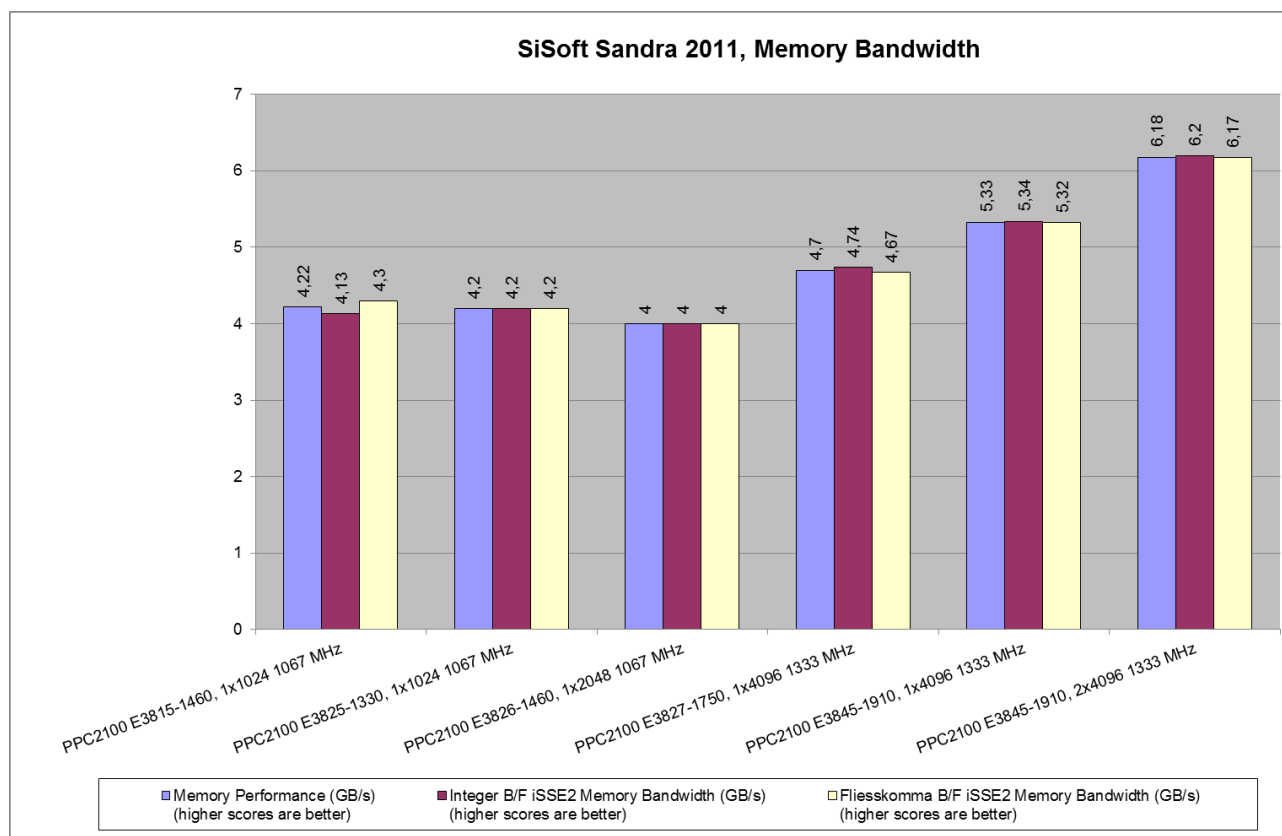

Figure 71: Results for SiSoft Sandra 2011, Memory Bandwidth – APC2100/PPC2100

4.12.2.8 Memory Latency

Benchmark the latency (response time) of processors caches and memory. Shows how your processors caches and memory sub-systems compare to other computers in terms of latency. The latency of caches is measured in processor clocks (i.e. how many clocks it takes for the data to be ready) as it is dependent on the processor clock speed. The latency of memory is measured in nanoseconds as it is typically independent on processor clock speed.

Lower scores are better

#	Test device	CPU1 Memory Latency Random (ns)	CPU1 Speed Factor Random (ns)	CPU1 Memory Latency Linear (ns)	CPU1 Speed Factor Linear (ns)
APC2100/PPC2100 with INTEL Bay Trail					
60	E3815 1C 1.46GHz 512kB 5W, 1GB-1067MHz	196,2	80,8	16	6,4
61	E3825 2C 1.33GHz 1MB 6W, 1GB-1067MHz	189,9	74,5	15,9	6,4
62	E3826 2C 1.46GHz 1MB 7W, 2GB-1067MHz	194	83,5	15,5	6,7
63	E3827 2C 1.75GHz 1MB 8W, 4GB-1333MHz	166,4	87,3	13,1	6,8
64	E3845 4C 1.91GHz 2MB 10W, 4GB-1333MHz	129,7	82,4	11,3	7,2
65	E3845 4C 1.91GHz 2MB 10W, 8GB-1333MHz	131,1	83,3	12,8	8,1

Table 53: Results for SiSoft Sandra 2011, Memory Latency CPU1 – APC2100/PPC2100

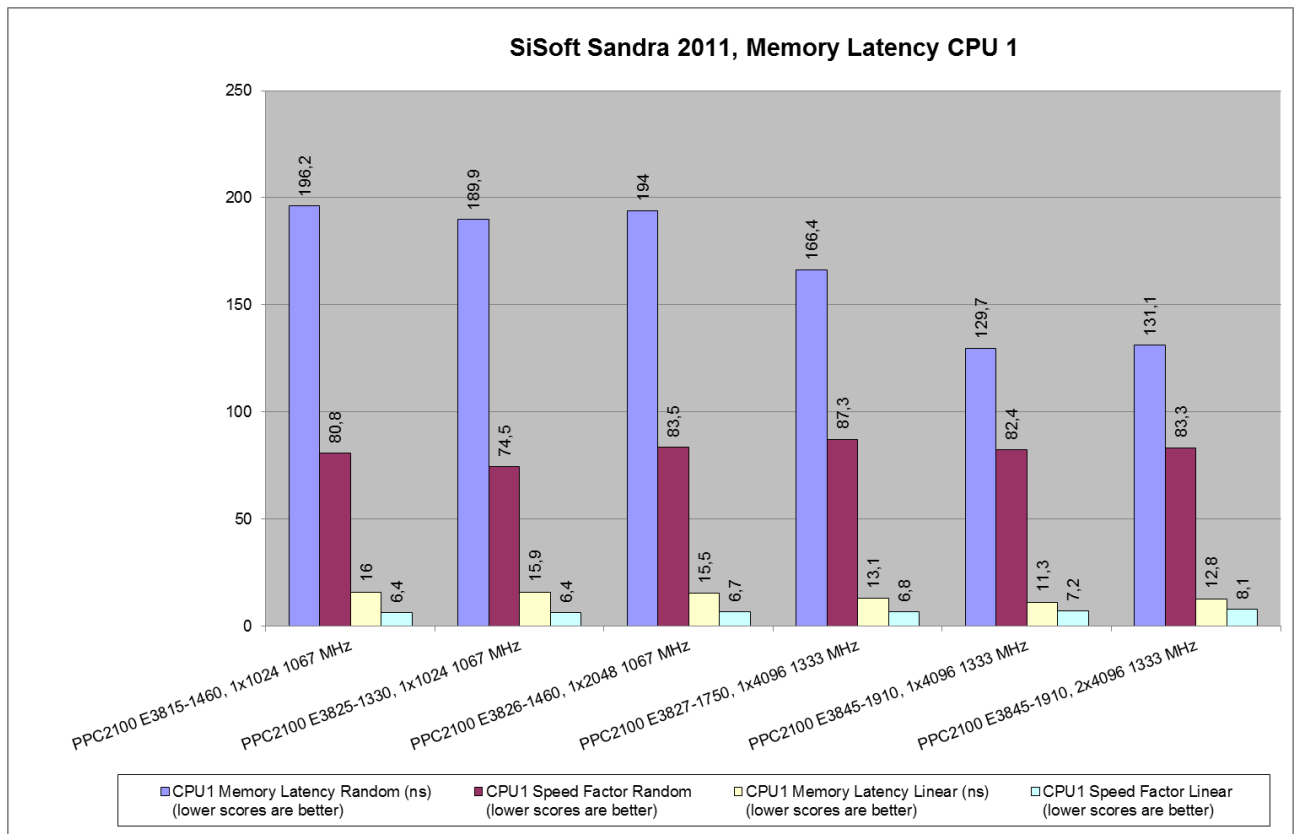

Figure 72: Results for SiSoft Sandra 2011, Memory Latency CPU1 – APC2100/PPC2100

Lower scores are better

#	Test device	CPU2 Memory Latency Random (ns)	CPU2 Speed Factor Random (ns)	CPU2 Memory Latency Linear (ns)	CPU2 Speed Factor Linear (ns)
APC2100/PPC2100 with INTEL Bay Trail					
60	E3815 1C 1.46GHz 512kB 5W, 1GB-1067MHz	-	-	-	-
61	E3825 2C 1.33GHz 1MB 6W, 1GB-1067MHz	186,8	72,6	17,7	6,2
62	E3826 2C 1.46GHz 1MB 7W, 2GB-1067MHz	187,9	81,9	15,2	6,6
63	E3827 2C 1.75GHz 1MB 8W, 4GB-1333MHz	163,2	86,1	12,6	6,6
64	E3845 4C 1.91GHz 2MB 10W, 4GB-1333MHz	127,7	81,5	11,2	7,1
65	E3845 4C 1.91GHz 2MB 10W, 8GB-1333MHz	129,8	82,8	12,7	8,1

Table 54: Results for SiSoft Sandra 2011, Memory Latency CPU2 – APC2100/PPC2100

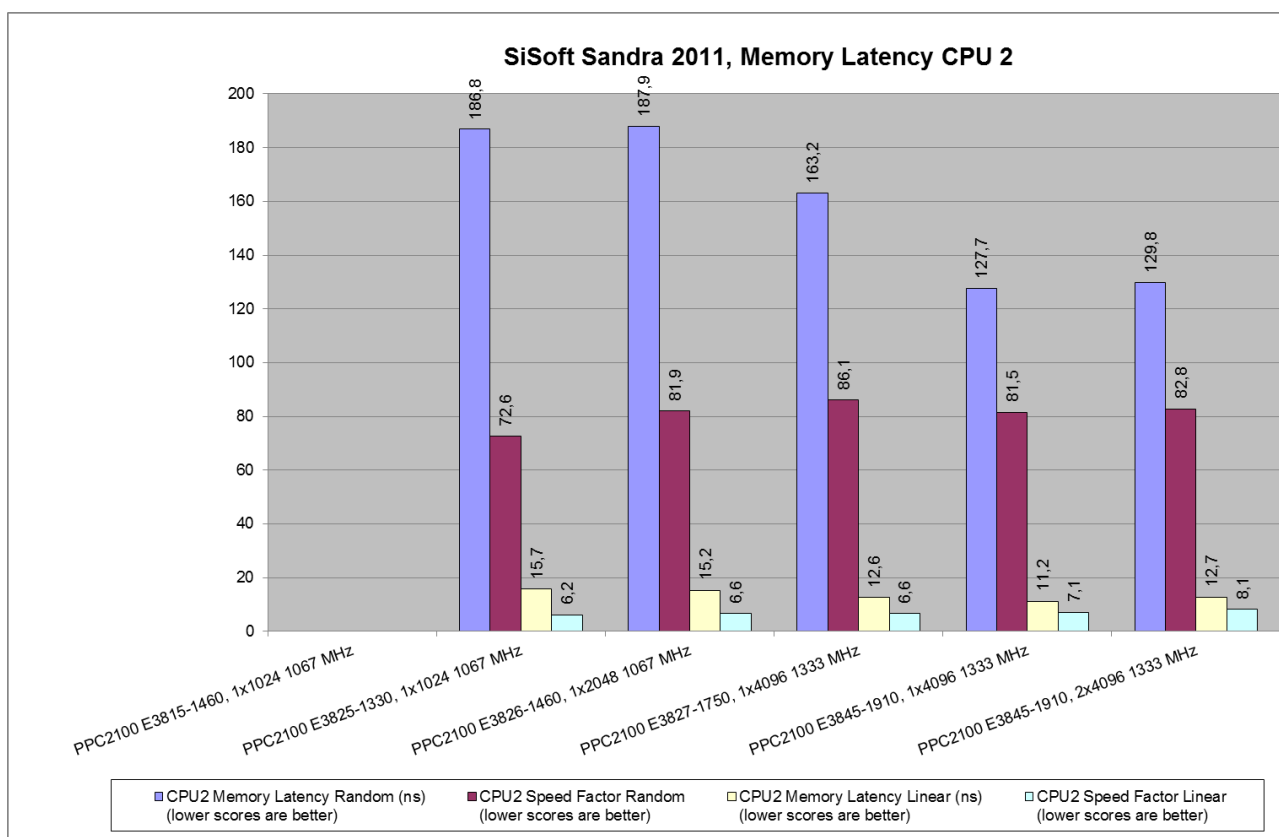

Figure 73: Results for SiSoft Sandra 2011, Memory Latency CPU2 – APC2100/PPC2100

4.12.2.9 Cache and Memory

Benchmark the processors caches and memory access (transfer speed). Shows how your processors caches and memory sub-systems compare to other computers in terms of access.

#	Test device	Cache/Memory Bandwidth (GB/s) (higher scores are better)	Speed Factor (lower scores are better)
APC2100/PPC2100 with INTEL Bay Trail			
60	E3815 1C 1.46GHz 512kB 5W, 1GB-1067MHz	7,54	5,9
61	E3825 2C 1.33GHz 1MB 6W, 1GB-1067MHz	10,8	9,5
62	E3826 2C 1.46GHz 1MB 7W, 2GB-1067MHz	10,58	11,1
63	E3827 2C 1.75GHz 1MB 8W, 4GB-1333MHz	12,73	11
64	E3845 4C 1.91GHz 2MB 10W, 4GB-1333MHz	22,25	22,8
65	E3845 4C 1.91GHz 2MB 10W, 8GB-1333MHz	23,83	19,2

Table 55: Results for SiSoft Sandra 2011, Cache and Memory – APC2100/PPC2100

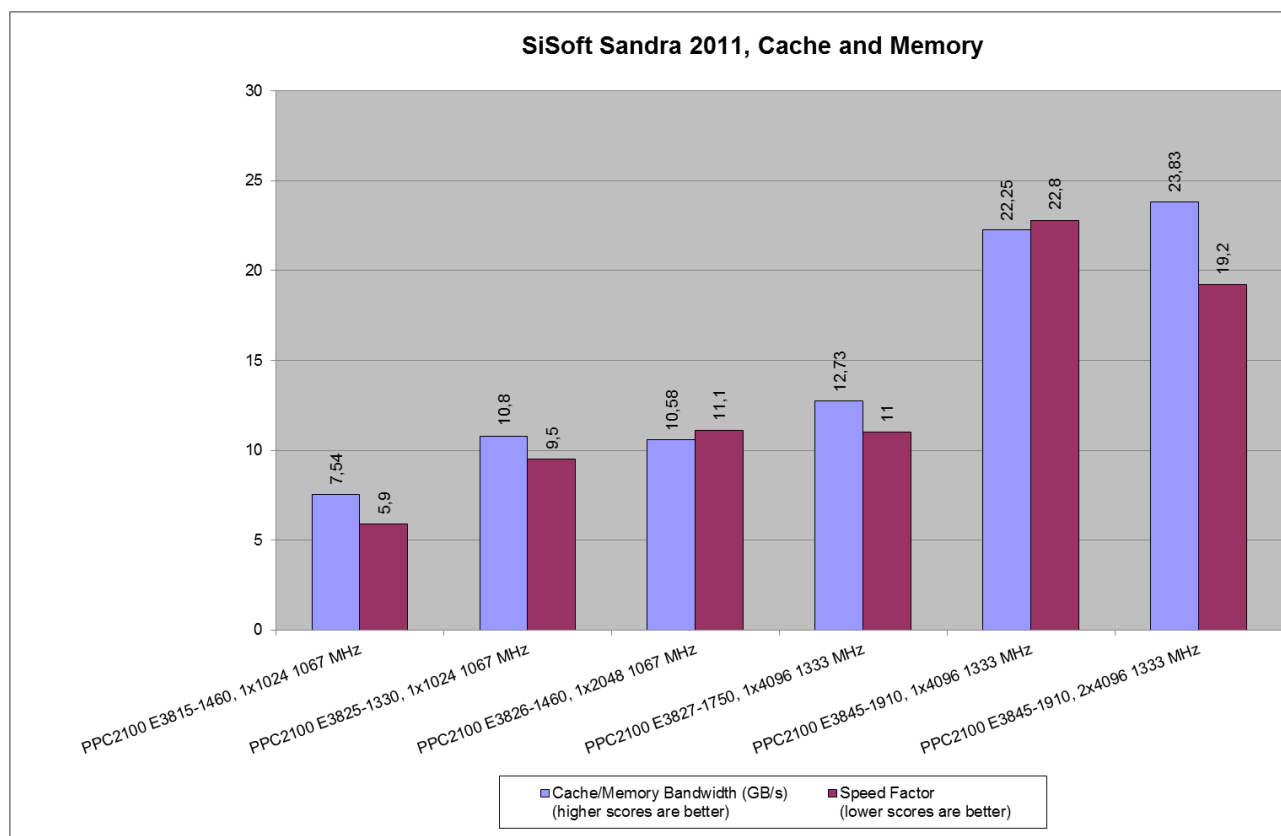

Figure 74: Results for SiSoft Sandra 2011, Cache and Memory – APC2100/PPC2100

4.12.3 Comparison APC910/PPC900 and APC2100/PPC2100

Benchmarks the ALU and FPU processor units. Shows how your processors handle arithmetic and floating point instructions in comparison to other typical processors. Such operations are used by software in typical tasks.

Higher scores are better

#	Test device	Arithmetic Performance (GOPS)	Dhrystone iSSE4.2 (GIPS)	Whetstone iSSE3 (GFLOPS)
APC910/PPC900 with INTEL QM77 Chipset				
38	i7-3615QE 4C 2.3/1.6GHz 6MB 45W 2x4096MB DDR3-SODIMM 1600MHz	95,55	120,59	75,71
40	i7-3612QE 4C 2.1/1.6GHz 6MB 35W, 2x4096MB DDR3-SODIMM 1600MHz	85,43	107,31	68
44	i7-3555LE 2C 2.5/1.6GHz 4MB 25W, 2x4096MB DDR3-SODIMM 1600MHz	45,83	57,5	36,52
46	i7-3517UE 2C 1.7/1.6GHz 4MB 17W, 2x4096MB DDR3-SODIMM 1600MHz	39,83	50	31,75
48	i5-3610ME 2C 2.7/1.6GHz 3MB 35W, 2x4096MB DDR3-SODIMM 1600MHz	47,39	59,42	37,8
50	i3-3120ME 2C 2.4/1.6GHz 3MB 35W, 2x4096MB DDR3-SODIMM 1600MHz	38,38	48	30,71
52	i3-3217UE 2C 1.6/1.6GHz 3MB 17W, 2x4096MB DDR3-SODIMM 1600MHz	24,8	31,33	19,64
APC910/PPC900 with INTEL HM76 Chipset				
54	C-847E 2C 1.1/1.3GHz 2MB 17W 2x4096MB DDR3-SODIMM 1333MHz	11,39	16,43	7,9
56	C-827E 1C 1.4/1.3GHz 1.5MB 17W 2x4096MB DDR3-SODIMM 1333MHz	7,18	10,46	5
58	C-1047UE 2C 1.4/1.6GHz 2MB 17W 2x4096MB DDR3-SODIMM 1600MHz	14,68	20,87	10,32
59	C-1020E 2C 2.2/1.6GHz 2MB 35W 2x4096MB DDR3-SODIMM 1600MHz	23,2	32,9	16,36
APC2100/PPC2100 with INTEL Bay Trail				
60	E3815 1C 1.46GHz 512kB 5W, 1GB-1067MHz	3,9	4,46	3,41
61	E3825 2C 1.33GHz 1MB 6W, 1GB-1067MHz	7	8	6,2
62	E3826 2C 1.46GHz 1MB 7W, 2GB-1067MHz	7,8	9,64	6,3
63	E3827 2C 1.75GHz 1MB 8W, 4GB-1333MHz	9,3	11,52	7,5
64	E3845 4C 1.91GHz 2MB 10W, 4GB-1333MHz	20,36	25,18	16,46
65	E3845 4C 1.91GHz 2MB 10W, 8GB-1333MHz	20,3	25,1	16,43

Table 56: Comparison for SiSoft Sandra 2011, CPU Arithmetic

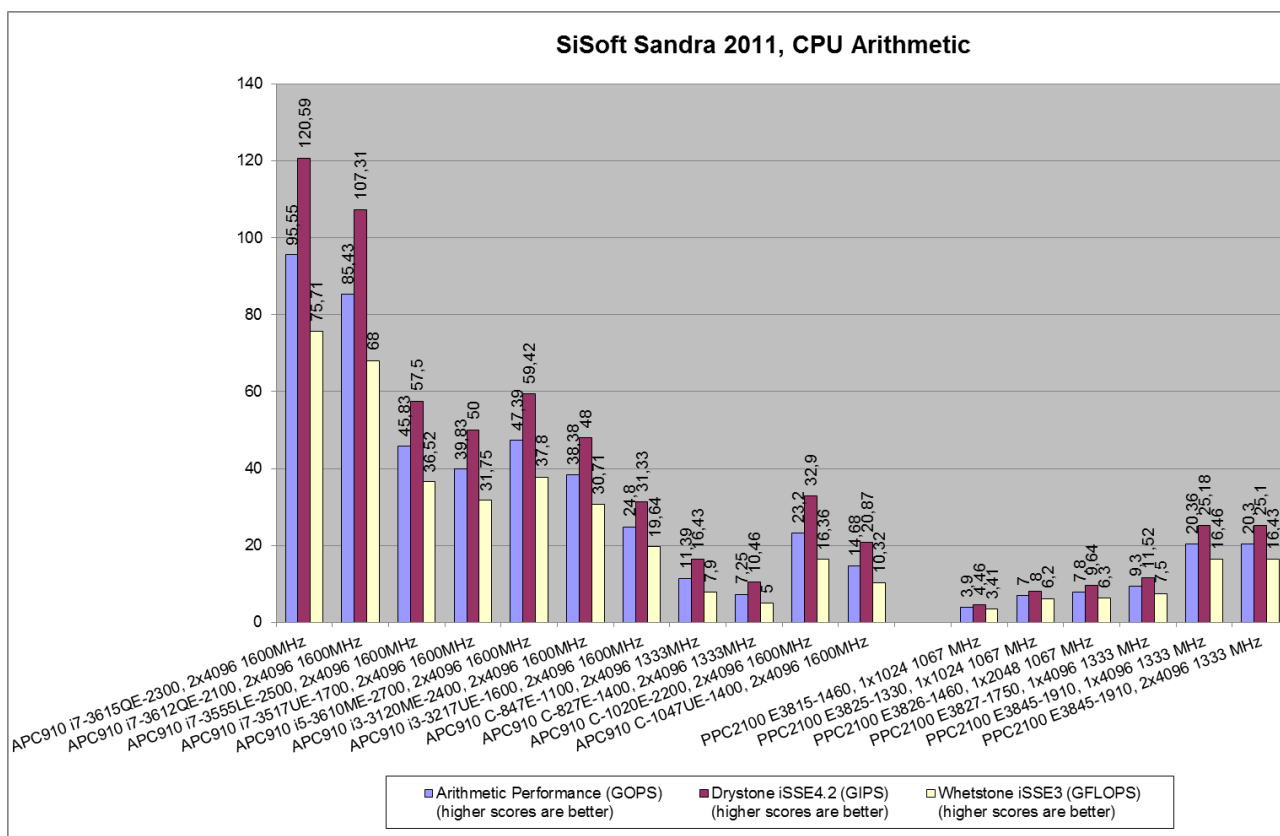

Figure 75: Comparison for SiSoft Sandra 2011, CPU Arithmetic

4.13 Passmark Performance Test 7.0

4.13.1 APC910/PPC900

4.13.1.1 Passmark Rating

The PassMark rating is weighted average of all the other test results and gives a single overall indication of the computers performance. The bigger the number, the faster the computer. The PassMark rating can only be calculated if the results from all other tests are available. The value is calculated using a series of weighted averages where some components are considered to be more important than others: Disk 21%, CD/DVD 5%, Memory 19%, 3D Graphics 12%, 2D Graphics 14% and CPU 29%.

Higher scores are better

#	Test device	Passmark Rating
APC810 with INTEL GM45 Chipset		
30	Core 2 Duo 2,53 GHz, 2x2048MB DDR3-SODIMM	979,6
APC910 with INTEL QM77 Chipset		
37	i7-3615QE 4C 2.3/1.6GHz 6MB 45W 2x4096MB DDR3-SODIMM 1067MHz	2255,4
38	i7-3615QE 4C 2.3/1.6GHz 6MB 45W 2x4096MB DDR3-SODIMM 1600MHz	2299,3
39	i7-3612QE 4C 2.1/1.6GHz 6MB 35W, 2x4096MB DDR3-SODIMM 1067MHz	1940,8
40	i7-3612QE 4C 2.1/1.6GHz 6MB 35W, 2x4096MB DDR3-SODIMM 1600MHz	2156,8
41	i7-3555LE 2C 2.5/1.6GHz 4MB 25W, 4096MB DDR3-SODIMM 1067MHz	1508,6
42	i7-3555LE 2C 2.5/1.6GHz 4MB 25W, 4096MB DDR3-SODIMM 1600MHz	1644,6
43	i7-3555LE 2C 2.5/1.6GHz 4MB 25W, 2x2048MB DDR3-SODIMM 1067MHz	1670,4
44	i7-3555LE 2C 2.5/1.6GHz 4MB 25W, 2x4096MB DDR3-SODIMM 1600MHz	1836,8
45	i7-3517UE 2C 1.7/1.6GHz 4MB 17W, 2x2048MB DDR3-SODIMM 1067MHz	1490,2
46	i7-3517UE 2C 1.7/1.6GHz 4MB 17W, 2x4096MB DDR3-SODIMM 1600MHz	1640,8
47	i5-3610ME 2C 2.7/1.6GHz 3MB 35W, 2x2048MB DDR3-SODIMM 1067MHz	1706,9
48	i5-3610ME 2C 2.7/1.6GHz 3MB 35W, 2x4096MB DDR3-SODIMM 1600MHz	1889
49	i3-3120ME 2C 2.4/1.6GHz 3MB 35W, 2x2048MB DDR3-SODIMM 1067MHz	1487,7
50	i3-3120ME 2C 2.4/1.6GHz 3MB 35W, 2x4096MB DDR3-SODIMM 1600MHz	1641,5
51	i3-3217UE 2C 1.6/1.6GHz 3MB 17W, 2x2048MB DDR3-SODIMM 1067MHz	1051,3
52	i3-3217UE 2C 1.6/1.6GHz 3MB 17W, 2x4096MB DDR3-SODIMM 1600MHz	1140,4
APC910 with INTEL HM76 Chipset		
53	C-847E 2C 1.1/1.3GHz 2MB 17W 2x2048MB DDR3-SODIMM 1067MHz	600,5
54	C-847E 2C 1.1/1.3GHz 2MB 17W 2x4096MB DDR3-SODIMM 1333MHz	645
55	C-827E 1C 1.4/1.3GHz 1.5MB 17W 2x2048MB DDR3-SODIMM 1067MHz	495,9
56	C-827E 1C 1.4/1.3GHz 1.5MB 17W 2x4096MB DDR3-SODIMM 1333MHz	538
58	C-1047UE 2C 1.4/1.6GHz 2MB 17W 2x4096MB DDR3-SODIMM 1600MHz	876
59	C-1020E 2C 2.2/1.6GHz 2MB 35W 2x4096MB DDR3-SODIMM 1600MHz	1257,9

Table 57: Results for Passmark Performance Test 7.0, Passmark Rating – APC910/PPC900

Passmark Performance-Test 7, Passmark Rating, DDR3 1067MHz

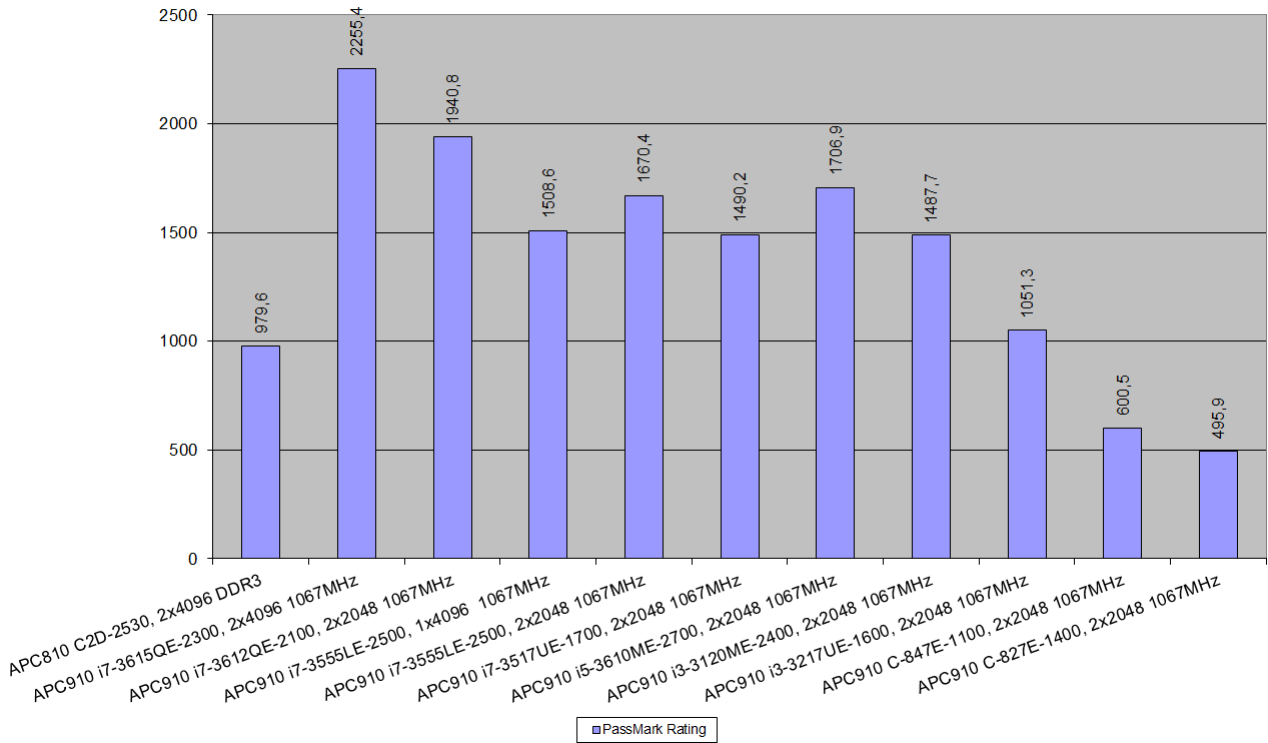

Figure 76: Results for Passmark Performance Test 7.0, Passmark Rating, DDR3 1067MHz – APC910/PPC900

Passmark Performance-Test 7, PassMark Rating, DDR3 1600/1333MHz

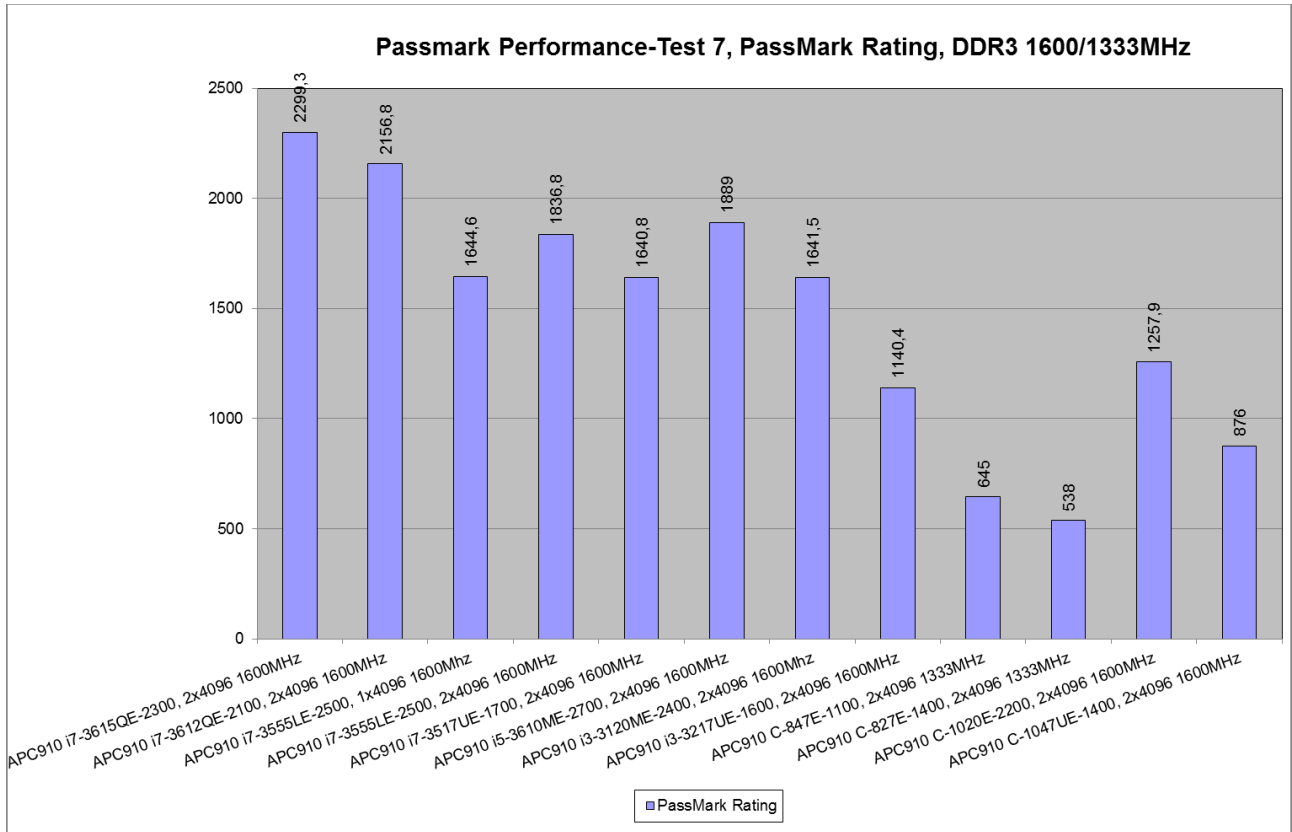

Figure 77: Results for Passmark Performance Test 7.0, Passmark Rating, DDR3 1600/1333MHz – APC910/PPC900

4.13.1.2 CPU Mark

This suite contains multi-process CPU tests. The number of CPU test processes is configurable in Preferences. The following tests make up the suite: Integer (addition, subtraction, multiplication, division), Floating Point (addition, subtraction, multiplication, division), Multimedia Instructions (128-bit SSE operations such as addition, subtraction and multiplication), Find Prime numbers, Compression, Encryption, Physics, Random String Sorting

Higher scores are better

#	Test device	CPU Mark
APC810 with INTEL GM45 Chipset		
30	Core 2 Duo 2,53 GHz, 2x2048MB DDR3-SODIMM	2269,1
APC910 with INTEL QM77 Chipset		
37	i7-3615QE 4C 2.3/1.6GHz 6MB 45W 2x4096MB DDR3-SODIMM 1067MHz	8790,4
38	i7-3615QE 4C 2.3/1.6GHz 6MB 45W 2x4096MB DDR3-SODIMM 1600MHz	8921,9
39	i7-3612QE 4C 2.1/1.6GHz 6MB 35W, 2x4096MB DDR3-SODIMM 1067MHz	7945,4
40	i7-3612QE 4C 2.1/1.6GHz 6MB 35W, 2x4096MB DDR3-SODIMM 1600MHz	8107,9
41	i7-3555LE 2C 2.5/1.6GHz 4MB 25W, 4096MB DDR3-SODIMM 1067MHz	4356,8
42	i7-3555LE 2C 2.5/1.6GHz 4MB 25W, 4096MB DDR3-SODIMM 1600MHz	4431,9
43	i7-3555LE 2C 2.5/1.6GHz 4MB 25W, 2x2048MB DDR3-SODIMM 1067MHz	4378,2
44	i7-3555LE 2C 2.5/1.6GHz 4MB 25W, 2x4096MB DDR3-SODIMM 1600MHz	4480,3
45	i7-3517UE 2C 1.7/1.6GHz 4MB 17W, 2x2048MB DDR3-SODIMM 1067MHz	3860,4
46	i7-3517UE 2C 1.7/1.6GHz 4MB 17W, 2x4096MB DDR3-SODIMM 1600MHz	3899,9
47	i5-3610ME 2C 2.7/1.6GHz 3MB 35W, 2x2048MB DDR3-SODIMM 1067MHz	4533,4
48	i5-3610ME 2C 2.7/1.6GHz 3MB 35W, 2x4096MB DDR3-SODIMM 1600MHz	4587,3
49	i3-3120ME 2C 2.4/1.6GHz 3MB 35W, 2x2048MB DDR3-SODIMM 1067MHz	3688,5
50	i3-3120ME 2C 2.4/1.6GHz 3MB 35W, 2x4096MB DDR3-SODIMM 1600MHz	3724,1
51	i3-3217UE 2C 1.6/1.6GHz 3MB 17W, 2x2048MB DDR3-SODIMM 1067MHz	2396,2
52	i3-3217UE 2C 1.6/1.6GHz 3MB 17W, 2x4096MB DDR3-SODIMM 1600MHz	2407,5
APC910 with INTEL HM76 Chipset		
53	C-847E 2C 1.1/1.3GHz 2MB 17W 2x2048MB DDR3-SODIMM 1067MHz	1146,7
54	C-847E 2C 1.1/1.3GHz 2MB 17W 2x4096MB DDR3-SODIMM 1333MHz	1175,5
55	C-827E 1C 1.4/1.3GHz 1.5MB 17W 2x2048MB DDR3-SODIMM 1067MHz	771,3
56	C-827E 1C 1.4/1.3GHz 1.5MB 17W 2x4096MB DDR3-SODIMM 1333MHz	771,9
58	C-1047UE 2C 1.4/1.6GHz 2MB 17W 2x4096MB DDR3-SODIMM 1600MHz	1601,8
59	C-1020E 2C 2.2/1.6GHz 2MB 35W 2x4096MB DDR3-SODIMM 1600MHz	2512,7

Table 58: Results for Passmark Performance Test 7.0, CPU Mark – APC910/PPC900

Passmark Performance-Test 7, CPU Mark, DDR3 1067MHz

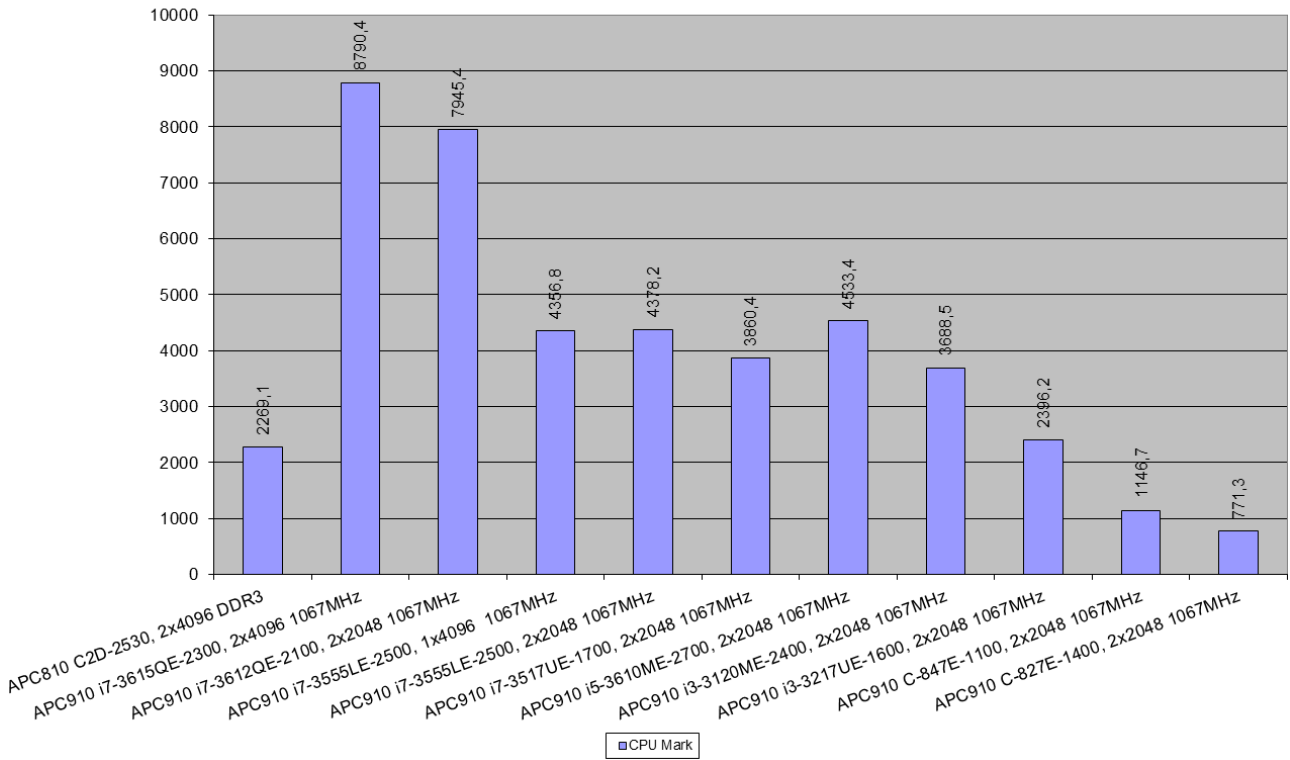

Figure 78: Results for Passmark Performance Test 7.0, CPU Mark, DDR3 1067MHz – APC910/PPC900

Passmark Performance-Test 7, CPU Mark, DDR3 1600/1333MHz

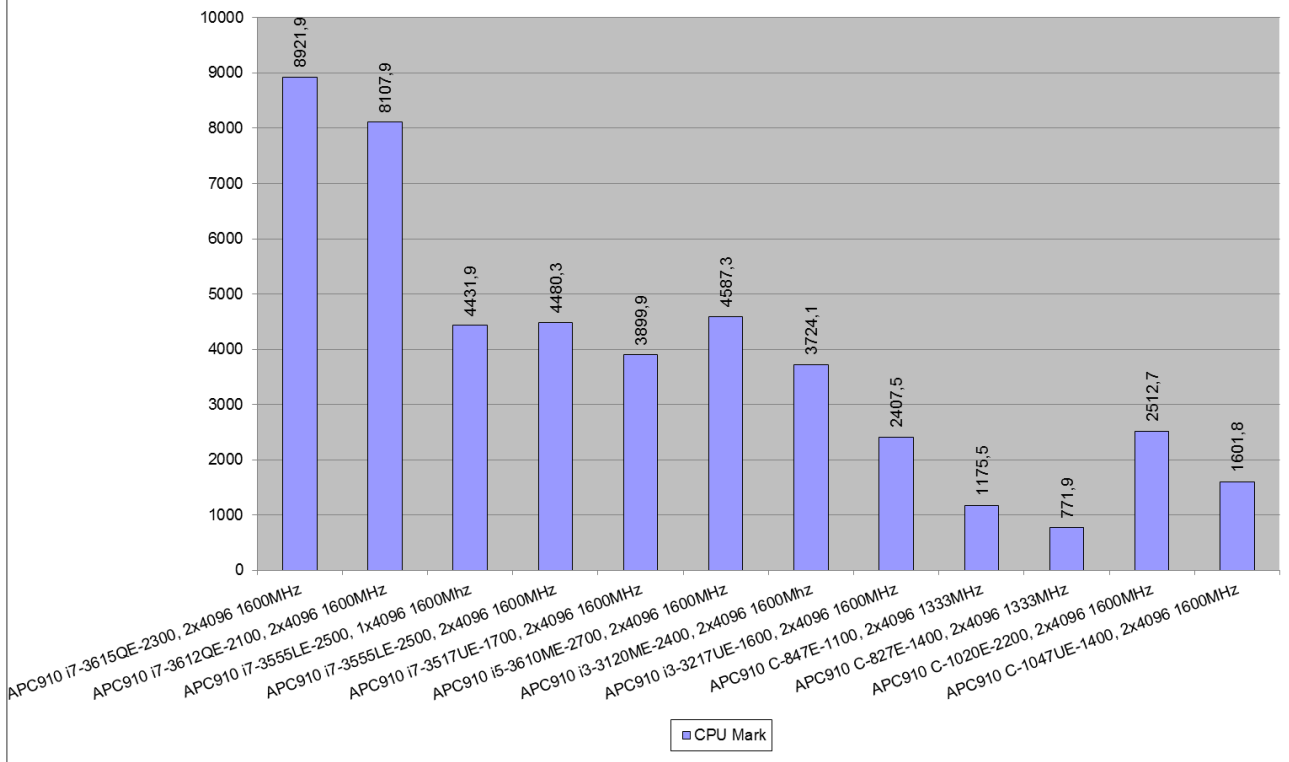

Figure 79: Results for Passmark Performance Test 7.0, CPU Mark, DDR3 1600/1333MHz – APC910/PPC900

4.13.1.3 2D Graphics Mark

This suite contains a number of tests that exercise the standard Windows graphics functions. The results from this suite depend on the speed at which the video card can carry out 2D graphics operations and the color depth currently in use. This suite contains: Solid Vectors, Transparent Vectors, Complex Vectors, Fonts and Text, Windows Interface, Image Filters, Image Rendering.

Higher scores are better

#	Test device	2D Graphics Mark
APC810 with INTEL GM45 Chipset		
30	Core 2 Duo 2,53 GHz, 2x2048MB DDR3-SODIMM	288,8
APC910 with INTEL QM77 Chipset		
37	i7-3615QE 4C 2.3/1.6GHz 6MB 45W 2x4096MB DDR3-SODIMM 1067MHz	456,1
38	i7-3615QE 4C 2.3/1.6GHz 6MB 45W 2x4096MB DDR3-SODIMM 1600MHz	459,4
39	i7-3612QE 4C 2.1/1.6GHz 6MB 35W, 2x4096MB DDR3-SODIMM 1067MHz	402,6
40	i7-3612QE 4C 2.1/1.6GHz 6MB 35W, 2x4096MB DDR3-SODIMM 1600MHz	405,7
41	i7-3555LE 2C 2.5/1.6GHz 4MB 25W, 4096MB DDR3-SODIMM 1067MHz	381,8
42	i7-3555LE 2C 2.5/1.6GHz 4MB 25W, 4096MB DDR3-SODIMM 1600MHz	409,7
43	i7-3555LE 2C 2.5/1.6GHz 4MB 25W, 2x2048MB DDR3-SODIMM 1067MHz	403
44	i7-3555LE 2C 2.5/1.6GHz 4MB 25W, 2x4096MB DDR3-SODIMM 1600MHz	416,3
45	i7-3517UE 2C 1.7/1.6GHz 4MB 17W, 2x2048MB DDR3-SODIMM 1067MHz	344,6
46	i7-3517UE 2C 1.7/1.6GHz 4MB 17W, 2x4096MB DDR3-SODIMM 1600MHz	352,3
47	i5-3610ME 2C 2.7/1.6GHz 3MB 35W, 2x2048MB DDR3-SODIMM 1067MHz	426,5
48	i5-3610ME 2C 2.7/1.6GHz 3MB 35W, 2x4096MB DDR3-SODIMM 1600MHz	436,6
49	i3-3120ME 2C 2.4/1.6GHz 3MB 35W, 2x2048MB DDR3-SODIMM 1067MHz	360,4
50	i3-3120ME 2C 2.4/1.6GHz 3MB 35W, 2x4096MB DDR3-SODIMM 1600MHz	374,1
51	i3-3217UE 2C 1.6/1.6GHz 3MB 17W, 2x2048MB DDR3-SODIMM 1067MHz	237,2
52	i3-3217UE 2C 1.6/1.6GHz 3MB 17W, 2x4096MB DDR3-SODIMM 1600MHz	236,6
APC910 with INTEL HM76 Chipset		
53	C-847E 2C 1.1/1.3GHz 2MB 17W 2x2048MB DDR3 1067MHz	155,2
54	C-847E 2C 1.1/1.3GHz 2MB 17W 2x4096MB DDR3 1333MHz	157,3
55	C-827E 1C 1.4/1.3GHz 1.5MB 17W 2x2048MB DDR3 1067MHz	170,5
56	C-827E 1C 1.4/1.3GHz 1.5MB 17W 2x4096MB DDR3 1333MHz	172,4
58	C-1047UE 2C 1.4/1.6GHz 2MB 17W 2x4096MB DDR3-SODIMM 1600MHz	225,9
59	C-1020E 2C 2.2/1.6GHz 2MB 35W 2x4096MB DDR3-SODIMM 1600MHz	349,7

Table 59: Results for Passmark Performance Test 7.0, 2D Graphics Mark – APC910/PPC900

Passmark Performance-Test 7, 2D Graphics Mark, DDR3 1067MHz

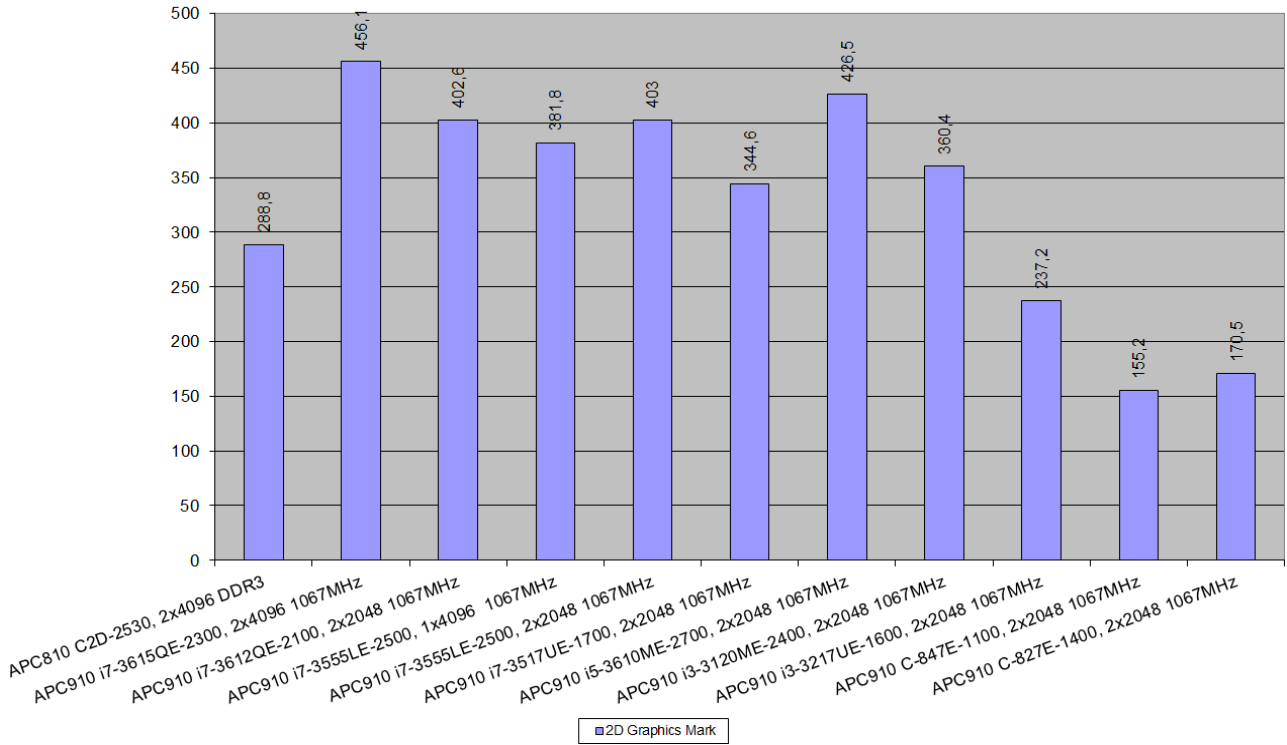

Figure 80: Results for Passmark Performance Test 7.0, 2D Graphics Mark, DDR3 1067MHz – APC910/PPC900

Passmark Performance-Test 7, 2D Graphics Mark, DDR3 1600/1333MHz

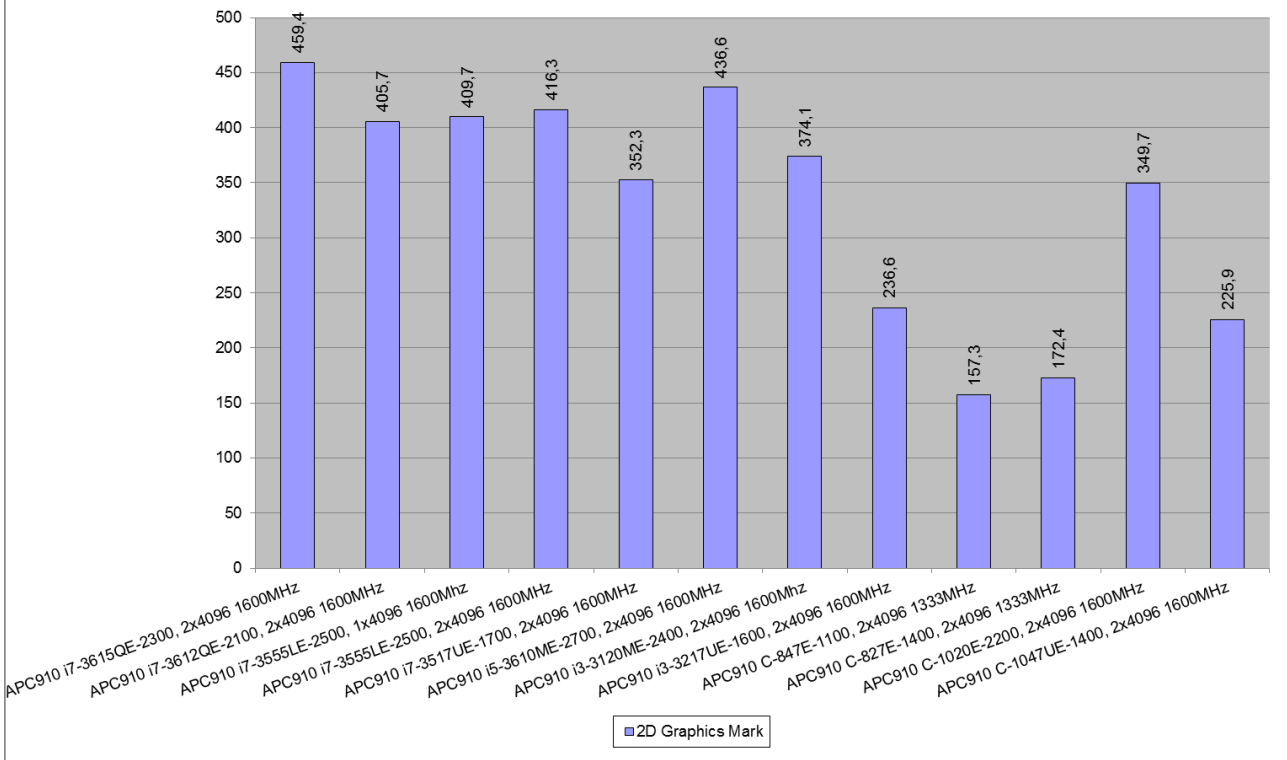

Figure 81: Results for Passmark Performance Test 7.0, 2D Graphics Mark, DDR3 1600/1333MHz – APC910/PPC900

4.13.1.4 3D Graphics Mark

This test suite attempts to measure the performance of the 3D graphics hardware installed in the machine. This test suite makes full use of version 9 of the Microsoft DirectX 3D library. Without DirectX 9.0 or above it will not be possible to run these tests. Three standard tests have been defined: Simple, Medium, and Complex.

Higher scores are better

#	Test device	3D Graphics Mark
APC810 with INTEL GM45 Chipset		
30	Core 2 Duo 2,53 GHz, 2x2048MB DDR3-SODIMM	188
APC910 with INTEL QM77 Chipset		
37	i7-3615QE 4C 2.3/1.6GHz 6MB 45W 2x4096MB DDR3-SODIMM 1067MHz	434,6
38	i7-3615QE 4C 2.3/1.6GHz 6MB 45W 2x4096MB DDR3-SODIMM 1600MHz	461,9
39	i7-3612QE 4C 2.1/1.6GHz 6MB 35W, 2x4096MB DDR3-SODIMM 1067MHz	420,7
40	i7-3612QE 4C 2.1/1.6GHz 6MB 35W, 2x4096MB DDR3-SODIMM 1600MHz	461,2
41	i7-3555LE 2C 2.5/1.6GHz 4MB 25W, 4096MB DDR3-SODIMM 1067MHz	271,6
42	i7-3555LE 2C 2.5/1.6GHz 4MB 25W, 4096MB DDR3-SODIMM 1600MHz	334,5
43	i7-3555LE 2C 2.5/1.6GHz 4MB 25W, 2x2048MB DDR3-SODIMM 1067MHz	370
44	i7-3555LE 2C 2.5/1.6GHz 4MB 25W, 2x4096MB DDR3-SODIMM 1600MHz	414,6
45	i7-3517UE 2C 1.7/1.6GHz 4MB 17W, 2x2048MB DDR3-SODIMM 1067MHz	353,1
46	i7-3517UE 2C 1.7/1.6GHz 4MB 17W, 2x4096MB DDR3-SODIMM 1600MHz	390,8
47	i5-3610ME 2C 2.7/1.6GHz 3MB 35W, 2x2048MB DDR3-SODIMM 1067MHz	362,4
48	i5-3610ME 2C 2.7/1.6GHz 3MB 35W, 2x4096MB DDR3-SODIMM 1600MHz	411,6
49	i3-3120ME 2C 2.4/1.6GHz 3MB 35W, 2x2048MB DDR3-SODIMM 1067MHz	351,2
50	i3-3120ME 2C 2.4/1.6GHz 3MB 35W, 2x4096MB DDR3-SODIMM 1600MHz	390,7
51	i3-3217UE 2C 1.6/1.6GHz 3MB 17W, 2x2048MB DDR3-SODIMM 1067MHz	334,5
52	i3-3217UE 2C 1.6/1.6GHz 3MB 17W, 2x4096MB DDR3-SODIMM 1600MHz	366,1
APC910 with INTEL HM76 Chipset		
53	C-847E 2C 1.1/1.3GHz 2MB 17W 2x2048MB DDR3 1067MHz	168,4
54	C-847E 2C 1.1/1.3GHz 2MB 17W 2x4096MB DDR3 1333MHz	171,3
55	C-827E 1C 1.4/1.3GHz 1.5MB 17W 2x2048MB DDR3 1067MHz	140,8
56	C-827E 1C 1.4/1.3GHz 1.5MB 17W 2x4096MB DDR3 1333MHz	143,4
58	C-1047UE 2C 1.4/1.6GHz 2MB 17W 2x4096MB DDR3-SODIMM 1600MHz	228,4
59	C-1020E 2C 2.2/1.6GHz 2MB 35W 2x4096MB DDR3-SODIMM 1600MHz	263

Table 60: Results for Passmark Performance Test 7.0, 3D Graphics Mark – APC910/PPC900

Passmark Performance-Test 7, 3D Graphics Mark, DDR3 1067MHz

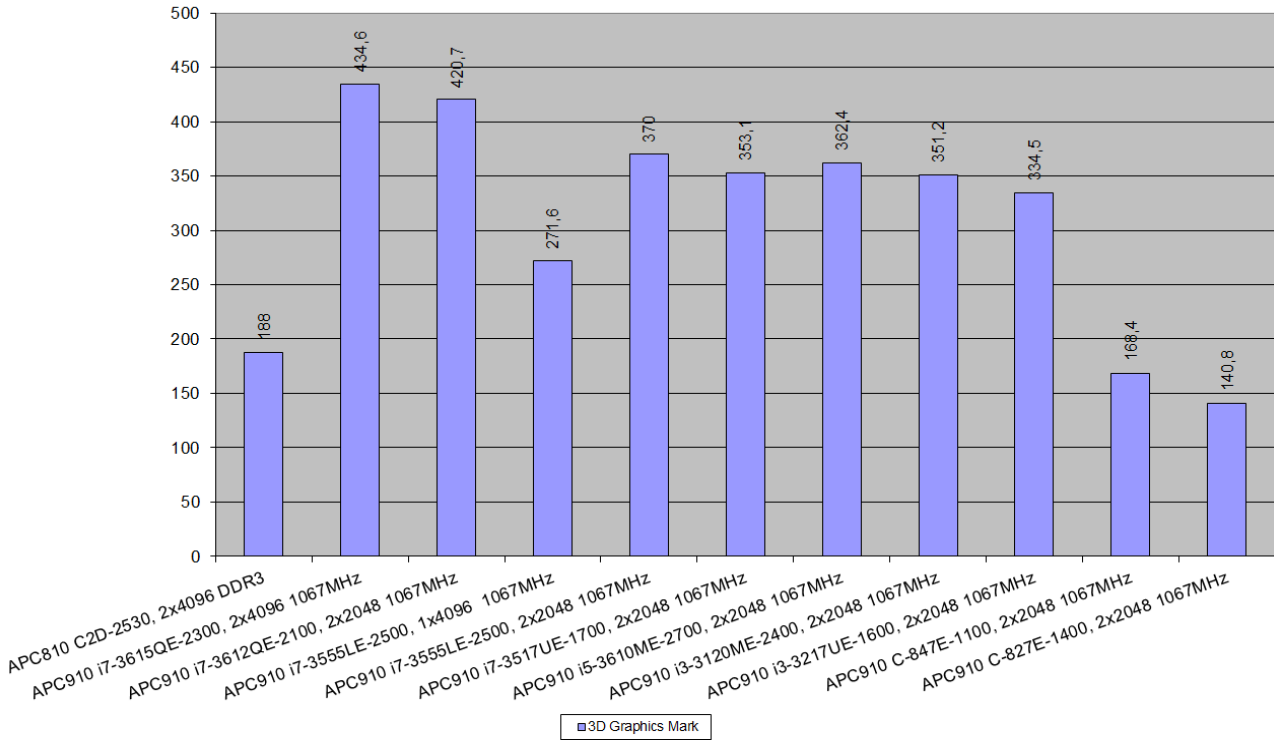

Figure 82: Results for Passmark Performance Test 7.0, 3D Graphics Mark, DDR3 1067MHz – APC910/PPC900

Passmark Performance-Test 7, 3D Graphics Mark, DDR3 1600/1333MHz

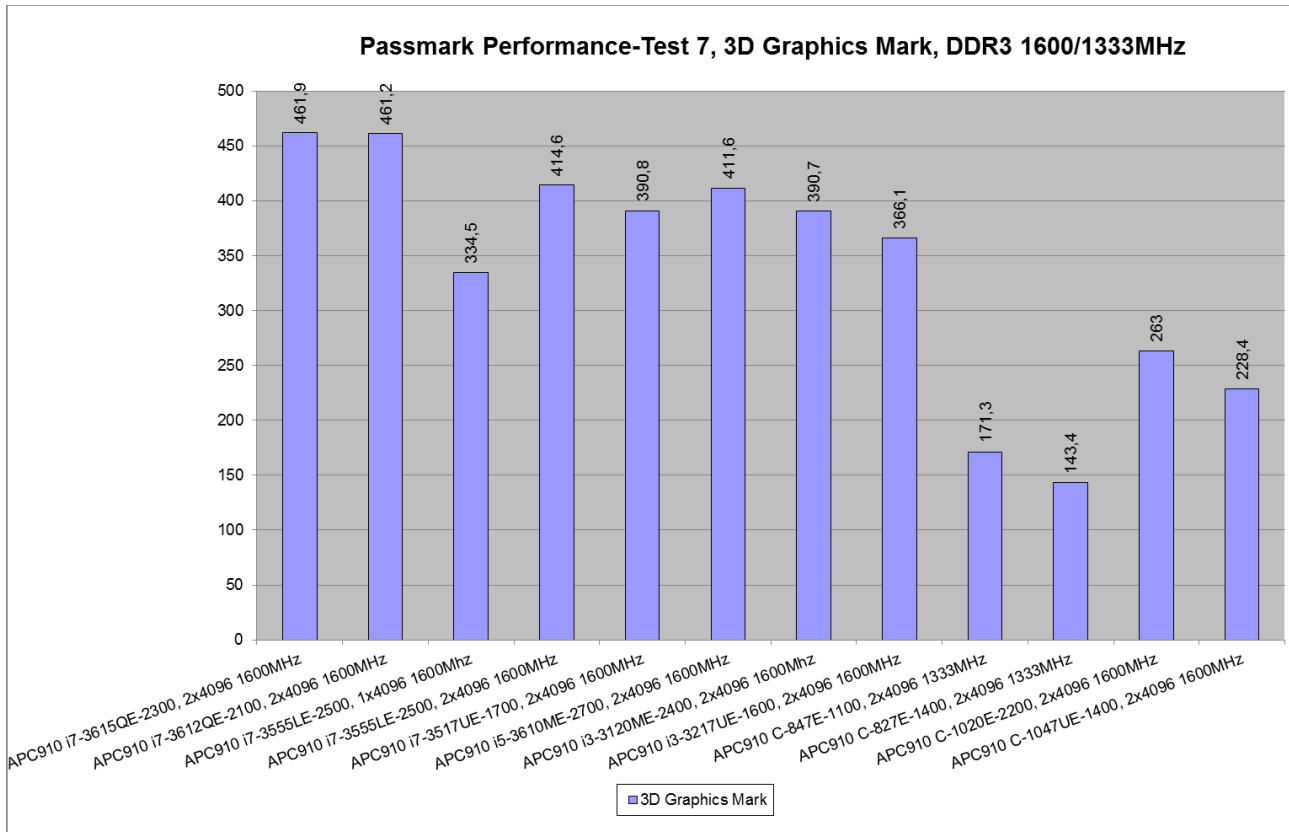

Figure 83: Results for Passmark Performance Test 7.0, 3D Graphics Mark, DDR3 1600/1333MHz – APC910/PPC900

4.13.1.5 Memory Mark

This test suite contains a number of tests that exercise the memory sub-system of the computer. All tests use a combination of 32-bit and 64-bit data when reading or writing from or to RAM. It contains: Memory-Allocate small block, Memory-Cached, Memory-UnCached, Memory-Write and Memory-Large RAM.

Higher scores are better

#	Test device	Memory Mark
APC810 with INTEL GM45 Chipset		
30	Core 2 Duo 2,53 GHz, 2x2048MB DDR3-SODIMM	1461,7
APC910 with INTEL QM77 Chipset		
37	i7-3615QE 4C 2.3/1.6GHz 6MB 45W 2x4096MB DDR3-SODIMM 1067MHz	2246,8
38	i7-3615QE 4C 2.3/1.6GHz 6MB 45W 2x4096MB DDR3-SODIMM 1600MHz	2250
39	i7-3612QE 4C 2.1/1.6GHz 6MB 35W, 2x4096MB DDR3-SODIMM 1067MHz	1337,2
40	i7-3612QE 4C 2.1/1.6GHz 6MB 35W, 2x4096MB DDR3-SODIMM 1600MHz	2139,6
41	i7-3555LE 2C 2.5/1.6GHz 4MB 25W, 4096MB DDR3-SODIMM 1067MHz	1395,7
42	i7-3555LE 2C 2.5/1.6GHz 4MB 25W, 4096MB DDR3-SODIMM 1600MHz	1442,5
43	i7-3555LE 2C 2.5/1.6GHz 4MB 25W, 2x2048MB DDR3-SODIMM 1067MHz	1420,1
44	i7-3555LE 2C 2.5/1.6GHz 4MB 25W, 2x4096MB DDR3-SODIMM 1600MHz	2109,8
45	i7-3517UE 2C 1.7/1.6GHz 4MB 17W, 2x2048MB DDR3-SODIMM 1067MHz	1226,2
46	i7-3517UE 2C 1.7/1.6GHz 4MB 17W, 2x4096MB DDR3-SODIMM 1600MHz	1972,3
47	i5-3610ME 2C 2.7/1.6GHz 3MB 35W, 2x2048MB DDR3-SODIMM 1067MHz	1443,7
48	i5-3610ME 2C 2.7/1.6GHz 3MB 35W, 2x4096MB DDR3-SODIMM 1600MHz	2287,4
49	i3-3120ME 2C 2.4/1.6GHz 3MB 35W, 2x2048MB DDR3-SODIMM 1067MHz	1224
50	i3-3120ME 2C 2.4/1.6GHz 3MB 35W, 2x4096MB DDR3-SODIMM 1600MHz	1921,6
51	i3-3217UE 2C 1.6/1.6GHz 3MB 17W, 2x2048MB DDR3-SODIMM 1067MHz	752,5
52	i3-3217UE 2C 1.6/1.6GHz 3MB 17W, 2x4096MB DDR3-SODIMM 1600MHz	1114,6
APC910 with INTEL HM76 Chipset		
53	C-847E 2C 1.1/1.3GHz 2MB 17W 2x2048MB DDR3 1067MHz	508,7
54	C-847E 2C 1.1/1.3GHz 2MB 17W 2x4096MB DDR3 1333MHz	770,1
55	C-827E 1C 1.4/1.3GHz 1.5MB 17W 2x2048MB DDR3 1067MHz	458,5
56	C-827E 1C 1.4/1.3GHz 1.5MB 17W 2x4096MB DDR3 1333MHz	935,9
58	C-1047UE 2C 1.4/1.6GHz 2MB 17W 2x4096MB DDR3-SODIMM 1600MHz	992,4
59	C-1020E 2C 2.2/1.6GHz 2MB 35W 2x4096MB DDR3-SODIMM 1600MHz	1537,9

Table 61: Results for Passmark Performance Test 7.0, Memory Mark – APC910/PPC900

Passmark Performance-Test 7, Memory Mark, DDR3 1067MHz

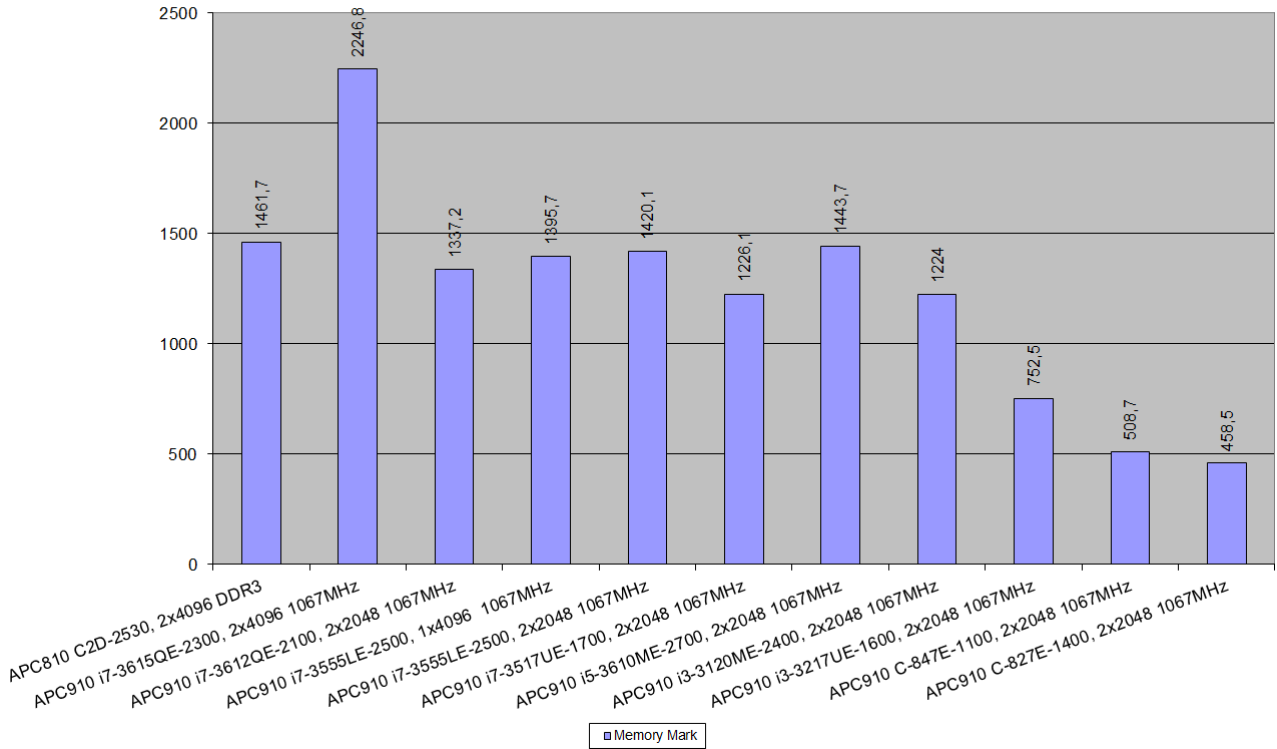

Figure 84: Results for Passmark Performance Test 7.0, Memory Mark, DDR3 1067MHz – APC910/PPC900

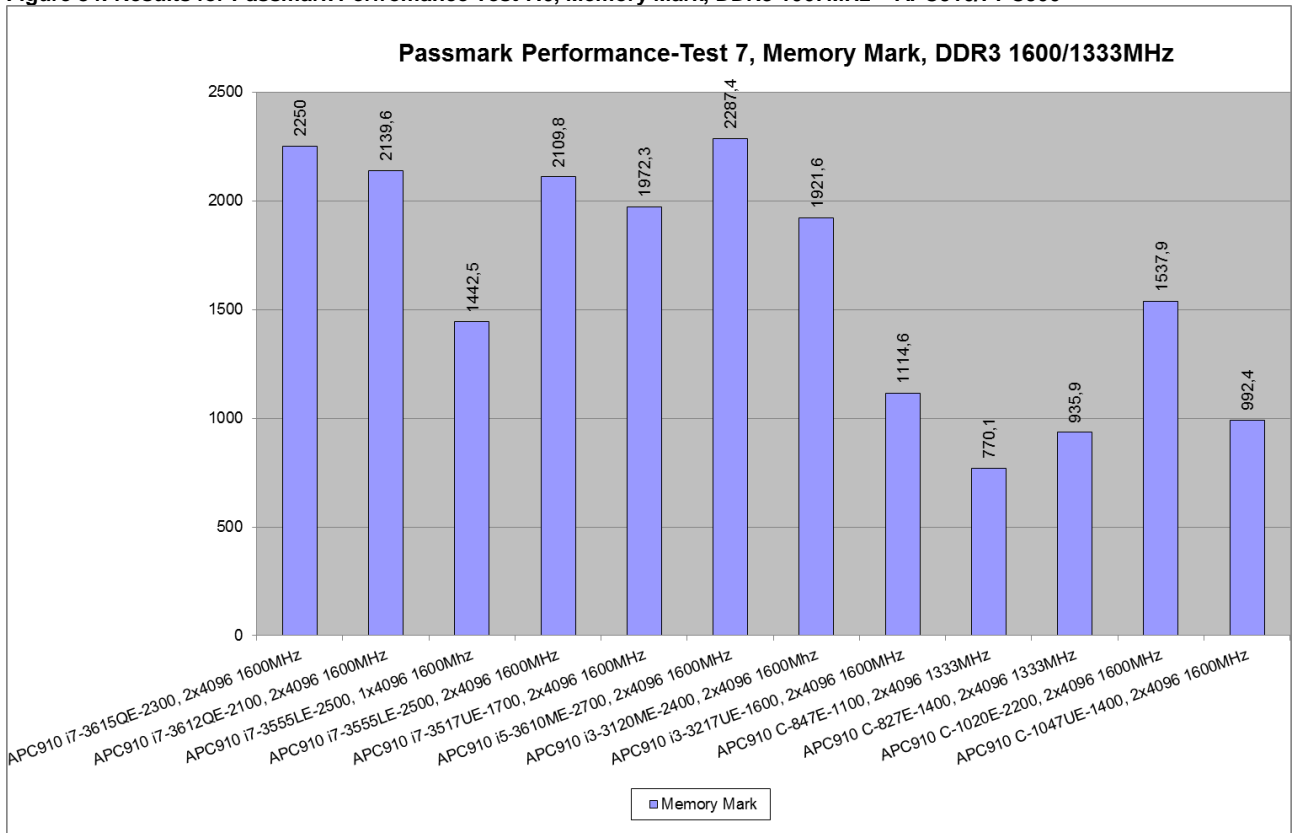

Figure 85: Results for Passmark Performance Test 7.0, Memory Mark, DDR3 1600/1333MHz – APC910/PPC900

4.13.1.6 Disk Mark

This suite contains a number of tests that exercise the mass storage units connected to the computer. By default, the current user's application directory is used for the test. This suite contains: Disk Sequential Read, Disk Sequential Write and Disk Random Seek RW.

Higher scores are better

#	Test device	Disk Mark
APC810 with INTEL GM45 Chipset		
30	Core 2 Duo 2,53 GHz, 2x2048MB DDR3-SODIMM	947,4
APC910 with INTEL QM77 Chipset		
37	i7-3615QE 4C 2.3/1.6GHz 6MB 45W 2x4096MB DDR3-SODIMM 1067MHz	3156,1
38	i7-3615QE 4C 2.3/1.6GHz 6MB 45W 2x4096MB DDR3-SODIMM 1600MHz	3152,9
39	i7-3612QE 4C 2.1/1.6GHz 6MB 35W, 2x4096MB DDR3-SODIMM 1067MHz	3066,7
40	i7-3612QE 4C 2.1/1.6GHz 6MB 35W, 2x4096MB DDR3-SODIMM 1600MHz	3088,8
41	i7-3555LE 2C 2.5/1.6GHz 4MB 25W, 4096MB DDR3-SODIMM 1067MHz	2991,8
42	i7-3555LE 2C 2.5/1.6GHz 4MB 25W, 4096MB DDR3-SODIMM 1600MHz	3041,4
43	i7-3555LE 2C 2.5/1.6GHz 4MB 25W, 2x2048MB DDR3-SODIMM 1067MHz	3108,2
44	i7-3555LE 2C 2.5/1.6GHz 4MB 25W, 2x4096MB DDR3-SODIMM 1600MHz	3029,3
45	i7-3517UE 2C 1.7/1.6GHz 4MB 17W, 2x2048MB DDR3-SODIMM 1067MHz	3097,3
46	i7-3517UE 2C 1.7/1.6GHz 4MB 17W, 2x4096MB DDR3-SODIMM 1600MHz	3093
47	i5-3610ME 2C 2.7/1.6GHz 3MB 35W, 2x2048MB DDR3-SODIMM 1067MHz	3031,2
48	i5-3610ME 2C 2.7/1.6GHz 3MB 35W, 2x4096MB DDR3-SODIMM 1600MHz	2996,3
49	i3-3120ME 2C 2.4/1.6GHz 3MB 35W, 2x2048MB DDR3-SODIMM 1067MHz	3070,9
50	i3-3120ME 2C 2.4/1.6GHz 3MB 35W, 2x4096MB DDR3-SODIMM 1600MHz	3023,6
51	i3-3217UE 2C 1.6/1.6GHz 3MB 17W, 2x2048MB DDR3-SODIMM 1067MHz	3043,2
52	i3-3217UE 2C 1.6/1.6GHz 3MB 17W, 2x4096MB DDR3-SODIMM 1600MHz	3021,7
APC910 with INTEL HM76 Chipset		
53	C-847E 2C 1.1/1.3GHz 2MB 17W 2x2048MB DDR3 1067MHz	3128,6
54	C-847E 2C 1.1/1.3GHz 2MB 17W 2x4096MB DDR3 1333MHz	3091,9
55	C-827E 1C 1.4/1.3GHz 1.5MB 17W 2x2048MB DDR3 1067MHz	3112,1
56	C-827E 1C 1.4/1.3GHz 1.5MB 17W 2x4096MB DDR3 1333MHz	2856,4
58	C-1047UE 2C 1.4/1.6GHz 2MB 17W 2x4096MB DDR3-SODIMM 1600MHz	3108,3
59	C-1020E 2C 2.2/1.6GHz 2MB 35W 2x4096MB DDR3-SODIMM 1600MHz	3142,4

Table 62: Results for Passmark Performance Test 7.0, Disk Mark – APC910/PPC900

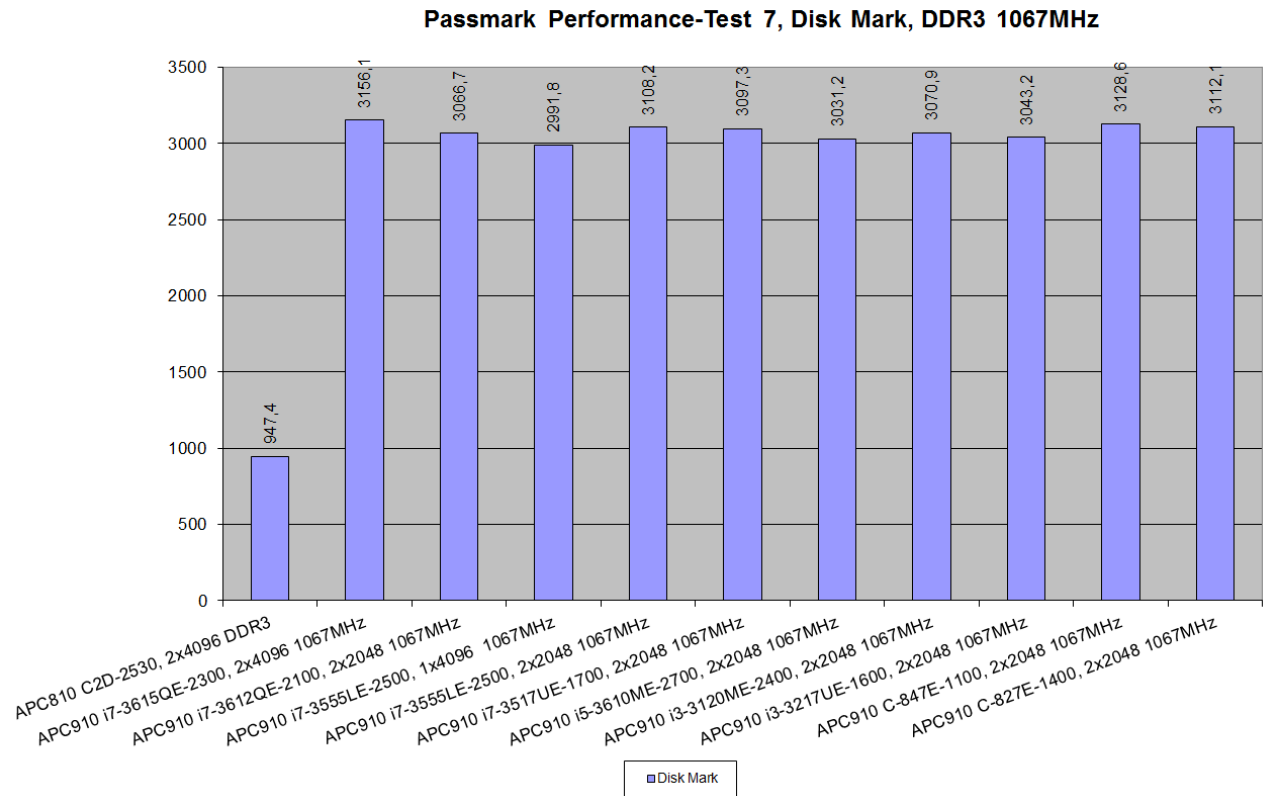

Figure 86: Results Passmark Performance Test 7.0, Disk Mark, DDR3 1067MHz – APC910/PPC900

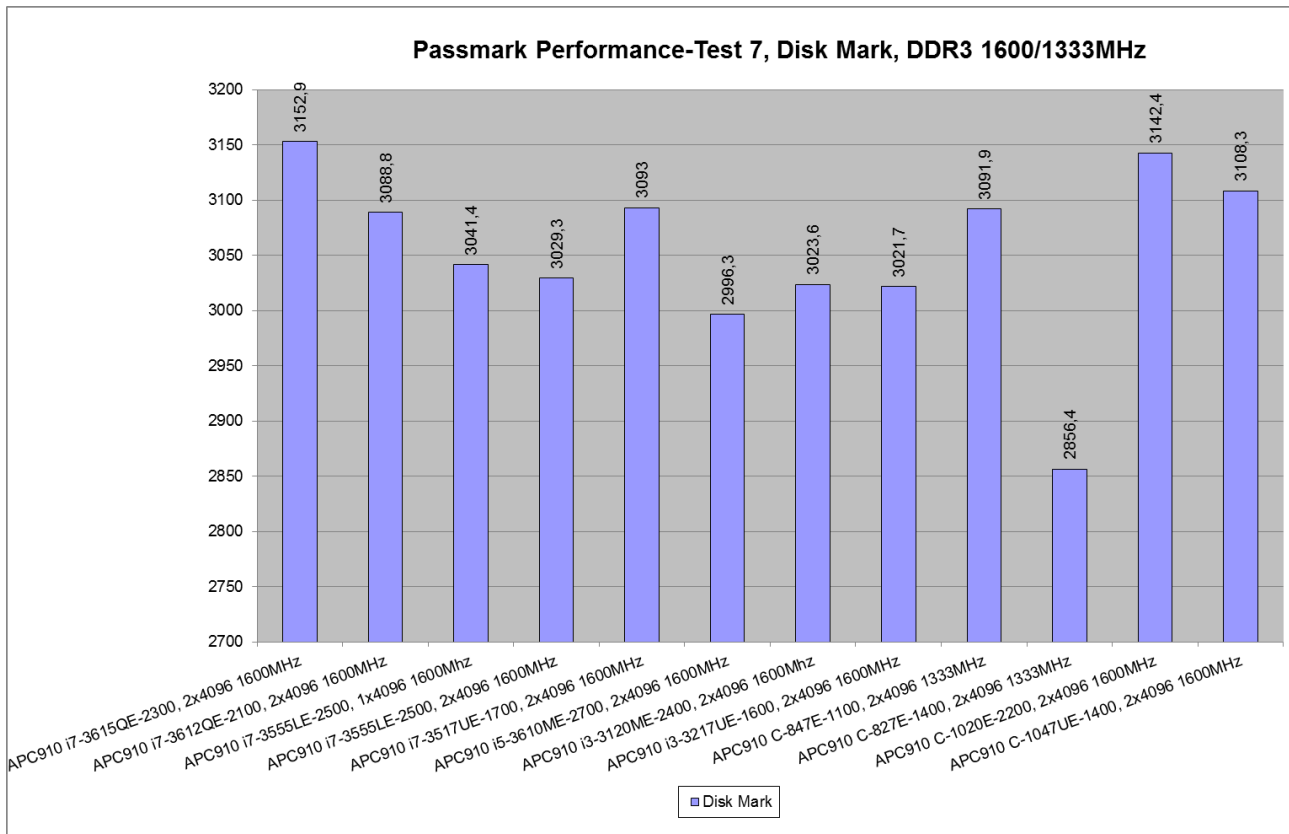

Figure 87: Results Passmark Performance Test 7.0, Disk Mark, DDR3 1600/1333MHz – APC910/PPC900

4.13.2 APC910

4.13.2.1 Passmark Rating

The PassMark rating is weighted average of all the other test results and gives a single overall indication of the computers performance. The bigger the number, the faster the computer. The PassMark rating can only be calculated if the results from all other tests are available. The value is calculated using a series of weighted averages where some components are considered to be more important than others: Disk 21%, CD/DVD 5%, Memory 19%, 3D Graphics 12%, 2D Graphics 14% and CPU 29%.

Higher scores are better

#	Test device	Passmark Rating
APC910 with INTEL QM77 Chipset		
38	i7-3615QE 4C 2.3/1.6GHz 6MB 45W 2x4096MB DDR3-SODIMM 1600MHz	2299,3
40	i7-3612QE 4C 2.1/1.6GHz 6MB 35W, 2x4096MB DDR3-SODIMM 1600MHz	2156,8
42	i7-3555LE 2C 2.5/1.6GHz 4MB 25W, 4096MB DDR3-SODIMM 1600MHz	1644,6
44	i7-3555LE 2C 2.5/1.6GHz 4MB 25W, 2x4096MB DDR3-SODIMM 1600MHz	1836,8
46	i7-3517UE 2C 1.7/1.6GHz 4MB 17W, 2x4096MB DDR3-SODIMM 1600MHz	1640,8
48	i5-3610ME 2C 2.7/1.6GHz 3MB 35W, 2x4096MB DDR3-SODIMM 1600MHz	1889
50	i3-3120ME 2C 2.4/1.6GHz 3MB 35W, 2x4096MB DDR3-SODIMM 1600MHz	1641,5
52	i3-3217UE 2C 1.6/1.6GHz 3MB 17W, 2x4096MB DDR3-SODIMM 1600MHz	1140,4
APC910 with INTEL HM76 Chipset		
54	C-847E 2C 1.1/1.3GHz 2MB 17W, 2x4096MB DDR3-SODIMM 1333MHz	645
56	C-827E 1C 1.4/1.3GHz 1.5MB 17W, 2x4096MB DDR3-SODIMM 1333MHz	538
58	C-1047UE 2C 1.4/1.6GHz 2MB 17W, 2x4096MB DDR3-SODIMM 1600MHz	876
59	C-1020E 2C 2.2/1.6GHz 2MB 35W, 2x4096MB DDR3-SODIMM 1600MHz	1257,9
APC910 with INTEL QM170 Chipset		
66	i5-6440EQ 4C 2.7GHz 6MB 45W, 2 x 4096 MB DDR4-SODIMM 2133MHz	2644,3
67	i7-6820EQ 4C 2.8GHz 8MB 45W, 2 x 8192 MB DDR4-SODIMM 2133MHz	2950,8
APC910 with INTEL HM170 Chipset		
68	i3-6100E 2C 2.7GHz 3MB 35W, 2 x 4096 MB DDR4-SODIMM 2133MHz	2224,1
69	i3-6100E 2C 1.9GHz 3MB 35W, 2 x 8192 MB DDR4-SODIMM 2133MHz	1766,5
70	C-G3900E 2C 2.4GHz 2MB 35W, 2 x 8192 MB DDR4-SODIMM 2133MHz	1854,3
71	C-G3900E 2C 1.7GHz 2MB 35W, 2 x 8192 MB DDR4-SODIMM 2133MHz	1383,7
APC910 with INTEL CM236 Chipset		
72	E3-1515MV5 4C 2,8GHz 8MB 45W, 2 x 8192 MB DDR4-SODIMM 2133MHz	3359,2

Table 63: Results for Passmark Performance Test 7.0, Passmark Rating – APC910

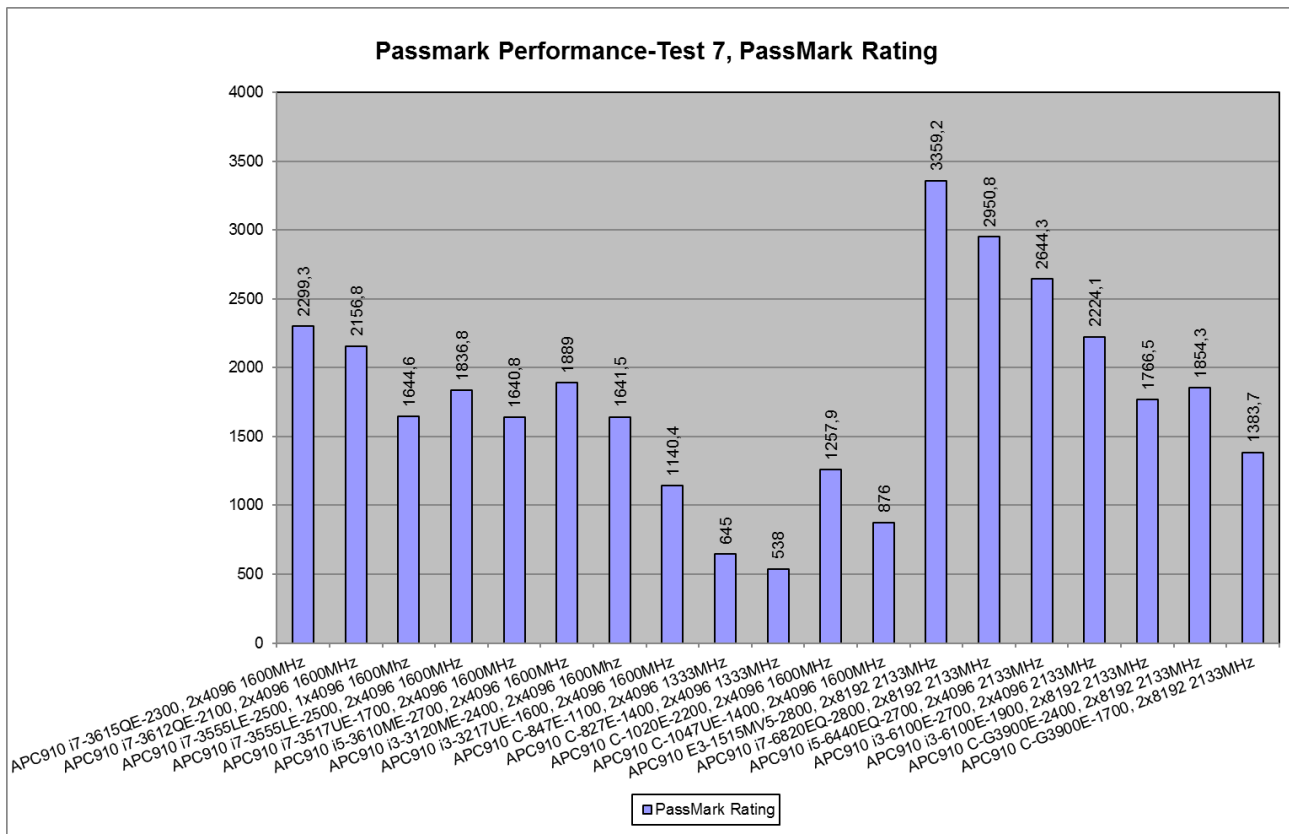

Figure 88: Results for Passmark Performance Test 7.0, Passmark Rating – APC910

4.13.2.2 CPU Mark

This suite contains multi-process CPU tests. The number of CPU test processes is configurable in Preferences. The following tests make up the suite: Integer (addition, subtraction, multiplication, division), Floating Point (addition, subtraction, multiplication, division), Multimedia Instructions (128-bit SSE operations such as addition, subtraction and multiplication), Find Prime numbers, Compression, Encryption, Physics, Random String Sorting

Higher scores are better

#	Test device	CPU Mark
APC910 with INTEL QM77 Chipset		
38	i7-3615QE 4C 2.3/1.6GHz 6MB 45W 2x4096MB DDR3-SODIMM 1600MHz	8921,9
40	i7-3612QE 4C 2.1/1.6GHz 6MB 35W, 2x4096MB DDR3-SODIMM 1600MHz	8107,9
42	i7-3555LE 2C 2.5/1.6GHz 4MB 25W, 4096MB DDR3-SODIMM 1600MHz	4431,9
44	i7-3555LE 2C 2.5/1.6GHz 4MB 25W, 2x4096MB DDR3-SODIMM 1600MHz	4480,3
46	i7-3517UE 2C 1.7/1.6GHz 4MB 17W, 2x4096MB DDR3-SODIMM 1600MHz	3899,9
48	i5-3610ME 2C 2.7/1.6GHz 3MB 35W, 2x4096MB DDR3-SODIMM 1600MHz	4587,3
50	i3-3120ME 2C 2.4/1.6GHz 3MB 35W, 2x4096MB DDR3-SODIMM 1600MHz	3724,1
52	i3-3217UE 2C 1.6/1.6GHz 3MB 17W, 2x4096MB DDR3-SODIMM 1600MHz	2407,5
APC910 with INTEL HM76 Chipset		
54	C-847E 2C 1.1/1.3GHz 2MB 17W 2x4096MB DDR3-SODIMM 1333MHz	1175,5
56	C-827E 1C 1.4/1.3GHz 1.5MB 17W 2x4096MB DDR3-SODIMM 1333MHz	771,9
58	C-1047UE 2C 1.4/1.6GHz 2MB 17W 2x4096MB DDR3-SODIMM 1600MHz	1601,8
59	C-1020E 2C 2.2/1.6GHz 2MB 35W 2x4096MB DDR3-SODIMM 1600MHz	2512,7
APC910 with INTEL QM170 Chipset		
66	i5-6440EQ 4C 2.7GHz 6MB 45W, 2 x 4096 MB DDR4-SODIMM 2133MHz	6500,8
67	i7-6820EQ 4C 2.8GHz 8MB 45W, 2 x 8192 MB DDR4-SODIMM 2133MHz	9291,4
APC910 with INTEL HM170 Chipset		
68	i3-6100E 2C 2.7GHz 3MB 35W, 2 x 4096 MB DDR4-SODIMM 2133MHz	4651,3
69	i3-6100E 2C 1.9GHz 3MB 35W, 2 x 8192 MB DDR4-SODIMM 2133MHz	3303,7
70	C-G3900E 2C 2.4GHz 2MB 35W, 2 x 8192 MB DDR4-SODIMM 2133MHz	3133,1
71	C-G3900E 2C 1.7GHz 2MB 35W, 2 x 8192 MB DDR4-SODIMM 2133MHz	2233,1
APC910 with INTEL CM236 Chipset		
72	E3-1515MV5 4C 2,8GHz 8MB 45W, 2 x 8192 MB DDR4-SODIMM 2133MHz	9583,8

Table 64: Results for Passmark Performance Test 7.0, CPU Mark – APC910

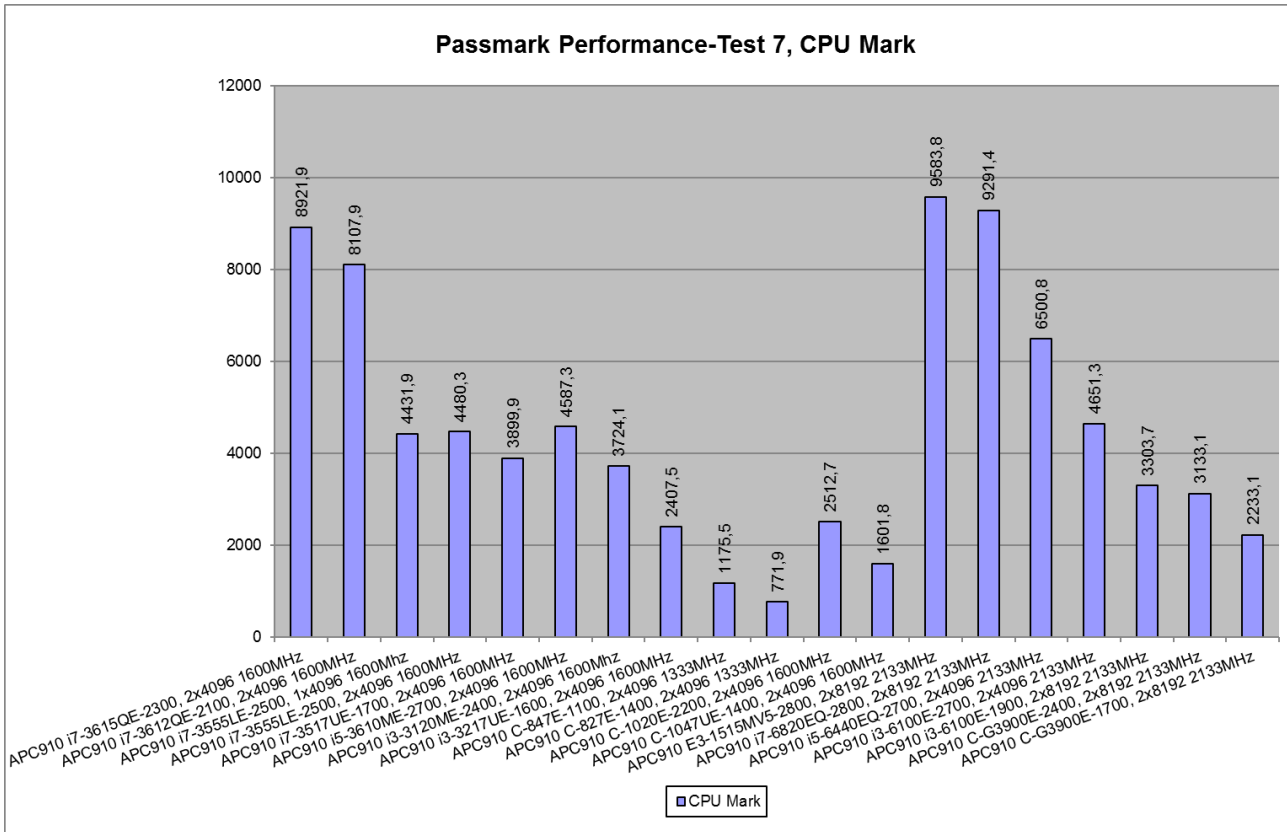

Figure 89: Results for Passmark Performance Test 7.0, CPU Mark – APC910

4.13.2.3 2D Graphics Mark

This suite contains a number of tests that exercise the standard Windows graphics functions. The results from this suite depend on the speed at which the video card can carry out 2D graphics operations and the color depth currently in use. This suite contains: Solid Vectors, Transparent Vectors, Complex Vectors, Fonts and Text, Windows Interface, Image Filters, Image Rendering.

Higher scores are better

#	Test device	2D Graphics Mark
APC910 with INTEL QM77 Chipset		
38	i7-3615QE 4C 2.3/1.6GHz 6MB 45W 2x4096MB DDR3-SODIMM 1600MHz	459,4
40	i7-3612QE 4C 2.1/1.6GHz 6MB 35W, 2x4096MB DDR3-SODIMM 1600MHz	405,7
42	i7-3555LE 2C 2.5/1.6GHz 4MB 25W, 4096MB DDR3-SODIMM 1600MHz	409,7
44	i7-3555LE 2C 2.5/1.6GHz 4MB 25W, 2x4096MB DDR3-SODIMM 1600MHz	416,3
46	i7-3517UE 2C 1.7/1.6GHz 4MB 17W, 2x4096MB DDR3-SODIMM 1600MHz	352,3
48	i5-3610ME 2C 2.7/1.6GHz 3MB 35W, 2x4096MB DDR3-SODIMM 1600MHz	436,6
50	i3-3120ME 2C 2.4/1.6GHz 3MB 35W, 2x4096MB DDR3-SODIMM 1600MHz	374,1
52	i3-3217UE 2C 1.6/1.6GHz 3MB 17W, 2x4096MB DDR3-SODIMM 1600MHz	236,6
APC910 with INTEL HM76 Chipset		
54	C-847E 2C 1.1/1.3GHz 2MB 17W 2x4096MB DDR3 1333MHz	157,3
56	C-827E 1C 1.4/1.3GHz 1.5MB 17W 2x4096MB DDR3 1333MHz	172,4
58	C-1047UE 2C 1.4/1.6GHz 2MB 17W 2x4096MB DDR3-SODIMM 1600MHz	225,9
59	C-1020E 2C 2.2/1.6GHz 2MB 35W 2x4096MB DDR3-SODIMM 1600MHz	349,7
APC910 with INTEL QM170 Chipset		
66	i5-6440EQ 4C 2.7GHz 6MB 45W, 2 x 4096 MB DDR4-SODIMM 2133MHz	540,5
67	i7-6820EQ 4C 2.8GHz 8MB 45W, 2 x 8192 MB DDR4-SODIMM 2133MHz	518,2
APC910 with INTEL HM170 Chipset		
68	i3-6100E 2C 2.7GHz 3MB 35W, 2 x 4096 MB DDR4-SODIMM 2133MHz	491,9
69	i3-6100E 2C 1.9GHz 3MB 35W, 2 x 8192 MB DDR4-SODIMM 2133MHz	350,7
70	C-G3900E 2C 2.4GHz 2MB 35W, 2 x 8192 MB DDR4-SODIMM 2133MHz	428,3
71	C-G3900E 2C 1.7GHz 2MB 35W, 2 x 8192 MB DDR4-SODIMM 2133MHz	304,4
APC910 with INTEL CM236 Chipset		
72	E3-1515MV5 4C 2,8GHz 8MB 45W, 2 x 8192 MB DDR4-SODIMM 2133MHz	519,7

Table 65: Results for Passmark Performance Test 7.0, 2D Graphics Mark – APC910

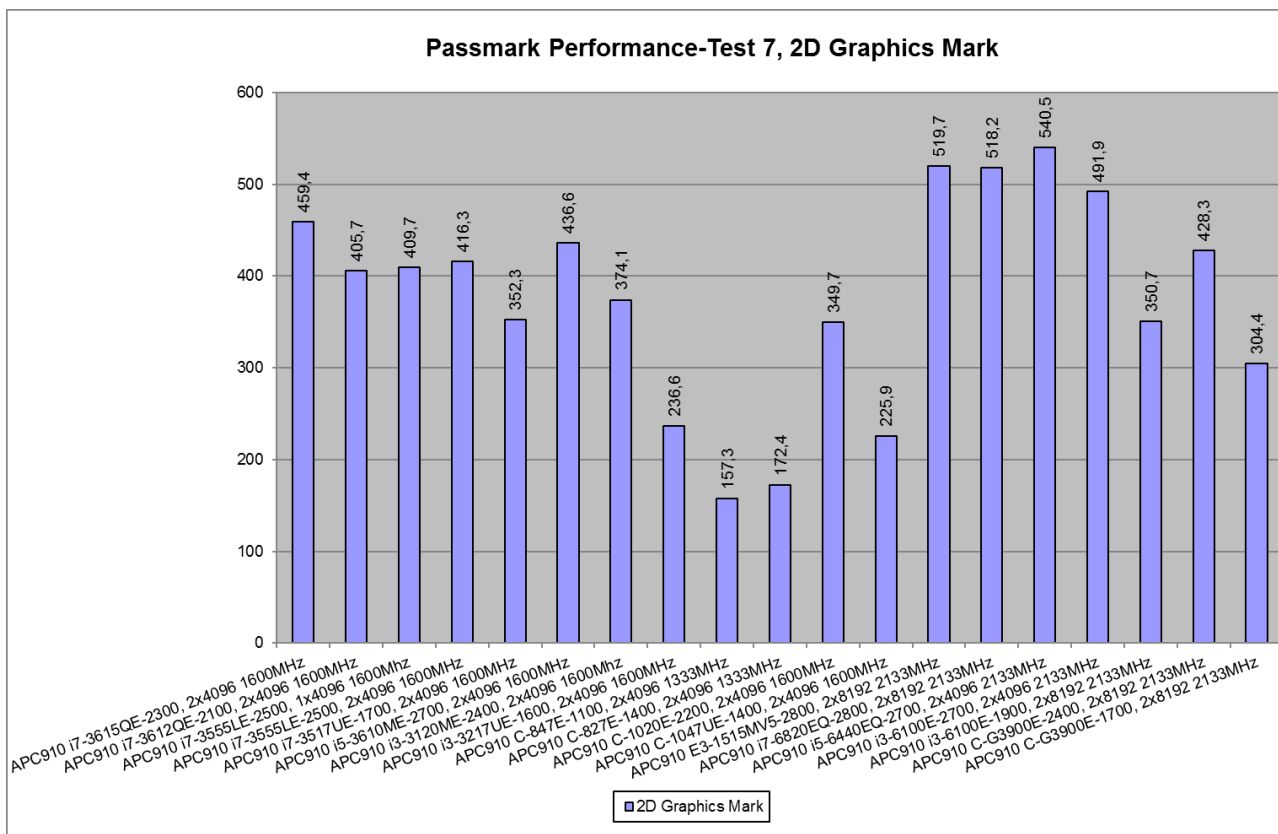

Figure 90: Results for Passmark Performance Test 7.0, 2D Graphics Mark – APC910

4.13.2.4 3D Graphics Mark

This test suite attempts to measure the performance of the 3D graphics hardware installed in the machine. This test suite makes full use of version 9 of the Microsoft DirectX 3D library. Without DirectX 9.0 or above it will not be possible to run these tests. Three standard tests have been defined: Simple, Medium, and Complex.

Higher scores are better

#	Test device	3D Graphics Mark
APC910 with INTEL QM77 Chipset		
38	i7-3615QE 4C 2.3/1.6GHz 6MB 45W 2x4096MB DDR3-SODIMM 1600MHz	461,9
40	i7-3612QE 4C 2.1/1.6GHz 6MB 35W, 2x4096MB DDR3-SODIMM 1600MHz	461,2
42	i7-3555LE 2C 2.5/1.6GHz 4MB 25W, 4096MB DDR3-SODIMM 1600MHz	334,5
44	i7-3555LE 2C 2.5/1.6GHz 4MB 25W, 2x4096MB DDR3-SODIMM 1600MHz	414,6
46	i7-3517UE 2C 1.7/1.6GHz 4MB 17W, 2x4096MB DDR3-SODIMM 1600MHz	390,8
48	i5-3610ME 2C 2.7/1.6GHz 3MB 35W, 2x4096MB DDR3-SODIMM 1600MHz	411,6
50	i3-3120ME 2C 2.4/1.6GHz 3MB 35W, 2x4096MB DDR3-SODIMM 1600MHz	390,7
52	i3-3217UE 2C 1.6/1.6GHz 3MB 17W, 2x4096MB DDR3-SODIMM 1600MHz	366,1
APC910 with INTEL HM76 Chipset		
54	C-847E 2C 1.1/1.3GHz 2MB 17W 2x4096MB DDR3 1333MHz	171,3
56	C-827E 1C 1.4/1.3GHz 1.5MB 17W 2x4096MB DDR3 1333MHz	143,4
58	C-1047UE 2C 1.4/1.6GHz 2MB 17W 2x4096MB DDR3-SODIMM 1600MHz	228,4
59	C-1020E 2C 2.2/1.6GHz 2MB 35W 2x4096MB DDR3-SODIMM 1600MHz	263
APC910 with INTEL QM170 Chipset		
66	i5-6440EQ 4C 2.7GHz 6MB 45W, 2 x 4096 MB DDR4-SODIMM 2133MHz	837,4
67	i7-6820EQ 4C 2.8GHz 8MB 45W, 2 x 8192 MB DDR4-SODIMM 2133MHz	819,7
APC910 with INTEL HM170 Chipset		
68	i3-6100E 2C 2.7GHz 3MB 35W, 2 x 4096 MB DDR4-SODIMM 2133MHz	749,9
69	i3-6100E 2C 1.9GHz 3MB 35W, 2 x 8192 MB DDR4-SODIMM 2133MHz	726,4
70	C-G3900E 2C 2.4GHz 2MB 35W, 2 x 8192 MB DDR4-SODIMM 2133MHz	628,4
71	C-G3900E 2C 1.7GHz 2MB 35W, 2 x 8192 MB DDR4-SODIMM 2133MHz	577,1
APC910 with INTEL CM236 Chipset		
72	E3-1515MV5 4C 2,8GHz 8MB 45W, 2 x 8192 MB DDR4-SODIMM 2133MHz	1712

Table 66: Results for Passmark Performance Test 7.0, 3D Graphics Mark – APC910

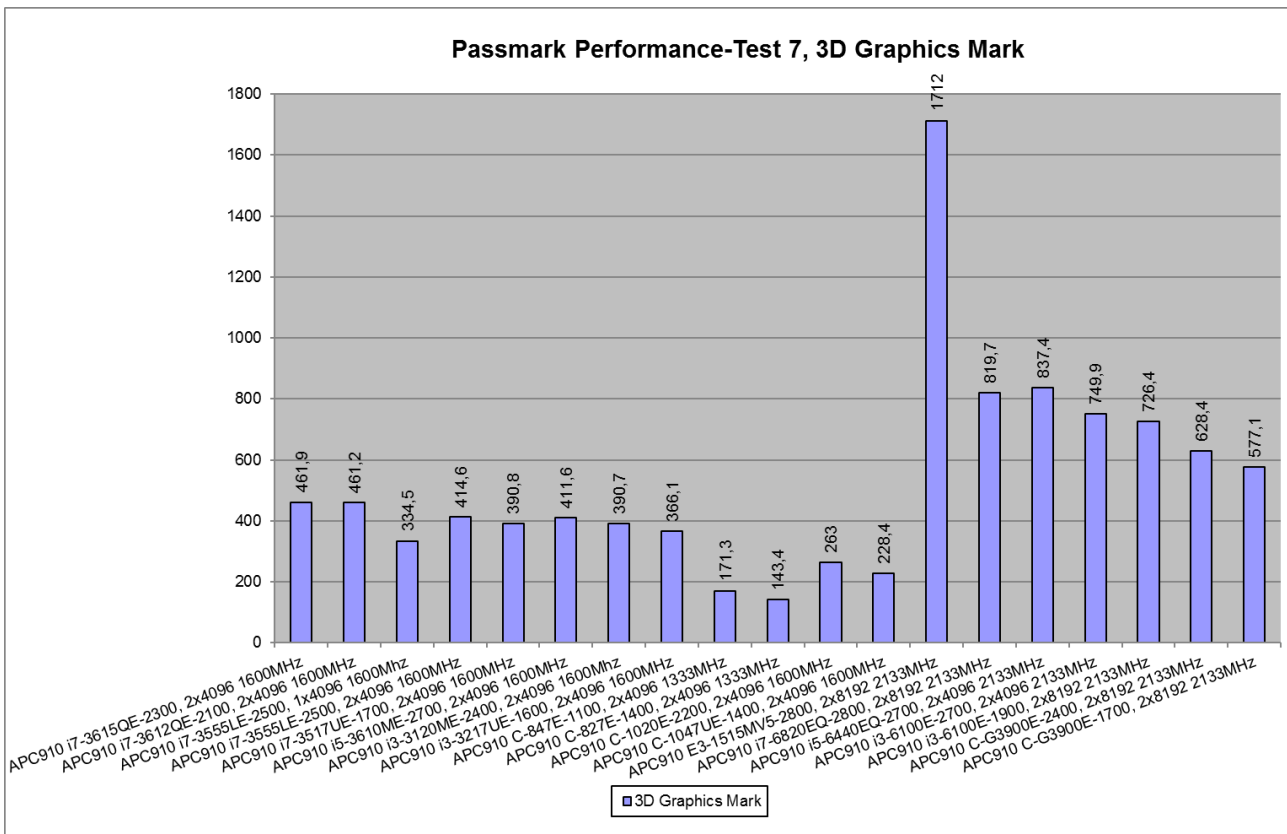

Figure 91: Results for Passmark Performance Test 7.0, 3D Graphics Mark – APC910

4.13.2.5 Memory Mark

This test suite contains a number of tests that exercise the memory sub-system of the computer. All tests use a combination of 32-bit and 64-bit data when reading or writing from or to RAM. It contains: Memory-Allocate small block, Memory-Cached, Memory-UnCached, Memory-Write and Memory-Large RAM.

Higher scores are better

#	Test device	Memory Mark
APC910 with INTEL QM77 Chipset		
38	i7-3615QE 4C 2.3/1.6GHz 6MB 45W 2x4096MB DDR3-SODIMM 1600MHz	2250
40	i7-3612QE 4C 2.1/1.6GHz 6MB 35W, 2x4096MB DDR3-SODIMM 1600MHz	2139,6
42	i7-3555LE 2C 2.5/1.6GHz 4MB 25W, 4096MB DDR3-SODIMM 1600MHz	1442,5
44	i7-3555LE 2C 2.5/1.6GHz 4MB 25W, 2x4096MB DDR3-SODIMM 1600MHz	2109,8
46	i7-3517UE 2C 1.7/1.6GHz 4MB 17W, 2x4096MB DDR3-SODIMM 1600MHz	1972,3
48	i5-3610ME 2C 2.7/1.6GHz 3MB 35W, 2x4096MB DDR3-SODIMM 1600MHz	2287,4
50	i3-3120ME 2C 2.4/1.6GHz 3MB 35W, 2x4096MB DDR3-SODIMM 1600MHz	1921,6
52	i3-3217UE 2C 1.6/1.6GHz 3MB 17W, 2x4096MB DDR3-SODIMM 1600MHz	1114,6
APC910 with INTEL HM76 Chipset		
54	C-847E 2C 1.1/1.3GHz 2MB 17W 2x4096MB DDR3 1333MHz	770,1
56	C-827E 1C 1.4/1.3GHz 1.5MB 17W 2x4096MB DDR3 1333MHz	935,9
58	C-1047UE 2C 1.4/1.6GHz 2MB 17W 2x4096MB DDR3-SODIMM 1600MHz	992,4
59	C-1020E 2C 2.2/1.6GHz 2MB 35W 2x4096MB DDR3-SODIMM 1600MHz	1537,9
APC910 with INTEL QM170 Chipset		
66	i5-6440EQ 4C 2.7GHz 6MB 45W, 2 x 4096 MB DDR4-SODIMM 2133MHz	2258,2
67	i7-6820EQ 4C 2.8GHz 8MB 45W, 2 x 8192 MB DDR4-SODIMM 2133MHz	3215,4
APC910 with INTEL HM170 Chipset		
68	i3-6100E 2C 2.7GHz 3MB 35W, 2 x 4096 MB DDR4-SODIMM 2133MHz	1974
69	i3-6100E 2C 1.9GHz 3MB 35W, 2 x 8192 MB DDR4-SODIMM 2133MHz	2229,2
70	C-G3900E 2C 2.4GHz 2MB 35W, 2 x 8192 MB DDR4-SODIMM 2133MHz	2802,1
71	C-G3900E 2C 1.7GHz 2MB 35W, 2 x 8192 MB DDR4-SODIMM 2133MHz	1998,5
APC910 with INTEL CM236 Chipset		
72	E3-1515MV5 4C 2,8GHz 8MB 45W, 2 x 8192 MB DDR4-SODIMM 2133MHz	3272,3

Table 67: Results for Passmark Performance Test 7.0, Memory Mark – APC910

Information:

The Passmark Performance Test 7 Memory Mark results are heavily dependent on the CPU frequency and the amount of installed main memory. Passmark already realized this fact and has done some improvements regarding the Memory Mark in Performance Test version 8 and 9. The actual test results shows this circumstances.

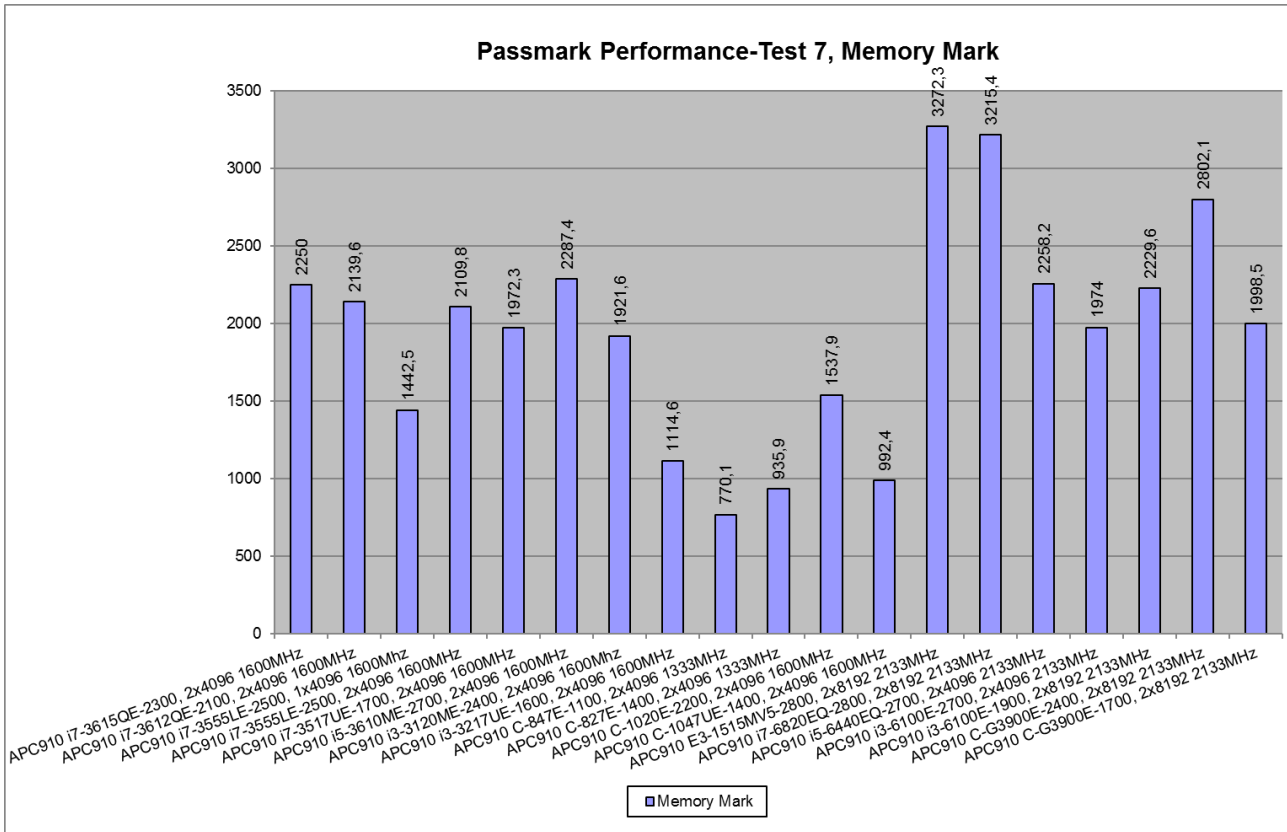

Figure 92: Results for Passmark Performance Test 7.0, Memory Mark – APC910

4.13.2.6 Disk Mark

This suite contains a number of tests that exercise the mass storage units connected to the computer. By default, the current user's application directory is used for the test. This suite contains: Disk Sequential Read, Disk Sequential Write and Disk Random Seek RW.

Higher scores are better

#	Test device	Disk Mark
APC910 with INTEL QM77 Chipset		
38	i7-3615QE 4C 2.3/1.6GHz 6MB 45W 2x4096MB DDR3-SODIMM 1600MHz	3152,9
40	i7-3612QE 4C 2.1/1.6GHz 6MB 35W, 2x4096MB DDR3-SODIMM 1600MHz	3088,8
42	i7-3555LE 2C 2.5/1.6GHz 4MB 25W, 4096MB DDR3-SODIMM 1600MHz	3041,4
44	i7-3555LE 2C 2.5/1.6GHz 4MB 25W, 2x4096MB DDR3-SODIMM 1600MHz	3029,3
46	i7-3517UE 2C 1.7/1.6GHz 4MB 17W, 2x4096MB DDR3-SODIMM 1600MHz	3093
48	i5-3610ME 2C 2.7/1.6GHz 3MB 35W, 2x4096MB DDR3-SODIMM 1600MHz	2996,3
50	i3-3120ME 2C 2.4/1.6GHz 3MB 35W, 2x4096MB DDR3-SODIMM 1600MHz	3023,6
52	i3-3217UE 2C 1.6/1.6GHz 3MB 17W, 2x4096MB DDR3-SODIMM 1600MHz	3021,7
APC910 with INTEL HM76 Chipset		
54	C-847E 2C 1.1/1.3GHz 2MB 17W 2x4096MB DDR3 1333MHz	3091,9
56	C-827E 1C 1.4/1.3GHz 1.5MB 17W 2x4096MB DDR3 1333MHz	2856,4
58	C-1047UE 2C 1.4/1.6GHz 2MB 17W 2x4096MB DDR3-SODIMM 1600MHz	3108,3
59	C-1020E 2C 2.2/1.6GHz 2MB 35W 2x4096MB DDR3-SODIMM 1600MHz	3142,4
APC910 with INTEL QM170 Chipset		
66	i5-6440EQ 4C 2.7GHz 6MB 45W, 2 x 4096 MB DDR4-SODIMM 2133MHz	4718,9
67	i7-6820EQ 4C 2.8GHz 8MB 45W, 2 x 8192 MB DDR4-SODIMM 2133MHz	4852,3
APC910 with INTEL HM170 Chipset		
68	i3-6100E 2C 2.7GHz 3MB 35W, 2 x 4096 MB DDR4-SODIMM 2133MHz	4805,4
69	i3-6100E 2C 1.9GHz 3MB 35W, 2 x 8192 MB DDR4-SODIMM 2133MHz	4114,8
70	C-G3900E 2C 2.4GHz 2MB 35W, 2 x 8192 MB DDR4-SODIMM 2133MHz	4476,2
71	C-G3900E 2C 1.7GHz 2MB 35W, 2 x 8192 MB DDR4-SODIMM 2133MHz	4113,5
APC910 with INTEL CM236 Chipset		
72	E3-1515MV5 4C 2,8GHz 8MB 45W, 2 x 8192 MB DDR4-SODIMM 2133MHz	4787,5

Table 68: Results for Passmark Performance Test 7.0, Disk Mark – APC910

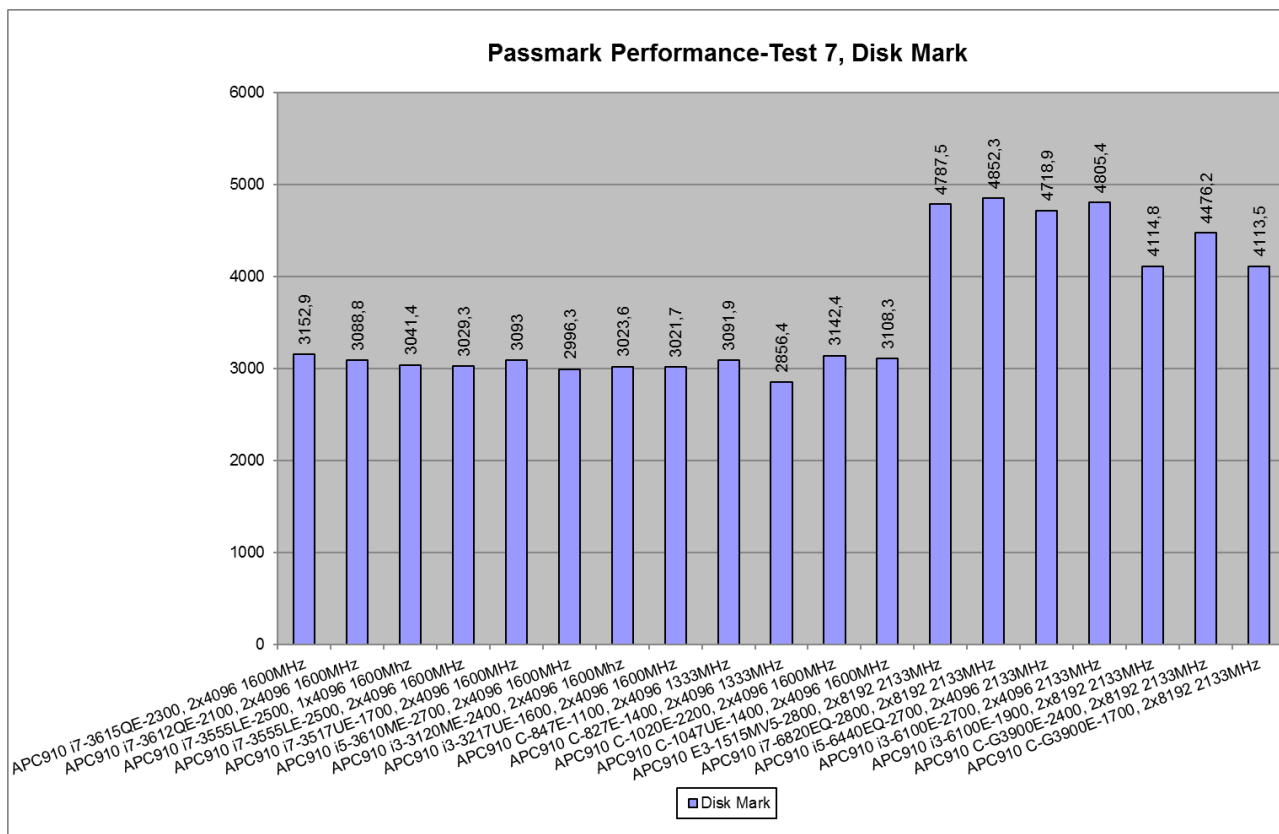

Figure 93: Results Passmark Performance Test 7.0, Disk Mark – APC910

4.13.3 APC2100/PPC2100

4.13.3.1 Passmark Rating

The PassMark rating is weighted average of all the other test results and gives a single overall indication of the computers performance. The bigger the number, the faster the computer. The PassMark rating can only be calculated if the results from all other tests are available. The value is calculated using a series of weighted averages where some components are considered to be more important than others: Disk 21%, CD/DVD 5%, Memory 19%, 3D Graphics 12%, 2D Graphics 14% and CPU 29%.

Higher scores are better

#	Test device	Passmark Rating
APC2100/PPC2100 with INTEL Bay Trail		
60	E3815 1C 1.46GHz 512kB 5W, 1GB-1067MHz	213,6
61	E3825 2C 1.33GHz 1MB 6W, 1GB-1067MHz	285,2
62	E3826 2C 1.46GHz 1MB 7W, 2GB-1067MHz	401,7
63	E3827 2C 1.75GHz 1MB 8W, 4GB-1333MHz	488,1
64	E3845 4C 1.91GHz 2MB 10W, 4GB-1333MHz	666,2
65	E3845 4C 1.91GHz 2MB 10W, 8GB-1333MHz	709,6

Table 69: Results for Passmark Performance Test 7.0, Passmark Rating – APC2100/PPC2100

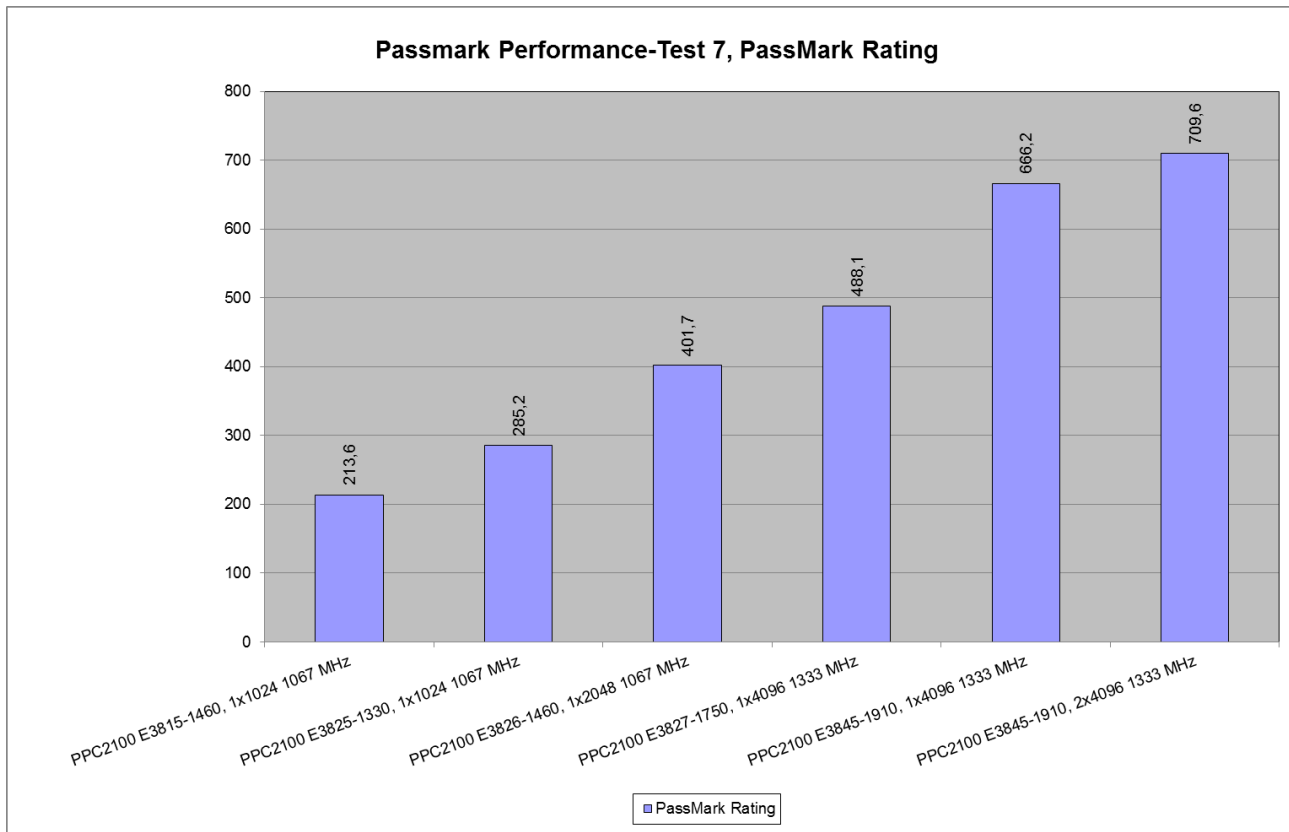

Figure 94: Results for Passmark Performance Test 7.0, Passmark Rating – APC2100/PPC2100

4.13.3.2 CPU Mark

This suite contains multi-process CPU tests. The number of CPU test processes is configurable in Preferences. The following tests make up the suite: Integer (addition, subtraction, multiplication, division), Floating Point (addition, subtraction, multiplication, division), Multimedia Instructions (128-bit SSE operations such as addition, subtraction and multiplication), Find Prime numbers, Compression, Encryption, Physics, Random String Sorting

Higher scores are better

#	Test device	CPU Mark
APC2100/PPC2100 with INTEL Bay Trail		
60	E3815 1C 1.46GHz 512kB 5W, 1GB-1067MHz	260,3
61	E3825 2C 1.33GHz 1MB 6W, 1GB-1067MHz	459,5
62	E3826 2C 1.46GHz 1MB 7W, 2GB-1067MHz	742,7
63	E3827 2C 1.75GHz 1MB 8W, 4GB-1333MHz	880,1
64	E3845 4C 1.91GHz 2MB 10W, 4GB-1333MHz	1848,2
65	E3845 4C 1.91GHz 2MB 10W, 8GB-1333MHz	1810,9

Table 70: Results for Passmark Performance Test 7.0, CPU Mark – APC2100/PPC2100

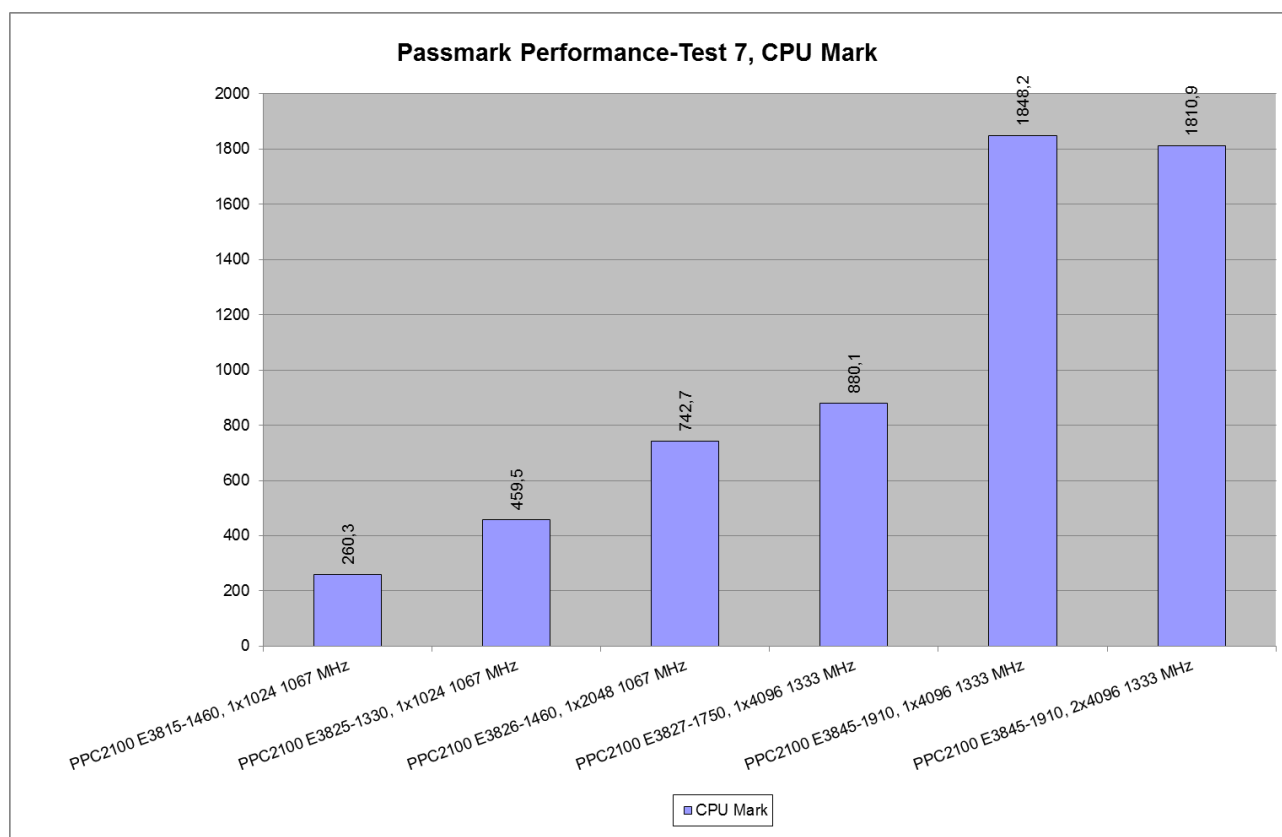

Figure 95: Results for Passmark Performance Test 7.0, CPU Mark – APC2100/PPC2100

4.13.3.3 2D Graphics Mark

This suite contains a number of tests that exercise the standard Windows graphics functions. The results from this suite depend on the speed at which the video card can carry out 2D graphics operations and the color depth currently in use. This suite contains: Solid Vectors, Transparent Vectors, Complex Vectors, Fonts and Text, Windows Interface, Image Filters, Image Rendering.

Higher scores are better

#	Test device	2D Graphics Mark
APC2100/PPC2100 with INTEL Bay Trail		
60	E3815 1C 1.46GHz 512kB 5W, 1GB-1067MHz	108,8
61	E3825 2C 1.33GHz 1MB 6W, 1GB-1067MHz	93,5
62	E3826 2C 1.46GHz 1MB 7W, 2GB-1067MHz	117,5
63	E3827 2C 1.75GHz 1MB 8W, 4GB-1333MHz	131,1
64	E3845 4C 1.91GHz 2MB 10W, 4GB-1333MHz	160,5
65	E3845 4C 1.91GHz 2MB 10W, 8GB-1333MHz	161,3

Table 71: Results for Passmark Performance Test 7.0, 2D Graphics Mark – APC2100/PPC2100

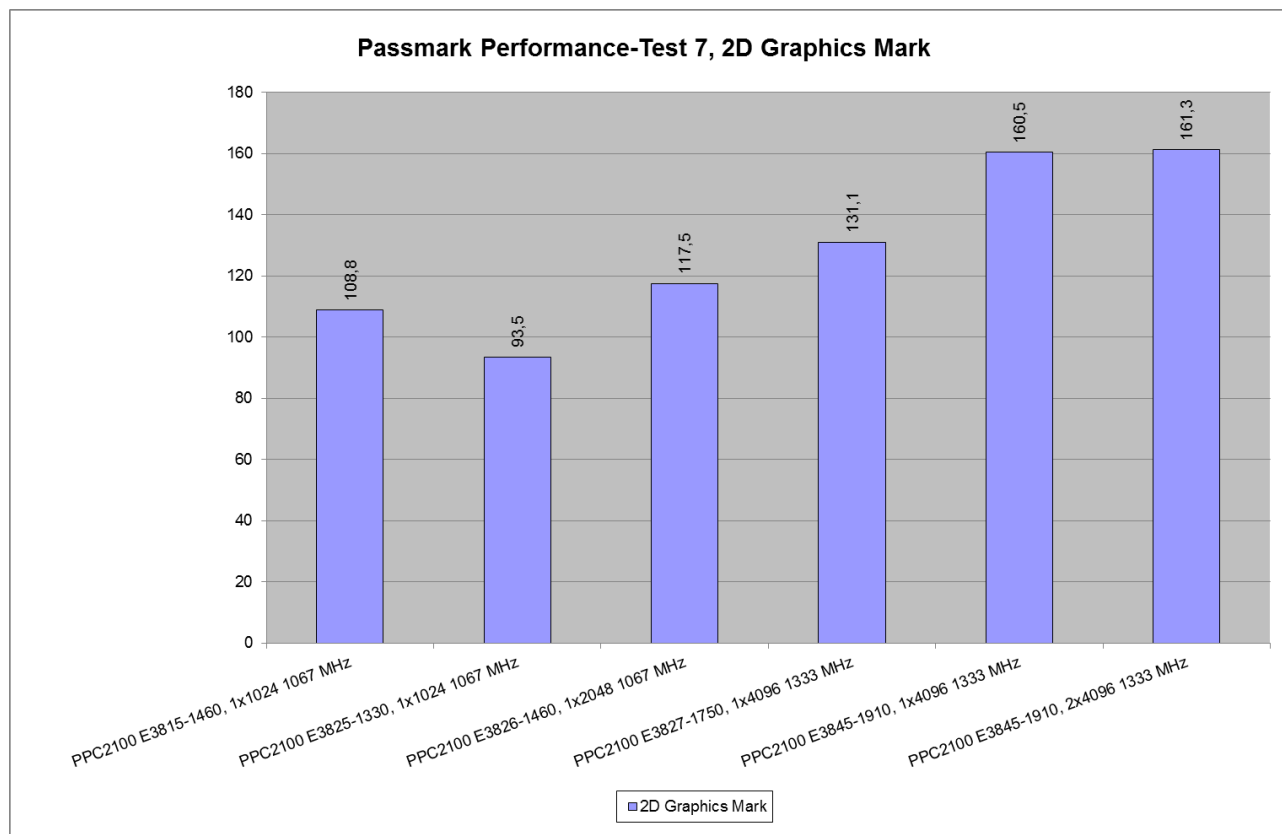

Figure 96: Results for Passmark Performance Test 7.0, 2D Graphics Mark – APC2100/PPC2100

4.13.3.4 3D Graphics Mark

This test suite attempts to measure the performance of the 3D graphics hardware installed in the machine. This test suite makes full use of version 9 of the Microsoft DirectX 3D library. Without DirectX 9.0 or above it will not be possible to run these tests. Three standard tests have been defined: Simple, Medium, and Complex.

Higher scores are better

#	Test device	3D Graphics Mark
APC2100/PPC2100 with INTEL Bay Trail		
60	E3815 1C 1.46GHz 512kB 5W, 1GB-1067MHz	94,8
61	E3825 2C 1.33GHz 1MB 6W, 1GB-1067MHz	113,8
62	E3826 2C 1.46GHz 1MB 7W, 2GB-1067MHz	127,4
63	E3827 2C 1.75GHz 1MB 8W, 4GB-1333MHz	147,5
64	E3845 4C 1.91GHz 2MB 10W, 4GB-1333MHz	149,4
65	E3845 4C 1.91GHz 2MB 10W, 8GB-1333MHz	167,8

Table 72: Results for Passmark Performance Test 7.0, 3D Graphics Mark – APC2100/PPC2100

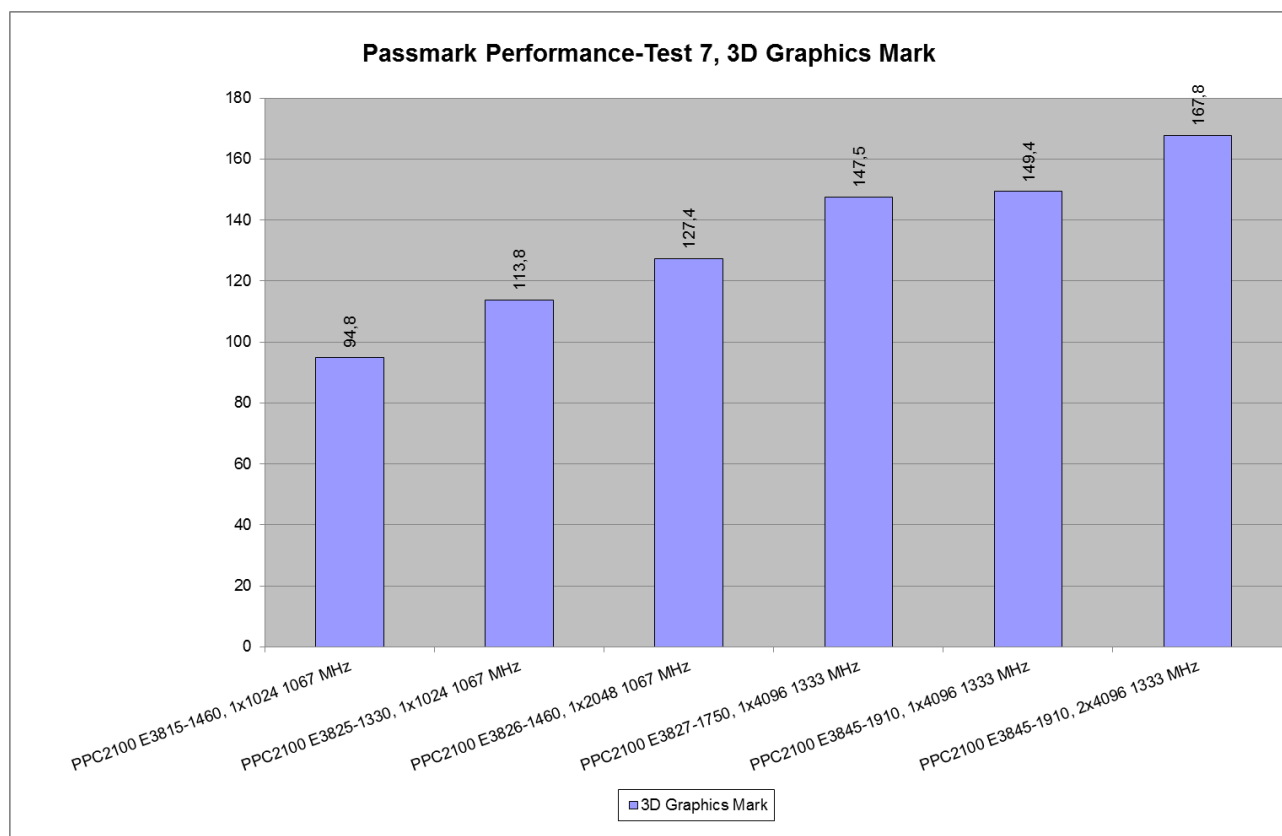

Figure 97: Results for Passmark Performance Test 7.0, 3D Graphics Mark – APC2100/PPC2100

4.13.3.5 Memory Mark

This test suite contains a number of tests that exercise the memory sub-system of the computer. All tests use a combination of 32-bit and 64-bit data when reading or writing from or to RAM. It contains: Memory-Allocate small block, Memory-Cached, Memory-UnCached, Memory-Write and Memory-Large RAM.

Higher scores are better

#	Test device	Memory Mark
APC2100/PPC2100 with INTEL Bay Trail		
60	E3815 1C 1.46GHz 512kB 5W, 1GB-1067MHz	201,6
61	E3825 2C 1.33GHz 1MB 6W, 1GB-1067MHz	201,4
62	E3826 2C 1.46GHz 1MB 7W, 2GB-1067MHz	295,3
63	E3827 2C 1.75GHz 1MB 8W, 4GB-1333MHz	482,2
64	E3845 4C 1.91GHz 2MB 10W, 4GB-1333MHz	529,4
65	E3845 4C 1.91GHz 2MB 10W, 8GB-1333MHz	811,4

Table 73: Results for Passmark Performance Test 7.0, Memory Mark – APC2100/PPC2100

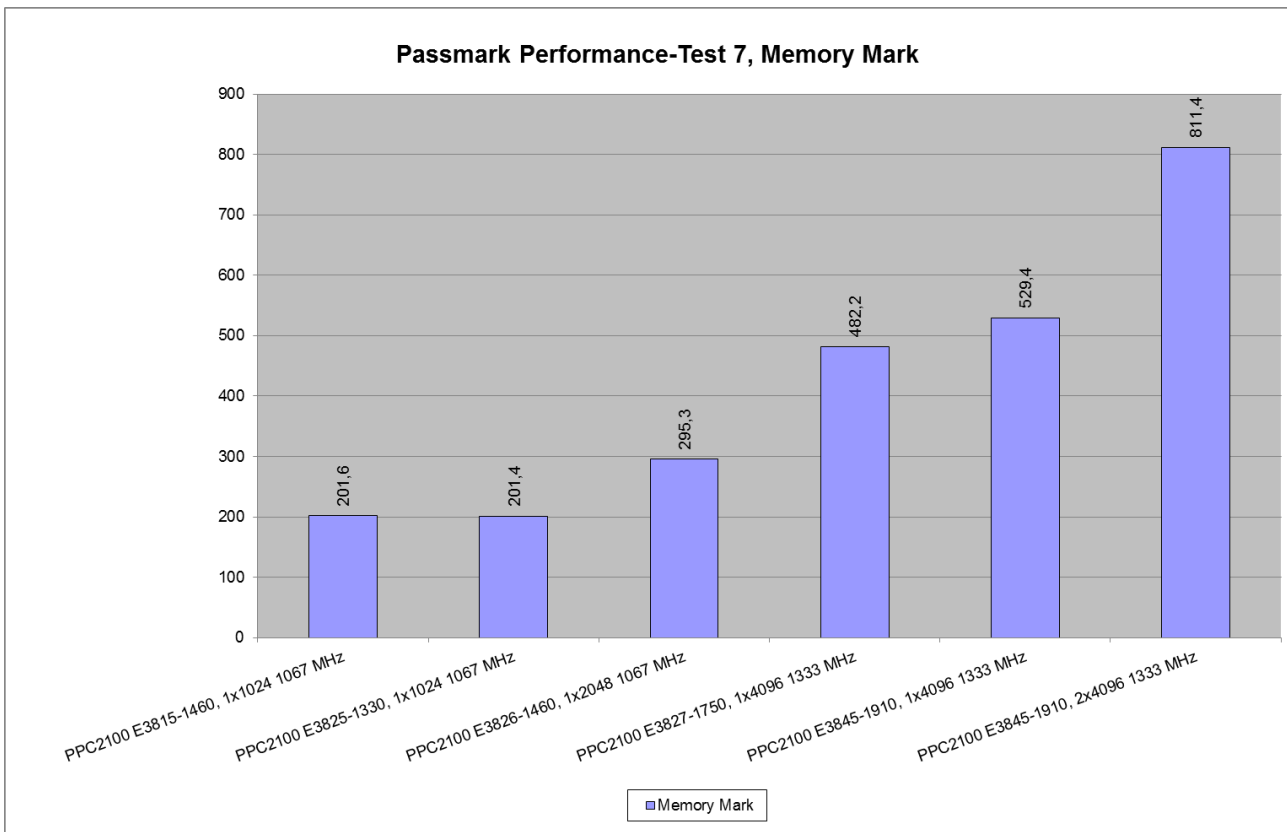

Figure 98: Results for Passmark Performance Test 7.0, Memory Mark – APC2100/PPC2100

4.13.3.6 Disk Mark

This suite contains a number of tests that exercise the mass storage units connected to the computer. By default, the current user's application directory is used for the test. This suite contains: Disk Sequential Read, Disk Sequential Write and Disk Random Seek RW.

Higher scores are better

#	Test device	Disk Mark
APC2100/PPC2100 with INTEL Bay Trail		
60	E3815 1C 1.46GHz 512kB 5W, 1GB-1067MHz	827,7
61	E3825 2C 1.33GHz 1MB 6W, 1GB-1067MHz	919,6
62	E3826 2C 1.46GHz 1MB 7W, 2GB-1067MHz	1105,8
63	E3827 2C 1.75GHz 1MB 8W, 4GB-1333MHz	1101
64	E3845 4C 1.91GHz 2MB 10W, 4GB-1333MHz	1100,7
65	E3845 4C 1.91GHz 2MB 10W, 8GB-1333MHz	1099,1

Table 74: Results for Passmark Performance Test 7.0, Disk Mark – APC2100/PPC2100

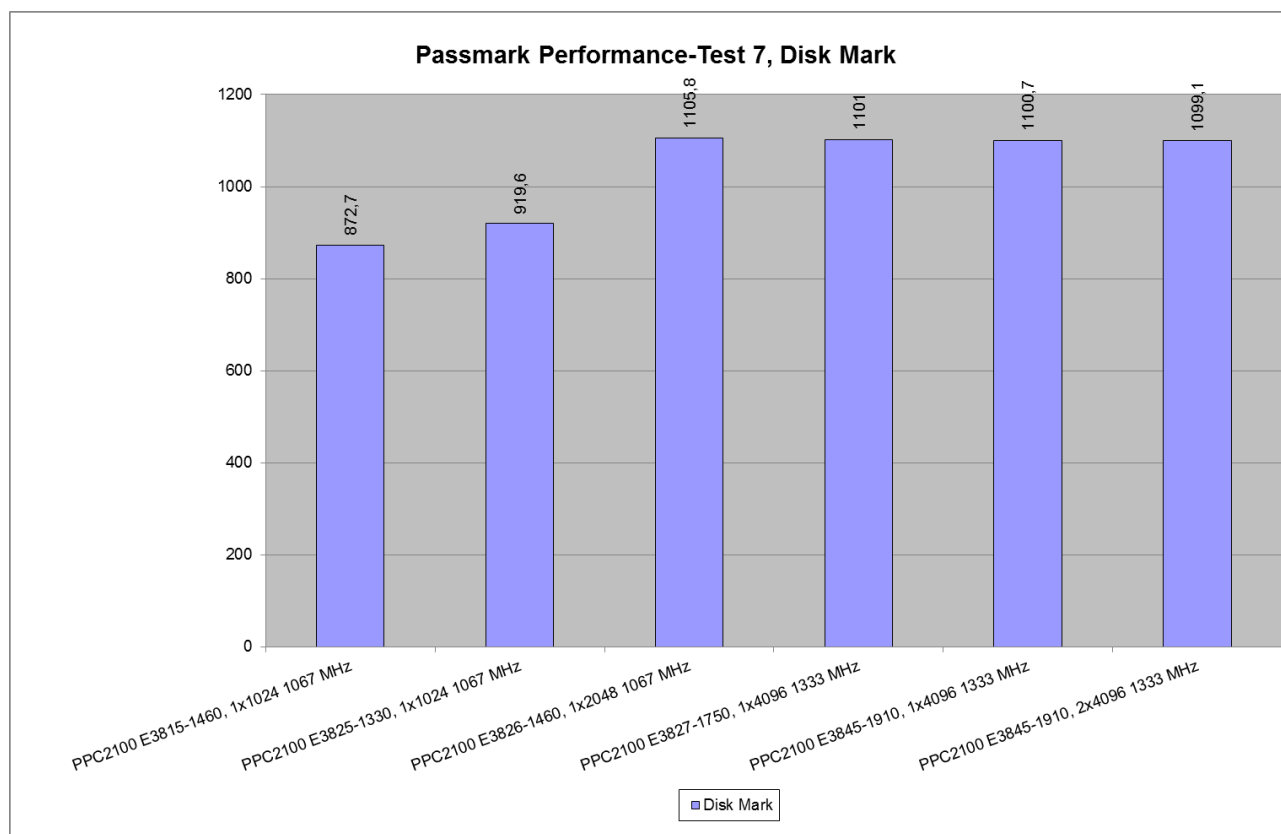

Figure 99: Results Passmark Performance Test 7.0, Disk Mark – APC2100/PPC2100

4.13.4 APC3100/PPC3100

4.13.4.1 Passmark Rating

The PassMark rating is weighted average of all the other test results and gives a single overall indication of the computers performance. The bigger the number, the faster the computer. The PassMark rating can only be calculated if the results from all other tests are available. The value is calculated using a series of weighted averages where some components are considered to be more important than others: Disk 21%, CD/DVD 5%, Memory 19%, 3D Graphics 12%, 2D Graphics 14% and CPU 29%.

Higher scores are better

#	Test device	Passmark Rating
APC3100/PPC3100 with INTEL Kabylake-U		
73	C-3965U 2C 2.2GHz 2MB 15W, 2 x 8192 MB DDR4-SODIMM 2133MHz	1490,7
74	i3-7100U 2C 2.4GHz 3MB 15W, 2 x 8192 MB DDR4-SODIMM 2133MHz	1803,9
75	i5-7300U 2C 2.6GHz 3MB 15W, 2 x 8192 MB DDR4-SODIMM 2133MHz	2360,7
76	i7-7600U 2C 2.8GHz 4MB 15W, 2 x 8192 MB DDR4-SODIMM 2133MHz	2535,6

Table 75: Results for Passmark Performance Test 7.0, Passmark Rating – APC3100/PPC3100

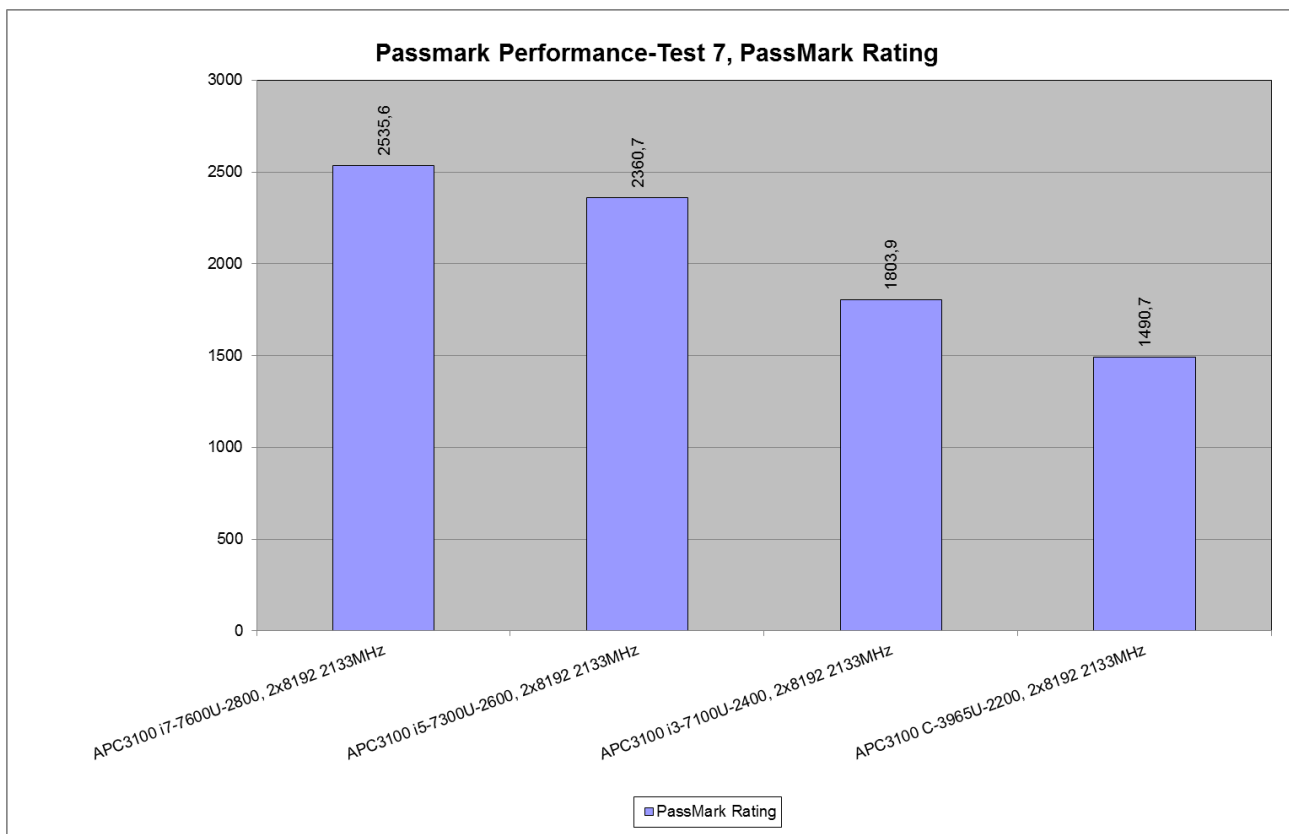

Figure 100: Results for Passmark Performance Test 7.0, Passmark Rating – APC3100/PPC3100

4.13.4.2 CPU Mark

This suite contains multi-process CPU tests. The number of CPU test processes is configurable in Preferences. The following tests make up the suite: Integer (addition, subtraction, multiplication, division), Floating Point (addition, subtraction, multiplication, division), Multimedia Instructions (128-bit SSE operations such as addition, subtraction and multiplication), Find Prime numbers, Compression, Encryption, Physics, Random String Sorting

Higher scores are better

#	Test device	CPU Mark
APC3100/PPC3100 with INTEL Kabylake-U		
73	C-3965U 2C 2.2GHz 2MB 15W, 2 x 8192 MB DDR4-SODIMM 2133MHz	2894,5
74	i3-7100U 2C 2.4GHz 3MB 15W, 2 x 8192 MB DDR4-SODIMM 2133MHz	4159,8
75	i5-7300U 2C 2.6GHz 3MB 15W, 2 x 8192 MB DDR4-SODIMM 2133MHz	5989,3
76	i7-7600U 2C 2.8GHz 4MB 15W, 2 x 8192 MB DDR4-SODIMM 2133MHz	6708,2

Table 76: Results for Passmark Performance Test 7.0, CPU Mark – APC3100/PPC3100

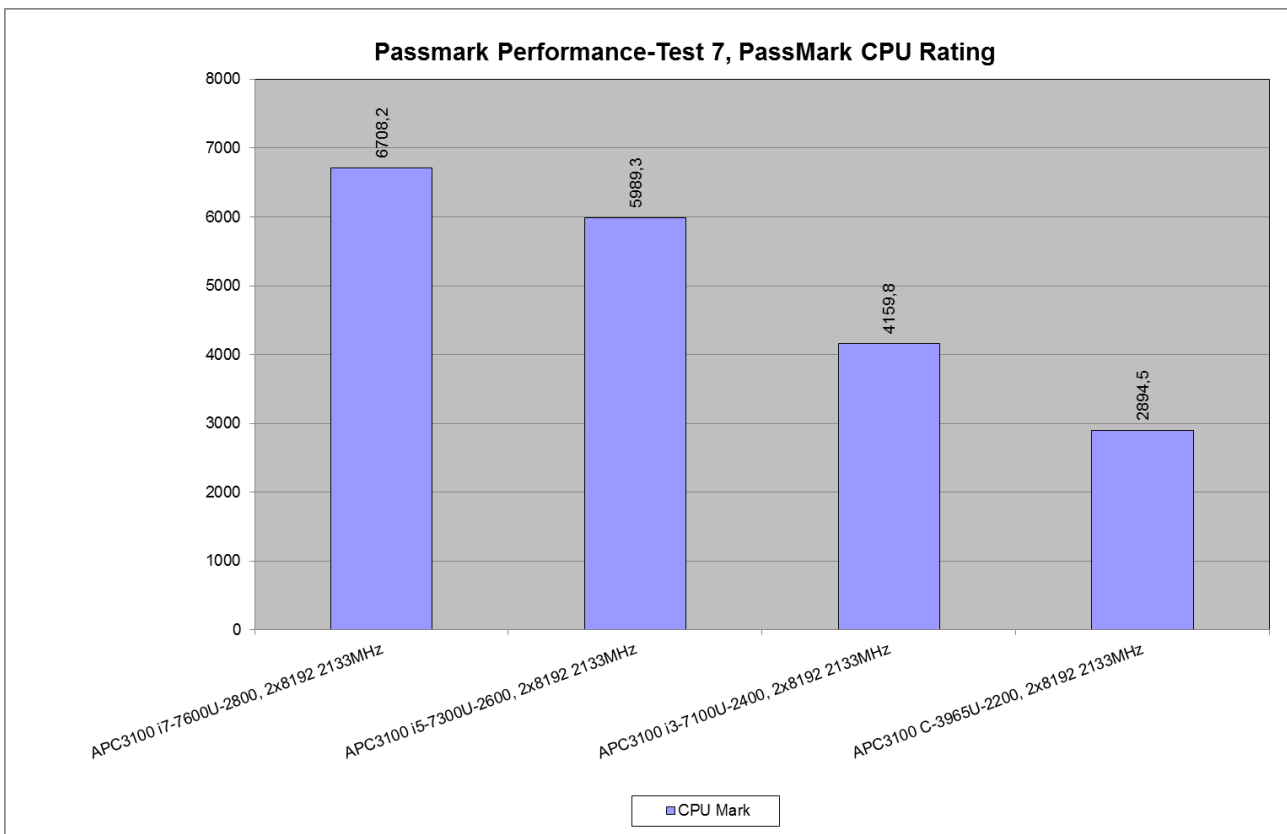

Figure 101: Results for Passmark Performance Test 7.0, CPU Mark – APC3100/PPC3100

4.13.4.3 2D Graphics Mark

This suite contains a number of tests that exercise the standard Windows graphics functions. The results from this suite depend on the speed at which the video card can carry out 2D graphics operations and the color depth currently in use. This suite contains: Solid Vectors, Transparent Vectors, Complex Vectors, Fonts and Text, Windows Interface, Image Filters, Image Rendering.

Higher scores are better

#	Test device	2D Graphics Mark
APC3100/PPC3100 with INTEL Kabylake-U		
73	C-3965U 2C 2.2GHz 2MB 15W, 2 x 8192 MB DDR4-SODIMM 2133MHz	298,7
74	i3-7100U 2C 2.4GHz 3MB 15W, 2 x 8192 MB DDR4-SODIMM 2133MHz	325,1
75	i5-7300U 2C 2.6GHz 3MB 15W, 2 x 8192 MB DDR4-SODIMM 2133MHz	447,6
76	i7-7600U 2C 2.8GHz 4MB 15W, 2 x 8192 MB DDR4-SODIMM 2133MHz	487,1

Table 77: Results for Passmark Performance Test 7.0, 2D Graphics Mark – APC3100/PPC3100

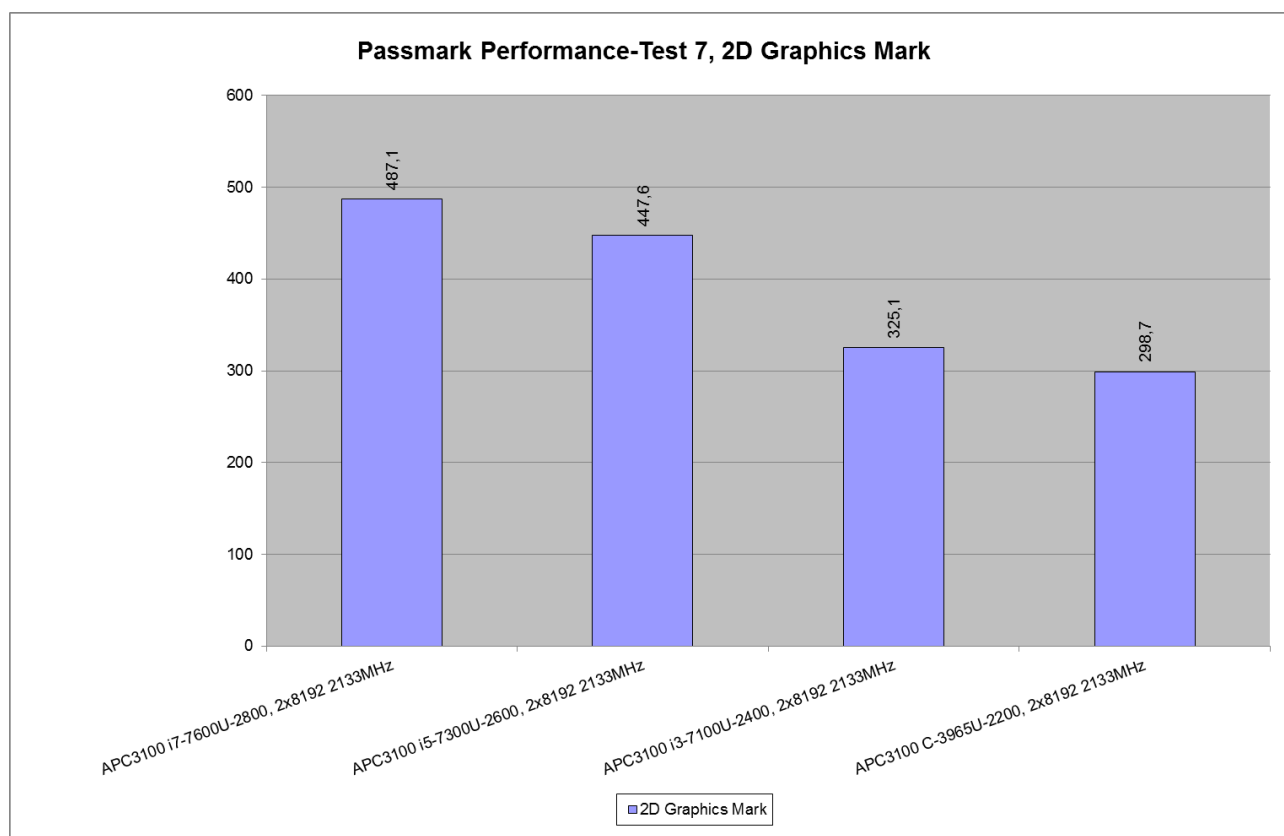

Figure 102: Results for Passmark Performance Test 7.0, 2D Graphics Mark – APC3100/PPC3100

4.13.4.4 3D Graphics Mark

This test suite attempts to measure the performance of the 3D graphics hardware installed in the machine. This test suite makes full use of version 9 of the Microsoft DirectX 3D library. Without DirectX 9.0 or above it will not be possible to run these tests. Three standard tests have been defined: Simple, Medium, and Complex.

Higher scores are better

#	Test device	3D Graphics Mark
APC3100/PPC3100 with INTEL Kabylake-U		
73	C-3965U 2C 2.2GHz 2MB 15W, 2 x 8192 MB DDR4-SODIMM 2133MHz	657,3
74	i3-7100U 2C 2.4GHz 3MB 15W, 2 x 8192 MB DDR4-SODIMM 2133MHz	856,1
75	i5-7300U 2C 2.6GHz 3MB 15W, 2 x 8192 MB DDR4-SODIMM 2133MHz	926,8
76	i7-7600U 2C 2.8GHz 4MB 15W, 2 x 8192 MB DDR4-SODIMM 2133MHz	931,4

Table 78: Results for Passmark Performance Test 7.0, 3D Graphics Mark – APC3100/PPC3100

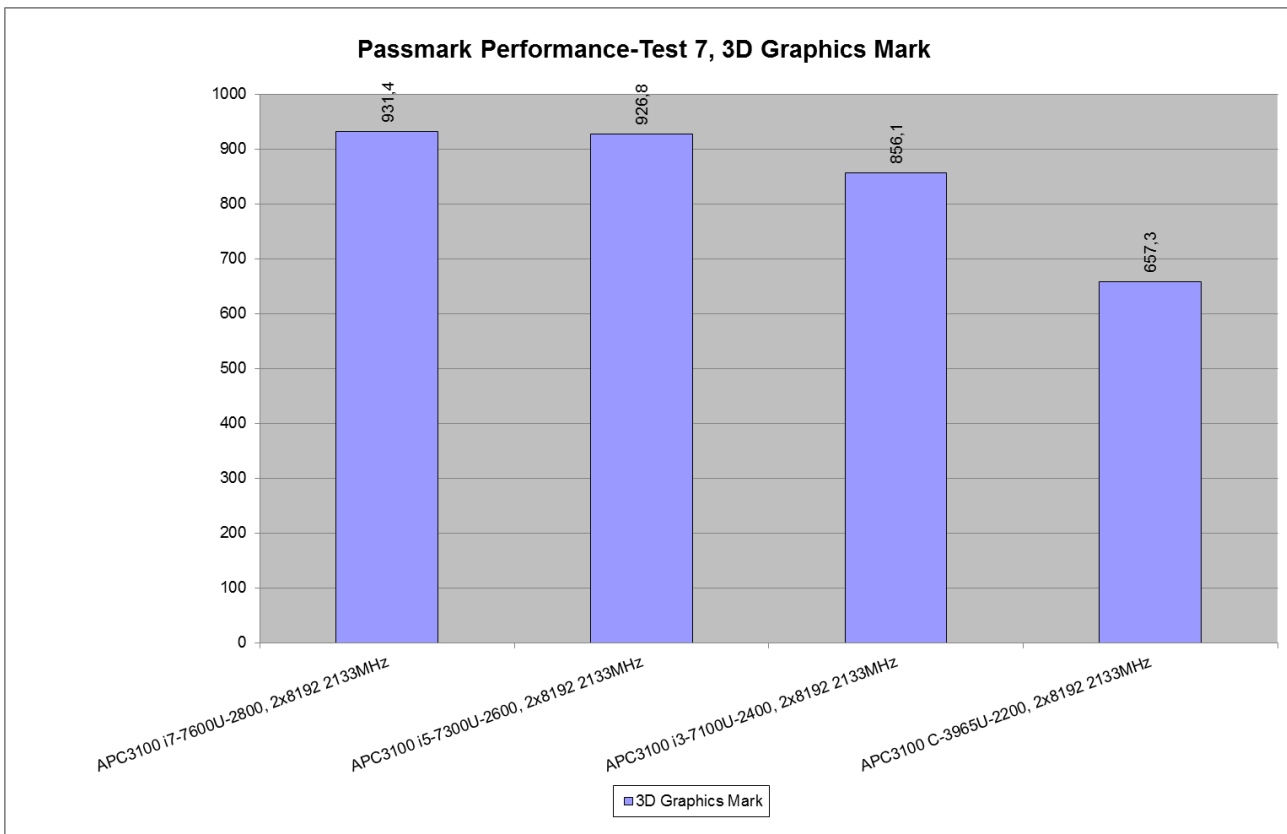

Figure 103: Results for Passmark Performance Test 7.0, 3D Graphics Mark – APC3100/PPC3100

4.13.4.5 Memory Mark

This test suite contains a number of tests that exercise the memory sub-system of the computer. All tests use a combination of 32-bit and 64-bit data when reading or writing from or to RAM. It contains: Memory-Allocate small block, Memory-Cached, Memory-UnCached, Memory-Write and Memory-Large RAM.

Higher scores are better

#	Test device	Memory Mark
APC3100/PPC3100 with INTEL Kabylake-U		
73	C-3965U 2C 2.2GHz 2MB 15W, 2 x 8192 MB DDR4-SODIMM 2133MHz	2490,2
74	i3-7100U 2C 2.4GHz 3MB 15W, 2 x 8192 MB DDR4-SODIMM 2133MHz	2707,4
75	i5-7300U 2C 2.6GHz 3MB 15W, 2 x 8192 MB DDR4-SODIMM 2133MHz	3938,6
76	i7-7600U 2C 2.8GHz 4MB 15W, 2 x 8192 MB DDR4-SODIMM 2133MHz	4465,2

Table 79: Results for Passmark Performance Test 7.0, Memory Mark – APC3100/PPC3100

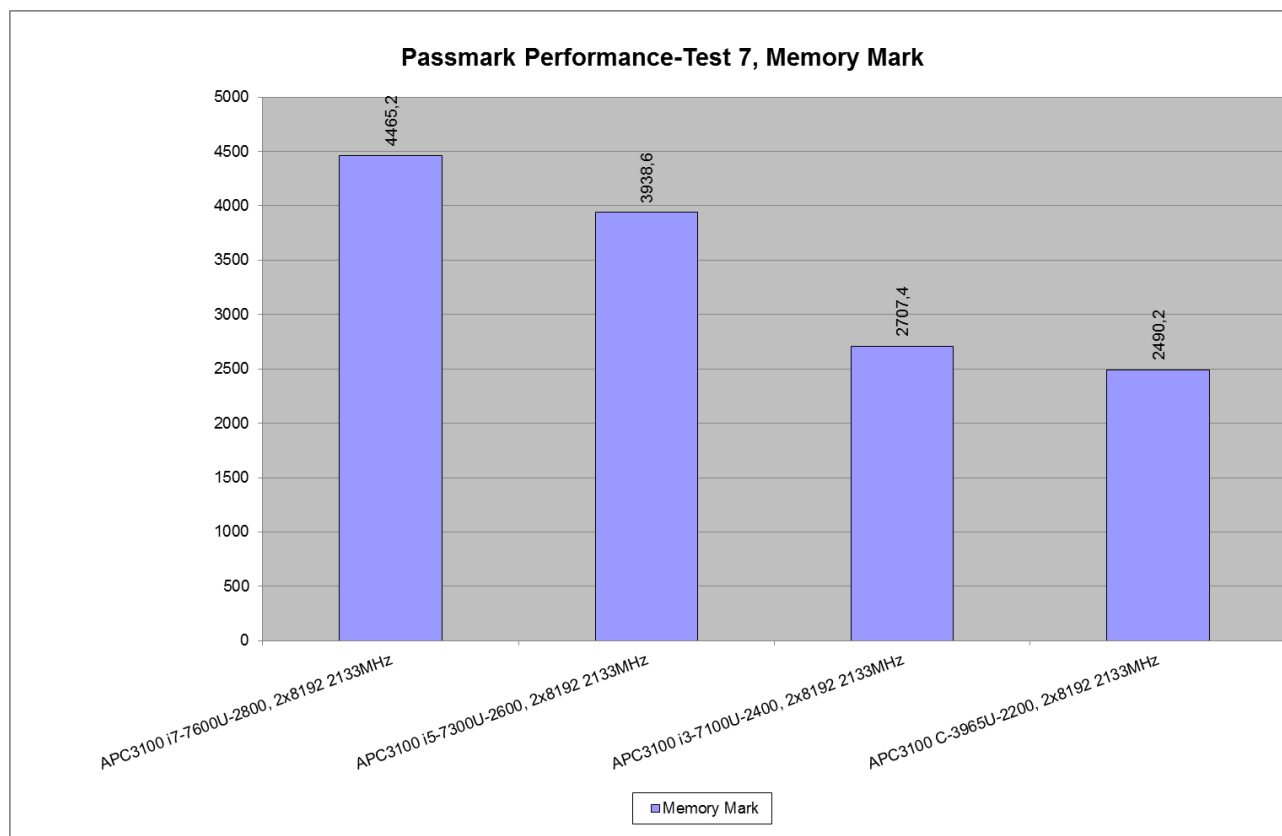

Figure 104: Results for Passmark Performance Test 7.0, Memory Mark – APC3100/PPC3100

4.13.4.6 Disk Mark

This suite contains a number of tests that exercise the mass storage units connected to the computer. By default, the current user's application directory is used for the test. This suite contains: Disk Sequential Read, Disk Sequential Write and Disk Random Seek RW.

Higher scores are better

#	Test device	Disk Mark
APC3100/PPC3100 with INTEL Kabylake-U		
73	C-3965U 2C 2.2GHz 2MB 15W, 2 x 8192 MB DDR4-SODIMM 2133MHz	1533,9
74	i3-7100U 2C 2.4GHz 3MB 15W, 2 x 8192 MB DDR4-SODIMM 2133MHz	1545,5
75	i5-7300U 2C 2.6GHz 3MB 15W, 2 x 8192 MB DDR4-SODIMM 2133MHz	1560,7
76	i7-7600U 2C 2.8GHz 4MB 15W, 2 x 8192 MB DDR4-SODIMM 2133MHz	1555

Table 80: Results for Passmark Performance Test 7.0, Disk Mark – APC3100/PPC3100

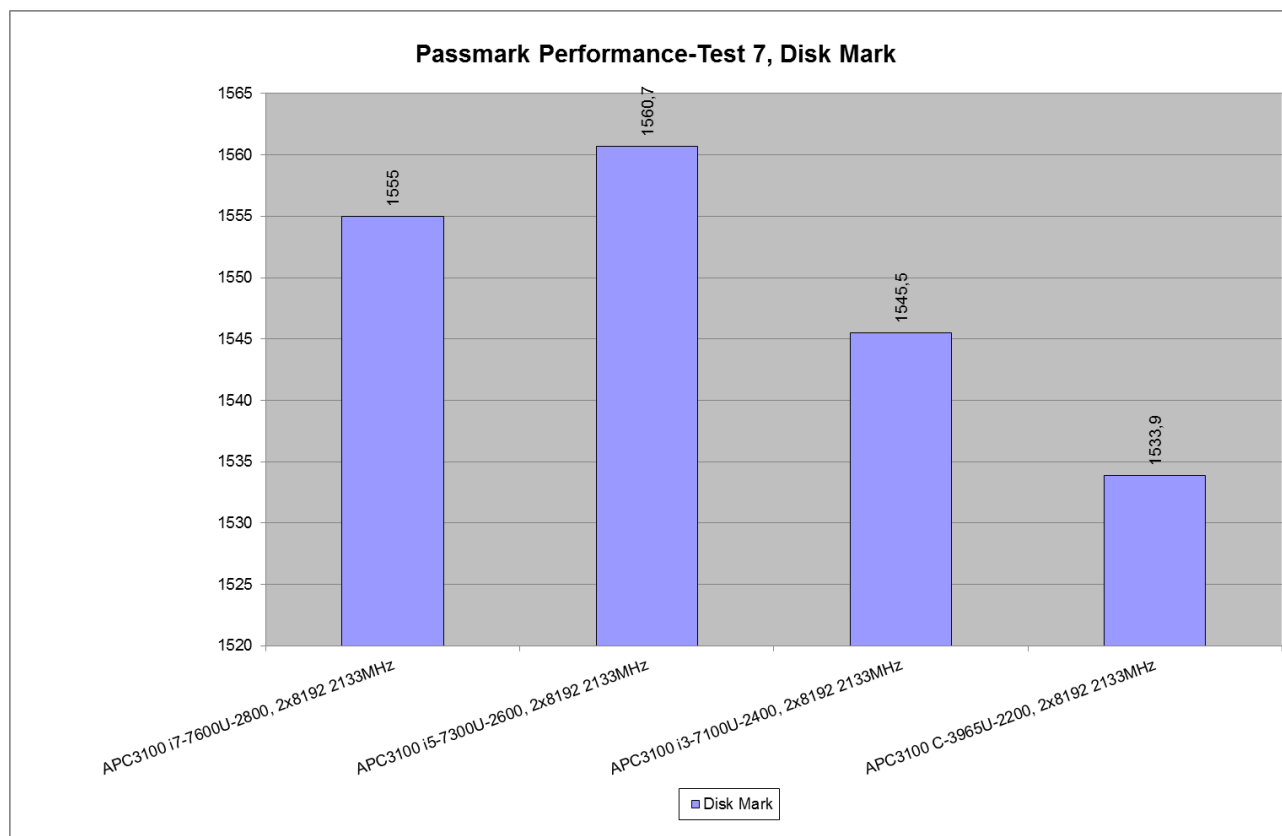

Figure 105: Results Passmark Performance Test 7.0, Disk Mark – APC3100/PPC3100

4.13.5 APC2200/PPC2200

4.13.5.1 Passmark Rating

The PassMark rating is weighted average of all the other test results and gives a single overall indication of the computers performance. The bigger the number, the faster the computer. The PassMark rating can only be calculated if the results from all other tests are available. The value is calculated using a series of weighted averages where some components are considered to be more important than others: Disk 21%, CD/DVD 5%, Memory 19%, 3D Graphics 12%, 2D Graphics 14% and CPU 29%.

Higher scores are better

#	Test device	Passmark Rating
APC2200/PPC2200 with INTEL Apollo Lake		
77	E3930 2C 1.30GHz 2MB 6.5W 2GB, 1 x 2048 MB LPDDR4 2133MHz	621,6
78	E3930 2C 1.30GHz 2MB 6.5W 4GB, 1 x 4096 MB LPDDR4 2133MHz	705,6
79	E3940 4C 1.60GHz 2MB 9.5W 4GB, 1 x 4096 MB LPDDR4 2133MHz	799,7
80	E3940 4C 1.60GHz 2MB 9.5W 8GB, 2 x 4096 MB LPDDR4 2133MHz	889,7

Table 81: Results for Passmark Performance Test 7.0, Passmark Rating – APC2200/PPC2200

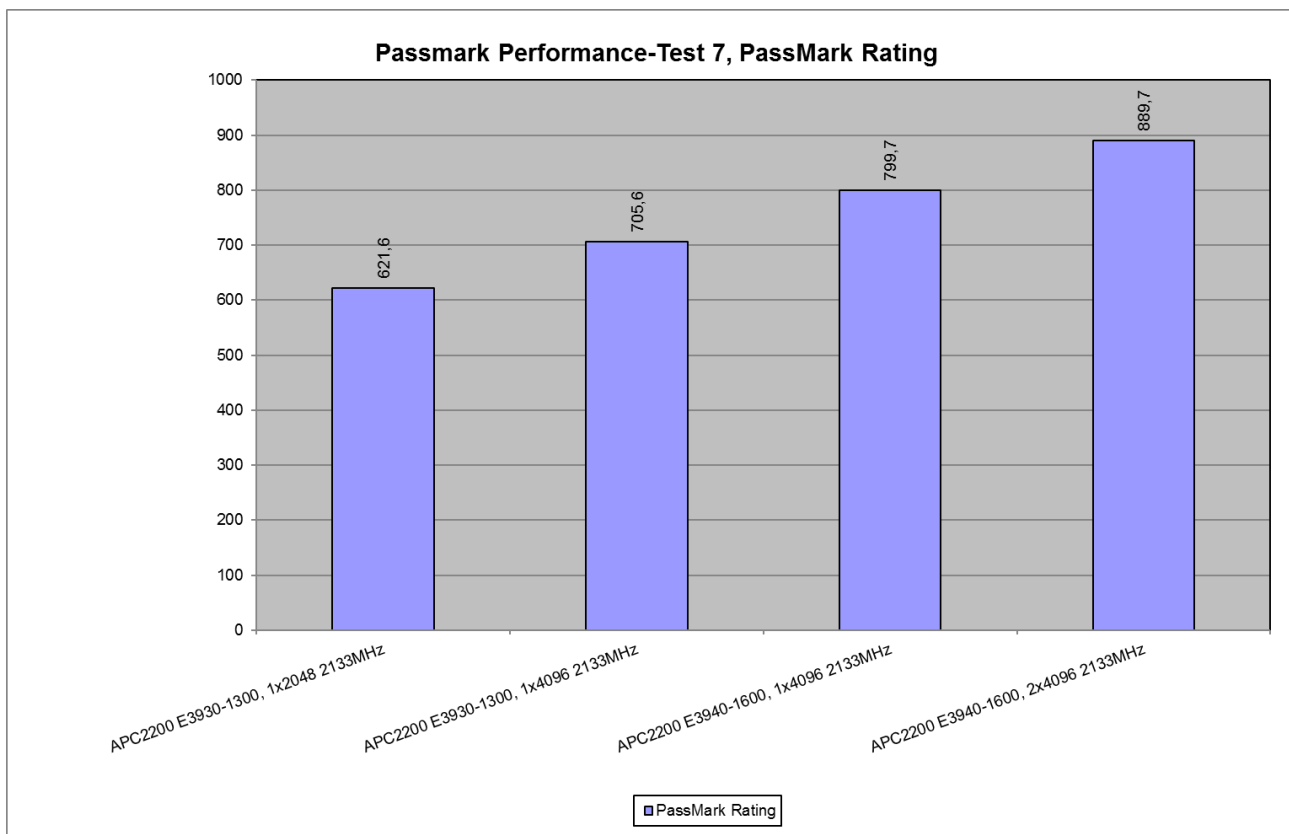

Figure 106: Results for Passmark Performance Test 7.0, Passmark Rating – APC2200/PPC2200

4.13.5.2 CPU Mark

This suite contains multi-process CPU tests. The number of CPU test processes is configurable in Preferences. The following tests make up the suite: Integer (addition, subtraction, multiplication, division), Floating Point (addition, subtraction, multiplication, division), Multimedia Instructions (128-bit SSE operations such as addition, subtraction and multiplication), Find Prime numbers, Compression, Encryption, Physics, Random String Sorting

Higher scores are better

#	Test device	CPU Mark
APC2200/PPC2200 with INTEL Apollo Lake		
77	E3930 2C 1.30GHz 2MB 6.5W 2GB, 1 x 2048 MB LPDDR4 2133MHz	1895,4
78	E3930 2C 1.30GHz 2MB 6.5W 4GB, 1 x 4096 MB LPDDR4 2133MHz	1889,8
79	E3940 4C 1.60GHz 2MB 9.5W 4GB, 1 x 4096 MB LPDDR4 2133MHz	3489,8
80	E3940 4C 1.60GHz 2MB 9.5W 8GB, 2 x 4096 MB LPDDR4 2133MHz	3486,3

Table 82: Results for Passmark Performance Test 7.0, CPU Mark – APC2200/PPC2200

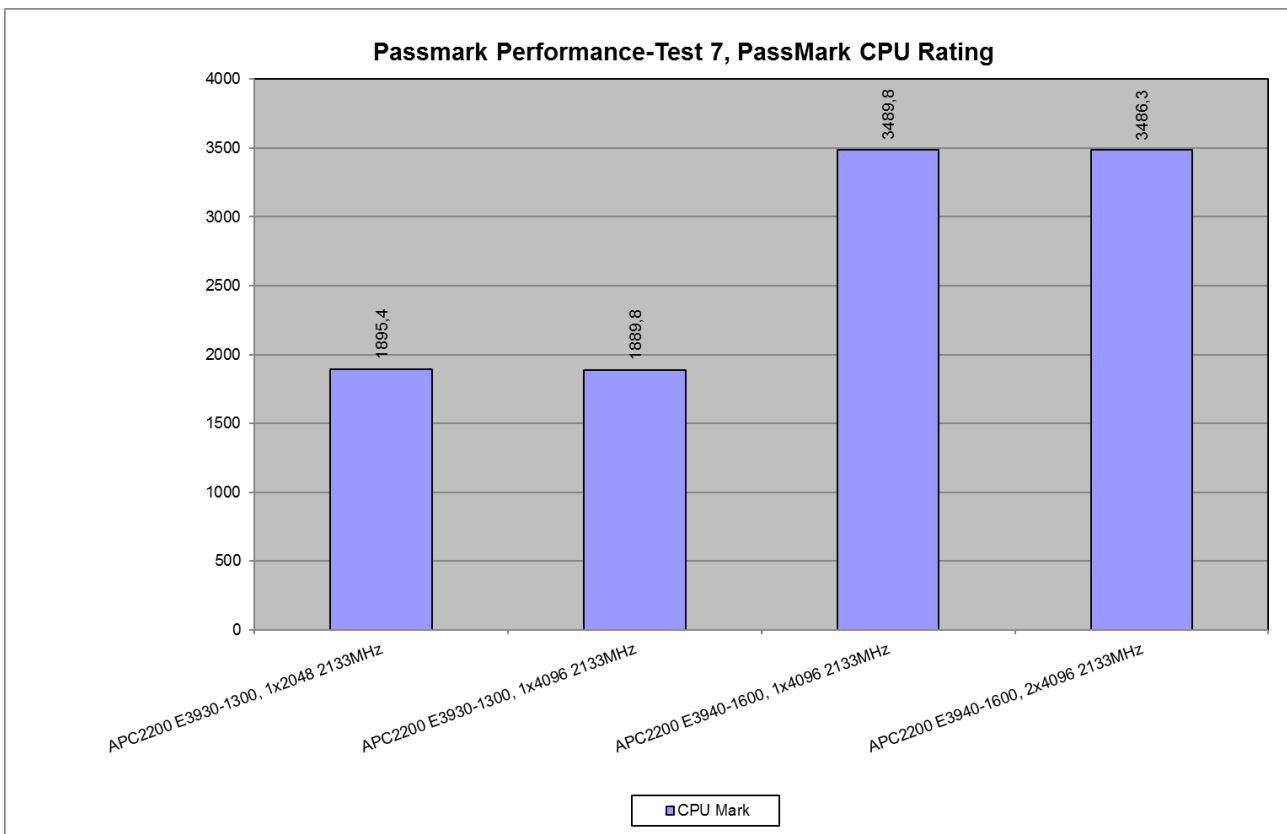

Figure 107: Results for Passmark Performance Test 7.0, CPU Mark – APC2200/PPC2200

4.13.5.3 2D Graphics Mark

This suite contains a number of tests that exercise the standard Windows graphics functions. The results from this suite depend on the speed at which the video card can carry out 2D graphics operations and the color depth currently in use. This suite contains: Solid Vectors, Transparent Vectors, Complex Vectors, Fonts and Text, Windows Interface, Image Filters, Image Rendering.

Higher scores are better

#	Test device	2D Graphics Mark
APC2200/PPC2200 with INTEL Apollo Lake		
77	E3930 2C 1.30GHz 2MB 6.5W 2GB, 1 x 2048 MB LPDDR4 2133MHz	110,9
78	E3930 2C 1.30GHz 2MB 6.5W 4GB, 1 x 4096 MB LPDDR4 2133MHz	135,9
79	E3940 4C 1.60GHz 2MB 9.5W 4GB, 1 x 4096 MB LPDDR4 2133MHz	138,4
80	E3940 4C 1.60GHz 2MB 9.5W 8GB, 2 x 4096 MB LPDDR4 2133MHz	139,4

Table 83: Results for Passmark Performance Test 7.0, 2D Graphics Mark – APC2200/PPC2200

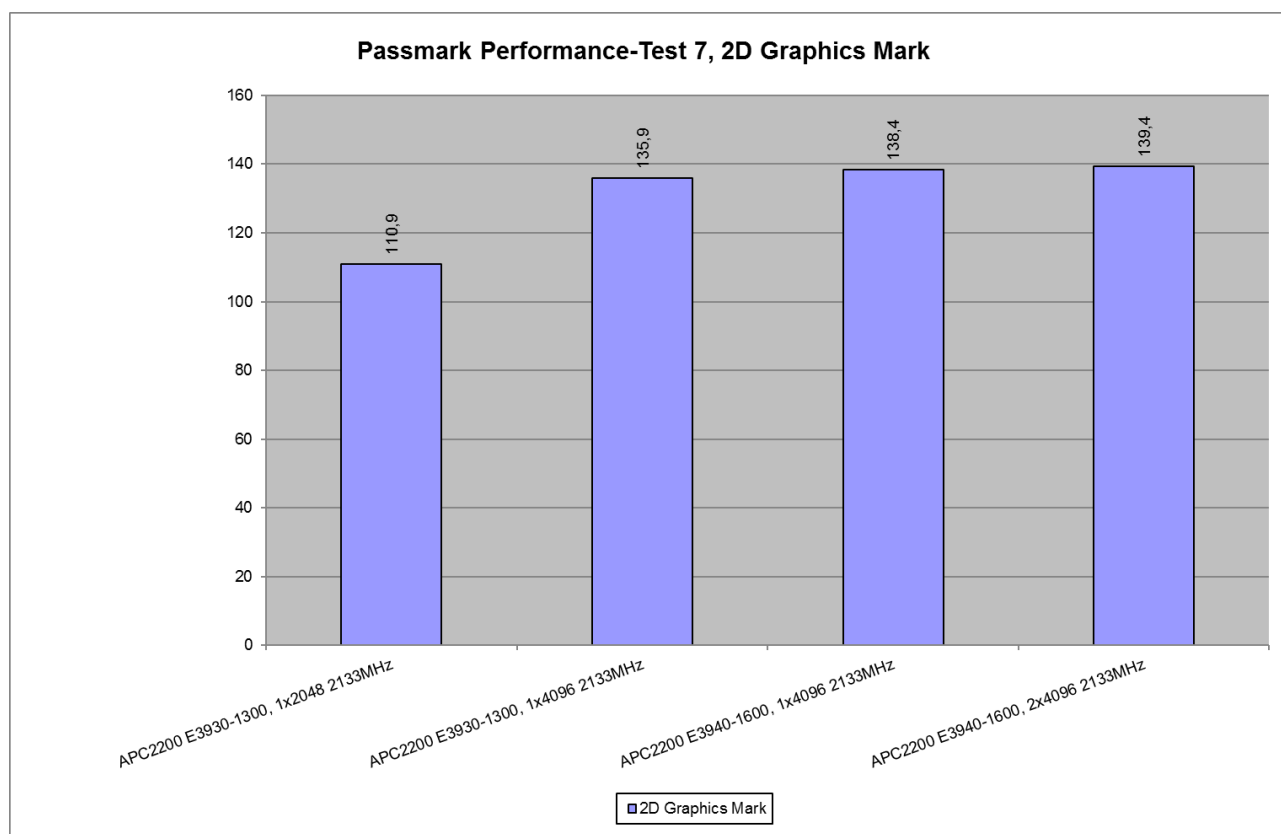

Figure 108: Results for Passmark Performance Test 7.0, 2D Graphics Mark – APC2200/PPC2200

4.13.5.4 3D Graphics Mark

This test suite attempts to measure the performance of the 3D graphics hardware installed in the machine. This test suite makes full use of version 9 of the Microsoft DirectX 3D library. Without DirectX 9.0 or above it will not be possible to run these tests. Three standard tests have been defined: Simple, Medium, and Complex.

Higher scores are better

#	Test device	3D Graphics Mark
APC2200/PPC2200 with INTEL Apollo Lake		
77	E3930 2C 1.30GHz 2MB 6.5W 2GB, 1 x 2048 MB LPDDR4 2133MHz	242
78	E3930 2C 1.30GHz 2MB 6.5W 4GB, 1 x 4096 MB LPDDR4 2133MHz	260,9
79	E3940 4C 1.60GHz 2MB 9.5W 4GB, 1 x 4096 MB LPDDR4 2133MHz	267,7
80	E3940 4C 1.60GHz 2MB 9.5W 8GB, 2 x 4096 MB LPDDR4 2133MHz	330,2

Table 84: Results for Passmark Performance Test 7.0, 3D Graphics Mark – APC2200/PPC2200

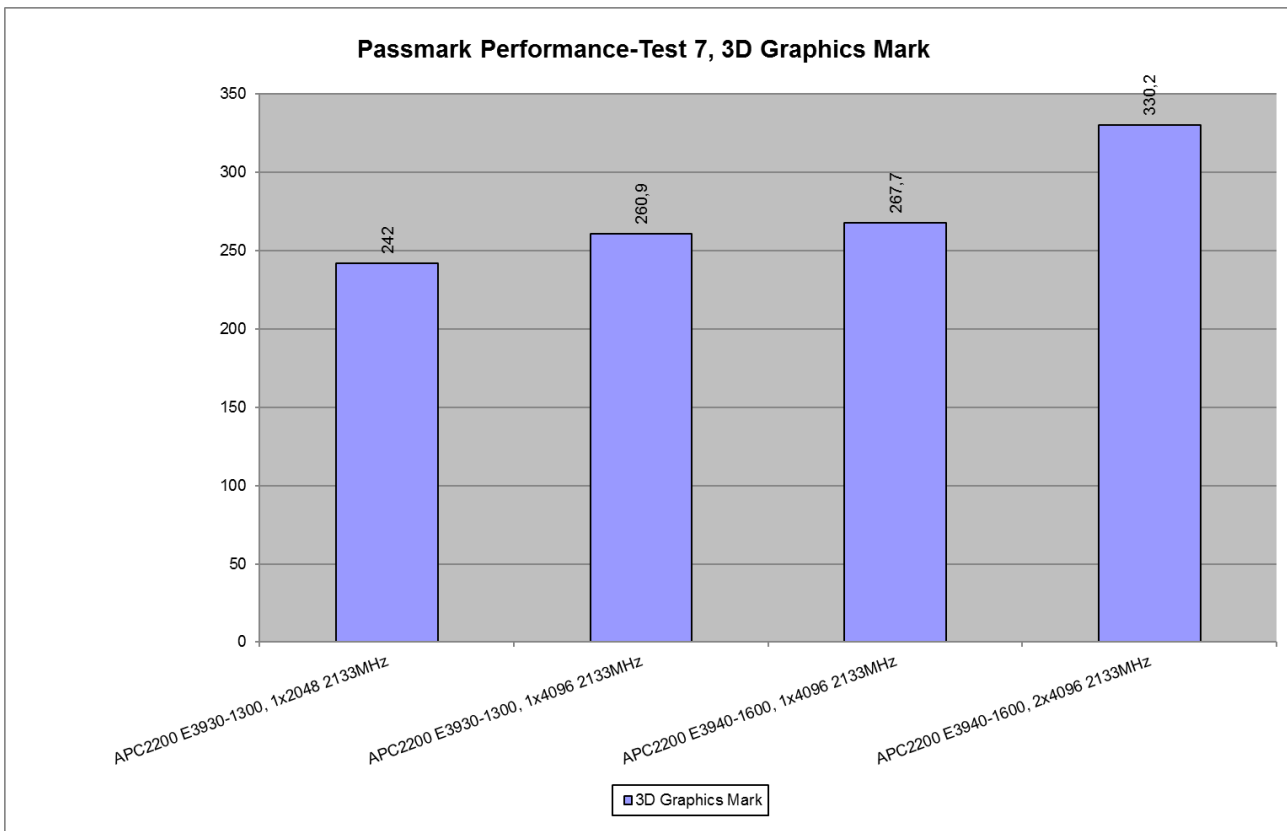

Figure 109: Results for Passmark Performance Test 7.0, 3D Graphics Mark – APC2200/PPC2200

4.13.5.5 Memory Mark

This test suite contains a number of tests that exercise the memory sub-system of the computer. All tests use a combination of 32-bit and 64-bit data when reading or writing from or to RAM. It contains: Memory-Allocate small block, Memory-Cached, Memory-UnCached, Memory-Write and Memory-Large RAM.

Higher scores are better

#	Test device	Memory Mark
APC2200/PPC2200 with INTEL Apollo Lake		
77	E3930 2C 1.30GHz 2MB 6.5W 2GB, 1 x 2048 MB LPDDR4 2133MHz	409,2
78	E3930 2C 1.30GHz 2MB 6.5W 4GB, 1 x 4096 MB LPDDR4 2133MHz	540,3
79	E3940 4C 1.60GHz 2MB 9.5W 4GB, 1 x 4096 MB LPDDR4 2133MHz	541,2
80	E3940 4C 1.60GHz 2MB 9.5W 8GB, 2 x 4096 MB LPDDR4 2133MHz	852,1

Table 85: Results for Passmark Performance Test 7.0, Memory Mark – APC2200/PPC2200

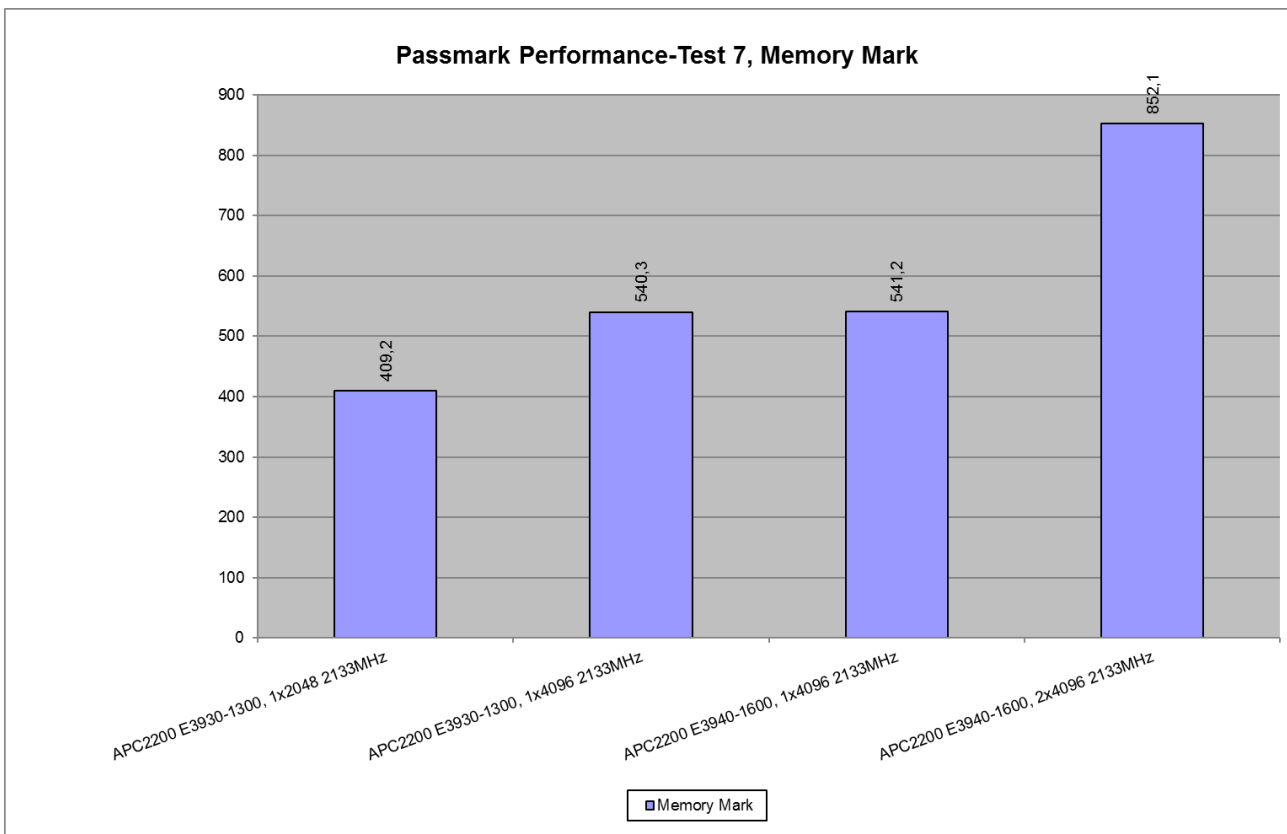

Figure 110: Results for Passmark Performance Test 7.0, Memory Mark – APC2200/PPC2200

4.13.5.6 Disk Mark

This suite contains a number of tests that exercise the mass storage units connected to the computer. By default, the current user's application directory is used for the test. This suite contains: Disk Sequential Read, Disk Sequential Write and Disk Random Seek RW.

Higher scores are better

#	Test device	Disk Mark
APC2200/PPC2200 with INTEL Apollo Lake		
77	E3930 2C 1.30GHz 2MB 6.5W 2GB, 1 x 2048 MB LPDDR4 2133MHz	909,8
78	E3930 2C 1.30GHz 2MB 6.5W 4GB, 1 x 4096 MB LPDDR4 2133MHz	899,3
79	E3940 4C 1.60GHz 2MB 9.5W 4GB, 1 x 4096 MB LPDDR4 2133MHz	879,8
80	E3940 4C 1.60GHz 2MB 9.5W 8GB, 2 x 4096 MB LPDDR4 2133MHz	852,9

Table 86: Results for Passmark Performance Test 7.0, Disk Mark – APC2200/PPC2200

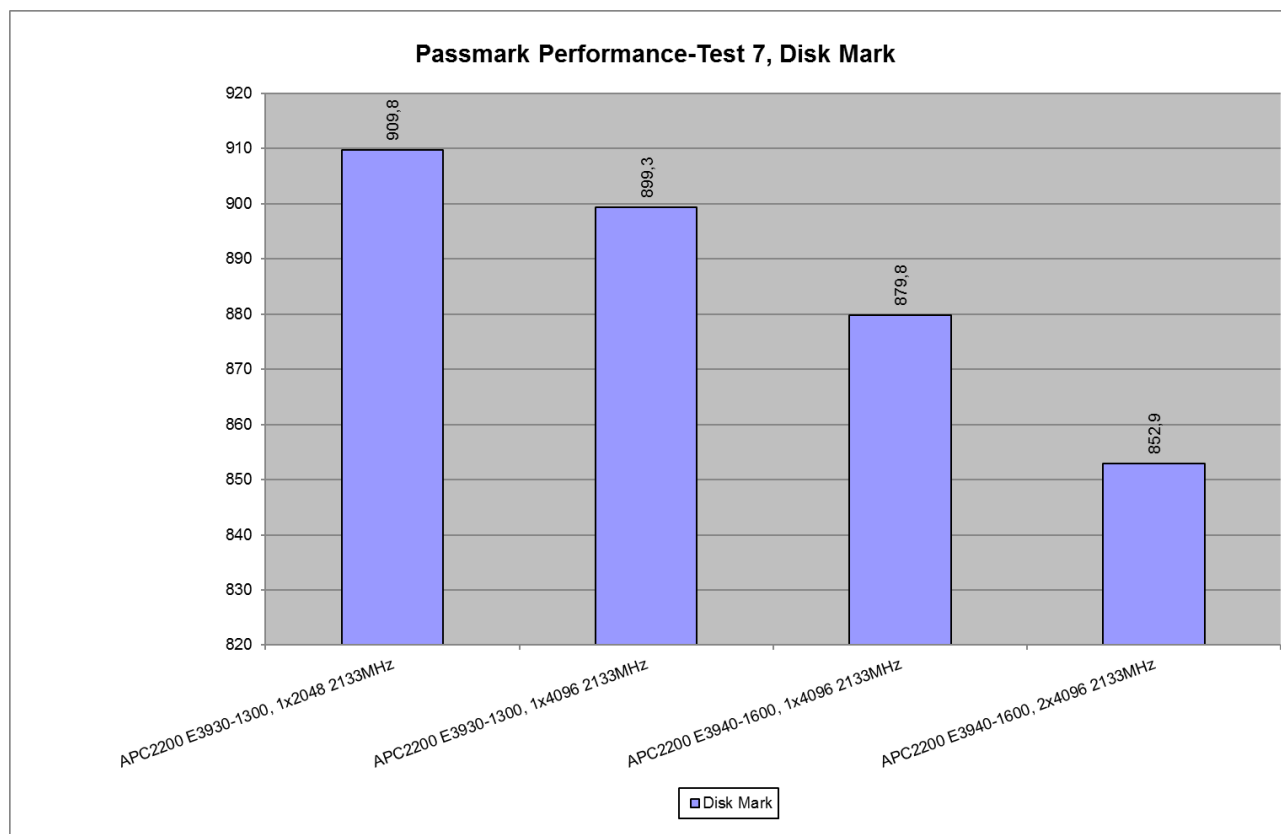

Figure 111: Results Passmark Performance Test 7.0, Disk Mark – APC2200/PPC2200

4.13.6 Comparison PP500, APC810/PPC800, APC910/PPC900, APC2100/PPC2100, APC3100/PPC3100 and APC2200/PPC2200

The PassMark rating is weighted average of all the other test results and gives a single overall indication of the computers performance. The bigger the number, the faster the computer. The PassMark rating can only be calculated if the results from all other tests are available. The value is calculated using a series of weighted averages where some components are considered to be more important than others: Disk 21%, CD/DVD 5%, Memory 19%, 3D Graphics 12%, 2D Graphics 14% and CPU 29%.

Higher scores are better

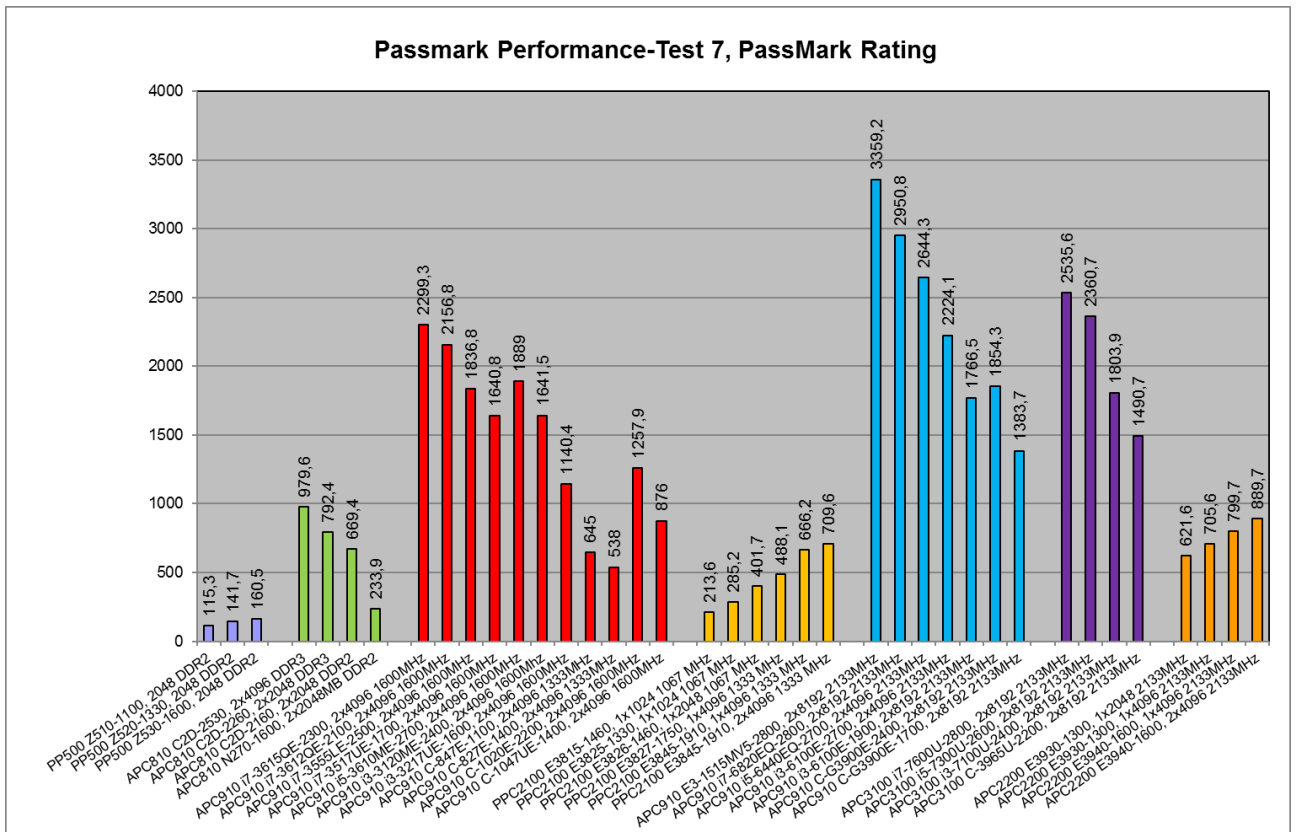

Figure 112: Comparison for Passmark Performance Test 7.0, PassMark Rating

#	Test device	Passmark Rating
PP500 with INTEL US15W Chipset		
34	Atom Z520 1,33GHz, 2048MB DDR2-SDRAM	141,7
35	Atom Z530 1,6GHz, 2048MB DDR2-SDRAM	160,5
36	Atom Z510 1,1GHz, 2048MB DDR2-SDRAM	115,3
APC810/PPC800 with INTEL 945GME Chipset		
27	Core 2 Duo T7400 2,16GHz, 2x2048MB DDR2-SDRAM (667MHz FSB)	669,4
29	Atom N270 1,6GHz, 2x2048MB DDR2-SDRAM (533MHz FSB)	233,9
APC810/PPC800 with INTEL GM45 Chipset		
30	Core 2 Duo T9400 2,53GHz, 2x4096MB DDR3-SODIMM (1066 MHz FSB)	979,6
32	Core 2 Duo P8400 2,26GHz, 2x2048MB DDR3-SODIMM (1066 MHz FSB)	792,4
APC910/PPC900 with INTEL QM77 Chipset		
38	i7-3615QE 4C 2.3/1.6GHz 6MB 45W 2x4096MB DDR3-SODIMM 1600MHz	2299,3
40	i7-3612QE 4C 2.1/1.6GHz 6MB 35W, 2x4096MB DDR3-SODIMM 1600MHz	2156,8
44	i7-3555LE 2C 2.5/1.6GHz 4MB 25W, 2x4096MB DDR3-SODIMM 1600MHz	1836,8
46	i7-3517UE 2C 1.7/1.6GHz 4MB 17W, 2x4096MB DDR3-SODIMM 1600MHz	1640,8
48	i5-3610ME 2C 2.7/1.6GHz 3MB 35W, 2x4096MB DDR3-SODIMM 1600MHz	1899
50	i3-3120ME 2C 2.4/1.6GHz 3MB 35W, 2x4096MB DDR3-SODIMM 1600MHz	1641,5
52	i3-3217UE 2C 1.6/1.6GHz 3MB 17W, 2x4096MB DDR3-SODIMM 1600MHz	1140,4
APC910/PPC900 with INTEL HM76 Chipset		
54	C-847E 2C 1.1/1.3GHz 2MB 17W 2x4096MB DDR3-SODIMM 1333MHz	645
56	C-827E 1C 1.4/1.3GHz 1.5MB 17W 2x4096MB DDR3 1333MHz	538
58	C-1047UE 2C 1.4/1.6GHz 2MB 17W 2x4096MB DDR3-SODIMM 1600MHz	876
59	C-1020E 2C 2.2/1.6GHz 2MB 35W 2x4096MB DDR3-SODIMM 1600MHz	1257,9
APC2100/PPC2100 with INTEL Bay Trail		
60	E3815 1C 1.46GHz 512kB 5W, 1GB-1067MHz	213,6
61	E3825 2C 1.33GHz 1MB 6W, 1GB-1067MHz	285,2
62	E3826 2C 1.46GHz 1MB 7W, 2GB-1067MHz	401,7
63	E3827 2C 1.75GHz 1MB 8W, 4GB-1333MHz	488,1
64	E3845 4C 1.91GHz 2MB 10W, 4GB-1333MHz	666,2
65	E3845 4C 1.91GHz 2MB 10W, 8GB-1333MHz	709,6
APC910 with INTEL QM170 Chipset		
66	i5-6440EQ 4C 2.7GHz 6MB 45W, 2 x 4096 MB DDR4-SODIMM 2133MHz	2644,3
67	i7-6820EQ 4C 2.8GHz 8MB 45W, 2 x 8192 MB DDR4-SODIMM 2133MHz	2950,8
APC910 with INTEL HM170 Chipset		
68	i3-6100E 2C 2.7GHz 3MB 35W, 2 x 4096 MB DDR4-SODIMM 2133MHz	2224,1
69	i3-6100E 2C 1.9GHz 3MB 35W, 2 x 8192 MB DDR4-SODIMM 2133MHz	1766,5
70	C-G3900E 2C 2.4GHz 2MB 35W, 2 x 8192 MB DDR4-SODIMM 2133MHz	1854,3
71	C-G3900E 2C 1.7GHz 2MB 35W, 2 x 8192 MB DDR4-SODIMM 2133MHz	1383,7
APC910 with INTEL CM236 Chipset		
72	E3-1515MV5 4C 2,8GHz 8MB 45W, 2 x 8192 MB DDR4-SODIMM 2133MHz	3359,2
APC3100/PPC3100 with INTEL KabyLake-U		
73	C-3965U 2C 2.2GHz 2MB 15W, 2 x 8192 MB DDR4-SODIMM 2133MHz	1490,7
74	i3-7100U 2C 2.4GHz 3MB 15W, 2 x 8192 MB DDR4-SODIMM 2133MHz	1803,9
75	i5-7300U 2C 2.6GHz 3MB 15W, 2 x 8192 MB DDR4-SODIMM 2133MHz	2360,7
76	i7-7600U 2C 2.8GHz 4MB 15W, 2 x 8192 MB DDR4-SODIMM 2133MHz	2535,6
APC2200/PPC2200 with INTEL Apollo Lake		

77	E3930 2C 1.30GHz 2MB 6.5W 2GB, 1 x 2048 MB LPDDR4 2133MHz	621,6
78	E3930 2C 1.30GHz 2MB 6.5W 4GB, 1 x 4096 MB LPDDR4 2133MHz	705,6
79	E3940 4C 1.60GHz 2MB 9.5W 4GB, 1 x 4096 MB LPDDR4 2133MHz	799,7
80	E3940 4C 1.60GHz 2MB 9.5W 8GB, 2 x 4096 MB LPDDR4 2133MHz	889,7

Table 87: Comparison for Passmark Performance Test 7.0, Passmark Rating (higher scores are better)

5 Figure Index

Figure 1 - Results for Sisoft Sandra 2002 Prof CPU arithmetic	13
Figure 2 – Results for Sisoft Sandra 2002 Prof CPU multimedia	15
Figure 3 – Results for Sisoft Sandra 2002 Prof memory bandwidth	17
Figure 4 – Results for Sisoft Sandra 2005 SR1 CPU arithmetic	19
Figure 5 – Results for Sisoft Sandra 2005 SR1 CPU multimedia	21
Figure 6 – Results for Sisoft Sandra 2005 SR1 Memory bandwidth	23
Figure 7 – Results for PCMark2002	25
Figure 8 – Results for PCMark04	27
Figure 9 – Results for WinBench99 CPUMark99	29
Figure 10 – Results for WinBench99 FPUWinMark	31
Figure 11 – Results for WinBench99 Direct Draw	33
Figure 12 - Results for WinBench99 Disc Inspection Test	34
Figure 13 – Results for WinBench99 High End Disk WinMark99	36
Figure 14 – Results for WinBench99 Business Disk WinMark99	38
Figure 15 – Results for HDTACH read speed	39
Figure 16 – Results for HDTACH access time measurement	40
Figure 17 – Results for 3D Mark 2000	42
Figure 18 – Results for 3D Mark 2001SE	44
Figure 19 – B&R Automation Runtime AR010 Version E2.82	46
Figure 20 – B&R Automation Runtime AR106 Version B2.83	48
Figure 21 - Results for Sisoft Sandra Pro Business 2007 CPU Arithmetic	50
Figure 22 - Results for Sisoft Sandra Pro Business 2007, CPU MultiMedia	52
Figure 23 - Results for Sisoft Sandra Pro Business 2007, CPU Memory Bandwidth	54
Figure 24 - Results for Sisoft Sandra Pro Business 2007, cache and memory bandwidth	56
Figure 25 – Results for Sisoft Sandra Pro Business 2007, cache and memory bandwidth	56
Figure 26 – Results for Sisoft Sandra Pro Business 2007, physical devices / removeable devices	58
Figure 27: Results for SiSoft Sandra 2011, CPU Arithmetic, DDR3 1067MHz – APC910/PPC900	60
Figure 28: Results for SiSoft Sandra 2011, CPU Arithmetic, DDR3 1600/1333MHz – APC910/PPC900	61
Figure 29: Results for SiSoft Sandra 2011, Processor Multi-Media (HM77 Chipset), DDR3 1067MHz – APC910/PPC900	63
Figure 30: Results for SiSoft Sandra 2011, Processor Multi-Media (HM77 Chipset), DDR3 1600MHz – APC910/PPC900	64
Figure 31: Results for SiSoft Sandra 2011, Processor Multi-Media (HM76 Chipset), DDR3 1067/1333/1600MHz – APC910/PPC900	64
Figure 32: Results for SiSoft Sandra 2011, Multi-Core Efficiency, DDR3 1067MHz – APC910/PPC900	66
Figure 33: Results for SiSoft Sandra 2011, Multi-Core Efficiency, DDR3 1600/1333MHz – APC910/PPC900	66
Figure 34: Results for SiSoft Sandra 2011, Cryptography, DDR3 1067MHz – APC910/PPC900	68
Figure 35: Results for SiSoft Sandra 2011, Cryptography, DDR3 1600MHz – APC910/PPC900	69
Figure 36: Results for SiSoft Sandra 2011, Cryptography (HM76 Chipset), DDR3 1067/1333/1600MHz – APC910/PPC900	69
Figure 37: Results for SiSoft Sandra 2011, Video Rendering (Direct3D 9c Devices), DDR3 1067MHz – APC910/PPC900	71
Figure 38: Results for SiSoft Sandra 2011, Video Rendering (Direct3D 9c Devices), DDR3 1600/1333MHz – APC910/PPC900	72
Figure 39: Results for SiSoft Sandra 2011, Video Rendering (Direct3D 10 Devices), DDR3 1067MHz – APC910/PPC900	72
Figure 40: Results for SiSoft Sandra 2011, Video Rendering (Direct3D 10 Devices), DDR3 1600/1333MHz – APC910/PPC900	73
Figure 41: Results for SiSoft Sandra 2011, Video Rendering (Direct3D 10.1 Devices), DDR3 1067MHz – APC910/PPC900	75
Figure 42: Results for SiSoft Sandra 2011, Video Rendering (Direct3D 10.1 Devices), DDR3 1600/1333MHz – APC910/PPC900	75

Figure 43: Results for SiSoft Sandra 2011, Video Rendering (Direct3D 11 Devices), DDR3 1067MHz – APC910/PPC900.....	76
Figure 44: Results for SiSoft Sandra 2011, Video Rendering (Direct3D 11 Devices), DDR3 1600MHz – APC910/PPC900.....	76
Figure 45: Results for SiSoft Sandra 2011, Video Memory Bandwidth (Direct3D 10 Devices), DDR3 1067MHz – APC910/PPC900	79
Figure 46: Results for SiSoft Sandra 2011, Video Memory Bandwidth (Direct3D 10 Devices), DDR3 1600/1333MHz – APC910/PPC900	79
Figure 47: Results SiSoft Sandra 2011, Video Memory Bandwidth (Direct3D 10.1 Devices), DDR3 1067MHz – APC910/PPC900	80
Figure 48: Results for SiSoft Sandra 2011, Video Memory Bandwidth (Direct3D 10.1 Devices), DDR3 1600/1333MHz – APC910/PPC900	80
Figure 49: Results for SiSoft Sandra 2011, Video Memory Bandwidth (Direct3D 11 Devices), DDR3 1067MHz – APC910/PPC900	81
Figure 50: Results for SiSoft Sandra 2011, Video Memory Bandwidth (Direct3D 11 Devices), DDR3 1600/1333MHz – APC910/PPC900	81
Figure 51: Results for SiSoft Sandra 2011, Memory Bandwidth (QM77 Chipset), DDR3 1067MHz – APC910/PPC900.....	83
Figure 52: Results for SiSoft Sandra 2011, Memory Bandwidth (QM77 Chipset), DDR3 1600MHz – APC910/PPC900.....	84
Figure 53: Results for SiSoft Sandra 2011, Memory Bandwidth (HM76 Chipset), DDR3 1067/1333/1600MHz – APC910/PPC900	84
Figure 54: Results for SiSoft Sandra 2011, Memory Latency CPU1, DDR3 1067MHz – APC910/PPC900.....	87
Figure 55: Results for SiSoft Sandra 2011, Memory Latency CPU1, DDR3 1600/1333MHz – APC910/PPC900.....	88
Figure 56: Results for SiSoft Sandra 2011, Memory Latency CPU2, DDR3 1067MHz – APC910/PPC900.....	88
Figure 57: Results for SiSoft Sandra 2011, Memory Latency CPU2, DDR3 1600/1333MHz – APC910/PPC900.....	89
Figure 58: Results for SiSoft Sandra 2011, Cache and Memory, DDR3 1067MHz – APC910/PPC900.....	91
Figure 59: Results for SiSoft Sandra 2011, Cache and Memory, DDR3 1600/1333MHz – APC910/PPC900.....	91
Figure 60: Results for SiSoft Sandra 2011, CPU Arithmetic – APC2100/PPC2100.....	92
Figure 61: Results for SiSoft Sandra 2011, Processor Multi-Media – APC2100/PPC2100.....	93
Figure 62: Results for SiSoft Sandra 2011, Multi-Core Efficiency – APC2100/PPC2100.....	94
Figure 63: Results for SiSoft Sandra 2011, Cryptography – APC2100/PPC2100.....	95
Figure 64: Results for SiSoft Sandra 2011, Video Rendering (Direct3D 9c Devices) – APC2100/PPC2100.....	96
Figure 65: Results for SiSoft Sandra 2011, Video Rendering (Direct3D 10 Devices) – APC2100/PPC2100.....	97
Figure 66: Results for SiSoft Sandra 2011, Video Rendering (Direct3D 10.1 Devices) – APC2100/PPC2100.....	98
Figure 67: Results for SiSoft Sandra 2011, Video Rendering (Direct3D 11 Devices) – APC2100/PPC2100.....	98
Figure 68: Results for SiSoft Sandra 2011, Video Memory Bandwidth (Direct3D 10 Devices) – APC2100/PPC2100.....	99
Figure 69: Results for SiSoft Sandra 2011, Video Memory Bandwidth (Direct3D 10.1 Devices) – APC2100/PPC2100.....	100
Figure 70: Results for SiSoft Sandra 2011, Video Memory Bandwidth (Direct3D 11 Devices) – APC2100/PPC2100.....	101
Figure 71: Results for SiSoft Sandra 2011, Memory Bandwidth – APC2100/PPC2100.....	102
Figure 72: Results for SiSoft Sandra 2011, Memory Latency CPU1 – APC2100/PPC2100	103
Figure 73: Results for SiSoft Sandra 2011, Memory Latency CPU2 – APC2100/PPC2100	104
Figure 74: Results for SiSoft Sandra 2011, Cache and Memory – APC2100/PPC2100	105
Figure 75: Comparison for SiSoft Sandra 2011, CPU Arithmetic.....	107

Figure 76: Results for Passmark Performance Test 7.0, Passmark Rating, DDR3 1067MHz – APC910/PPC900.....	109
Figure 77: Results for Passmark Performance Test 7.0, Passmark Rating, DDR3 1600/1333MHz – APC910/PPC900.....	109
Figure 78: Results for Passmark Performance Test 7.0, CPU Mark, DDR3 1067MHz – APC910/PPC900.....	111
Figure 79: Results for Passmark Performance Test 7.0, CPU Mark, DDR3 1600/1333MHz – APC910/PPC900.....	111
Figure 80: Results for Passmark Performance Test 7.0, 2D Graphics Mark, DDR3 1067MHz – APC910/PPC900.....	113
Figure 81: Results for Passmark Performance Test 7.0, 2D Graphics Mark, DDR3 1600/1333MHz – APC910/PPC900.....	113
Figure 82: Results for Passmark Performance Test 7.0, 3D Graphics Mark, DDR3 1067MHz – APC910/PPC900.....	115
Figure 83: Results for Passmark Performance Test 7.0, 3D Graphics Mark, DDR3 1600/1333MHz – APC910/PPC900.....	115
Figure 84: Results for Passmark Performance Test 7.0, Memory Mark, DDR3 1067MHz – APC910/PPC900.....	117
Figure 85: Results for Passmark Performance Test 7.0, Memory Mark, DDR3 1600/1333MHz – APC910/PPC900.....	117
Figure 86: Results Passmark Performance Test 7.0, Disk Mark, DDR3 1067MHz – APC910/PPC900 ..	119
Figure 87: Results Passmark Performance Test 7.0, Disk Mark, DDR3 1600/1333MHz – APC910/PPC900.....	119
Figure 88: Results for Passmark Performance Test 7.0, Passmark Rating – APC910	121
Figure 89: Results for Passmark Performance Test 7.0, CPU Mark – APC910	123
Figure 90: Results for Passmark Performance Test 7.0, 2D Graphics Mark – APC910.....	125
Figure 91: Results for Passmark Performance Test 7.0, 3D Graphics Mark – APC910.....	127
Figure 92: Results for Passmark Performance Test 7.0, Memory Mark – APC910.....	129
Figure 93: Results Passmark Performance Test 7.0, Disk Mark – APC910	131
Figure 94: Results for Passmark Performance Test 7.0, Passmark Rating – APC2100/PPC2100.....	132
Figure 95: Results for Passmark Performance Test 7.0, CPU Mark – APC2100/PPC2100	133
Figure 96: Results for Passmark Performance Test 7.0, 2D Graphics Mark – APC2100/PPC2100	134
Figure 97: Results for Passmark Performance Test 7.0, 3D Graphics Mark – APC2100/PPC2100	135
Figure 98: Results for Passmark Performance Test 7.0, Memory Mark – APC2100/PPC2100	136
Figure 99: Results Passmark Performance Test 7.0, Disk Mark – APC2100/PPC2100	137
Figure 100: Results for Passmark Performance Test 7.0, Passmark Rating – APC3100/PPC3100.....	138
Figure 101: Results for Passmark Performance Test 7.0, CPU Mark – APC3100/PPC3100	139
Figure 102: Results for Passmark Performance Test 7.0, 2D Graphics Mark – APC3100/PPC3100	140
Figure 103: Results for Passmark Performance Test 7.0, 3D Graphics Mark – APC3100/PPC3100	141
Figure 104: Results for Passmark Performance Test 7.0, Memory Mark – APC3100/PPC3100	142
Figure 105: Results Passmark Performance Test 7.0, Disk Mark – APC3100/PPC3100	143
Figure 106: Results for Passmark Performance Test 7.0, Passmark Rating – APC2200/PPC2200.....	144
Figure 107: Results for Passmark Performance Test 7.0, CPU Mark – APC2200/PPC2200	145
Figure 108: Results for Passmark Performance Test 7.0, 2D Graphics Mark – APC2200/PPC2200	146
Figure 109: Results for Passmark Performance Test 7.0, 3D Graphics Mark – APC2200/PPC2200	147
Figure 110: Results for Passmark Performance Test 7.0, Memory Mark – APC2200/PPC2200	148
Figure 111: Results Passmark Performance Test 7.0, Disk Mark – APC2200/PPC2200	149
Figure 112: Comparison for Passmark Performance Test 7.0, Passmark Rating	150

6 Table Index

Table 1: Versions.....	2
Table 2: Safety notices	3
Table 3: Test locations	3
Table 4: Devices being tested	10
Table 5: Hard disks and removeable devices used.....	10
Table 6: Benchmark programs used and the corresponding WEB links.....	11
Table 7: Results for Sisoft Sandra 2002 Prof CPU arithmetic.....	13
Table 8: Results for Sisoft Sandra 2002 Prof CPU multimedia.....	14
Table 9: Results for Sisoft Sandra 2002 Prof CPU memory bandwidth.....	16
Table 10: Results for Sisoft Sandra 2005 SR1 CPU arithmetic	18
Table 11: Results for Sisoft Sandra 2005 SR1 CPU multimedia	20
Table 12: Results for Sisoft Sandra 2005 SR1 CPU memory bandwidth	22
Table 13: Results for PCMark2002	24
Table 14: Results for PCMark04	26
Table 15: Results for WinBench99 CPUMark99	28
Table 16: Results for WinBench99 FPUWinMark	30
Table 17: Results for WinBench99 Direct Draw	32
Table 18: Results for WinBench99 Disk Inspection Test	34
Table 19: Results for WinBench99 High End Disk WinMark99.....	36
Table 20: Results for WinBench99 Business Disk Winmark99.....	38
Table 21: Results for HDTACH 2.70 read speed	39
Table 22: Results for HDTACH access time measurement	40
Table 23: Results for 3D Mark 2000.....	41
Table 24: Results for 3D Mark 2001SE	43
Table 25: Results for AR010 Version E2.82.....	45
Table 26: Results for B&R AR106 Version B2.83	48
Table 27: Results for Sisoft Sandra Pro Business 2007, CPU Arithmetic	49
Table 28: Results for Sisoft Sandra Pro Business 2007, CPU MultiMedia	51
Table 29: Results for Sisoft Sandra Pro Business 2007, CPU Memory Bandwidth.....	53
Table 30: Results for Sisoft Sandra Pro Business 2007, cache and memory bandwidth	55
Table 31: Results for Sisoft Sandra Pro Business 2007, physical devices / removeable devices.....	57
Table 32: Results for SiSoft Sandra 2011, CPU Arithmetic – APC910/PPC900	60
Table 33: Results for SiSoft Sandra 2011, Processor Multi-Media – APC910/PPC900	63
Table 34: Results for SiSoft Sandra 2011, Multi-Core Efficiency – APC910/PPC900.....	65
Table 35: Results for SiSoft Sandra 2011, Cryptography – APC910/PPC900	68
Table 36: Results for SiSoft Sandra 2011, Video Rendering (Direct3D 9c/10 Devices) – APC910/PPC900.....	71
Table 37: Results for SiSoft Sandra 2011, Video Rendering (Direct3D 10.1/11 Devices) – APC910/PPC900.....	74
Table 38: Results for SiSoft Sandra 2011, Video Memory Bandwidth (Direct3D 10/10.1 Devices) – APC910/PPC900.....	78
Table 39: Results SiSoft Sandra 2011, Video Memory Bandwidth (Direct3D 11 Devices) – APC910/PPC900.....	78
Table 40: Results for SiSoft Sandra 2011, Memory Bandwidth – APC910/PPC900	83
Table 41: Results for SiSoft Sandra 2011, Memory Latency CPU1 – APC910/PPC900.....	86
Table 42: Results for SiSoft Sandra 2011, Memory Latency CPU2 – APC910/PPC900.....	87
Table 43: Results for SiSoft Sandra 2011, Cache and Memory – APC910/PPC900	90
Table 44: Results for SiSoft Sandra 2011, CPU Arithmetic – APC2100/PPC2100	92
Table 45: Results for SiSoft Sandra 2011, Processor Multi-Media – APC2100/PPC2100	93
Table 46: Results for SiSoft Sandra 2011, Multi-Core Efficiency – APC2100/PPC2100.....	94
Table 47: Results for SiSoft Sandra 2011, Cryptography – APC2100/PPC2100	95
Table 48: Results for SiSoft Sandra 2011, Video Rendering (Direct3D 9c/10 Devices) – APC2100/PPC2100.....	96

Table 49: Results for SiSoft Sandra 2011, Video Rendering (Direct3D 10.1/11 Devices) – APC2100/PPC2100.....	97
Table 50: Results for SiSoft Sandra 2011, Video Memory Bandwidth (Direct3D 10/10.1 Devices) – APC2100/PPC2100.....	99
Table 51: Results SiSoft Sandra 2011, Video Memory Bandwidth (Direct3D 11 Devices) – APC2100/PPC2100.....	101
Table 52: Results for SiSoft Sandra 2011, Memory Bandwidth – APC2100/PPC2100.....	102
Table 53: Results for SiSoft Sandra 2011, Memory Latency CPU1 – APC2100/PPC2100.....	103
Table 54: Results for SiSoft Sandra 2011, Memory Latency CPU2 – APC2100/PPC2100.....	104
Table 55: Results for SiSoft Sandra 2011, Cache and Memory – APC2100/PPC2100.....	105
Table 56: Comparison for SiSoft Sandra 2011, CPU Arithmetic.....	106
Table 57: Results for Passmark Performance Test 7.0, Passmark Rating – APC910/PPC900.....	108
Table 58: Results for Passmark Performance Test 7.0, CPU Mark – APC910/PPC900.....	110
Table 59: Results for Passmark Performance Test 7.0, 2D Graphics Mark – APC910/PPC900.....	112
Table 60: Results for Passmark Performance Test 7.0, 3D Graphics Mark – APC910/PPC900.....	114
Table 61: Results for Passmark Performance Test 7.0, Memory Mark – APC910/PPC900.....	116
Table 62: Results for Passmark Performance Test 7.0, Disk Mark – APC910/PPC900.....	118
Table 63: Results for Passmark Performance Test 7.0, Passmark Rating – APC910.....	120
Table 64: Results for Passmark Performance Test 7.0, CPU Mark – APC910.....	122
Table 65: Results for Passmark Performance Test 7.0, 2D Graphics Mark – APC910.....	124
Table 66: Results for Passmark Performance Test 7.0, 3D Graphics Mark – APC910.....	126
Table 67: Results for Passmark Performance Test 7.0, Memory Mark – APC910.....	128
Table 68: Results for Passmark Performance Test 7.0, Disk Mark – APC910.....	130
Table 69: Results for Passmark Performance Test 7.0, Passmark Rating – APC2100/PPC2100.....	132
Table 70: Results for Passmark Performance Test 7.0, CPU Mark – APC2100/PPC2100.....	133
Table 71: Results for Passmark Performance Test 7.0, 2D Graphics Mark – APC2100/PPC2100.....	134
Table 72: Results for Passmark Performance Test 7.0, 3D Graphics Mark – APC2100/PPC2100.....	135
Table 73: Results for Passmark Performance Test 7.0, Memory Mark – APC2100/PPC2100.....	136
Table 74: Results for Passmark Performance Test 7.0, Disk Mark – APC2100/PPC2100.....	137
Table 75: Results for Passmark Performance Test 7.0, Passmark Rating – APC3100/PPC3100.....	138
Table 76: Results for Passmark Performance Test 7.0, CPU Mark – APC3100/PPC3100.....	139
Table 77: Results for Passmark Performance Test 7.0, 2D Graphics Mark – APC3100/PPC3100.....	140
Table 78: Results for Passmark Performance Test 7.0, 3D Graphics Mark – APC3100/PPC3100.....	141
Table 79: Results for Passmark Performance Test 7.0, Memory Mark – APC3100/PPC3100.....	142
Table 80: Results for Passmark Performance Test 7.0, Disk Mark – APC3100/PPC3100.....	143
Table 81: Results for Passmark Performance Test 7.0, Passmark Rating – APC2200/PPC2200.....	144
Table 82: Results for Passmark Performance Test 7.0, CPU Mark – APC2200/PPC2200.....	145
Table 83: Results for Passmark Performance Test 7.0, 2D Graphics Mark – APC2200/PPC2200.....	146
Table 84: Results for Passmark Performance Test 7.0, 3D Graphics Mark – APC2200/PPC2200.....	147
Table 85: Results for Passmark Performance Test 7.0, Memory Mark – APC2200/PPC2200.....	148
Table 86: Results for Passmark Performance Test 7.0, Disk Mark – APC2200/PPC2200.....	149
Table 87: Comparison for Passmark Performance Test 7.0, Passmark Rating (higher scores are better).....	152

7 Index

	3		
3D Mark 2000	11, 41, 42		
3D Mark 2001SE	11, 43, 44		
	A		
AMD 486DX2	7, 12, 14, 16, 28, 30, 32		
AMD 486DX5	7, 12, 14, 16, 28, 30, 32		
ATI			
Radeon 9600	7		
Rage Mobility	7		
	B		
B&R			
Automation Runtime AR010 Version E2.82...45,			
46			
Automation Runtime AR106 Version B2.83...47,			
48			
Benchmark programs	11		
	C		
Chips & Technologies 65535	7		
Chips & Technologies 69000	7		
	D		
Devices being tested	7		
Distribution	2		
	F		
Figure Index	153		
	G		
Geode 7, 12, 14, 16, 18, 20, 22, 24, 26, 28, 30, 32,			
41, 43			
	H		
Hardware	7		
HDTach V2.70	11, 39		
	I		
Index	158		
Intel			
82815 Graphics	7		
82855 GME Graphic	7		
82865G Graphics	7		
Celeron 3... 7, 12, 14, 16, 18, 20, 22, 24, 26, 28,			
30, 32, 41, 43, 45, 48			
Celeron M.. 7, 12, 14, 16, 18, 20, 22, 24, 26, 28,			
30, 32, 41, 43, 45, 48, 49, 51, 53, 55			
Pentium 3 .. 7, 12, 14, 16, 18, 20, 22, 24, 26, 28,			
30, 32, 41, 43			
Pentium 4 .. 7, 12, 14, 16, 18, 20, 22, 24, 26, 28,			
29, 30, 31, 32, 33, 41, 43			
Pentium M. 7, 12, 14, 16, 18, 20, 22, 24, 26, 28,			
30, 32, 41, 43, 45, 48, 49, 51, 53, 55			
Introduction	6		
	O		
Operating system	11		
	P		
Passmark Performance Test 7.0	108		
PCMark04	11, 26		
PCMark2002	11, 24		
	R		
Results	12		
	S		
Safety Notices	3		
Sisoft			
Sandra 2002 Prof	12, 13, 14, 15, 16, 17		
Sandra 2005 SR1	18, 19, 20, 21, 22, 23		
Sandra 2011 Lite	59		
Sandra Pro Business 2007	49		
Software	11		
	T		
Table Index	156		
Table of Contents	4		
Test Locations	3		
	V		
Versions	2		
	W		
WinBench99	11, 28, 30, 32, 34, 35, 36, 37, 38		