

# **Automation Panel 9xD - Hygienic design**

## **User's manual**

Version: **1.92 (August 2022)**  
Order no.: **MAAP9xD.HY-ENG**

**Translation of the original documentation**

## **Publishing information**

B&R Industrial Automation GmbH

B&R Strasse 1

5142 Eggelsberg

Austria

Telephone: +43 7748 6586-0

Fax: +43 7748 6586-26

[office@br-automation.com](mailto:office@br-automation.com)

## **Disclaimer**

All information in this document is current as of its creation. The contents of this document are subject to change without notice. B&R Industrial Automation GmbH assumes unlimited liability in particular for technical or editorial errors in this document only (i) in the event of gross negligence or (ii) for culpably inflicted personal injury. Beyond that, liability is excluded to the extent permitted by law. Liability in cases in which the law stipulates mandatory unlimited liability (such as product liability) remains unaffected. Liability for indirect damage, consequential damage, business interruption, loss of profit or loss of information and data is excluded, in particular for damage that is directly or indirectly attributable to the delivery, performance and use of this material.

B&R Industrial Automation GmbH notes that the software and hardware designations and brand names of the respective companies used in this document are subject to general trademark, brand or patent protection.

Hardware and software from third-party suppliers referenced in this document is subject exclusively to the respective terms of use of these third-party providers. B&R Industrial Automation GmbH assumes no liability in this regard. Any recommendations made by B&R Industrial Automation GmbH are not contractual content, but merely non-binding information for which no liability is assumed. When using hardware and software from third-party suppliers, the relevant user documentation of these third-party suppliers must additionally be consulted and, in particular, the safety guidelines and technical specifications contained therein must be observed. The compatibility of the products from B&R Industrial Automation GmbH described in this document with hardware and software from third-party suppliers is not contractual content unless this has been separately agreed in individual cases; in this respect, warranty for such compatibility is excluded in any case, and it is the sole responsibility of the customer to verify this compatibility in advance.

<b>1 Introduction</b>	<b>8</b>
1.1 Manual history	8
1.2 Information about this document	9
1.2.1 Organization of notices	9
1.2.2 Guidelines	9
<b>2 General safety guidelines</b>	<b>10</b>
2.1 Intended use	10
2.2 Protection against electrostatic discharge	10
2.2.1 Packaging	10
2.2.2 Regulations for proper ESD handling	10
2.3 Regulations and measures	11
2.4 Transport and storage	11
2.5 Installation	11
2.6 Operation	11
2.6.1 Protection against contact with electrical parts	11
2.6.2 Ambient conditions - Dust, moisture, aggressive gases	12
2.6.3 Programs, viruses and malicious programs	12
2.7 Cybersecurity disclaimer for products	12
<b>3 System overview</b>	<b>13</b>
3.1 Information about this user's manual	13
3.2 Description of individual modules	13
3.2.1 Panels	13
3.2.2 Link modules	14
3.2.3 System units	14
3.3 Design/Configuration	15
3.3.1 Configuration	15
3.4 Overview	16
<b>4 Technical data</b>	<b>17</b>
4.1 Complete system	17
4.1.1 Connection options	17
4.1.1.1 SDL operation	17
4.1.1.2 DVI operation	19
4.1.1.3 SDL3 operation	21
4.1.1.4 SDL4 operation	22
4.1.2 Electrical properties	23
4.1.2.1 Power calculation	23
4.1.3 Environmental properties	26
4.1.3.1 Temperature specifications	26
4.1.3.2 Minimum ambient temperature during operation	28
4.1.3.3 Temperature during storage and transport	29
4.1.3.4 Temperature sensor positions	30
4.1.3.5 Relative humidity	31
4.1.3.6 Vibration and shock	32
4.1.4 Encoder interface link module	33
4.1.4.1 SDL/DVI receiver (5DLSDL.1001-00)	33
4.1.4.2 SDL3 receiver (5DLSD3.1001-00)	39
4.1.4.3 SDL4 receiver (5DLSD4.1001-00)	42
4.1.5 System unit device interfaces	45
4.1.5.1 System unit PPC2100 (5PPC2100.BYxx-000)	45
4.1.5.2 System unit PPC2200 (5PPC2200.ALxx-000)	51
4.1.6 Features	57
4.1.6.1 AP92D - Features	57
4.1.6.2 AP93D - Features	59
4.1.6.3 AP99D - Features	61

4.2 Individual components.....	68
4.2.1 Panels.....	68
4.2.1.1 5AP92D.1505-I00.....	68
4.2.1.2 5AP92D.1906-I00.....	70
4.2.1.3 5AP93D.185B-B62.....	72
4.2.1.4 5AP93D.240C-B62.....	74
4.2.1.5 5AP99D.156B-B62.....	76
4.2.1.6 5AP99D.185B-B62.....	79
4.2.1.7 5AP99D.185C-B62.....	82
4.2.1.8 5AP99D.215C-B62.....	85
4.2.2 Link modules.....	87
4.2.2.1 5DLSDL.1001-00.....	87
4.2.2.2 5DLSD3.1001-00.....	89
4.2.2.3 5DLSD4.1001-00.....	91
4.2.3 System units.....	93
4.2.3.1 5PPC2100.BYxx-000.....	93
4.2.3.2 5PPC2200.ALxx-000.....	96
4.2.4 Interface options.....	99
4.2.5 Battery compartment.....	100
4.2.5.1 5ACCBT01.0000-001.....	100
4.2.6 CFast cards.....	101
<b>5 Installation and wiring.....</b>	<b>102</b>
5.1 Important information for installation/commissioning.....	102
5.2 Alignment of the swing arm connection for AP93D and AP99D.....	102
5.3 Installing optional control elements.....	105
5.4 Device labeling with slide-in labels.....	106
5.5 Connecting to the power grid.....	106
5.5.1 Installing the DC power cable.....	106
5.5.1.1 Wiring.....	106
5.5.2 Connecting the power supply to a B&R device.....	107
5.5.3 Grounding concept - Functional ground.....	108
5.6 Connecting cables.....	109
<b>6 Commissioning.....</b>	<b>110</b>
6.1 Basic information.....	110
6.2 Switching on the device for the first time.....	110
6.2.1 General information before switching on the device.....	110
6.2.2 Switching on the Automation Panel.....	110
6.3 Touch screen calibration.....	111
6.3.1 Single-touch (analog resistive).....	111
6.3.1.1 Windows 10 IoT Enterprise.....	111
6.3.1.2 Windows Embedded 8.1 Industry Pro.....	111
6.3.1.3 Windows 7 Professional / Ultimate.....	111
6.3.1.4 Windows Embedded Standard 7 Embedded / Premium.....	111
6.3.1.5 Windows XP Professional.....	111
6.3.1.6 Windows Embedded Standard 2009.....	111
6.3.2 Multi-touch (projected capacitive - PCT).....	111
6.3.2.1 Windows 10 IoT Enterprise.....	111
6.3.2.2 Windows Embedded 8.1 Industry Pro.....	111
6.3.2.3 Windows 7 Professional / Ultimate.....	112
6.3.2.4 Windows Embedded Standard 7 Premium.....	112
6.4 Display brightness control.....	113
6.4.1 Adjusting in SDL / SDL3 / SDL4 mode.....	113
6.4.2 Adjusting in DVI operation.....	113

<b>7 Software</b> .....	<b>114</b>
7.1 Upgrade information.....	114
7.1.1 Automation Panel firmware upgrade.....	114
7.2 Automation Device Interface (ADI).....	115
7.2.1 ADI driver.....	115
7.2.1.1 Installation.....	115
7.2.1.2 ADI Control Center.....	115
7.2.2 ADI Development Kit.....	116
7.2.3 ADI .NET SDK.....	117
7.2.4 ADI OPC UA Server.....	118
7.3 Key Editor.....	119
7.4 RFID read/write transponder unit.....	120
7.4.1 Commissioning.....	120
7.4.1.1 Connection.....	120
7.4.1.2 Supported operating systems.....	120
7.4.1.3 Driver installation.....	120
7.4.1.4 Port settings.....	120
7.4.1.5 Terminal program.....	120
7.4.1.6 RFID command set.....	121
7.4.2 Commands.....	121
7.4.2.1 General commands.....	121
7.4.2.2 Upgrade commands.....	121
7.4.3 MIFARE.....	122
7.4.3.1 MIFARE commands.....	122
7.4.3.2 Authentication.....	122
7.4.3.3 Access rights and memory organization.....	123
7.4.3.4 Value block.....	123
7.4.3.5 Access rights.....	124
7.4.3.6 MIFARE commands - Examples.....	125
7.4.4 ISO15693.....	125
7.4.4.1 ISO 15693 commands.....	125
7.4.4.2 Memory organization.....	126
7.4.4.3 Flag definitions.....	127
7.4.4.4 ISO 15693 commands - Examples.....	128
7.4.5 Error codes.....	129
7.4.5.1 Error messages and error numbers.....	129
<b>8 International and national certifications</b> .....	<b>132</b>
8.1 Directives and declarations.....	132
8.1.1 CE marking.....	132
8.1.2 EMC Directive.....	132
8.1.3 Low voltage directive.....	132
8.1.4 Radio Equipment Directive (RED).....	132
8.2 Certifications.....	133
8.2.1 UL certification.....	133
8.2.1.1 UL - Additional information.....	133
8.2.2 EAC.....	133
8.2.3 UKCA.....	134
8.2.4 FCC and IC.....	134
<b>9 Accessories</b> .....	<b>135</b>
9.1 Accessories - Information.....	135
9.2 Cables.....	135
9.3 USB mass storage device.....	135
9.4 Terminal block power supply.....	136
9.4.1 OTB103.9x.....	136
9.4.1.1 Order data.....	136

9.4.1.2 Technical data.....	136
9.5 Cage clamp terminal block for wiring emergency stop.....	137
9.5.1 OTB1104.8100.....	137
9.5.1.1 General information.....	137
9.5.1.2 Order data.....	137
9.5.1.3 Technical data.....	137
9.6 Screw clamp terminal block for wiring B&R illuminated ring keys.....	138
9.6.1 OTB1112.8010.....	138
9.6.1.1 General information.....	138
9.6.1.2 Order data.....	138
9.6.1.3 Technical data.....	138
9.7 Line filter.....	139
9.7.1 5AC804.MFLT-00.....	139
9.7.1.1 General information.....	139
9.7.1.2 Order data.....	139
9.7.1.3 Technical data.....	139
9.7.1.4 Dimensions.....	140
9.7.1.5 Drilling template.....	140
9.7.1.6 Connecting to the end device.....	140
9.8 Replacement screws.....	141
9.8.1 5A9000.75, 5A9000.76.....	141
9.8.1.1 General information.....	141
9.8.1.2 Order data.....	141
9.8.1.3 Technical data.....	141
9.9 Replacement gaskets.....	142
9.9.1 5A9000.73, 5A9000.74.....	142
9.9.1.1 General information.....	142
9.9.1.2 Order data.....	142
9.9.1.3 Technical data.....	142
9.10 Replacement gaskets.....	143
9.10.1 5A9000.D3, 5A9000.D4, 5A9000.D5, 5A9000.D6, 5A9000.D7.....	143
9.10.1.1 General information.....	143
9.10.1.2 Order data.....	143
9.10.1.3 Technical data.....	143
9.11 Replacement parts.....	144
9.11.1 Replacement parts - Order data.....	144
9.11.1.1 5ACCRPC2.0003-000 - Technical data.....	144
<b>10 Maintenance.....</b>	<b>145</b>
10.1 Cleaning.....	145
10.2 User tips for increasing the service life of the display.....	146
10.2.1 Backlight.....	146
10.2.1.1 Measures to maintain backlight service life.....	146
10.2.2 Image persistence.....	146
10.2.2.1 What causes image persistence?.....	146
10.2.2.2 How can image persistence be reduced?.....	146
10.3 Pixel errors.....	146
10.4 System units.....	146
10.5 Repairs/Complaints and replacement parts.....	147
A.A MTCX.....	148
A.B Abbreviations.....	148
A.C Viewing angles.....	148
A.4 Chemical resistance.....	150
A.4.1 Autotex panel overlay (polyester).....	151
A.4.2 Touch screen.....	152
A.D Features.....	153
A.D.1 RFID read/write transponder unit.....	153

A.D.2 Emergency stop Schlegel FRVKPOOI.....	153
A.E Touch screen.....	154
A.E.1 Touch screen (single-touch).....	154
A.E.1.1 Technical data.....	154
A.E.1.2 Temperature/Humidity diagram.....	154
A.E.2 Touch screen (multi-touch generation 3).....	154
A.E.2.1 Technical data.....	154
A.E.2.2 Temperature/Humidity diagram.....	155
A.F POWERLINK.....	155
A.F.1 LED "S/E" (status/error LED).....	155
A.F.1.1 Ethernet mode.....	155
A.F.1.2 POWERLINK V2 mode.....	156
A.F.1.3 System stop error codes.....	157
A.F.1.4 POWERLINK V2.....	157
<b>12 Environmentally friendly disposal.....</b>	<b>158</b>
12.1 Separation of materials.....	158

# 1 Introduction

## Information:

B&R makes every effort to keep documents as current as possible. The most current versions are available for download on the B&R website ([www.br-automation.com](http://www.br-automation.com)).

## 1.1 Manual history

Version	Date	Comment <sup>1)</sup>
1.92	August 2022	Updated document. <ul style="list-style-type: none"> <li>Updated "International and national certifications" on page 132.</li> <li>Updated "Grounding concept - Functional ground" on page 108.</li> </ul>
1.91	September 2021	Updated document. <ul style="list-style-type: none"> <li>Corrected specifications for panel 5AP99D.185C-B62, see <a href="#">Power calculation</a>.</li> </ul>
1.90	March 2021	Updated document, editorial changes. <ul style="list-style-type: none"> <li>Updated "5AP99D.185C-B62" on page 82.</li> <li>Updated "Device labeling with slide-in labels" on page 106.</li> <li>Updated information about the fuse for link modules, see "+24 VDC power supply" in section "Encoder interface link module" on page 33.</li> </ul>
1.80	September 2020	Updated document, editorial changes. <ul style="list-style-type: none"> <li>Updated section "Installing optional control elements" on page 105.</li> <li>Updated section "General safety guidelines" on page 10.</li> <li>Updated section "Power calculation" on page 23.</li> <li>Updated section "Individual components" on page 68.</li> <li>Updated section "Software" on page 114.</li> <li>Updated section "Accessories" on page 135.</li> <li>Updated section "Maintenance" on page 145.</li> </ul>
1.70	2019-11-14	Updated book. <ul style="list-style-type: none"> <li>Editorial revisions.</li> <li>Added system unit 5PPC2200.ALxx-000.</li> <li>Added link module 5DLSD4.1001-00.</li> <li>Updated chapter "Technical data".</li> <li>Updated chapter "Installation and wiring".</li> <li>Updated chapter "Commissioning".</li> </ul>
1.60	2018-02-26	Updated book. <ul style="list-style-type: none"> <li>Added hygienic panels 5AP92D.1505-I00 and 5AP92D.1906-I00 to user's manual.</li> </ul>
1.50	2018-01-23	Updated book. <ul style="list-style-type: none"> <li>Updated chapter "Standards and certifications".</li> </ul>
1.40	2017-11-06	Updated book. <ul style="list-style-type: none"> <li>Updated chapter "Individual components".</li> </ul>
1.30	2017-09-11	Updated book. <ul style="list-style-type: none"> <li>Visual Components: Updated description of colors.</li> <li>Individual components: Updated transmittance for touch screen.</li> <li>Updated accessories.</li> <li>Features: Updated optional cutouts.</li> </ul>
1.20	2016-12-21	Updated book. <ul style="list-style-type: none"> <li>Revised key and LED matrix.</li> <li>Updated accessory 0TB1104.8100.</li> <li>Updated accessory 0TB1112.8010.</li> <li>Updated accessory line filter 5AC804.MFLT-00.</li> </ul>
1.10	2015-07-08	<ul style="list-style-type: none"> <li>Changed housing with material number.</li> <li>Mounting possible from top or bottom.</li> </ul>
1.00	2015-02-05	<ul style="list-style-type: none"> <li>First version</li> </ul>

1) Editorial corrections are not listed.



## 1.2 Information about this document

**This document is not intended for end customers! The safety guidelines required for end customers must be incorporated into the operating instructions for end customers in the respective national language by the machine manufacturer or system provider.**

### 1.2.1 Organization of notices

#### Safety notices

Contain **only** information that warns of dangerous functions or situations.

Signal word	Description
<b>Danger!</b>	Failure to observe these safety guidelines and notices will result in death, severe injury or substantial damage to property.
<b>Warning!</b>	Failure to observe these safety guidelines and notices can result in death, severe injury or substantial damage to property.
<b>Caution!</b>	Failure to observe these safety guidelines and notices can result in minor injury or damage to property.
<b>Notice!</b>	Failure to observe these safety guidelines and notices can result in damage to property.

#### General notices

Contain **useful** information for users and instructions for avoiding malfunctions.

Signal word	Description
<b>Information:</b>	Useful information, application tips and instructions for avoiding malfunctions.

### 1.2.2 Guidelines

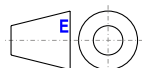

European dimension standards apply to all dimension diagrams.

**All dimensions in millimeters.**

Unless otherwise specified, the following general tolerances apply:

Nominal dimension range	General tolerance per DIN ISO 2768 medium
Up to 6 mm	±0.1 mm
Over 6 to 30 mm	±0.2 mm
Over 30 to 120 mm	±0.3 mm
Over 120 to 400 mm	±0.5 mm
Over 400 to 1000 mm	±0.8 mm

## 2 General safety guidelines

---

### 2.1 Intended use

In all cases, it is necessary to observe and comply with applicable national and international standards, regulations and safety measures!

The B&R products described in this manual are intended for use in industry and industrial applications. The intended use includes control, operation, monitoring, drive and HMI tasks as part of automation processes in machines and systems.

B&R products are only permitted to be used in their original condition. Modifications and extensions are only permitted if they are described in this manual.

B&R excludes liability for damage of any kind resulting from the use of B&R products in any intended way.

B&R products have not been designed, developed and manufactured for use that involves fatal risks or hazards that could result in death, injury, serious physical harm or other loss without the assurance of exceptionally stringent safety precautions.

B&R products are explicitly not intended for use in the following applications:

- Monitoring and control of thermonuclear processes
- Weapon systems control
- Flight and traffic control systems for passenger and freight transport
- Health monitoring and life support systems

### 2.2 Protection against electrostatic discharge

Electrical assemblies that can be damaged by electrostatic discharge (ESD) must be handled accordingly.

#### 2.2.1 Packaging

- **Electrical assemblies with housing:**  
Do not require special ESD packaging but must be handled properly (see "Electrical assemblies with housing").
- **Electrical assemblies without housing:**  
Are protected by ESD-suitable packaging.

#### 2.2.2 Regulations for proper ESD handling

##### Electrical assemblies with housing

- Do not touch the connector contacts of connected cables.
- Do not touch the contact tips on circuit boards.

##### Electrical assemblies without housing

The following applies in addition to "Electrical assemblies with housing":

- All persons handling electrical assemblies and devices in which electrical assemblies are installed must be grounded.
- Assemblies are only permitted to be touched on the narrow sides or front plate.
- Always place assemblies on suitable surfaces (ESD packaging, conductive foam, etc.). Metallic surfaces are not suitable surfaces!
- Assemblies must not be subjected to electrostatic discharges (e.g. due to charged plastics).
- A minimum distance of 10 cm from monitors or television sets must be maintained.

- Measuring instruments and devices must be grounded.
- Test probes of floating potential measuring instruments must be discharged briefly on suitable grounded surfaces before measurement.

### Individual components

- ESD protective measures for individual components are implemented throughout B&R (conductive floors, shoes, wrist straps, etc.).
- The increased ESD protective measures for individual components are not required for handling B&R products at customer locations.

## 2.3 Regulations and measures

Electronic devices are generally not failsafe. If the programmable logic controller, operating or control device or uninterruptible power supply fails, the user is responsible for ensuring that connected devices (such as motors) are brought to a safe state.

When using programmable logic controllers as well as when using operating and monitoring devices as control systems in conjunction with a Soft PLC (e.g. B&R Automation Runtime or similar product) or Slot PLC (e.g. B&R LS251 or similar product), the safety measures that apply to industrial controllers (protection by protective equipment such as emergency stops) must be observed in accordance with applicable national and international regulations. This also applies to all other connected devices, such as drives.

All work such as installation, commissioning and servicing are only permitted to be carried out by qualified personnel. Qualified personnel are persons who are familiar with the transport, installation, assembly, commissioning and operation of the product and have the appropriate qualifications for their job (e.g. IEC 60364). National accident prevention regulations must be observed.

The safety guidelines, information about connection conditions (nameplate and documentation) and limit values specified in the technical data must be read carefully before installation and commissioning and must be strictly observed.

## 2.4 Transport and storage

During transport and storage, devices must be protected against undue stress (mechanical stress, temperature, humidity, aggressive atmosphere).

## 2.5 Installation

- The devices are not ready for use and must be installed and wired according to the requirements of this documentation in order to comply with EMC limit values.
- Installation must be carried out according to the documentation using suitable equipment and tools.
- Devices are only permitted to be installed in a voltage-free state and by qualified personnel. The control cabinet must first be disconnected from the power supply and secured against being switched on again.
- General safety regulations and national accident prevention regulations must be observed.
- The electrical installation must be carried out in accordance with relevant regulations (e.g. line cross section, fuse protection, protective ground connection).

## 2.6 Operation

### 2.6.1 Protection against contact with electrical parts

In order to operate programmable logic controllers, operating and monitoring devices and uninterruptible power supplies, it is necessary for certain components to carry dangerous voltages over 42 VDC. Touching one of these components can result in a life-threatening electric shock. There is a risk of death, serious injury or damage to property.

Before switching on programmable logic controllers, operating and monitoring devices and uninterruptible power supplies, it must be ensured that the housing is properly connected to ground potential (PE rail). Ground connections must also be made if the operating and monitoring device and uninterruptible power supply are only connected for testing purposes or only operated for a short time!

Before switching on, live parts must be securely covered. All covers must be kept closed during operation.

## 2.6.2 Ambient conditions - Dust, moisture, aggressive gases

The use of operating and monitoring devices (e.g. industrial PCs, Power Panels, Mobile Panels) and uninterruptible power supplies in dusty environments must be avoided. This can otherwise result in dust deposits that affect the functionality of the device, especially in systems with active cooling (fans), which may no longer ensure sufficient cooling.

The presence of aggressive gases in the environment can also result in malfunctions. In combination with high temperature and relative humidity, aggressive gases – for example with sulfur, nitrogen and chlorine components – trigger chemical processes that can very quickly impair or damage electronic components. Blackened copper surfaces and cable ends in existing installations are indicators of aggressive gases.

When operated in rooms with dust and condensation that can endanger functionality, operating and monitoring devices such as Automation Panels or Power Panels are protected on the front against the ingress of dust and moisture when installed correctly (e.g. cutout installation). The back of all devices must be protected against the ingress of dust and moisture, however, or the dust deposits must be removed at suitable intervals.

## 2.6.3 Programs, viruses and malicious programs

Any data exchange or installation of software using data storage media (e.g. floppy disk, CD-ROM, USB flash drive) or via networks or the Internet poses a potential threat to the system. It is the direct responsibility of the user to avert these dangers and to take appropriate measures such as virus protection programs and firewalls to protect against them and to use only software from trustworthy sources.

## 2.7 Cybersecurity disclaimer for products

B&R products communicate via a network interface and were developed for secure connection with internal and, if necessary, other networks such as the Internet.

### Information:

**In the following, B&R products are referred to as "product" and all types of networks (e.g. internal networks and the Internet) are referred to as "network".**

It is the sole responsibility of the customer to establish and continuously ensure a secure connection between the product and the network. In addition, appropriate security measures must be implemented and maintained to protect the product and entire network from any security breaches, unauthorized access, interference, digital intrusion, data leakage and/or theft of data or information.

B&R Industrial Automation GmbH and its subsidiaries are not liable for damages and/or losses in connection with security breaches, unauthorized access, interference, digital intrusion, data leakage and/or theft of data or information.

The aforementioned appropriate security measures include, for example:

- Segmentation of the network (e.g. separation of the IT network from the control network<sup>1)</sup>)
- Use of firewalls
- Use of authentication mechanisms
- Encryption of data
- Use of anti-malware software

Before B&R releases products or updates, they are subjected to appropriate functional testing. Independently of this, we recommend that our customers develop their own test processes in order to be able to check the effects of changes in advance. Such changes include, for example:

- Installation of product updates
- Significant system modifications such as configuration changes
- Deployment of updates or patches for third-party software (non-B&R software)
- Hardware replacement

These tests should ensure that implemented security measures remain effective and that systems in the customer's environment behave as expected.

<sup>1)</sup> The term "control network" refers to computer networks used to connect control systems. The control network can be divided into zones, and there can be several separate control networks within a company or site. The term "control systems" refers to all types of B&R products such as controllers (e.g. X20), HMI systems (e.g. Power Panel T30), process control systems (e.g. APROL) and supporting systems such as engineering workstations with Automation Studio.

## 3 System overview

---

### 3.1 Information about this user's manual

This user's manual contains all relevant information about an operational Automation Panel 9xD - Hygienic design device.

### 3.2 Description of individual modules

#### 3.2.1 Panels

Panels form the basis for each Automation Panel 9xD, Panel PC 2100 swing arm device and Panel PC 2200 swing arm device. They consist of a display, touch screen and housing. Different display sizes and panels with or without operating elements are available. The panels can only be operated as a complete system in combination with a link module (Automation Panel 9xD) or CPU board and system unit (Panel PC 2100 / Panel PC 2200 with swing arm system).

Single-touch panels start at order number 5AP92D.xxxx-xxx, multi-touch panels start at 5AP93D.xxxx-xxx and multi-touch panels with keys start at 5AP99D.xxxx-xxx.



### 3.2.2 Link modules

Link modules have various graphics interfaces and connections. If a link module is installed on a panel, the result is an Automation Panel 9xD. The Automation Panel 9xD is installed on a swing arm system using the attached flange.

A link module cannot be operated without a panel.

#### Information:

For additional information, see [Automation Panel 5000 user's manual](#).



### 3.2.3 System units

#### Panel PC 2100

System units consist of the CPU board and an aluminum housing. All interfaces and the main memory of the PPC2100 are integrated on the system units. An interface option and CFast card can also be connected. The main memory modules are permanently installed on the system unit and cannot be replaced.

If a system unit is installed on a panel, the result is an operational Panel PC 2100.

A system unit without a panel is not functional.

#### Information:

For additional information, see the [PPC2100SW1 user's manual](#).



#### Panel PC 2200

System units consist of the CPU board and an aluminum housing. All interfaces and the main memory of the PPC2200 are integrated on the system units. An interface option and CFast card can also be connected. The main memory modules are permanently installed on the system unit and cannot be replaced.

If a system unit is installed on a panel, this results in a functional Panel PC 2200.

A system unit without a panel is not functional.

#### Information:

For additional information, see the [PPC2200SW user's manual](#).









### 3.3 Design/Configuration

The Automation Panel 9xD hygienic device can be used as a remote panel or part of a Panel PC. For this, the panel is either equipped with a receiver for Smart Display Link (SDL), SDL3 or SDL4, or a PC unit is attached. The operator panel is always identical.

#### 3.3.1 Configuration

The following individual components are mandatory for operation as an Automation Panel 9xD:

- Panel
- Link module or system unit
- Terminal block

Base system - Configuration						
<b>Panels</b>						Select 1
	<b>Automation Panel 92D</b>	<b>Diagonal</b>	<b>Resolution</b>	<b>Touch screen</b>	<b>Operating elements</b>	
	5AP92D.1505-I00	15.0"	XGA	Single-touch	No	
	5AP92D.1906-I00	19.0"	SXGA	Single-touch	No	
	<b>Automation Panel 93D</b>	<b>Diagonal</b>	<b>Resolution</b>	<b>Touch screen</b>	<b>Operating elements</b>	
	5AP93D.185B-B62	18.5"	HD	Multi-touch	No	
	5AP93D.240C-B62	24.0"	FHD	Multi-touch	No	
	<b>Automation Panel 99D</b>	<b>Diagonal</b>	<b>Resolution</b>	<b>Touch screen</b>	<b>Operating elements</b>	
	5AP99D.156B-B62	15.6"	HD	Multi-touch	Yes	
	5AP99D.185B-B62	18.5"	HD	Multi-touch	Yes	
	5AP99D.185C-B62	18.5"	FHD	Multi-touch	Yes	
	5AP99D.215C-B62	21.5"	FHD	Multi-touch	Yes	
<b>System units</b>						Select 1
<b>Panel PC 2200</b>						
	System unit	Processor	Processor clock frequency	Cores	Main memory type	Memory size
	5PPC2200.AL02-000	Intel Atom x5-E3930	1300 MHz	2	LPDDR4 SDRAM	2 GB
	5PPC2200.AL04-000	Intel Atom x5-E3930	1300 MHz	2	LPDDR4 SDRAM	4 GB
	5PPC2200.AL14-000	Intel Atom x5-E3940	1600 MHz	4	LPDDR4 SDRAM	4 GB
	5PPC2200.AL18-000	Intel Atom x5-E3940	1600 MHz	4	LPDDR4 SDRAM	8 GB
<b>Panel PC 2100</b>						
	System unit	Processor	Processor clock frequency	Cores	Main memory type	Memory size
	5PPC2100.BY01-000	Intel Atom E3815	1460 MHz	1	DDR3 SDRAM	1 GB
	5PPC2100.BY11-000	Intel Atom E3825	1330 MHz	2	DDR3 SDRAM	1 GB
	5PPC2100.BY22-000	Intel Atom E3826	1460 MHz	2	DDR3 SDRAM	2 GB
	5PPC2100.BY34-000	Intel Atom E3827	1750 MHz	2	DDR3 SDRAM	4 GB
	5PPC2100.BY44-000	Intel Atom E3845	1910 MHz	4	DDR3 SDRAM	4 GB
	5PPC2100.BY48-000	Intel Atom E3845	1910 MHz	4	DDR3 SDRAM	8 GB
<b>Link modules</b>						Select 1
	<b>SDL/DVI receiver</b>	<b>SDL3 receiver</b>		<b>SDL4 receiver</b>		
	5DLSDL.1001-00	5DLS3.1001-00		5DLS4.1001-00		
<b>Terminal blocks</b>						Select 1
	<b>Power supply connectors</b>					
	0TB103.9					
	0TB103.91					

### 3.4 Overview

Order number	Short description	Page
	<b>Accessories</b>	
5ACCBT01.0000-001	Battery compartment - Dark gray - Includes battery - For APC2200/PPC2200	100
	<b>Link modules</b>	
5DLS3D3.1001-00	Automation Panel link module - SDL3 receiver - For Automation Panel 923/933/1000 - For Automation Panel 5000	89
5DLS3D4.1001-00	Automation Panel link module - SDL4 receiver - For Automation Panel 923/933/1000 - For Automation Panel 5000	91
5DLS3DL.1001-00	Automation Panel link module - SDL/DVI receiver - For Automation Panel 923/933/1000 - For Automation Panel 5000	87
	<b>Panels</b>	
5AP92D.1505-I00	- Automation Panel 15" XGA TFT - Single-touch (analog, resistive) - 1024 x 768 pixels - Protection: IP69K (front), IP66 (back) - Front/Housing made of stainless steel (hygienic design) - Prepared for mounting on Rittal CP-S stainless steel swing arm system (flange not included in delivery) - USB port on back	68
5AP92D.1906-I00	- Automation Panel 19" SXGA TFT - Single-touch (analog, resistive) - 1280 x 1024 pixels - Protection: IP69K (front), IP66 (back) - Front/Housing made of stainless steel (hygienic design) - Prepared for mounting on Rittal CP-S stainless steel swing arm system (flange not included in delivery) - USB port on back	70
5AP93D.185B-B62	- Automation Panel 18.5" HD TFT - Multi-touch (projected capacitive) - 1366 x 768 pixels (16:9) - Protection: IP69K (front), IP66 (back) - Front/Housing made of stainless steel (hygienic design) - Prepared for mounting on Rittal CP-S stainless steel swing arm system (flange not included in delivery) - Flange possible on top or bottom - USB port on back	72
5AP93D.240C-B62	- Automation Panel 24.0" Full HD TFT - Multi-touch (projected capacitive) - 1920 x 1080 pixels (16:9) - Protection: IP69K (front), IP66 (back) - Front/Housing made of stainless steel (hygienic design) - Prepared for mounting on Rittal CP-S stainless steel swing arm system (flange not included in delivery) - Flange possible on top or bottom - USB port on back	74
5AP99D.156B-B62	- Automation Panel 15.6" HD TFT - Multi-touch (projected capacitive) - 1366 x 768 pixels (16:9) - Protection: IP69K (front), IP66 (back) - Front/Housing made of stainless steel (hygienic design) - Emergency stop, hygienic design - 5 B&R illuminated ring keys, 4-color (4x yellow, green, red, white and 1x yellow, green, red, blue) - Prepared for mounting on Rittal CP-S stainless steel swing arm system (flange not included in delivery) - Flange possible on top or bottom - USB port on back - RFID read/write unit	76
5AP99D.185B-B62	- Automation Panel 18.5" HD TFT - Multi-touch (projected capacitive) - 1366 x 768 pixels (16:9) - Protection: IP69K (front), IP66 (back) - Front/Housing made of stainless steel (hygienic design) - Emergency stop, hygienic design - 5 B&R illuminated ring keys, 4-color (4x yellow, green, red, white and 1x yellow, green, red, blue) - Prepared for mounting on Rittal CP-S stainless steel swing arm system (flange not included in delivery) - Flange possible on top or bottom - USB port on back - RFID read/write unit	79
5AP99D.185C-B62	- Automation Panel 18.5" FHD TFT - Multi-touch (projected capacitive) - 1920 x 1080 pixels (16:9) - Protection: IP69K (front), IP66 (back) - Front/Housing made of stainless steel (hygienic design) - Emergency stop, hygienic design - 5 B&R illuminated ring keys, 4-color (4x yellow, green, red, white and 1x yellow, green, red, blue) - Prepared for mounting on Rittal CP-S stainless steel swing arm system (flange not included in delivery) - Flange possible on top or bottom - USB port on back - RFID read/write unit	82
5AP99D.215C-B62	- Automation Panel 21.5" Full HD TFT - Multi-touch (projected capacitive) - 1920 x 1080 pixels (16:9) - Protection: IP69K (front), IP66 (back) - Front/Housing made of stainless steel (hygienic design) - Emergency stop, hygienic design - 5 B&R illuminated ring keys, 4-color (4x yellow, green, red, white and 1x yellow, green, red, blue) - Prepared for mounting on Rittal CP-S stainless steel swing arm system (flange not included in delivery) - Flange possible on top or bottom - USB port on back - RFID read/write unit	85
	<b>System units</b>	
5PPC2100.BY01-000	PPC2100 system unit - Intel Atom E3815 1.46 GHz - Single core - 1 GB SDRAM - For Automation Panel 923/933/1000	93
5PPC2100.BY11-000	PPC2100 system unit - Intel Atom E3825 1.33 GHz - Dual core - 1 GB SDRAM - For Automation Panel 923/933/1000	93
5PPC2100.BY22-000	PPC2100 system unit - Intel Atom E3826 1.46 GHz - Dual core - 2 GB SDRAM - For Automation Panel 923/933/1000	93
5PPC2100.BY34-000	PPC2100 system unit - Intel Atom E3827 1.75 GHz - Dual core - 4 GB SDRAM - For Automation Panel 923/933/1000	93
5PPC2100.BY44-000	PPC2100 system unit - Intel Atom E3845 1.91 GHz - Quad core - 4 GB SDRAM - For Automation Panel 923/933/1000	93
5PPC2100.BY48-000	PPC2100 system unit - Intel Atom E3845 1.91 GHz - Quad core - 8 GB SDRAM - For Automation Panel 923/933/1000	93
5PPC2200.AL02-000	PPC2200 system unit - Intel Atom E3930 1.30 GHz - Dual core - 2 GB SDRAM	96
5PPC2200.AL04-000	PPC2200 system unit - Intel Atom E3930 1.30 GHz - Dual core - 4 GB SDRAM	96
5PPC2200.AL14-000	PPC2200 system unit - Intel Atom E3940 1.60 GHz - Quad core - 4 GB SDRAM	96
5PPC2200.AL18-000	PPC2200 system unit - Intel Atom E3940 1.60 GHz - Quad core - 8 GB SDRAM	96



## 4 Technical data

### 4.1 Complete system

#### 4.1.1 Connection options

The Automation Panel can be connected to a B&R industrial PC via SDL, DVI SDL3 or SDL4 operations. The connection options described below provide an overview of the operating modes and possible limitations.

##### 4.1.1.1 SDL operation

###### 4.1.1.1.1 SDL operation without USB cable (mode 1)

With this connection option, all communication between the Automation Panel and B&R industrial PC takes place via a single SDL cable.

In addition to the display data, information from the touch screen, matrix keys, LEDs and service/diagnostic data is transferred. The Automation Panel can be installed up to away from the B&R industrial PC. USB 1.1 is also transferred over this distance and fully integrated into SDL. External adapter modules are not required.

The brightness of the display can be set via the ADI Control Center, for example.

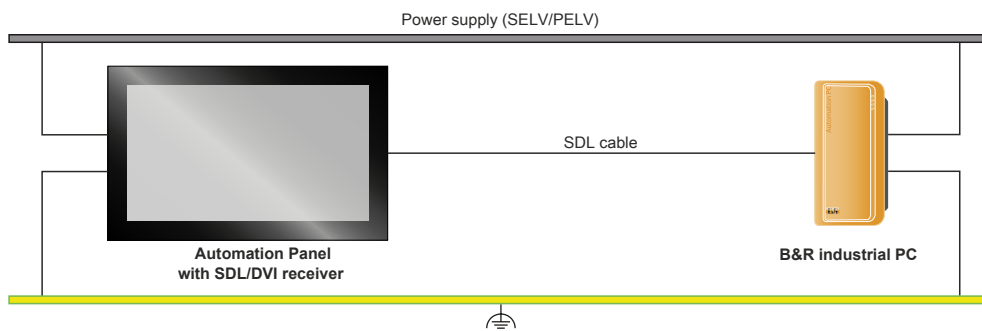

##### Availability of the interfaces on the Automation Panel with SDL/DVI receiver:

Panel In	✓	USB In	✗	Power supply	✓	Brightness controls	✗
USB1, USB2	✓	COM interface for touch screen	✗	Grounding	✓		

##### Requirements

- Automation Panel with SDL/DVI receiver
- B&R industrial PC with SDL interface
- SDL cable

#### 4.1.1.1.2 SDL operation with USB cable (mode 2)

With this connection option, communication between the Automation Panel and B&R industrial PC takes place via an SDL cable that is connected to interface "Panel In" and a USB type A/B cable that is connected to interface "USB In".

Display data as well as information from the resistive touch screen keys, matrix keys, LEDs and service/diagnostic data is transferred via the SDL cable. The touch screen data from the multi-touch screen is transferred via the USB type A/B cable. The Automation Panel can be installed up to 5 m (USB specification) away from the B&R industrial PC. USB 2.0 can be transferred over this distance via the USB type A/B cable. External adapter modules are not required.

The brightness of the display can be set via the ADI Control Center, for example.

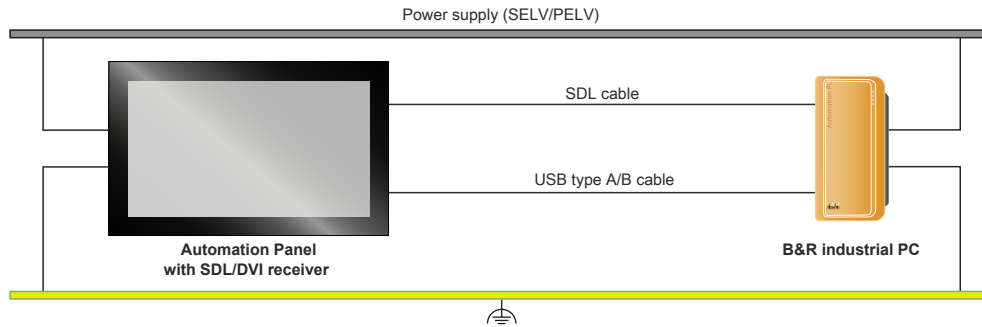

**Availability of the interfaces on the Automation Panel with SDL/DVI receiver:**

Panel In	✓	USB In	✓	USB 2.0	✓	Power supply	✓	Brightness controls	✗
USB1, USB2	✓	USB 2.0	✓	COM interface for touch screen	✗	Grounding	✓		

Maximum cable length: 5 m

**Requirements**

- Automation Panel with SDL/DVI receiver
- B&R industrial PC with SDL interface
- SDL cable, USB type A/B cable

### 4.1.1.2 DVI operation

In DVI operation, all signals needed to operate the Automation Panel are transferred via a separate cable. The brightness of the display can be set using the brightness buttons.

#### 4.1.1.2.1 DVI operation with single-touch Automation Panel

If an Automation Panel with resistive touch screen (single-touch) is operated with DVI, a DVI, USB type A/B and RS232 cable must be connected.

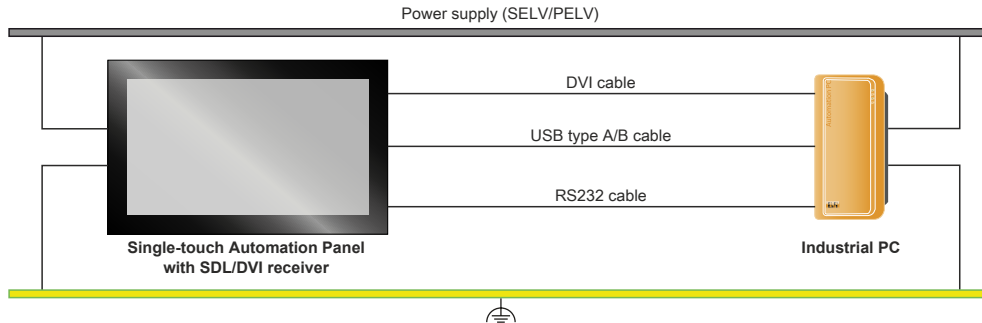

**Availability of the interfaces on the Automation Panel with SDL/DVI receiver:**

Panel In	✓	USB In	✓ USB 2.0	Power supply	✓	Brightness controls	✓
USB1, USB2	✓ USB 2.0	COM interface for touch screen	✓	Grounding	✓		

Maximum cable length: 5 m

**Requirements**

- Automation Panel with SDL/DVI receiver
- Industrial PC with DVI interface
- DVI cable, USB type A/B cable, RS232 cable

#### 4.1.1.2.2 DVI operation with multi-touch Automation Panel

If an Automation Panel with PCT touch screen (multi-touch) is operated with DVI, a DVI and USB type A/B cable must be connected.

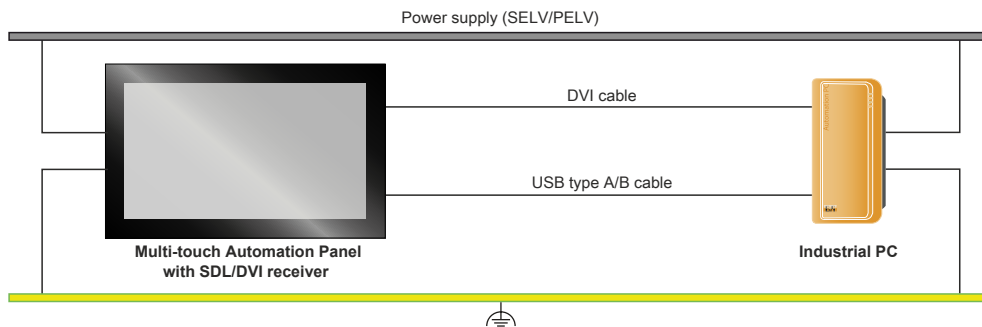

**Availability of the interfaces on the Automation Panel with SDL/DVI receiver:**

Panel In	✓	USB In	✓ USB 2.0	Power supply	✓	Brightness controls	✓
USB1, USB2	✓ USB 2.0	COM interface for touch screen	x	Grounding	✓		

Maximum cable length: 5 m

**Requirements**

- Automation Panel with SDL/DVI receiver
- Industrial PC with DVI interface
- DVI cable, USB type A/B cable

#### 4.1.1.2.3 General limitations/characteristics

- Key and LED data is not transferred.
- Data from operating elements is not transferred.
- Service and diagnostic data is not transferred.
- The maximum cable length is limited to 5 m.
- Upgrading the firmware of Automation Panels is not possible.

### 4.1.1.3 SDL3 operation

Smart Display Link 3 (SDL3) technology transfers all communication channels between a B&R industrial PC and panel up to 100 m over a standard Ethernet cable (min. Cat 6a). An RJ45 connector is used for the device connection, which is ideal for confined spaces in feed-throughs and swing arm systems.

#### 4.1.1.3.1 SDL3 operation with SDL3 transmitter

In SDL3 operation with an SDL3 transmitter in the B&R industrial PC, all communication between the Automation Panel and B&R industrial PC takes place via a single SDL3 cable.

In addition to the display data, information from the touch screen, matrix keys, LEDs and service/diagnostic data is transferred. The Automation Panel can be installed up to 100 m away from the B&R industrial PC. USB 2.0 is also transferred over this distance and fully integrated into SDL3. External adapter modules are not required.

The brightness of the display can be set via the ADI Control Center.

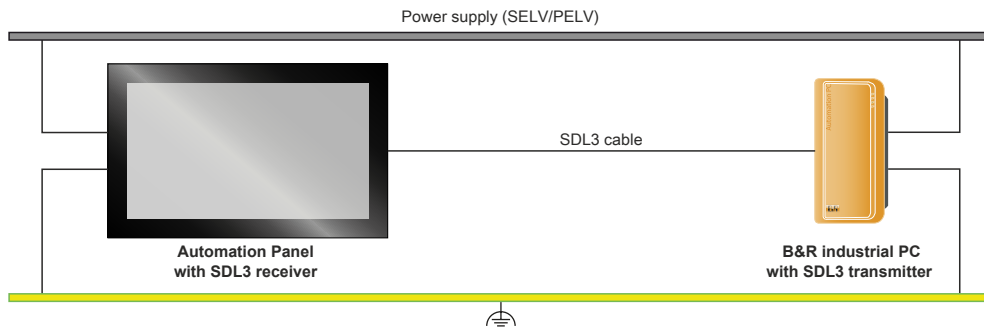

**Availability of interfaces on Automation Panels with an SDL3 receiver:**

SDL3 interface ✓      USB1, USB2 ✓      USB 2.0      Power supply ✓      Grounding ✓

Maximum cable length for SDL3: 100 m

#### Requirements

- Automation Panel with SDL3 receiver
- B&R industrial PC with SDL3 interface
- SDL3/SDL4 cable

#### 4.1.1.3.2 General limitations/characteristics

- USB 2.0 transfer is limited to 30 Mbit/s with SDL3.
- A display is always emulated by the SDL3 transmitter using EDID data and hot plug detection, so DVI-compatible operation is possible. For this reason, the following behavior may occur during operation with multiple displays. In the operating system, a connected panel is reported by the video driver even in the following situations:
  - No SDL3/SDL4 cable is connected.
  - There is no connection established yet between the SDL3 link module and SDL3 transmitter.

This behavior can be avoided by appropriate configuration in BIOS or via the graphics driver.

#### 4.1.1.4 SDL4 operation

Smart Display Link 4 (SDL4) technology transfers all communication channels between a B&R industrial PC and panel up to 100 m over a standard Ethernet cable (min. Cat 6a). An RJ45 connector is used for the device connection, which is ideal for confined spaces in feed-throughs and swing arm systems.

##### 4.1.1.4.1 SDL4 operation with SDL4 transmitter

In SDL4 operation with an SDL4 transmitter in the B&R industrial PC, all communication between the Automation Panel and B&R industrial PC takes place via a single SDL4 cable.

In addition to the display data, information from the touch screen, matrix keys, LEDs and service/diagnostic data is transferred. The Automation Panel can be installed up to 100 m away from the B&R industrial PC. USB 2.0 is also transferred over this distance and fully integrated into SDL4. External adapter modules are not required.

The brightness of the display can be set via the ADI Control Center, for example.

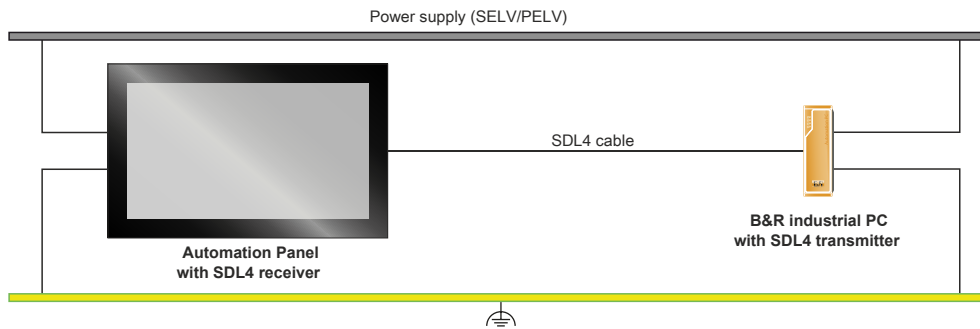

**Availability of the interfaces on the Automation Panel with SDL4 receiver:**

SDL4 interface ✓      USB1, USB2 ✓      USB 2.0      Power supply ✓      Grounding ✓

Maximum cable length for SDL4: 100 m

#### Requirements

- Automation Panel with SDL4 receiver
- B&R industrial PC with SDL4 interface
- SDL3/SDL4 cable

##### 4.1.1.4.2 General limitations

- USB 2.0 transfer is limited to 150 Mbit/s with SDL4.
- A display is always emulated by the SDL4 transmitter using EDID data and hot plug detection, so DVI-compatible operation is possible. For this reason, the following behavior may occur during operation with multiple displays.

In the operating system, a connected panel is reported by the video driver even in the following situations:

- No SDL3/SDL4 cable is connected.
- There is no connection established yet between the SDL4 link module and SDL4 transmitter.

This behavior can be avoided by appropriate configuration in BIOS or via the graphics driver.

## 4.1.2 Electrical properties

### 4.1.2.1 Power calculation

#### 4.1.2.1.1 Power calculation with link module

In order to calculate the total power of the Automation Panel, the power rating of the display being used must be added to the power rating of the link module being used.

#### Information:

Unless otherwise specified, the following values are maximum values and additional consumers (e.g. USB devices) are not taken into account.

Type	Order number	Total power consumption of link module
SDL/DVI receiver	5DLSDL.1001-00	Max. 3.6 W (without USB consumer) Max. 8.6 W (with USB consumer)
SDL3 receiver	5DLSD3.1001-00	Max. 8.1 W (without USB consumer) Max. 13.1 W (with USB consumer)
SDL4 receiver	5DLSD4.1001-00	Max. 8.1 W (without USB consumer) Max. 13.1 W (with USB consumer)

## Panels

Type	Order number	+5 V	+3.3 V	+12 V	Total power consumption
15" single-touch	5AP92D.1505-I00	-	2.1 W	8.9 W	11 W
15.6" multi-touch with operating elements	5AP99D.156B-B62	3.35 W	-	10.50 W	13.85 W
18.5" multi-touch	5AP93D.185B-B62	6.10 W	-	10.80 W	16.90 W
18.5" multi-touch with operating elements	5AP99D.185B-B62	6.10 W	-	10.80 W	16.90 W
18.5" multi-touch with operating elements	5AP99D.185C-B62	6.10 W	-	19.20 W	25.30 W
19" single-touch	5AP92D.1906-I00	5 W	-	22 W	27 W
21.5" multi-touch with operating elements	5AP99D.215C-B62	7.40 W	-	18.30 W	25.70 W
24.0" multi-touch	5AP93D.240C-B62	6.35 W	-	24.00 W	30.35 W

#### Example:

15.6" 5AP99D.156B-B62 panel	3.35 W + 10.50 W =	13.85 W
5DLSDL.1001-00 SDL/DVI receiver	8.6 W (with USB consumers)	8.60 W
	<b>Total max.:</b>	<b>22.45 W</b>

#### 4.1.2.1.2 Power calculation with system unit PPC2100

In order to calculate the total power of the Automation Panel, the power rating of the display used must be added to the power rating of the system unit and the power rating of additional components (CFast card or interface option).

### Information:

Unless otherwise specified, the following values are maximum values and additional consumers (e.g. USB devices) are not taken into account.

Type	Model number	Total power consumption
PPC2100 E3815 1C 1.46 GHz	5PPC2100.BY01-002	12 W (without USB consumer) 22 W (with USB consumer)
PPC2100 E3825 2C 1.33 GHz	5PPC2100.BY11-002	13 W (without USB consumer) 23 W (with USB consumer)
PPC2100 E3826 2C 1.46 GHz	5PPC2100.BY22-002	15 W (without USB consumer) 25 W (with USB consumer)
PPC2100 E3827 2C 1.75 GHz	5PPC2100.BY34-002	17 W (without USB consumer) 27 W (with USB consumer)
PPC2100 E3845 4C 1.91 GHz	5PPC2100.BY44-002	19 W (without USB consumer) 29 W (with USB consumer)
PPC2100 E3845 4C 1.91 GHz	5PPC2100.BY48-002	20 W (without USB consumer) 30 W (with USB consumer)

### Panels

Type	Order number	+5 V	+3.3 V	+12 V	Total power consumption
15" single-touch	5AP92D.1505-I00	-	2.1 W	8.9 W	11 W
15.6" multi-touch with operating elements	5AP99D.156B-B62	3.35 W	-	10.50 W	13.85 W
18.5" multi-touch	5AP93D.185B-B62	6.10 W	-	10.80 W	16.90 W
18.5" multi-touch with operating elements	5AP99D.185B-B62	6.10 W	-	10.80 W	16.90 W
18.5" multi-touch with operating elements	5AP99D.185C-B62	6.10 W	-	19.20 W	25.30 W
19" single-touch	5AP92D.1906-I00	5 W	-	22 W	27 W
21.5" multi-touch with operating elements	5AP99D.215C-B62	7.40 W	-	18.30 W	25.70 W
24.0" multi-touch	5AP93D.240C-B62	6.35 W	-	24.00 W	30.35 W

### CFast cards

All data are maximum values of the current revision. <sup>2)</sup>

Type	Order number	+5 V	+3.3 V	+12 V	Total power consumption
SLC technology	5CFAST.xxxx-00	-	1.14 W	-	1.14 W
MLC technology	5CFAST.xxxx-10	-	2.03 W	-	2.03 W

### Interface options

Type	Order number	+5 V	+3.3 V	+12 V	Total power consumption
POWERLINK CAN X2X	5ACCIF01.FPCC-000	0.45 W	1.55 W	-	2.00 W
POWERLINK RS485 CAN	5ACCIF01.FPCS-000	0.75 W	1.00 W	-	1.75 W
POWERLINK	5ACCIF01.FPLK-000	-	1.75 W	-	1.75 W
POWERLINK RS232	5ACCIF01.FPLS-000	0.50 W	1.00 W	-	1.50 W
POWERLINK RS232	5ACCIF01.FPLS-001	-	1.50 W	-	1.50 W
POWERLINK RS232 CAN	5ACCIF01.FPSC-000	0.75 W	1.00 W	-	1.75 W
POWERLINK RS232 CAN X2X	5ACCIF01.FPSC-001	0.60 W	1.40 W	-	2.00 W
2x RS422/RS485	5ACCIF01.FSS0-000	0.80 W	0.20 W	-	1.00 W
CAN	5ACCIF01.ICAN-000	0.45 W	0.05 W	-	0.50 W
RS232	5ACCIF01.IS00-000	-	0.50 W	-	0.50 W

#### 4.1.2.1.2.1 Calculation example

15.6" 5AP99D.156B-B62 panel	3.35 W + 10.5 W	13.85 W
5PPC2100.BY11-002 system unit	23.00 W (with USB consumers)	23.00 W
POWERLINK interface option 5ACCIF01.FPLK-000	1.75 W	1.75 W
CFast card 5CFAST.xxxx-10	2.03 W	2.03 W
<b>Total max.:</b>		<b>40.63 W</b>

<sup>2)</sup> For detailed revision-dependent information, see [aggregate data sheet for CFast cards](#).



#### 4.1.2.1.3 Power calculation with system unit PPC2200

In order to calculate the total power of the Automation Panel, the power rating of the display used must be added to the power rating of the system unit and the power rating of additional components (CFast card or interface option).

### Information:

Unless otherwise specified, the following values are maximum values and additional consumers (e.g. USB devices) are not taken into account.

Type	Order number	Total power consumption of the system unit
PPC2200 E3930 2C 1.30 GHz	5PPC2200.AL02-000	15 W (without USB consumer) 25 W (with USB consumer)
PPC2200 E3930 2C 1.30 GHz	5PPC2200.AL04-000	15 W (without USB consumer) 25 W (with USB consumer)
PPC2200 E3940 4C 1.60 GHz	5PPC2200.AL14-000	20 W (without USB consumer) 30 W (with USB consumer)
PPC2200 E3940 4C 1.60 GHz	5PPC2200.AL18-000	20 W (without USB consumer) 30 W (with USB consumer)

### Panels

Type	Order number	+5 V	+3.3 V	+12 V	Total power consumption
15" single-touch	5AP92D.1505-I00	-	2.1 W	8.9 W	11 W
15.6" multi-touch with operating elements	5AP99D.156B-B62	3.35 W	-	10.50 W	13.85 W
18.5" multi-touch	5AP93D.185B-B62	6.10 W	-	10.80 W	16.90 W
18.5" multi-touch with operating elements	5AP99D.185B-B62	6.10 W	-	10.80 W	16.90 W
18.5" multi-touch with operating elements	5AP99D.185C-B62	6.10 W	-	19.20 W	25.30 W
19" single-touch	5AP92D.1906-I00	5 W	-	22 W	27 W
21.5" multi-touch with operating elements	5AP99D.215C-B62	7.40 W	-	18.30 W	25.70 W
24.0" multi-touch	5AP93D.240C-B62	6.35 W	-	24.00 W	30.35 W

### CFast cards

Type	Order number	+5 V	+3.3 V	+12 V	Total power consumption
SLC technology	5CFAST.xxxx-00	-	1.14 W	-	1.14 W
MLC technology	5CFAST.xxxx-10	-	2.03 W	-	2.03 W

### Interface options

Type	Order number	+5 V	+ 3.3 V	+12 V	Total power consumption
POWERLINK CAN X2X	5ACCIF01.FPCC-000	0.45 W	1.55 W	-	2 W
POWERLINK RS485 CAN	5ACCIF01.FPCS-000	0.75 W	1 W	-	1.75 W
POWERLINK	5ACCIF01.FPLK-000	-	1.75 W	-	1.75 W
POWERLINK RS232	5ACCIF01.FPLS-000	0.5 W	1 W	-	1.5 W
POWERLINK RS232	5ACCIF01.FPLS-001	-	1.5 W	-	1.5 W
POWERLINK RS232 CAN	5ACCIF01.FPSC-000	0.75 W	1 W	-	1.75 W
POWERLINK RS232 CAN X2X	5ACCIF01.FPSC-001	0.6 W	1.4 W	-	2 W
2x RS422/RS485	5ACCIF01.FSS0-000	0.8 W	0.2 W	-	1 W
CAN	5ACCIF01.ICAN-000	0.45 W	0.05 W	-	0.5 W
1x RS232	5ACCIF01.IS00-000	-	0.5 W	-	0.5 W
2x ETH 10/100/1000	5ACCIF03.CETH-000	-	2 W	-	2 W

#### 4.1.2.1.3.1 Calculation example

15.6" 5AP99D.156B-B62 panel	3.35 W + 10.5 W	13.85 W
System unit 5PPC2200.AL14-000	20.00 W (without USB consumers)	20.00 W
POWERLINK interface option 5ACCIF01.FPLK-000	1.75 W	1.75 W
CFast card 5CFAST.xxxx-10	2.03 W	2.03 W
<b>Total max.:</b>		<b>37.63 W</b>

### 4.1.3 Environmental properties

#### 4.1.3.1 Temperature specifications

Because it is possible to combine different , the following table provides a component-dependent overview of the maximum ambient temperatures resulting from these combinations.

#### **Information:**

**The maximum specified ambient temperatures for operation were determined under worst-case conditions. Experience has shown that higher ambient temperatures can be achieved with typical applications in Microsoft Windows, for example. The relevant test and assessment must be carried out individually by the user on site (reading out the temperatures in BIOS or using the B&R Control Center, for example).**

#### **Information about worst-case conditions**

- Thermal Analysis Tool (TAT) from Intel for simulating processor utilization (100% CPU, 100% memory, 100% graphic)
- BurnInTest 7.1 from PassMark Software for simulating 100% interface utilization using loopback adapters (100% network)
- 2x 1 A USB load
- Maximum expansion and power consumption of the system
- 100% display brightness

### 4.1.3.1.1 System unit

#### 4.1.3.1.1.1 Maximum ambient temperature for worst-case operation PPC2100

All temperature specifications in degrees Celsius [°C] at 500 m above sea level, <b>non-condensing</b> .		Maximum worst-case ambient temperature (system unit 5PPC2100.BYxx-000)		
The respective ambient temperature is typically derated 1°C per 1000 meters starting at 500 m above sea level.		5PPC2100.BY01-000 (E3815 1.46 GHz)	5PPC2100.BY11-000 (E3825 1.33 GHz)	5PPC2100.BY22-000 (E3826 1.46 GHz)
		50	50	50
<b>Maximum ambient temperature (accessories)</b>				
AP9xD panel	5AP92D.1505-I00	✓	✓	✓
	5AP92D.1906-I00	45	45	45
	5AP93D.185B-B62	40	40	35
	5AP93D.240C-B62	40	40	40
	5AP99D.156B-B62	40	40	35
	5AP99D.185B-B62	40	40	35
	5AP99D.185C-B62	40	40	35
	5AP99D.215C-B62	40	40	40
CFast card	5CFAST.xxxx-00 ≥ E0	✓	✓	✓
	5CFAST.xxxx-10	✓	✓	✓
Interface option	5ACCIF01.FPCC-000	✓	✓	✓
	5ACCIF01.FPCS-000	✓	✓	✓
	5ACCIF01.FPLK-000	✓	✓	✓
	5ACCIF01.FPLS-000	✓	✓	✓
	5ACCIF01.FPLS-001	✓	✓	✓
	5ACCIF01.FPSC-000	✓	✓	✓
	5ACCIF01.FPSC-001	✓	✓	✓
	5ACCIF01.FSS0-000	✓	✓	✓
	5ACCIF01.ICAN-000	✓	✓	✓
	5ACCIF01.IS00-000	✓	✓	✓

All temperature specifications in degrees Celsius [°C] at 500 m above sea level, <b>non-condensing</b> .		Maximum worst-case ambient temperature (system unit 5PPC2100.BYxx-000)		
The respective ambient temperature is typically derated 1°C per 1000 meters starting at 500 m above sea level.		5PPC2100.BY34-000 (E3827 1.75 GHz)	5PPC2100.BY44-000 (E3845 1.91 GHz)	5PPC2100.BY48-000 (E3845 1.91 GHz)
		50	50	50
<b>Maximum ambient temperature (accessories)</b>				
AP9xD panel	5AP92D.1505-I00	✓	45	45
	5AP92D.1906-I00	45	45	45
	5AP93D.185B-B62	35	35	35
	5AP93D.240C-B62	40	35	35
	5AP99D.156B-B62	35	35	35
	5AP99D.185B-B62	35	35	35
	5AP99D.185C-B62	35	35	35
	5AP99D.215C-B62	40	40	40
CFast card	5CFAST.xxxx-00 ≥ E0	✓	✓	✓
	5CFAST.xxxx-10	✓	✓	✓
Interface option	5ACCIF01.FPCC-000	✓	✓	✓
	5ACCIF01.FPCS-000	✓	✓	✓
	5ACCIF01.FPLK-000	✓	✓	✓
	5ACCIF01.FPLS-000	✓	✓	✓
	5ACCIF01.FPLS-001	✓	✓	✓
	5ACCIF01.FPSC-000	✓	✓	✓
	5ACCIF01.FPSC-001	✓	✓	✓
	5ACCIF01.FSS0-000	✓	✓	✓
	5ACCIF01.ICAN-000	✓	✓	✓
	5ACCIF01.IS00-000	✓	✓	✓

### 4.1.3.1.1.2 Maximum ambient temperature for worst-case operation PPC2200

All temperature specifications in degrees Celsius [°C] at 500 m above sea level, <b>non-condensing</b> .		Maximum worst-case ambient temperature (system unit 5PPC2200.ALxx-000)			
The respective ambient temperature is typically derated 1°C per 1000 meters starting at 500 m above sea level.		5PPC2200.AL02-000 (E3930 1.3 GHz)	5PPC2200.AL04-000 (E3930 1.3 GHz)	5PPC2200.AL14-000 (E3940 1.6 GHz)	5PPC2200.AL18-000 (E3940 1.6 GHz)
<b>Maximum ambient temperature (accessories)</b>		<b>55</b>	<b>55</b>	<b>50</b>	<b>50</b>
AP9xD panel	5AP92D.1505-I00	✓	✓	45	45
	5AP92D.1906-I00	45	45	45	45
	5AP93D.185B-B62	40	40	35	35
	5AP93D.240C-B62	40	40	35	35
	5AP99D.156B-B62	40	40	35	35
	5AP99D.185B-B62	40	40	35	35
	5AP99D.215C-B62	40	40	40	40
CFast card	5CFAST.xxxx-00 ≥ E0	✓	✓	✓	✓
	5CFAST.xxxx-10	✓	✓	✓	✓
Interface option	5ACCIF01.FPCC-000	✓	✓	✓	✓
	5ACCIF01.FPCS-000	✓	✓	✓	✓
	5ACCIF01.FPLK-000	✓	✓	✓	✓
	5ACCIF01.FPLS-000	✓	✓	✓	✓
	5ACCIF01.FPLS-001	✓	✓	✓	✓
	5ACCIF01.FPSC-000	✓	✓	✓	✓
	5ACCIF01.FPSC-001	✓	✓	✓	✓
	5ACCIF01.FSS0-000	✓	✓	✓	✓
	5ACCIF01.ICAN-000	✓	✓	✓	✓
	5ACCIF01.IS00-000	✓	✓	✓	✓
5ACCIF03.CETH-000	✓	✓	✓	✓	

### 4.1.3.1.2 Link module

#### 4.1.3.1.2.1 Maximum ambient temperature for worst-case operation

All temperature specifications in degrees Celsius [°C] at 500 m above sea level, <b>non-condensing</b> .		Link module		
The respective ambient temperature is typically derated 1°C per 1000 meters starting at 500 m above sea level.		5DLSDL.1001-00 SDL/DVI	5DLSD3.1001-00 SDL3	5DLSD4.1001-00 SDL4
<b>Maximum ambient temperature</b>		<b>45</b>	<b>45</b>	<b>45</b>
APxD panel	5AP92D.1505-I00	✓	✓	✓
	5AP92D.1906-I00	✓	✓	✓
	5AP93D.185B-B62	✓	✓	✓
	5AP93D.240C-B62	40	40	40
	5AP99D.156B-B62	✓	✓	✓
	5AP99D.185B-B62	✓	✓	✓
	5AP99D.215C-B62	40	40	40

### 4.1.3.2 Minimum ambient temperature during operation

The Automation Panels in the hygienic design are only permitted to be operated at 0°C or higher.

### 4.1.3.3 Temperature during storage and transport

The following table provides an overview of the minimum and maximum ambient temperatures for storing and transporting the complete system. Limitations are possible due to individual components.

#### Panels

Type	Order number	Storage [°C]	Transport [°C]
15" single-touch	5AP92D.1505-I00	-20 to 70	-20 to 70
15.6" multi-touch with operating elements	5AP99D.156B-B62	-25 to 70	-25 to 70
18.5" multi-touch	5AP93D.185B-B62	-20 to 60	-20 to 60
18.5" multi-touch with operating elements	5AP99D.185B-B62	-20 to 60	-20 to 60
18.5" multi-touch with operating elements	5AP99D.185C-B62	-20 to 60	-20 to 60
19" single-touch	5AP92D.1906-I00	-20 to 70	-20 to 70
21.5" multi-touch with operating elements	5AP99D.215C-B62	-20 to 60	-20 to 60
24" multi-touch	5AP93D.240C-B62	-25 to 70	-25 to 70

#### Link modules

Type	Model number	Storage [°C]	Transport [°C]
SDL/DVI receiver	5DLSDL.1001-00	-20 to 60	-20 to 60
SDL3 receiver	5DLS3.1001-00	-20 to 60	-20 to 60
SDL4 receiver	5DLS4.1001-00	-20 to 60	-20 to 60

#### PPC2100 system unit

Component	Model number	Storage [°C]	Transport [°C]
System units	5PPC2100.BYxx-000	-20 to 60	-20 to 60
CFast cards	5CFAST.xxxx-00	-50 to 100	-50 to 100
	5CFAST.032G-10 ≥ Rev. G0	-40 to 85	-40 to 85
	5CFAST.064G-10 ≥ Rev. E0	-40 to 85	-40 to 85
	5CFAST.128G-10 ≥ Rev. E0	-40 to 85	-40 to 85
	5CFAST.032G-10 ≤ Rev. F0	-55 to 95	-55 to 95
	5CFAST.064G-10 ≤ Rev. D0	-55 to 95	-55 to 95
	5CFAST.128G-10 ≤ Rev. D0	-55 to 95	-55 to 95
	5CFAST.256G-10	-40 to 85	-40 to 85
Interface options	5ACCIF01.FPCC-000	-20 to 60	-20 to 60
	5ACCIF01.FPCS-000	-20 to 60	-20 to 60
	5ACCIF01.FPLK-000	-20 to 60	-20 to 60
	5ACCIF01.FPLS-000	-20 to 60	-20 to 60
	5ACCIF01.FPLS-001	-20 to 60	-20 to 60
	5ACCIF01.FPSC-000	-20 to 60	-20 to 60
	5ACCIF01.FPSC-001	-20 to 60	-20 to 60
	5ACCIF01.FSS0-000	-20 to 60	-20 to 60
	5ACCIF01.ICAN-000	-20 to 60	-20 to 60
5ACCIF01.IS00-000	-20 to 60	-20 to 60	

#### PPC2200 system unit

Type	Model number	Storage [°C]	Transport [°C]
System units	5PPC2200.ALxx-000	-25 to 60	-25 to 60
CFast cards	5CFAST.xxxx-00	-50 to 100	-50 to 100
	5CFAST.032G-10 ≥ Rev. G0	-40 to 85	-40 to 85
	5CFAST.064G-10 ≥ Rev. E0	-40 to 85	-40 to 85
	5CFAST.128G-10 ≥ Rev. E0	-40 to 85	-40 to 85
	5CFAST.032G-10 ≤ Rev. F0	-55 to 95	-55 to 95
	5CFAST.064G-10 ≤ Rev. D0	-55 to 95	-55 to 95
	5CFAST.128G-10 ≤ Rev. D0	-55 to 95	-55 to 95
	5CFAST.256G-10	-40 to 85	-40 to 85
Interface options	5ACCIF01.FPCC-000	-20 to 60	-20 to 60
	5ACCIF01.FPCS-000	-20 to 60	-20 to 60
	5ACCIF01.FPLK-000	-20 to 60	-20 to 60
	5ACCIF01.FPLS-000	-20 to 60	-20 to 60
	5ACCIF01.FPLS-001	-20 to 60	-20 to 60
	5ACCIF01.FPSC-000	-20 to 60	-20 to 60
	5ACCIF01.FPSC-001	-20 to 60	-20 to 60
	5ACCIF01.FSS0-000	-20 to 60	-20 to 60
	5ACCIF01.ICAN-000	-20 to 60	-20 to 60
5ACCIF01.IS00-000	-20 to 60	-20 to 60	
5ACCIF03.CETH-000	-20 to 60	-20 to 60	

#### 4.1.3.4 Temperature sensor positions

Temperatures<sup>3)</sup> can be read out in BIOS or Microsoft Windows operating systems via the B&R Control Center.



Figure 1: Automation Panel 9xD - Temperature sensor position

ADI sensors	Position	Measuring point for	Measurement	Max. specified [°C]
Panel	A	Display	Temperature of the display (sensor integrated on the panel).	5AP92D.1505-I00: 85 5AP99D.156B-B62: 75 5AP93D.185B-B62: 70 5AP99D.185B-B62: 70 5AP99D.185C-B62: 70 5AP92D.1906-I00: 80 5AP99D.215C-B62: 75 5AP93D.240C-B62: 70

<sup>3)</sup> The measured temperature is a guide value for the immediate ambient temperature, but it may have been influenced by neighboring components.

### 4.1.3.5 Relative humidity

The following tables show the minimum and maximum relative humidity (at 30°C, non-condensing) of the individual components that are relevant for limiting the humidity of the complete system. The smallest or largest value must always be used for this determination. For more detailed information, see technical data or temperature/humidity diagrams of the individual components.

#### Panels

Panel type	Order number	Operation [%]	Storage [%]	Transport [%]
15" single-touch	5AP92D.1505-I00	8 to 90	8 to 90	8 to 90
15.6" multi-touch with operating elements	5AP99D.156B-B62	5 to 90	5 to 90	5 to 90
18.5" multi-touch	5AP93D.185B-B62	5 to 90	5 to 90	5 to 90
18.5" multi-touch with operating elements	5AP99D.185B-B62	5 to 90	5 to 90	5 to 90
18.5" multi-touch with operating elements	5AP99D.185C-B62	5 to 90	5 to 90	5 to 90
19" single-touch	5AP92D.1906-I00	5 to 90	5 to 90	5 to 90
21.5" multi-touch with operating elements	5AP99D.215C-B62	10 to 90	10 to 90	10 to 90
24" multi-touch	5AP93D.240C-B62	5 to 90	5 to 90	5 to 90

#### Link modules

Type	Order number	Operation [%]	Storage [%]	Transport [%]
SDL/DVI receiver	5DLSDL.1001-00	5 to 90	5 to 95	5 to 95
SDL3 receiver	5DLS3D.1001-00	5 to 90	5 to 95	5 to 95
SDL4 receiver	5DLS4D.1001-00	5 to 90	5 to 95	5 to 95

#### PPC2100 system units

Component	Order number	Operation [%]	Storage [%]	Transport [%]
System units	5PPC2100.BYxx-000	5 to 90	5 to 95	5 to 95
CFast cards	5CFAST.xxxx-00	Max. 85% at 85°C	Max. 85% at 85°C	Max. 85% at 85°C
	5CFAST.032G-10 ≥ Rev. G0	Max. 85% at 85°C	Max. 85% at 85°C	Max. 85% at 85°C
	5CFAST.064G-10 ≥ Rev. E0	Max. 85% at 85°C	Max. 85% at 85°C	Max. 85% at 85°C
	5CFAST.128G-10 ≥ Rev. E0	Max. 85% at 85°C	Max. 85% at 85°C	Max. 85% at 85°C
	5CFAST.032G-10 ≤ Rev. F0	10 to 95	10 to 95	10 to 95
	5CFAST.064G-10 ≤ Rev. D0	10 to 95	10 to 95	10 to 95
	5CFAST.128G-10 ≤ Rev. D0	10 to 95	10 to 95	10 to 95
	5CFAST.256G-10	Max. 85% at 85°C	Max. 85% at 85°C	Max. 85% at 85°C
Interface options	5ACCIF01.FPCC-000	5 to 90	5 to 95	5 to 95
	5ACCIF01.FPCS-000	5 to 90	5 to 95	5 to 95
	5ACCIF01.FPLK-000	5 to 90	5 to 95	5 to 95
	5ACCIF01.FPLS-000	5 to 90	5 to 95	5 to 95
	5ACCIF01.FPLS-001	5 to 90	5 to 95	5 to 95
	5ACCIF01.FPSC-000	5 to 90	5 to 95	5 to 95
	5ACCIF01.FPSC-001	5 to 90	5 to 95	5 to 95
	5ACCIF01.FSS0-000	5 to 90	5 to 95	5 to 95
	5ACCIF01.ICAN-000	5 to 90	5 to 95	5 to 95
5ACCIF01.IS00-000	5 to 90	5 to 95	5 to 95	

#### PPC2200 system units

Component	Order number	Operation [%]	Storage [%]	Transport [%]
System units	5PPC2200.ALxx-000	5 to 90	5 to 95	5 to 95
CFast cards	5CFAST.xxxx-00	Max. 85% at 85°C	Max. 85% at 85°C	Max. 85% at 85°C
	5CFAST.032G-10 ≥ Rev. G0	Max. 85% at 85°C	Max. 85% at 85°C	Max. 85% at 85°C
	5CFAST.064G-10 ≥ Rev. E0	Max. 85% at 85°C	Max. 85% at 85°C	Max. 85% at 85°C
	5CFAST.128G-10 ≥ Rev. E0	Max. 85% at 85°C	Max. 85% at 85°C	Max. 85% at 85°C
	5CFAST.032G-10 ≤ Rev. F0	10 to 95	10 to 95	10 to 95
	5CFAST.064G-10 ≤ Rev. D0	10 to 95	10 to 95	10 to 95
	5CFAST.128G-10 ≤ Rev. D0	10 to 95	10 to 95	10 to 95
	5CFAST.256G-10	Max. 85% at 85°C	Max. 85% at 85°C	Max. 85% at 85°C
Interface options	5ACCIF01.FPCC-000	5 to 90	5 to 95	5 to 95
	5ACCIF01.FPCS-000	5 to 90	5 to 95	5 to 95
	5ACCIF01.FPLK-000	5 to 90	5 to 95	5 to 95
	5ACCIF01.FPLS-000	5 to 90	5 to 95	5 to 95
	5ACCIF01.FPLS-001	5 to 90	5 to 95	5 to 95
	5ACCIF01.FPSC-000	5 to 90	5 to 95	5 to 95
	5ACCIF01.FPSC-001	5 to 90	5 to 95	5 to 95
	5ACCIF01.FFS0-000	5 to 90	5 to 95	5 to 95
	5ACCIF01.ICAN-000	5 to 90	5 to 95	5 to 95
	5ACCIF01.IS00-000	5 to 90	5 to 95	5 to 95
5ACCIF03.CETH-000	5 to 90	5 to 95	5 to 95	

#### 4.1.3.6 Vibration and shock

The following table provides an overview of the maximum vibrations and shock values of the complete system. Limitations are possible due to individual components.

Vibration			
	Operation	Storage <sup>1)</sup>	Transport <sup>1)</sup>
Automation Panel 9xD	9 to 200 Hz: 1 g (periodic)	30 g, 6 ms	30 g, 6 ms
Shock			
	Operation	Storage <sup>1)</sup>	Transport <sup>1)</sup>
Automation Panel 9xD	15 g, 11 ms (periodic)	2 to 8 Hz: 7.5 mm amplitude 8 to 200 Hz: 2 g 200 to 500 Hz: 4 g	2 to 8 Hz: 7.5 mm amplitude 8 to 200 Hz: 2 g 200 to 500 Hz: 4 g

1) The specifications refer to a device in its original packaging.



## 4.1.4 Encoder interface link module

### 4.1.4.1 SDL/DVI receiver (5DLSDL.1001-00)

#### 4.1.4.1.1 Overview

#### Information:

For information about SDL/DVI operation, see section ["SDL operation" on page 17](#) or ["DVI operation" on page 19](#).

The interfaces available on the device or module are numbered for the purpose of clear differentiation. The numbering used by the operating system may deviate, however.

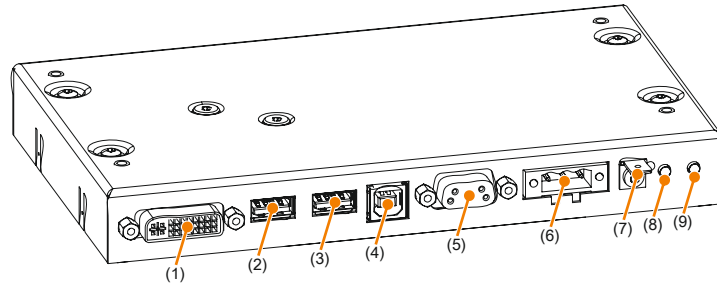

No.	Interface name	Chapter	No.	Interface name	Chapter
1	Panel In SDL/DVI	"Panel In interface"	6	Power 24 VDC	"+24 VDC power supply"
2	USB1	"USB interfaces"	7	Grounding	"Grounding"
3	USB2	"USB interfaces"	8	Brightness (DVI) +	"Brightness controls"
4	USB In	"USB In interface"	9	Brightness (DVI) -	"Brightness controls"
5	COM	"Serial interface"			

#### 4.1.4.1.2 +24 VDC power supply

#### Danger!

This device is only permitted to be supplied by a SELV/PELV power supply unit or with safety extra-low voltage (SELV) per IEC 61010-2-201.

The necessary 3-pin connector is not included in delivery; for suitable accessories, see [0TB103.9x](#).

The device is protected against overload and reverse polarity by a soldered fuse (10 A, fast-acting). If the fuse is defective (e.g. due to overload), the device must be sent to B&R for repairs. If the polarity is reversed, it is not necessary to replace the fuse.

Pin	Description	Figure
1	-	
2	Functional ground	
3	+	
<ul style="list-style-type: none"> <li>Reverse polarity protection</li> <li>3-pin</li> <li>Male</li> </ul>		
<b>Electrical properties</b>		
Nominal voltage	24 VDC ±25%, SELV <sup>1)</sup>	
Nominal current	Max. 3 A	
Overvoltage category per EN 61131-2	II	
Galvanic isolation	Yes	
Uninterruptible power supply	No	

1) IEC 61010-2-201 requirements must be observed.

#### 4.1.4.1.3 Grounding

### Caution!

The functional ground (power supply pin 2 and ground connection) must be connected to the central grounding point (e.g. control cabinet or system) via the shortest possible path with the lowest possible resistance and with the largest possible wire cross section. This type of grounding is mandatory for proper functionality.

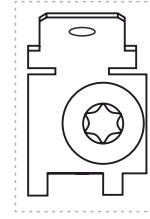

For example, a copper strip must be attached to the ground connection at a central grounding point of the control cabinet or system in which the device is installed. The wire cross section should be as large as possible (at least 2.5 mm<sup>2</sup>).

#### 4.1.4.1.4 Panel In interface

The interface is designed as a DVI-I connector (female) and can be operated with DVI-D or SDL transmission technology.

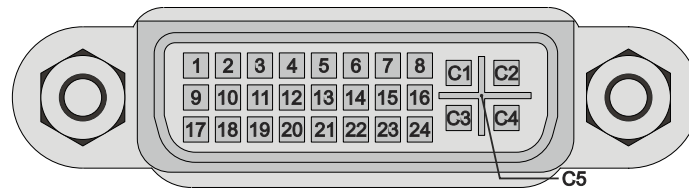

Pin	Pinout	Description	Pin	Pinout	Description
1	TMDS data 2-	DVI lane 2 (negative)	16	HPD	Hot plug detection
2	TMDS data 2+	DVI lane 2 (positive)	17	TMDS data 0-	DVI lane 0 (negative)
3	TMDS data 2/4 SHIELD	Shield for data pairs 2 and 4	18	TMDS data 0+	DVI lane 0 (positive)
4	SDL-	SDL lane (negative)	19	TMDS data 0/XUSB1 SHIELD	Shield of data pair 0 and USB1
5	SDL+	SDL lane (positive)	20	XUSB1-	USB lane 1 (negative)
6	DDC clock	DDC-based control signal (clock)	21	XUSB1+	USB lane 1 (positive)
7	DDC data	DDC-based control signal (data)	22	TMDS clock shield	Shield of clock pair
8			23	TMDS clock+	DVI clock (positive)
9	TMDS data 1-	DVI lane 1 (negative)	24	TMDS clock -	DVI clock (negative)
10	TMDS data 1+	DVI lane 1 (positive)	C1		
11	TMDS data 1/XUSB0 SHIELD	Shield of data pair 1 and USB0	C2		
12	XUSB0-	USB lane 0 (negative)	C3		
13	XUSB0+	USB lane 0 (positive)	C4		
14	+5 V power <sup>1)</sup>	+5 V power supply	C5		
15	Ground (return for +5 V, HSync and VSync)	Ground	-		-

1) Protected internally by a multifuse.

### Information:

**Hot plugging output devices on the interface for service purposes is supported by the hardware and graphic drivers of approved operating systems. Recalibration may be required for touch screen devices.**

**A maximum of 100 mating cycles are specified for this interface.**

It is important to note the following information about the transfer rate:

- In SDL operation without USB type A/B cable, the USB transfer rate is limited to USB 1.1.
- A USB transfer rate of USB 2.0 is possible in DVI or SDL operation with a USB type A/B cable.

#### 4.1.4.1.4.1 Cable lengths and resolutions for SDL transfer

The following table shows the relationship between segment length and maximum resolution depending on the SDL cable:

SDL cable Segment length [m]	Resolution						
	VGA 640 x 480	SVGA 800 x 600	XGA 1024 x 768	HD 1366 x 768	SXGA 1280 x 1024	UXGA 1600 x 1200	FHD 1920 x 1080
0.8	5CASDL.0008-00	5CASDL.0008-00	5CASDL.0008-00	5CASDL.0008-00	5CASDL.0008-00	5CASDL.0008-00	5CASDL.0008-00
1.8	5CASDL.0018-00	5CASDL.0018-00	5CASDL.0018-00	5CASDL.0018-00	5CASDL.0018-00	5CASDL.0018-00	5CASDL.0018-00
	5CASDL.0018-01	5CASDL.0018-01	5CASDL.0018-01	5CASDL.0018-01	5CASDL.0018-01	5CASDL.0018-01	5CASDL.0018-01
	5CASDL.0018-03	5CASDL.0018-03	5CASDL.0018-03	5CASDL.0018-03	5CASDL.0018-03	5CASDL.0018-03	5CASDL.0018-03
5	5CASDL.0050-00	5CASDL.0050-00	5CASDL.0050-00	5CASDL.0050-00	5CASDL.0050-00	5CASDL.0050-00	5CASDL.0050-00
	5CASDL.0050-01	5CASDL.0050-01	5CASDL.0050-01	5CASDL.0050-01	5CASDL.0050-01	5CASDL.0050-01	5CASDL.0050-01
	5CASDL.0050-03	5CASDL.0050-03	5CASDL.0050-03	5CASDL.0050-03	5CASDL.0050-03	5CASDL.0050-03	5CASDL.0050-03
6	5CASDL.0060-00	5CASDL.0060-00	5CASDL.0060-00	5CASDL.0060-00	5CASDL.0060-00	5CASDL.0060-00	5CASDL.0060-00
10	5CASDL.0100-00	5CASDL.0100-00	5CASDL.0100-00	5CASDL.0100-00	5CASDL.0100-00	5CASDL.0100-00	5CASDL.0100-00
	5CASDL.0100-01	5CASDL.0100-01	5CASDL.0100-01	5CASDL.0100-01	5CASDL.0100-01	5CASDL.0100-01	5CASDL.0100-01
	5CASDL.0100-03	5CASDL.0100-03	5CASDL.0100-03	5CASDL.0100-03	5CASDL.0100-03	5CASDL.0100-03	5CASDL.0100-03
15	5CASDL.0150-00	5CASDL.0150-00	5CASDL.0150-00	5CASDL.0150-00	5CASDL.0150-00	-	-
	5CASDL.0150-01	5CASDL.0150-01	5CASDL.0150-01	5CASDL.0150-01	5CASDL.0150-01	-	-
	5CASDL.0150-03	5CASDL.0150-03	5CASDL.0150-03	5CASDL.0150-03	5CASDL.0150-03	-	5CASDL.0150-03
20	5CASDL.0200-00	5CASDL.0200-00	5CASDL.0200-00	5CASDL.0200-00	5CASDL.0200-00	-	-
	5CASDL.0200-03	5CASDL.0200-03	5CASDL.0200-03	5CASDL.0200-03	5CASDL.0200-03	-	5CASDL.0200-03
	5CASDL.0250-00	5CASDL.0250-00	5CASDL.0250-00	5CASDL.0250-00	-	-	-
25	5CASDL.0250-03	5CASDL.0250-03	5CASDL.0250-03	5CASDL.0250-03	-	-	-
	5CASDL.0300-00	5CASDL.0300-00	-	-	-	-	-
	5CASDL.0300-03	5CASDL.0300-03	-	-	-	-	-
30	5CASDL.0300-00	5CASDL.0300-00	-	-	-	-	-
	5CASDL.0300-03	5CASDL.0300-03	5CASDL.0300-13	5CASDL.0300-13	5CASDL.0300-13	-	5CASDL.0300-13
	5CASDL.0400-13	5CASDL.0400-13	5CASDL.0400-13	5CASDL.0400-13	5CASDL.0400-13	-	5CASDL.0400-13
40	5CASDL.0400-13	5CASDL.0400-13	5CASDL.0400-13	5CASDL.0400-13	5CASDL.0400-13	-	5CASDL.0400-13

#### 4.1.4.1.4.2 Cable lengths and resolutions for DVI transfer

The following table shows the relationship between segment length and maximum resolution depending on the DVI cable:

DVI cable Segment length [m]	Resolution						
	VGA 640 x 480	SVGA 800 x 600	XGA 1024 x 768	HD 1366 x 768	SXGA 1280 x 1024	UXGA 1600 x 1200	FHD 1920 x 1080
1.8	5CADVI.0018-00	5CADVI.0018-00	5CADVI.0018-00	5CADVI.0018-00	5CADVI.0018-00	5CADVI.0018-00	5CADVI.0018-00
5	5CADVI.0050-00	5CADVI.0050-00	5CADVI.0050-00	5CADVI.0050-00	5CADVI.0050-00	5CADVI.0050-00	5CADVI.0050-00

The maximum cable length for DVI transfer is limited to 5 m due to the USB specification.

#### 4.1.4.1.5 Serial interface

The serial interface is only available for use with a single-touch display in DVI operation. It is used to transfer data from the resistive touch screen and must be connected to a serial interface on the output device.

COM interface	
RS232	
Type	Modem supported, not galvanically isolated, DSUB, 9-pin, female
UART	16550-compatible, 16-byte FIFO buffer
Transfer rate	Max. 115 kbit/s
Bus length	Max. 15 m
Pin	Pinout
1	NC
2	RXD
3	TXD
4	NC
5	GND
6	NC
7	RTS
8	CTS
9	NC

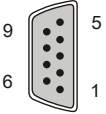

#### 4.1.4.1.6 USB In interface

The USB In interface is a USB 2.0 type B interface that is used to transfer USB data. It must be connected to a USB interface on the output device (e.g. B&R industrial PC) if DVI operation or SDL operation with a USB type A/B cable was chosen as the transfer method. For possible transfer methods, see section "Connection options" on page 17.

If the interface is connected to an output device (e.g. B&R industrial PC), then USB 2.0 transfer rates are possible on the USB1 and USB2 interfaces.

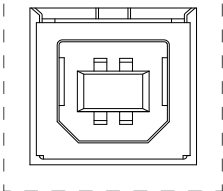
Description		Figure
Standard	USB 2.0	
Variant	Type B, female	
Transfer rate	Low speed (1.5 Mbit/s) Full speed (12 Mbit/s) High speed (480 Mbit/s)	
Current-carrying capacity <sup>1)</sup>	Max. 500 mA	
Cable length	Max. 5 m (without hub)	
	-	

1) The USB interface is protected by a maintenance-free "USB current-limiting switch" (max. 500 mA).

#### 4.1.4.1.7 USB interfaces

The link module is equipped with a USB 2.0 (Universal Serial Bus) host controller with several USB ports, of which 2 USB interfaces are routed externally and freely available to the user.

### Warning!

USB peripheral devices can be connected to the USB interfaces. Due to the variety of USB devices available on the market, B&R cannot guarantee their functionality. The functionality of USB devices available from B&R is ensured.

### Caution!

Due to the general PC specification, this interface must be handled with the utmost care with regard to EMC, cable routing, etc.

#### USB1, USB2

Depending on the transfer method (SDL or DVI operation), there are limitations regarding the transfer rate for interfaces USB1 and USB2. For possible transfer methods, see section "Connection options" on page 17.

Transfer method	USB type	Max. cable length
SDL operation without USB cable	USB 1.1	<sup>1)</sup>
SDL operation with USB cable	USB 2.0	5 m
Single-touch DVI operation	USB 2.0	5 m
Multi-touch DVI operation	USB 2.0	5 m

1) The max. cable length of depends on the resolution. For exact specifications, see table Cable lengths and resolutions for SDL transfer.

USB1 - 2	
Standard	USB 2.0
Variant	Type A, female
Transfer rate	Low speed (1.5 Mbit/s) Full speed (12 Mbit/s) High speed (480 Mbit/s)
Current-carrying capacity <sup>1)</sup> USB1 (1) USB2 (2)	Total max. 1 A
Cable length USB 2.0	Max. 5 m (without hub)

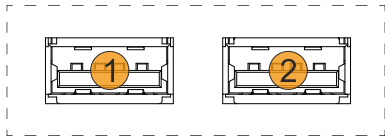

1) The USB interfaces are protected by a shared maintenance-free "USB current-limiting switch" (total max. 1 A).

#### 4.1.4.1.8 Brightness controls

The brightness controls can be used to set the brightness of the backlight on the Automation Panel in DVI operation. Buttons have no function during SDL operation; the brightness can be set via the B&R Control Center, for example.

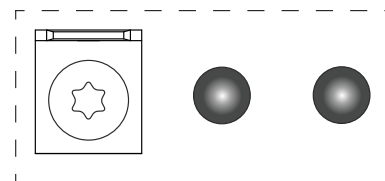

### 4.1.4.2 SDL3 receiver (5DLSD3.1001-00)

#### 4.1.4.2.1 Overview

The interfaces available on the device or module are numbered for the purpose of clear differentiation. The numbering used by the operating system may deviate, however.

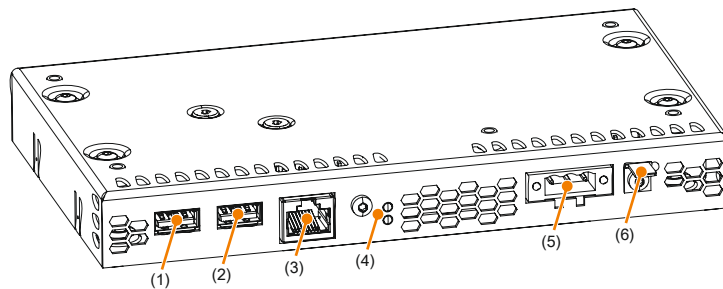

No.	Interface name	Chapter	No.	Interface name	Chapter
1	USB1	"USB interfaces"	4	SDL3 In LEDs	"SDL3 In interfaces"
2	USB2	"USB interfaces"	5	Power 24 VDC	"+24 VDC power supply"
3	SDL3 In	"SDL3 In interfaces"	6	Grounding	"Grounding"

#### 4.1.4.2.2 +24 VDC power supply

### Danger!

This device is only permitted to be supplied by a SELV/PELV power supply unit or with safety extra-low voltage (SELV) per IEC 61010-2-201.

The necessary 3-pin connector is not included in delivery; for suitable accessories, see [0TB103.9x](#).

The device is protected against overload and reverse polarity by a soldered fuse (10 A, fast-acting). If the fuse is defective (e.g. due to overload), the device must be sent to B&R for repairs. If the polarity is reversed, it is not necessary to replace the fuse.

Pin	Description	Figure
1	-	
2	Functional ground	
3	+	
<ul style="list-style-type: none"> <li>Reverse polarity protection</li> <li>3-pin</li> <li>Male</li> </ul>		
<b>Electrical properties</b>		
Nominal voltage	24 VDC ±25%, SELV <sup>1)</sup>	
Nominal current	Max. 3 A	
Overvoltage category per EN 61131-2	II	
Galvanic isolation	Yes	
Uninterruptible power supply	No	

1) IEC 61010-2-201 requirements must be observed.

### 4.1.4.2.3 Grounding

#### Caution!

The functional ground (power supply pin 2 and ground connection) must be connected to the central grounding point (e.g. control cabinet or system) via the shortest possible path with the lowest possible resistance and with the largest possible wire cross section. This type of grounding is mandatory for proper functionality.

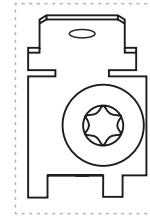

For example, a copper strip must be attached to the ground connection at a central grounding point of the control cabinet or system in which the device is installed. The wire cross section should be as large as possible (at least 2.5 mm<sup>2</sup>).

### 4.1.4.2.4 SDL3 In interfaces

#### Information:

For additional information, see section "SDL3 operation" on page 21.

The SDL3 In interface is a female RJ45 connector and operated with SDL3 transmission technology.

Description		Figure
The following shows an overview of the video signals possible on the panel input. For details, see the technical data for the link module or panel used.		
Variant	RJ45 connector, female	
Link module	Video signals	
5DLS3.1001-00	SDL3	

#### Information:

##### Cable lengths and resolutions for SDL3 transfer:

The maximum cable length for SDL3 transfers is 100 m with a B&R SDL3/SDL4 cable (regardless of the panel resolution).

SDL3 IN LEDs			
LED	Color	Status	Explanation
Link	Yellow	On	Indicates an active SDL3 connection.
		Off	No active SDL3 connection.
Status	Yellow	On	The SDL3 connection is established and OK.
		Off	No active SDL3 connection.
		Blinking	Indicates the SDL3 connection is OK, but a firmware image is corrupt.

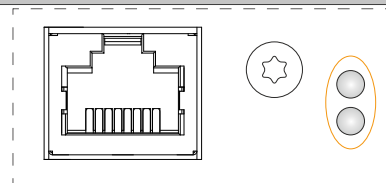

#### Information:

Hot plugging display devices on the SDL3 In interface for service purposes is supported by the hardware and graphics drivers of approved operating systems. The female RJ45 connector is specified for 500 mating cycles.

#### Information:

If a display device with touch screen is connected to the SDL3 In interface and then disconnected again during operation (hot plugging), it may be necessary to recalibrate the touch screen.



#### 4.1.4.2.5 USB interfaces

The link module is equipped with a USB 2.0 (Universal Serial Bus) host controller with several USB ports, of which 2 USB interfaces are routed externally and freely available to the user.

### Warning!

USB peripheral devices can be connected to the USB interfaces. Due to the variety of USB devices available on the market, B&R cannot guarantee their functionality. The functionality of USB devices available from B&R is ensured.

### Caution!

Due to the general PC specification, this interface must be handled with the utmost care with regard to EMC, cable routing, etc.

USB1 - 2	
Standard	USB 2.0
Variant	Type A, female
Transfer rate	Low speed (1.5 Mbit/s) Full speed (12 Mbit/s) High speed (30 Mbit/s)
Current-carrying capacity <sup>1)</sup> USB1 (1) USB2 (2)	Total max. 1 A
Cable length USB 2.0	Max. 5 m (without hub)

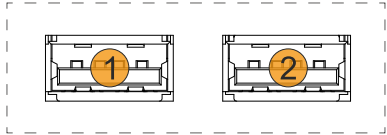

1) The USB interfaces are protected by a shared maintenance-free "USB current-limiting switch" (total max. 1 A).

### 4.1.4.3 SDL4 receiver (5DLSD4.1001-00)

#### 4.1.4.3.1 Overview

The interfaces available on the device or module are numbered for the purpose of clear differentiation. The numbering used by the operating system may deviate, however.

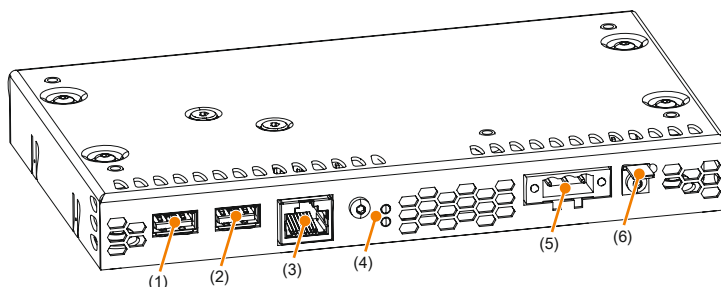

No.	Interface name	Chapter	No.	Interface name	Chapter
1	USB1	"USB interfaces"	4	SDL4 In LEDs	"SDL4 In interface"
2	USB2	"USB interfaces"	5	Power 24 VDC	"+24 VDC power supply"
3	SDL4 In	"SDL4 In interface"	6	Grounding	"Grounding"

#### 4.1.4.3.2 +24 VDC power supply

### Danger!

This device is only permitted to be supplied by a SELV/PELV power supply unit or with safety extra-low voltage (SELV) per IEC 61010-2-201.

The necessary 3-pin connector is not included in delivery; for suitable accessories, see [0TB103.9x](#).

The device is protected against overload and reverse polarity by a soldered fuse (10 A, fast-acting). If the fuse is defective (e.g. due to overload), the device must be sent to B&R for repairs. If the polarity is reversed, it is not necessary to replace the fuse.

Pin	Description	Figure
1	-	
2	Functional ground	
3	+	
<ul style="list-style-type: none"> <li>Reverse polarity protection</li> <li>3-pin</li> <li>Male</li> </ul>		
Electrical properties		
Nominal voltage	24 VDC ±25%, SELV <sup>1)</sup>	
Nominal current	Max. 3 A	
Overvoltage category per EN 61131-2	II	
Galvanic isolation	Yes	
Uninterruptible power supply	No	

1) IEC 61010-2-201 requirements must be observed.

### 4.1.4.3.3 Grounding

#### Caution!

The functional ground (power supply pin 2 and ground connection) must be connected to the central grounding point (e.g. control cabinet or system) via the shortest possible path with the lowest possible resistance and with the largest possible wire cross section. This type of grounding is mandatory for proper functionality.

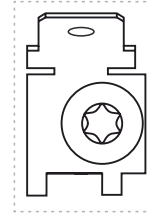

For example, a copper strip must be attached to the ground connection at a central grounding point of the control cabinet or system in which the device is installed. The wire cross section should be as large as possible (at least 2.5 mm<sup>2</sup>).

### 4.1.4.3.4 SDL4 In interface

#### Information:

For additional information, see section "SDL4 operation" on page 22.

The SDL4 In interface is a female RJ45 connector and operated with SDL4 transmission technology.

Description		Figure
The following shows an overview of the video signals possible on the panel input. For details, see the technical data for the link module or panel used.		
Variant	RJ45 connector, female	
Link module	Video signals	
5DLS4.1001-00	SDL4	

#### Information:

##### Cable lengths and resolutions for SDL4 transfer:

The maximum cable length for SDL4 transfer with a B&R SDL3/SDL4 cable is 100 meters (regardless of the resolution of the panel).

SDL4 IN LEDs			
LED	Color	Status	Explanation
Link	Yellow	On	Indicates an active SDL4 connection.
		Off	No active SDL4 connection.
Status	Yellow	On	The SDL4 connection is established and OK.
		Off	No active SDL4 connection.
		Blinking	Indicates the SDL4 connection is OK, but a firmware image is corrupt.

#### Information:

Hot plugging display devices on the SDL4 In interface for service purposes is supported by the hardware and graphics drivers of approved operating systems. The female RJ45 connector is specified for 500 mating cycles.

#### Information:

If a display device with touch screen is connected to the SDL4 In interface and then disconnected again during operation (hot plugging), it may be necessary to recalibrate the touch screen.

#### 4.1.4.3.5 USB interfaces

The link module is equipped with a USB 2.0 (Universal Serial Bus) host controller with several USB ports, of which 2 USB interfaces are routed externally and freely available to the user.

### Warning!

USB peripheral devices can be connected to the USB interfaces. Due to the variety of USB devices available on the market, B&R cannot guarantee their functionality. The functionality of USB devices available from B&R is ensured.

### Caution!

Due to the general PC specification, this interface must be handled with the utmost care with regard to EMC, cable routing, etc.

USB1 - 2	
Standard	USB 2.0
Variant	Type A, female
Transfer rate	Low speed (1.5 Mbit/s) Full speed (12 Mbit/s) High speed (150 Mbit/s)
Current-carrying capacity <sup>1)</sup> USB1 (1) USB2 (2)	Total max. 1 A
Cable length USB 2.0	Max. 5 m (without hub)

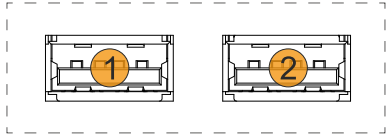

1) The USB interfaces are protected by a shared maintenance-free "USB current-limiting switch" (total max. 1 A).

## 4.1.5 System unit device interfaces

### 4.1.5.1 System unit PPC2100 (5PPC2100.BYxx-000)

#### 4.1.5.1.1 Overview

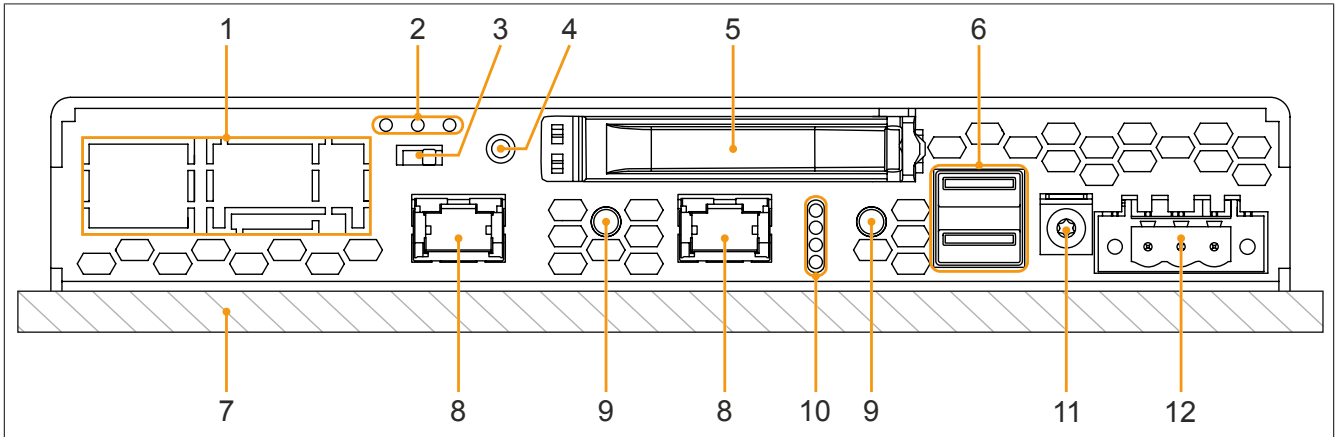

Legend			
1	"IF option slot (IF1, IFx)" on page 50	2	Status LEDs of the interface option <sup>1)</sup>
3	Interface option - Terminating resistor <sup>1)</sup>	4	Screw point for cable shield
5	"CFast slot" on page 48	6	"USB interfaces" on page 47
7	Panel (configuration-dependent)	8	"Ethernet interfaces" on page 46
9	"Power and reset buttons" on page 48	10	"LED status indicators" on page 49
11	"Grounding" on page 46	12	" +24 VDC power supply" on page 45

1) Only available with installed interface option (configuration-dependent, see "IF option slot (IF1, IFx)" on page 50).

#### 4.1.5.1.2 +24 VDC power supply

### Danger!

This device is only permitted to be supplied by a SELV/PELV power supply unit or with safety extra-low voltage (SELV) per IEC 61010-2-201.

The necessary 3-pin connector is not included in delivery; for suitable accessories, see "0TB103.9x" on page 136.

The device is protected against overload and reverse polarity by a soldered fuse (10 A, fast-acting). If the fuse is defective (e.g. due to overload), the device must be sent to B&R for repairs. If the polarity is reversed, it is not necessary to replace the fuse.

Pin	Description	Figure
1	+	
2	Functional ground	
3	-	
<ul style="list-style-type: none"> <li>Reverse polarity protection</li> <li>3-pin</li> <li>Male</li> </ul>		
Electrical properties		
Nominal voltage	24 VDC ±25%, SELV <sup>1)</sup>	
Nominal current	Max. 3.5 A	
Overvoltage category per EN 61131-2	II	
Inrush current	Typ. 6 A, max. 10 A for < 300 μs	
Galvanic isolation	Yes	
Uninterruptible power supply	No	

1) IEC 61010-2-201 requirements must be observed.

### 4.1.5.1.2.1 Grounding

#### Caution!

The functional ground (power supply pin 2 and ground connection) must be connected to the central grounding point (e.g. control cabinet or system) via the shortest possible path with the lowest possible resistance and with the largest possible wire cross section. This type of grounding is mandatory for proper functionality.

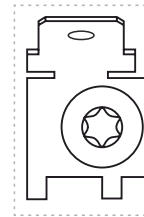

For example, a copper strip must be attached to the ground connection at a central grounding point of the control cabinet or system in which the device is installed. The wire cross section should be as large as possible (at least 2.5 mm<sup>2</sup>).

### 4.1.5.1.3 Ethernet interfaces

The Ethernet controller is routed externally via the system unit.

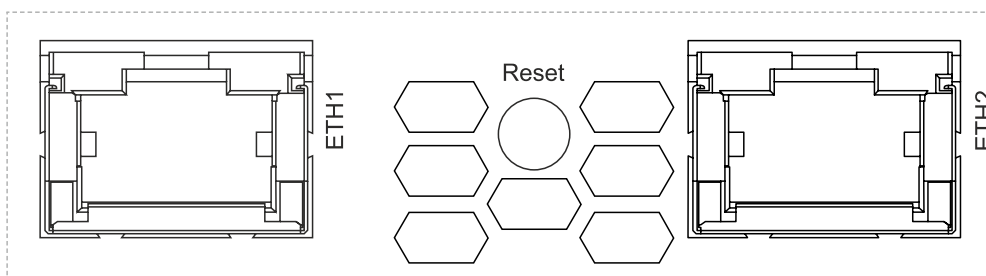

ETH1, ETH2		
Variant	RJ45, female	
Controller	Intel I210	
Wiring	S/STP (Cat 5e)	
Transfer rate	10/100/1000 Mbit/s <sup>1)</sup>	
Cable length	Max. 100 m (min. Cat 5e)	
<b>LED "Speed" (b)</b>	<b>On</b>	<b>Off</b>
	100 Mbit/s	10 Mbit/s <sup>2)</sup>
	1000 Mbit/s	-
<b>LED "Link" (a)</b>	<b>On</b>	<b>Active</b>
	Link (a connection to an Ethernet network exists)	Blinking (data being transferred)

Example image

- 1) Switching takes place automatically.
- 2) The 10 Mbit/s transfer rate / connection is only available if LED "Link" is active at the same time.

#### Driver support

A special driver is required to operate the Ethernet controller. Drivers for approved operating systems are available for download in the Downloads section of the B&R website ([www.br-automation.com](http://www.br-automation.com)).

#### Information:

Necessary drivers must be downloaded from the B&R website, not from manufacturer websites.

#### 4.1.5.1.4 USB interfaces

Panel PC devices are equipped with a USB 3.0 (Universal Serial Bus) host controller with several USB ports, of which one USB 3.0 interface and one USB 2.0 interface are routed externally and freely available to the user.

### Warning!

USB peripheral devices can be connected to the USB interfaces. Due to the variety of USB devices available on the market, B&R cannot guarantee their functionality. The functionality of USB devices available from B&R is ensured.

### Caution!

Due to the general PC specification, this interface must be handled with the utmost care with regard to EMC, cable routing, etc.

#### Driver support

A special driver is necessary to operate the USB 3.0 host controller with multiple USB interfaces. Drivers for approved operating systems are available for download in the Downloads section of the B&R website ([www.br-automation.com](http://www.br-automation.com)).

### Information:

Necessary drivers must be downloaded from the B&R website, not from manufacturer websites.

USB1 and USB2		
Standard	USB1	USB 3.0
	USB2	USB 2.0
Variant	Type A, female	
Transfer rate	Low speed (1.5 Mbit/s)	
	Full speed (12 Mbit/s)	
	High speed (480 Mbit/s)	
	SuperSpeed (5 Gbit/s) <sup>1)</sup>	
Current-carrying capacity <sup>2)</sup>	Max. 1 A	
Cable length	USB 2.0	Max. 5 m (without hub) <sup>3)</sup>
	USB 3.0	Max. 3 m (without hub)

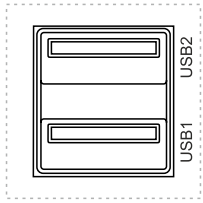

The diagram shows a USB Type A female connector with two ports. The top port is labeled 'USB2' and the bottom port is labeled 'USB1'. The ports are shown in a perspective view within a dashed rectangular border.

- 1) Compatibility with SuperSpeed depends on the operating system used and is only possible with USB 3.0.
- 2) Each USB interface is protected by a maintenance-free "USB current-limiting switch" (max. 1 A).
- 3) With revisions < B0 for system units, the max. cable length has been specified at 3 m.

#### 4.1.5.1.5 CFast slot

The Panel PC offers an easy-to-access CFast slot so that a CFast card can also be used as a removable storage medium for transferring data or performing upgrades.

This CFast slot is internally connected to the chipset and implemented in version SATA II (SATA 3.0 Gbit/s).

### Information:

**5CFAST.0xxx-00 CFast cards are only permitted to be operated in the xPC2100 with revision E0 or later.**

CFast slot	
Connection	SATA 0
Order number	Short description
CFast cards	
5CFAST.2048-00	CFast 2 GB SLC
5CFAST.4096-00	CFast 4 GB SLC
5CFAST.8192-00	CFast 8 GB SLC
5CFAST.016G-00	CFast 16 GB SLC
5CFAST.032G-00	CFast 32 GB SLC
5CFAST.032G-10	CFast 32 GB MLC
5CFAST.064G-10	CFast 64 GB MLC
5CFAST.128G-10	CFast 128 GB MLC
5CFAST.256G-10	CFast 256 GB MLC

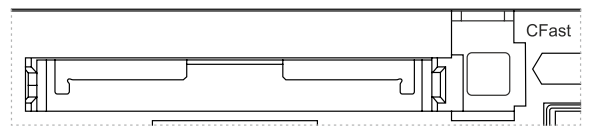

### Warning!

**CFast cards are only permitted to be inserted and removed in a voltage-free state!**

#### 4.1.5.1.6 Power and reset buttons

Both buttons can be pressed without any tools.

Description
<p><b>Power button</b></p> <p>The power button offers full ATX power supply support and has various configurable functions.</p> <ul style="list-style-type: none"> <li>• <b>Short press:</b> Switches the PC on or off or performs the action configured in the operating system when pressing the power button (shutdown, sleep, etc.).</li> <li>• <b>Long press (approx. 4 s):</b> The ATX power supply switches off the PC without shutting it down.</li> </ul> <p>Pressing the power button does not reset the MTCX processor.</p>
<p><b>Reset button</b></p> <p>Pressing the reset button triggers a hardware/PCI reset. The PC is restarted. During a reset, the MTCX processor is not reset.</p>

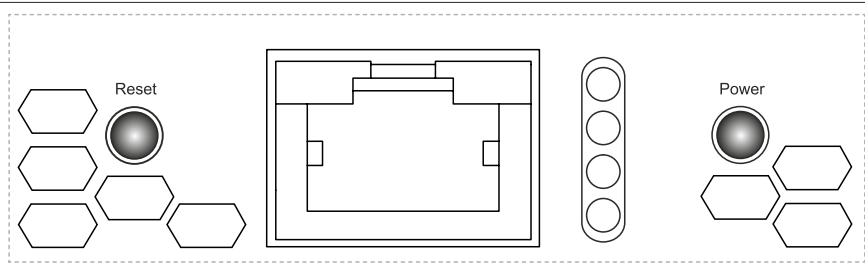







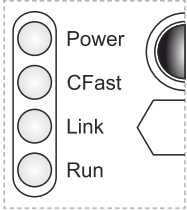

### Warning!

**Switching off the power without shutting down or resetting the system can result in data loss!**

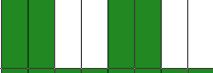
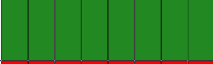

4.1.5.1.7 LED status indicators

Assignment	LED	Color	Status	Explanation	LED status indicators <sup>1)</sup>	
	Power	Green	On	Power supply OK		
		Red	On	The system is in power saving mode (standby). <sup>1)</sup>		
		Red-Green	Blinking	Faulty or incomplete BIOS, MTCX or I/O FPGA update, power supply OK		
				Faulty or incomplete BIOS, MTCX or I/O FPGA update, power saving mode (standby)		
	<p><b>Information:</b> An update must be performed again.</p>					
	CFast	Yellow	On	Indicates CFast access		
	Link	Reserved				
	Run	Green	Blinking	Automation Runtime is starting up. Controlled by Automation Runtime (ARemb and AR-win).		
		Green	On	Application running Controlled by Automation Runtime (ARemb and AR-win).		
		Red	On	Application in SERVICE mode Controlled by Automation Runtime (ARemb and AR-win).		
Orange		Blinking	A license violation has occurred.			

- 1) Two columns form 1 interval of 500 ms each.
- 2) S5: Soft-off  
S4: Hibernate (suspend-to-disk)

### 4.1.5.1.8 IF option slot (IF1, IFx)

xPC2x00 system units have 1 slot for an interface option.

The following table lists the interface options that can be operated in the IF option slot.

Interface option slot	
Order number	Interface options Short description
5ACCIF01.FPCC-000	Interface card - 2x CAN interfaces - 1x X2X Link interface - 1x POWERLINK interface - 512 kB nvSRAM - For APC2100/PPC2100/APC2200/PPC2200
5ACCIF01.FPCS-000	Interface card - 1x RS485 interface - 1x CAN interface - 1x POWERLINK interface - 32 kB FRAM - For APC2100/PPC2100/APC2200/PPC2200
5ACCIF01.FPLK-000	Interface card - 1x POWERLINK interface - integrated 2-port hub - 512 kB nvSRAM - For APC2100/PPC2100/APC2200/PPC2200
5ACCIF01.FPLS-000	Interface card - 1x RS232 interface - 1x POWERLINK interface - 32 kB FRAM - For APC2100/PPC2100/APC2200/PPC2200
5ACCIF01.FPLS-001	Interface card - 1x RS232 interface - 1x POWERLINK interface - 512 kB nvSRAM - For APC2100/PPC2100/APC2200/PPC2200
5ACCIF01.FPSC-000	Interface card - 1x RS232 interface - 1x CAN interface - 1x POWERLINK interface - 32 kB FRAM - For APC2100/PPC2100/APC2200/PPC2200
5ACCIF01.FPSC-001	Interface card - 1x RS232 interface - 1x CAN interface - 1x X2X Link interface - 1x POWERLINK interface - 512 kB nvSRAM - For APC2100/PPC2100/APC2200/PPC2200
5ACCIF01.FSS0-000	Interface card - 2x RS422/RS485 interface - For APC2100/PPC2100/APC2200/PPC2200
5ACCIF01.ICAN-000	Interface card - 1x CAN interface - For APC2100/PPC2100/APC2200/PPC2200
5ACCIF01.IS00-000	Interface card - 1x RS232 interface - For APC2100/PPC2100/APC2200/PPC2200

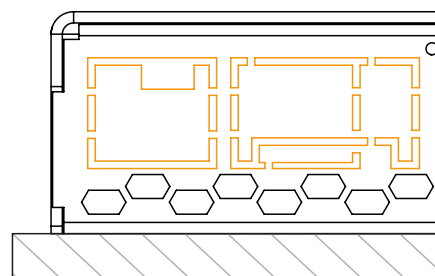

#### Information:

Interface options can only be installed and replaced at the B&R factory.

### 4.1.5.2 System unit PPC2200 (5PPC2200.ALxx-000)

#### 4.1.5.2.1 Overview

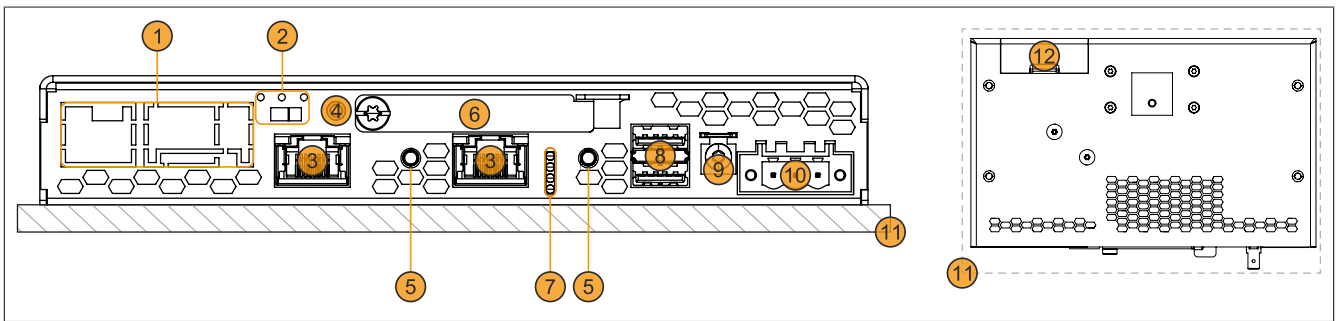

Legend			
1	"IF option slot " on page 56	2	Status LEDs of the interface option <sup>1)</sup> Interface option - Terminating resistor <sup>1)</sup>
3	"Ethernet interfaces" on page 52	4	Screw point for cable shield
5	"Power and reset buttons" on page 54	6	"CFast slot" on page 48
7	"LED status indicators" on page 55	8	"USB interfaces" on page 53
9	"Grounding" on page 52	10	"+24 VDC power supply" on page 45
11	Panel (configuration-dependent)	12	"Battery compartment" on page 56

1) Only available with installed interface option (configuration-dependent, see "IF option slot " on page 56).

#### 4.1.5.2.2 +24 VDC power supply

## Danger!

This device is only permitted to be supplied by a SELV/PELV power supply unit or with safety extra-low voltage (SELV) per IEC 61010-2-201.

The necessary 3-pin connector is not included in delivery; for suitable accessories, see "0TB103.9x" on page 136.

The device is protected against overload and reverse polarity by a soldered fuse (15 A, fast-acting). If the fuse is defective (e.g. due to overload), the device must be sent to B&R for repairs. If the polarity is reversed, it is not necessary to replace the fuse.

Pin	Description	Figure
1	+	
2	Functional ground	
3	-	
<ul style="list-style-type: none"> <li>Reverse polarity protection</li> <li>3-pin</li> <li>Male</li> </ul>		
Electrical properties		
Nominal voltage	24 VDC ±25%, SELV <sup>1)</sup>	
Nominal current	Max. 4 A	
Overvoltage category per EN 61131-2	II	
Inrush current	Typ. 5 A, max. 50 A for < 500 μs	
Galvanic isolation	Yes	
Uninterruptible power supply	No	

1) IEC 61010-2-201 requirements must be observed.

#### 4.1.5.2.1 Grounding

### Caution!

The functional ground (power supply pin 2 and ground connection) must be connected to the central grounding point (e.g. control cabinet or system) via the shortest possible path with the lowest possible resistance and with the largest possible wire cross section. This type of grounding is mandatory for proper functionality.

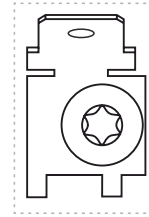

For example, a copper strip must be attached to the ground connection at a central grounding point of the control cabinet or system in which the device is installed. The wire cross section should be as large as possible (at least 2.5 mm<sup>2</sup>).

#### 4.1.5.2.3 Ethernet interfaces

The Ethernet controller is routed externally via the system unit.

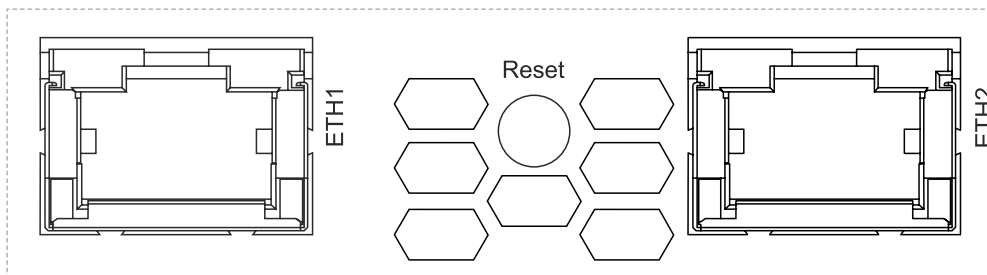

ETH1, ETH2		
Variant	RJ45, female	
Controller	Intel I210	
Wiring	S/STP (Cat 5e)	
Transfer rate	10/100/1000 Mbit/s <sup>1)</sup>	
Cable length	Max. 100 m (min. Cat 5e)	
<b>LED "Speed" (b)</b>	<b>On</b>	<b>Off</b>
	100 Mbit/s	10 Mbit/s <sup>2)</sup>
	1000 Mbit/s	-
<b>LED "Link" (a)</b>	<b>On</b>	<b>Active</b>
	Link (a connection to an Ethernet network exists)	Blinking (data being transferred)

Example image

- 1) Switching takes place automatically.
- 2) The 10 Mbit/s transfer rate / connection is only available if LED "Link" is active at the same time.

#### Driver support

A special driver is required to operate the Ethernet controller. Drivers for approved operating systems are available for download in the Downloads section of the B&R website ([www.br-automation.com](http://www.br-automation.com)).

### Information:

Necessary drivers must be downloaded from the B&R website, not from manufacturer websites.

#### 4.1.5.2.4 USB interfaces

Panel PC devices are equipped with a USB 3.0 (Universal Serial Bus) host controller with several USB ports, of which one USB 3.0 interface and one USB 2.0 interface are routed externally and freely available to the user.

### Warning!

USB peripheral devices can be connected to the USB interfaces. Due to the variety of USB devices available on the market, B&R cannot guarantee their functionality. The functionality of USB devices available from B&R is ensured.

### Caution!

Due to the general PC specification, this interface must be handled with the utmost care with regard to EMC, cable routing, etc.

#### Driver support

A special driver is necessary to operate the USB 3.0 host controller with multiple USB interfaces. Drivers for approved operating systems are available for download in the Downloads section of the B&R website ([www.br-automation.com](http://www.br-automation.com)).

### Information:

Necessary drivers must be downloaded from the B&R website, not from manufacturer websites.

USB1 and USB2		
Standard	USB1	USB 3.0
	USB2	USB 2.0
Variant	Type A, female	
Transfer rate	Low speed (1.5 Mbit/s)	
	Full speed (12 Mbit/s)	
	High speed (480 Mbit/s)	
	SuperSpeed (5 Gbit/s) <sup>1)</sup>	
Current-carrying capacity <sup>2)</sup>	Max. 1 A	
Cable length	USB 2.0	Max. 5 m (without hub) <sup>3)</sup>
	USB 3.0	Max. 3 m (without hub)

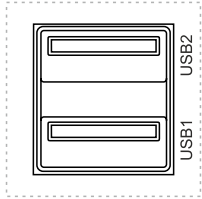

- 1) Compatibility with SuperSpeed depends on the operating system used and is only possible with USB 3.0.
- 2) Each USB interface is protected by a maintenance-free "USB current-limiting switch" (max. 1 A).
- 3) With revisions < B0 for system units, the max. cable length has been specified at 3 m.

#### 4.1.5.2.5 CFast slot

The The panel PC offers an easily accessible CFast slot so that the CFast card can also be used as a removable storage medium for data transfer or upgrades.

This CFast slot is internally connected to the chipset via SATA 0 and implemented in version SATA III (SATA 6.0 Gbit/s).

### Warning!

CFast cards are only permitted to be inserted and removed in a voltage-free state!

CFast slot	
Connection	SATA 0
Order number	Short description
	<b>CFast cards</b>
5CFAST.2048-00	CFast 2 GB SLC
5CFAST.4096-00	CFast 4 GB SLC
5CFAST.8192-00	CFast 8 GB SLC
5CFAST.016G-00	CFast 16 GB SLC
5CFAST.032G-00	CFast 32 GB SLC
5CFAST.032G-10	CFast 32 GB MLC
5CFAST.064G-10	CFast 64 GB MLC
5CFAST.128G-10	CFast 128 GB MLC
5CFAST.256G-10	CFast 256 GB MLC



### 4.1.5.2.6 Power and reset buttons











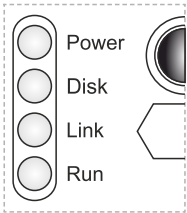



Both buttons can be pressed without any tools.

Description
<p><b>Power button</b></p> <p>The power button offers full ATX power supply support and has various configurable functions.</p> <ul style="list-style-type: none"> <li>• <b>Short press:</b> Switches the PC on or off or performs the action configured in the operating system when pressing the power button (shutdown, sleep, etc.).</li> <li>• <b>Long press (approx. 4 s):</b> The ATX power supply switches off the PC without shutting it down.</li> </ul> <p>Pressing the power button does not reset the MTCX processor.</p>
<p><b>Reset button</b></p> <p>Pressing the reset button triggers a hardware/PCI reset. The PC is restarted. During a reset, the MTCX processor is not reset.</p>

## Warning!

Switching off the power without shutting down or resetting the system can result in data loss!

4.1.5.2.7 LED status indicators

Assignment	LED	Color	Status	Explanation	LED status indicator <sup>1)</sup>
	Power	Green	On	Power supply OK	
			Blinking	The device is started up; the battery state is "BAD".	
		<p><b>Information:</b> For additional information, see "Battery compartment".</p>			
	Red	Red	On	The system is in power saving mode (standby). <sup>1)</sup>	
			Blinking	The MTCX is running; the battery state is "BAD". The system is in power saving mode (standby). <sup>1)</sup>	
	Red-Green	Red-Green	Blinking	Faulty or incomplete BIOS, MTCX or I/O FPGA update, battery state OK, power supply OK	
				Faulty or incomplete BIOS, MTCX or I/O FPGA update, battery state OK, power saving mode (standby) <sup>1)</sup>	
				Faulty or incomplete BIOS, MTCX or I/O FPGA update, battery state BAD, power supply OK	
				Faulty or incomplete BIOS, MTCX or I/O FPGA update, battery state BAD, power saving mode (standby) <sup>1)</sup>	
	<p><b>Information:</b> An update must be performed again.</p>				
Disk	Yellow	On	Indicates drive access (CFast)		
Link	Reserved				
Run	Green	Green	Blinking	Automation Runtime is starting up. Controlled by Automation Runtime (ARemb and AR-win).	
			On	Application running. Controlled by Automation Runtime (ARemb and AR-win).	
			On	Application in SERVICE mode. Controlled by Automation Runtime (ARemb and AR-win).	
			Blinking	A license violation has occurred.	

1) Two columns form 1 interval of 500 ms each.  
 2) S5: Soft-off  
 S4: Hibernate (suspend-to-disk)

#### 4.1.5.2.8 IF option slot

xPC2x00 system units have 1 slot for an interface option.

The following table lists the interface options that can be operated in the IF option slot.

Interface option slot	
Order number	Interface options Short description
5ACCIF01.FPCC-000	Interface card - 2x CAN interfaces - 1x X2X Link interface - 1x POWERLINK interface - 512 kB nvSRAM - For APC2100/PPC2100/APC2200/PPC2200
5ACCIF01.FPCS-000	Interface card - 1x RS485 interface - 1x CAN interface - 1x POWERLINK interface - 32 kB FRAM - For APC2100/PPC2100/APC2200/PPC2200
5ACCIF01.FPLK-000	Interface card - 1x POWERLINK interface - integrated 2-port hub - 512 kB nvSRAM - For APC2100/PPC2100/APC2200/PPC2200
5ACCIF01.FPLS-000	Interface card - 1x RS232 interface - 1x POWERLINK interface - 32 kB FRAM - For APC2100/PPC2100/APC2200/PPC2200
5ACCIF01.FPLS-001	Interface card - 1x RS232 interface - 1x POWERLINK interface - 512 kB nvSRAM - For APC2100/PPC2100/APC2200/PPC2200
5ACCIF01.FPSC-000	Interface card - 1x RS232 interface - 1x CAN interface - 1x POWERLINK interface - 32 kB FRAM - For APC2100/PPC2100/APC2200/PPC2200
5ACCIF01.FPSC-001	Interface card - 1x RS232 interface - 1x CAN interface - 1x X2X Link interface - 1x POWERLINK interface - 512 kB nvSRAM - For APC2100/PPC2100/APC2200/PPC2200
5ACCIF01.FSS0-000	Interface card - 2x RS422/RS485 interface - For APC2100/PPC2100/APC2200/PPC2200
5ACCIF01.ICAN-000	Interface card - 1x CAN interface - For APC2100/PPC2100/APC2200/PPC2200
5ACCIF01.IS00-000	Interface card - 1x RS232 interface - For APC2100/PPC2100/APC2200/PPC2200
5ACCIF03.CETH-000	Interface card - 2x ETH interface (10/100/1000) - For APC2200/PPC2200

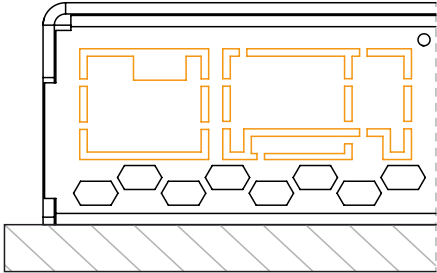

### Information:

Interface options can only be installed and replaced at the B&R factory.

#### 4.1.5.2.9 Battery compartment

The battery compartment consists of the battery holder and the battery.

The lithium battery (3 V, 1000 mAh) ensures retention of the internal real-time clock (RTC). The self-discharge time of the battery is at least 8 years (at 50°C, 6 µA for the components being supplied). The battery is subject to wear and should be replaced regularly (after the specified service life at the latest).

Order number	Short description	Figure
	<b>Accessories</b>	
5ACCBT01.0000-001	Battery compartment - Dark gray - Includes battery - For APC2200/PPC2200	



## 4.1.6 Features

### 4.1.6.1 AP92D - Features

Automation Panels [5AP92D.1505-100](#) and [5AP92D.1906-100](#) are equipped with the following interfaces:

- Rear USB interface

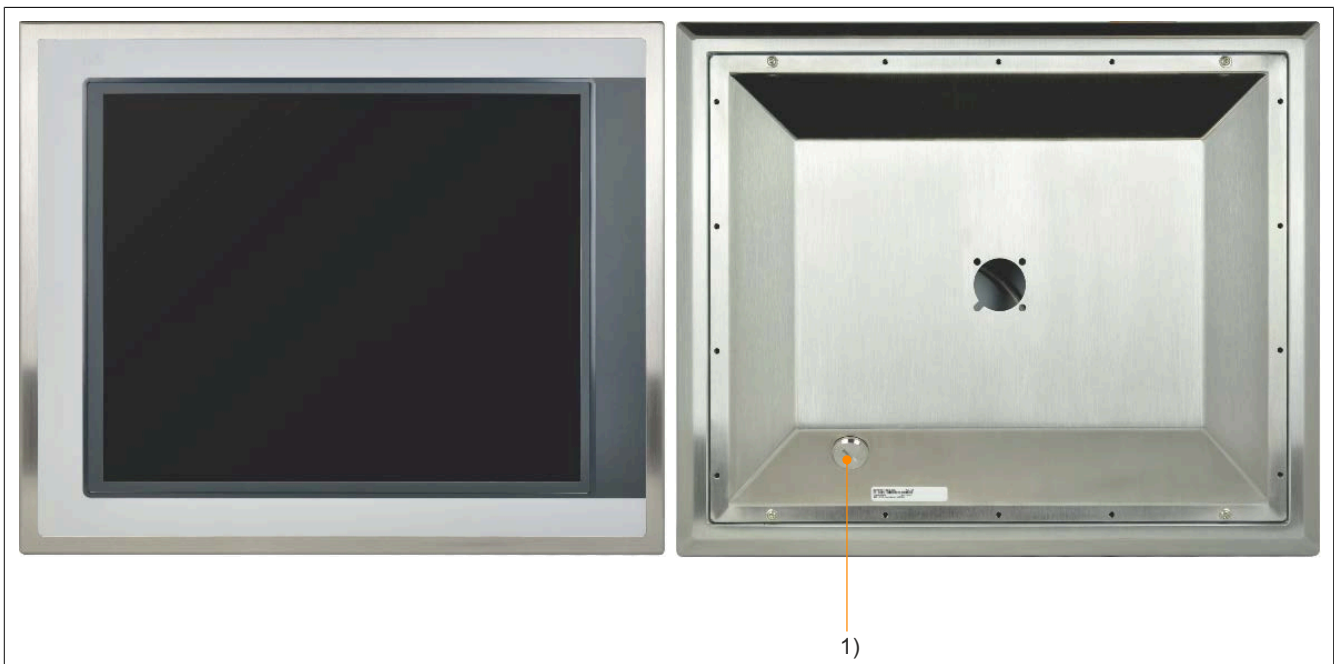

Figure 2: Front and rear view (AP92D)

1) USB interface

#### 4.1.6.1.1 USB interface

Panels are equipped with a rear USB 2.0 interface. This is equipped with a protective cover.

#### Caution!

IP66 protection can only be achieved if the USB protective cover is properly installed.

#### Warning!

USB peripheral devices can be connected to the USB interfaces. Due to the variety of USB devices available on the market, B&R cannot guarantee their functionality. The functionality of USB devices available from B&R is ensured.

#### Caution!

Due to the general PC specification, this interface must be handled with the utmost care with regard to EMC, cable routing, etc.

The USB interface is available to the user for service purposes.

#### Information:

The USB interface on the panel takes up the USB2 interface on the link module. If the USB cable is unplugged, the USB interface is disabled.

Depending on the transfer method (SDL or DVI operation), there are limitations regarding the transfer rate for interfaces USB1 and USB2. For possible transfer methods, see section [Connection options](#).

## Technical data

Transfer method	USB type	Max. cable length
SDL operation mode 1	USB 1.1	40 m
SDL operation mode 2	USB 2.0	5 m
Single-touch DVI operation	USB 2.0	5 m
Multi-touch DVI operation	USB 2.0	5 m
SDL3 operation	USB 2.0	100 m
SDL4 operation	USB 2.0	100 m

### Front USB

Type	USB 2.0
Variant	Type A, female
Transfer rate	Low speed (1.5 Mbit/s), full speed (12 Mbit/s) to high speed (480 Mbit/s) <sup>1)</sup>
Current-carrying capacity <sup>2)</sup>	Max. 500 mA
Cable length	
USB 2.0	Max. 5 m (without hub)

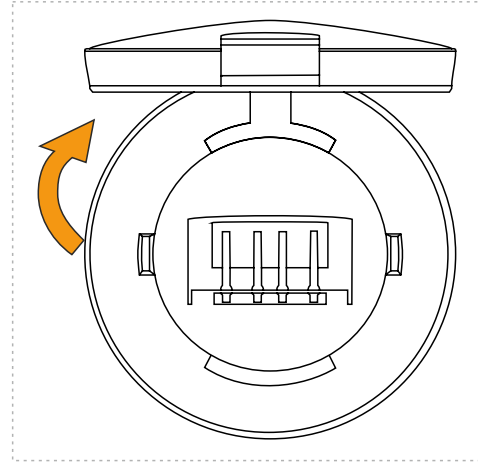

- 1) In SDL3 operation: Low speed (1.5 Mbit/s), full speed (12 Mbit/s) to high speed (30 Mbit/s)
- 2) The USB interface is protected by a maintenance-free "USB current-limiting switch" (max. 500 mA).

#### 4.1.6.2 AP93D - Features

Automation Panels [5AP93D.185B-B62](#) and [5AP93D.240C-B62](#) are equipped with the following interfaces:

- Rear USB interface

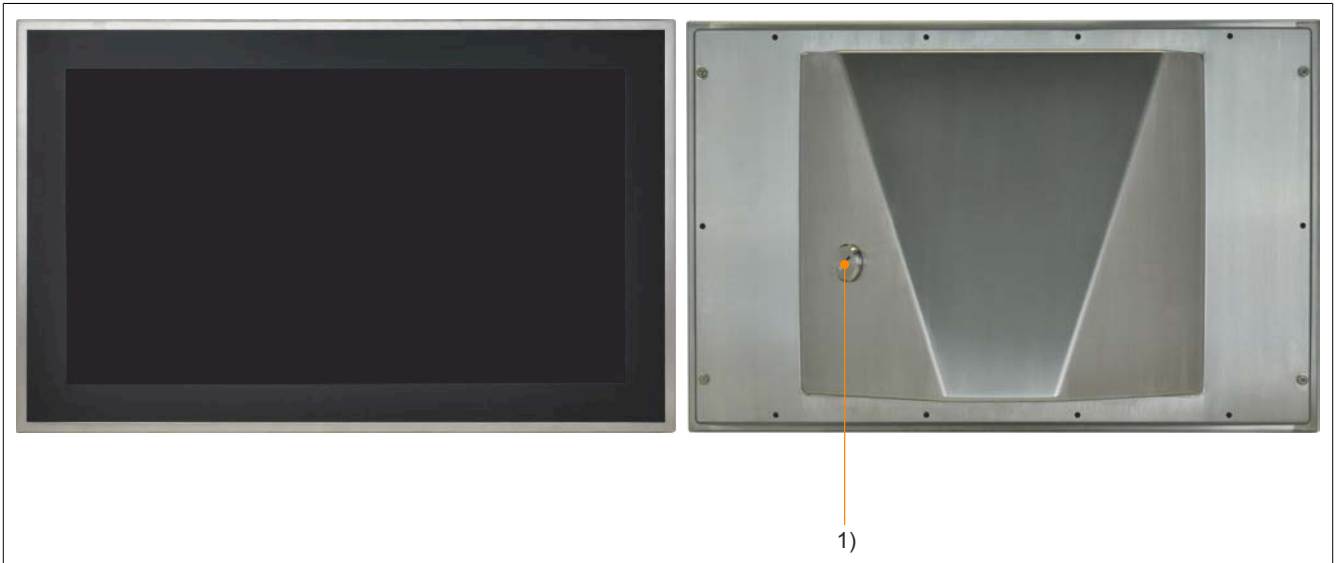

Figure 3: Front and rear view without operating elements (AP93D)

##### 4.1.6.2.1 USB interface

Panels are equipped with a rear USB 2.0 interface. This is equipped with a protective cover.

#### Caution!

IP66 protection can only be achieved if the USB protective cover is properly installed.

#### Warning!

USB peripheral devices can be connected to the USB interfaces. Due to the variety of USB devices available on the market, B&R cannot guarantee their functionality. The functionality of USB devices available from B&R is ensured.

#### Caution!

Due to the general PC specification, this interface must be handled with the utmost care with regard to EMC, cable routing, etc.

The USB interface is available to the user for service purposes.

#### Information:

The USB interface on the panel takes up the USB2 interface on the link module. If the USB cable is unplugged, the USB interface is disabled.

Depending on the transfer method (SDL or DVI operation), there are limitations regarding the transfer rate for interfaces USB1 and USB2. For possible transfer methods, see section [Connection options](#).

Transfer method	USB type	Max. cable length
SDL operation mode 1	USB 1.1	40 m
SDL operation mode 2	USB 2.0	5 m
Single-touch DVI operation	USB 2.0	5 m
Multi-touch DVI operation	USB 2.0	5 m
SDL3 operation	USB 2.0	100 m
SDL4 operation	USB 2.0	100 m

Front USB		
Type	USB 2.0	
Variant	Type A, female	
Transfer rate	Low speed (1.5 Mbit/s), full speed (12 Mbit/s) to high speed (480 Mbit/s) <sup>1)</sup>	
Current-carrying capacity <sup>2)</sup>	Max. 500 mA	
Cable length	Max. 5 m (without hub)	
	USB 2.0	

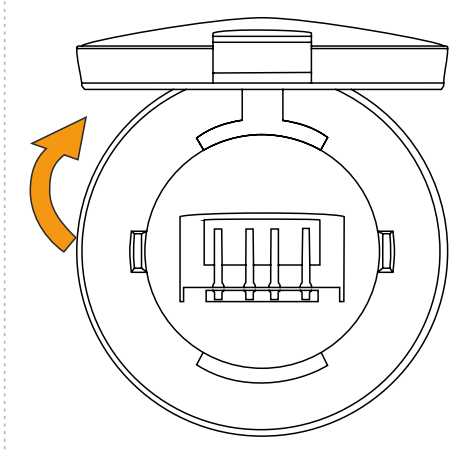

- 1) In SDL3 operation: Low speed (1.5 Mbit/s), full speed (12 Mbit/s) to high speed (30 Mbit/s)
- 2) The USB interface is protected by a maintenance-free "USB current-limiting switch" (max. 500 mA).

### 4.1.6.3 AP99D - Features

Automation Panels [5AP99D.156B-B62](#), [5AP99D.185B-B62](#), [5AP99D.185C-B62](#) and [5AP99D.215C-B62](#) are equipped with the following interfaces and operating elements:

- Rear USB interface
- RFID read/write unit
- 5 B&R illuminated ring keys
- Emergency stop
- Optional keys

#### Information:

Illuminated ring keys come with a standard label. A template is available from the B&R website ([www.br-automation.com](http://www.br-automation.com)).

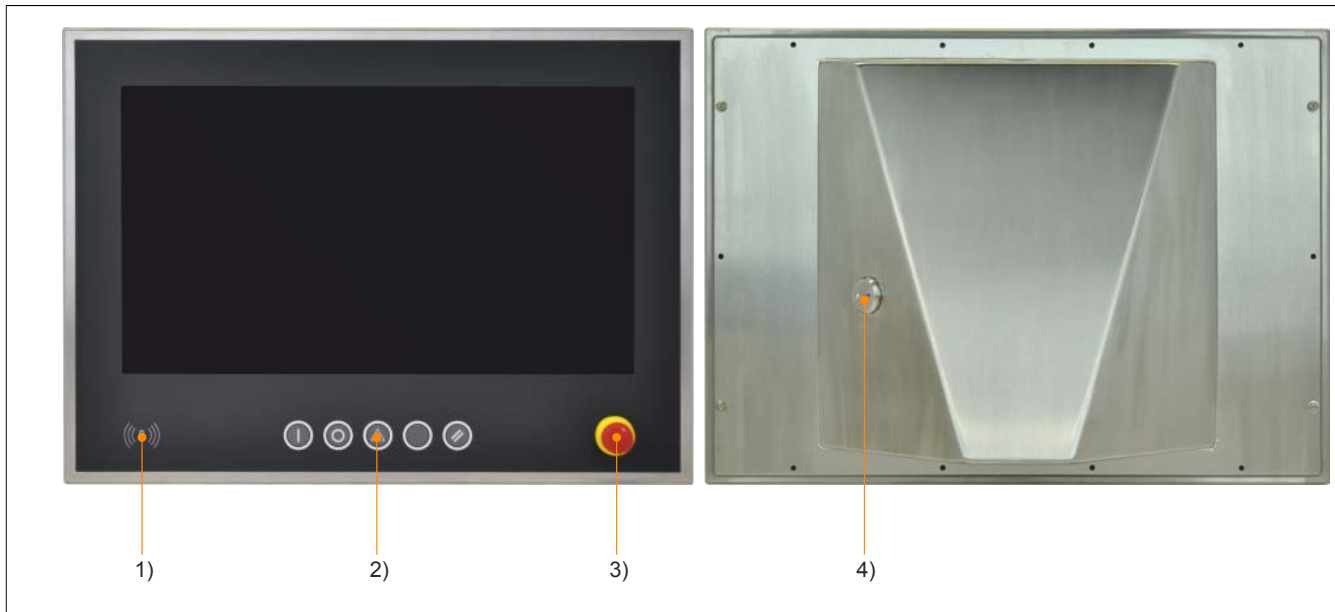

Figure 4: Front and rear view with operating elements (AP99D)

- 1) RFID read/write unit
- 2) B&R illuminated ring keys
- 3) Emergency stop
- 4) USB interface

#### 4.1.6.3.1 USB interface

Panels are equipped with a rear USB 2.0 interface. This is equipped with a protective cover.

#### Caution!

IP66 protection can only be achieved if the USB protective cover is properly installed.

#### Warning!

USB peripheral devices can be connected to the USB interfaces. Due to the variety of USB devices available on the market, B&R cannot guarantee their functionality. The functionality of USB devices available from B&R is ensured.

#### Caution!

Due to the general PC specification, this interface must be handled with the utmost care with regard to EMC, cable routing, etc.

The USB interface is available to the user for service purposes.

## Information:

The USB interface on the panel takes up the USB2 interface on the link module. If the USB cable is unplugged, the USB interface is disabled.

Depending on the transfer method (SDL or DVI operation), there are limitations regarding the transfer rate for interfaces USB1 and USB2. For possible transfer methods, see section [Connection options](#).

Transfer method	USB type	Max. cable length
SDL operation mode 1	USB 1.1	40 m
SDL operation mode 2	USB 2.0	5 m
Single-touch DVI operation	USB 2.0	5 m
Multi-touch DVI operation	USB 2.0	5 m
SDL3 operation	USB 2.0	100 m
SDL4 operation	USB 2.0	100 m

Front USB	
Type	USB 2.0
Variant	Type A, female
Transfer rate	Low speed (1.5 Mbit/s), full speed (12 Mbit/s) to high speed (480 Mbit/s) <sup>1)</sup>
Current-carrying capacity <sup>2)</sup>	Max. 500 mA
Cable length	
USB 2.0	Max. 5 m (without hub)

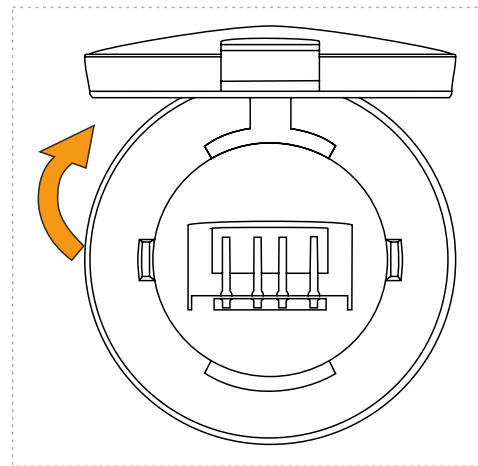

- 1) In SDL3 operation: Low speed (1.5 Mbit/s), full speed (12 Mbit/s) to high speed (30 Mbit/s)
- 2) The USB interface is protected by a maintenance-free "USB current-limiting switch" (max. 500 mA).

#### 4.1.6.3.2 RFID read/write unit

The RFID read/write unit is located on the front of the panel and can be used to read MIFARE and ISO 15693 tags.

The following transponder tags can be used with this RFID read/write unit:

Order number	Short description
5A9010.43	Transponder tag, black housing, read/write, SLI, 1 kbit, 13.56 MHz
5A9010.44	Transponder tag, white housing, read/write, SLI, 1 kbit, 13.56 MHz
5A9010.45	Transponder tag, yellow housing, read/write, SLI, 1 kbit, 13.56 MHz
5A9010.46	Transponder tag, red housing, read/write, SLI, 1 kbit, 13.56 MHz
5A9010.47	Transponder tag, green housing, read/write, SLI, 1 kbit, 13.56 MHz
5A9010.48	Transponder tag, blue housing, read/write, SLI, 1 kbit, 13.56 MHz
5A9020.43	Transponder tag, black housing, MIFARE Classic, 1 kB, 13.56 MHz read/write
5A9020.44	Transponder tag, white housing, MIFARE Classic, 1 kB, 13.56 MHz read/write
5A9020.45	Transponder tag, yellow housing, MIFARE Classic, 1 kB, 13.56 MHz read/write
5A9020.46	Transponder tag, red housing, MIFARE Classic, 1 kB, 13.56 MHz read/write
5A9020.47	Transponder tag, green housing, MIFARE Classic, 1 kB, 13.56 MHz read/write
5A9020.48	Transponder tag, blue housing, MIFARE Classic, 1 kB, 13.56 MHz read/write

#### Information:

The tag must be held ca. 0.5 cm from the front of the device for the RFID read/write unit to function properly (ISO 15693 and ISO 14443). Placing flush may cause a temporary loss of communication.

#### Information:

For additional information about the RFID read/write unit, see the technical description for the 5E9030.29.

### 4.1.6.3.3 B&R illuminated ring keys

Each key and LED can be individually configured and adapted to the application. Various B&R tools are available for this purpose:

- B&R Key Editor, B&R KCF Editor or B&R Control Center for Windows operating systems
- Visual Components (VC) for Automation Runtime
- Direct wiring

Keys and LEDs from each device are processed by the matrix controller in a bit string of 128 bits each.

#### 4.1.6.3.3.1 Windows

The positions of the keys and LEDs in the matrix are displayed as hardware numbers and can be read directly on the target system using B&R tools and the ADI Control Center.

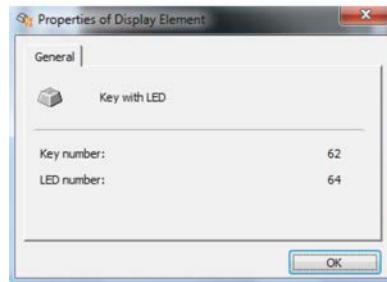

B&R Key Editor

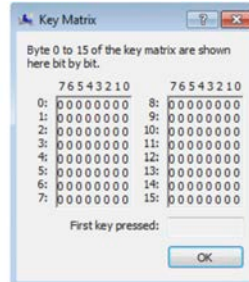

ADI Control Center



### 4.1.6.3.3.2 Visual Components

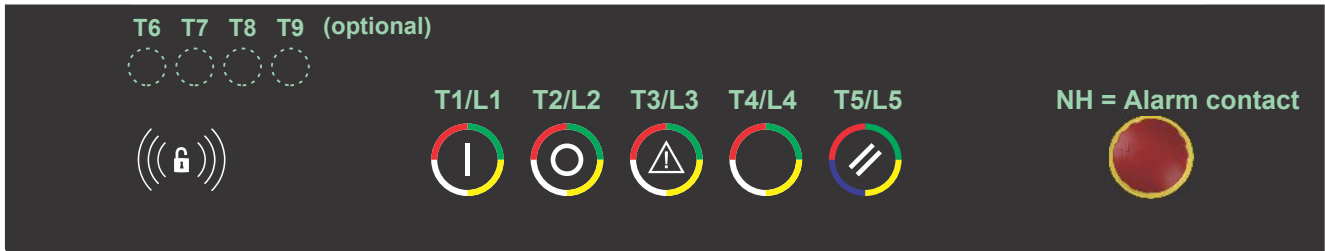

When using a key or LED matrix in Visual Components (**Visu / Runtime / Matrix**) in VC, the corresponding offsets are assigned according to the following table:

Key and LED matrix - Offset		
Offset	Key	LED <sup>1)</sup>
0	T1	L1
1	T2	L2
2	T3	L3
3	T4	L4
4	T5	L5
5	NH	x
6	x	L1
7	x	L2
8	x	L3
9	x	L4
10	x	L5
11	x	L1
12	x	L2
13	x	L3
14	x	L4
15	x	L5
16	T6 (opt.)	x
17	T7 (opt.)	x
18	T8 (opt.)	x
19	T9 (opt.)	x
Colors (LED lighting)		
Yellow <sup>1)</sup>	Green	Red
Blue	White	-

1) The yellow illumination color is generated by setting green and red simultaneously.

When using a key or LED matrix in Visual Components (**Visu / Runtime / Matrix**), **Examples:** the offsets correspond to the respective order number - 1.

- Key 1 = Offset 0
- LED 5 = Offset 4

The following data types and data values are permitted in each case:

	Type	Value		Type	Value
Keys	BOOL	False = Off	LEDs	BOOL	False = Off
		True = On			True = On
	INTEGER	0 = Off		INTEGER	0 = Off
		1 = On			1 = On
-	-	2 = Flash slowly			
		3 = Flash quickly			

### 4.1.6.3.3.3 Direct wiring

Keys and LEDs can optionally be wired directly.

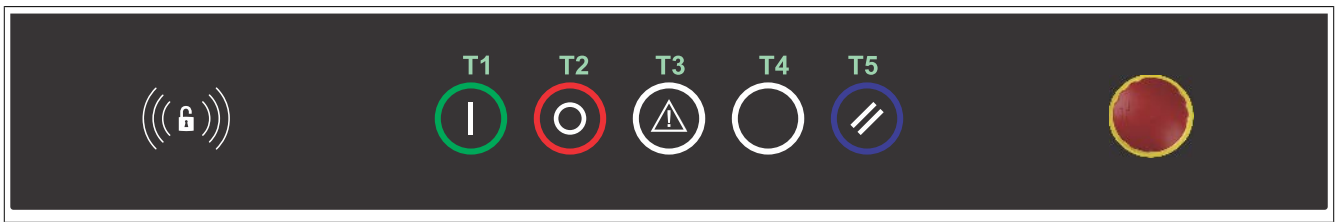

Figure 5: Key and LED assignments - Direct wiring

12-pin multipoint connector - Pinout		
<b>Accessories</b>		
0TB1112.8010	RM 3.5 12-pin screw clamp terminal block, 1.5 mm <sup>2</sup>	
PIN	Description	
1	24 VDC	24 V ±25%
2	T1_OUT	<0.5 A
3	T2_OUT	
4	T3_OUT	
5	T4_OUT	
6	T5_OUT	
7	Green_T1_IN	24 V ±25%
8	Red_T2_IN	
9	White_T3_IN	
10	White_T4_IN	
11	Blue_T5_IN	
12	GND	

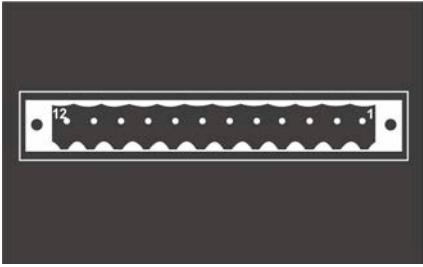

Table 2: 12-pin multipoint connector - Pinout

12-pin multipoint connector - Circuit diagram					
24 VDC	Customer In	1	24 VDC		
		2	T1_OUT		
		3	T2_OUT		
		4	T3_OUT		
		5	T4_OUT		
		6	T5_OUT		
		Customer In	7	Green_T1_IN	
		Customer In	8	Red_T2_IN	
		Customer In	9	White_T3_IN	
		Customer In	10	White_T4_IN	
		Customer In	11	Blue_T5_IN	
		Customer In	12	GND	

Table 3: 12-pin multipoint connector - Circuit diagram

### 4.1.6.3.4 Emergency stop

4-pin multipoint connector - Pinout	
<b>Accessories</b>	
0TB1104.8100	RM 3.5 mm, 4-pin cage clamp terminal block
<b>Pin</b>	<b>Description</b>
1	NC 11/12
2	
3	
4	NC 21/22

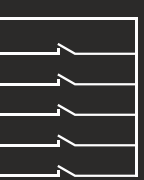
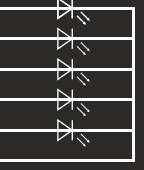
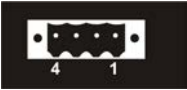

### 4.1.6.3.5 Connection for optional keys

Connector pinout (5-pin connector)	
<b>Accessories</b>	
0TB705.81	RM 3.5 mm, 5-pin cage clamp terminal block



For the assignment of the optional keys, see table "Key and LED matrix - Offset" on page 65.

### 4.1.6.3.6 Slide-in labels

Panels with keys are delivered with inserted, transparent slide-in labels in the function keys. These can be labeled by hand.

It is also possible to download a template for slide-in labels with individual captions from the B&R website ([www.br-automation.com](http://www.br-automation.com)).

The slots provided for slide-in labels are accessible on the rear of the Automation Panel devices, see "Device labeling with slide-in labels" on page 106.

## 4.2 Individual components

### 4.2.1 Panels

#### 4.2.1.1 5AP92D.1505-I00

##### 4.2.1.1.1 General information

- Single-touch (analog, resistive), with fully laminated panel overlay (shatter protection)
- IP69K protection (front), IP66 protection (back)
- Front and housing made of stainless steel (hygienic design, no dirt-collecting edge)
- B&R panel overlay design, edge protection for the panel overlay
- Prepared for mounting on Rittal CP-S stainless steel swing arm system (flange not included in delivery)
- Rear USB interface with cover and anti-loss strap

##### 4.2.1.1.2 Order data

Order number	Short description	Figure
	<b>Panels</b>	
5AP92D.1505-I00	- Automation Panel 15" XGA TFT - Single-touch (analog, resistive) - 1024 x 768 pixels - Protection: IP69K (front), IP66 (back) - Front/Housing made of stainless steel (hygienic design) - Prepared for mounting on Rittal CP-S stainless steel swing arm system (flange not included in delivery) - USB port on back	

##### 4.2.1.1.3 Technical data

Order number	5AP92D.1505-I00
<b>General information</b>	
B&R ID code	0xF2A5
Certifications	
CE	Yes
UL	cULus E115267 Industrial control equipment
EAC	Yes
<b>Display</b>	
Type	TFT color
Diagonal	15"
Colors	16.7 million
Resolution	XGA, 1024 x 768 pixels
Contrast	700:1
Viewing angles	
Horizontal	Direction R / Direction L = 80°
Vertical	Direction U / Direction D = 70°
Backlight	
Type	LED
Brightness	Typ. 20 to 400 cd/m <sup>2</sup>
Half-brightness time <sup>1)</sup>	50,000 h
Touch screen	
Technology	Analog, resistive
Controller	B&R, serial, 12-bit
Transmittance	Up to 78%
<b>Operating conditions</b>	
Pollution degree per EN 61131-2	Pollution degree 2
Suitable for hygienic applications	Yes
Degree of protection per EN 60529	Back: IP66 (only with flange installed) Front: IP69K <sup>2)</sup>
Degree of protection per UL 50	Front: Type 4X indoor use only
<b>Mechanical properties</b>	
Note	The housing is designed for installation on a Rittal CP-S stainless steel flange (CP6664.500 or CP6664.000)
Housing	
Material	Stainless steel 1.4301, smoothed

Order number	5AP92D.1505-I00
Front	
Frame	Stainless steel 1.4301, smoothed
Panel overlay	
Material	Polyester
Design	B&R design
Gasket	Silicone profile gasket between front and cover
Flange output	Rear
Dimensions	
Width	420 mm
Height	344 mm
Depth	71.5 mm
Weight	6,700 g

- 1) At 25°C ambient temperature. Reducing the brightness by 50% can increase the half-brightness time by approximately 50%.
- 2) The structured coating on the front can become loose under a steam jet, however. This only affects the appearance of the front; functionality is not impaired.

#### 4.2.1.1.4 Dimensions

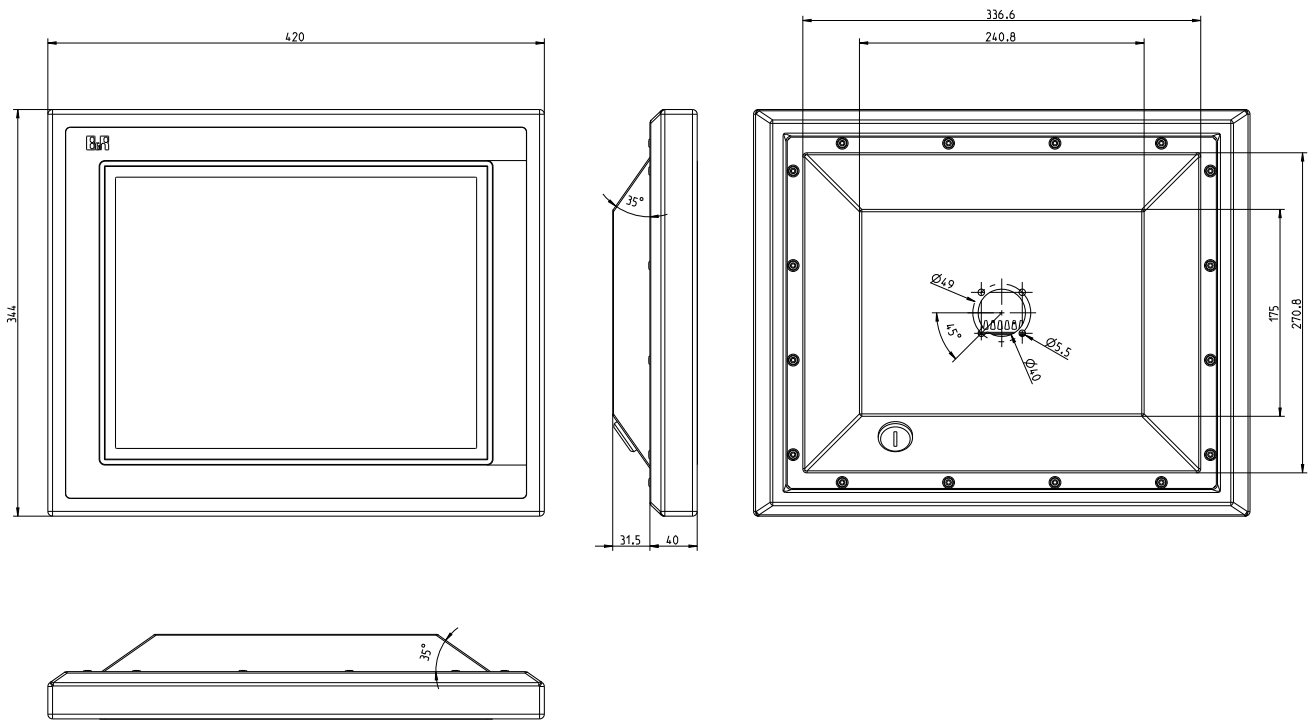

#### Information:

2D and 3D diagrams (DXF and STEP formats) can be downloaded from the B&R website ([www.br-automation.com](http://www.br-automation.com)).

#### 4.2.1.2 5AP92D.1906-I00

##### 4.2.1.2.1 General information

- Single-touch (analog, resistive), with fully laminated panel overlay (shatter protection)
- IP69K protection (front), IP66 protection (back)
- Front and housing made of stainless steel (hygienic design, no dirt-collecting edge)
- B&R panel overlay design, edge protection for the panel overlay
- Prepared for mounting on Rittal CP-S stainless steel swing arm system (flange not included in delivery)
- Rear USB interface with cover and anti-loss strap

##### 4.2.1.2.2 Order data

Order number	Short description	Figure
	<b>Panels</b>	
5AP92D.1906-I00	- Automation Panel 19" SXGA TFT - Single-touch (analog, resistive) - 1280 x 1024 pixels - Protection: IP69K (front), IP66 (back) - Front/Housing made of stainless steel (hygienic design) - Prepared for mounting on Rittal CP-S stainless steel swing arm system (flange not included in delivery) - USB port on back	

Table 6: 5AP92D.1906-I00 - Order data

##### 4.2.1.2.3 Technical data

Order number	5AP92D.1906-I00
<b>General information</b>	
B&R ID code	0xF2A6
Certifications	
CE	Yes
UL	cULus E115267 Industrial control equipment
EAC	Yes
<b>Display</b>	
Type	TFT color
Diagonal	19"
Colors	16.7 million
Resolution	SXGA, 1280 x 1024 pixels
Contrast	1500:1
Viewing angles	
Horizontal	Direction R / Direction L = 85°
Vertical	Direction U / Direction D = 85°
Backlight	
Type	LED
Brightness	Typ. 35 to 350 cd/m <sup>2</sup>
Half-brightness time <sup>1)</sup>	70,000 h
Touch screen	
Technology	Analog, resistive
Controller	B&R, serial, 12-bit
Transmittance	Up to 78%
<b>Operating conditions</b>	
Pollution degree per EN 61131-2	Pollution degree 2
Suitable for hygienic applications	Yes
Degree of protection per EN 60529	Back: IP66 (only with flange installed) Front: IP69K <sup>2)</sup>
Degree of protection per UL 50	Front: Type 4X indoor use only
<b>Mechanical properties</b>	
Note	The housing is designed for installation on a Rittal CP-S stainless steel flange (CP6664.500 or CP6664.000)
Housing	
Material	Stainless steel 1.4301, smoothed

Table 7: 5AP92D.1906-I00 - Technical data

Order number	5AP92D.1906-I00
Front	
Frame	Stainless steel 1.4301, smoothed
Panel overlay	
Material	Polyester
Design	B&R design
Gasket	Silicone profile gasket between front and cover
Flange output	Rear
Dimensions	
Width	514 mm
Height	420 mm
Depth	78.5 mm
Weight	10,000 g

Table 7: 5AP92D.1906-I00 - Technical data

- 1) At 25°C ambient temperature. Reducing the brightness by 50% can increase the half-brightness time by approximately 50%.
- 2) The structured coating on the front can become loose under a steam jet, however. This only affects the appearance of the front; functionality is not impaired.

#### 4.2.1.2.4 Dimensions

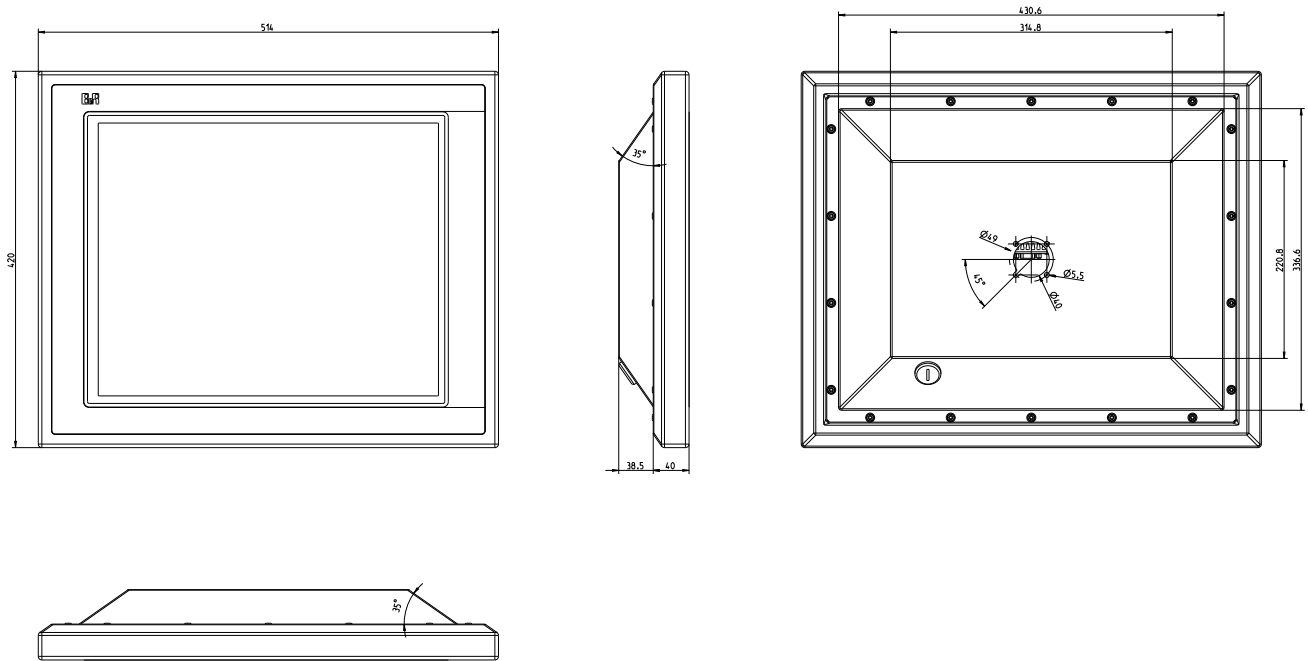

### Information:

2D and 3D diagrams (DXF and STEP formats) can be downloaded from the B&R website ([www.br-automation.com](http://www.br-automation.com)).

### 4.2.1.3 5AP93D.185B-B62

#### 4.2.1.3.1 General information

- Multi-touch (projected capacitive); with fully-laminated panel overlay (shatter protection)
- IP69K protection (front), IP66 protection (back)
- Front and housing made of stainless steel (hygienic design, no dirt-collecting edge)
- B&R panel overlay design, edge protection for the panel overlay
- Prepared for mounting on Rittal CP-S stainless steel swing arm system (flange not included in delivery)
- Flange output possible on top or bottom
- Rear USB interface with cover and anti-loss strap

#### 4.2.1.3.2 Order data

Order number	Short description	Figure
	<b>Panels</b>	
5AP93D.185B-B62	- Automation Panel 18.5" HD TFT - Multi-touch (projected capacitive) - 1366 x 768 pixels (16:9) - Protection: IP69K (front), IP66 (back) - Front/Housing made of stainless steel (hygienic design) - Prepared for mounting on Rittal CP-S stainless steel swing arm system (flange not included in delivery) - Flange possible on top or bottom - USB port on back	

#### 4.2.1.3.3 Technical data

Order number	5AP93D.185B-B62
<b>General information</b>	
B&R ID code	0xE8C2
Certifications	
CE	Yes
UL	cULus E115267 Industrial control equipment
EAC	Yes
<b>Display</b>	
Type	TFT color
Diagonal	18.5"
Colors	16.7 million
Resolution	HD, 1366 x 768 pixels
Contrast	1000:1
Viewing angles	
Horizontal	Direction R / Direction L = 170°
Vertical	Direction U / Direction D = 160°
Backlight	
Type	LED
Brightness	300 cd/m <sup>2</sup>
Half-brightness time <sup>1)</sup>	50,000 h
Touch screen	
Technology	Projected capacitive touch (PCT) (with shatter protection)
Transmittance	>90%
<b>Operating conditions</b>	
Pollution degree per EN 61131-2	Pollution degree 2
Suitable for hygienic applications	Yes
Degree of protection per EN 60529	Back: IP66 (only with flange installed) Front: IP69K <sup>2)</sup>
Degree of protection per UL 50	Front: Type 4X indoor use only
<b>Mechanical properties</b>	
Note	The housing is designed for installation on a Rittal CP-S stainless steel flange (CP6664.500 or CP6664.000)
Housing	
Material	Stainless steel 1.4301, smoothed
Front	
Frame	Stainless steel 1.4301, smoothed
Panel overlay	
Material	Polyester
Design	B&R design
Gasket	Silicone profile gasket between front and cover
Flange output	Upper and lower



Order number	5AP93D.185B-B62
Dimensions	
Width	507.2 mm
Height	327.8 mm
Depth	141.6 mm
Weight	8,800 g

- 1) At 25°C ambient temperature. Reducing the brightness by 50% can increase the half-brightness time by approximately 50%.
- 2) The structured coating on the front can become loose under a steam jet, however. This only affects the appearance of the front; functionality is not impaired.

#### 4.2.1.3.4 Dimensions

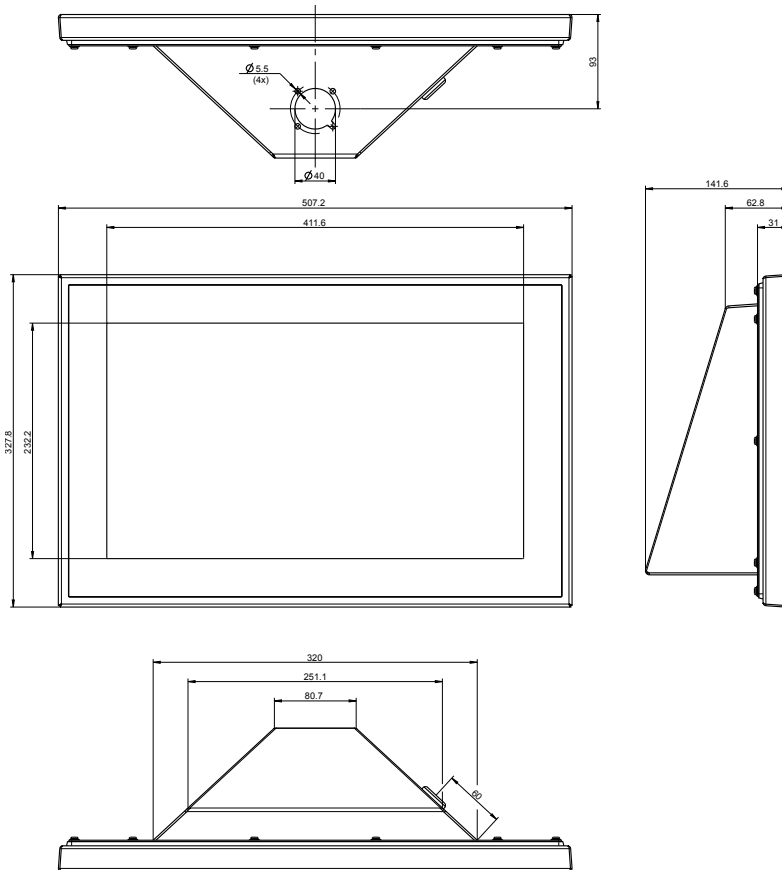

#### Information:

2D and 3D diagrams (DXF and STEP formats) can be downloaded from the B&R website ([www.br-automation.com](http://www.br-automation.com)).

#### 4.2.1.4 5AP93D.240C-B62

##### 4.2.1.4.1 General information

- Multi-touch (projected capacitive); with fully-laminated panel overlay (shatter protection)
- IP69K protection (front), IP66 protection (back)
- Front and housing made of stainless steel (hygienic design, no dirt-collecting edge)
- B&R panel overlay design, edge protection for the panel overlay
- Prepared for mounting on Rittal CP-S stainless steel swing arm system (flange not included in delivery)
- Flange output possible on top or bottom
- Rear USB interface with cover and anti-loss strap

##### 4.2.1.4.2 Order data

Order number	Short description	Figure
	<b>Panels</b>	
5AP93D.240C-B62	- Automation Panel 24.0" Full HD TFT - Multi-touch (projected capacitive) - 1920 x 1080 pixels (16:9) - Protection: IP69K (front), IP66 (back) - Front/Housing made of stainless steel (hygienic design) - Prepared for mounting on Rittal CP-S stainless steel swing arm system (flange not included in delivery) - Flange possible on top or bottom - USB port on back	

##### 4.2.1.4.3 Technical data

Order number	5AP93D.240C-B62
<b>General information</b>	
B&R ID code	0xE8C3
Certifications	
CE	Yes
UL	cULus E115267 Industrial control equipment
EAC	Yes
<b>Display</b>	
Type	TFT color
Diagonal	24.0"
Colors	16.7 million
Resolution	FHD, 1920 x 1080 pixels
Contrast	5000:1
Viewing angles	
Horizontal	Direction R / Direction L = 89°
Vertical	Direction U / Direction D = 89°
Backlight	
Type	LED
Brightness	300 cd/m <sup>2</sup>
Half-brightness time <sup>1)</sup>	50,000 h
Touch screen	
Technology	Projected capacitive touch (PCT) (with shatter protection)
Transmittance	>90%
<b>Operating conditions</b>	
Pollution degree per EN 61131-2	Pollution degree 2
Suitable for hygienic applications	Yes
Degree of protection per EN 60529	Back: IP66 (only with flange installed) Front: IP69K <sup>2)</sup>
Degree of protection per UL 50	Front: Type 4X indoor use only
<b>Mechanical properties</b>	
Note	The housing is designed for installation on a Rittal CP-S stainless steel flange (CP6664.500 or CP6664.000)
Housing	
Material	Stainless steel 1.4301, smoothed
Front	
Frame	Stainless steel 1.4301, smoothed
Panel overlay	
Material	Polyester
Design	B&R design
Gasket	Silicone profile gasket between front and cover
Flange output	Upper and lower

Order number	5AP93D.240C-B62
Dimensions	
Width	630.2 mm
Height	396.8 mm
Depth	141.91 mm
Weight	12,300 g

- 1) At 25°C ambient temperature. Reducing the brightness by 50% can increase the half-brightness time by approximately 50%.
- 2) The structured coating on the front can become loose under a steam jet, however. This only affects the appearance of the front; functionality is not impaired.

#### 4.2.1.4.4 Dimensions

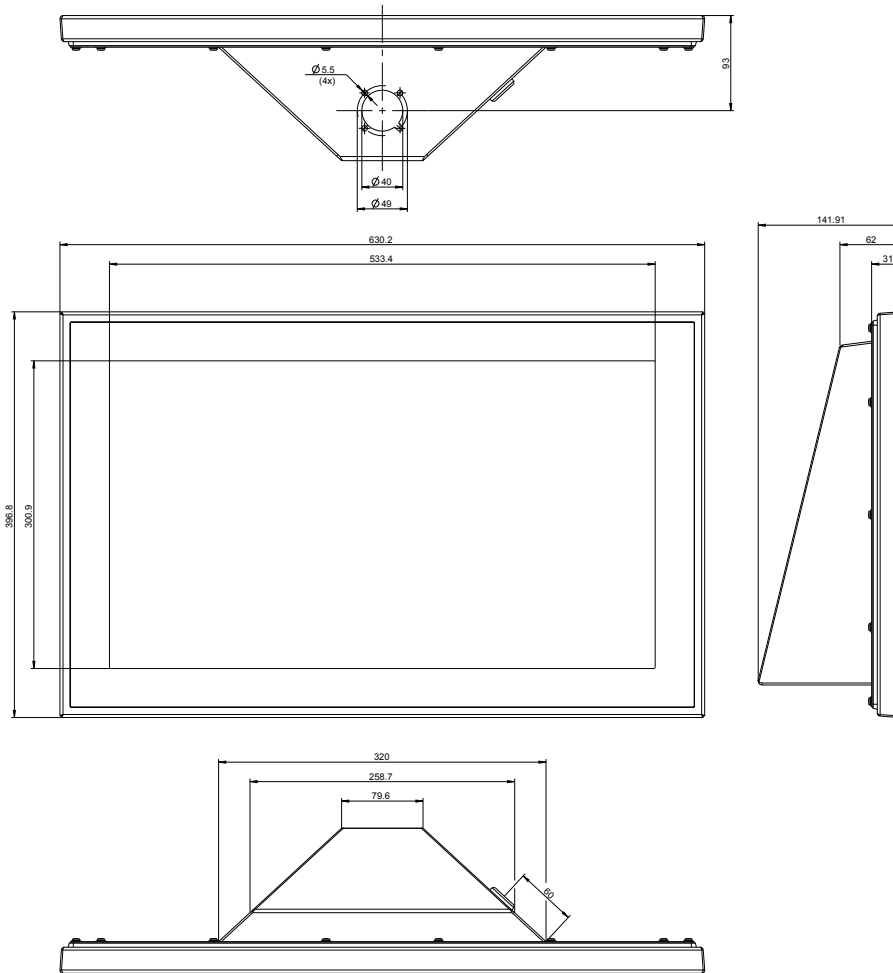

#### Information:

2D and 3D diagrams (DXF and STEP formats) can be downloaded from the B&R website ([www.br-automation.com](http://www.br-automation.com)).

### 4.2.1.5 5AP99D.156B-B62

#### 4.2.1.5.1 General information

- Multi-touch (projected capacitive); with fully-laminated panel overlay (shatter protection)
- Protection: IP69K (front), IP66 (back)
- Front/Housing made of stainless steel (hygienic design, no dirt-collecting edge)
- B&R panel overlay design, edge protection for the panel overlay
- Emergency stop, hygienic design
- 13.56 MHz read/write transponder unit, MIFARE Classic
- 1 prepared cutout for optional operating elements (ø 22.5 mm)
- 5 B&R illuminated ring keys, 4-color (4x yellow, green, red, white and 1x yellow, green, red, blue)
- Prepared for mounting on Rittal CP-S stainless steel swing arm system (flange not included in delivery)
- Flange output possible on top or bottom
- Rear USB interface with cover and anti-loss strap

#### 4.2.1.5.2 Order data

Order number	Short description	Figure
5AP99D.156B-B62	<p><b>Panels</b></p> <p>- Automation Panel 15.6" HD TFT - Multi-touch (projected capacitive) - 1366 x 768 pixels (16:9) - Protection: IP69K (front), IP66 (back) - Front/Housing made of stainless steel (hygienic design) - Emergency stop, hygienic design - 5 B&amp;R illuminated ring keys, 4-color (4x yellow, green, red, white and 1x yellow, green, red, blue) - Prepared for mounting on Rittal CP-S stainless steel swing arm system (flange not included in delivery) - Flange possible on top or bottom - USB port on back - RFID read/write unit</p>	

#### 4.2.1.5.3 Technical data

Order number	5AP99D.156B-B62
<b>General information</b>	
B&R ID code	0xE8C4
Certifications	
CE	Yes
UL	cULus E115267 Industrial control equipment
EAC	Yes
<b>Display</b>	
Type	TFT color
Diagonal	15.6"
Colors	16.7 million
Resolution	HD, 1366 x 768 pixels
Contrast	500:1
Viewing angles	
Horizontal	Direction R / Direction L = 85°
Vertical	Direction U / Direction D = 80°
Backlight	
Type	LED
Brightness	300 cd/m <sup>2</sup>
Half-brightness time <sup>1)</sup>	50,000 h
Touch screen	
Technology	Projected capacitive touch (PCT) (with shatter protection)
Transmittance	>90%
<b>Interfaces</b>	
RFID read/write transponder unit	
Type	For I-Code SLI transponder, amplitude modulation and MIFARE Classic
Frequency	13.56 MHz
Read/Write range in air	Approx. 1 to 3 cm
<b>Keys</b>	
Illuminated ring keys	5x B&R illuminated ring keys
Illuminated ring keys	
Color	4x red, green, yellow, white 1x red, green, yellow, blue

<b>Order number</b>	<b>5AP99D.156B-B62</b>
<b>Features</b>	
Emergency stop	
Type	Schlegel FRVK series <sup>2)</sup>
Contact element	2x normally closed contact, 1x normally open contact
Optional operating elements	
Quantity	1x prepared cutout
<b>Operating conditions</b>	
Pollution degree per EN 61131-2	Pollution degree 2
Suitable for hygienic applications	Yes
Degree of protection per EN 60529	Back: IP66 (only with flange installed) Front: IP69K <sup>2)3)</sup>
Degree of protection per UL 50	Front: Type 4X indoor use only
<b>Mechanical properties</b>	
Note	The housing is designed for installation on a Rittal CP-S stainless steel flange (CP6664.500 or CP6664.000)
Housing	
Material	Stainless steel 1.4301, smoothed
Front	
Frame	Stainless steel 1.4301, smoothed
Panel overlay	
Material	Polyester
Design	B&R design
Gasket	Silicone profile gasket between front and cover
Flange output	Upper and lower
Dimensions	
Width	446.2 mm
Height	333.2 mm
Depth	143 mm (without emergency stop)
Weight	7,800 g

- 1) At 25°C ambient temperature. Reducing the brightness by 50% can increase the half-brightness time by approximately 50%.
- 2) Emergency stop according to manufacturer as of October 2019, limitation: nozzle spacing > 250 mm, standard requirement per ISO 20653:2013-02 (IPX9K) 100 - 150 mm
- 3) The structured coating on the front can become loose under a steam jet, however. This only affects the appearance of the front; functionality is not impaired.

#### 4.2.1.5.4 Dimensions

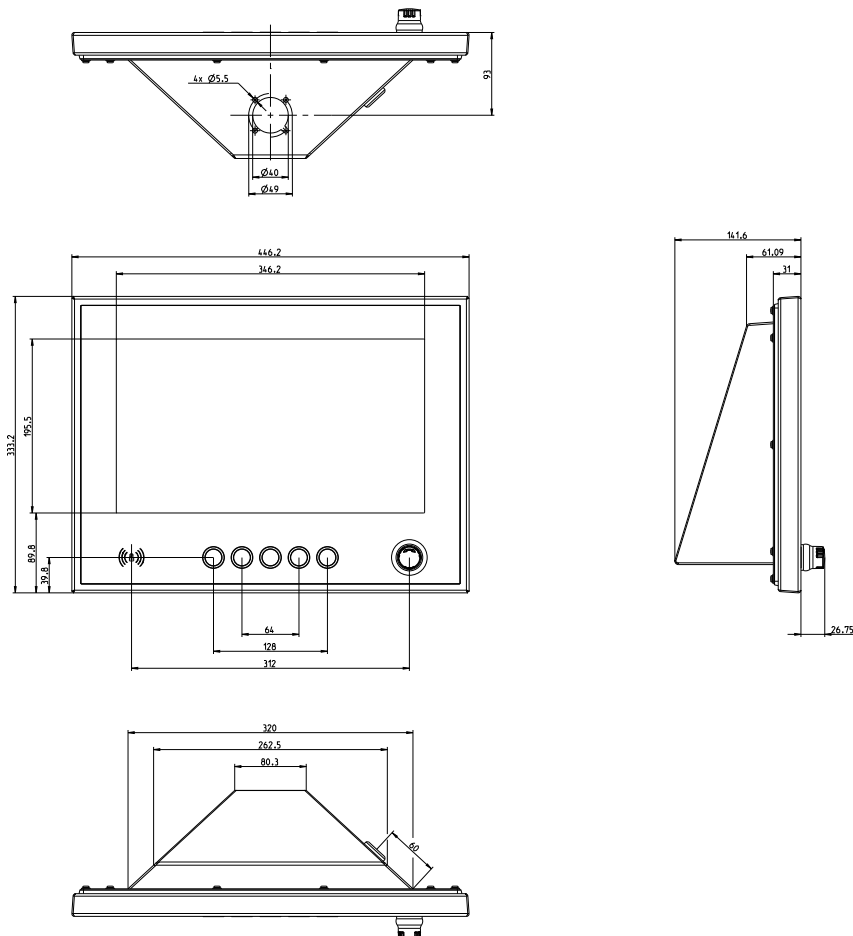

## Information:

2D and 3D diagrams (DXF and STEP formats) can be downloaded from the B&R website ([www.br-automation.com](http://www.br-automation.com)).

#### 4.2.1.6 5AP99D.185B-B62

##### 4.2.1.6.1 General information

- Multi-touch (projected capacitive); with fully-laminated panel overlay (shatter protection)
- Protection: IP69K (front), IP66 (back)
- Front/Housing made of stainless steel (hygienic design, no dirt-collecting edge)
- B&R panel overlay design, edge protection for the panel overlay
- Emergency stop, hygienic design
- 13.56 MHz read/write transponder unit, MIFARE Classic
- 2 prepared cutouts for optional operating elements (ø 22.5 mm)
- 5 B&R illuminated ring keys, 4-color (4x yellow, green, red, white and 1x yellow, green, red, blue)
- Prepared for mounting on Rittal CP-S stainless steel swing arm system (flange not included in delivery)
- Flange output possible on top or bottom
- Rear USB interface with cover and anti-loss strap

##### 4.2.1.6.2 Order data

Order number	Short description	Figure
5AP99D.185B-B62	<b>Panels</b> - Automation Panel 18.5" HD TFT - Multi-touch (projected capacitive) - 1366 x 768 pixels (16:9) - Protection: IP69K (front), IP66 (back) - Front/Housing made of stainless steel (hygienic design) - Emergency stop, hygienic design - 5 B&R illuminated ring keys, 4-color (4x yellow, green, red, white and 1x yellow, green, red, blue) - Prepared for mounting on Rittal CP-S stainless steel swing arm system (flange not included in delivery) - Flange possible on top or bottom - USB port on back - RFID read/write unit	

##### 4.2.1.6.3 Technical data

Order number	5AP99D.185B-B62
<b>General information</b>	
B&R ID code	0xE8C5
Certifications	
CE	Yes
UL	cULus E115267 Industrial control equipment
EAC	Yes
<b>Display</b>	
Type	TFT color
Diagonal	18.5"
Colors	16.7 million
Resolution	HD, 1366 x 768 pixels
Contrast	1000:1
Viewing angles	
Horizontal	Direction R / Direction L = 170°
Vertical	Direction U / Direction D = 160°
Backlight	
Type	LED
Brightness	300 cd/m <sup>2</sup>
Half-brightness time <sup>1)</sup>	50,000 h
Touch screen	
Technology	Projected capacitive touch (PCT) (with shatter protection)
Transmittance	>90%
<b>Interfaces</b>	
RFID read/write transponder unit	
Type	For I-Code SLI transponder, amplitude modulation and MIFARE Classic
Frequency	13.56 MHz
Read/Write range in air	Approx. 1 to 3 cm
<b>Keys</b>	
Illuminated ring keys	5x B&R illuminated ring keys
Illuminated ring keys	
Color	4x red, green, yellow, white 1x red, green, yellow, blue

## Technical data

<b>Order number</b>	<b>5AP99D.185B-B62</b>
<b>Features</b>	
Emergency stop	
Type	Schlegel FRVK series <sup>2)</sup>
Contact element	2x normally closed contact, 1x normally open contact
Optional operating elements	
Quantity	2x prepared cutout
<b>Operating conditions</b>	
Pollution degree per EN 61131-2	Pollution degree 2
Suitable for hygienic applications	Yes
Degree of protection per EN 60529	Back: IP66 (only with flange installed) Front: IP69K <sup>2)3)</sup>
Degree of protection per UL 50	Front: Type 4X indoor use only
<b>Mechanical properties</b>	
Note	The housing is designed for installation on a Rittal CP-S stainless steel flange (CP6664.500 or CP6664.000)
Housing	
Material	Stainless steel 1.4301, smoothed
Front	
Frame	Stainless steel 1.4301, smoothed
Panel overlay	
Material	Polyester
Design	B&R design
Gasket	Silicone profile gasket between front and cover
Flange output	Upper and lower
Dimensions	
Width	507.2 mm
Height	369.7 mm
Depth	141.6 mm (without emergency stop)
Weight	9,550 g

- 1) At 25°C ambient temperature. Reducing the brightness by 50% can increase the half-brightness time by approximately 50%.
- 2) Emergency stop according to manufacturer as of October 2019, limitation: nozzle spacing > 250 mm, standard requirement per ISO 20653:2013-02 (IPX9K) 100 - 150 mm
- 3) The structured coating on the front can become loose under a steam jet, however. This only affects the appearance of the front; functionality is not impaired.



### 4.2.1.6.4 Dimensions

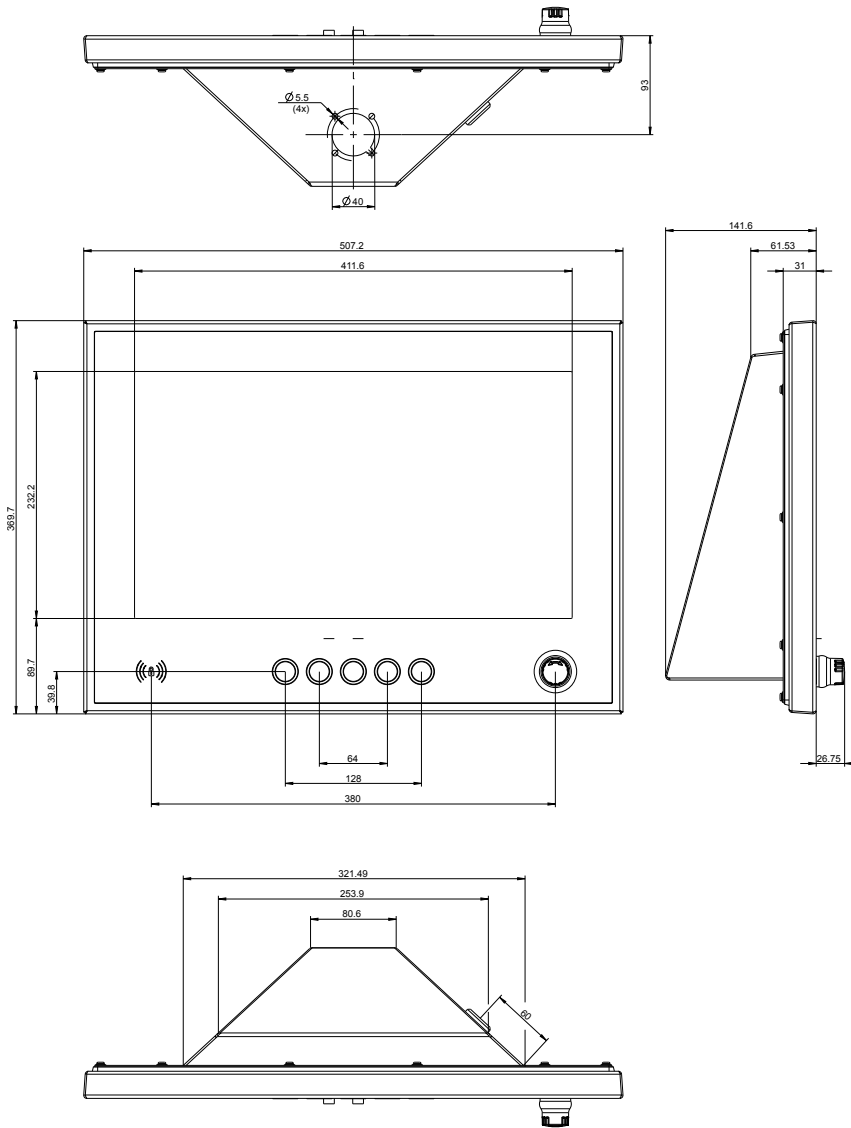

#### Information:

2D and 3D diagrams (DXF and STEP formats) can be downloaded from the B&R website ([www.br-automation.com](http://www.br-automation.com)).

### 4.2.1.7 5AP99D.185C-B62

#### 4.2.1.7.1 General information

- Multi-touch (projected capacitive); with fully-laminated panel overlay (shatter protection)
- Protection: IP69K (front), IP66 (back)
- Front/Housing made of stainless steel (hygienic design, no dirt-collecting edge)
- B&R panel overlay design, edge protection for the panel overlay
- Emergency stop, hygienic design
- 13.56 MHz read/write transponder unit, MIFARE Classic
- 2 prepared cutouts for optional operating elements (ø 22.5 mm)
- 5 B&R illuminated ring keys, 4-color (4x yellow, green, red, white and 1x yellow, green, red, blue)
- Prepared for mounting on Rittal CP-S stainless steel swing arm system (flange not included in delivery)
- Flange output possible on top or bottom
- Rear USB interface with cover and anti-loss strap

#### 4.2.1.7.2 Order data

Order number	Short description	Figure
5AP99D.185C-B62	<b>Panels</b> - Automation Panel 18.5" FHD TFT - Multi-touch (projected capacitive) - 1920 x 1080 pixels (16:9) - Protection: IP69K (front), IP66 (back) - Front/Housing made of stainless steel (hygienic design) - Emergency stop, hygienic design - 5 B&R illuminated ring keys, 4-color (4x yellow, green, red, white and 1x yellow, green, red, blue) - Prepared for mounting on Rittal CP-S stainless steel swing arm system (flange not included in delivery) - Flange possible on top or bottom - USB port on back - RFID read/write unit	

#### 4.2.1.7.3 Technical data

Order number	5AP99D.185C-B62
<b>General information</b>	
B&R ID code	0x2A0B
Certifications	
CE	Yes
UL	In preparation
EAC	Yes
<b>Display</b>	
Type	TFT color
Diagonal	18.5"
Colors	16.7 million
Resolution	FHD, 1920 x 1080 pixels
Contrast	1500:1
Viewing angles	
Horizontal	Direction R / Direction L = 85°
Vertical	Direction U / Direction D = 85°
Backlight	
Type	LED
Brightness	Typ. 40 to 400 cd/m <sup>2</sup>
Half-brightness time <sup>1)</sup>	50,000 h
Touch screen	
Technology	Projected capacitive touch (PCT) (with shatter protection)
Transmittance	>90%
<b>Interfaces</b>	
RFID read/write transponder unit	
Type	For I-Code SLI transponder, amplitude modulation and MIFARE Classic
Frequency	13.56 MHz
Read/Write range in air	Approx. 1 to 3 cm
<b>Keys</b>	
Illuminated ring keys	5x B&R illuminated ring keys
Illuminated ring keys	
Color	4x red, green, yellow, white 1x red, green, yellow, blue

<b>Order number</b>	<b>5AP99D.185C-B62</b>
<b>Features</b>	
Emergency stop	
Type	Schlegel FRVK series <sup>2)</sup>
Contact element	2x normally closed contact, 1x normally open contact
Optional operating elements	
Quantity	2x prepared cutout
<b>Operating conditions</b>	
Pollution degree per EN 61131-2	Pollution degree 2
Suitable for hygienic applications	Yes
Degree of protection per EN 60529	Back: IP66 (only with flange installed) Front: IP69K <sup>2)3)</sup>
Degree of protection per UL 50	Front: Type 4X indoor use only
<b>Mechanical properties</b>	
Note	The housing is designed for installation on a Rittal CP-S stainless steel flange (CP6664.500 or CP6664.000)
Housing	
Material	Stainless steel 1.4301, smoothed
Front	
Frame	Stainless steel 1.4301, smoothed
Panel overlay	
Material	Polyester
Design	B&R design
Gasket	Silicone profile gasket between front and cover
Flange output	Upper and lower
Dimensions	
Width	507.2 mm
Height	369.7 mm
Depth	141.6 mm (without emergency stop)
Weight	9,550 g

- 1) At 25°C ambient temperature. Reducing the brightness by 50% can increase the half-brightness time by approximately 50%.
- 2) Emergency stop according to manufacturer as of October 2019, limitation: nozzle spacing > 250 mm, standard requirement per ISO 20653:2013-02 (IPX9K) 100 - 150 mm
- 3) The structured coating on the front can become loose under a steam jet, however. This only affects the appearance of the front; functionality is not impaired.

### 4.2.1.7.4 Dimensions

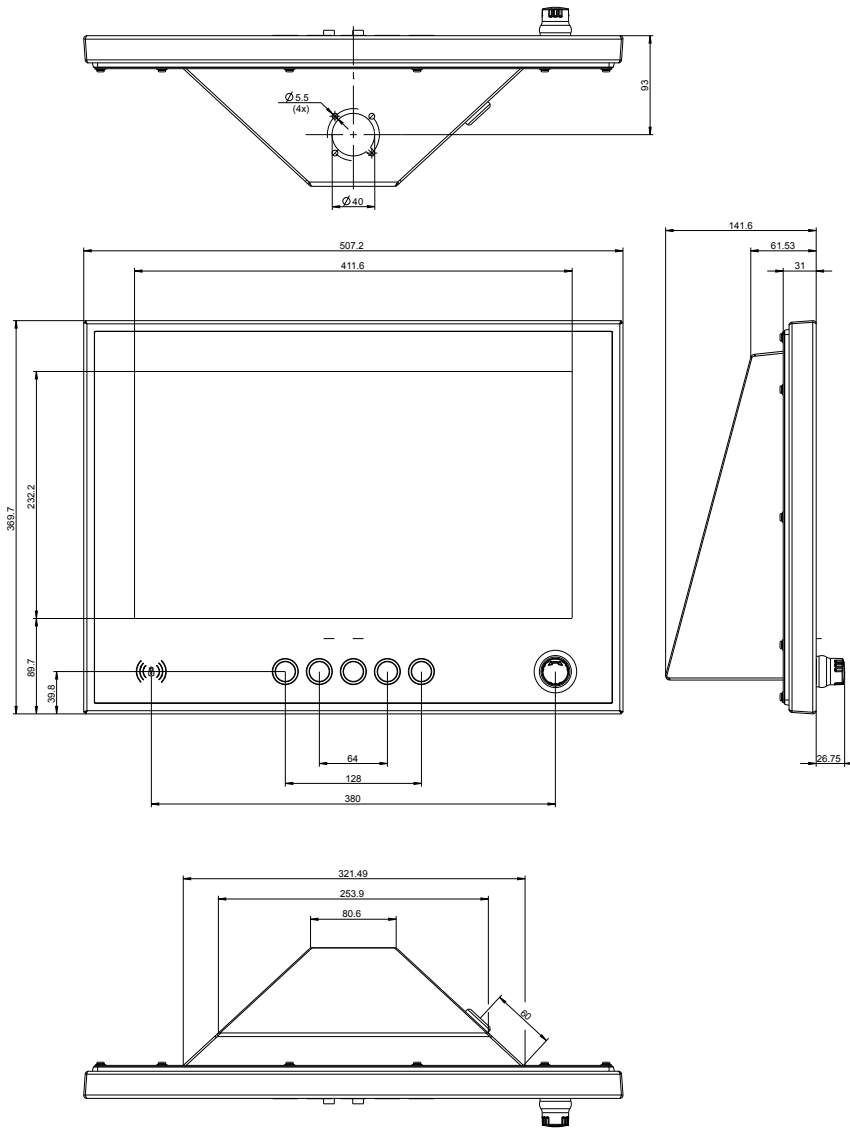

#### Information:

2D and 3D diagrams (DXF and STEP formats) can be downloaded from the B&R website ([www.br-automation.com](http://www.br-automation.com)).

### 4.2.1.8 5AP99D.215C-B62

#### 4.2.1.8.1 General information

- Multi-touch (projected capacitive); with fully-laminated panel overlay (shatter protection)
- Protection: IP69K (front), IP66 (back)
- Front/Housing made of stainless steel (hygienic design, no dirt-collecting edge)
- B&R panel overlay design, edge protection for the panel overlay
- Emergency stop, hygienic design
- 13.56 MHz read/write transponder unit, MIFARE Classic
- 2 prepared cutouts for optional operating elements (ø 22.5 mm)
- 5 B&R illuminated ring keys, 4-color (4x yellow, green, red, white and 1x yellow, green, red, blue)
- Prepared for mounting on Rittal CP-S stainless steel swing arm system (flange not included in delivery)
- Flange output possible on top or bottom
- Rear USB interface with cover and anti-loss strap

#### 4.2.1.8.2 Order data

Order number	Short description	Figure
5AP99D.215C-B62	<p><b>Panels</b></p> <p>- Automation Panel 21.5" Full HD TFT - Multi-touch (projected capacitive) - 1920 x 1080 pixels (16:9) - Protection: IP69K (front), IP66 (back) - Front/Housing made of stainless steel (hygienic design) - Emergency stop, hygienic design - 5 B&amp;R illuminated ring keys, 4-color (4x yellow, green, red, white and 1x yellow, green, red, blue) - Prepared for mounting on Rittal CP-S stainless steel swing arm system (flange not included in delivery) - Flange possible on top or bottom - USB port on back - RFID read/write unit</p>	

#### 4.2.1.8.3 Technical data

Order number	5AP99D.215C-B62
<b>General information</b>	
B&R ID code	0xE8C6
Certifications	
CE	Yes
UL	cULus E115267 Industrial control equipment
EAC	Yes
<b>Display</b>	
Type	TFT color
Diagonal	21.46"
Colors	16.7 million
Resolution	FHD, 1920 x 1080 pixels
Contrast	1000:1
Viewing angles	
Horizontal	Direction R / Direction L = 178°
Vertical	Direction U / Direction D = 178°
Backlight	
Type	LED
Brightness	250 cd/m <sup>2</sup>
Half-brightness time <sup>1)</sup>	30,000 h
Touch screen	
Technology	Projected capacitive touch (PCT) (with shatter protection)
Transmittance	>90%
<b>Interfaces</b>	
RFID read/write transponder unit	
Type	For I-Code SLI transponder, amplitude modulation and MIFARE Classic
Frequency	13.56 MHz
Read/Write range in air	Approx. 1 to 3 cm
<b>Keys</b>	
Illuminated ring keys	5x B&R illuminated ring keys
Illuminated ring keys	
Color	4x red, green, yellow, white 1x red, green, yellow, blue

## Technical data

<b>Order number</b>	<b>5AP99D.215C-B62</b>
<b>Features</b>	
Emergency stop	
Type	Schlegel FRVK series <sup>2)</sup>
Contact element	2x normally closed contact, 1x normally open contact
Optional operating elements	
Quantity	2x prepared cutout
<b>Operating conditions</b>	
Pollution degree per EN 61131-2	Pollution degree 2
Suitable for hygienic applications	Yes
Degree of protection per EN 60529	Back: IP66 (only with flange installed) Front: IP69K <sup>2)3)</sup>
Degree of protection per UL 50	Front: Type 4X indoor use only
<b>Mechanical properties</b>	
Note	The housing is designed for installation on a Rittal CP-S stainless steel flange (CP6664.500 or CP6664.000)
Housing	
Material	Stainless steel 1.4301, smoothed
Front	
Frame	Stainless steel 1.4301, smoothed
Panel overlay	
Material	Polyester
Design	B&R design
Gasket	Silicone profile gasket between front and cover
Flange output	Upper and lower
Dimensions	
Width	573.7 mm
Height	407.7 mm
Depth	143 mm (without emergency stop)
Weight	10,800 g

- 1) At 25°C ambient temperature. Reducing the brightness by 50% can increase the half-brightness time by approximately 50%.
- 2) Emergency stop according to manufacturer as of October 2019, limitation: nozzle spacing > 250 mm, standard requirement per ISO 20653:2013-02 (IPX9K) 100 - 150 mm
- 3) The structured coating on the front can become loose under a steam jet, however. This only affects the appearance of the front; functionality is not impaired.

### 4.2.1.8.4 Dimensions

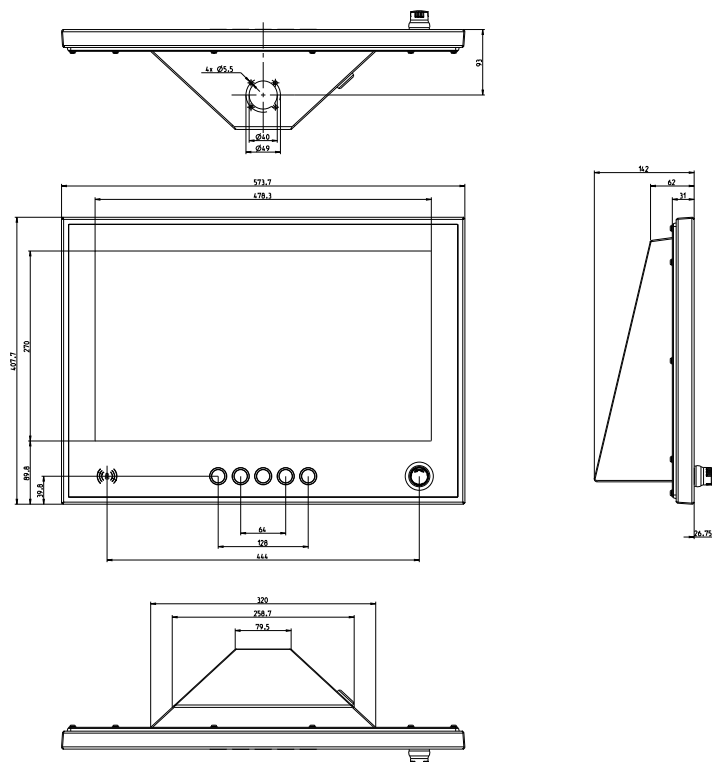

## Information:

2D and 3D diagrams (DXF and STEP formats) can be downloaded from the B&R website ([www.br-automation.com](http://www.br-automation.com)).

## 4.2.2 Link modules

### 4.2.2.1 5DLSDL.1001-00

#### 4.2.2.1.1 General information

- Link module for Automation Panel 9x3/1000/5000
- 1x SDL/DVI Panel In interface
- 2x USB 2.0 type A
- 1x USB In (USB type B)
- 1x RS232 interface
- Display brightness buttons

#### 4.2.2.1.2 Order data

Order number	Short description	Figure
	<b>Link modules</b>	
5DLSDL.1001-00	Automation Panel link module - SDL/DVI receiver - For Automation Panel 923/933/1000 - For Automation Panel 5000	
	<b>Required accessories</b>	
	<b>Accessories</b>	
0TB103.9	Connector 24 VDC - 3-pin, female - Screw clamp terminal block 3.31 mm <sup>2</sup>	
0TB103.91	Connector 24 VDC - 3-pin, female - Cage clamp terminal block 3.31 mm <sup>2</sup>	

#### 4.2.2.1.3 Technical data

### Information:

The following specified characteristic data, features and limit values are only valid for these individual components and may differ from those of the complete system. The data specified for the complete system applies to the complete system in which this individual component is used, for example.

Order number	5DLSDL.1001-00
<b>General information</b>	
B&R ID code	0xE1A4
Brightness buttons	Yes <sup>1)</sup>
Certifications	
CE	Yes
UKCA	Yes
UL	cULus E115267 Industrial control equipment
HazLoc	cULus HazLoc E180196 Industrial control equipment for hazardous locations Class I, Division 2, Groups ABCD, T4 <sup>2)</sup>
DNV <sup>3)</sup>	Temperature: <b>B</b> (0 - 55°C) Humidity: <b>B</b> (up to 100%) Vibration: <b>A</b> (0.7 g) EMC: <b>B</b> (bridge and open deck) <sup>4)</sup>
LR	ENV3
KR	Yes
ABS	Yes
BV	<b>EC31B</b> Temperature: 5 - 55°C Vibration: 0.7 g EMC: Bridge and open deck Product family certification
EAC	
<b>Interfaces</b>	
COM	
Type	RS232, modem supported, not galvanically isolated
Variant	DSUB, 9-pin, female
UART	16550-compatible, 16-byte FIFO buffer
Max. baud rate	115 kbit/s
USB	
Quantity	3 (2x Type A; 1x Type B)
Type	USB 2.0 <sup>5)</sup>
Variant	2x type A 1x type B
Transfer rate	Low speed (1.5 Mbit/s), full speed (12 Mbit/s) to high speed (480 Mbit/s)
Current-carrying capacity	Total max. 1 A <sup>6)</sup>

## Technical data

<b>Order number</b>	<b>5DLSDL.1001-00</b>
Panel In	
Variant	DVI-D
Type	SDL/DVI
<b>Electrical properties</b>	
Nominal voltage	24 VDC $\pm$ 25%, SELV <sup>7)</sup>
Nominal current	Max. 3 A
Overvoltage category per EN 61131-2	II
Galvanic isolation	Yes
<b>Operating conditions</b>	
Pollution degree per EN 61131-2	Pollution degree 2
<b>Mechanical properties</b>	
Dimensions	
Width	190 mm
Height	110 mm
Depth	23.6 mm
Weight	538 g

- 1) The brightness controls can be used to set the brightness of the backlight on the Automation Panel in DVI operation.
- 2) Yes, but applies only if all components installed in the complete system have this certification and the complete system bears the corresponding mark.
- 3) The following Automation Panel link module interfaces are not approved for use in DNV ambient conditions: COM, USB.
- 4) Yes, but applies only if all components installed in the complete system have this certification and are listed on the associated DNV certificate for the product family.
- 5) Max. USB 1.1 is possible in "SDL operation without USB cable".
- 6) For the 2 USB type A female connectors.
- 7) IEC 61010-2-201 requirements must be observed.



### 4.2.2.2 5DLSD3.1001-00

#### 4.2.2.2.1 General information

- Link module for Automation Panel 9x3/1000/5000
- 1x SDL3 Panel In interface
- 2x USB 2.0 type A

#### 4.2.2.2.2 Order data

Order number	Short description	Figure
	<b>Link modules</b>	
5DLSD3.1001-00	Automation Panel link module - SDL3 receiver - For Automation Panel 923/933/1000 - For Automation Panel 5000	
	<b>Required accessories</b>	
	<b>Accessories</b>	
0TB103.9	Connector 24 VDC - 3-pin, female - Screw clamp terminal block 3.31 mm <sup>2</sup>	
0TB103.91	Connector 24 VDC - 3-pin, female - Cage clamp terminal block 3.31 mm <sup>2</sup>	
	<b>Optional accessories</b>	
	<b>SDL3/SDL4/PoE cables</b>	
5CASD3.0010-00	SDL3/SDL4/FT50 cable - 1 m - FT50 including Power over Ethernet	
5CASD3.0030-00	SDL3/SDL4/FT50 cable - 3 m - FT50 including Power over Ethernet	
5CASD3.0050-00	SDL3/SDL4/FT50 cable - 5 m - FT50 including Power over Ethernet	
5CASD3.0070-00	SDL3/SDL4/FT50 cable - 7 m - FT50 including Power over Ethernet	
5CASD3.0100-00	SDL3/SDL4/FT50 cable - 10 m - FT50 including Power over Ethernet	
5CASD3.0150-00	SDL3/SDL4/FT50 cable - 15 m - FT50 including Power over Ethernet	
5CASD3.0200-00	SDL3/SDL4/FT50 cable - 20 m - FT50 including Power over Ethernet	
5CASD3.0300-00	SDL3/SDL4/FT50 cable - 30 m - FT50 including Power over Ethernet	
5CASD3.0500-00	SDL3/SDL4/FT50 cable - 50 m - FT50 including Power over Ethernet	
5CASD3.1000-00	SDL3/SDL4/FT50 cable - 100 m - FT50 including Power over Ethernet	

#### 4.2.2.2.3 Technical data

### Information:

The following specified characteristic data, features and limit values are only valid for these individual components and may differ from those of the complete system. The data specified for the complete system applies to the complete system in which this individual component is used, for example.

Order number	5DLSD3.1001-00
<b>General information</b>	
LEDs	Status, Link
B&R ID code	0xE3FC
<b>Certifications</b>	
CE	Yes
UKCA	Yes
UL	cULus E115267 Industrial control equipment
HazLoc	cULus HazLoc E180196 Industrial control equipment for hazardous locations Class I, Division 2, Groups ABCD, T4 <sup>1)</sup>
EAC	Product family certification
<b>Interfaces</b>	
<b>USB</b>	
Quantity	2
Type	USB 2.0
Variant	2x type A
Transfer rate	Low speed (1.5 Mbit/s), full speed (12 Mbit/s) to high speed (30 Mbit/s)
Current-carrying capacity	Total max. 1 A
<b>SDL3 In</b>	
Variant	RJ45, shielded
Type	SDL3

## Technical data

<b>Order number</b>	<b>5DLS3.1001-00</b>
<b>Electrical properties</b>	
Nominal voltage	24 VDC $\pm 25\%$ , SELV <sup>2)</sup>
Nominal current	Max. 3 A
Overvoltage category per EN 61131-2	II
Galvanic isolation	Yes
<b>Operating conditions</b>	
Pollution degree per EN 61131-2	Pollution degree 2
<b>Mechanical properties</b>	
Dimensions	
Width	190 mm
Height	110 mm
Depth	23.6 mm
Weight	527 g

- 1) Yes, but applies only if all components installed in the complete system have this certification and the complete system bears the corresponding mark.  
 2) IEC 61010-2-201 requirements must be observed.

### 4.2.2.3 5DLSD4.1001-00

#### 4.2.2.3.1 General information

- Link module for Automation Panel 9x3/1000/5000
- 1x SDL4 Panel In interface
- 2x USB 2.0 type A

#### 4.2.2.3.2 Order data

Order number	Short description	Figure
	<b>Link modules</b>	
5DLSD4.1001-00	Automation Panel link module - SDL4 receiver - For Automation Panel 923/933/1000 - For Automation Panel 5000	
	<b>Required accessories</b>	
	<b>Accessories</b>	
0TB103.9	Connector 24 VDC - 3-pin, female - Screw clamp terminal block 3.31 mm <sup>2</sup>	
0TB103.91	Connector 24 VDC - 3-pin, female - Cage clamp terminal block 3.31 mm <sup>2</sup>	
	<b>Optional accessories</b>	
	<b>SDL3/SDL4/PoE cables</b>	
5CASD3.0010-00	SDL3/SDL4/FT50 cable - 1 m - FT50 including Power over Ethernet	
5CASD3.0030-00	SDL3/SDL4/FT50 cable - 3 m - FT50 including Power over Ethernet	
5CASD3.0050-00	SDL3/SDL4/FT50 cable - 5 m - FT50 including Power over Ethernet	
5CASD3.0070-00	SDL3/SDL4/FT50 cable - 7 m - FT50 including Power over Ethernet	
5CASD3.0100-00	SDL3/SDL4/FT50 cable - 10 m - FT50 including Power over Ethernet	
5CASD3.0150-00	SDL3/SDL4/FT50 cable - 15 m - FT50 including Power over Ethernet	
5CASD3.0200-00	SDL3/SDL4/FT50 cable - 20 m - FT50 including Power over Ethernet	
5CASD3.0300-00	SDL3/SDL4/FT50 cable - 30 m - FT50 including Power over Ethernet	
5CASD3.0500-00	SDL3/SDL4/FT50 cable - 50 m - FT50 including Power over Ethernet	
5CASD3.1000-00	SDL3/SDL4/FT50 cable - 100 m - FT50 including Power over Ethernet	

#### 4.2.2.3.3 Technical data

### Information:

The following specified characteristic data, features and limit values are only valid for these individual components and may differ from those of the complete system. The data specified for the complete system applies to the complete system in which this individual component is used, for example.

Order number	5DLSD4.1001-00
<b>General information</b>	
LEDs	Status, Link
B&R ID code	0xECE3
Certifications	
CE	Yes
UKCA	Yes
UL	cULus E115267 Industrial control equipment
EAC	Product family certification
<b>Interfaces</b>	
USB	
Quantity	2
Type	USB 2.0
Variant	2x type A
Transfer rate	Low speed (1.5 Mbit/s), full speed (12 Mbit/s) to high speed (150 Mbit/s)
Current-carrying capacity	Total max. 1 A
SDL4 In	
Variant	RJ45, shielded
Type	SDL4
<b>Electrical properties</b>	
Nominal voltage	24 VDC ±25%, SELV <sup>1)</sup>
Nominal current	Max. 3 A
Overvoltage category per EN 61131-2	II

## Technical data

<b>Order number</b>	<b>5DLSD4.1001-00</b>
Galvanic isolation	Yes
<b>Operating conditions</b>	
Pollution degree per EN 61131-2	Pollution degree 2
<b>Mechanical properties</b>	
Dimensions	
Width	190 mm
Height	110 mm
Depth	23.6 mm
Weight	525 g

1) IEC 61010-2-201 requirements must be observed.

## 4.2.3 System units

### 4.2.3.1 5PPC2100.BYxx-000

#### 4.2.3.1.1 General information

PPC2100 system units consist of a CPU board, main memory and housing. It includes all interfaces; in addition, an interface option can be installed. The main memory is permanently soldered to the CPU board and cannot be replaced or upgraded.

- Intel Atom processors
- Intel Bay Trail platform
- DDR3 memory
- Intel HD Graphics
- 1x CFAST slot
- Slot for 1 interface option

#### 4.2.3.1.2 Order data

Order number	Short description	Figure
	<b>System units</b>	
5PPC2100.BY01-000	PPC2100 system unit - Intel Atom E3815 1.46 GHz - Single core - 1 GB SDRAM - For Automation Panel 923/933/1000	
5PPC2100.BY11-000	PPC2100 system unit - Intel Atom E3825 1.33 GHz - Dual core - 1 GB SDRAM - For Automation Panel 923/933/1000	
5PPC2100.BY22-000	PPC2100 system unit - Intel Atom E3826 1.46 GHz - Dual core - 2 GB SDRAM - For Automation Panel 923/933/1000	
5PPC2100.BY34-000	PPC2100 system unit - Intel Atom E3827 1.75 GHz - Dual core - 4 GB SDRAM - For Automation Panel 923/933/1000	
5PPC2100.BY44-000	PPC2100 system unit - Intel Atom E3845 1.91 GHz - Quad core - 4 GB SDRAM - For Automation Panel 923/933/1000	
5PPC2100.BY48-000	PPC2100 system unit - Intel Atom E3845 1.91 GHz - Quad core - 8 GB SDRAM - For Automation Panel 923/933/1000	
	<b>Required accessories</b>	
	<b>CFAST cards</b>	
5CFAST.016G-00	CFAST 16 GB SLC	
5CFAST.032G-00	CFAST 32 GB SLC	
5CFAST.032G-10	CFAST 32 GB MLC	
5CFAST.064G-10	CFAST 64 GB MLC	
5CFAST.128G-10	CFAST 128 GB MLC	
5CFAST.256G-10	CFAST 256 GB MLC	
	<b>Optional accessories</b>	
	<b>Interface options</b>	
5ACCIF01.FPCC-000	Interface card - 2x CAN interfaces - 1x X2X Link interface - 1x POWERLINK interface - 512 kB nvSRAM - For APC2100/PPC2100/APC2200/PPC2200 - Only available with a new device	
5ACCIF01.FPCS-000	Interface card - 1x RS485 interface - 1x CAN interface - 1x POWERLINK interface - 32 kB FRAM - For APC2100/PPC2100/APC2200/PPC2200 - Only available with a new device	
5ACCIF01.FPLK-000	Interface card - 1x POWERLINK interface - Integrated 2-port hub - 512 kB nvSRAM - For APC2100/PPC2100/APC2200/PPC2200 - Only available with a new device	
5ACCIF01.FPLS-000	Interface card - 1x RS232 interface - 1x POWERLINK interface - 32 kB FRAM - For APC2100/PPC2100/APC2200/PPC2200 - Only available with a new device	
5ACCIF01.FPLS-001	Interface card - 1x RS232 interface - 1x POWERLINK interface - 512 kB nvSRAM - For APC2100/PPC2100/APC2200/PPC2200 - Only available with a new device	
5ACCIF01.FPSC-000	Interface card - 1x RS232 interface - 1x CAN interface - 1x POWERLINK interface - 32 kB FRAM - For APC2100/PPC2100/APC2200/PPC2200 - Only available with a new device	
5ACCIF01.FPSC-001	Interface card - 1x RS232 interface - 1x CAN interface - 1x X2X Link Interface - 1x POWERLINK interface - 512 kB nvSRAM - For APC2100/PPC2100/APC2200/PPC2200 - Only available with a new device	
5ACCIF01.FSS0-000	Interface card - 2x RS422/RS485 interface - For APC2100/PPC2100/APC2200/PPC2200 - Only available with a new device	
5ACCIF01.ICAN-000	Interface card - 1x CAN interface - For APC2100/PPC2100/APC2200/PPC2200 - Only available with a new device	
5ACCIF01.IS00-000	Interface card - 1x RS232 interface - For APC2100/PPC2100/APC2200/PPC2200 - Only available with a new device	

### 4.2.3.1.3 Technical data

Order number	5PPC2100. BY01-000	5PPC2100. BY11-000	5PPC2100. BY22-000	5PPC2100. BY34-000	5PPC2100. BY44-000	5PPC2100. BY48-000
<b>General information</b>						
LEDs	Power, CFast, Link, Run					
B&R ID code	0xE522	0xE524	0xE545	0xE547	0xE54B	0xED0B
Cooling	Passive via housing					
Power button	Yes					
Reset button	Yes					
Buzzer	No					
Certifications						
CE	Yes					
UKCA	Yes					
UL	cULus E115267 Industrial control equipment					
HazLoc	cULus HazLoc E180196 Industrial control equipment for hazardous locations Class I, Division 2, Groups ABCD, T4 <sup>1)</sup>					
DNV	-				Temperature: <b>B</b> (0 - 55°C) Humidity: <b>B</b> (up to 100%) Vibration: <b>A</b> (0.7 g) EMC: <b>B</b> (bridge and open deck) <sup>2)</sup>	
LR	-				ENV3	
KR	-				Yes	
ABS	-				Yes	
BV	-				<b>EC31B</b> Temperature: 5 - 55°C Vibration: 0.7 g EMC: Bridge and open deck	
EAC	Product family certification					
<b>Controller</b>						
Bootloader	UEFI BIOS					
Processor						
Type	Intel Atom E3815	Intel Atom E3825	Intel Atom E3826	Intel Atom E3827	Intel Atom E3845	
Clock frequency	1460 MHz	1330 MHz	1460 MHz	1750 MHz	1910 MHz	
Number of cores	1	2			4	
Architecture	22 nm					
Thermal design power (TDP)	5 W	6 W	7 W	8 W	10 W	
L2 cache	512 kB	1 MB			2 MB	
Intel 64 architecture	Yes					
Intel Hyper-Threading Technology	No					
Intel vPro Technology	No					
Intel Virtualization Technology (VT-x)	Yes					
Intel Virtualization Technology for Directed I/O (VT-d)	No					
Enhanced Intel SpeedStep Technology	Yes					
Chipset	Intel Bay Trail					
Real-time clock						
Accuracy	At 25°C: Typ. 12 ppm (1 second) per day <sup>3)</sup>					
Self-discharge time <sup>4)</sup>	Typ. approx. 400 h Min. approx. 200 h					
Battery-backed	No					
Power failure logic						
Controller	MTCX <sup>5)</sup>					
Buffer time	10 ms					
Memory						
Type	DDR3 SDRAM					
Memory size	1 GB		2 GB		4 GB	
Velocity	DDR3L-1067			DDR3L-1333		
Memory interface width	Single channel					Dual channel
Removable	No					
Graphics						
Controller	Intel HD Graphics					
Max. dynamic graphics frequency	400 MHz	533 MHz	667 MHz	792 MHz		
Color depth	Max. 32-bit					
DirectX support	11					
OpenGL support	4.0					
Power management	ACPI 4.0					
<b>Interfaces</b>						
CFast slot						
Quantity	1					
Type	SATA II (SATA 3.0 Gbit/s)					

Order number	5PPC2100. BY01-000	5PPC2100. BY11-000	5PPC2100. BY22-000	5PPC2100. BY34-000	5PPC2100. BY44-000	5PPC2100. BY48-000
<b>USB</b>						
Quantity	2					
Type	1x USB 3.0 1x USB 2.0					
Variant	Type A					
Transfer rate	Low speed (1.5 Mbit/s), full speed (12 Mbit/s), high speed (480 Mbit/s) to SuperSpeed (5 Gbit/s) <sup>6)</sup>					
Current-carrying capacity	Max. 1 A per connection					
<b>Ethernet</b>						
Quantity	2					
Variant	RJ45, shielded					
Transfer rate	10/100/1000 Mbit/s					
Max. baud rate	1 Gbit/s					
<b>Slots</b>						
Interface option <sup>7)</sup>	1					
<b>Electrical properties</b>						
Nominal voltage	24 VDC ±25% <sup>8)</sup>					
Nominal current	3.5 A					
Inrush current	Typ. 6 A, max. 10 A for < 300 µs					
Overvoltage category per EN 61131-2	II					
Galvanic isolation	Yes					
<b>Operating conditions</b>						
Pollution degree per EN 61131-2	Pollution degree 2					
Degree of protection per EN 60529	Back: IP20 (front: depends on the panel used) <sup>9)</sup>					
<b>Ambient conditions</b>						
Elevation						
Operation	Max. 3000 m (component-dependent) <sup>10)</sup>					
<b>Mechanical properties</b>						
<b>Dimensions</b>						
Width	190 mm					
Height	115 mm					
Depth	29.7 mm					
Weight	577 g					

- 1) Yes, but applies only if all components installed in the complete system have this certification and the complete system bears the corresponding mark.
- 2) Yes, but applies only if all components installed in the complete system have this certification and are listed on the associated DNV certificate for the product family.
- 3) At max. specified ambient temperature: Typ. 58 ppm (5 seconds) - worst case 220 ppm (19 seconds).
- 4) To achieve the specified values for the self-discharge time, the product must be supplied with power for min. 8 hours.
- 5) Maintenance Controller Extended
- 6) The SuperSpeed transfer rate (5 Gbit/s) is only possible with USB 3.0.
- 7) The interface option cannot be replaced.
- 8) IEC 61010-2-201 requirements must be observed.
- 9) Only if all interface covers are installed.
- 10) The maximum ambient temperature is typically derated 1°C per 1000 meters starting at 500 m above sea level.

### 4.2.3.2 5PPC2200.ALxx-000

#### 4.2.3.2.1 General information

PPC2200 system units consist of a CPU board, housing and mounting plate. It includes all interfaces; in addition, an interface option can be installed. The main memory is permanently soldered to the CPU board and cannot be replaced or upgraded.

- Intel Atom X processor series
- Intel Apollo Lake
- LPDDR4 memory
- Intel HD Graphics
- 1x CFAST slot
- Slot for 1 interface option

#### 4.2.3.2.2 Order data

Order number	Short description	Figure
	<b>System units</b>	
5PPC2200.AL02-000	PPC2200 system unit - Intel Atom E3930 1.30 GHz - Dual core - 2 GB SDRAM	
5PPC2200.AL04-000	PPC2200 system unit - Intel Atom E3930 1.30 GHz - Dual core - 4 GB SDRAM	
5PPC2200.AL14-000	PPC2200 system unit - Intel Atom E3940 1.60 GHz - Quad core - 4 GB SDRAM	
5PPC2200.AL18-000	PPC2200 system unit - Intel Atom E3940 1.60 GHz - Quad core - 8 GB SDRAM	
	<b>Required accessories</b>	
	<b>CFAST cards</b>	
5CFAST.016G-00	CFAST 16 GB SLC	
5CFAST.032G-00	CFAST 32 GB SLC	
5CFAST.032G-10	CFAST 32 GB MLC	
5CFAST.064G-10	CFAST 64 GB MLC	
5CFAST.128G-10	CFAST 128 GB MLC	
5CFAST.2048-00	CFAST 2 GB SLC	
5CFAST.256G-10	CFAST 256 GB MLC	
5CFAST.4096-00	CFAST 4 GB SLC	
5CFAST.8192-00	CFAST 8 GB SLC	
	<b>Optional accessories</b>	
	<b>Interface options</b>	
5ACCIF01.FPCC-000	Interface card - 2x CAN interfaces - 1x X2X Link interface - 1x POWERLINK interface - 512 kB nvSRAM - For APC2100/PPC2100/APC2200/PPC2200 - Only available with a new device	
5ACCIF01.FPCS-000	Interface card - 1x RS485 interface - 1x CAN interface - 1x POWERLINK interface - 32 kB FRAM - For APC2100/PPC2100/APC2200/PPC2200 - Only available with a new device	
5ACCIF01.FPLK-000	Interface card - 1x POWERLINK interface - Integrated 2-port hub - 512 kB nvSRAM - For APC2100/PPC2100/APC2200/PPC2200 - Only available with a new device	
5ACCIF01.FPLS-000	Interface card - 1x RS232 interface - 1x POWERLINK interface - 32 kB FRAM - For APC2100/PPC2100/APC2200/PPC2200 - Only available with a new device	
5ACCIF01.FPLS-001	Interface card - 1x RS232 interface - 1x POWERLINK interface - 512 kB nvSRAM - For APC2100/PPC2100/APC2200/PPC2200 - Only available with a new device	
5ACCIF01.FPSC-000	Interface card - 1x RS232 interface - 1x CAN interface - 1x POWERLINK interface - 32 kB FRAM - For APC2100/PPC2100/APC2200/PPC2200 - Only available with a new device	
5ACCIF01.FPSC-001	Interface card - 1x RS232 interface - 1x CAN interface - 1x X2X Link Interface - 1x POWERLINK interface - 512 kB nvSRAM - For APC2100/PPC2100/APC2200/PPC2200 - Only available with a new device	
5ACCIF01.FSS0-000	Interface card - 2x RS422/RS485 interface - For APC2100/PPC2100/APC2200/PPC2200 - Only available with a new device	
5ACCIF01.ICAN-000	Interface card - 1x CAN interface - For APC2100/PPC2100/APC2200/PPC2200 - Only available with a new device	
5ACCIF01.IS00-000	Interface card - 1x RS232 interface - For APC2100/PPC2100/APC2200/PPC2200 - Only available with a new device	
5ACCIF03.CETH-000	Interface card - 2x ETH 10/100/1000 interface - For APC2200/PPC2200 - Only available with a new device	



## 4.2.3.2.3 Technical data

**Information:**

The following specified characteristic data, features and limit values are only valid for these individual components and may differ from those of the complete system. The data specified for the complete system applies to the complete system in which this individual component is used, for example.

Order number	5PPC2200.AL02-000	5PPC2200.AL04-000	5PPC2200.AL14-000	5PPC2200.AL18-000
<b>General information</b>				
LEDs	Power, Disk, Link, Run			
B&R ID code	0xF0C6	0xF0C7	0xF0C8	0xF0C9
Cooling	Passive via housing			
Power button	Yes			
Reset button	Yes			
Buzzer	No			
Certifications				
CE	Yes			
UL	cULus E115267 Industrial control equipment			
DNV	-			Temperature: <b>B</b> (0 - 55°C) Humidity: <b>B</b> (up to 100%) Vibration: <b>A</b> (0.7 g) EMC: <b>B</b> (bridge and open deck) <sup>1)</sup>
LR	-			ENV3
ABS	-			Yes
BV	-			<b>EC31B</b> Temperature: 5 - 55°C Vibration: 0.7 g EMC: Bridge and open deck
<b>Controller</b>				
Bootloader	UEFI BIOS			
<b>Processor</b>				
Type	Intel Atom x5-E3930		Intel Atom x5-E3940	
Clock frequency	1300 MHz		1600 MHz	
Number of cores	2		4	
Architecture	14 nm			
Thermal design power (TDP)	6.5 W		9.5 W	
L2 cache	2 MB			
Intel 64 architecture	Yes			
Intel Hyper-Threading Technology	No			
Intel vPro Technology	No			
Intel Virtualization Technology (VT-x)	Yes			
Intel Virtualization Technology for Directed I/O (VT-d)	Yes			
Enhanced Intel SpeedStep Technology	Yes			
Chipset	Intel Apollo Lake			
Trusted Platform Module	TPM 2.0			
<b>Real-time clock</b>				
Accuracy	At 25°C: Typ. 12 ppm (1 second) per day <sup>2)</sup>			
Battery-backed	Yes			
<b>Power failure logic</b>				
Controller	MTCX <sup>3)</sup>			
Buffer time	10 ms			
<b>Memory</b>				
Type	LPDDR4 SDRAM			
Memory size	2 GB	4 GB	8 GB	
Velocity	DDR4L-2133			
Memory interface width	Single channel		Dual channel	
Removable	No			
<b>Graphics</b>				
Controller	Intel HD Graphics			
Max. dynamic graphics frequency	550 MHz		600 MHz	
Color depth	Max. 32-bit			
DirectX support	12			
OpenGL support	4.3			
Power management	ACPI 5.0			
<b>Interfaces</b>				
CFast slot				
Quantity	1			
Type	SATA III (SATA 6.0 Gbit/s)			

## Technical data

Order number	5PPC2200.AL02-000	5PPC2200.AL04-000	5PPC2200.AL14-000	5PPC2200.AL18-000
<b>USB</b>				
Quantity	2			
Type	USB 3.0			
Variant	Type A			
Transfer rate	Low speed (1.5 Mbit/s), full speed (12 Mbit/s), high speed (480 Mbit/s) to SuperSpeed (5 Gbit/s) <sup>4)</sup>			
Current-carrying capacity	Max. 1 A per connection			
<b>Ethernet</b>				
Quantity	2			
Variant	RJ45, shielded			
Transfer rate	10/100/1000 Mbit/s			
Max. baud rate	1 Gbit/s			
<b>Slots</b>				
Interface option <sup>5)</sup>	1			
<b>Electrical properties</b>				
Nominal voltage	24 VDC ±25%, SELV <sup>6)</sup>			
Nominal current	Max. 4 A			
Inrush current	Typ. 5 A, max. 50 A for < 500 µs			
Oversvoltage category per EN 61131-2	II			
Galvanic isolation	Yes			
<b>Operating conditions</b>				
Pollution degree per EN 61131-2	Pollution degree 2			
Degree of protection per EN 60529	Back: IP20 (front: depends on the panel used) <sup>7)</sup>			
<b>Ambient conditions</b>				
Elevation				
Operation	Max. 3000 m (component-dependent) <sup>8)</sup>			
<b>Mechanical properties</b>				
Dimensions				
Width	190 mm			
Height	115 mm			
Depth	29.7 mm			
Weight	577 g			

- 1) Yes, but applies only if all components installed in the complete system have this certification and are listed on the associated DNV certificate for the product family.
- 2) At max. specified ambient temperature: Typ. 58 ppm (5 seconds) - worst case 220 ppm (19 seconds).
- 3) Maintenance Controller Extended
- 4) The SuperSpeed transfer rate (5 Gbit/s) is only possible with USB 3.0.
- 5) The interface option cannot be replaced.
- 6) IEC 61010-2-201 requirements must be observed.
- 7) Only if all interface covers are installed.  
The degree of protection of the complete system depends on the mounting unit used as well as the panel.
- 8) The maximum ambient temperature is typically derated 1°C per 1000 meters starting at 500 m above sea level.

## 4.2.4 Interface options

For information about the interface options available for PPC2x00 system units, see the respective system manual. These are available for download on the B&R website.

- [User's manual PPC2100SW1](#)
- [User's manual PPC2200SW](#)

## 4.2.5 Battery compartment

### 4.2.5.1 5ACCBT01.0000-001

#### 4.2.5.1.1 General information

The lithium battery is needed to retain BIOS CMOS data and to back up the real-time clock (RTC).  
The battery is subject to wear and must be replaced if the battery capacity is insufficient (state "Bad").

#### 4.2.5.1.2 Order data

Order number	Short description	Figure
	<b>Accessories</b>	
5ACCBT01.0000-001	Battery compartment - Dark gray - Includes battery - For APC2200/PPC2200	

For the battery compartment replacement part, see "5ACCRPC2.0003-000" on page 144 in section "Replacement parts".

#### 4.2.5.1.3 Technical data

### Information:

The following specified characteristic data, features and limit values are only valid for this accessory and may differ from those of the complete system. The data specified for the complete system applies to the complete system in which this accessory is installed, for example.

Order number	5ACCBT01.0000-001
<b>General information</b>	
Battery	
Type	Panasonic 1000 mAh
Nominal voltage	3 V
Service life	8 years <sup>1)</sup>
Removable	No <sup>2)</sup>
Variant	Lithium
Certifications	
CE	Yes
UKCA	Yes
UL	cULus E115267 Industrial control equipment
DNV	Temperature: <b>B</b> (0 - 55°C) Humidity: <b>B</b> (up to 100%) Vibration: <b>A</b> (0.7 g) EMC: <b>B</b> (bridge and open deck) <sup>3)</sup>
LR	ENV3
ABS	Yes
BV	<b>EC31B</b> Temperature: 5 - 55°C Vibration: 0.7 g EMC: Bridge and open deck
<b>Operating conditions</b>	
Pollution degree per EN 61131-2	Pollution degree 2
<b>Ambient conditions</b>	
Temperature	
Operation	-25 to 60°C
Storage	-25 to 60°C
Transport	-25 to 60°C
Relative humidity	
Operation	5 to 90%
Storage	5 to 95%
Transport	5 to 95%

<b>Order number</b>	<b>5ACCBT01.0000-001</b>
<b>Mechanical properties</b>	
Housing	
Material	Dyed gray (similar to Pantone 432C) plastic
Weight	Approx. 13 g

- 1) At 50°C, 6 µA for the components being supplied.
- 2) The battery is permanently installed in the battery compartment and cannot be replaced. The entire battery compartment must always be replaced, see section "Accessories".
- 3) Yes, but applies only if all components installed in the complete system have this certification and are listed on the associated DNV certificate for the product family.

#### 4.2.6 CFast cards

Additional information about compatible CFast cards is available in [aggregate data sheet for CFast cards](#) on the B&R website.

## 5 Installation and wiring

---

### 5.1 Important information for installation/commissioning

The following must be taken into account when using a Rittal CP-S stainless steel flange (CP6664.500 or CP6664.000):

#### Information:

**Before installing the Automation Panel 9xD on a swing arm system, it must be checked whether the sealing ring is installed on the flange of the AP9xD.**

**The swing arm shaft must have an outer diameter of 48 mm. The end of the swing arm shaft installed on the flange must be chamfered at a 45° angle and deburred.**

#### Installation notes

- Ambient conditions must be taken into account.
- The device is only permitted to be operated in closed rooms.
- The device is not permitted to be exposed to direct sunlight.
- When installing the device, the permissible mounting orientations must be observed.
- The swing arm system must be able to hold four times the total weight of the device.
- When connecting cables (DVI, SDL, USB, etc.), the bend radius must be observed.
- The device must be installed in such a way that reflections on the screen are avoided as far as possible.
- The device must be installed in such a way that it can be optimally viewed by the user.
- To ensure leak tightness, new [Replacement screws](#) must be used after the hygienic panels have been removed again.
- If necessary, individual [Replacement gaskets](#) are also available.

### 5.2 Alignment of the swing arm connection for AP93D and AP99D

The holding hooks and grips are already attached to the housing cover, which is installed on the panel using 4 screws and delivered with the flange connection underneath.

#### Proceed as follows if the swing arm connection should be aligned on the bottom:

1. Loosen the four screws on the housing cover, open it and remove the retaining straps. The housing cover can now be removed and installed on the swing arm.
2. The retaining straps are attached in the next step (the long retaining straps are always installed on the top; the short retaining straps are always installed on the bottom).
3. Wiring can now take place. The panel is then installed on the holding hooks of the housing cover. Make sure the retaining straps are not pinched.
4. Before screwing down the housing cover, make sure that the gasket is lined up with the knobs in the opening of the panel. The gasket must be flush at the 4 corners and along the respective edges.
5. The housing cover is centered on the panel with 4 screws (2 turns each). Check once more that the gasket is not pinched.
6. Then lightly tighten the remaining Torx M4x12 mm screws. If the housing cover is centered correctly and the gasket is flush, then all screws can be secured (max. torque: 1 Nm).

#### Proceed as follows if the swing arm connection should be aligned on the top:

1. Loosen the four screws on the housing cover and open it.

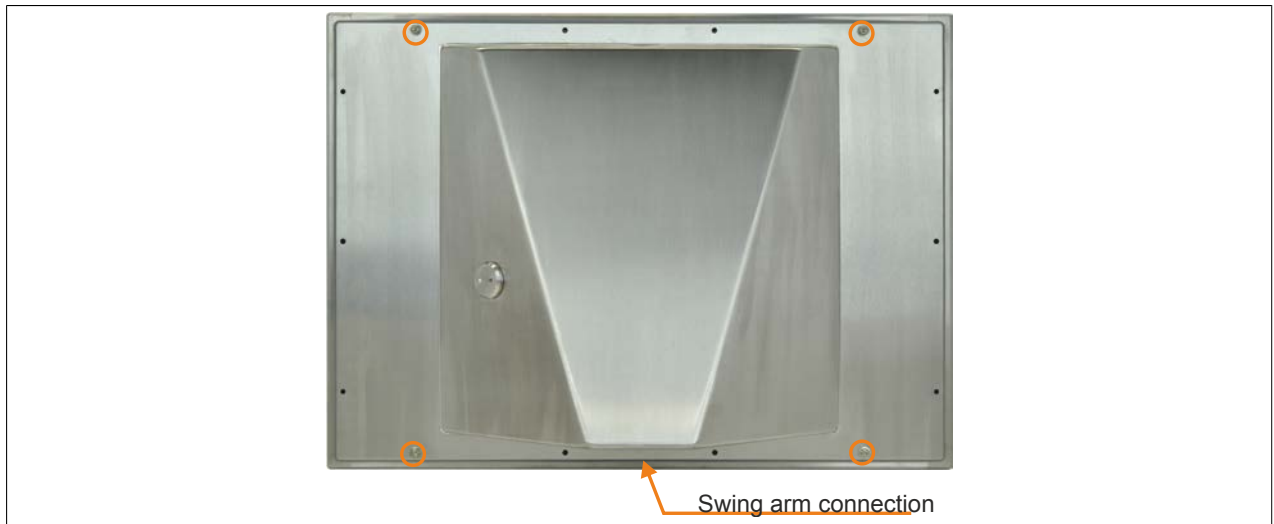

2. Remove the holding hooks and retaining straps and rotate the housing cover 180°.
3. After rotating that housing cover, attach it to the swing arm.
4. Install the retaining straps and holding books back on the housing cover (the holding hooks can also be installed before installation on the swing arm). The holding hooks must be installed with the tab outward and on the same side to which the long retaining straps are attached.
5. The holding hooks are attached with two M3 self-locking nuts (max. torque: 0.55 Nm).



6. The long retaining straps are always installed on the top; the short retaining straps are always installed on the bottom. It is important to ensure that the retaining straps protrude inwards (into the depression of the housing) in order not to be pinched.

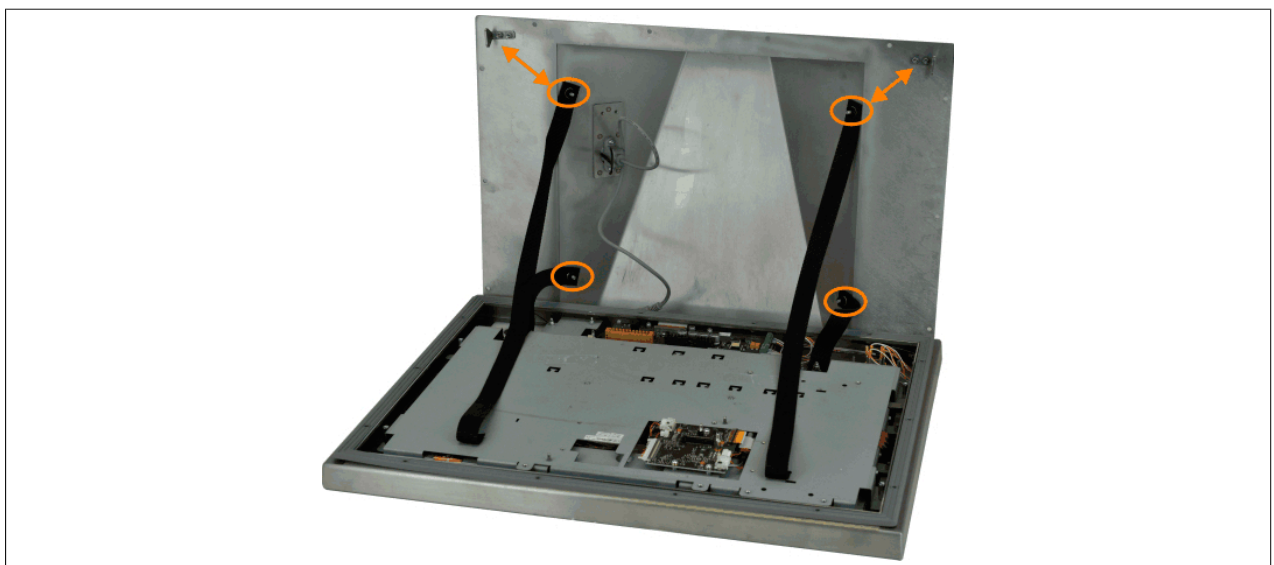

7. Wiring can now take place. The panel is then installed on the holding hooks of the housing cover. Make sure the retaining straps are not pinched.
8. Before screwing down the housing cover, make sure that the gasket is lined up with the knobs in the opening of the panel. The gasket must be flush at the 4 corners and along the respective edges.

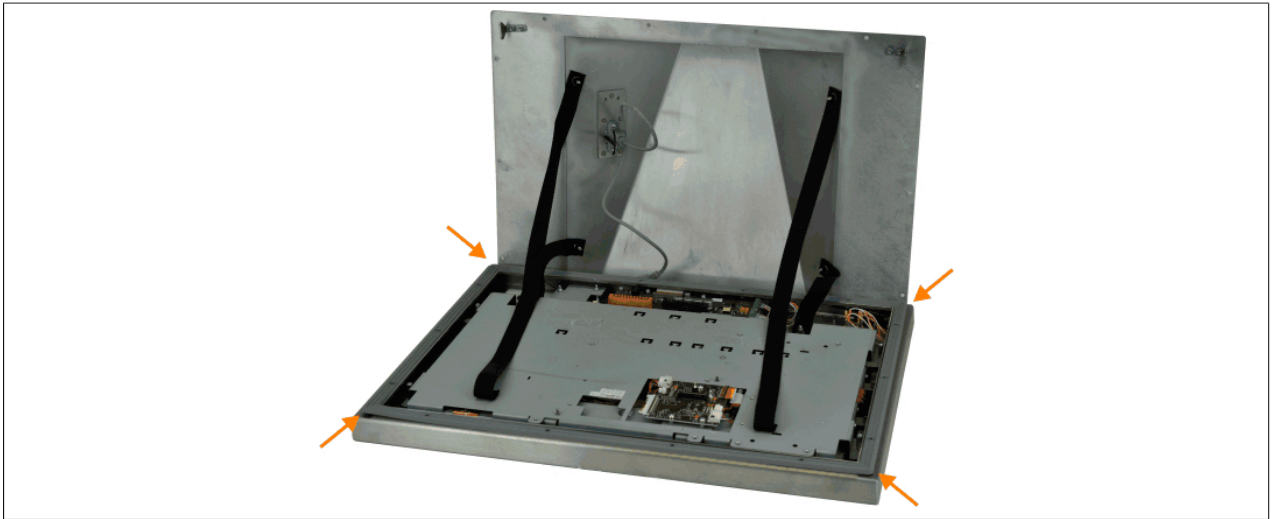

9. The housing cover is centered on the panel with 4 screws (2 turns each). Check once more that the gasket is not pinched.

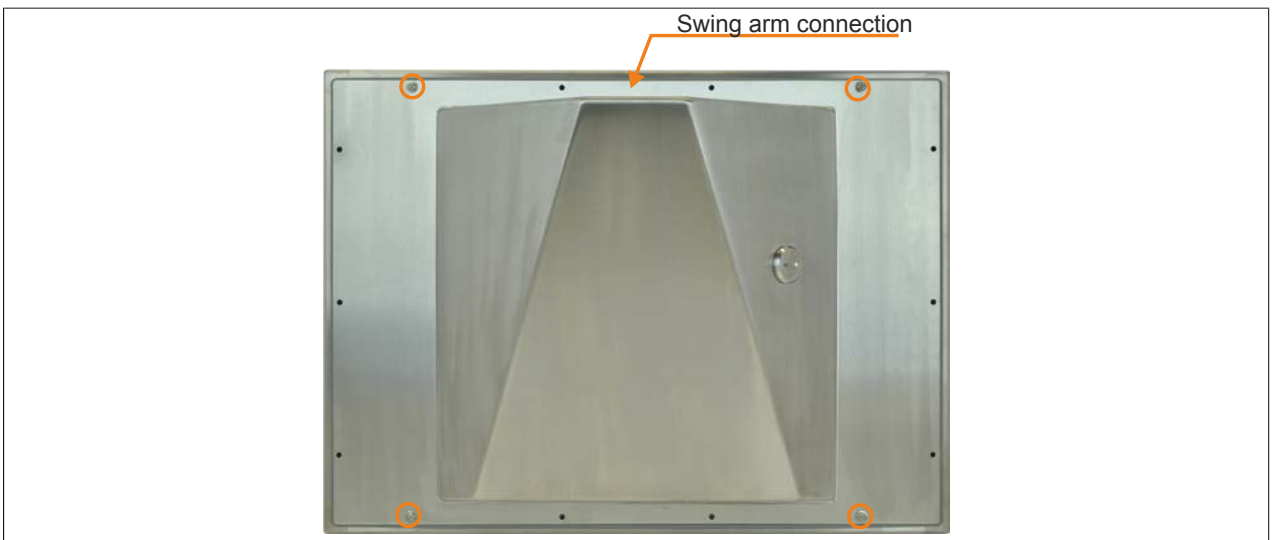

10. Then lightly tighten the remaining Torx M4x12 mm screws. If the housing cover is centered correctly and the gasket is flush, then all screws can be tightened down (max. torque: 1 Nm).

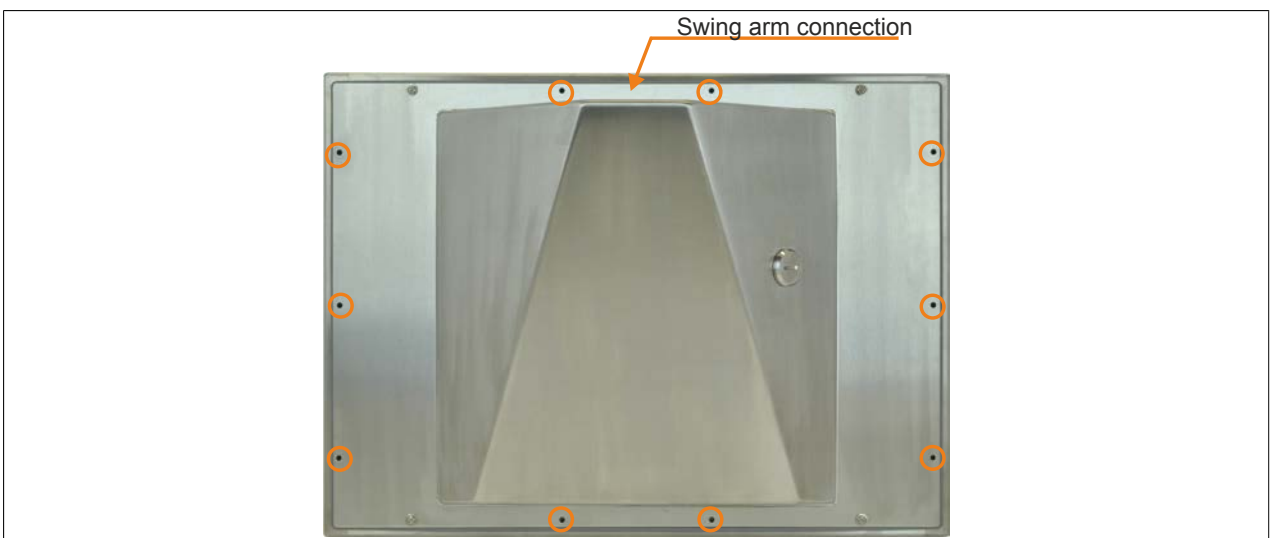



### 5.3 Installing optional control elements

Depending on the variant of the AP93D and AP99D panels with hygienic design, 1 to 2 prepared cutouts are available to be equipped with optional operating elements.

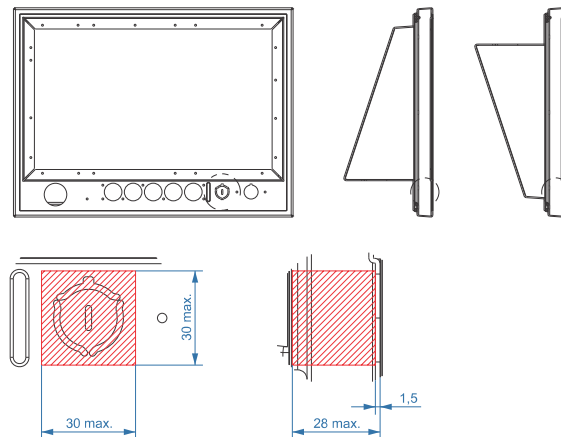

1. Disconnect the power supply cable to the device (disconnect the power cable!). Disconnect from all sources and poles!
2. Carry out electrostatic discharge at the ground connection.
3. Place the on a clean, flat surface.
4. Cut through the panel overlay from the inside with a sharp object (e.g. scalpel) along the outer edges of the 3 curved cutout areas.

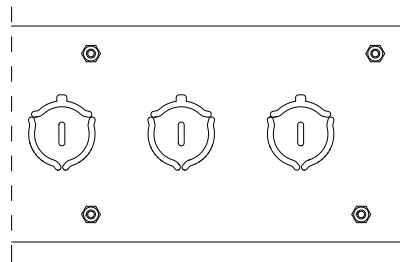

5. Carefully cut the panel overlay at the notch for the anti-twist lock.
6. Cut through the panel overlay along the outer edges of the middle cutout with a scalpel.
7. Push though the cutout for the operating element with a flat-blade screwdriver.

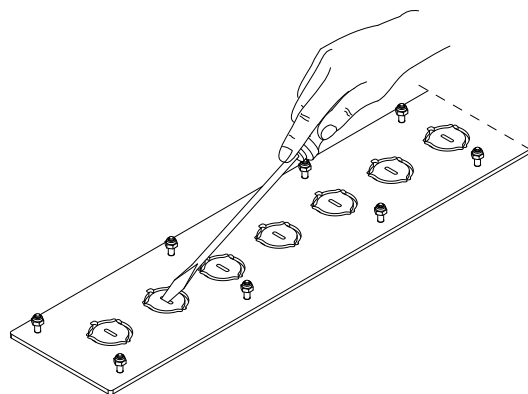

8. Cut the panel overlay so that it is flush with the edge of the steel plate.
9. Operating elements can now be installed on the expansion cover.

## 5.4 Device labeling with slide-in labels

The housing cover must be opened to insert the slide-in label. The prepared slide-in labels must be inserted into the device as shown below.

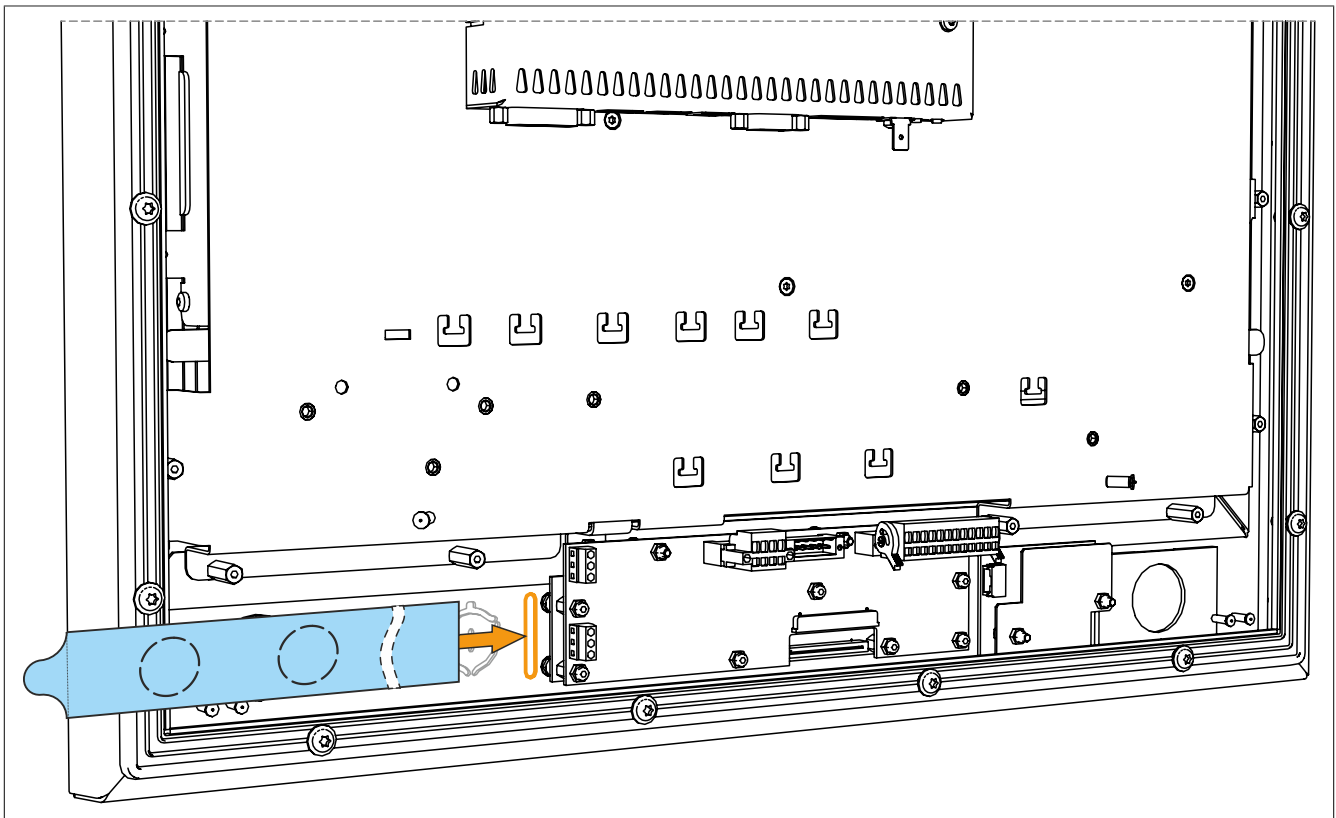

## 5.5 Connecting to the power grid

### Danger!

- The entire power supply must be disconnected and electrostatic discharge must take place on the housing or ground connection before removing any covers or components from the device and installing or removing any accessories, hardware or cables.
- Remove the power cable from the device and from the power supply.
- All covers and components, accessories, hardware and cables must be installed or secured before the device is connected to the power supply and switched on.

### 5.5.1 Installing the DC power cable

### Danger!

The entire power supply to the B&R industrial PC or B&R Automation Panel must be interrupted. Before connecting the DC power cable, it must be checked whether it has been disconnected from the voltage source (e.g. power supply unit).

#### 5.5.1.1 Wiring

### Caution!

The pinout of the power supply interface must be observed!

The DC power cable must be implemented with a wire cross section of 0.75 mm<sup>2</sup> to 1.5 mm<sup>2</sup> and wire end sleeves.

Conductors of the power cable	Terminal connection symbol
+24 VDC	+
GND	
0 VDC	-

### Installing screw clamp terminal block 0TB103.9

Secure the conductors with wire end sleeves ① in the terminal contacts ③ as shown in the figure below and tighten the screw clamp terminals ④ with a screwdriver (max. tightening torque 0.4 Nm). It is important to pay attention to the label on the spring clamp terminal ②.

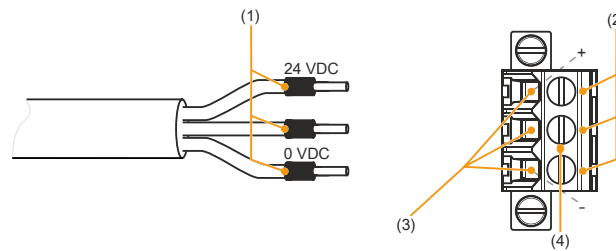

### Installing cage clamp terminal block 0TB103.91

Insert a screwdriver into the cage clamp terminals ③ and secure the conductors with wire end sleeves ① in the terminal contacts ② as shown in the figure below. Close the terminal contact by removing the screwdriver. It is important to pay attention to the label on the spring clamp terminal ④.

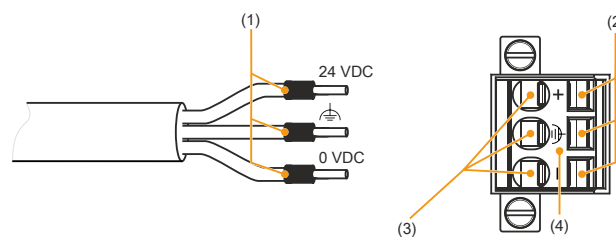

## 5.5.2 Connecting the power supply to a B&R device

### Danger!

The entire power supply to the B&R device must be interrupted. Before connecting the power cable, it must be checked whether it has been disconnected from the voltage source (e.g. power supply unit).

1. Carry out electrostatic discharge on the housing or at the ground connection.
2. Connect the power supply connector to the B&R device and tighten the mounting screws (max. tightening torque 0.5 Nm).

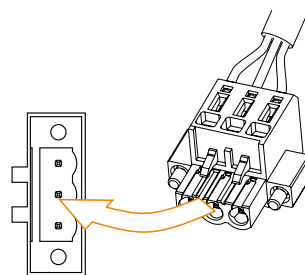

### 5.5.3 Grounding concept - Functional ground

Functional ground is a low impedance current path between circuits and ground. It is used for equipotential bonding and thus for improving immunity to interference.

#### Notice!

**Functional grounding does not meet the requirements of protective ground!  
Suitable measures for electrical safety in the event of operation and faults must be provided separately.**

The device is equipped with the following functional ground connections:

- Functional ground connection of the power supply
- Ground connection

The functional ground on the B&R device is marked with the following symbol:



The following points must be observed to ensure that electrical interference is safely diverted:

- Connect the device to the central grounding point (e.g. the control cabinet or the system) using the shortest possible low-resistance path.
- Cable design with at least 2.5 mm<sup>2</sup> per connection. If a cable with wire end sleeve is used at terminal block 0TB103.9 or 0TB103.91, a cable with a maximum of 1.5 mm<sup>2</sup> per connection is possible.
- Observe the shielding concept of the conductors. All data cables connected to the device must be shielded.

The functional ground is connected via the interfaces on the link module or Panel PC being used. The following figure shows the connection diagram of a PPC2200 system unit.

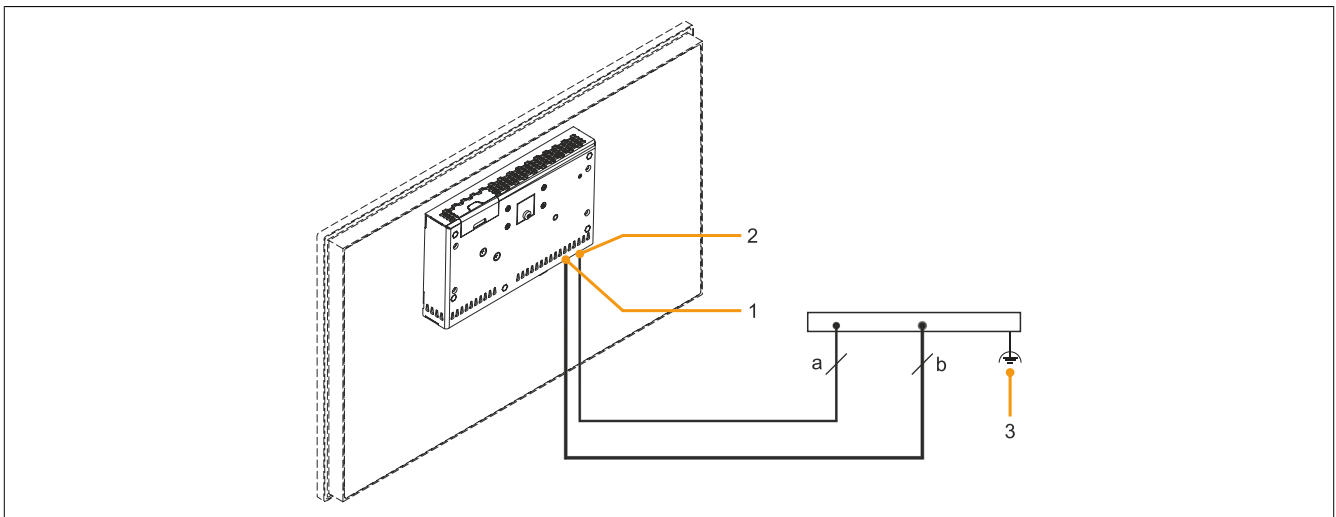

#### Legend

1	Ground connection	2	Power supply connection +24 VDC pin 2	3	Central grounding point
a	At least 1.5 mm <sup>2</sup>	b	At least 2.5 mm <sup>2</sup>		-

## 5.6 Connecting cables

When connecting or installing cables, the bend radius specification must be observed. For this specification, see the technical data of the respective cable.

The maximum tightening torque of the locating screws is 0.5 Nm.

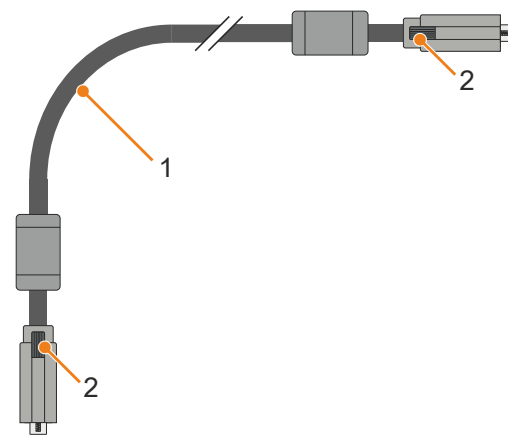

- 1) Bend radius
- 2) Locating screws

## 6 Commissioning

---

### 6.1 Basic information

Condensation may form under certain environmental conditions or rapid climatic changes. For improved acclimatization and to avoid damage, the device must be slowly adapted to the room temperature.

### 6.2 Switching on the device for the first time

#### 6.2.1 General information before switching on the device

##### Checklist

Before the device is started up for the first time, the following points must be checked:

- Have the installation instructions been observed as described in "[Installation and wiring](#)" on page 102?
- Have the permissible ambient conditions and environmental conditions for the device been taken into account?
- Is the power supply connected correctly and have the values been checked?
- Is the ground cable correctly connected to the ground connection?
- Before installing additional hardware, the device must have been started up.

##### Caution!

**Before the device is started up, it must be gradually adapted to room temperature! Exposure to direct heat radiation is not permitted.**

**When transporting at low temperatures or in the event of large temperature fluctuations, the collection of moisture in or on the device is not permitted.**

**Moisture can cause short circuits in electrical circuits and damage the device.**

##### Requirements

The following criteria must be met before switching on the device for the first time:

- The protective film has been removed from the panel.
- The functional ground connections are as short as possible and connected to the central grounding point using the largest possible wire cross section.
- All connection cables are connected correctly.
- A USB keyboard and USB mouse are connected (optional).
- An Automation PC or Panel PC is connected (via DVI, SDL, SDL3 or SDL4).

#### 6.2.2 Switching on the Automation Panel

##### Procedure

1. Connect the power supply and switch it on.
2. The device is operating.

## 6.3 Touch screen calibration

B&R touch screen devices are equipped with a B&R touch controller that supports hardware calibration. These devices come already pre-calibrated from the factory. This feature offers great advantages especially for replacement parts since recalibration is usually no longer required when replacing a device (identical model/type). B&R still recommends recalibration for best results and to optimally adapt the touch screen to the needs of the user.

### 6.3.1 Single-touch (analog resistive)

#### 6.3.1.1 Windows 10 IoT Enterprise

After starting Windows 10 IoT Enterprise on a Panel PC for the first time, the appropriate touch screen driver is installed automatically.

On all other devices, the touch screen driver must be subsequently installed to operate the touch screen. The appropriate driver is available for download in the Downloads section of the B&R website ([www.br-automation.com](http://www.br-automation.com)).

#### 6.3.1.2 Windows Embedded 8.1 Industry Pro

After starting Windows Embedded 8.1 Industry Pro on the Panel PC for the first time, the corresponding touch screen driver is installed automatically.

On all other devices, the touch screen driver must be subsequently installed to operate the touch screen. The appropriate driver is available for download in the Downloads section of the B&R website ([www.br-automation.com](http://www.br-automation.com)).

#### 6.3.1.3 Windows 7 Professional / Ultimate

After installing Windows 7 on the device, the touch screen driver must be installed in order to operate the touch screen. The appropriate driver is available for download in the Downloads section of the B&R website ([www.br-automation.com](http://www.br-automation.com)).

#### 6.3.1.4 Windows Embedded Standard 7 Embedded / Premium

A touch screen driver will be installed automatically if a touch controller is detected during the Windows Embedded Standard 7 installation.

The touch screen driver must be installed manually if a touch screen controller was not detected when installing Windows Embedded Standard 7 or if an Automation Panel has been connected after installation. The appropriate driver is available for download in the Downloads section of the B&R website ([www.br-automation.com](http://www.br-automation.com)).

#### 6.3.1.5 Windows XP Professional

After installing Windows XP Professional on the device, the touch screen driver must be installed in order to operate the touch screen. The appropriate driver is available for download in the Downloads section of the B&R website ([www.br-automation.com](http://www.br-automation.com)).

#### 6.3.1.6 Windows Embedded Standard 2009

After starting Windows Embedded Standard 2009 on the Panel PC or Power Panel for the first time (first boot agent), the corresponding touch screen driver is installed automatically.

On all other devices, the touch screen driver must be subsequently installed to operate the touch screen. The appropriate driver is available for download in the Downloads section of the B&R website ([www.br-automation.com](http://www.br-automation.com)).

### 6.3.2 Multi-touch (projected capacitive - PCT)

#### 6.3.2.1 Windows 10 IoT Enterprise

Microsoft multi-touch drivers are installed on the device during installation of Windows 10 IoT Enterprise. After successful installation, the device is immediately ready for operation.

#### 6.3.2.2 Windows Embedded 8.1 Industry Pro

Microsoft multi-touch drivers are installed on the device during installation of Windows Embedded 8.1 Industry Pro. After successful installation of Windows Embedded 8.1 Industry Pro, the device is immediately ready for operation.

### **6.3.2.3 Windows 7 Professional / Ultimate**

Microsoft multi-touch drivers are installed on the device during installation of Windows 7. After successful installation of Windows 7, the device is immediately ready for operation.

### **6.3.2.4 Windows Embedded Standard 7 Premium**

Microsoft multi-touch drivers are installed on the device during installation of Windows Embedded Standard 7 Premium. After successful installation of Windows Embedded Standard 7 Premium, the device is immediately ready for operation.



## 6.4 Display brightness control

In SDL, SDL3 or SDL4 operation, the brightness of the display can be configured using the B&R Control Center on the connected B&R industrial PC, for example. In DVI operation, the brightness can only be controlled using the two brightness controls provided on the SDL/DVI receiver.

### 6.4.1 Adjusting in SDL / SDL3 / SDL4 mode

1. Open **Control Center** in the Control Panel.
2. Select the **Display** tab.
3. Select the Automation Panel from the list.
4. Set the desired brightness using the slider.

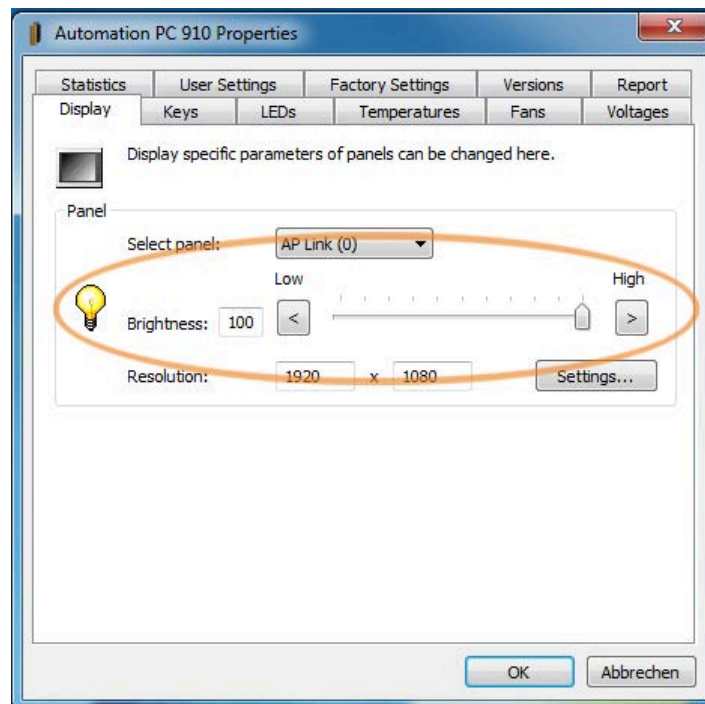

#### Information:

The changed settings are displayed online but only applied by the system (and used after the next restart) if the Control Center is exited with **OK**.

The configured brightness is independent of the value configured in BIOS Setup, i.e. the value set in BIOS is used until Windows boots. The value set in BIOS is only applied the first time the Control Center is launched.

### 6.4.2 Adjusting in DVI operation

1. Use the two brightness controls on the SDL/DVI receiver to set the brightness (for additional information, see "[SDL/DVI receiver \(5DLSDL.1001-00\)](#)" on page 33).

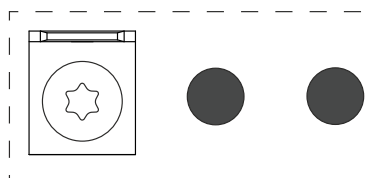

# 7 Software

---

## 7.1 Upgrade information

### **Warning!**

The BIOS and firmware on B&R devices must always be kept up to date. New versions can be downloaded from the B&R website ([www.br-automation.com](http://www.br-automation.com)).

### 7.1.1 Automation Panel firmware upgrade

With *Firmware upgrade (Automation Panel, SDL3 Converter, SLD4 converter)*, it is possible to update the firmware of several controllers (SDLR, SDL3R, SDL4R, SDL3 Converter, SDL4 Converter) depending on the variant of the system.

A current firmware upgrade can be downloaded directly from the Downloads section of the B&R website ([www.br-automation.com](http://www.br-automation.com)).

### **Caution!**

The Automation Panel is not permitted to be switched off or reset while performing an upgrade!

## 7.2 Automation Device Interface (ADI)

The Automation Device Interface (ADI) enables access to specific functions of B&R devices.

### 7.2.1 ADI driver

#### 7.2.1.1 Installation

The ADI driver is included in most B&R Windows operating systems or can be installed on request.

The ADI driver (also includes the ADI Control Center) and user documentation can be downloaded at no cost from the Downloads section of the B&R website ([www.br-automation.com](http://www.br-automation.com)). If a more recent version is available, it can be installed later.

#### Information:

The *Write filter* must be disabled during installation.

#### 7.2.1.2 ADI Control Center

The settings of B&R devices can be read out and changed in Windows using the ADI Control Center in the Control Panel. The figure shown is a symbolic image; the representation may vary depending on the device.

#### Information:

The displayed temperature and voltage values (e.g. CPU temperature, core voltage, battery voltage) represent uncalibrated information values. No conclusions about possible alarms or hardware malfunctions can be drawn from this. The hardware components used have automatic diagnostic functions in the event of error.

Module	Sensor	°C	°F	Alarm
System Unit	1	25.00	77.00	
System Unit	2	28.00	82.40	
System Unit	3	35.00	95.00	
System Unit	4	29.00	84.20	
IF Module 3	1	45.50	113.90	
IF Module 1	1	24.00	75.20	
Panel 0	1	30.00	86.00	
Panel 8	1	28.50	83.30	
CPU		29.00	84.20	
UPS	Battery	24.00	75.20	

#### 7.2.1.2.1 Functions

The ADI Control Center offers the following functions, for example:

- Changing display-specific parameters
- Reading out device-specific keys
- Updating the key configuration
- Testing keys or device-specific LEDs of a membrane keypad
- Reading out or calibrating control devices (e.g. key switch, handwheel, joystick, potentiometer)
- Reading out temperatures, fan speeds, switch positions and statistical data
- Reading out operating hours (power-on hours)
- Reading user settings and factory settings
- Reading out software versions
- Updating and backing up BIOS and firmware
- Creating reports for the current system (support)
- Setting the SDL equalizer value for the SDL cable adjustment
- Changing the user serial ID

For a detailed description, see the user documentation for the ADI driver.

#### Information:

The functions available in the ADI Control Center depend on the device family.

## 7.2.2 ADI Development Kit

This software allows *ADI* functions to be accessed from Windows applications created with Microsoft Visual Studio, for example:

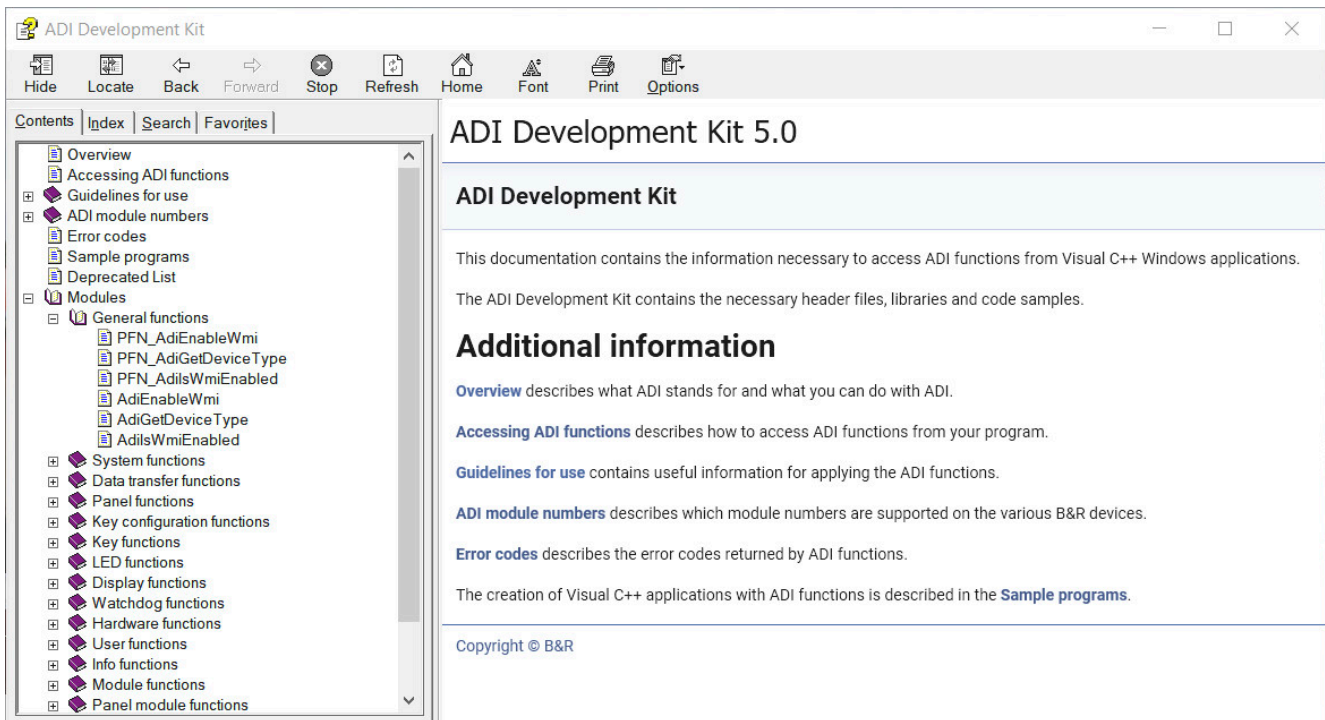

### Features:

- Header files and import libraries
- Help files
- Example projects
- ADI DLL: For testing applications if no ADI driver is installed.

The appropriate ADI driver must be installed for the device. The ADI driver is already included in B&R images of embedded operating systems.

For a detailed description of how to use ADI functions, see Automation Help.

The ADI Development Kit can be downloaded at no cost from the Downloads section of the B&R website ([www.br-automation.com](http://www.br-automation.com)).

## 7.2.3 ADI .NET SDK

This software allows *ADI* functions to be accessed from .NET applications created with Microsoft Visual Studio.

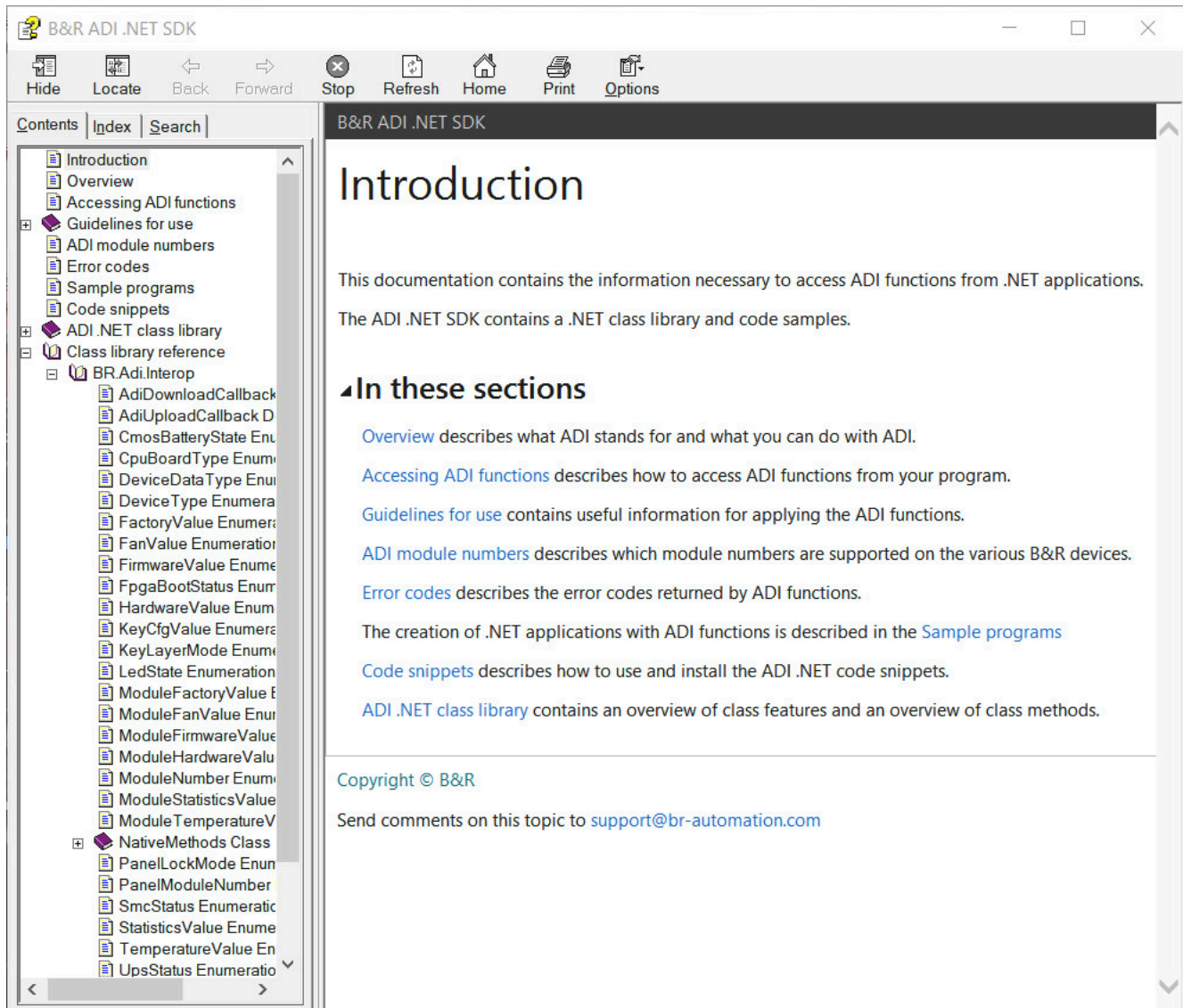

### Features:

- ADI .NET class library
- Help files (in English)
- Sample projects and code snippets
- ADI DLL: For testing applications if no ADI driver is installed.

The appropriate ADI driver must be installed for the device. The ADI driver is already included in B&R images of embedded operating systems.

For a detailed description of how to use ADI functions, see Automation Help.

The ADI .NET SDK can be downloaded at no cost from the Downloads section of the B&R website ([www.br-automation.com](http://www.br-automation.com)).

## 7.2.4 ADI OPC UA Server

This document contains technical information about B&R Automation Device Interface OPC UA Server (B&R ADI OPC UA Server).

The descriptions and figures refer to B&R ADI OPC UA Server V2.0.0 and later.

ADI OPC UA Server provides the functions and information of the Automation Device Interface (ADI) as OPC UA variables. OPC UA stands for **O**pen **P**latform **C**ommunications **U**nified **A**rchitecture and is an international standard for secure, reliable, manufacturer- and platform-independent information exchange in industrial communication.

OPC UA is based on the client-server principle and, in the case of ADI OPC UA Server, enables temperatures and device information to be read from B&R devices, for example.

Additional information is available on the OPC Foundation ([www.opcfoundation.org](http://www.opcfoundation.org)) website, for example.

The ADI OPC UA Server and user documentation can be downloaded at no cost from the Downloads section of the B&R website ([www.br-automation.com](http://www.br-automation.com)).

## 7.3 Key Editor

A frequently occurring requirement for panels is adapting function keys and LEDs to the application software. With the Key Editor, individual adaptation to the application is possible quickly and easily.

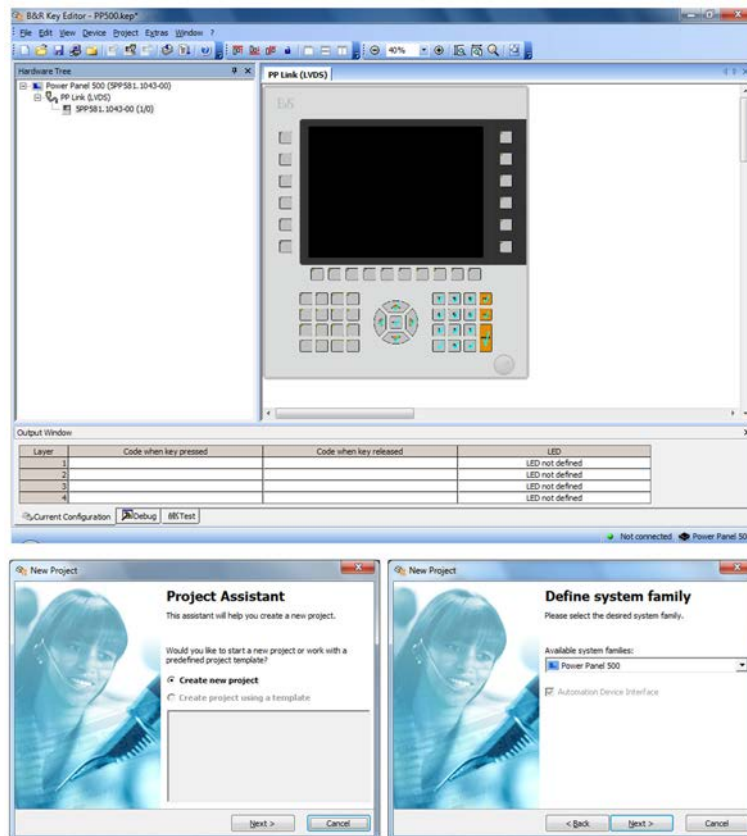

Figure 6: B&R Key Editor screenshots (version 3.50)

### Features:

- Configuration of normal keys like on a keyboard (A, B, C, etc.)
- Keyboard shortcuts (CTRL+C, SHIFT+DEL, etc.) on one key
- Special key functions (change brightness, etc.)
- Assignment of LED functions (HDD access, power, etc.)
- 4 assignments possible per key (using layers)
- Configuration of the panel lock time when connecting several Automation Panel devices to Automation PCs and Panel PCs

For detailed instructions about configuring keys and LEDs and installing the key configuration on the target system, see the help documentation for the Key Editor. The Key Editor and help documentation can be downloaded at no cost from the Downloads section of the B&R website ([www.br-automation.com](http://www.br-automation.com)).

## 7.4 RFID read/write transponder unit

### 7.4.1 Commissioning

#### 7.4.1.1 Connection

The reader can be operated on any commercially available type A USB interface that meets the specifications described in the technical data for the 5E9030.29.

#### 7.4.1.2 Supported operating systems

- Windows XP Professional
- Windows 7
- Windows 10 (no driver necessary)

#### 7.4.1.3 Driver installation

The driver for the USB communication device class (CDC) must be installed before using the transponder.

After the driver installation, the reader is identified as a serial COMx device.

#### **Information:**

This driver can be downloaded from the B&R website ([www.br-automation.com](http://www.br-automation.com)).

#### 7.4.1.4 Port settings

The following port settings are necessary for communication:

Bits per second: 115200

Data bits: 8

Parity: None

Stop bits: 1

Flow control: None

#### 7.4.1.5 Terminal program

For testing purposes, an appropriate terminal program (note "Port settings") can be used to communicate with the reader. In Windows, the freeware tools RealTerm or Tera Term can be used, for example.

#### **Information:**

Depending on the configuration of the terminal program, it may be necessary to enable input echoing (command "echo\_on") in order to see the input on the screen.



### 7.4.1.6 RFID command set

The transponder reads and writes MIFARE and ISO 15693 tags. The corresponding commands and parameters are valid depending on the tag being used. When a tag comes within range of the antenna, the PiccSelect message and serial number of the tag are output. When the tag is removed, the PiccRemove message and serial number of the tag are output.

```
*****
***** SW_ResetSTART *****
** Mifare **
** B&R Automation **
** S/W Rev. 0.7 **
**ENTER 'helpme' for information**
*****
PiccSelect: 3B7CF4E0
PiccRemove: 3B7CF4E0
```

1. Command "Command syntax"
2. The executed command in plain text
3. Response

```
read,a,ff ff ff ff ff ff,5
```

Command "read": Data in block 5 in HEX=00000000000000000000000000000000

"Error: <ErrorNumber> (error syntax)"

There is a difference between operating errors and RFID stack error messages. See section "[Error codes](#)".

#### Information:

Each command must be terminated by a carriage return (r).

## 7.4.2 Commands

### 7.4.2.1 General commands

Command	Description	Parameter 1	Parameter 2	Parameter 3	Parameter 4	Parameter 5
Info_On	Outputs command confirmation	--	--	--	--	--
Info_Off	Does not output command confirmation (default)	--	--	--	--	--
Show_Config	Displays current settings	--	--	--	--	--
Show_Revision	Displays software and hardware revision information	--	--	--	--	--
Show_Status	Displays the RFID stack error	--	--	--	--	--
Show_SN	Displays the active tag number	--	--	--	--	--
Show_Key	Displays the active key	--	--	--	--	--
Echo_On	Displays an input echo for the output	--	--	--	--	--
Echo_Off	Suppresses the input echo for the output (default)	--	--	--	--	--
Startup	Displays the startup message	--	--	--	--	--
Life	Life command -> Returns OK	--	--	--	--	--
Helpme	Displays a list of all commands	--	--	--	--	--
Show_Error	Shows error details	--	--	--	--	--
Restart	Restarts the reader	--	--	--	--	--

Table 32: General commands

### 7.4.2.2 Upgrade commands

Command	Description	Parameter 1	Parameter 2	Parameter 3	Parameter 4	Parameter 5
Firmware_Upgrade	Switches the transponder reader to USB mass storage update mode	--	--	--	--	--
Firmware_Info	Displays information about the current firmware	--	--	--	--	--

Table 33: Update commands

#### 7.4.2.2.1 Upgrade procedure

The following are necessary in order to upgrade the device firmware:

- Exclusive connection to the USB transponder reader
- Firmware file (e.g. firmware\_0.80.bin)
- Terminal program with active connection to the transponder reader (see "[Commissioning](#)")
- Direct access to the USB port is an advantage (reconnection).

### Procedure in Windows:

- 1) Enter command "Firmware\_Upgrade" to put the transponder reader in upgrade mode.
- 2) Depending on the Windows system settings, the transponder reader will automatically be registered as a USB mass storage device.
- 3) A new drive will appear in Windows Explorer (e.g. D:\).
- 4) Open the new drive in Windows Explorer.
- 5) Delete the firmware.bin file located there.
- 6) Copy the new firmware file (e.g. firmware\_80.bin) to the drive.
- 7) The transponder reader should now be modified by the new firmware.
- 8) The transponder reader must be restarted to complete the upgrade procedure. This is done by disconnecting and reconnecting the USB port or by switching the device off and back on again.
- 9) It is possible to check the firmware version with command "show\_revision" or command "firmware\_info" after a restart.

## 7.4.3 MIFARE

### 7.4.3.1 MIFARE commands

Command	Description	Parameter 1	Parameter 2	Parameter 3	Parameter 4	Parameter 5
Read	Reads a 16-byte block from PICC	"A" or "B"	See table Access rights (parameter 2).	Source block	--	--
Read_Blocks	Reads the specified range of blocks from PICC	"A" or "B"	See table Access rights (parameter 2).	Starting block	Ending block	--
Write	Writes a 16-byte block to PICC	"A" or "B"	See table Access rights (parameter 2).	Destination block	16-byte data in hex 00h	--
Decr	Takes the value of the source value block, subtracts the specified value and writes the result to the destination block	"A" or "B"	See table Access rights (parameter 2).	Source block	Destination block	Value
Incr	Takes the value of the source value block, adds the specified value and writes the result to the destination block	"A" or "B"	See table Access rights (parameter 2).	Source block	Destination block	Value
Restore	Copies a value block	"A" or "B"	See table Access rights (parameter 2).	Source block	Destination block	--
InitZero	Initializes a value block with the value 0	"A" or "B"	See table Access rights (parameter 2).	Destination block	--	--
Store_Key_EEPROM	Stores a 6-byte key in EEPROM	"A" or "B"	Sector for key in reader's EEPROM	6-byte key		
Store_Key_Temp	Stores a 6-byte key in the transponder reader temporarily until switched off	6-byte key	--	--	--	--
Connect	Connects manually to a specific tag	4-byte SNr	--	--	--	--
Disconnect	Automatically restores a connection to the best tag	--	--	--	--	--
Key_CMD	Sends a key directly with each command (default)	--	--	--	--	--
Key_EEPROM	Uses the key from EEPROM	--	--	--	--	--
Key_TEMP	Uses the temporary key	--	--	--	--	--

Table 34: MIFARE commands

### 7.4.3.2 Authentication

The keys needed for authentication can be stored either in EEPROM or temporarily in the transponder. Alternatively, the authentication keys can be transferred with the command.

Commands Key\_EEPROM, Key\_TEMP and Key\_CMD are used to set the storage location or to send the authentication keys.

The following commands are used to store the authentication key in the transponder:

MIFARE commands - Authentication key storage					
Command	Parameter 1	Parameter 2	Parameter 3	Parameter 4	Parameter 5
Store_key_eeprom	"A" or "B"	Sector for key in reader's EEPROM	6-byte key	--	--
Store_key_temp	6-byte key	--	--	--	--

Table 35: MIFARE commands - Authentication key storage

```
store_key_eeprom,a,0,ff ff ff ff ff ff
```

Command "store\_key\_eeprom": The key is written to EEPROM sector 0.

Default key (when tags are delivered): 0xFF FF FF FF FF FF

Up to 16 keys (0 to 15) can be stored in EEPROM for each key (A and B).

#### **7.4.3.3 Access rights and memory organization**

The tag is divided into 16 sectors of 4 blocks each. Each block contains 16 bytes. The 4th block in each sector contains the keys and access rights for the respective sector (sector trailer). Access rights can be assigned individually to each block. Each sector can be assigned one of two different keys (A or B).

These keys and access rights must be stored in a defined format (according to the MIFARE specification). To change these access rights, use command "write" to write to the respective sector trailer in the proper format.

This documentation will not go into further detail with regard to the memory organization and access rights of tags. For additional information, see data sheet "MIFARE standard card IC MF1 IC S50 functional specification".

#### **7.4.3.4 Value block**

A block can be used as a value block. A value block is a signed 4-byte value. With each command (read, increment, decrement, restore), the tag automatically increments/decrements the value without requiring the value to be read. In order to use a block as a value block, it must adhere to a defined format.

This documentation will not go into further detail with regard to the value blocks of tags. For additional information, see the attached data sheet "MIFARE standard card IC MF1 IC S50 functional specification".

### 7.4.3.5 Access rights

There are various options for parameter 2 depending on the configuration.

MIFARE access rights (parameter 2)			
Config	Key_CMD	Key_EEPROM	Key_TEMP
Para2	6-byte key	Sector for key in reader's EEPROM	Uses the temporarily stored key: Dummy value (0-63)

Table 36: MIFARE access rights (parameter 2)

"A" = Authentication with key A, "B" = Authentication with key B

**Sector** = 0-63

**Source or target block** = 0-254 (depending on type MIFARE 1K 0-63, MIFARE 4K 0-254, with decrement, increment, restore, source block must be of type "value block")

**Data and key** = 00 - FF (no leading "0x", bytes can optionally be separated by a space)

**Value** = 4 byte including sign bit

All commands and parameters are in ASCII. Data is in 00h hex format.

Para1	Para2	Para3	Para4	Para5
Block (typically 3 - sector trailer)	Access rights for block 0 (data block)	Access rights for block 1 (data block)	Access rights for block 2 (data block)	Access rights for block 3 (sector trailer)

Table 37: MIFARE access rights (5-byte parameters)

Value	RD	WR	INCR	DECREMENT / TRANSFER / RESTORE	Comment
0x00	A / B	A / B	A / B	A / B	Full access with every key (default factory setting)
0x01	A / B	B	-	-	
0x02	A / B	-	-	-	
0x03	A / B	B	B	A / B	Value block
0x04	A / B	-	-	A / B	Value block
0x05	B	-	-	-	
0x06	B	B	-	-	
0x07	-	-	-	-	No access

Table 38: MIFARE access rights - Parameters 2, 3 and 4 (data blocks)

If key B is read in the corresponding sector trailer, it cannot be used for authentication (all of the yellow rows in the table above).

**Consequences:** When the reader attempts to authenticate a block in a sector with Key B (access conditions marked in gray), then the card will refuse all subsequent memory access following the authentication.

Value	Key A		Access bits		Key B		Comment
	RD	WR	RD	WR	RD	WR	
0x00	-	A	A	-	A	A	Key B can be read.
0x01	-	B	A / B	-	-	B	
0x02	-	-	A	-	A	-	Key B can be read.
0x03	-	-	A / B	-	-	-	No access
0x04	-	A	A	A	A	A	Key B can be read (factory default).
0x05	-	-	A / B	B	-	-	
0x06	-	B	A / B	B	-	B	
0x07	-	-	A / B	-	-	-	No access

Table 39: MIFARE access rights - Parameter 5 (sector trailer)

The rows marked in yellow are access conditions where key B can be read and used for data.

### 7.4.3.6 MIFARE commands - Examples

```
Befehl:
write,a,0,5,0123456789ABCDEF0123456789ABCDEF
Antwort:
Command write -> Data in sector 1 Block 5 written=0123456789ABCDEF0123456789ABCDEF
```

```
Befehl:
read,a,0,5
Antwort:
Command read -> Data in block 5 in HEX=0123456789ABCDEF0123456789ABCDEF
```

```
Befehl:
Initzero,a,0,8
Antwort:
Command initzero -> Data in sector 2 Block 8 written=00000000FFFFFFFF0000000000FF00FF
```

```
Befehl:
Incr,a,0,8,8,2
Antwort:
Command incr -> Block 008 successful by 000000002 incremented and written to block 008
```

```
Befehl:
read,a,ff ff ff ff ff ff,5
Antwort:
Command read -> Data in Block 5 in HEX=FFFF0000000000000000000000000000
```

```
Befehl:
connect,0b a1 78 98
Antwort:
Command connect ->
*****INFO*****
Key_mode = Key_eeeprom
Info_text = Info_on
Tag_connected = Manual_mode
Tag_sn = 0BA17898
*****END_OF_INFO*****
```

```
Befehl:
read_blocks,a,0,0,3
Antwort:
Command read_blocks ->
Data in block 0 in HEX=3B7CF4E05388040046B9949745302809
Data in block 1 in HEX=00000000000000000000000000000000
Data in block 2 in HEX=00000000000000000000000000000000
Data in block 3 in HEX=000000000000FF078069FFFFFFFFFFFF
```

## 7.4.4 ISO15693

### 7.4.4.1 ISO 15693 commands

Command	Description	Parameter 1	Parameter 2	Parameter 3	Parameter 4	Parameter 5
Read	Reads a 4-byte block from PICC	Flags (flag)	Source block	--	--	--
Read_Blocks	Reads the specified range of blocks from PICC	Flags (flag)	Starting block	Ending block	--	--
Write	Writes a 4-byte block to PICC	Flags (flag)	Destination block	4-byte data in hex 00h	--	--
Sys_Info	Reads the AFI, DSFID, number of bytes and bytes/block	Flags (flag)	--	--	--	--
Security	Displays the write protection status of individual blocks	Flags (flag)	Starting block	Ending block	--	--
Set_AFI	Writes the AFI value	Flags (flag)	1-byte value	--	--	--

Table 40: ISO 15693 commands

Command	Description	Parameter 1	Parameter 2	Parameter 3	Parameter 4	Parameter 5
Set_DSFD	Writes the DSFD value	Flags (flag)	1-byte value	--	--	--
Lock_Block	Enables write protection for a block	Flags (flag)	Target block	--	--	--
Lock_AFI	Sets AFI write protection	Flags (flag)	--	--	--	--
Lock_DSFD	Sets DSFD write protection	Flags (flag)	--	--	--	--
Connect	Connects manually to a specific tag	8-byte SNr	--	--	--	--
Disconnect	Automatically restores a connection to the best tag	--	--	--	--	--
Inventory	Reads the UID and DSFD from the PICC	Flags (flag)	AFI	Bit length	Mask	
Stay_Quiet	PICC enters quiet mode	Flags (flag)	Serial number	--	--	--
Reset_To_Ready	PICC exits quiet mode	Flags (flag)	Serial number	--	--	--
Reset_Quiet	All PICCs exit quiet mode	--	--	--	--	--

Table 40: ISO 15693 commands

**Information:**

For additional information about flags, see ["Flag definitions"](#).

**7.4.4.2 Memory organization**

**Source and destination block** = 0 to 254 (depends on the tag)

**Data and key** = 00 to FF (no leading "0x", bytes can optionally be separated by a space)

**Value** = 1 byte including sign bit

All commands and parameters are in ASCII. Data is in 00h hex format.

### 7.4.4.3 Flag definitions

Request Flag Bits 1 to 4			
Bit	Flag Name	Value	Description
b1	Subcarrier flag	0	A single subcarrier is used by the flag
		1	Two subcarriers are used by the flag
b2	Data rate flag	0	Low data rate
		1	High data rate
b3	Inventory flag	0	Flags 5 to 8 meaning in following tables (points to table "Request Flag Bits 5 to 8 when inventory flag IS NOT set"
		1	Flags 5 to 8 meaning in following tables (points to table Request Flag Bits 5 to 8 when inventory flag IS set
b4	Protocol extension flag	0	No protocol format extension
		1	Protocol format is extended. Reserved for future use.

Table 41: Request Flag Bits 1 to 4

Request Flag Bits 5 to 8 when inventory flag IS NOT set			
Bit	Flag Name	Value	Description
b5	Select flag	0	Request executed by any tag according to the setting of <i>Adress flag</i>
		1	Request executed only by tag in selected state. The <i>Adress flag</i> is set to 0 and the UID field is not included in the request
b6	Address flag	0	Request is nor addressed. UID field is not included. It can be executed by any tag.
		1	Request is addressed. UID field is included. It is executed only by the tag whose UID matches the UID sepcified in the request
b7	Option flag	0	Meaning is defined by the command description. It is set to 0 if not otherwise defined by the command.
		1	Meaning is defined by the command description
b8	RFU	0	Reserved for future use

Table 42: Request Flag Bits 5 to 8 when inventory flag IS NOT set

Request Flag Bits 5 to 8 when inventory flag IS set			
Bit	Flag name	Value	Description
b5	AFI flag	0	AFI field is not present
		1	AFI field is present
b6	Nb_slots_flag	0	16 slots
		1	1 slot
b7	Option flag	0	Meaning is defined by the request description. It is set to 0 if not otherwise defined by the request
		1	Meaning is defined by the request desription
b8	RFU	0	Reserved for future use

Table 43: Request Flag Bits 5 to 8 when inventory flag IS set

#### 7.4.4.4 ISO 15693 commands - Examples

##### 7.4.4.4.1 Inventory

flags [hex]:

0x02 = High Data rate

0x04 = Inventory

0x10 = AFI value is set

0x20 = Single slot

afi [dec]:

AFI value if 0x10 set in the flags

bitlength [dec]:

Bit length of the subsequent UID mask. A maximum bit length of 60 is permitted for 16 slots; a bit length of 64 is permitted for one slot. The length of the subsequent mask is derived from this parameter.

mask [hex]:

UID mask for the inventory command - 1 to 8 bytes. If the bit length is "0", then a byte ("00") must be transmitted.

#### INFORMATION:

The UID of an ISO 15693 transponder is output in reverse byte order.

#### Inventory examples:

```
Inventory,06,0,0,0  \\ Inventory mit High data rate, 16 Slots, kein AFI Wert
Inventory,16,3,0,0  \\ Inventory mit High data rate, 16 Slots, AFI Wert '3'
Inventory,26,0,0,0  \\ Inventory mit High data rate, 1 Slot, kein AFI Wert
```

#### Inventory response:

```
1 Byte DSFID Wert, 8 Byte UID - Slot 1
1 Byte DSFID Wert, 8 Byte UID - Slot 2
...
...
1 Byte DSFID Wert, 8 Byte UID - Slot 16
```

If 0x20 is set as a flag, then only the entry from slot 1 is valid. All other slots return "0".

##### 7.4.4.4.2 Reset\_To\_Ready

#### Reset\_To\_Ready

flags (hex), sn [hex]: 8-byte UID of tag

The filter for the tag is set, and the tag is disconnected.

##### 7.4.4.4.3 Stay\_Quiet

#### Stay\_Quiet

flags (hex), sn [hex]: 8-byte UID of tag

The filter of the tag is reset and reappears with the inventory command.

##### 7.4.4.4.4 Reset\_Quiet

#### Reset\_Quiet

This command resets ALL filters that were set previously with Stay\_Quiet.



## 7.4.5 Error codes

### 7.4.5.1 Error messages and error numbers

Operating errors		
Value	Name	Description
0	ERR_NONE	No errors (OK)
1	ERR_OTHER	Miscellaneous operating error, unrecognized command
2	ERR_PARAMETER	Incorrect number of parameters
3	ERR_AUTH	Authentication error (A or B)
4	ERR_SECTOR	Invalid range for sector (0-63)
5	ERR_BLOCK_SRC	Invalid range for source block (0-255)
6	ERR_WRITE	No data found for writing
7	ERR_KEY_EE	No key found for writing
8	ERR_KEY_STORE	Could not save key
9	ERR_BLOCK_DST	Invalid range for destination block (0-255)
10	ERR_NO_TAG	No tag in range
11	ERR_BLOCK_NUM	Incorrect values for source/destination blocks
12	ERR_TAG_NUM	Invalid tag number
13	ERR_KEY	Invalid key
14	ERR_REMOTE	X-modem firmware update canceled (not used)
15	ERR_SYNC	X-modem firmware update packet start not found (not used)
16	ERR_RETRY	X-modem firmware update number of retry attempts (not used)
17	ERR_READ	Could not read data
18	ERR_INCDECREAS	Error accessing value block
19	ERR_LOCK	Could not lock block
20	ERR_AFI	Error writing AFI value
21	ERR_DSFD	Error writing DSFD value
22	ERR_SYSINFO	Could not read system information
23	ERR_INVENTORY	Could not execute inventory command due to incorrect parameter (value) or internal RFID stack error
24	ERR_STAY_QUIET	Could not set specified ISO tag to STAY_QUIET (no longer accessible)
25	ERR_RESET2READY	Could not set specified ISO tag to READY (after a preceding STAY_QUIET)

Table 44: Operating errors

RFID stack errors can be queried using command "show\_status". Each error number consists of a high byte (stack components) and a low byte (errors). Command "show\_error" allows the error to be evaluated in detail. (for example: ISO15693 error codes, see ["Response Flags & Error Codes"](#))

Error messages - RFID stack LOW byte		
Value	Name	Description
0xXX00	PH_ERR_SUCCESS	Returned in case of no error
0xXX71	PH_ERR_SUCCESS_CHAINING	Rx chaining is not complete, further action needed
0xXX72	PH_ERR_SUCCESS_INCOMPLETE_BYTE	An incomplete byte was received
0xXX01	PH_ERR_IO_TIMEOUT	No reply received, e.g. PICC removal
0xXX02	PH_ERR_INTEGRITY_ERROR	Wrong CRC or parity detected
0xXX03	PH_ERR_COLLISION_ERROR	A collision occurred
0xXX04	PH_ERR_BUFFER_OVERFLOW	Attempt to write beyond buffer size
0xXX05	PH_ERR_FRAMING_ERROR	Invalid frame format
0xXX06	PH_ERR_PROTOCOL_ERROR	Received response violates protocol
0xXX07	PH_ERR_AUTH_ERROR	Authentication error
0xXX08	PH_ERR_READ_WRITE_ERROR	A Read or Write error occurred in RAM/ROM or Flash
0xXX09	PH_ERR_TEMPERATURE_ERROR	The RC sensors signal overheating
0xXX0A	PH_ERR_RF_ERROR	Error on RF-Interface
0xXX0B	PH_ERR_INTERFACE_ERROR	An error occurred in RC communication
0xXX0C	PH_ERR_LENGTH_ERROR	A length error occurred
0xXX7F	PH_ERR_INTERNAL_ERROR	An internal error occurred
0xXX20	PH_ERR_INVALID_DATA_PARAMS	Invalid data parameters supplied (layer id check failed)
0xXX21	PH_ERR_INVALID_PARAMETER	Invalid parameter supplied
0xXX22	PH_ERR_PARAMETER_OVERFLOW	Reading/Writing a parameter would produce an overflow
0xXX23	PH_ERR_UNSUPPORTED_PARAMETER	Parameter not supported
0xXX24	PH_ERR_UNSUPPORTED_COMMAND	Command not supported
0xXX25	PH_ERR_USE_CONDITION	Condition of use not satisfied
0xXX26	PH_ERR_KEY	A key error occurred
0xXX80	ISO15693_ERROR	See <a href="#">"Response Flags &amp; Error Codes"</a> .
0xXX80	MIFARE	NAK 0
0xXX81	MIFARE	NAK 1
0xXX82	MIFARE	NAK 4
0xXX83	MIFARE	NAK 5

Table 45: Error messages - RFID stack LOW byte

Error messages - RFID stack HIGH byte		
Value	Name	Description
0x00XX	PH_COMP_GENERIC	Generic Component Code
0x01XX	PH_COMP_BAL	BAL Component Code
0x02XX	PH_COMP_HAL	HAL Component Code
0x03XX	PH_COMP_PAL_ISO14443P3A	ISO14443-3A PAL-Component Code
0x04XX	PH_COMP_PAL_ISO14443P3B	ISO14443-3B PAL-Component Code
0x05XX	PH_COMP_PAL_ISO14443P4A	ISO14443-4A PAL-Component Code
0x06XX	PH_COMP_PAL_ISO14443P4	ISO14443-4 PAL-Component Code
0x07XX	PH_COMP_PAL_MIFARE	MIFARE(R) PAL-Component Code
0x08XX	PH_COMP_PAL_FELICA	Open FeliCa PAL-Component Code
0x09XX	PH_COMP_PAL_EPCUID	ICode EPC/UID PAL-Component Code
0x0AXX	PH_COMP_PAL_SLI15693	ICode SLI/ISO15693 PAL-Component Code
0x0BXX	PH_COMP_PAL_I18000P3M3	ISO18000-3 Mode3 PAL-Component Code
0x0CXX	PH_COMP_PAL_I18092MPI	ISO18092 passive initiator mode PAL-Component Code
0x10XX	PH_COMP_AL_MFC	MIFARE(R) Classic AL-Component Code
0x11XX	PH_COMP_AL_MFUL	MIFARE(R) Ultralight AL-Component Code
0x12XX	PH_COMP_AL_MFP	MIFARE(R) Plus AL-Component Code
0x13XX	PH_COMP_AL_VCA	Virtual Card Architecture AL-Component Code
0x14XX	PH_COMP_AL_FELICA	Open FeliCa AL-Component Code
0x15XX	PH_COMP_AL_I15693	ISO15693 AL-Component Code
0x16XX	PH_COMP_AL_SLI	ICode SLI AL-Component Code
0x18XX	PH_COMP_AL_I18000P3M3	ISO18000-3 Mode3 AL-Component Code
0x19XX	PH_COMP_AL_MFDF	MIFARE DESFIRE EV1 AL Component Code
0x1AXX	PH_COMP_AL_P40CMDPRIV	P40 command libraryAL-Component Code
0x1BXX	PH_COMP_AL_P40CMDPUB	P40 command libraryAL-Component Code
0x30XX	PH_COMP_DL_AMP	Amplifier DL-Component Code
0x31XX	PH_COMP_DL_THSTRM	Thermostream DL-Component Code
0x32XX	PH_COMP_DL_OSCI	Oscilloscope DL-Component Code
0x33XX	PH_COMP_DL_RDFFPGA	Reader FPGA Box DL-Component Code
0x34XX	PH_COMP_DL_MSTAMPOSC	Master Amplifier Oscilloscope DL-Component Code
0x35XX	PH_COMP_DL_STEPPER	Stepper DL-Component Code
0xE0XX	PH_COMP_CIDMANAGER	Cid Manager Component Code
0xE1XX	PH_COMP_CRYPTOSYM	CryptoSym Component Code
0xE2XX	PH_COMP_KEYSTORE	KeyStore Component Code
0xE3XX	PH_COMP_TOOLS	Tools Component Code
0xE4XX	PH_COMP_CRYPTORNG	CryptoRng Component Code
0xEFXX	PH_COMP_LOG	Log Component Code

Table 46: Error messages - RFID stack HIGH byte

Response Flags			
Bit	Flag Name	Value	Description
b1	Error Flag	0	No error
		1	Error detected. Errorcode is in the Error filed response
b2	RFU	0	Reserved for future use
b3	RFU	0	Reserved for future use
b4	Extension flag	0	High data rate
		1	Protocol format is extended. Reserved for future use
b5	RFU	0	Reserved for future use
b6	RFU	0	Reserved for future use
b7	RFU	0	Reserved for future use
b8	RFU	0	Reserved for future use
Error Codes			
Value	Description		
01	The request is not supported, i.e., the request code is not recognized		
02	The request code is not recognized, for example: a format error occurred.		
03	The request option is not supported.		
0F	Error with no information given or a specific error code is not supported		
10	The specified block is not available (does not exist)		
11	The specified block is already locked and thus cannot be locked again		
12	The specified block is locked and its content cannot be changed		
13	The specified block was not successfully programmed		
14	The specified block was not successfully locked		
A0 - DF	Custom request error codes		
All others	Reserved for future use		

Table 47: Response Flags &amp; Error Codes

## 8 International and national certifications

### 8.1 Directives and declarations

#### 8.1.1 CE marking



All directives applicable to the respective product and their harmonized EN standards are met.

#### 8.1.2 EMC Directive

These devices meet the requirements of EC directive "2014/30/EU Electromagnetic compatibility" and are designed for the following application areas:

EN 61131-2:2007 + Ber 1:2009-01	Programmable controllers - Part 2: Equipment requirements and tests
EN 61000-6-2:2005 + AC:2011	Electromagnetic compatibility (EMC) - Part 6-2: Generic standards - Immunity for industrial environments
EN 61000-6-4:2007 + A1:2011	Electromagnetic compatibility (EMC) - Part 6-4: Generic standards - Emission standard for industrial environments

#### 8.1.3 Low voltage directive

These devices meet the requirements of the EC directive "2014/35/EU Low Voltage Directive" and are designed for the following application areas:

EN 61131-2:2007 + Ber 1:2009-01	Programmable controllers - Part 2: Equipment requirements and tests
EN 60204-1:2006 + A1:2009	Safety of machinery - Electrical equipment of machines - Part 1: General requirements

The low voltage directive applies to equipment that can be used with a nominal voltage between 50 and 1000 VAC and between 75 and 1500 VDC.

#### 8.1.4 Radio Equipment Directive (RED)

These products meet the requirements of EU directive "Radio Equipment Directive 2014/53/EU" and are designed for industrial use:

EN 61131-2:2007	Programmable controllers - Part 2: Equipment requirements and tests
EN 61000-6-2:2005	Electromagnetic compatibility (EMC) - Part 6-2: Generic standards - Immunity for industrial environments
EN 61000-6-4:2007	Electromagnetic compatibility (EMC) - Part 6-4: Generic standards - Emission standard for industrial environments
EN 300 330 V2.1.1	Short range devices (SRD) - Radio equipment in the frequency range 9 kHz to 25 MHz and inductive loop systems in the frequency range 9 kHz to 30 MHz
EN 301 489-1 V2.2.0	Electromagnetic compatibility (EMC) - Standard for radio equipment and services - Part 1: Common technical requirements - Harmonized standard for electromagnetic compatibility

EN 301 489-3 V2.1.1	Electromagnetic compatibility (EMC) standard for radio equipment and services - Part 3: Specific conditions for short-range devices (SRD) operating on frequencies between 9 kHz and 246 GHz
EN 62368-1:2014/ AC:2015/A11:2017	Audio/Video, information and communication technology equipment - Part 1: Safety requirements
EN 50364:2010	Limitation of human exposure to electromagnetic fields from devices operating in the frequency range 0 Hz to 300 GHz, used in electronic article surveillance (EAS), radio frequency identification (RFID) and similar applications
EN 62369-1:2010	Evaluation of human exposure to electromagnetic fields from short-range devices (SRDs) in various applications over the frequency range 0 GHz to 300 GHz - Part 1: Fields produced by devices used for electronic article surveillance, radio frequency identification and similar systems

## 8.2 Certifications

### Danger!

**A complete system can only receive certification if ALL individual components installed and connected in it have the corresponding certifications. If an individual component is used that does NOT have the corresponding certification, the complete system will also NOT be certified.**

B&R products and services comply with applicable standards. These are international standards from organizations such as ISO, IEC and CENELEC, as well as national standards from organizations such as UL, CSA, FCC, VDE, ÖVE, etc. We pay special attention to the reliability of our products in the industrial sector.

Unless otherwise specified, the following certifications apply:

### Information:

**Currently valid certifications are listed on the serial number adhesive label of the device.**

#### 8.2.1 UL certification



Products with this mark are tested by Underwriters Laboratories and listed as "industrial control equipment". The mark is valid for the USA and Canada and facilitates the certification of your machines and systems in this economic area.

Underwriters Laboratories (UL) per standards UL 61010-1 and UL 61010-2-201 Canadian (CSA) standard per C22.2 No. 61010-1-12 and CSA C22.2 No. 61010-2-201:14

Ind. Cont. Eq.  
E115267

The UL certificates are available on the B&R website ([Downloads > Certificates > UL](#)).

##### 8.2.1.1 UL - Additional information

As "type 4X equipment" or IP65 (EN 60529), it meets all requirements for a separate protective housing when used in industrial control equipment per UL 508, UL 61010-1 or when relevant standards such as UL 50, UL 50E are applied.

#### 8.2.2 EAC



Products with this mark are tested by an accredited test laboratory and permitted to be imported into the Eurasian Customs Union (based on EU conformity).

### 8.2.3 UKCA



#### UK Conformity Assessed (UKCA)

All directives applicable to the respective product and their relevant standards are met. Products with this marking are permitted to be imported into Great Britain (England, Wales, Scotland).

#### Information:

The declarations of conformity are available on the B&R website ([Downloads > Certificates > Declarations of conformity](#)).

### 8.2.4 FCC and IC

Products with this mark are tested by Underwriters Laboratories and listed as "industrial control equipment". The mark is valid for the USA and Canada and facilitates the certification of your machines and systems in this economic area.

**USA:**  
Federal Communications  
Commission (FCC)

This device complies with Part 15 of the FCC rules. Operation is subjected to the following two conditions: (1) this device may not cause harmful interference, and (2) this device must accept any interference received, including interference that may cause undesired operation.

**Canada:**  
Industry Canada (IC)

This device contains license-exempt transmitter(s)/receiver(s) that comply with Innovation, Science and Economic Development Canada's license-exempt RSS(s). Operation is subject to the following two conditions: (1) this device may not cause interference, and (2) this device must accept any interference received, including interference that may cause undesired operation.

If products are also equipped with an RFID read/write unit, it must be approved for operation in the USA and Canada. These types of products are identified by a sticker with "Contains FCC ID:" and "Contains IC:" on the RFID read/write unit. In addition to the additional sticker for products with an RFID read/write unit, the requirements below also apply.

#### Information:

**Changes or modifications not expressly approved by the party responsible for compliance could void the user's authority to operate the equipment.**

#### Information:

**This equipment has been tested and found to comply with the limits for a Class A digital device, pursuant to part 15 of the FCC Rules. These limits are designed to provide reasonable protection against harmful interference when the equipment is operated in a commercial environment. This equipment generates, uses, and can radiate radio frequency energy and, if not installed and used in accordance with the instruction manual, may cause harmful interference to radio communications. Operation of this equipment in a residential area is likely to cause harmful interference in which case the user will be required to correct the interference at his own expense.**

## 9 Accessories

---

The following accessories have undergone functional testing by B&R in connection with the device used and can be operated with this device. Possible limitations regarding operation with individual components other than the complete system must be taken into account, however. All individual specifications of the components must be observed when operating the complete system.

All components listed in this manual have undergone intensive system and compatibility testing and been approved accordingly. B&R cannot assume any functional warranty for accessories that have not been approved.

### 9.1 Accessories - Information

#### **Information:**

Accessories can be ordered at B&R using the following order numbers.

### 9.2 Cables

For additional information about compatible cables, see the B&R website ([HMI cable manual](#)).

### 9.3 USB mass storage device

For additional information about compatible USB mass storage devices, see the B&R website ([USB mass storage devices](#)).

## 9.4 Terminal block power supply

### 9.4.1 0TB103.9x

#### 9.4.1.1 Order data

Order number	Short description	Figure
	<b>Accessories</b>	
0TB103.9	Connector 24 VDC - 3-pin, female - Screw clamp terminal block 3.31 mm <sup>2</sup>	
0TB103.91	Connector 24 VDC - 3-pin, female - Cage clamp terminal block 3.31 mm <sup>2</sup>	

#### 9.4.1.2 Technical data

### Information:

The following specified characteristic data, features and limit values are only valid for this accessory and may differ from those of the complete system. The data specified for the complete system applies to the complete system in which this accessory is installed, for example.

Order number	0TB103.9	0TB103.91
<b>General information</b>		
Certifications		
CE		Yes
UL		cULus E115267 Industrial control equipment
HazLoc		cULus HazLoc E180196 Industrial control equipment for hazardous locations Class I, Division 2, Groups ABCD, T4 <sup>1)</sup>
DNV		Temperature: <b>B</b> (0 - 55°C) Humidity: <b>B</b> (up to 100%) Vibration: <b>A</b> (0.7 g) EMC: <b>B</b> (bridge and open deck) <sup>2)</sup>
LR		ENV3
KR		Yes
ABS		Yes
BV		<b>EC31B</b> Temperature: 5 - 55°C Vibration: 0.7 g EMC: Bridge and open deck
EAC		Yes
<b>Terminal block</b>		
Note	Protected against vibration by the screw flange Nominal data per UL	
Number of pins	3 (female)	
Type of terminal block	Screw clamp terminal block variant	Cage clamp terminal block variant <sup>3)</sup>
Cable type	Only copper wires (no aluminum wires!)	
Pitch	5.08 mm	
Connection cross section		
AWG wire	26 to 14 AWG	26 to 12 AWG
Wire end sleeves with plastic covering	0.20 to 1.50 mm <sup>2</sup>	
Solid wires	0.20 to 2.50 mm <sup>2</sup>	
Fine-stranded wires	0.20 to 1.50 mm <sup>2</sup>	0.20 to 2.50 mm <sup>2</sup>
With wire end sleeves	0.20 to 1.50 mm <sup>2</sup>	
Tightening torque	0.4 Nm	-
<b>Electrical properties</b>		
Nominal voltage	300 V	
Nominal current <sup>4)</sup>	10 A / contact	
Contact resistance	≤5 mΩ	
<b>Operating conditions</b>		
Pollution degree per EN 61131-2	Pollution degree 2	

- 1) Yes, but applies only if all components installed in the complete system have this certification and the complete system bears the corresponding mark.
- 2) Yes, but applies only if all components installed in the complete system have this certification and are listed on the associated DNV certificate for the product family.
- 3) The cage clamp terminal block cannot be used side by side.
- 4) The respective limit data of the I/O modules must be taken into account!



## 9.5 Cage clamp terminal block for wiring emergency stop

### 9.5.1 0TB1104.8100

#### 9.5.1.1 General information

This 1-row, 4-pin cage clamp terminal block is used to connect to various B&R modules.

#### 9.5.1.2 Order data

Order number	Short description	Figure
	<b>Accessories</b>	
0TB1104.8100	Accessory terminal block (3.5), 4-pin, cage clamp terminal block, 1.5 mm <sup>2</sup> , protected against vibration by the screw flange	

#### 9.5.1.3 Technical data

Order number	0TB1104.8100
<b>General information</b>	
Certifications	
EAC	Product family certification
<b>Terminal block</b>	
Number of pins	4
Type of terminal block	Cage clamp terminal block
Cable type	Only copper wires (no aluminum wires!)
Pitch	3.5 mm
Connection cross section	
AWG wire	AWG 28 - AWG 14
Tightening torque	Max. 0.25 Nm
<b>Electrical properties</b>	
Nominal voltage	300 V
Nominal current <sup>1)</sup>	10 A / contact
Contact resistance	5.00 mΩ

1) The limit data for each I/O module must be taken into consideration.

## 9.6 Screw clamp terminal block for wiring B&R illuminated ring keys

### 9.6.1 0TB1112.8010

#### 9.6.1.1 General information

This 1-row, 12-pin screw clamp terminal block is used to connect to various B&R modules.

#### 9.6.1.2 Order data

Order number	Short description	Figure
	<b>Accessories</b>	
0TB1112.8010	Accessory terminal block, 12-pin, screw clamp terminal block 1.5 mm <sup>2</sup> , Screw flange, pitch 3.5 mm	

Table 52: 0TB1112.8010 - Order data

#### 9.6.1.3 Technical data

Order number	0TB1112.8010
<b>General information</b>	
Certifications	
CE	Yes
UL	cULus E115267 Industrial control equipment
EAC	Product family certification
<b>Terminal block</b>	
Number of pins	12
Type of terminal block	Screw clamp terminal block variant
Cable type	Only copper wires (no aluminum wires!)
Pitch	3.5 mm
Connection cross section	
AWG wire	28 - 14 AWG
Tightening torque	Max. 0.25 Nm
<b>Electrical properties</b>	
Nominal voltage	300 V
Nominal current <sup>1)</sup>	10 A

1) The respective limit data of the I/O modules must be taken into account!

## 9.7 Line filter

### 9.7.1 5AC804.MFLT-00

#### 9.7.1.1 General information

Line filter 5AC804.MFLT-00 may be necessary to meet maritime requirements regarding conducted interference emissions in power supply line per DNV.

The line filter should be installed as close to the end device as possible; the supply line from the end device to the line filter should be kept as short as possible.

#### 9.7.1.2 Order data

Order number	Short description	Figure
5AC804.MFLT-00	Line filter	

#### 9.7.1.3 Technical data

### Information:

The following specified characteristic data, features and limit values are only valid for this accessory and may differ from those of the complete system. The data specified for the complete system applies to the complete system in which this accessory is installed, for example.

Order number	5AC804.MFLT-00
<b>General information</b>	
Certifications	
CE	Yes
UKCA	Yes
UL	cULus E115267 Industrial control equipment
HazLoc	cULus HazLoc E180196 Industrial control equipment for hazardous locations Class I, Division 2, Groups ABCD, T4 <sup>1)</sup>
DNV	Temperature: <b>B</b> (0 - 55°C) Humidity: <b>B</b> (up to 100%) Vibration: <b>A</b> (0.7 g) EMC: <b>B</b> (bridge and open deck) <sup>2)</sup>
LR	ENV3
KR	Yes
ABS	Yes
BV	<b>EC31B</b> Temperature: 5 - 55°C Vibration: 0.7 g EMC: Bridge and open deck Product family certification
EAC	
<b>Terminal block</b>	
Connection cross section	
With wire end sleeves	1.5 mm <sup>2</sup>
Flexible	0.2 to 1.5 mm <sup>2</sup>
Inflexible	0.2 to 2.5 mm <sup>2</sup>
<b>Electrical properties</b>	
Nominal voltage	24 VDC (-25% / +30%), SELV <sup>3)</sup>
Nominal current	8 A
Overvoltage category per EN 61131-2	II
<b>Operating conditions</b>	
Pollution degree per EN 61131-2	Pollution degree 2
<b>Ambient conditions</b>	
Temperature	
Operation	-25 to 65°C
Storage	-25 to 65°C
Transport	-25 to 65°C
<b>Mechanical properties</b>	
Housing	
Material	Galvanized plate

Order number	5AC804.MFLT-00
Dimensions	
Width	54 mm
Length	94 mm
Depth	32.15 mm
Weight	205 g

- 1) Yes, but applies only if all components installed in the complete system have this certification and the complete system bears the corresponding mark.
- 2) Yes, but applies only if all components installed in the complete system have this certification and are listed on the associated DNV certificate for the product family.
- 3) IEC 61010-2-201 requirements must be observed.

### 9.7.1.4 Dimensions

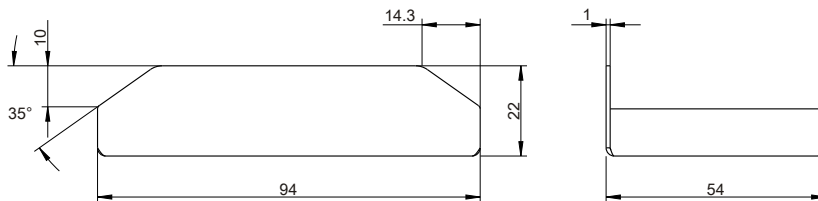

### 9.7.1.5 Drilling template

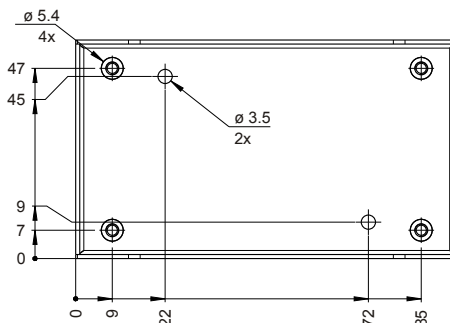

### 9.7.1.6 Connecting to the end device

The line filter must be connected between the power supply and the end device. The following figure shows a connection diagram.

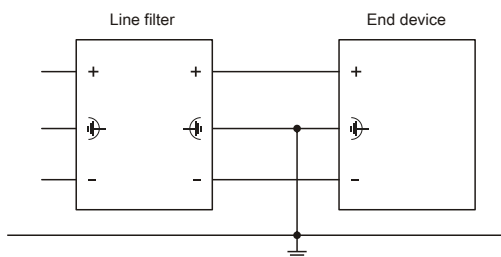

The following points must be observed:

- Use shielded, twisted wires.
- Keep the lines as short as possible (power supply - line filter - end device).
- The line filter must be installed on an uncoated, oil-free metallic surface.

## 9.8 Replacement screws

### 9.8.1 5A9000.75, 5A9000.76

#### 9.8.1.1 General information

To ensure leak tightness, new screws must be used after the hygienic panels have been removed again. Torx or slotted screws are available.

#### 9.8.1.2 Order data

Order number	Short description	Figure
	<b>Accessories</b>	
5A9000.75	cHMI housing Torx replacement screws 20 pcs.	
5A9000.76	cHMI housing slotted replacement screws 20 pcs.	

#### 9.8.1.3 Technical data

Order number	5A9000.75	5A9000.76
<b>General information</b>		
Note	20 pcs. Torx T20 replacement screws	20 pcs. slotted replacement screws
<b>Mechanical properties</b>		
Material	A2 stainless steel with integrated sealing ring	

## 9.9 Replacement gaskets

### 9.9.1 5A9000.73, 5A9000.74

#### 9.9.1.1 General information

Replacement gaskets are available as optional accessories.

#### 9.9.1.2 Order data

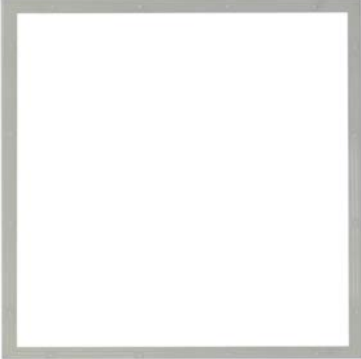
Order number	Short description	Figure
	<b>Accessories</b>	
5A9000.73	cHMI housing replacement gasket 15" For 5AP920.1505-K04, 5AP920.1505-K14, 5AP920.1505-K24, 5AP920.1505-K34, 5AP920.1505-K94, 5AP920.1505-K96, 5AP92D.1505-I00 1 pc.	
5A9000.74	cHMI housing replacement gasket 19" For 5AP920.1906-K14, 5AP920.1906-K34, 5AP92D.1906-I00 1 pc.	

#### 9.9.1.3 Technical data

Order number	5A9000.73	5A9000.74
<b>General information</b>		
Note	Replacement gasket for 15-inch hygienic panels	Replacement gasket for 19-inch hygienic panels
Certifications		
CE	Yes	
<b>Mechanical properties</b>		
Material	Silicone	

## 9.10 Replacement gaskets

### 9.10.1 5A9000.D3, 5A9000.D4, 5A9000.D5, 5A9000.D6, 5A9000.D7

#### 9.10.1.1 General information

Replacement gaskets are available as optional accessories.

#### 9.10.1.2 Order data

Order number	Short description	Figure
	<b>Accessories</b>	
5A9000.D3	cHMI replacement gasket 5AP99D.156B-B62 1 pc.	
5A9000.D4	cHMI replacement gasket 5AP93D.185B-B62 1 pc.	
5A9000.D5	cHMI replacement gasket 5AP99D.185B-B62 and 5AP99D.185C-B62 1 pc.	
5A9000.D6	cHMI replacement gasket 5AP99D.215C-B62 1 pc.	
5A9000.D7	cHMI replacement gasket 5AP93D.240C-B62 1 pc.	

#### 9.10.1.3 Technical data

Order number	5A9000.D3	5A9000.D4	5A9000.D5	5A9000.D6	5A9000.D7
<b>General information</b>					
Note	Replacement gasket for 5AP99D.156B-B62	Replacement gasket for 5AP93D.185B-B62	Replacement gasket for 5AP99D.185B-B62 and 5AP99D.185C-B62	Replacement gasket for 5AP99D.215C-B62	Replacement gasket for 5AP93D.240C-B62
Certifications					
CE	Yes				
<b>Mechanical properties</b>					
Material	Silicone				

## 9.11 Replacement parts

The following replacement parts can be ordered for the Panel PC 2100 swing arm and Panel PC 2200 swing arm:

- Mounting screws for PPC2x00
- Slot cover for interfaces
- Cover for CFast slot
- Battery compartment 5ACCRPC2.0003-000 for PPC2200  
(corresponds to the variant supplied with the configuration "5ACCBT01.0000-001" on page 100)

### 9.11.1 Replacement parts - Order data

Material number	Description
5ACCRPC2.0000-000	PPC2100/2200 mounting screws kit - 4x screw M3x34 mm - 2x special screw for PPC2100
5ACCRPC2.0001-000	xPC2100/2200 interface covers - 1x cover set
5ACCRPC2.0002-000	xPC2200 CFast cover
5ACCRPC2.0003-000	xPC2200 battery compartment - 1x battery holder for xPC2200 - 1x battery including circuit board

#### 9.11.1.1 5ACCRPC2.0003-000 - Technical data

### Information:

The following specified characteristic data, features and limit values are only valid for this accessory and may differ from those of the complete system. The data specified for the complete system applies to the complete system in which this accessory is installed, for example.

Order number	5ACCRPC2.0003-000
<b>General information</b>	
Battery	
Type	Panasonic 1000 mAh
Nominal voltage	3 V
Service life	8 years <sup>1)</sup>
Removable	No <sup>2)</sup>
Variant	Lithium
Certifications	
CE	Yes
<b>Operating conditions</b>	
Pollution degree per EN 61131-2	Pollution degree 2
<b>Ambient conditions</b>	
Temperature	
Operation	-25 to 60°C
Storage	-25 to 60°C
Transport	-25 to 60°C
Relative humidity	
Operation	5 to 90%
Storage	5 to 95%
Transport	5 to 95%
<b>Mechanical properties</b>	
Housing	
Material	Dyed gray (similar to Pantone 432C) plastic
Weight	Approx. 13 g

1) At 50°C, 6 µA for the components being supplied.

2) The battery is permanently installed in the battery compartment and cannot be replaced. The entire battery compartment must always be replaced.



# 10 Maintenance

---

The following chapter describes the maintenance work that can be carried out by a qualified and trained end user.

## **Information:**

Only components approved by B&R are permitted to be used for maintenance work.

## 10.1 Cleaning

### **Danger!**

In order to prevent unintentional operation (by touching the touch screen or keys), the device is only permitted to be cleaned when the power is switched off.

- Use a cloth moistened with dishwashing detergent, screen cleaner or alcohol (ethanol) to clean the device.
- The cleaning agent is not permitted to be applied directly to the device.  
Abrasive cleaners, aggressive solvents and chemicals, compressed air or steam cleaners are not permitted to be used.
- When cleaning, areas with adhesive labels and product information should be left out to avoid damage.

### **Information:**

Displays with a touch screen should be cleaned at regular intervals.

## 10.2 User tips for increasing the service life of the display

### 10.2.1 Backlight

The service life of the backlight is specified by its "half-brightness time". An operating time of 50,000 hours would mean that the display brightness would still be 50% after this time.

#### 10.2.1.1 Measures to maintain backlight service life

- The display brightness can be set to the lowest level that is comfortable for the user's eyes.
- Bright images should be avoided as far as possible.
- A 50% reduction in brightness can increase the half-brightness time by about 50%.

### 10.2.2 Image persistence

Image persistence refers to the "burning in" of a static image on a display after being displayed for a long time. It does not only occur with static images, however. Image persistence is also referred to in the technical literature as screen burn-in, image retention, memory effect, memory sticking or ghost image.

There are 2 different types:

- Area type: This type can be seen in a dark gray image. The effect disappears if the display is switched off for a long time.
- Line type: This can result in permanent damage.

#### 10.2.2.1 What causes image persistence?

- Static images
- No screensaver
- Sharp transitions in contrast (e.g. black/white)
- High ambient temperatures
- Operation outside of specifications

#### 10.2.2.2 How can image persistence be reduced?

- Switch continuously between static and dynamic images.
- Prevent excessive differences in brightness between foreground and background elements.
- Use colors with similar brightness.
- Use complementary colors for subsequent images.
- Use screensavers.

## 10.3 Pixel errors

### Information:

Displays can contain faulty pixels (pixel errors) due to the manufacturing process. They are not grounds for initiating a complaint or warranty claim.

## 10.4 System units

For additional information about maintaining and servicing configurations with PPC2x00 system units, see the respective system manual. These are available for download on the B&R website.

- [User's manual PPC2100](#)
- [User's manual PPC2200](#)

## 10.5 Repairs/Complaints and replacement parts

### **Danger!**

Unauthorized opening or repair of a device may result in personal injury and/or serious damage to property. Repairs are therefore only permitted to be carried out by authorized qualified personnel at the manufacturer's premises.

To process a repair/complaint, a repair order or complaint must be created via the B&R Material Return Portal on the B&R website ([www.br-automation.com](http://www.br-automation.com)).

# Appendix A

## A.A MTCX

The MTCX controller (FPGA processor) is located on the mainboard (component of every system unit) of the xPC2200:



The MTCX is responsible for the following monitoring and control functions:

- Power failure logic and power on logic (power OK sequencing)
- Handling of watchdog (handling of NMI/reset)
- Temperature monitoring and fan control
- Handling/Coordination of keys and LEDs (matrix keyboard of B&R panels)
- Advanced desktop operation (buttons, USB forwarding)
- Daisy chain display operation (touch screen, USB forwarding)
- Panel locking mechanism (configurable via the ADI Control Center)
- Backlight control of a connected B&R display
- Calculating statistical data: Power-on cycles, power-on hours and fan hours (resolution: 15 min)
- SDL data transfer (display, matrix keyboard, touch screen, service data, USB)
- LED status indicators (Power, Disk, Link, Run)
- Optimal (default) BIOS settings are reported to BIOS by the MTCX depending on the existing hardware.

The functions of the MTCX can be extended by upgrading its firmware<sup>4)</sup>. The version can be read in BIOS or in approved Microsoft Windows operating systems using the ADI Control Center.

## A.B Abbreviations

Abbreviations used in the document are explained here.

Abbreviation	Stands for	Description
NC	Normally closed	Stands for a normally closed relay contact.
	Not connected	Used in pinout descriptions if a terminal or pin is not connected on the module side.
ND	Not defined	Stands for an undefined value in technical data tables. This may be because the cable manufacturer has not provided a value for certain technical data.
NO	Normally open	Stands for a normally open relay contact.
TBD	To be defined	Used in technical data tables if there is currently no value for specific technical data. The value will be supplied later.
MTBF	Mean time between failures	The expected value of the operating time between two consecutive failures.

## A.C Viewing angles

For viewing angle specifications (R, L, U, D) of the display types, see the technical data of the individual components.

<sup>4)</sup> Can be downloaded from the Downloads section of the B&R website ([www.br-automation.com](http://www.br-automation.com)).

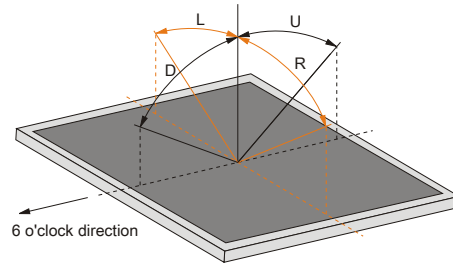

## A.4 Chemical resistance

Panels are manufactured with the Autotex panel overlay:

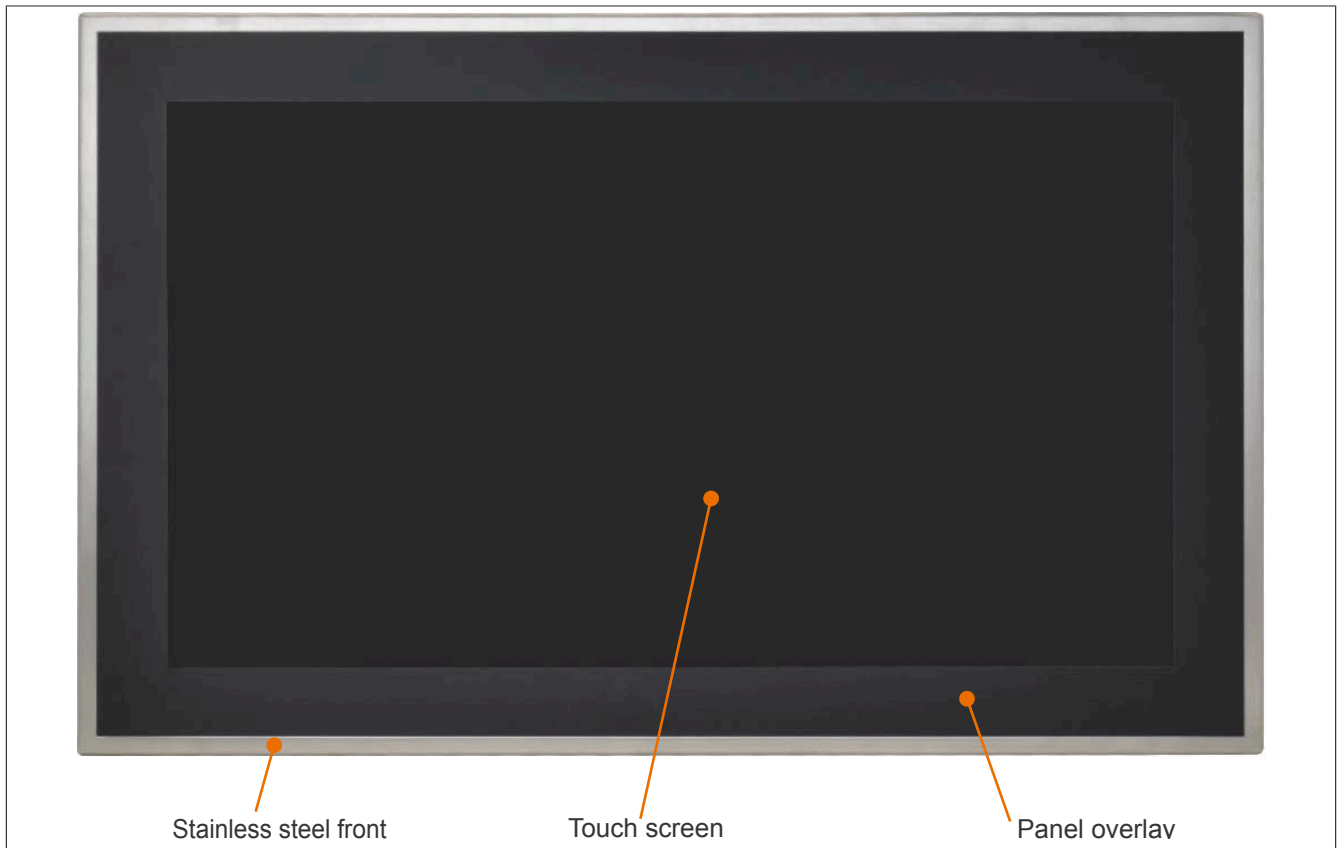

Figure 7: Stainless steel front with Autotex panel overlay

#### A.4.1 Autotex panel overlay (polyester)

Unless otherwise specified, the panel overlay is resistant to the following chemicals, materials and substances per DIN 42115 Part 2 when exposed for up to 24 hours without visible changes:

- Acetaldehyde
- Acetone
- Acetonitrile
- Aliphatic hydrocarbons
- Alkali carbonate
- Formic acid <50%
- Ammonia <40%
- Amyl acetate
- Ethanol
- Ether
- Gasoline
- Bichromate
- Potassium
- Cutting oil
- Brake fluid
- Butyl CELLOSOLVE (2-Bu-toxyethanol)
- Sodium hypochlorite <20%
- Cyclohexanol
- Cyclohexanone
- Decon
- Diacetone alcohol
- Dibutyl phthalate
- Diesel
- Diethyl ether
- Diethyl phthalate
- Dioxan
- Dowandol DRM/PM
- Iron II chloride (FeCl<sub>2</sub>)
- Iron III chloride (FeCl<sub>3</sub>)
- Acetic acid <50%
- Butyl acetate
- Ethyl acetate
- Linseed oil
- Aviation fuel
- Formaldehyde 37 to 42%
- Glycerine
- Glycol
- Isophorone
- Isopropanol
- Potassium hydroxide
- Potassium carbonate
- Methanol
- Methylisobutylketone (MIBK)
- Sodium bisulphate
- Sodium carbonate
- Caustic soda <40%
- Paraffin oil
- Phosphoric acid <30%
- Blown castor oil
- Nitric acid <10%
- Hydrochloric acid <36%
- Sea water
- Sulphuric acid <10%
- Silicon oil
- Tenside
- Turpentine oil substitute
- Toluene
- Triacetin
- Trichloroacetic acid < 50%
- Trichloroethane
- Thinner (white spirit)
- Washing agents
- Water
- Hydrogen peroxide <25%
- Fabric conditioner
- Xylene

Per DIN 42115 Part 2, the panel overlay is resistant to exposure to glacial acetic acid for less than one hour without visible damage.

## A.4.2 Touch screen

### 5-wire touch screen (single-touch)

Unless otherwise specified, the touch screen is resistant to the following chemicals, materials and substances when exposed for up to 1 hour (at 25°C) with no visible changes:

- Acetone
- Beer
- Unleaded gasoline
- Chemical cleaning agents
- Hydrogen chloride <6%
- Coca-Cola
- Diesel
- Dimethylbenzene
- Vinegar
- Ethanol
- Antifreeze
- Gear oil
- Ammonia-based glass cleaner
- Household detergents
- Hexane
- n-hexane
- Isopropanol
- Coffee
- Methylbenzene
- Methylene chloride
- Methyl ethyl ketone
- Mineral spirits
- Motor oil
- Nitric acid <70%
- Saline solution <5%
- Tea
- Turpentine
- Lubricants
- Sulphuric acid <40%
- Cooking oil

### Touch screen generation 2 and 3 (multi-touch)

Unless otherwise specified, the touch screen is resistant to the following chemicals, materials and substances per ASTM D 1308-02 and ASTM F 1598-95 when exposed for up to 24 hours without visible changes:

- Acetone
- Ammonia <5%
- Gasoline
- Beer
- Lead
- Brake fluid
- Hydrogen chloride <6%
- Coca-Cola
- Dimethylbenzene
- Ethanol
- Rubber cement
- Isopropanol
- Coffee
- Ink
- Lipstick
- Lysol
- Methylbenzene
- Methyl ethyl ketone
- Naphtha
- Nitric acid <70%
- Lubricants
- Sulphuric acid <40%
- Stamping ink
- Tea
- Trichloroethylene
- Water
- White wine vinegar
- Windex Original



## A.D Features

### A.D.1 RFID read/write transponder unit

RFID read/write transponder unit		Example image 
Vendor ID	0x1FC9	
Frequency	13.56 MHz	
Read/Write transponder unit	For I-Code SLI transponder, amplitude modulation and MIFARE Classic	
Quantity	1	
Standard	ISO 15693, MIFARE Classic	
Read/Write range in air	Approx. 1 cm	
Supply voltage	5 VDC +20% (via USB)	
Evaluation	Via USB	

Table 63: RFID read/write transponder unit

The following transponder tags can be used with this RFID transponder:

Order number	Short description
5A9010.43	Transponder tag, black housing, read/write, SLI, 1 kbit, 13.56 MHz
5A9010.44	Transponder tag, white housing, read/write, SLI, 1 kbit, 13.56 MHz
5A9010.45	Transponder tag, yellow housing, read/write, SLI, 1 kbit, 13.56 MHz
5A9010.46	Transponder tag, red housing, read/write, SLI, 1 kbit, 13.56 MHz
5A9010.47	Transponder tag, green housing, read/write, SLI, 1 kbit, 13.56 MHz
5A9010.48	Transponder tag, blue housing, read/write, SLI, 1 kbit, 13.56 MHz
5A9020.43	Transponder tag, black housing, MIFARE Classic, 1 kB, 13.56 MHz read/write
5A9020.44	Transponder tag, white housing, MIFARE Classic, 1 kB, 13.56 MHz read/write
5A9020.45	Transponder tag, yellow housing, MIFARE Classic, 1 kB, 13.56 MHz read/write
5A9020.46	Transponder tag, red housing, MIFARE Classic, 1 kB, 13.56 MHz read/write
5A9020.47	Transponder tag, green housing, MIFARE Classic, 1 kB, 13.56 MHz read/write
5A9020.48	Transponder tag, blue housing, MIFARE Classic, 1 kB, 13.56 MHz read/write

### A.D.2 Emergency stop Schlegel FRVKPOOI

Emergency stop Schlegel FRVKPOOI		
Manufacturer	Schlegel	
Type	SHORTRON	
Manufacturer number	FRVKPOOI	
Quantity	1	
Contact function	Maintained	
Resetting	By rotating right and left	
Service life	20,000 (20°C)	
Contacts	2x normally closed contact, 1x normally open contact	

Table 64: Emergency stop Schlegel FRVKPOOI

#### Information:

For additional technical data, see the manufacturer's website: [www.schlegel.biz](http://www.schlegel.biz).

## A.E Touch screen

### A.E.1 Touch screen (single-touch)

#### A.E.1.1 Technical data

##### Information:

The following specified characteristic data, features and limit values are only valid for these individual components and may differ from those of the complete system. The data specified for the complete system applies to the complete system in which this individual component is used, for example.

Order number	Touchscreen ST cHMI
<b>General information</b>	
Technology	Analog resistive
Release pressure	<1 N
Light transmission	Up to 78%
<b>Operating conditions</b>	
Activation	Finger, thin glove, pen, credit card
<b>Ambient conditions</b>	
Temperature	
Operation	-10 to 50°C
Storage	-20 to 70°C
Transport	-20 to 70°C
Relative humidity	
Operation	90% at max. 35°C; see diagram.
Storage	90% at max. 50°C for max. 240 h; see diagram.
Transport	90% at max. 50°C for max. 240 h; see diagram.

Table 65: Touchscreen ST cHMI - Technical data

#### A.E.1.2 Temperature/Humidity diagram

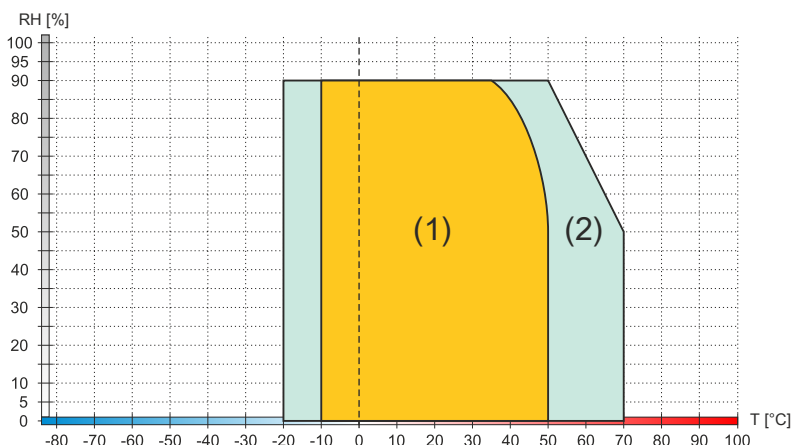

Diagram legend			
(1)	Operation	T [°C]	Temperature in °C
(2)	Storage and transport	RH [%]	Relative humidity (RH) in percent and <b>non-condensing</b>

### A.E.2 Touch screen (multi-touch generation 3)

#### A.E.2.1 Technical data

##### Information:

The following specified characteristic data, features and limit values are only valid for these individual components and may differ from those of the complete system. The data specified for the complete system applies to the complete system in which this individual component is used, for example.

Order number	Touchscreen
<b>General information</b>	
Technology	Projected capacitive touch (PCT)
Light transmission	>90%
Anti-glare coating	Optical/Gloss = 80
<b>Operating conditions</b>	
Activation	Finger, thin glove

Order number	Touchscreen
<b>Ambient conditions</b>	
Temperature	
Operation	-10 to 70°C
Storage	-40 to 70°C
Transport	-40 to 70°C
Relative humidity	
Operation	Up to 90% at max. 35°C, see diagram for > 35°C.
Storage	Up to 90% at max. 35°C, see diagram for > 35°C.
Transport	Up to 90% at max. 35°C, see diagram for > 35°C.

### A.E.2.2 Temperature/Humidity diagram

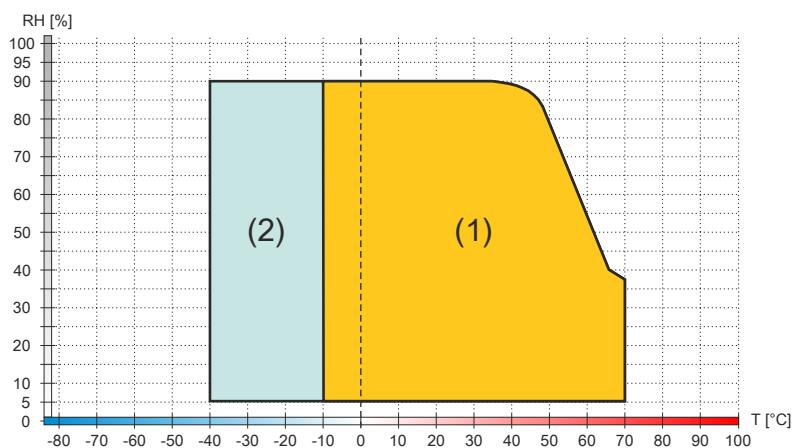

Diagram legend			
(1)	Operation	T [°C]	Temperature in °C
(2)	Storage and transport	RH [%]	Relative humidity (RH) in percent and <b>non-condensing</b>

## A.F POWERLINK

### A.F.1 LED "S/E" (status/error LED)

This LED is a green/red dual LED and indicates the state of the POWERLINK interface. The LED states have a different meaning depending on the operating mode of the POWERLINK interface.

#### A.F.1.1 Ethernet mode

In this mode, the interface is operated as an Ethernet interface.

LED "S/E"		Description
Green	Red	
On	Off	The interface is operated as an Ethernet interface.

Table: LED "S/E": Interface in Ethernet mode

### A.F.1.2 POWERLINK V2 mode

#### Error message

LED "S/E"		Description
Green	Red	
Off	On	The interface is in error mode (failed Ethernet frames, increased number of collisions on the network, etc.). Note: Several red blinking signals are displayed immediately after the device is switched on. These are not errors, however.
Blinking	On	If an error occurs in the following modes, then the green LED blinks over the red LED: <ul style="list-style-type: none"> <li>PRE_OPERATIONAL_1</li> <li>PRE_OPERATIONAL_2</li> <li>READY_TO_OPERATE</li> </ul> 

Table: LED "S/E" - Error message (interface in POWERLINK mode)

#### Interface status

LED "S/E"		Description
Green	Red	
Off	Off	<b>Mode: NOT_ACTIVE</b> The interface is either in mode NOT_ACTIVE or one of the following modes or errors is present: <ul style="list-style-type: none"> <li>The device is switched off.</li> <li>The device is in the startup phase.</li> <li>The interface or device is not configured correctly in Automation Studio.</li> <li>The interface or device is defective.</li> </ul> <b>Managing node (MN)</b> The network is monitored for POWERLINK frames. If a frame is not received within the configured time window (timeout), the interface immediately enters mode PRE_OPERATIONAL_1. If POWERLINK communication is detected before the time has elapsed, however, the MN is not started.
Flickering (approx. 10 Hz)	Off	<b>Mode: BASIC_ETHERNET</b> The interface is in mode BASIC_ETHERNET. The interface is operated in Ethernet mode.
Single flash (approx. 1 Hz)	Off	<b>Mode: PRE_OPERATIONAL_1</b> The interface is in mode PRE_OPERATIONAL_1.
	On	<b>Controlled node (CN)</b> If the red LED lights up in this mode, this means that the MN has failed.
Double flash (approx. 1 Hz)	Off	<b>Mode: PRE_OPERATIONAL_2</b> The interface is in mode PRE_OPERATIONAL_2.
	On	<b>Controlled node (CN)</b> If the red LED lights up in this mode, this means that the MN has failed.

Table: LED "S/E" - Interface state (interface in POWERLINK mode)

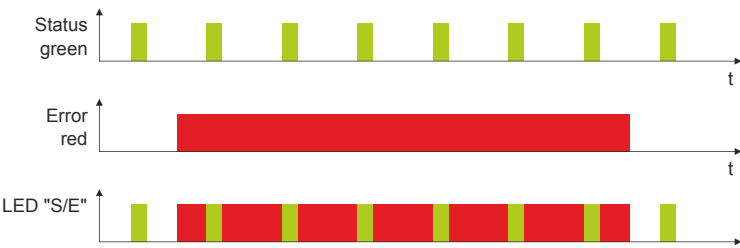
LED "S/E"		Description
Green	Red	
Triple flash (approx. 1 Hz)	Off	<b>Mode: READY_TO_OPERATE</b> The interface is in mode READY_TO_OPERATE.  <b>Managing node (MN)</b> Cyclic and asynchronous communication. Received PDO data is ignored.  <b>Controlled node (CN)</b> The configuration of the CN is completed. Normal cyclic and asynchronous communication. The transmitted PDO data corresponds to the PDO mapping. However, cyclic data is not yet evaluated.
	On	<b>Controlled node (CN)</b> If the red LED lights up in this mode, this means that the MN has failed.
On	Off	<b>Mode: OPERATIONAL</b> The interface is in mode OPERATIONAL. PDO mapping is active and cyclic data is evaluated.
Blinking (approx. 2.5 Hz)	Off	<b>Mode: STOPPED</b> The interface is in mode STOPPED.  <b>Managing node (MN)</b> This mode does not occur for the MN.  <b>Controlled node (CN)</b> Output data is not being output, and no input data is being provided. This mode can only be reached and exited by a corresponding command from the MN.

Table: LED "S/E" - Interface state (interface in POWERLINK mode)

### Blink times

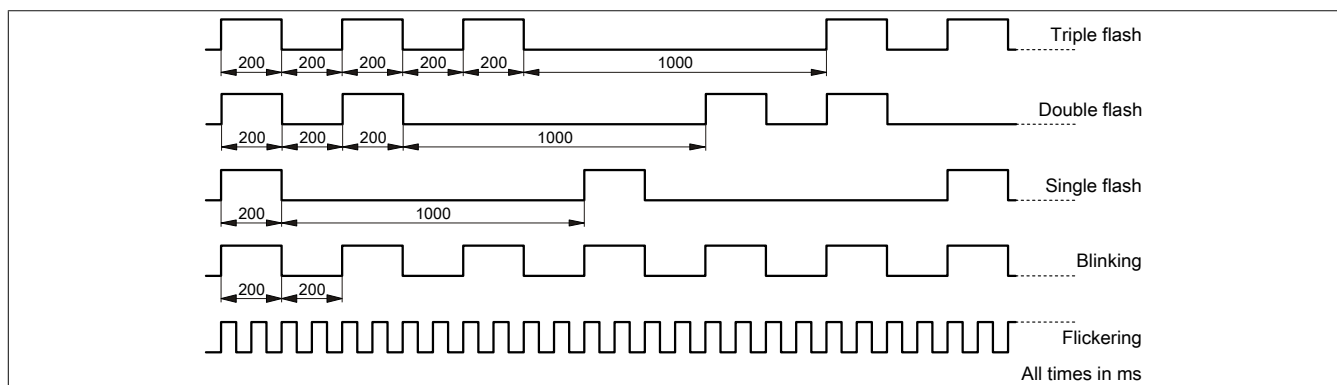

### A.F.1.3 System stop error codes

A system stop error can occur due to incorrect configuration or defective hardware.

The error code is indicated by LED "S/E" blinking red. The blinking signal of the error code consists of 4 switch-on phases with short (150 ms) or long (600 ms) duration. The error code is repeated every 2 seconds.

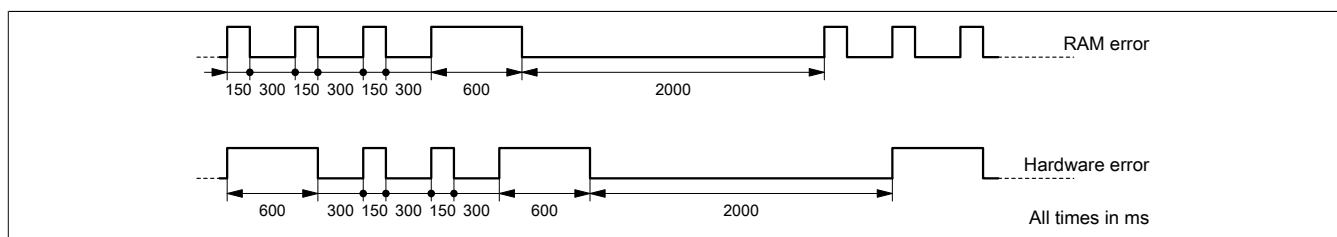

Error	Error description
RAM error	The device is defective and must be replaced.
Hardware error	The device or a system component is defective and must be replaced.

### A.F.1.4 POWERLINK V2

By default, the POWERLINK interface is operated as a managing node (MN). In the managing node, the node number is set to a fixed value of 240.

If the POWERLINK node is operated as a controlled node (CN), a node number from 1 to 239 can be set in the POWERLINK configuration in Automation Studio.

## 12 Environmentally friendly disposal

---

All programmable logic controllers, operating and monitoring devices and uninterruptible power supplies from B&R are designed to have as little impact on the environment as possible.

### 12.1 Separation of materials

To ensure that devices can be recycled in an environmentally friendly manner, it is necessary to separate out the different materials.

Component	Disposal
Programmable logic controllers Operating and monitoring devices Uninterruptible power supplies Batteries and rechargeable batteries Cables	Electronics recycling
Paper/Cardboard packaging	Paper/Cardboard recycling
Plastic packaging material	Plastic recycling

Disposal must be carried out in accordance with applicable legal regulations.