

MT8070iH

Human Machine Interface
with 7" TFT LCD display



【Introduction】

MT8000 series is the new HMI generation of Weintek. With the design concept of meeting customers' satisfaction while easy-to-Use attribute as before, a MT8000 not only performs as a Human Machine Interface but also plays as a role of data exchange center. Through the most popular Ethernet connection, data can be shared among MT8000s without limitation and any SCADA/HMI software on the PC can simply access data from MT8000s. MT8000 series is the best choice for your requirement tomorrow.

The MT8070iH is equipped with a USB 1.1 host, a USB 2.0 high speed device and SD card slot.

◆ Specifications

- **Construction:** plastic molding housing
- **Display:** 7" 65,536 color TFT LCD
- **CPU and core logic:** 32Bit RISC 400MHz processor
- **DRAM:** 64 MB DDR2 on board
- **Storage:** 128 MB flash memory on board,
- **I/O:** 3 serial ports: Com1: RS-232/RS-485 2w/4w,
Com2: RS-232,
Com3: RS-232/RS-485 2w
1 Ethernet port (10/100Base-T)
1 USB 1.1 host
1 USB 2.0 high speed device
- **Sound output:** Line out
- **RTC:** Built-in
- **Power input:** 24±20%V_{DC}, 250mA @ 24VDC
- **Dimension (W x H x D):** 200 x 146 x 42.5mm
- **Weight:** 0.85kg
- **Software:** EB8000 V2.0.0 or later

◆ Features

- 7" 800x480 TFT LCD
- Fan-less cooling system
- Built-in flash memory and RTC
- NEMA4/IP65 compliant front panel
- LED Back Light
- One USB Host and one USB client port
- SD card slot
- Power Isolator inside

◆ LCD Display

Display type	TFT LCD
Display size (diagonal)	7"
Max colors	65536
Resolution	800 x 480
Pixel pitch (HxV, mm)	0.1905 x 0.0635
Viewing angle (°)	70/50/70/70(T/B/R/L)
Luminance (cd/m ²)	300
Backlight	LED
Backlight Life time	30,000 hrs.
Contrast ratio	500:1

◆ Touchscreen

- **Type:** 4-wire, analog resistive
- **Resolution:** continuous
- **Light transmission:** above 80%
- **Life:** 1 million activation minimum

◆ Environmental Specifications

- **Operating temperature:** 0° ~ 45°C (32° ~ 113°F)
- **Storage temperature:** -20° ~ 60°C (-4° ~ 140°F)
- **Relative humidity:** 10% ~ 90% @ 40°C, non-condensing
- **Shock (operation):** 10 to 25Hz(X,Y,Z direction 2G 30minutes)
- **CE/FCC :** Complies with EN 55022:2006, Class A
EN 61000-3-2:2006
EN 61000-3-3:1995+A1:2001+A2:2005
- **Front panel meets NEMA4 / IP65**

◆ Dimensions Drawing

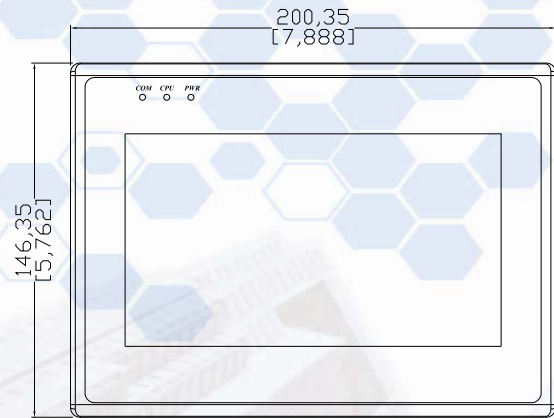

Front View

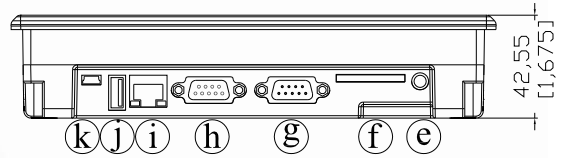

Bottom View

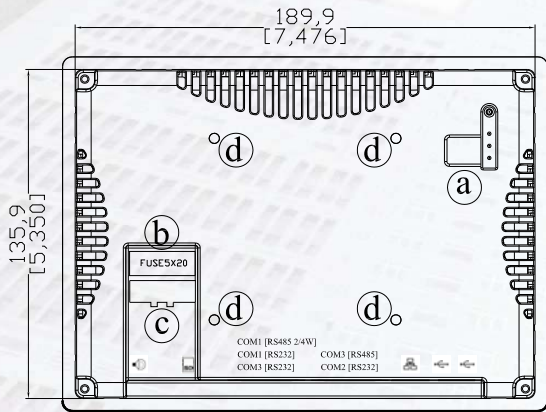

Rear View

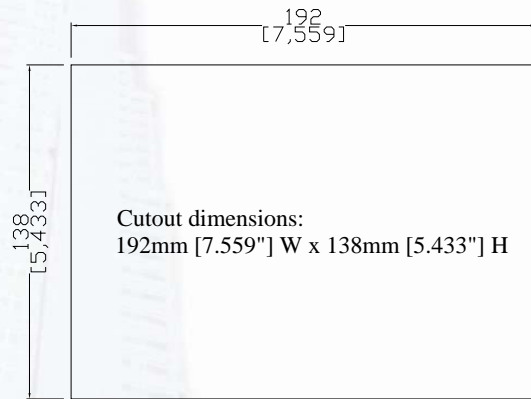

a	DIP SW & Reset button	e	Audio
b	Fuse	f	SD card slot
c	Power connector	g	Com1 RS485, Com3 RS485, Com3 RS232
d	VESA 75mm screw holes	h	Com1 RS232, Com2 RS232
		i	Ethernet port (RJ-45)
		j	USB Host port
		k	USB Client port

Ordering Information

- ❑ **MT8070iH:**
7" 800x480 TFT LCD HMI, 128MB flash memory/64MB DDR2 RAM on board.
- ❑ **RZCMT6100:**
MT6000/8000 i series download cable / Mini USB to USB 2.0 100 cm
- ❑ **RP0080700:**
7" Protective Sheet, for MT607, 6070, 8070