

*User Guide*

# **Interbus**

Option Module  
For Unidrive

Part Number: 0460-0076  
Issue Number: 4



## SAFETY INFORMATION

---

Persons supervising and performing the electrical installation or maintenance of a Drive and/or an external Option Unit must be suitably qualified and competent in these duties. They should be given the opportunity to study and if necessary to discuss this User Guide before work is started.

The voltages present in the Drive and external Option Units are capable of inflicting a severe electric shock and may be lethal. The Stop function of the Drive does not remove dangerous voltages from the terminals of the Drive and external Option Unit. Mains supplies should be removed before any servicing work is performed.

The installation instructions should be adhered to. Any questions or doubt should be referred to the supplier of the equipment. It is the responsibility of the owner or user to ensure that the installation of the Drive and external Option Unit, and the way in which they are operated and maintained complies with the requirements of the Health and Safety at Work Act in the United Kingdom and applicable legislation and regulations and codes of practice in the UK or elsewhere.

The Drive software may incorporate an optional Auto-start facility. In order to prevent the risk of injury to personnel working on or near the motor or its driven equipment and to prevent potential damage to equipment, users and operators, all necessary precautions must be taken if operating the Drive in this mode.

The Stop and Start inputs of the Drive should not be relied upon to ensure safety of personnel. If a safety hazard could exist from unexpected starting of the Drive, an interlock should be installed to prevent the motor being inadvertently started.

## GENERAL INFORMATION

---

The manufacturer accepts no liability for any consequences resulting from inappropriate, negligent or incorrect installation or adjustment of the optional operating parameters of the equipment or from mismatching the Drive with the motor.

The contents of this User Guide are believed to be correct at the time of printing. In the interests of a commitment to a policy of continuous development and improvement, the manufacturer reserves the right to change the specification of the product or its performance, or the contents of the User Guide, without notice.

All rights reserved. No part of this User Guide may be reproduced or transmitted in any form or by any means, electrical or mechanical including photocopying, recording or by any information storage or retrieval system, without permission in writing from the publisher.

<b>Copyright</b>	© January 2001 Control Techniques SSPD
<b>Author</b>	Paul Bennett
<b>Issue Code</b>	Issue 4
<b>System File</b>	
<b>Hardware (UDxx)</b>	
<b>Firmware (UDxx)</b>	

---

# Contents

---

<b>1</b>	<b>Introduction</b>	<b>5</b>
1.1	Interbus Interface for Unidrive	5
1.2	Product Conformance Certification	5
1.3	Overview Specification	5
<b>2</b>	<b>Mechanical Installation</b>	<b>6</b>
2.1	Unidrive	6
<b>3</b>	<b>Electrical Installation</b>	<b>7</b>
3.1	Interbus Connectors	7
3.2	Interbus Connections	8
3.3	Interbus Cable	8
3.4	Interbus Cable Screen Connections	9
3.5	Interbus Network Termination	9
3.6	Maximum Network Length	9
<b>4</b>	<b>Getting Started</b>	<b>10</b>
4.1	Basic Communications Quick Start	10
4.2	Interbus Node Address	10
4.3	Interbus Data Rate	10
4.4	Data Format	11
4.5	Network Status	11
4.6	Network Loss Trip	11
4.7	Initialising Set-up Changes	12
<b>5</b>	<b>Cyclic Data</b>	<b>13</b>
5.1	What is Cyclic Data?	13
5.2	Interbus Data Format	13
5.2.1	PCP V2.0 Non-Cyclic Data with 3 Cyclic Words	13
5.3	Internal 32-Bit Parameters on UD70	14
5.4	Storing Parameters	15
5.4.1	Saving Unidrive Parameters (Menu 1 to 19)	15
5.4.2	Saving UD70 Parameters (Menu 20 and Internal)	15
5.5	Mapping Conflicts	16
5.5.1	Control Word Mapping Conflicts	16
5.6	Fieldbus Control Word for Unidrive	17
5.7	Fieldbus Status Word for Unidrive	19
5.8	Disabling Cyclic Data Channels	20
<b>6</b>	<b>Non Cyclic Data</b>	<b>21</b>
6.1	PCP V2.0	22
6.1.1	WRITE Object	22
6.1.2	READ Object	22
6.1.3	STATUS Object	23
6.1.4	Reading parameters using PCP	24
6.1.5	Writing parameters using PCP	25

6.2	Interbus Set-up using Non-Cyclic Data	26
<b>7</b>	<b>Interbus CMD Tool Support Files</b>	<b>27</b>
7.1	Interbus CMD Tool	27
7.2	Interbus Data Formats	27
<b>8</b>	<b>Diagnostics</b>	<b>28</b>
8.1	Fieldbus Code	28
8.2	Firmware Version	28
8.3	System File	29
8.4	Node Address	29
8.5	Network Data Rate	29
8.6	Network Status	29
8.7	Diagnostic LEDs	30
8.8	No Data Transfer	30
8.9	Unidrive Trip Codes	31
<b>9</b>	<b>Advanced Features</b>	<b>32</b>
9.1	Network Loss Trip	32
9.2	Unidrive Sequencing Mode 3	33
9.3	Drive Reset Using The Interbus Network	34
9.3.1	Reset Without DPL Code	34
9.3.2	Reset Using PCP Communications	35
9.3.3	Reset Using DPL Code	35
9.4	Non-Cyclic Parameter Store	35
9.5	EVENT Task Trigger on UD70	36
<b>10</b>	<b>Quick Reference</b>	<b>37</b>
10.1	Complete Parameter Reference	37
10.2	Interbus Data Formats	37
10.3	Fieldbus Control Word	38
10.4	Fieldbus Status Word	39
10.5	Unidrive Trip Codes	40

---

# 1 Introduction

---

## **NOTE**

*Unidrive parameters are denoted in this manual by “#MM.PP”, where MM refers to the menu number, and PP refers to the parameter number within that menu. Please refer to the Unidrive manual for a full list of parameter definitions.*

### 1.1 Interbus Interface for Unidrive

The Unidrive Interbus interface is supplied as an option module, with the Interbus using a UD70 as the host. The UD70 does not lose any functionality when the Interbus interface is fitted. The data rate for Interbus networks is currently fixed at 500 Kbits/sec.

The Unidrive supplies all power requirements for the Unidrive Interbus interface. There is no provision for a back-up +24V power supply.

### 1.2 Product Conformance Certification

The Unidrive Interbus interface (with V3.00.00 firmware) was submitted to the Interbus Club for conformance testing. All tests were successful, and the Interbus Club awarded full Interbus Conformance Certification. (Certificate No. 197)

## **NOTE**

*Unidrive Interbus interfaces fitted with V2.03.00 firmware or earlier do NOT have Product Conformance Certification.*

### 1.3 Overview Specification

- Three 16 bit input/output words, all can be mapped to or from Unidrive parameters
- Three 16 bit input/output words
- PCP V2.0 non-cyclic communications supported

---

## 2 Mechanical Installation

---



**Warning**

*The Unidrive must be disconnected from the mains supply before installing or removing an option module.*

### 2.1 Unidrive

1. Slide the option module into the Unidrive.



2. Push the option module into the Unidrive until it clicks into place.



---

## 3 Electrical Installation

---

### 3.1 Interbus Connectors

The Unidrive Interbus Interface has two 9-way D-type connectors to connect to the Interbus network. Connector A is the Remote Bus IN plug and connector B is the Remote Bus OUT socket. Connectors C and D are RS232 Programming Port(C) and the general-purpose RS485 Port (D) of the UD70.

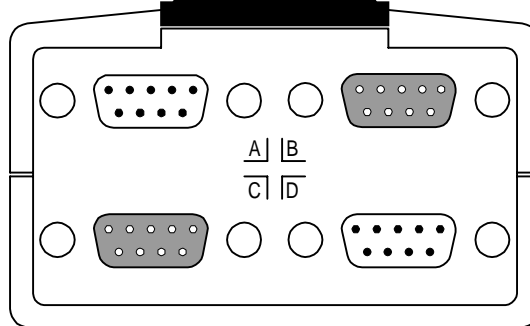

The pin connections for the Interbus Remote Bus IN and OUT connectors are given in the table below. 0V ISO is completely isolated from 0V COM.

Terminal	Function	Description
A6	/DO1	Negative Data IN line, connect to /DO2
A1	DO1	Positive Data IN line, connect to DO2
A7	/DI1	Negative Data OUT line, connect to /DI2
A2	DI1	Positive Data OUT line, connect to DI2
A3	0V ISO	0V Isolated
A Shell	Screen	Remote Bus IN cable screen connection
B6	/DO2	Negative Data OUT line, connect to /DO1
B1	DO2	Positive Data OUT line, connect to DO1
B7	/DI2	Negative Data IN line, connect to /DI1
B2	DI2	Positive Data IN line, connect to DI1
B3	0V COM	0V Common, internally linked to Drive 0V
B5	RBST	Remote Bus OUT Enable
B9	+5V	+5V Comms
B Shell	Screen	Remote Bus OUT cable screen connection

### 3.2 Interbus Connections

To connect a node to the Interbus network, make the connections as shown in the diagram below. Note that the screen should be connected to the shell of the D-type connector.

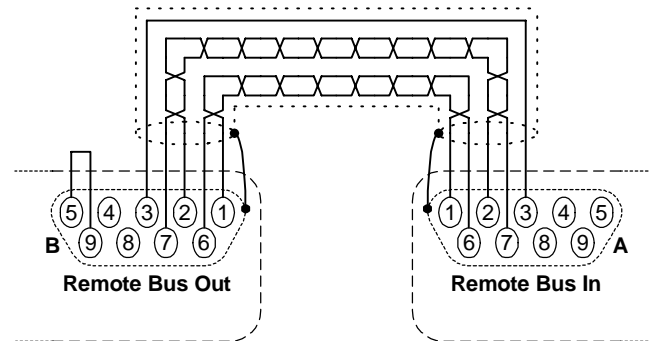

**NOTE**

*The Remote Bus OUT Enable (terminal 5) must be linked to +5V (terminal 9) if the Remote Bus OUT terminals are connected to another node on the network.*

### 3.3 Interbus Cable

Interbus cable has three twisted pairs plus overall screening. The colours normally used on Interbus networks are shown below.

Cable	Data Signal	D-type	Description
Green	/DO1, /DO2	6	Negative data OUT line
Yellow	DO1, DO2	1	Positive data OUT line
Pink	/DI1, /DI2	7	Negative data IN line
Grey	DI1, DI2	2	Positive data IN line
Brown	0V	3	0V Common
	RBST, +5V	5, 9	Remote Bus OUT Enable
Shield	Screen	Shell	Cable screen

Interbus networks run at a high data rate, and require cable specifically designed to carry the high frequency signals. Low quality cable will attenuate the signals, and may render the signal unreadable for the other nodes on the network. A list of approved manufacturers of Interbus equipment is available at "www.interbus.com".

**NOTE**

*Control Techniques can only guarantee correct and reliable operation of its Interbus interfaces if the network cable installed has been fully approved by the Interbus Club.*



### 3.4 Interbus Cable Screen Connections

The end of the Remote Bus IN and OUT cable screens should be formed into "pigtailed" and connected to the shell of the respective D-type connectors. The screens of the Remote Bus IN and OUT cables should NOT be linked together.

### 3.5 Interbus Network Termination

External termination resistors are not required on Interbus networks, as each section of cable is automatically terminated on every Interbus node. The connections required for the last node on the network are shown below.

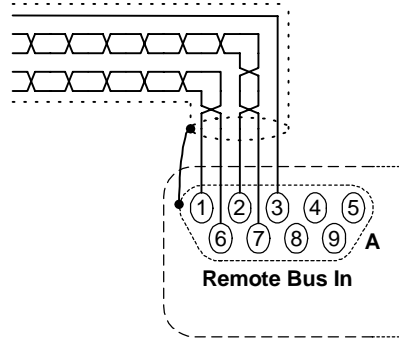

### 3.6 Maximum Network Length

The maximum physical length of cable for each network segment is 1200m, so the maximum total length of the Interbus depends on the number of nodes connected to the network.

Each Unidrive transmits and receives 4 data words (64 bits) over the network. The network data width is 4096 bits, giving a theoretical maximum of 64 Unidrive nodes on a single network. However, Interbus master controllers can only handle 62 nodes with PCP communications on a single network, so this limits the maximum number of Unidrive nodes to 62. Other non-PCP nodes can be added to the network to use the remaining 128 bits of data.

---

## 4 Getting Started

---

The Quick Start section shows the basic parameter configurations required for the Interbus interfaces to establish communications. Cyclic and non-cyclic data explanations are given in chapters 5 and 6.

### **NOTE**

*Parameters #20.01 to #20.20 and #20.50 are reserved for configuring the Profibus-DP interface, and should not be used in DPL programs.*

### 4.1 Basic Communications Quick Start

The Unidrive Interbus interface will operate simply by connecting it to the Unidrive, and powering up the Drive. It will read the configuration parameters from the Unidrive, and configure itself accordingly. The data format is automatically detected when the master controller initialises the network.

The Unidrive Interbus interface is configured using menu 20 parameters. The parameters listed in the table below should be configured on each node BEFORE connecting the node to the Interbus network.

Function	Unidrive	Recommended Setting
Node Address	Auto	The node address is determined by the physical location of the node
Network Data Rate	Fixed	The data rate is fixed at 500 Kbits/sec for Interbus network
Network Loss Trip	#20.11	48

### 4.2 Interbus Node Address

The node address is assigned automatically by the Interbus master controller during network initialisation. The address assigned depends entirely on the physical position of the node on the Interbus network ring.

### 4.3 Interbus Data Rate

The data rate is fixed at 500Kbits/sec for Interbus networks.

## 4.4 Data Format

The data format is 3 cyclic words with PCP (V2.0) non-cyclic communications. The Interbus ID Code for this data format is 0xF3 (243), with a Process Data Channel of 48 bits.

Each cyclic data word is mapped to a Unidrive parameter with default mappings as shown in the table below.

Cyclic Channel	Default Mapping Status
IN Word 0	Non-cyclic data word
IN Word 1	Status word
IN Word 2	Post-ramp speed reference
IN Word 3	Motor active current
OUT Word 0	Non-cyclic data word
OUT Word 1	Control word
OUT Word 2	Digital speed reference 1
OUT Word 3	Torque reference

## 4.5 Network Status

Unidrive: #20.50

The status of the Interbus network is displayed in #20.50, and can be viewed on the display on the Unidrive.

#20.50	Status	Description
>0	Network healthy	Indicates the number of network cycles per second, and the slave is exchanging data with the master controller.
0	Network is not running	Indicates that the network is not currently running.

## 4.6 Network Loss Trip

Unidrive: #17.14

If the Interbus network stops operating, the interface will trip the Unidrive on "tr60". The default time delay between network loss and Unidrive trip is 48ms, so the actual delay to trip will be between 48ms and 96ms. (See section 9.1 for more details.) The master controller will automatically detect that the slave node has gone missing from the network, and will update relevant status registers.

### NOTE

**Changes to #17.PP parameters in the Unidrive do not take effect until the UD70 has been reset. See sections 4.7 and 5.4.2.**

## 4.7 Initialising Set-up Changes

UD70 (#17.PP) and Interbus (#20.PP) configuration parameters are only read during the initialisation sequence of the UD70. This prevents corruption of the configuration while parameters are being edited. When parameters have been configured, the UD70 must be reset to implement any changes made to the configuration parameters.

To reset from the UD70, set #MM.00 to 1070, and press the red RESET button on the Unidrive. Any changes made to the Interbus configuration will now take effect.

### **NOTE**

*Resetting the UD70 does not store the #20.PP configuration parameters, so these changes will be lost when the Unidrive is powered down. See section 5.4.2 for details on storing Unidrive and UD70 parameters.*

---

## 5 Cyclic Data

---

### NOTE

*“OUT data” and “IN data” describe the direction of data transfer as seen by the PLC scanner.*

### 5.1 What is Cyclic Data?

Cyclic data is a method data transfer that must be set-up during network configuration, but is transmitted automatically once configuration is complete. The high-speed data transfer is achieved by transmitting only a 16-bit data value for each cyclic channel over the Interbus network, and relying on local mapping information within the Unidrive to ensure the correct data is sent to the correct locations. This method relies on the PLC program writing and reading data values to and from the registers allocated to the node during network configuration, and the source and destination of IN and OUT data being set-up correctly in the Unidrive itself.

The flexibility of the Unidrive Interbus interface means that each cyclic data OUT channel can be directed to any read-write Unidrive parameter. Similarly, each cyclic data IN channel can use any Unidrive parameter as a source of data.

### NOTE

*The mapping configuration cannot be changed dynamically, as the UD70 must be reset before changes to the mapping become active.*

### 5.2 Interbus Data Format

The default data format for the Unidrive Interbus interface is 3 cyclic data words, plus Mode 1 (PCP V2.0) non-cyclic communications.

Non-cyclic data mode	Cyclic words	Interbus ID Code	Process Data Channel	CMD Tool Ref
PCP V2.0	3	0xF3 (243)	48 bits	F_103

#### 5.2.1 PCP V2.0 Non-Cyclic Data with 3 Cyclic Words

The mapping for the cyclic data channels on the Unidrive Interbus interface can be set from the Unidrive keypad using #20.PP parameters.

The mapping method is similar to the method used for mapping analogue inputs and outputs. The value entered in the mapping parameter takes the form MMPP, where MM = menu number of the target parameter and PP = parameter number of the target parameter.

### NOTE

*#20.01 to #20.20, and #20.50, are all reserved for Interbus set-up and configuration, and should not be used in DPL programs.*

The default mapping values are shown in the table below.

Data Word	Mapping Parameter	Default Mapping Status
IN Word 1	#20.07	#90.11, status word
IN Word 2	#20.03	#2.01, post-ramp speed reference
IN Word 3	#20.04	#4.20, motor load as % of rated motor load
OUT Word 1	#20.06	#90.11, control word
OUT Word 2	#20.01	#1.21, digital speed reference 1
OUT Word 3	#20.02	#4.08, torque reference

**NOTE**

*If a mapping parameter is set to an invalid value, e.g. destination parameter is read only, or parameter does not exist, the Unidrive will reset the mapping parameter (#20.PP) to its default value.*

If a cyclic channel is not required, setting the mapping value to -1 will disable it. The data word will still be transmitted over the network, but the data value will not be written to any Unidrive parameter.

**NOTE**

*The cyclic data channels do not use decimal points. For example, the digital speed reference 1 (#1.21) has units of Hertz, accurate to 1 decimal place. To write a value of 24.6Hz to #1.21, the value must be transmitted as 246.*

### 5.3 Internal 32-Bit Parameters on UD70

The Unidrive Interbus Interface has a set of internal 32-bit registers. These are addressed as \_Pxx%, \_Qxx%, \_Rxx% or \_Sxx% from the DPL program, and the \_Qxx% registers are used with the internal position controller in the UD70.

A 32-bit cyclic channel can be created for IN data, OUT data or both, by combining cyclic channels 2 and 3. This allows full 32-bit values to be directly transferred between the UD70 and the controlling PC or PLC. (See the "User's Guide" for the UD70 for more information.)

The 32-bit cyclic channel is configured by mapping IN or OUT cyclic data channel 2 (#20.01 or #20.03) to a 32 bit register, and setting the mapping for IN or OUT cyclic data channel 3 (#20.02 or #20.04) to -2. Channel 3 will contain the data high word (upper 16 bits of the 32-bit register) and channel 2 contains the data low word (lower 16 bits of the 32-bit register.)

The 32-bit registers can also be addressed as parameters as listed in the table below. To map a cyclic channel to one of these registers, the appropriate parameter reference must be entered in the mapping parameter.

Registers	Parameter Reference
_P00% - _P99%	#70.00 to #70.99
_Q00% - _Q99%	#71.00 to #71.99
_R00% - _R99%	#72.00 to #72.99
_S00% - _S99%	#73.00 to #73.99

**NOTE**

*If the mapping for both cyclic channel 2 and cyclic channel 3 are directed to 32 bit registers, only the low 16 bits of each register will be written to or read from.*

## 5.4 Storing Parameters

Although any changes to the mapping will take effect after a UD70 reset sequence, the new values must be stored in non-volatile memory if they are to be restored automatically when the Interface is next powered up.

### 5.4.1 Saving Unidrive Parameters (Menu 1 to 19)

To initiate the Unidrive parameter save sequence, set #MM.00 to 1000 and press the red RESET button on the keypad.

All parameters in these menus are saved in the EEPROM in the Unidrive. If the Unidrive Interbus interface is replaced, the Unidrive will retain all values in menu 1 through menu 19 when the Unidrive is next powered up.

### 5.4.2 Saving UD70 Parameters (Menu 20 and Internal)

To initiate the non-volatile save sequence for these parameters, set #17.19 to 1. The UD70 will then store menu 20 and the internal 32-bit parameters, clear #17.19 back to zero and completely reset itself.

All menu 20 parameters and internal 32-bit parameters (\_Pxx% and \_Qxx%) are stored in the FLASH memory of the UD70. If the Unidrive Interbus interface is replaced, the menu 20 parameters may need to be re-configured. If the replacement module has been used before, the stored values may be different from the normal default settings.

The UD70 can also be configured to store these parameters automatically when the Unidrive powers down. The store routine is triggered when an under-voltage (UU) trip occurs. Set #17.20 to 1, store the Unidrive parameters and reset the UD70 to enable this feature.

## 5.5 Mapping Conflicts

When the mapping parameters for the Interbus cyclic channels are set, care must be taken to ensure that there are no clashes with the mapping of the analogue and digital inputs within the Unidrive. The Unidrive Interbus interface will not indicate any conflict of mapping parameters. This only applies to analogue and digital inputs, and OUT data on the Interbus network.

If a numerical parameter is written to from two different sources, the value of this parameter will depend entirely upon the scan times for the analogue or digital input and the Interbus network. Further confusion may be caused due to the update rate of the display. A parameter may appear to be steady at a particular value, but occasionally, a glitch in the value will be seen. In reality, this value may be changing continuously, leading to erratic behaviour.

Function	Mapping Parameter	Function	Mapping Parameter
Analogue I/P 1	#7.10	Logic O/P 2	#9.20
Analogue I/P 2	#7.14	Motorised Pot O/P	#9.25
Analogue I/P 3	#7.18	Binary Summer	#9.33
Digital I/P 1	#8.10	Comparator 1 O/P	#12.07
Digital I/P 2	#8.13	Comparator 2 O/P	#12.17
Digital I/P 3	#8.16	Reference Input	#13.06
Digital I/P 4	#8.19	PID O/P	#14.16
Digital I/P 5	#8.21	Cyclic OUT Word 1	#20.06
Digital I/P 6	#8.23	Cyclic OUT Word 2	#20.01
Logic O/P 1	#9.10	Cyclic OUT Word 3	#20.02

Ensure that each Unidrive parameter in the table above has a different value programmed. A value of 0 will disable analogue and digital inputs, and -1 will disable the cyclic data channels.

### 5.5.1 Control Word Mapping Conflicts

The control word provides a method of writing to multiple bit parameters using one data word. If one of the cyclic data channels is writing to the control word, the following bit parameters for each Unidrive must not be controlled by any digital inputs.

Function	Param	Function	Param
Enable	#6.15	Preset ref select bit 1	#1.46
Run Forwards	#6.30	Application bit	#18.31
Jog	#6.31	Application bit	#18.32
Run Reverse	#6.32	Application bit	#18.33
Preset ref select bit 0	#1.45		



## 5.6 Fieldbus Control Word for Unidrive

### NOTE

*This section assumes that the Unidrive is configured to use the default Wire Proof PLC sequencing mode (#6.04 = 4). If PLC mode is selected (#6.04 = 3), the control word mapping is slightly different. Refer to section 9.2 for details.*

The Control Word is an efficient way of remotely controlling the motion of a Unidrive. Each bit in the control word has a particular function, and provides a method of controlling the function of the Unidrive (RUN, JOG, etc.) with a single data word. The control word is addressed in the UD70 by writing to #90.11.

b15	b14	b13	B12	b11	b10	b9	b8
M6	M5	#18.33	M3	M2	M1	M0	#18.32

b7	b6	b5	b4	b3	b2	b1	b0
#18.31	#1.46	#1.45	TRIP	RUN REV	JOG	RUN FWD	ENABLE

The bits shown as "Mx" are individual mask bits that allow the corresponding "bx" to be masked, i.e. the MASK bits determine whether or not the data bit is written through to the corresponding parameter.

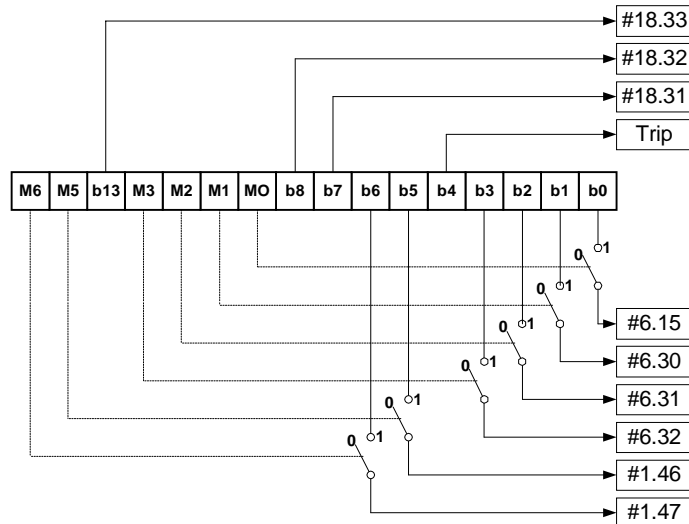

If mask bits M0 and M1 are set to 1, ENABLE and RUN FWD are updated with the values of b0 and b1 (either 0 or 1) every time the control word value is received. JOG and RUN REV will not be updated, even if the values of b2 and b3 change, because their mask bits (M2 and M3) are not set to 1. If M0 and M1 are reset to 0, the values in b0

and b1 will NOT be written to ENABLE and RUN FWD, and these parameters will remain set to their current state.

The TRIP bit (b4) will cause a "tr52" trip when set to 1, but the trip cannot be cleared until the TRIP bit (b4) has been reset to 0. Parameters #18.31 to #18.33 are general user parameters and do not have mask bits.

Bit	Function	Description
0	ENABLE	Set to 1 to put the Unidrive in READY mode. (The hardware ENABLE must also be present.) The RUN FWD, JOG and RUN REV bits will have no effect unless the ENABLE bit is set to 1. The Unidrive outputs are disabled immediately when the ENABLE bit is reset to 0, and the motor will coast to stop
1	RUN FWD	Set to 1 to run the motor in the forwards direction. Reset to 0 to decelerate the motor to a controlled stop before the Unidrive output stage is disabled
2	JOG	Set to 1 with RUN FWD or RUN REV bit also set to jog the motor in the appropriate direction. The Unidrive will ramp the motor to the normal speed or stop when the JOG bit is reset to 0, depending on the status of the RUN FWD and RUN REV bits.
3	RUN REV	Set to 1 to run the motor in the reverse direction. When reset to 0, the Unidrive will decelerate the motor to stop before the outputs are disabled
4	TRIP	Set to 1 to trip the Unidrive on "tr52". The TRIP bit must be reset to 0 before the Unidrive can be reset.
5	#1.45	Preset Reference Select. These bits are used to select the digital speed references used. Refer to the Unidrive User Guide for more information.
6	#1.46	
7	#18.31	User application bit
8	#18.32	User application bit
9	M0	ENABLE mask bit
10	M1	RUN FWD mask bit
11	M2	JOG mask bit
12	M3	RUN REV mask bit
13	#18.33	User application bit
14	M5	Mask bits for the Preset Reference Select bits
15	M6	

Some example control words for Wire-Proof PLC mode are given in the table below.

b15-b12	b11-b8	b7-b4	b3-b0	Value	Action
0000	0010	0000	0000	0x0200	Drive disable
0001	1110	0000	0001	0x1E01	Enabled + stopped
0001	1110	0000	0011	0x1E03	Enabled + run fwd
0001	1110	0000	1001	0x1E09	Enabled + run rev
0001	1110	0000	1101	0x1E0C	Enabled + jog rev

## 5.7 Fieldbus Status Word for Unidrive

The status word is an efficient way of remotely monitoring and diagnosing the status of the Unidrive. Each bit in the status word indicates the status of a function of the Unidrive, e.g. At Speed, Drive Healthy, etc. The status word is addressed in the UD70 by writing to #90.11.

b15	b14	b13	b12	b11	b10	b9	b8
X	#10.15	#10.14	#10.13	#10.12	#10.11	#10.10	#10.09

b7	b6	b5	b4	b3	b2	b1	b0
#10.08	#10.07	#10.06	#10.05	#10.04	#10.03	#10.02	#10.01

The table below shows the particular status of the Unidrive indicated by each bit when set to 1.

Bit	Parameter	Description
0	#10.01	Drive healthy
1	#10.02	Drive running
2	#10.03	Zero speed
3	#10.04	Running at or below min speed
4	#10.05	Below set speed
5	#10.06	At speed
6	#10.07	Above set speed
7	#10.08	Load reached
8	#10.09	In current limit
9	#10.10	Regenerating
10	#10.11	Dynamic brake active
11	#10.12	Dynamic brake alarm
12	#10.13	Direction commanded
13	#10.14	Direction running
14	#10.15	Mains Loss
15		Not used

## 5.8 Disabling Cyclic Data Channels

Set the appropriate channel mapping parameter to -1, and reset the Unidrive Interbus Interface.

If an application only requires 2 cyclic data channels, the remaining channel can be disabled. This means that the data received from that channel will not be written to any Unidrive parameter. It does not actually remove the channel from the Interbus network.

---

## 6 Non Cyclic Data

---

The non-cyclic data channel provides a method for the master controller to read from or write to any parameter within the Drive. This channel can be used for single infrequent data transfers, or uploading and downloading parameter sets to or from a particular node.

Non-cyclic data access to Unidrive parameters via the PCP channel must be configured in both the Interbus network controller, and the main PLC or PC program. Macros can be defined and downloaded using a package such as the Interbus CMD Network Configuration Tool from Phoenix Contact. These macros provide the necessary control for the main program to initiate and control PCP communications. (See section 7)

### NOTE

***The non-cyclic data channel does not use decimal points. For example, the digital speed reference 1 (#1.21) has units of Hertz, accurate to 1 decimal place. To write a value of 24.6Hz to #1.21, the value must be transmitted as 246.***

The table below shows the version of PCP protocol implemented in the different versions of Interbus interfaces. The PCP channel uses 1 word per node on each network cycle.

Interface	Firmware	System File	PCP Version
Unidrive Interbus Interface	V2.03.00	V2.6.0 and later	V1.5
Unidrive Interbus Interface	V3.00.00 and later	V2.7.3 and later	V2.0  Certified! No. 197

## 6.1 PCP V2.0

Mode 1 non-cyclic communications implements the Peripheral Communication Protocol (PCP) Version 2.0. The Unidrive Interbus has server functionality only. When an Interbus network is initialised, each node with PCP support is assigned a Communication Reference, or CR. The CR is used to identify which the node for which each command is intended.

The following services are supported:

Function	Description
INITIATE	Opens a PCP connection with the node at the specified CR
ABORT	Closes the PCP connection to the node at the specified CR
READ	Reads an Index and Sub-Index from node with specified CR
WRITE	Writes a specified number of data bytes to an Index and Sub-Index in node with specified CR
STATUS	Returns the current state and current operating state of the remote device with specified CR
IDENTIFY	Returns the "ID plates" of the device at the specified CR. The following info is returned: Manufacturer_Name: Control Techn. Device_Name Unidrive UD-74 Revision: Version 03.00
GET OD LONG	

Unidrive parameters are not addressed directly using the PCP channel. Three special objects must be used to the access Unidrive parameters.

### 6.1.1 WRITE Object

Index: 0x5000 Sub-Index: 0x00

This WRITE object is used to send a data value to a parameter within the Unidrive. Four bytes are written to this object.

3. Menu number
4. Parameter number
5. Data high-byte
6. Data low-byte

To check that the WRITE object command has been successfully implemented, use the STATUS object to check the status byte returned.

### 6.1.2 READ Object

Index: 0x5001 Sub-Index: 0x00

Reading a parameter value from the Unidrive is done in two stages. The data bytes written to the READ object defines the target parameter to be read, but does not return the actual parameter value. Two bytes are written to this object.

1. Menu number
2. Parameter number

The actual value returned from the value must be read using the STATUS object. Once a READ parameter has been defined, the READ object is not required again until the target parameter needs to be changed.

### 6.1.3 STATUS Object

Index: 0x5002                      Sub-Index: 0x00

This object returns the menu, parameter and data value of the last object sent, plus a status byte. The Unidrive parameter specified by the READ object is actually read on receipt of the STATUS object. Re-reading the STATUS object will re-read the Unidrive parameter and return the updated parameter value.

1. Menu number
2. Parameter number
3. Data high-byte
4. Data low-byte
5. Status byte

The status byte indicates whether the READ or WRITE message was implemented successfully.

Status Byte	Indication	Description
0x80	READY	The previous PCP message was implemented successfully in the Unidrive
0xC0	ERROR	An error occurred with the previous PCP message. This can be caused writing a value of range, writing to a read-only parameter of reading from a write-only parameter.

#### **NOTE**

*The decimal point is ignored with data values transferred using Interbus. A Unidrive parameter with a value of 1.23 will return the value 123 or 0x7B.*

### 6.1.4 Reading parameters using PCP

To read a parameter from a Unidrive using the PCP channel, the READ and STATUS objects must be used. The menu and parameter references are written to the READ object, with the data value and status byte returned when the STATUS object is read.

The sequence of events required is shown in the diagram below.

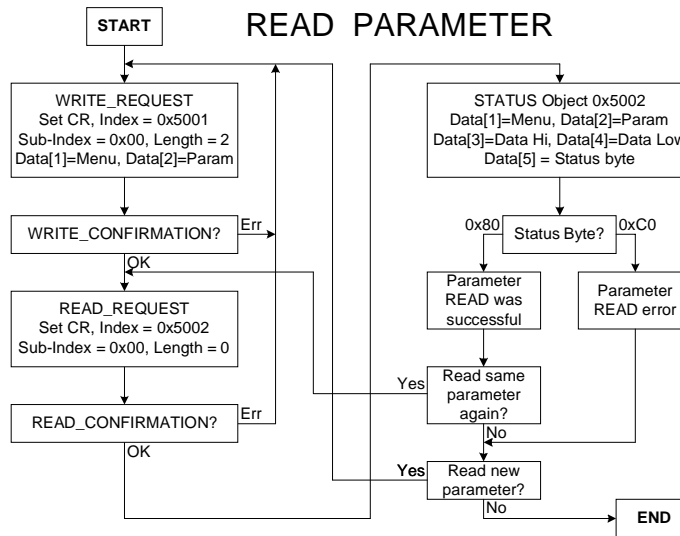

An INITIATE\_REQUEST command must be used to establish a PCP connection to each node on the network to which PCP commands will be sent. Once a PCP connection has been established, the INITIATE\_REQUEST command is not required again unless a network error causes the PCP connection to be aborted by the master controller.



### 6.1.5 Writing parameters using PCP

To write a parameter to the Unidrive using the PCP channel, the WRITE and STATUS objects must be used. The menu and parameter references, plus the data high and data low bytes are written to the WRITE object. These values are returned, along with the status byte when the STATUS object is read.

The sequence of events required is shown in the diagram below.

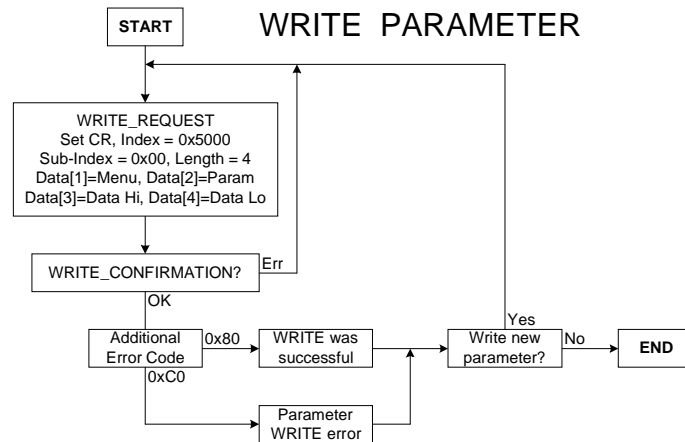

An INITIATE\_REQUEST command must be used to establish a PCP connection to each node on the network to which PCP commands will be sent. Once a PCP connection has been established, the INITIATE\_REQUEST command is not required again unless a network error causes the PCP connection to be aborted by the master controller.

The non-cyclic data channel provides the controlling PLC with a method of reading from or writing to any parameter within the Drive. This channel can be used for single infrequent data transfers, or uploading and downloading parameter sets for a particular node. This would allow the PLC program detect new or replacement nodes, and download the required parameter set.

## 6.2 Interbus Set-up using Non-Cyclic Data

The Unidrive Interbus interface can also be configured via the non-cyclic data channel. Menu 20 in the Unidrive contains the parameter values currently being used, and these can be modified as required. Cyclic data mapping parameters can be edited via the non-cyclic data, but changes made to the data mapping will not take effect until the UD70 has been reset.

Setting #17.19 to 1 will store the mapping changes in the Interbus interface, and reset the Interbus interface. The Interbus master controller may detect a brief error while the Unidrive Interbus interface resets and re-configures itself.

The parameters listed below are the parameters that can be written to configure the Interbus interface.

Param	Default	Description
#20.07	#90.11	IN Channel 1 Mapping
#20.03	#2.01	IN Channel 2 Mapping
#20.04	#4.02	IN Channel 3 Mapping
#20.06	#90.11	OUT Channel 1 Mapping
#20.01	#1.21	OUT Channel 2 Mapping
#20.02	#4.08	OUT Channel 3 Mapping
#20.11	200	Trip Delay Time in ms (See section 9.1) If no network messages are received in this time period, the network loss trip is invoked.
#20.13	0	Reserved, must be set to 0.
#17.14	0	Network Loss Trip Enable
#17.19	0	UD70 Store and Reset

The parameters listed in the table below return information about the Interbus interface. Writing to these parameters will not affect the operation of the node.

Param	Description
#20.14	Option ID Code (See section 8.1) Indicates the fieldbus type, flavour and hardware version.
#20.15	Software Version Vxx.yy (See section 8.2) Indicates the firmware version fitted to the Interbus interface
#20.50	Fieldbus Diagnostic (See section 8.6) Indicates the number of message being processed by the Unidrive Interbus interface
#17.02	System File Version (See section 8.3)

Parameters #20.01 to #20.20, and #20.50, are reserved for use by the Unidrive Interbus interface. Unpredictable behaviour of the Interbus interface may result if these parameters are used for other purposes.

---

## 7 Interbus CMD Tool Support Files

---

### 7.1 Interbus CMD Tool

The CMD Tool is the software package used to configure and diagnose the Generation 4 Interbus master controllers. An external database file is available from Control Techniques that contains full product descriptions and bitmaps for Unidrive and Commander SE. This allows easy inclusion of the Unidrive in Interbus networks.

A database file is provided to describe the Unidrive data format. The non-cyclic channel configuration is also included to support PCP. Unidrive bitmap files are also included.

Drive	Filename
Unidrive	CT_IBS.ZIP

The file CT\_IBS.ZIP contains a text file README\_CT.TXT. This contains the instructions on how to install the Unidrive support file to the appropriate directories, and import it into the CMD Configuration Tool. Contact your local Drive Centre to obtain the above file.

#### **NOTE**

*The Interbus CMD Tool support files are not essential when configuring an Interbus network. Each node can be entered manually, or the master controller can scan the network to determine which nodes are connected.*

### 7.2 Interbus Data Formats

Non-cyclic data mode	Cyclic words	Interbus ID Code	Process Data Channel	CMD Tool Ref
PCP V2.0	3	0xF3 (243)	48 bits	F_103

---

## 8 Diagnostics

---

The information from the parameters described below should always be noted before contacting Control Techniques for technical support.

### 8.1 Fieldbus Code

**Unidrive:** #20.14

The fieldbus code identifies the hardware level in the option module. This information is vital when trying to determine what upgrades can be performed on older modules.

#20.14	Fieldbus Type	Fieldbus Flavour	Hardware Revision	
200	2 (Interbus)	0 (Remote)	0 (UD74A Issue A and UD74B Issue B)	
201	2 (Interbus)	0 (Remote)	1 (UD74A and UD74B Issue 01.01)	

### 8.2 Firmware Version

**Unidrive:** #20.15

The version of firmware fitted to the DeviceNet interface can be read from #20.15 on Unidrive. The Hardware Revision column shows the hardware level that can accept each version of firmware.

	Code	Firmware Version	Hardware Revision	
Unidrive	203	V2.03.00	0	
	300	V3.00.00	1	

### 8.3 System File

Unidrive: #17.02

The system file installed in the UD70 must be the correct file for the communications option installed. The system file for the Unidrive Interbus interface is "IBSPROFI.SYS".

The system file that must be installed can depend on the level of hardware and firmware in the module. In general, new system files are backward compatible with older versions of firmware and hardware, but there may be some limitations when upgrading older modules.

The system file version can be read from parameter #17.02 on the Unidrive.

Hardware Revision	Firmware	System File	#17.02	Comments
0	V2.03.00	V2.06.00 or later	2.60	V2.06.03 or later is required if the UD70 is to be programmed using SYPT
1	V3.00.00	V2.07.03 or later	2.73	 Certified! No.197

### 8.4 Node Address

Each node is automatically assigned a network address by the master controller during network initialisation. The ring nature of the Interbus network means that the node address is determined by the physical location of the node on the network.

### 8.5 Network Data Rate

The network data rate is fixed at 500 Kbits/sec.

### 8.6 Network Status

Unidrive: #20.50

#20.50 on Unidrive indicates the number of valid messages per second being received by the node. The Interbus network master controller addresses every node on the network once per network cycle, and exchanges the configured amount of information. If a network has been correctly wired, screened and terminated, there will be very few errors occurring, and the number of messages per second displayed on each node should be the same. #20.50 is only updated once per second.

## 8.7 Diagnostic LEDs

LED	Indication	Colour	Description
RC or CC	Cable Check	Green	Indicates that the cable connection is good. The LED will go off during the reset sequence.
BA	Bus Active	Green	Indicates that the bus is active, and data is being transferred.
TR	Transmit Receive	Green	Indicates that the PCP connection has been made, and data is being transferred through the PCP channel.
RD	Remote Bus Disable	Red	Indicates that the outgoing remote bus is switched off.
LD or US	Local Bus Disable	Red	Indicates that the Interbus interface is powered up. Local bus is permanently disabled.

### **NOTE**

*The LED's on the Unidrive Interbus Interface module are inside the plastic, and cannot be seen under normal operating conditions. They can be viewed by removing the top cover of the option module, but this should only be done by suitably qualified personnel during commissioning.*

## 8.8 No Data Transfer

If data is not being transferred from the master controller to the Unidrive, make the following checks:

- Check the cabling connections.
- Ensure the correct system file has been downloaded to the UD70.
- Check the controller configuration settings.
- The mapping parameters have been programmed correctly and stored. Reset the UD70 to ensure that the changes take effect.
- Check that there are no mapping parameter conflicts, i.e. an analogue input is not trying to control the same parameter as a cyclic OUT channels. The "Linking Screen" in UniSoft shows all input and output mapping parameters on a single screen for this purpose.
- Check that the network is running, #20.50 >0. (See section 8.6)

## 8.9 Unidrive Trip Codes

If certain errors occur, the Unidrive will trip and show the trip code in the upper window.

Trip Code	Error
tr52	This code indicates that the trip originated from the setting of bit 4 in the control word.
tr56	The UD70 does not contain the correct operating system. Download the system file "IBSPROFI.SYS" from the MD29 Toolkit
tr57	An illegal operating system call has been made, e.g. "WRNET". This is a CNet command, and is not available with Interbus.
tr60	This trip indicates that the time-out trip has been activated. The number of network cycles per second has dropped to zero in the trip time period when cycles were counted in the previous trip time period.

Refer to section 9.3 for details about resetting the Unidrive using the Interbus network.

---

## 9 Advanced Features

---

### 9.1 Network Loss Trip

Unidrive: #20.11

The Interbus interface counts the number of valid network cycles received in a time period specified by #20.11. The trip is triggered if no messages are received in a given sample period, and messages were received in the previous sample period. The default setting for #20.11 is 48ms.

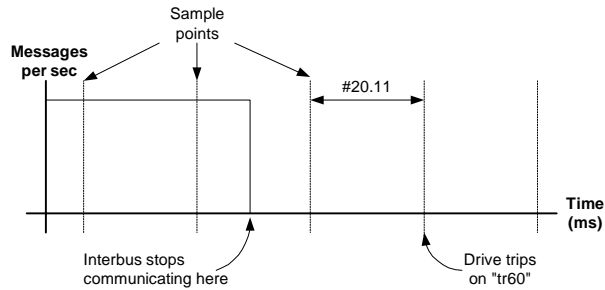

As can be seen from the diagram, the actual time from network loss to Drive trip will range from #20.11 ms to  $2 * \#20.11$  ms. By decreasing #20.11, the maximum trip time will be reduced, but if the trip time is set too low, spurious network loss trips will be seen.

The actual network loss trip time depends entirely on the number of messages per second being received under normal operation. As a rough guide, the network loss trip time (#20.11) should be set such that a minimum of 10 messages will be received in any given sample period under normal operating conditions.

#### **NOTE**

*The network loss trip delay is specified in ms, but the time set will be rounded up to the nearest multiple of 16ms. Hence, if the time delay is set to 100ms, this will be rounded up to 112ms.*



## 9.2 Unidrive Sequencing Mode 3

The default sequencing mode for Unidrive is the Wire-Proof PLC Mode. If PLC Mode is selected (#6.04 = 3), the sequencing bits (#6.30 - #6.32) have slightly different functions.

Control Word	Parameter	Sequencing Bit	PLC Mode (#6.04 = 3)
b0	#6.15	Enable	Enable
b1	#6.30	0	Run
b2	#6.31	1	Jog
b3	#6.32	2	Reverse

**ENABLE** the display will show "Inh" when set at 0, and depends on #6.30 and #6.32 when set to 1. Setting #6.15 to 0 overrides #6.30 and #6.32, and immediately disables the Unidrive. The motor will coast to rest if it is running when the Unidrive is disabled.

**JOG** the jog bit must be set, along with the appropriate run and direction signals.

To reset the Unidrive using the Interbus network, use the non-cyclic channel to set #10.38 to 100. The Unidrive will clear #10.38 back to 0 and reset. (See Unidrive manual for more information.)

Some example control word values for the Unidrive are given in the tables below.

b15-b12	b11-b8	b7-b4	b3-b0	Value	Action (PLC mode)
0000	0010	0000	0000	0x0200	Drive disable
0001	1110	0000	0001	0x1E01	Enabled + stopped
0001	1110	0000	0011	0x1E03	Enabled + run fwd
0001	1110	0000	1011	0x1E0B	Enabled + run rev
0001	1110	0000	1111	0x1E07	Enabled + jog rev

## 9.3 Drive Reset Using The Interbus Network

The Unidrive control word does not provide a RESET bit to clear a trip condition in the Unidrive. There are three methods of resetting the Unidrive from the master controller via the Interbus network.

### 9.3.1 Reset Without DPL Code

To implement a RESET function without using DPL code, one of the application bits in the control word (see section 5.6) must be used. The application bits directly control #18.31, #18.32 and #18.33, so one of these parameters must be used to control the RESET function (#10.33) of the Unidrive. A 0-1 transition of the application bit will reset the Unidrive.

Assuming #18.31 is to be used as the RESET bit, one of the programmable logic functions in menu 9 can be used to link #18.31 to #10.33, and control resetting of the Unidrive. The table below shows the Unidrive parameter settings required. An alternative configuration using logic function 2 can be implemented by using the parameters in brackets instead.

Parameter	Value	Parameter	Value
#9.04 (#9.14)	18.31	#9.08 (#9.18)	0
#9.05 (#9.15)	0	#9.09 (#9.19)	0.0
#9.06 (#9.16)	0.00	#9.10 (#9.20)	10.33

By default, #10.33 is directly controlled by digital input 2. This must be disabled by setting the mapping parameter for digital input 2 (#8.13) to another value.

If the terminal reset function is required in addition to a fieldbus reset function, logic function 1 or 2 can be configured as an OR function of the fieldbus and terminal reset signals. The parameter settings for menu 9 to implement this are shown below.

Parameter	Value	Parameter	Value
#8.13	<> 10.33	#9.07 (#9.17)	1
#9.04 (#9.14)	18.31	#9.08 (#9.18)	1
#9.05 (#9.15)	1	#9.09 (#9.19)	0.0
#9.06 (#9.16)	8.02	#9.10 (#9.20)	10.33

#### **NOTE**

*The Unidrive may need to be reset several times if multiple trips have occurred. As the reset will only occur on a 0 -1 transition of #10.33, the master controller should toggle the RESET bit until Drive Healthy (bit 0 of the status word) goes to 1.*

### 9.3.2 Reset Using PCP Communications

If PCP communication has been implemented in the master controller, the Unidrive can be reset by writing a value of 100 to #10.38. The Unidrive may require several reset attempts if multiple trips have occurred. Use bit 0 of the status word (Drive Healthy) to check that the Unidrive has been successfully reset. (See sections 5.7 and 6)

### 9.3.3 Reset Using DPL Code

If both of the menu 9 logic functions within the Unidrive are being used, some DPL code can be used to monitor the control word, and reset the Unidrive. The code should be placed in the SPEED, ENCODER or CLOCK task to ensure frequent scanning of the RESET bit.

```

ENCODER {
reset% = #18.31          ; new state of RESET signal

; check for 0 to 1 transition of RESET bit
IF reset% = 1 AND old_reset% = 0 THEN

; set #10.38 to 100 until Drive Healthy bit is set
DO
      #10.38 = 100
LOOP WHILE #10.01 = 0
ENDIF

old_reset% = reset% ; store current state of RESET signal
}

```

If another trip condition occurs while the Unidrive is tripped, the Unidrive must be reset twice before all trips are cleared. This is achieved by using the DO...WHILE loop until the Drive Healthy bit (#10.01) is set.

**NOTE**

***If a run-time (program) error occurs in the UD70, the DPL program will stop, and the master controller will not be able to reset the Unidrive using the Interbus network.***

## 9.4 Non-Cyclic Parameter Store

Unidrive: #17.19

0 = no action

1 = store Interbus configuration

Setting #17.19 to 1 will store all #20.PP parameters, and all internal 32-bit \_Pxx% and \_Qxx% registers. The Interbus interface will also be reset, causing the Interbus network to stop. Any changes made to the configuration via the non-cyclic communications channel will take effect when the reset sequence has been completed.

**NOTE**

***Resetting the Interbus interface will cause the network to stop. The Unidrive Interbus interface will take approximately 700ms to complete the reset sequence, after which the network can be re-started.***

## 9.5 EVENT Task Trigger on UD70

Unidrive: #17.23

The EVENT task is a high priority task in the UD70 that can be triggered either by the timer/counter unit, or by the Interbus network.

When the fieldbus network is selected as the trigger source, the EVENT task is triggered in every Interbus network cycle.

#17.23	EVENT Task Trigger Source	Comments
0	Timer/Counter Unit	The EVENT task is triggered when the counter rolls over/under, or by digital input 0 on the UD70. Refer to UD70 Manual for more information.
1	Interbus	The EVENT task is triggered every time new data arrives from the Interbus network, and is passed to the UD70.

Care must be taken not to put too much code in the EVENT task. It has a higher priority than all other UD70 tasks except for the INITIAL task, so an extended EVENT task could easily prevent the SPEED task from running, and cause the UD70 to trip.

### **NOTE**

*This feature is only available with system file V2.07.06 or later.*

---

## 10 Quick Reference

---

### 10.1 Complete Parameter Reference

Parameter	Default	Description
#20.01	121	IN Channel 2 Mapping
#20.02	408	IN Channel 3 Mapping
#20.03	201	OUT Channel 2 Mapping
#20.04	402	OUT Channel 3 Mapping
#20.06	9011	IN Channel 1 Mapping
#20.07	9011	OUT Channel 1 Mapping
#20.11	48	Trip Delay Time (ms)
#20.14	201	Option ID Code (Read only)
#20.15	300	Software Version Vxx.yy where software version is Vxx.yy.zz (Read only)
#20.50	----	Fieldbus Diagnostic (Read only) Also displayed in #0.47
#20.05	0	Reserved
#20.08	0	Reserved
#20.09	0	Reserved
#20.10	0	Reserved
#20.12	0	Reserved
#20.13	0	Reserved
#20.16	0	Reserved
#20.17	0	Reserved
#20.18	0	Reserved
#20.19	0	Reserved
#20.20	0	Reserved

### 10.2 Interbus Data Formats

Format	Non-cyclic data mode	Cyclic words	Interbus ID Code	Process Data Channel
F_103	1	3	0xF3 (243)	48 bits

## 10.3 Fieldbus Control Word

<b>b15</b>	<b>b14</b>	<b>b13</b>	<b>B12</b>	<b>b11</b>	<b>b10</b>	<b>b9</b>	<b>b8</b>
M6	M5	#18.33	M3	M2	M1	M0	#18.32

<b>b7</b>	<b>b6</b>	<b>b5</b>	<b>b4</b>	<b>b3</b>	<b>b2</b>	<b>b1</b>	<b>b0</b>
#18.31	#1.46	#1.45	TRIP	RUN REV	JOG	RUN FWD	ENABLE

Bit	Function	Description
0	ENABLE	Set to 1 to put the Unidrive in READY mode. (The hardware ENABLE must also be present.) The RUN FWD, JOG and RUN REV bits will have no effect unless the ENABLE bit is set to 1. The Unidrive outputs are disabled immediately when the ENABLE bit is reset to 0, and the motor will coast to stop
1	RUN FWD	Set to 1 to run the motor in the forwards direction. Reset to 0 to decelerate the motor to a controlled stop before the Unidrive output stage is disabled
2	JOG	Set to 1 with RUN FWD or RUN REV bit also set to jog the motor in the appropriate direction. The Unidrive will ramp the motor to the normal speed or stop when the JOG bit is reset to 0, depending on the status of the RUN FWD and RUN REV bits.
3	RUN REV	Set to 1 to run the motor in the reverse direction. When reset to 0, the Unidrive will decelerate the motor to stop before the outputs are disabled
4	TRIP	Set to 1 to trip the Unidrive on "tr52". The TRIP bit must be reset to 0 before the Unidrive can be reset.
5	#1.45	Preset Reference Select. These bits are used to select the digital speed references used. Refer to the Unidrive User Guide for more information.
6	#1.46	
7	#18.31	User application bit
8	#18.32	User application bit
9	M0	ENABLE mask bit
10	M1	RUN FWD mask bit
11	M2	JOG mask bit
12	M3	RUN REV mask bit
13	#18.33	User application bit
14	M5	Mask bits for the Preset Reference Select bits
15	M6	

## 10.4 Fieldbus Status Word

b15	b14	b13	b12	b11	b10	b9	b8
X	#10.15	#10.14	#10.13	#10.12	#10.11	#10.10	#10.09

b7	b6	b5	b4	b3	b2	b1	b0
#10.08	#10.07	#10.06	#10.05	#10.04	#10.03	#10.02	#10.01

Bit	Parameter	Description
0	#10.01	Drive healthy
1	#10.02	Drive running
2	#10.03	Zero speed
3	#10.04	Running at or below min speed
4	#10.05	Below set speed
5	#10.06	At speed
6	#10.07	Above set speed
7	#10.08	Load reached
8	#10.09	In current limit
9	#10.10	Regenerating
10	#10.11	Dynamic brake active
11	#10.12	Dynamic brake alarm
12	#10.13	Direction commanded
13	#10.14	Direction running
14	#10.15	Mains Loss
15	X	Not used

## 10.5 Unidrive Trip Codes

The trip codes listed below may be caused by the Interbus interface. Other trips may occur if a DPL program is loaded. For a full list of UD70 trips, refer to the UD70 User Guide

Trip Code	Error
tr52	This code indicates that the trip originated from the setting of bit 4 in the control Word
tr56	The UD70 does not contain the correct operating system for the detected hardware. Download the system file "IBSPROFI.SYS". If the trip persists, ensure that the UD73A and UD70 boards inside the module are properly clipped together. (This should only be attempted by suitably qualified personnel!!)
tr57	An illegal operating system call has been made, e.g. WRNET. CTNet commands cannot be used with Profibus-DP
tr60	This trip indicates that loss of the Interbus network has been detected. This can be caused by disconnecting the node from the network, a bad cable connection, or by resetting or stopping the network master controller