

NACHI

Standard specifications

FD11 controller

11th edition

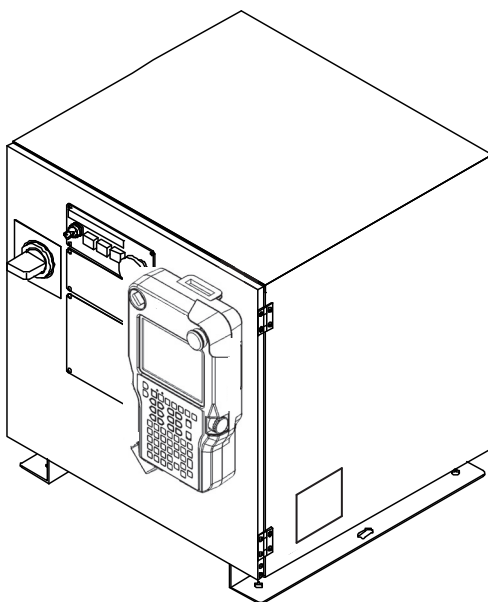

NACHI-FUJIKOSHI CORP.

1808, SFDEN-006-011,001

Table of contents

1. Basic Specification..... 2

2. Control Specification..... 3

 2.1 Standard functions 3

 2.2 Changing specification..... 5

 2.3 Option functions..... 6

3. Controller Appearance..... 14

 3.1 Controller dimensions 14

 3.2 Teach pendant and operating panel..... 15

 3.3 Additional box dimensions 16

 3.4 Additional axes BOX (transformer less spec.) dimensions 17

 3.5 Additional axes BOX (transformer spec.) dimensions..... 18

 3.6 User interface panel..... 19

 3.7 Layout for option part installation (inside of cabinet)..... 20

 3.8 Layout for option part installation (inside of additional cabinet)..... 21

4. Transporting..... 22

5. Installation..... 23

 5.1 Installing dimensions 23

 5.2 Installing place 23

 5.3 Installing method..... 24

6. Type of controller 25

1. Basic Specification

<i>Item</i>	<i>Specification</i>
Controlled axis	Simultaneous 6 axes (maximum 8 axes as option)
Servo motor	AC servo motor
Position reader	Absolute encoder
Programming language	Teaching playback
Program number	9,999 programs
Memory capacity	256MB (2,560,000 steps equivalent)
Teach pendant	5.7 inches color LCD (640*480, with back light, 65,536 color display) standard cable length 8m (direct inlet specification) single hand 3 position enable switch (left hand), touch panel, IP65 equivalent, Weight 0.96Kg, Cable diameter ϕ 8.3mm
Operating panel	Mode select switch (teach/playback), Emergency stop button, Motor ON button, Start button, Stop button
Safety function	PLd (category 3)
Stopping category (*1)	Category 0 stop Emergency stop and external emergency stop in teach mode, Teach enable switch (mat switch), G-STOP (protective stop) in teach mode <i>Category 0 is stopping robot by turning off the servo power immediately.</i> Category 1 stop Emergency stop and external emergency stop in playback mode, Safety plug, G-STOP (protective stop) in playback mode, Hold <i>Category 1 is stopping robot after deceleration done, then turning off the servo power.</i> Category 2 stop Stop, Pause <i>Category 2 is stopping robot after deceleration done. Servo power is kept on.</i>
Cables to robot	standard cable length 5m (direct inlet specification)
Memory device	Flash memory
External memory device	USB memory (USB memory itself is not accessory of controller)
User interface	Interface panel on front door inside, side panel and rear panel (refer to another sheet) (When hardware option is added, some place may not be available to use.)
Construction	Full closed cabinet
Dust proof, drip proof	IP54 equivalent
Cooling	Indirect cooling method
Standard Primary power supply (*2)	AC200V – 220V +/- 10% (3 phase, 50/60Hz) D grounding Main circuit breaker 40A, Leak current maximum 100mA <Consuming power> While robot's moving : Refer to the specification sheet for each robot While power saving : 0.13kVA (cooling fan is activating), 0.08kVA (cooling fan is stopping)
Power supply for interface circuit	AC200V +/- 10%, 2 phase, 50/60Hz, 5A at maximum DC24V 0.8A at maximum
Ambient temperature	0 – 45 degree (50/60Hz)
Ambient humidity	20 – 85% (no dew)
Installation	Not higher than 1,000 meters above sea level
Standard External dimension (*3)	W580*D542*H590 mm (not including the height of stand 60mm)
Standard Weight (*3)	Approx.62Kg
Color	Munsell 10GY9/1
Others	Conforms to RoHS

(*1) Please refer to the FD controller instruction manual "SETUP" or "External Input / Output".

(*2) In power saving, motor power is turned off and robot arm is held by brake.

(*3) External dimension and weight may vary due to the robot type, primary power voltage, option and or so.

2. Control Specification

2.1 Standard functions

<i>Functions</i>	<i>Abstract</i>
Interpolation	Linear interpolation; XYZ parallel movement on robot coordinate system (based on the world wide standard JIS B8437) Fixing TCP; Changing robot attitude while fixing TCP point Tool coordinate; XYZ parallel movement on tool coordinate system Circular interpolation; Movement on circle by determined with 3 points. Start point and end point can be designated individually.
Low speed playback	TCP speed is limited 250mm/sec under following condition. 1. Low speed signal input 2. Check GO/BACK operation 3. First step playback after STEP number is designated
Speed definition	TCP linear speed 1 - 5000mm/sec (0.1mm/sec unit) Time 0.01 - 100sec (0.01sec unit) Power ratio 1.0 - 100.0 % (0.1% unit) Tool angle speed 1 - 500deg/s (1deg/s unit)
Speed override	Playback speed can be varied 1 - 150% without changing recorded speed.
Check GO/BACK	In teach mode, recorded position can be confirmed step by step or continuously, and forward / backward. (Functions also can be played back.)
Accuracy	8 degrees (0 - 1000mm) of in position accuracy can be designated on every step. And in-position or path-through can be designated also.
Tool designation	32 different tools can be designated on every step.
Automatic tool length calculator	Tool length is calculated by playback designated program.
Automatic tool weight and COG calculator	Tool weight and COG is calculated by playback designated program.
Automatic tool moment of inertia calculator	Tool moment of inertia is calculated by playback designated program.
Self checking	Self check the error of robot and controller. (700 kind of errors)
Error detection	Check the condition of robot and controller all the time. Robot stops immediately when error happens.
Logical I/O	Maximum 2,048 logical inputs and 2,048 logical outputs are available as standard. I/O card is option.
Signal assignment	Port assignment and positive/negative logic of all I/O is available.
Editor	1. Screen editor Addition, deletion and copy of every move step and function is available. Recorded position can be also edited. 2. Copy utility Recorded program and step can be copied. 3. Program conversion Condition & speed, each axis angle, parallel shift, etc. 4. Program Certification File directory, file verify

Functions	Abstract
Machine lock	This can check I/O by playback program, keeping robot stationary.
I/O simulation	This can check program flow by changing logical I/O from teach pendant, keeping physical I/O locked.
Memory protect	This can protect program to avoid the modification and deletion by careless operation.
Power saver	This can save energy by motor power off and brake lock after pre-determined time passed with no movement. When more time passed, fan motors inside of cabinet will stop for further power saving.
Monitor utility	Real time monitor of following data; 1. Robot program 2. Error logging 3. Fixed I/O 4. General usage I/O 5. Program queue 6. Operating time 7. PLC program (ladder monitor), and or so
Help message (Built-in manual)	Operations and function explanations are displayed on teach pendant. And graphical troubleshooting manual is also displayed.
Customization	Software keys are re-locatable for better operation.
Power failure backup	When main power is down while playback robot, all necessary data is back upped for easy restarting of the robot after power on.
Program queue	Up to 10 programs to be played back can be reserved.
Home position	Up to 32 home position can be defined. Home position signal is outputted.
Functions	<ul style="list-style-type: none"> - General usage signal output - General usage signal input - Program flow control (step jump/call, program jump/call) - Timer delay - Welding, and or so
Interface panel	Pushbuttons and lamps can be arranged on teach pendant touch panel screen. Operating switches and indicators are replaced to software, so this utility can contribute to cost down. Available to register up to 31 keys /screen * 8 screens = 248 keys
Ethernet	File upload and download via Ethernet is available. (1 port)
Serial interface	RS232C communication is available. (1 ch)
Built-in PLC	This is software programmable logic controller. Physical I/O board (another option) is necessary to perform I/O actually.(Refer to hardware option)
High Speed Interference Detection	In the case operation mistake or unexpected interference occurs during teaching work, this function can detect it as a contact with outside world, and stops the robot immediately.
Overhaul Prediction	This is to prevent from trouble occurrence by estimating the lifespan of bearings in each robot arm and by detecting torque over. Furthermore, this function can predict the overhaul timing of robot.

2.2 Changing specification

No.	Item	Specification
■ Primary power voltage		
1	Different primary power voltage (*1)	For out of the standard primary power voltage (AC200 - 220V). AC 380/400/420/440/460/480V +/-10%, 3φ 50/60Hz, D grounding AC580/600V +/-10%, 3φ 50/60Hz, D grounding [North America specification] Controller type; FD11-1101 Breaker 15A [Except for North America specification] Controller type; FD11-0100 Breaker 30A
■ Connection		
1	Cable to robot	Cable length can be changed up to 5m, 10m, 15m, 20m, 25m (direct inlet and connector specification) Total cable length 25m at maximum
2	Cable to T/P	Cable length can be changed up to 8m, 15m, 25m, 30m (direct inlet specification)
■ Overseas specification		
1	For North America (*1)	Some parts are replaced to conform to North America standard : ANSI/RIA R15.06:1999 and NFPA79 Controller type; FD11-1101
2	For Europe (*1)	Some parts are replaced to conform to European standard : CE marking (Controller type; FD11-0100 + CE specification (FD11-SEQMAIN-05) Please refer to "6. Type of controller" for the detail of teach pendant and wire harness.

(*1) Additional box for transformer is necessary on the standard cabinet. External dimension of controller is changed to W580*D542*H1180 mm (not including the height of stand 60mm).

2.3 Option functions < Hardware option >

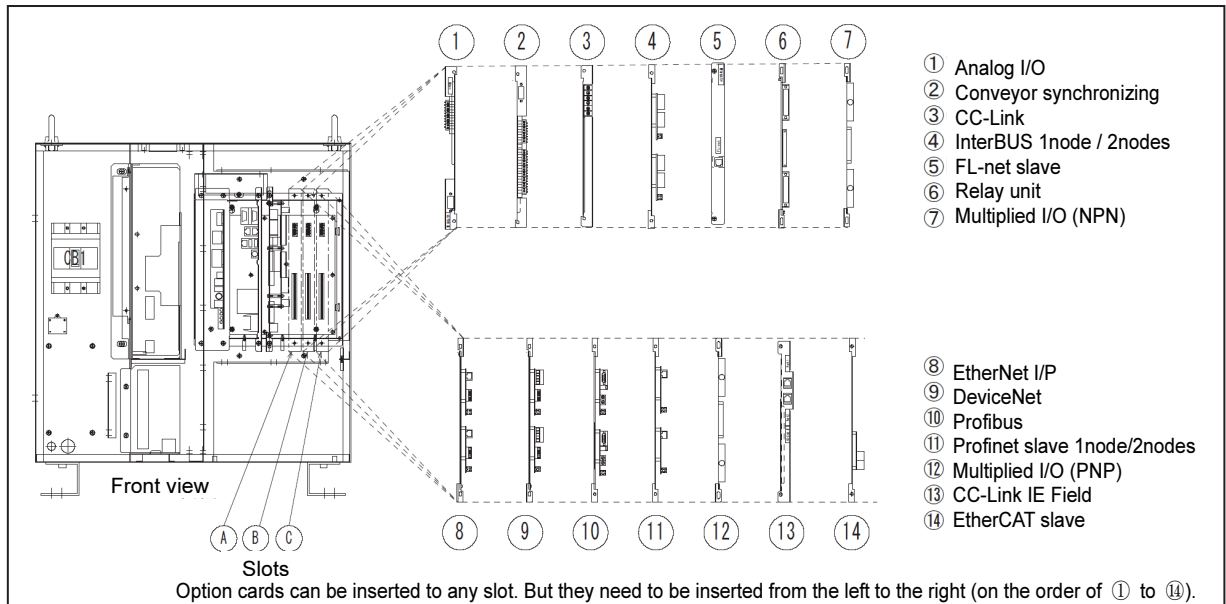

No.	Item	Specification	Parts No.
Memory			
1	USB memory	Used to backup program and constant. (Insertion port is equipped as standard on teach pendant.)	
			1GB FD11-OP93-A
			4GB FD11-OP93-B
Additional Axes			
1	Gun axis	Spot welding gun is servo controlled. Gun specification (gun quantity, gun change) and simultaneous usage with another aux. axes depends on the individual application.	Additional amplifier may be necessary according to total axis number *4
2	Slide axis	Slider unit is servo controlled.	
3	Positioner axis	Positioner is servo controlled.	
4	Gripper axis	Gripper is servo controlled.	
5	Servo ON/OFF control of mechanism by mechanism	Motor power line and brake line of aux. axes is connected / disconnected one by one to enable of individual servo ON/OFF irrelevant from robot. This utility is convenient to operate robot when aux. axes has fatal error.	
		1 axis	FD11-OP80-A
		2 axes	FD11-OP80-B
		2 axes at the same time	FD11-OP80-C
6	Servo analog monitor	For servo tuning procedure, the velocity and the current wave shape can be outputted with analog voltage. A D/A converter IC and connection cable is attached.	FD11-OP142-A

No.	Item	Specification	Parts No.
<p>■ Interface</p>			
1	Fieldbus *1	<p>Fieldbus is available up to 4 channels with the combination of master, slave and master+slave. (Maximum channel quantity may vary according to Fieldbus specification and combination with other options.)</p> <hr/> <p>CC-Link CC-Link (applicable to Ver.1.10) CC-Link IE Field FL-net slave EtherCAT slave INTERBUS 1 node INTERBUS 2 nodes Profinet 1 slave Profinet 2 slaves EtherNet IP DeviceNet Profibus</p>	<p>AX10-OP98-B AX10-OP98-C FD11-OP155-A FD11-OP101-B FD11-OP169-B AX10-OP100-A AX10-OP100-B AX10-OP136-B AX10-OP136-D AX10-OP130-# (# = A-E) AX10-OP131-# (# = A-E) AX10-OP132-# (# = A-E)</p> <p>(A: Master) (B: Slave) (C: Master+Slave) (D: Slave+Slave) (E: Master+Master)</p>
2	Multiplied I/O *1	<p>I/O board UM356 is added in PCI slot. Maximum 96 inputs and 96 outputs can be available by adding three I/O boards.</p> <p>Input DC24V : no pole, Input resistance 3kΩ/ 8mA) Output DC24V : NPN, output voltage DC36V, output current 100mA)</p> <hr/> <p>PNP adding 32 points PNP adding 64 points PNP adding 96 points NPN adding 32 points NPN adding 64 points NPN adding 96 points</p>	<p>FD11-OP151-A FD11-OP151-B FD11-OP151-C FD11-OP125-A FD11-OP125-B FD11-OP125-C</p>
3	Relay contact output	<p>Output signal is outputted through relay contact. (This option is used with "Multiplied I/O" specification) Relay contact board mounted inside of front door can support 32 relay contact outputs. Maximum two relay contact boards can support up to 64 relay contact outputs.</p> <hr/> <p>PNP adding 32 points PNP adding 32 points NPN adding 32 points NPN adding 64 points</p>	<p>FD11-OP118-AP FD11-OP118-BP FD11-OP118-AN FD11-OP118-BN</p>

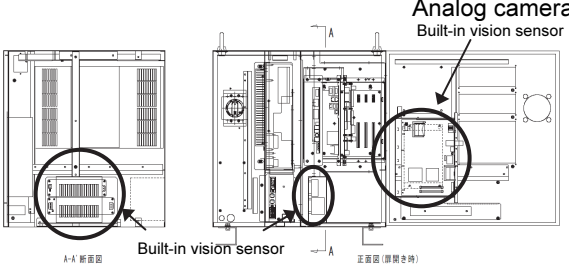
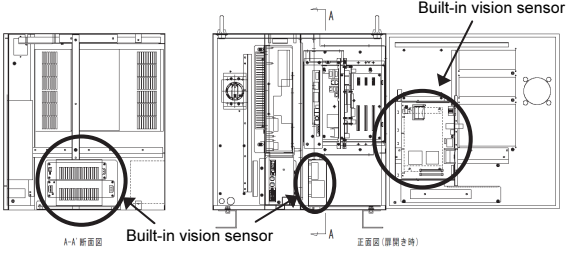
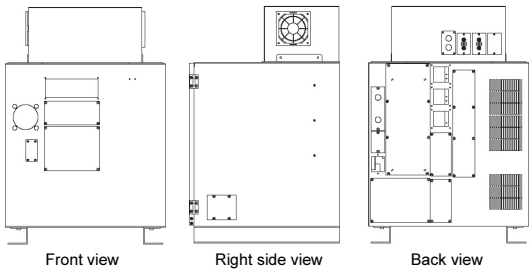
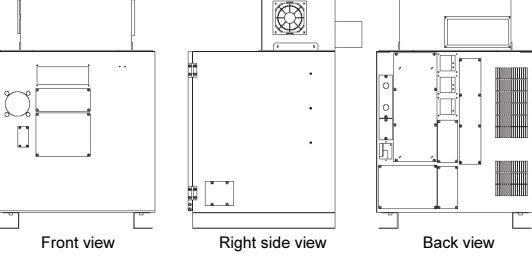
No.	Item	Specification	Parts No.
<p>■ Others</p>			
<p>1</p>	<p>Vision sensor *2</p>	<p>Vision system can see the target such as work-piece by camera, and measure its position. Control unit is stored inside of controller.</p>	
		<p>Built-in</p>  <p>Analog camera Built-in vision sensor</p> <p>Built-in vision sensor</p> <p>A-A 断面図</p> <p>正面図 (制御ユニット側)</p>	<p>FD11-OP139-A</p>
		<p>Built-in</p>  <p>Digital camera Built-in vision sensor</p> <p>Built-in vision sensor</p> <p>A-A 断面図</p> <p>正面図 (制御ユニット側)</p>	<p>FD11-OP139-G</p>
		<p>Vision system can see the target such as work-piece by camera, and measure its position. Control unit is stored in added box</p>	
		<p>Added box</p>  <p>Analog camera</p> <p>Front view</p> <p>Right side view</p> <p>Back view</p>	<p>FD11-OP139-B</p>
		<p>Added box</p>  <p>Digital camera</p> <p>Front view</p> <p>Right side view</p> <p>Back view</p>	<p>FD11-OP139-F</p>

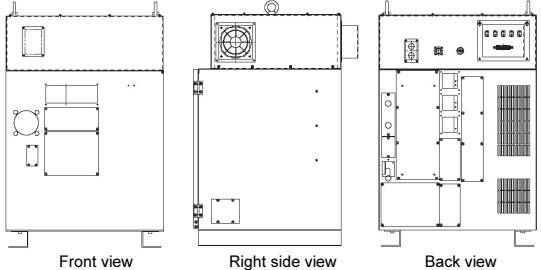
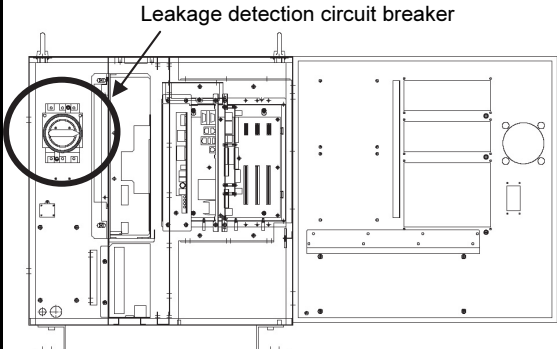
No.	Item	Specification	Parts No.
	3D matching	<p>Random dot pattern is irradiated to the target from projector and the whole of target is caught by two stereo cameras to measure the position and attitude of the target. This system needs an additional box (different from above box.)</p>  <p>Front view Right side view Back view</p> <p>Furthermore, following option is necessary.</p> <p>Projector parts (power cable 5m) Projector parts (power cable 10m) Projector parts (power cable 15m) Camera parts</p>	<p>FD11-OP139-C</p> <p>CFD-OP139-P01-05 CFD-OP139-P01-10 CFD-OP139-P01-15 CFD-OP139-C02</p>
2	Analogue I/O *1	<p>Analogue I/O interface board is added.</p> <p>Input 2ch (-10 to +10V) Output 4ch (-10 to +10V)</p>	<p>AX10-OP46-A AX10-OP46-B</p>
3	Conveyor synchronization *1	<p>To perform conveyor synchronized motion, speed signal receiver board is added. NACHI prepares the conveyor pulse transmitter unit also.</p> <p>Specification of receiver board: Differential input (conforming to RS-422), Terminating register 100Ω (can be set by SW on board), Response frequency 1MHz max</p> <p>PCB to receive conveyor speed signal Conveyor pulse transmitter unit</p>	<p>FD11-OP47-A AW10-OP47-A</p>
4	Leakage detection circuit breaker *3	<p>Main circuit breaker is replaced to the leakage detection type.</p>  <p>Leakage detection circuit breaker</p> <p>Front view (Door is opened)</p> <p>200V (Sensitivity current 100mA) 400V (Sensitivity current 100mA)</p>	<p>FD11-OP106-A FD11-OP106-B</p>
5	Brake release SW	<p>Brake release can be forcibly released when motor power is impossible to be turned on.</p>	

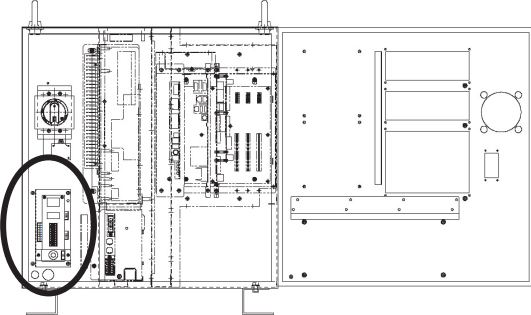
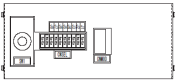
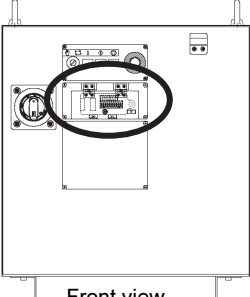
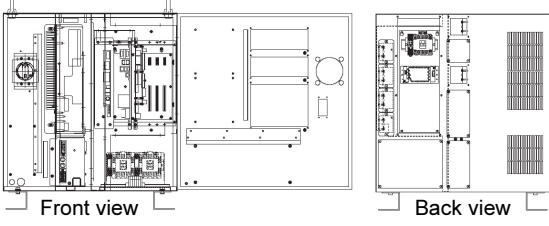
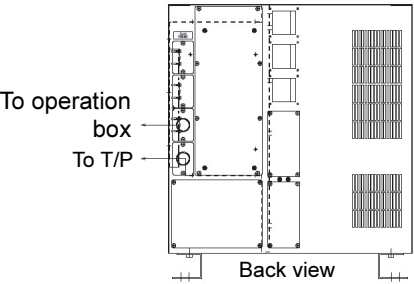
No.	Item	Specification	Parts No.
		<p>Mounted inside cabinet</p>  <p>Front view (Door is opened)</p>	FD11-OP90-D
		<p>Portable type (cable length 5m)</p> 	FD11-OP90-E
		<p>Mounted on the door panel</p>  <p>Front view</p>	FD11-OP90-F
6	External power ON/OFF control	<p>Controller primary power can be switched ON/OFF by the signal from external device.</p>  <p>Front view Back view</p>	FD11-OP18-A
7	Separate operation box	<p>Operating panel on cabinet is removed and mounted on separate box.</p>  <p>To operation box To T/P</p> <p>Back view</p>	<p>Cable length 5m FD11-OP64-A-C05</p> <p>Cable length 10m FD11-OP64-A-C10</p> <p>Cable length 15m FD11-OP64-A-C15</p> <p>Cable length 20m FD11-OP64-A-C20</p>

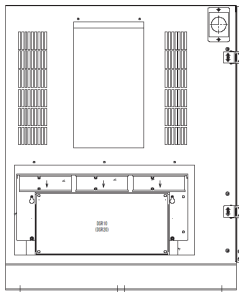
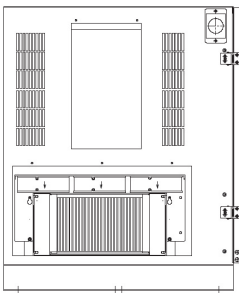
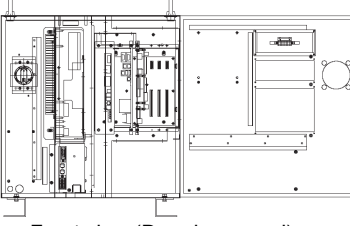
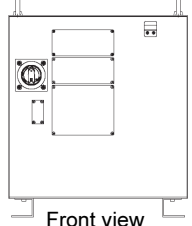
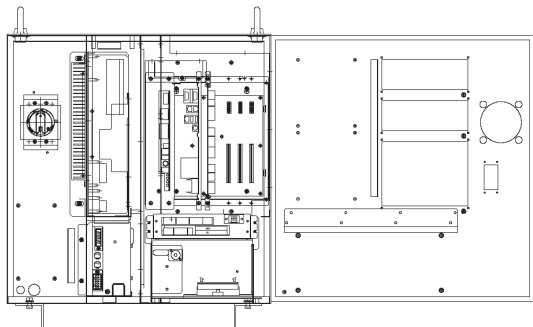
No.	Item	Specification	Parts No.
8	Upgrading of regenerative discharge resistor	Regenerative discharge resistor is upgraded for high duty motion such as palletizing.	
		<p style="text-align: center;">High-duty specification</p>  <p style="text-align: center;">Left side view</p>	FD11-OP65-B
		<p style="text-align: center;">High-duty specification (LP-series)</p>  <p style="text-align: center;">Left side view</p>	FD11-OP65-C
9	External mode selection	<p>By using an external signal instead of the mode selection switch on the operation panel, the operation mode can be selected. When this option is installed, the operation panel is removed from the controller and cannot be used.</p>  <p style="text-align: center;">Front view (Door is opened)</p>  <p style="text-align: center;">Front view</p>	FD11-OP20-A
10	Robot Monitoring Unit (RMU20)	<p>A Robot Monitoring Unit (RMU20) that monitors the robot position and the robot speed is added. In this option, an exclusive IPM drive unit is necessary.</p>  <p style="text-align: center;">Front view (Door is opened)</p>	FD11-OP145-A

*1: Extension PCI slot in PCB rack is allocated to these options. 3 PCI slots are prepared.

*2: This utility occupies the standard Ethernet port on CPU board.

So if Ethernet utility is necessary, another Ethernet option [FD11-OP83-A] is necessary.

Furthermore, servo ON/OFF control of mechanism by mechanism [FD11-OP80-C] (2 axes at the same time) can not be used.

*3: If leakage detection circuit breaker is prepared by customer at the primary power supply, its sensitivity current should be 100mA or higher.

*4: 8 axes additional option [FD11-OP124-A (transformer spec.), FD11-OP124-C (transformer-less spec.)] is necessary.

<NOTES> Combination of options

- Built-in vision sensor [FD11-OP139-A,-G] and External power ON/OFF control [FD11-OP18-A] can not be used at the same time. Also Built-in vision sensor [FD11-OP139-A,-G] and Servo ON/OFF control of mechanism by mechanism [FD11-OP80-A,-B,-C] can not be used at the same time. (These limitations are due to the physical interference. So FD11-OP139-B,C and F options have no limitation because these options need an additional box.)
- In case of CE specification, Brake release SW in the cabinet [FD11-OP90-D] can not be used. Please select Brake release SW on the door [FD11-OP90-F].
- When using "External power ON/OFF control" [FD11-OP18-A] and "8 axes additional option" at the same time, 8 axes additional option [FD11-OP124-D (transformer spec.), FD11-OP124-E (transformer-less spec.)] is necessary.
- The "Robot Monitoring Unit" [FD11-OP145-A] and the "Built-in vision sensor" [FD11-OP139-A,-G] can not be used at the same time. "2 axes" of "Mechanism by mechanism servo ON/OFF" [FD11-OP80-C] is also unavailable with this option.

< Software option >

This table shows the function that can be realized by only software.

No.	Item	Specification
1	Synchronizing control	Enabling the synchronizing control between robot and positioner, or robot and robot.
2	Multi-unit control	Enabling the simultaneous control / individual control by registering robot and aux. axes as "unit".
3	Palletizing	Palletizing and de-palletizing teaching can be programmed by easy pattern definition.
4	Adaptive motion control	Enabling to drive each joint softly.
5	Oscilloscope	Enabling to monitor the servo data such as velocity, current, etc. of each joint by graphical display on teach pendant.
6	Endless rotating function	Enabling to operate the joint endlessly rotating to one direction. Position endless, velocity endless and selectable endless need this function.
7	XYZ shift	Recorded point is played back with XYZ parallel shift amount. Also including the function to detect the deviation of work-piece location and to shift the robot locus. (Sensing device is not included.)
8	Robot language	SLIM language is supported for complicate application.
9	Fine motion control	Enabling to improve the locus accuracy. Command is recorded in step.
10	Multi-lingual	Japanese and English (standard) Korean, Chinese, Germany and Spanish (Option)
11	Socket communication	This is a function to communicate with an external device via Ethernet using a USER-TASK program that includes various application functions. This function make it possible to check the variables in the robot controller or to check the condition of the robot, or to acquire the position data from a vision-device of each manufacture and change the shift register of this robot controller.
12	Open NR-IF	This is a DLL (Dynamic Link Library) that can run on the Windows OS PC. By using this DLL, it becomes possible to connect the robot controller and the Windows PC and send/receive various data (e.g. robot position, I/O signals, etc.) each other. This function can be used for remote monitoring application software, or a traceability application software, etc.

< Document >

No.	Item	Specification
1	Instruction manual	Document explaining the basic operation and setup operation and or so. Please select either of paper manual or CD manual.

3. Controller Appearance

3.1 Controller dimensions

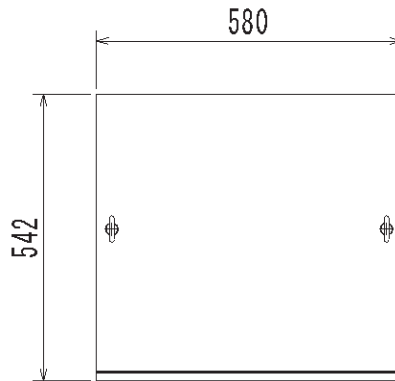

【上面図】 TOP

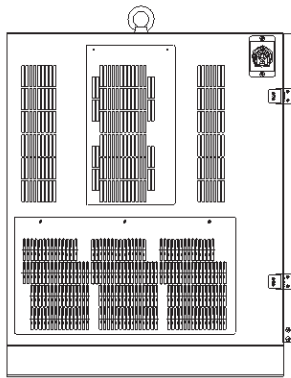

【左側面図】 LEFT

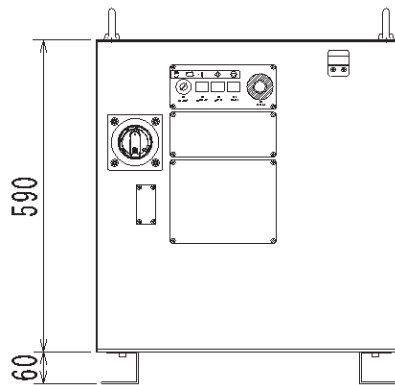

【正面図】 FRONT

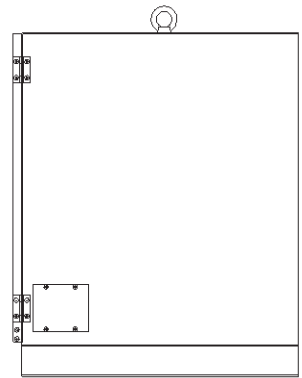

【右側面図】 RIGHT

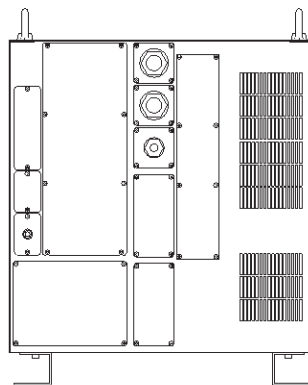

【背面図】 BACK

3.2 Teach pendant and operating panel

Operation panel

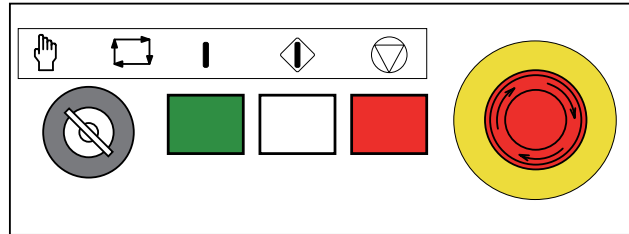

Teach pendant

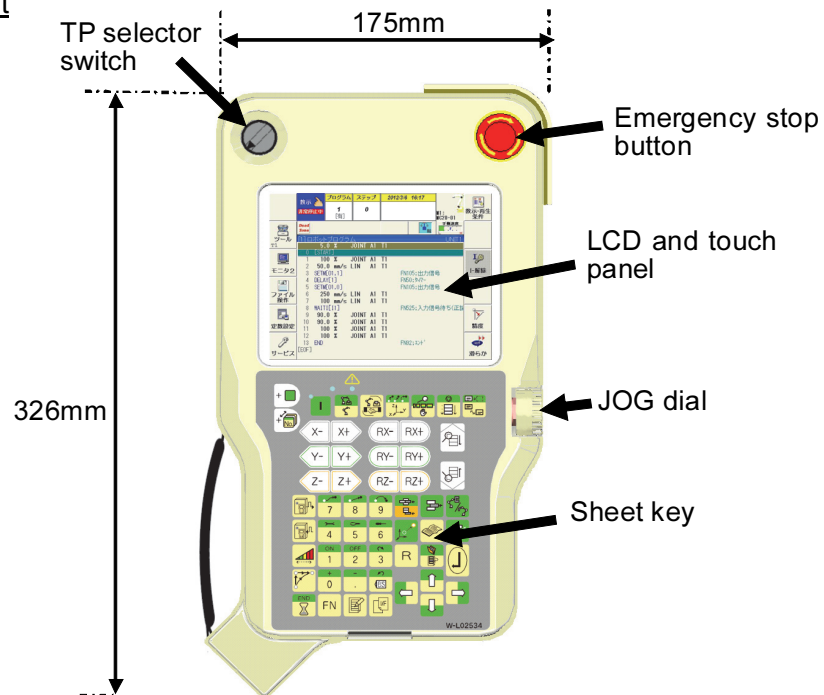

Sheet key

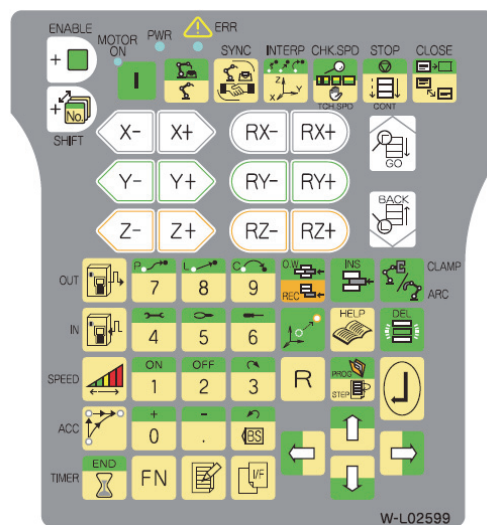

3.3 Additional box dimensions

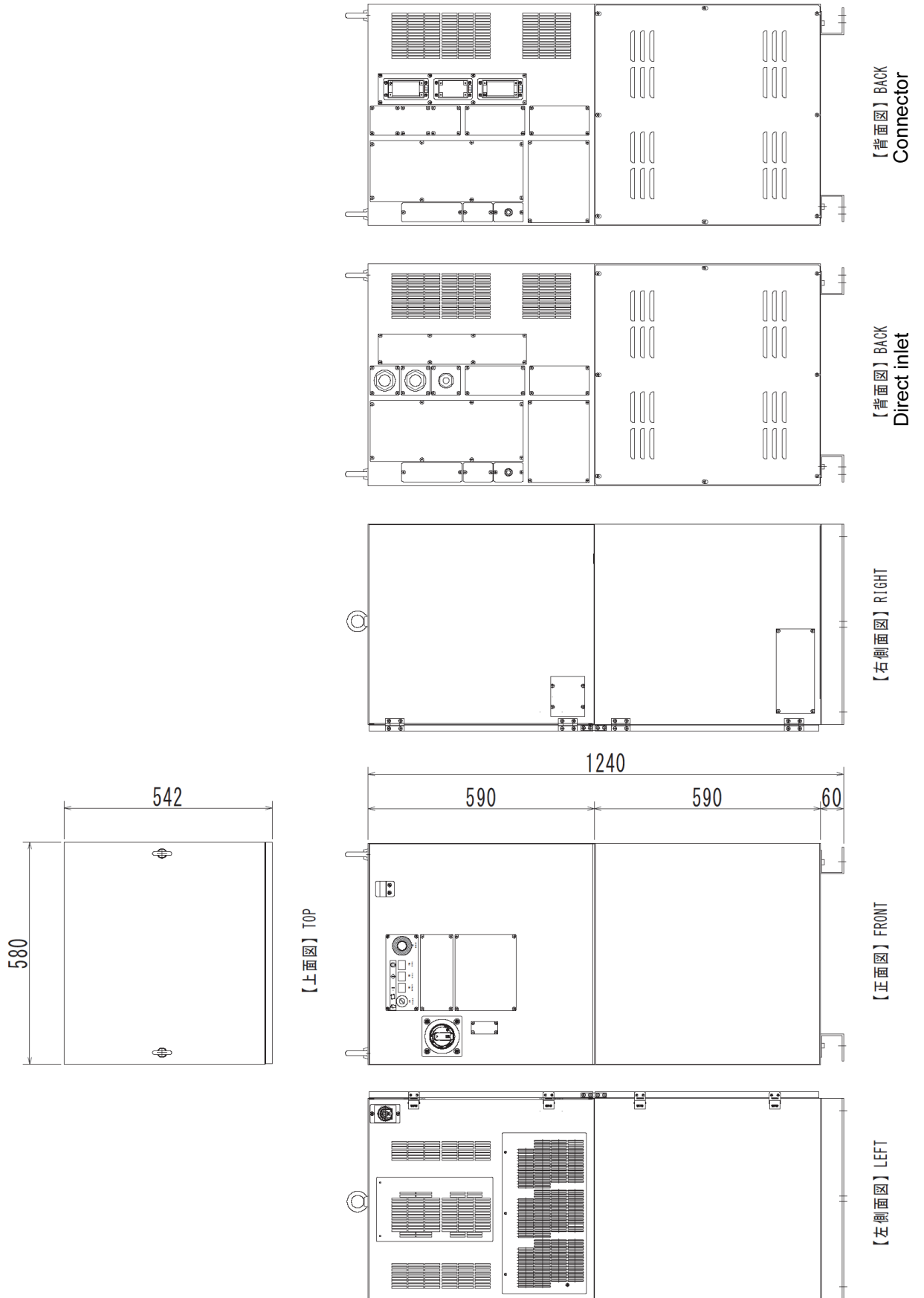

3.4 Additional axes BOX (transformer less spec.) dimensions

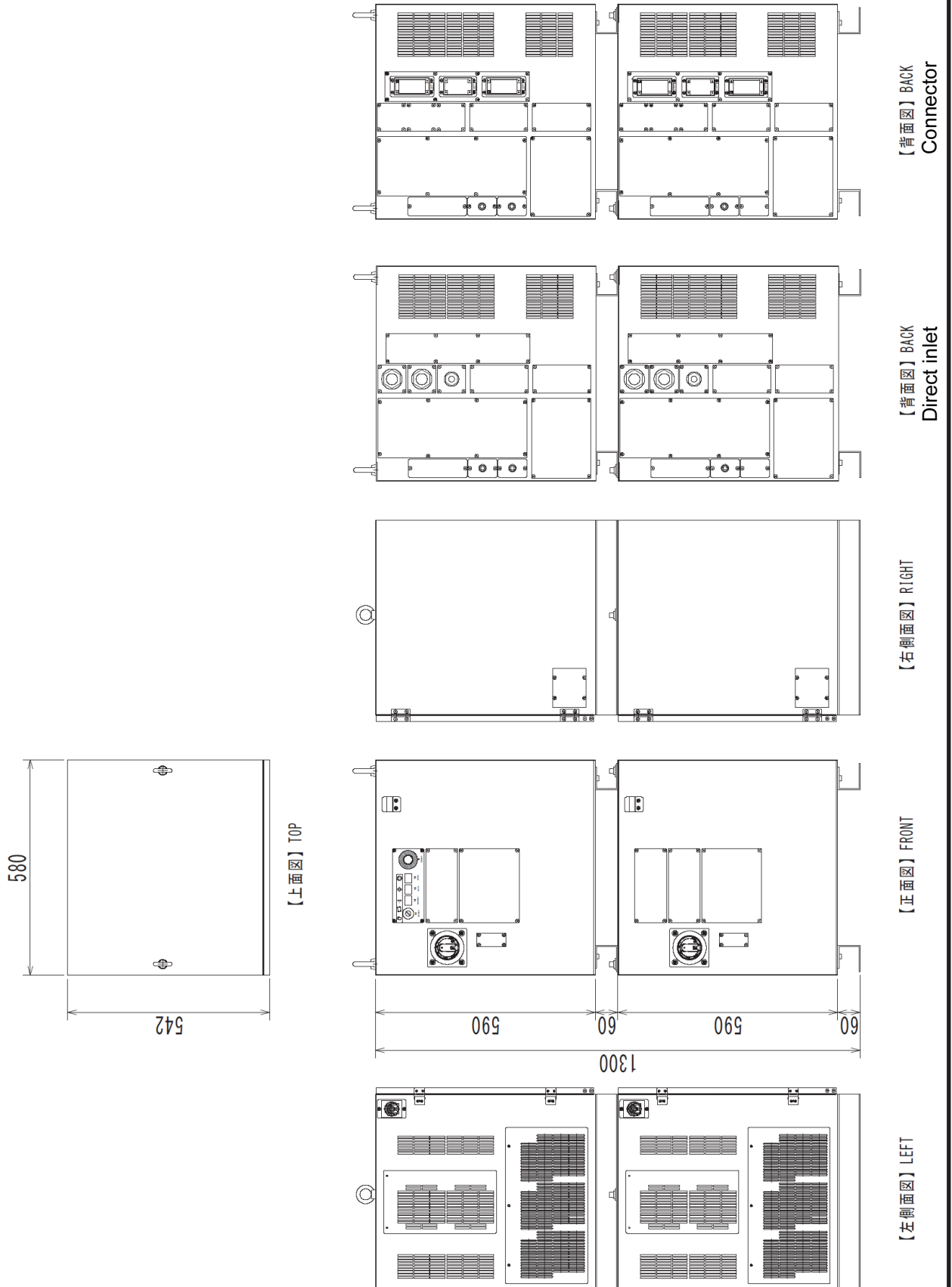

3.5 Additional axes BOX (transformer spec.) dimensions

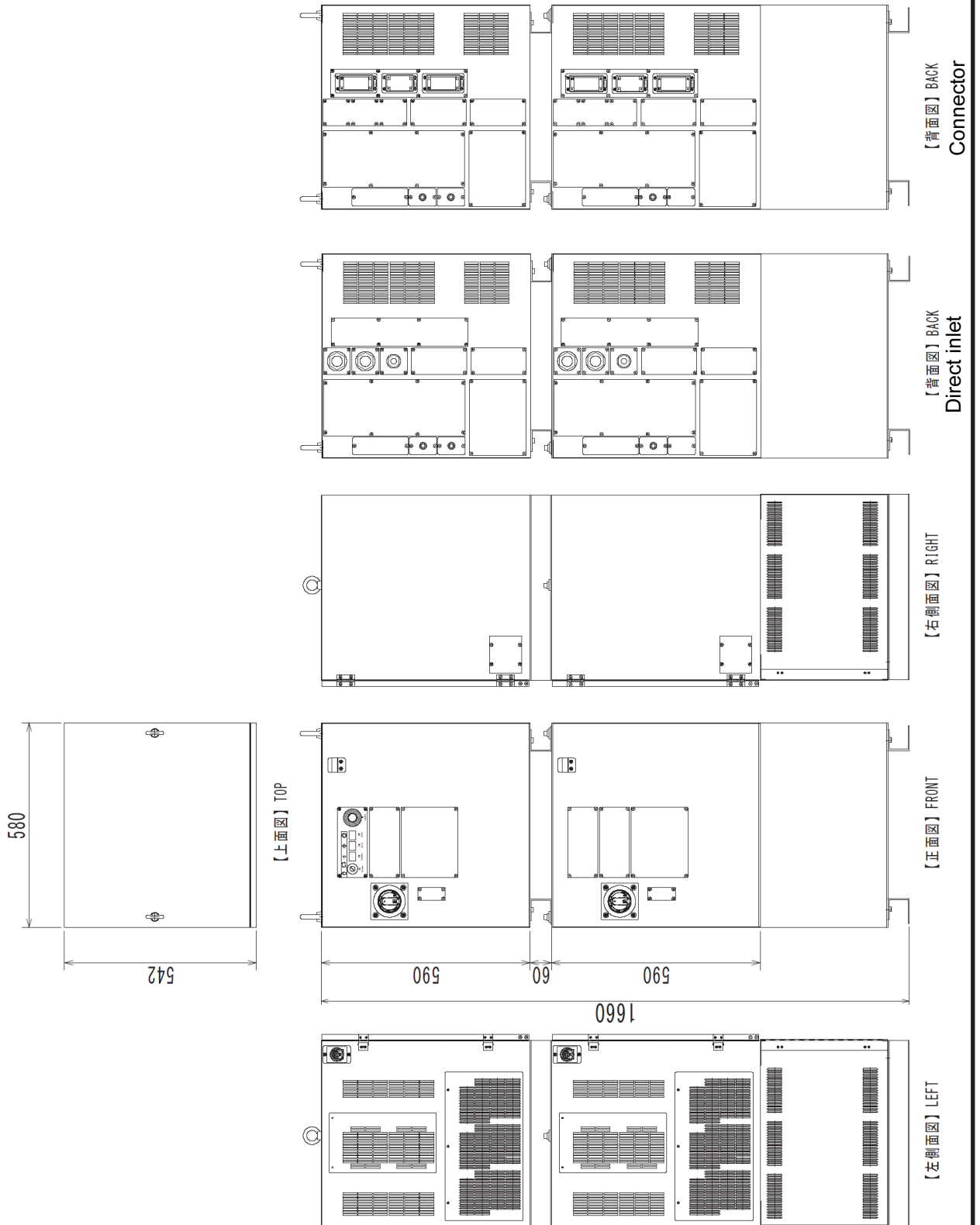

3.6 User interface panel

ケーブル入線口ハネ①
CABLE INPUT PANEL ①

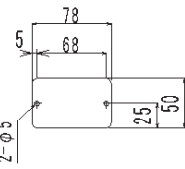

電源入線口ハネ
POWER SOURCE INPUT PANEL

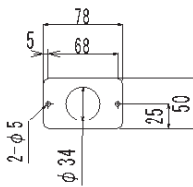

キヤプコン 0A-2 (オム電機) 取付け
CONNECTOR 0A-2 (OHM ELECTRIC)
適用ケーブル径φ9~19
APPLICABLE CABLE DIAMETER φ9~19

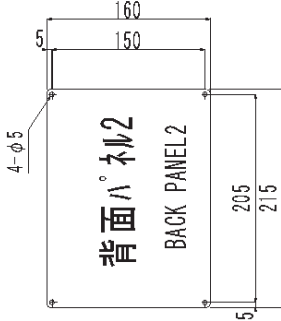

ケーブル入線口ハネ②
CABLE INPUT PANEL ②

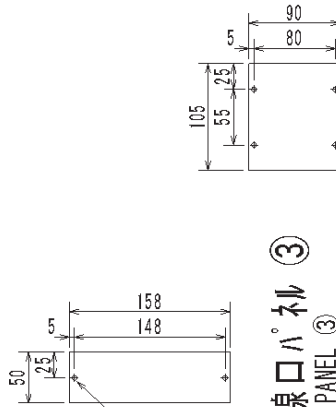

ケーブル入線口ハネ③
CABLE INPUT PANEL ③

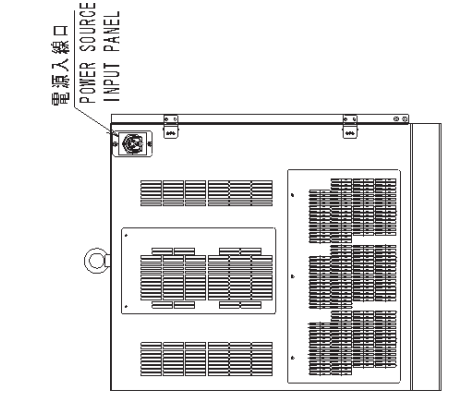
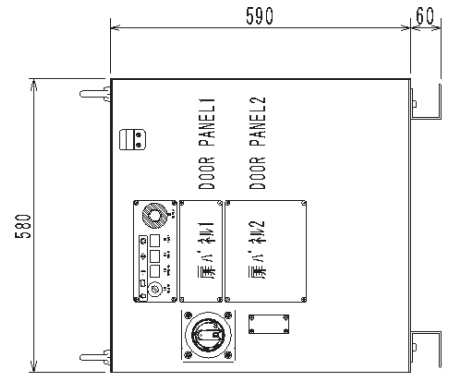
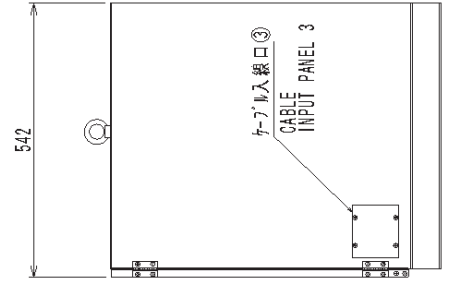
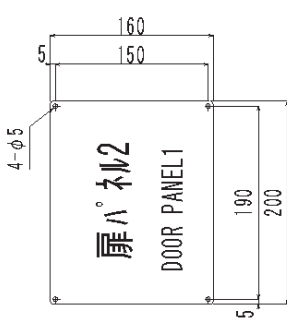
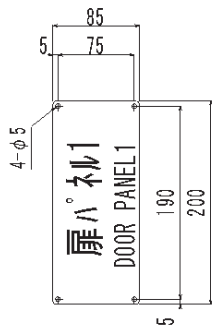
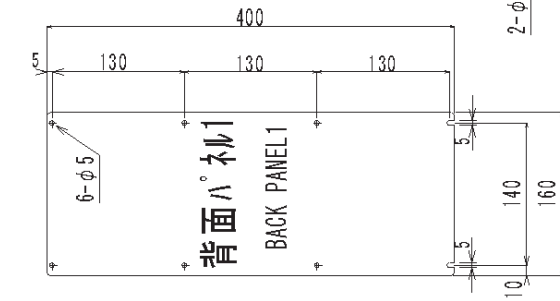
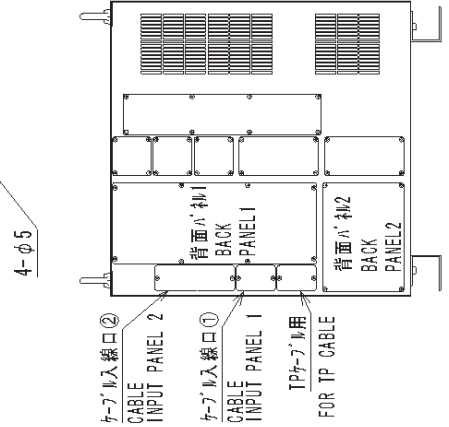

3.7 Layout for option part installation (inside of cabinet)

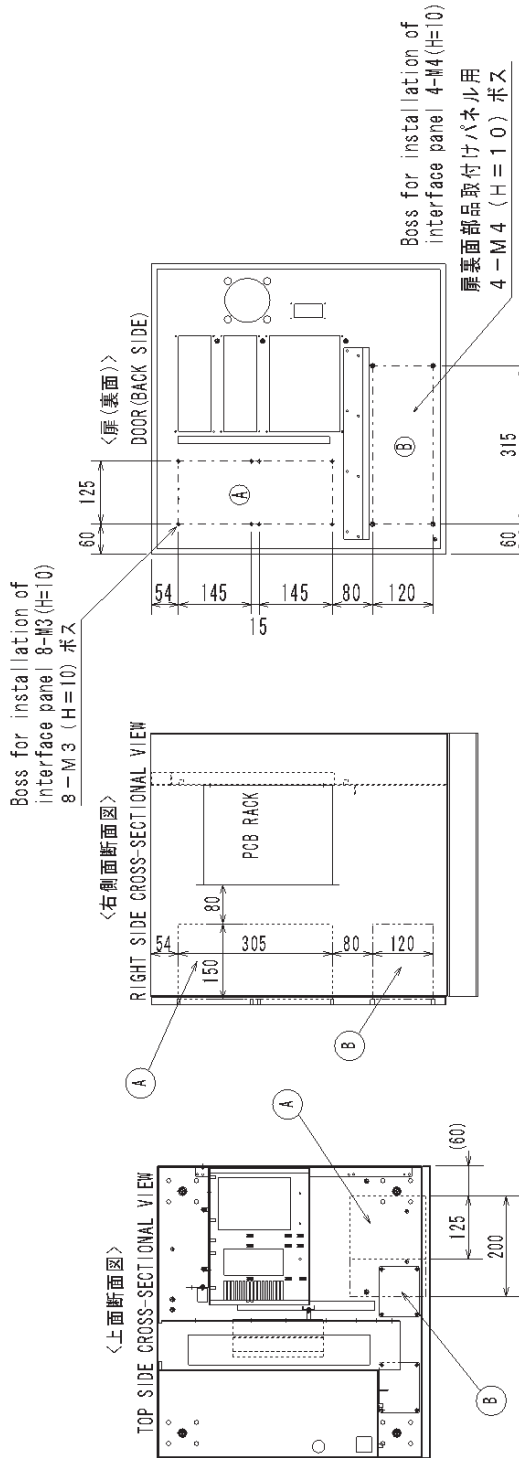

部品実装可能エリアは、パネル取付けボスの内側を目安として下さい。
 部品許容高さは、左図を参照ください。

Mount parts in less than 315mmx120mm
 The height of the parts.
 please refer to the diagram on the left

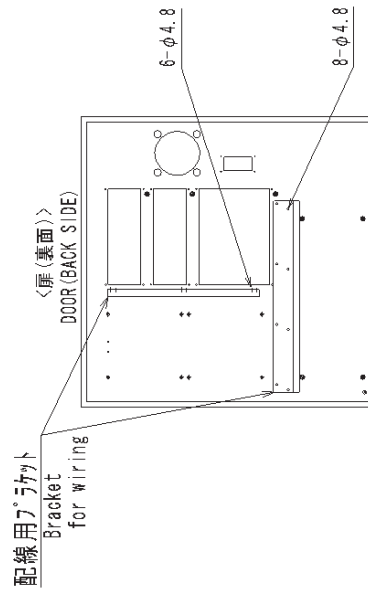



扉裏面の配線を固定するためのブラケットです、配線クランプ部品として、ワイヤードル WS-2WS (北川工業) 取付用穴 (φ4.8) を設けてあります。この穴を利用して、ケーブルバンド等も使用できます。

Bracket for fixing the wiring on the back door.
 As part wire clamp,
 Wire Saddle WS-2WS (Kitagawa Industries Co., Ltd.)
 Mounting hole (φ4.8) has provided.
 Using this hole, you can use cable tie.

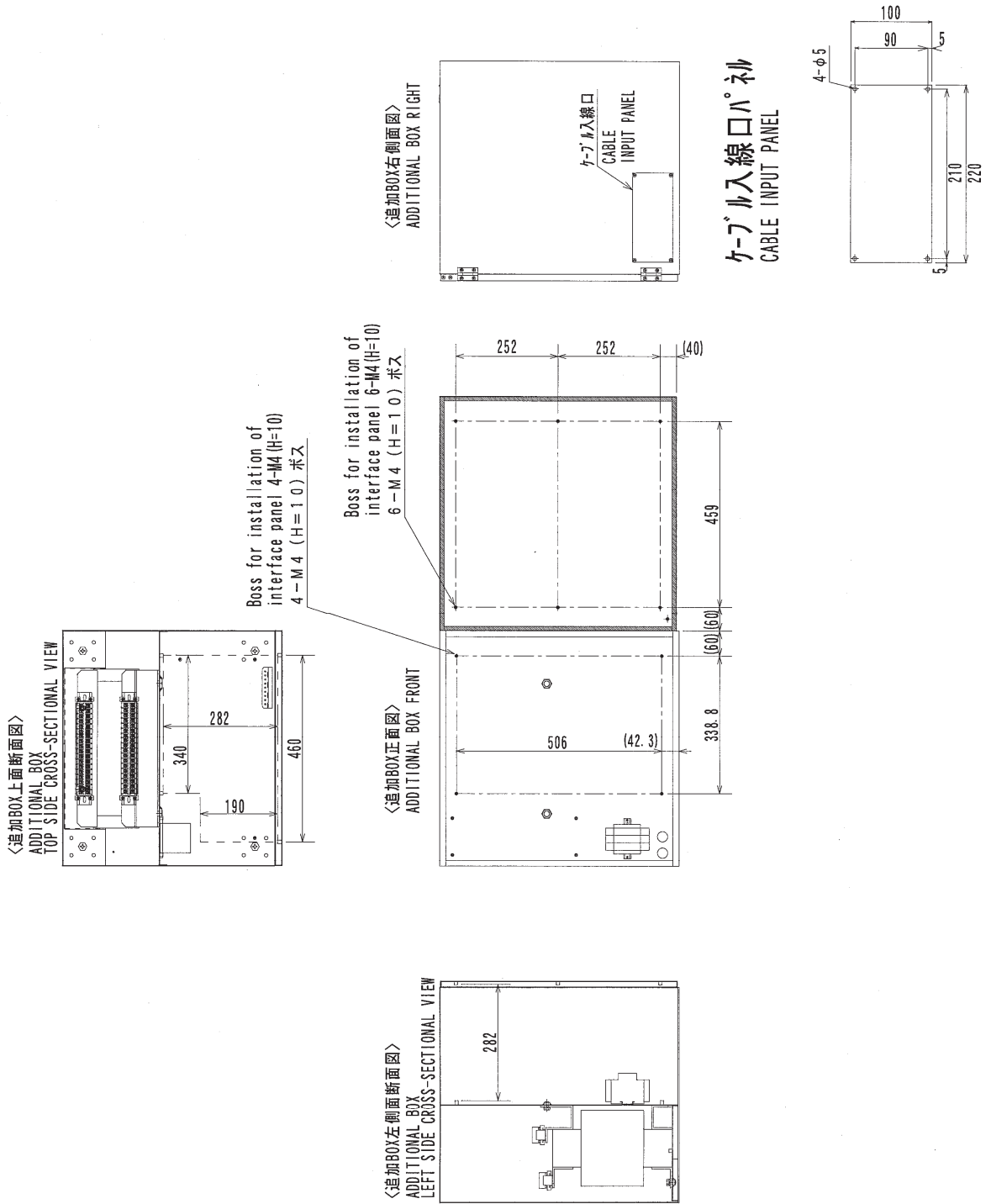
3.8 Layout for option part installation (inside of additional cabinet)



4. Transporting

 WARNING	<p>Transfer the controller to its installation place by use of a crane, a forklift, or a hand lifter. When to transfer it by use of a crane, use eye bolts (at 2 portions). And when to use a forklift or a hand lifter, transfer the controller so that it should not fall down.</p>
 WARNING	<p>The weight of the controller is approx. 62 kg. (standard single mechanism) Confirm the actual mass by the label pasted on the robot control unit because the mass may vary under other specifications.</p> <p>When working, put on protective gears such as a helmet, safety shoes and so forth, and carry out the work while wearing safe working clothes appropriate for the work.</p>
 WARNING	<p>Printed boards and other precision devices are used in the controller; therefore do not give any impact during transfer. When hoisting the controller using a crane, take care that none of the parts on the controller will be damaged by the wires.</p>

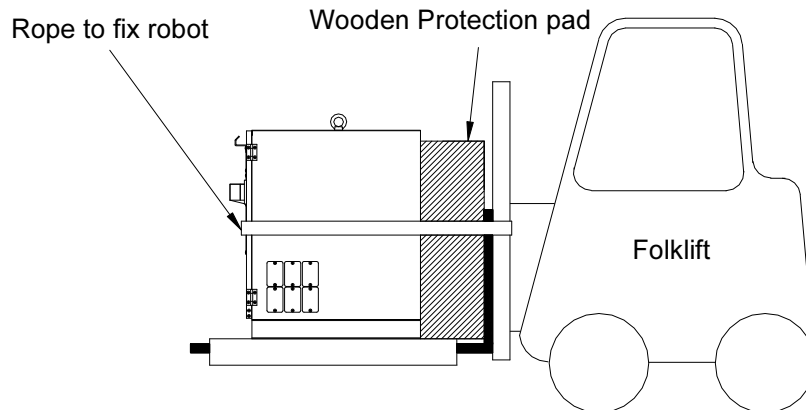

Use shackles to affix the wire rope to the eye-bolt securely

Provide the following kind of shackles
 Withstand load : 0.9 t
 JIS B2801

Wire rope
 Withstand load
 450 kg or more
 Length:
 1.5 m or more

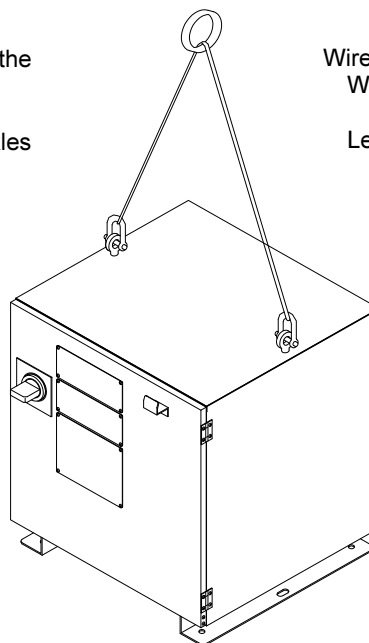

5. Installation

5.1 Installing dimensions

Although robot controller does not have any of the moving parts like the manipulator, it must still be secured at its installation location without fail in order to prevent it from falling when it has been installed in a high place or from toppling over when it has been installed on the floor.

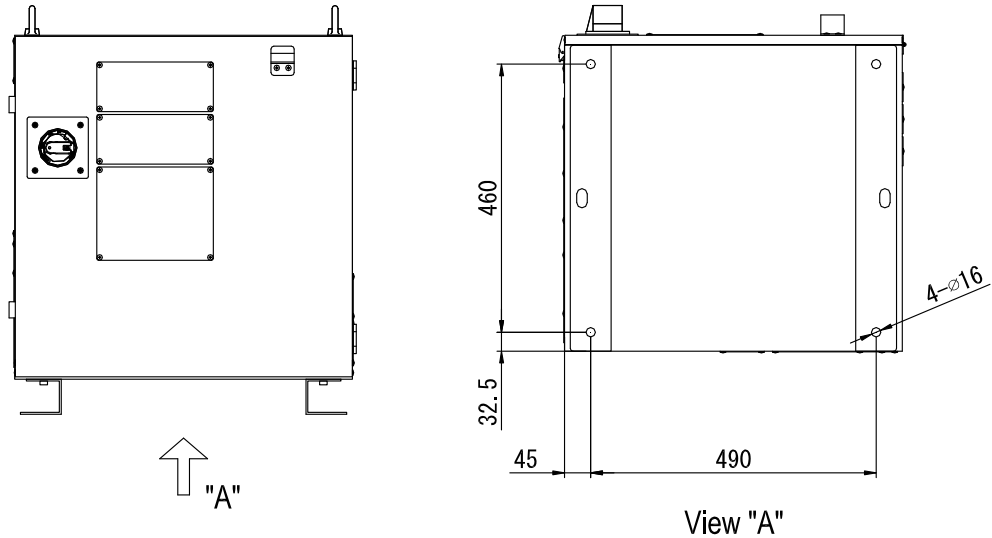

5.2 Installing place

When installing the controller, leave a clearance of at least 100 mm between the controller and the wall behind it in order to ensure proper ventilation inside the robot controller. To install a robot controller and welding power supply, etc. on a place two or more meters in height such as a frame base, a foothold as described below is required so that adjustment and maintenance, etc. can be performed.

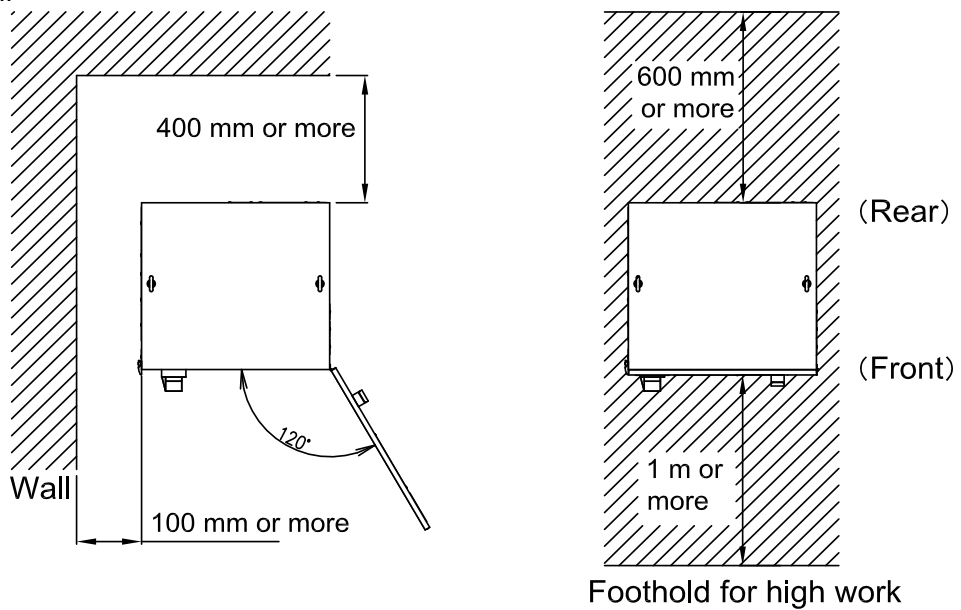

A robot controller has a through-hole for an external connection cable on its right side and back side. To install a robot controller, secure a space of 400 mm at least for external connection cable.

5.3 Installing method

When the robot controller is to be installed on the floor, first fit M12 concrete anchors and secure the support channels on the bottom of the controller to the anchor bolts using four M12 lock nuts (M12). (Tightening torque: 42.2 N•m (431 kgf•cm))

If the floor is not strong enough, embed J-shaped anchor bolts in the floor and secure the robot controller.

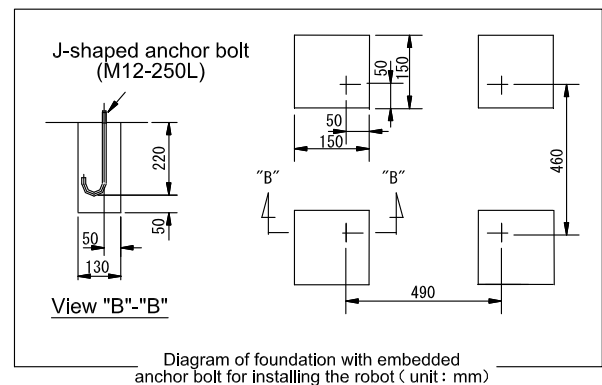
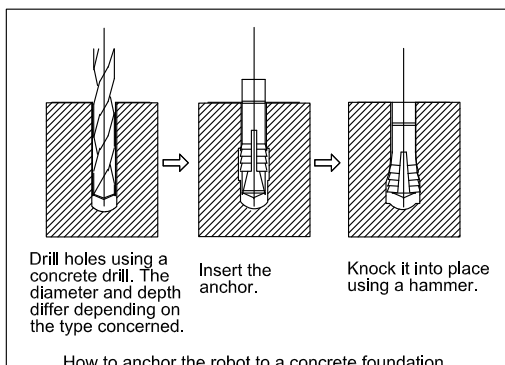
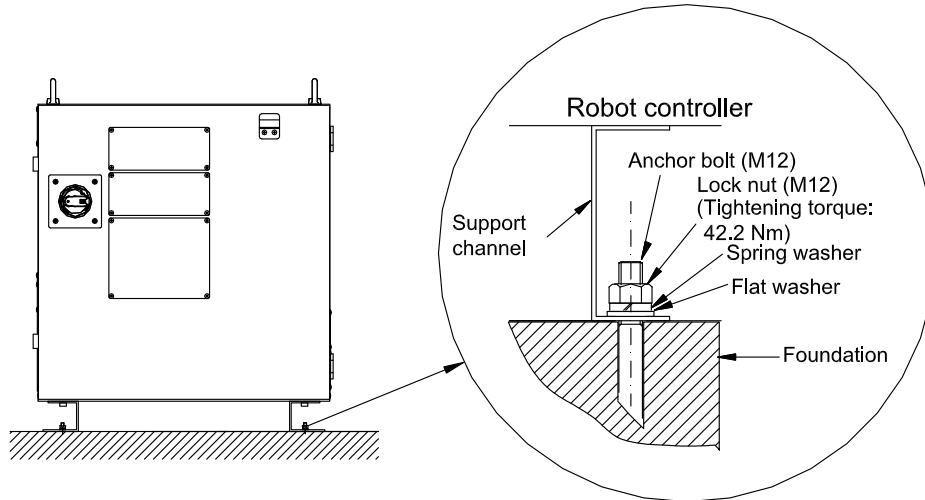

After the robot controller has been installed, shut the door completely, and check that the door has been locked by the keys provided for this purpose. Dirt, dust and other foreign matter may find their way inside the robot controller if its door is not completely shut, possibly causing it to fail. Also lock the circuit breaker of the controller using the key provided for this purpose. Be absolutely sure to entrust the safekeeping of the key for the circuit breaker padlock to a specially designated person or the person in charge of safety management. (The padlock is to be provided by customer)

Door key can be locked. If necessary, lock them and a specially designated person or the person in charge of safety management should charge the key.

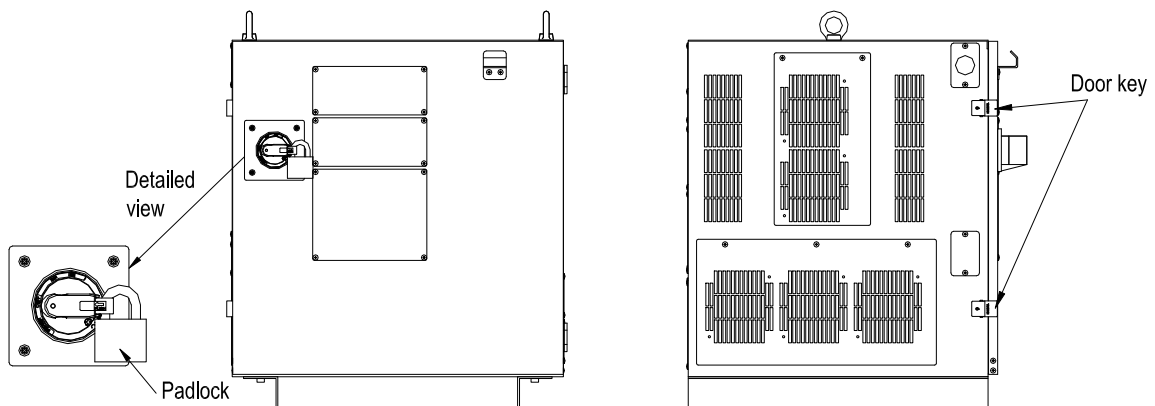

6. Type of controller

Controller type

	Specification	Primary power voltage	transformer
FD11-0000	Domestic (JIS)	AC200V	without transformer
FD11-1101	For North America (ANSI, NFPA79)	AC400V, etc	with transformer
FD11-0100	For both Domestic and Abroad	AC400V, etc	with transformer

Teach pendant type

FDTPFSJ

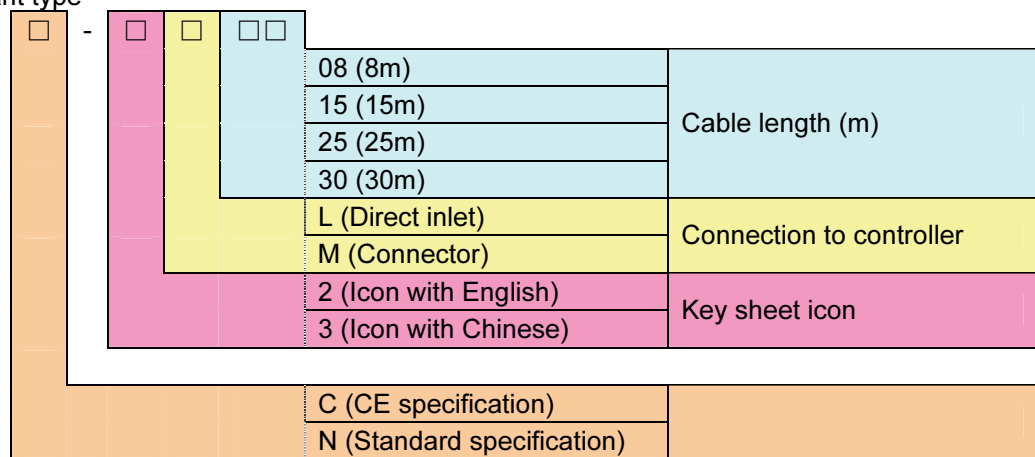

One □ is one alphabetic character or number selected from table.

Wire harness type (Direct inlet)

Type	Specification		Typical applicable robot
A000F-J1-**-A	Standard	For large manipulator 3 wires	SRA series, ST series, MC series (larger than 35kg), MR series (larger than 35kg), etc
A000F-J1-**-A-CE	CE		
A000F-J1-**-B	Standard	For small manipulator 2 wires	MC series (smaller than 20kg), MC10S, MZ12 MR20, etc
A000F-J1-**-B-CE	CE		
Z000F-J1-**-A	Standard / CE Shared	MZ small series	MZ03EL / MZ07 series

(** is cable length ; 05: 5m, 10: 10m, 15: 15m, 20: 20m, 25: 25m)

Wire harness type (Connector)

Type	Specification		Typical applicable robot
HK100X-J1-**-A	Standard	For large manipulator 3 wires	SRA series, ST series, MC series (larger than 35kg), MR series (larger than 35kg), etc
HK100X-J1-**-U	CE		
HK100X-J1-**-UC	UL/CE		
HK100X-J1-**-B	Standard	For small manipulator 2 wires	MC series (smaller than 20kg), MC10S, MZ12 MR20, etc
HK100X-J1-**-UB	CE		
HK100X-J1-**-UCB	UL/CE		

(** is cable length ; 05: 5m, 10: 10m, 15: 15m, 20: 20m, 25: 25m)

NACHI NACHI-FUJIKOSHI CORP.		http://www.nachi-fujikoshi.co.jp/	
Japan Main Office	Phone: +81-3-5568-5245	Fax: +81-3-5568-5236	Shiodome Sumitomo Bldg. 17F, 1-9-2 Higashi-Shinbashi Minato-ku, TOKYO, 105-0021 JAPAN
Nachi Robotic Systems Inc. (NRS)		http://www.nachirobotics.com/	
North America Headquarters	Phone: 248-305-6545	Fax: 248-305-6542	42775 W. 9 Mile Rd. Novi, Michigan 48375, U.S.A
Indiana Service Center	Phone: 248-305-6545	Fax: 248-305-6542	Greenwood, Indiana
Ohio Service Center	Phone: 248-305-6545	Fax: 248-305-6542	Cincinnati, Ohio
South Carolina Service Center	Phone: 248-305-6545	Fax: 248-305-6542	Greenville, South Carolina
Canada Branch Office	Phone: 905-760-9542	Fax: 905-760-9477	89 Courtland Ave., Unit No.2, Concord, Ontario, L4K 3T4, CANADA
Mexico Branch Office	Phone :+52-555312-6556	Fax:+52-55-5312-7248	Urbina No.54, Parque Industrial Naucalpan, Naucalpan de Juarez, Estado de Mexico C.P. 53489, MEXICO
NACHI EUROPE GmbH		http://www.nachi.de/	
Central Office Germany	Phone: +49-2151-65046-0	Fax: +49-2151-65046-90	Bischofstrasse 99, 47809, Krefeld, GERMANY
U.K. branch	Phone: +44-0121-423-5000	Fax: +44-0121-421-7520	Unit 3, 92, Kettles Wood Drive, Woodgate Business Park, Birmingham B32 3DB, U.K.
Czech branch	Phone: + 420-255-734-000	Fax: +420-255-734-001	Obchodni 132, 251 01 Cestice, PRAGUE-EAST CZECH REPUBLIC
Turkey branch	Phone: + 90-(0)216-688-4457	Fax: +90-(0)216-688-4458	Ataturk Mah. Mustafa Kemal Cad. No:10/1A 34758 Atasehir / Istanbul - TURKEY
NACHI AUSTRALIA PTY. LTD.		http://www.nachi.com.au/	
Robotic Division & Victoria office	Phone: +61-(0)3-9796-4144	Fax: +61-(0)3-9796-3899	38, Melverton Drive, Hallam, Victoria 3803, , AUSTRALIA
Sydney office	Phone: +61-(0)2-9898-1511	Fax: +61-(0)2-9898-1678	Unit 1, 23-29 South Street, Rydalmere, N.S.W, 2116, AUSTRALIA
Brisbane office	Phone: +61-(0)7-3272-4714	Fax: +61-(0)7-3272-5324	7/96 Gardens Dr,Willawong,QLD 4110, , AUSTRALIA
NACHI SHANGHAI CO., LTD.		http://www.nachi.com.cn/	
Shanghai office	Phone: +86-(0)21-6915-2200	Fax: +86-(0)21-6915-2200	11F Royal Wealth Centre, No.7 Lane 98 Danba Road Putuo District, Shanghai 200062, China
NACHI KOREA		http://www.nachi-korea.co.kr/	
Seoul office	Phone: +82-(0)2-469-2254	Fax: +82-(0)2-469-2264	2F Dongsan Bldg. 276-4, Sungsu 2GA-3DONG, Sungdong-ku, Seoul 133-123, KOREA

Copyright NACHI-FUJIKOSHI CORP.

Robot Division

1-1-1, FUJIKOSHIHONMACHI, TOYAMA CITY, JAPAN 930-8511

Phone +81-76-423-5137

Fax +81-76-493-5252

NACHI-FUJIKOSHI CORP. holds all rights of this document. No part of this manual may be photocopied or reproduced in any form without prior written consent from NACHI-FUJIKOSHI CORP. Contents of this document may be modified without notice. Any missing page or erratic pagination in this document will be replaced.

In case that an end user uses this product for military purpose or production of weapon, this product may be liable for the subject of export restriction stipulated in the Foreign Exchange and Foreign Trade Control Law. Please go through careful investigation and necessary formalities for export.

Original manual is written in Japanese.

NACHI-FUJIKOSHI CORP. ©