

SIEMENS

SIMATIC HMI

HMI devices Unified Comfort Panels

Operating Instructions



Preface

Overview

1

Safety instructions

2

Mounting and connecting the device

3

Operating the device

4

Operating the Control Panel

5

Transferring data

6

Device maintenance and repair

7

Technical information

8

Technical Support

A

Markings and symbols

B

Abbreviations

C

Legal information

Warning notice system

This manual contains notices you have to observe in order to ensure your personal safety, as well as to prevent damage to property. The notices referring to your personal safety are highlighted in the manual by a safety alert symbol, notices referring only to property damage have no safety alert symbol. These notices shown below are graded according to the degree of danger.

DANGER

indicates that death or severe personal injury **will** result if proper precautions are not taken.

WARNING

indicates that death or severe personal injury **may** result if proper precautions are not taken.

CAUTION

indicates that minor personal injury can result if proper precautions are not taken.

NOTICE

indicates that property damage can result if proper precautions are not taken.

If more than one degree of danger is present, the warning notice representing the highest degree of danger will be used. A notice warning of injury to persons with a safety alert symbol may also include a warning relating to property damage.

Qualified Personnel

The product/system described in this documentation may be operated only by **personnel qualified** for the specific task in accordance with the relevant documentation, in particular its warning notices and safety instructions. Qualified personnel are those who, based on their training and experience, are capable of identifying risks and avoiding potential hazards when working with these products/systems.

Proper use of Siemens products

Note the following:

WARNING

Siemens products may only be used for the applications described in the catalog and in the relevant technical documentation. If products and components from other manufacturers are used, these must be recommended or approved by Siemens. Proper transport, storage, installation, assembly, commissioning, operation and maintenance are required to ensure that the products operate safely and without any problems. The permissible ambient conditions must be complied with. The information in the relevant documentation must be observed.

Trademarks

All names identified by ® are registered trademarks of Siemens AG. The remaining trademarks in this publication may be trademarks whose use by third parties for their own purposes could violate the rights of the owner.

Disclaimer of Liability

We have reviewed the contents of this publication to ensure consistency with the hardware and software described. Since variance cannot be precluded entirely, we cannot guarantee full consistency. However, the information in this publication is reviewed regularly and any necessary corrections are included in subsequent editions.

Preface

Purpose of the operating instructions

These operating instructions contain information based on the requirements for mechanical engineering documentation. This information relates to the location, transport, storage, mounting, use and maintenance.

These operating instructions are intended for:

- Users
- Commissioning engineers
- Maintenance personnel

Observe especially the information in the "Safety instructions" (Page 21) section.

You can find more information in the TIA Portal Information System.

Basic knowledge required

General knowledge of automation technology and process communication is needed to understand the operating instructions. Knowledge of personal computers and Microsoft operating systems is required.

Scope of the operating instructions

The operating instructions apply to the following HMI devices in conjunction with the SIMATIC WinCC Unified software:

Name	Type	Article number, device with Siemens logo	Article number, device without Siemens logo
MTP700 Unified Comfort	7" device	6AV2128-3GB06-0AX0	6AV2128-3GB36-0AX0
MTP1000 Unified Comfort	10" device	6AV2128-3KB06-0AX0	6AV2128-3KB36-0AX0
MTP1200 Unified Comfort	12" device	6AV2128-3MB06-0AX0	6AV2128-3MB36-0AX0
MTP1500 Unified Comfort	15" device	6AV2128-3QB06-0AX0	6AV2128-3QB36-0AX0
MTP1900 Unified Comfort	19" device	6AV2128-3UB06-0AX0	6AV2128-3UB36-0AX0
MTP2200 Unified Comfort	22" device	6AV2128-3XB06-0AX0	6AV2128-3XB36-0AX0

NOTICE
Manual belongs to the HMI device
This manual belongs to the HMI device and is also required for recommissioning. Store all supplied and supplementary documentation for the entire service life of the HMI device. Provide all stored documents to subsequent owners of the HMI device.

Trademarks

The following designations marked with the symbol ® are registered trademarks of Siemens AG:

- HMI®
- SIMATIC®
- WinCC®

Style conventions

Style Convention	Scope
"Add screen"	<ul style="list-style-type: none">• Terminology that appears in the user interface, for example, dialog box names, tabs, buttons, menu commands• Required input, for example limit values, tag values• Path information
"File > Edit"	Operational sequences, for example, menu commands, shortcut menu commands
<F1>, <Alt+P>	Keyboard operation

Please observe notes labeled as follows:

Note

A note contains important information about the product described in the manual and its use, or a specific section of the manual to which you should pay particular attention.

Naming conventions

This document uses the following naming conventions.

Term	Applies to
Plant	<ul style="list-style-type: none"> • System • Machining center • One or more machines
Comfort HMI device, HMI device, Device	<ul style="list-style-type: none"> • MTP700 Unified Comfort • MTP1000 Unified Comfort • MTP1200 Unified Comfort • MTP1500 Unified Comfort • MTP1900 Unified Comfort • MTP2200 Unified Comfort
WinCC	SIMATIC WinCC Unified V16 or higher

Instead of the full product name, the short product name is also used without the suffix "Unified Comfort", for example:

"MTP700" representative for "MTP700 Unified Comfort"

Figures

This manual contains figures of the described devices. The figures can deviate from the delivered device in detail.

Picture components are marked with black position numbers on a white background:

①, ②, ③, ...

Steps in the figures are identified with white process numbers on a black background according to the sequence in which they have to be executed: ❶, ❷, ❸, ...

Table of contents

	Preface	3
1	Overview.....	11
1.1	Product description	11
1.2	Scope of delivery	13
1.3	Design of the devices.....	14
1.4	Interfaces	15
1.5	Accessories.....	16
1.6	The HMI device in the operating process	18
1.7	Apps and software options	19
2	Safety instructions.....	21
2.1	General safety instructions	21
2.2	Security management for HMI devices.....	23
2.3	Data protection.....	24
2.4	Notes about usage.....	24
2.5	Use in hazardous areas.....	27
3	Mounting and connecting the device	29
3.1	Preparing for installation	29
3.1.1	Checking the delivery.....	29
3.1.2	Checking the operating conditions.....	29
3.1.3	Permitted mounting positions	30
3.1.4	Checking clearances.....	32
3.1.5	Preparing the mounting cutout.....	33
3.2	Mounting the device.....	34
3.2.1	Notes on installation.....	34
3.2.2	Positions of the mounting clips	35
3.2.3	Fastening the built-in device with mounting clips	37
3.3	Installing a strain relief	38
3.4	Connecting the device	40
3.4.1	Notes on connection	40
3.4.2	Connecting the equipotential bonding circuit.....	41
3.4.3	Connecting the power supply	44
3.4.4	Connecting the configuration PC	46
3.4.5	Connecting the controller.....	47
3.4.6	Connecting a USB device.....	49
3.4.7	Connecting a printer.....	51
3.4.8	Switching on, testing and switching off the device	53
3.4.9	Securing the cables	54
3.4.10	Securing cables for use in hazardous areas	55
3.5	Removing the device	56

4	Operating the device	57
4.1	Operator input options	57
4.2	Important notes on touch screen	57
4.3	Supported gestures.....	60
4.3.1	Supported gestures in the Control Panel.....	60
4.3.2	Supported gestures in the runtime project.....	60
4.4	Using the screen keyboard	63
4.4.1	The screen keyboards	63
4.4.2	Control keys on the screen keyboard	66
4.5	Using the taskbar	67
4.6	Commissioning the HMI device	68
4.7	Memory concept and memory cards	69
4.7.1	Memory concept.....	69
4.7.2	Changing the memory card.....	72
5	Operating the Control Panel	75
5.1	Opening the settings	75
5.2	Overview of functions.....	77
5.3	System Properties.....	78
5.3.1	Panel information	78
5.3.2	Display	79
5.3.3	Screensaver	80
5.3.4	Update OS	81
5.3.5	Reboot.....	83
5.3.6	Performance.....	84
5.4	Runtime Properties	85
5.4.1	Automatic runtime start	85
5.4.2	Alarm buffer.....	86
5.5	Network and Internet.....	87
5.5.1	Network settings.....	87
5.5.1.1	Overview	87
5.5.1.2	PN-X1	87
5.5.1.3	PN-X2.....	89
5.5.1.4	General	91
5.5.2	Remote connection	91
5.6	Security	93
5.6.1	User management	93
5.6.2	Certificates	97
5.6.3	Control panel access	99
5.7	External Devices and Input.....	100
5.7.1	Hardware interfaces.....	100
5.8	Language, Region and Formats	101
5.8.1	Date and time.....	101

5.9	Service and Commissioning	103
5.9.1	Transfer	103
5.9.2	Update OS	104
5.9.3	Backup	106
5.9.4	Automatic backup	108
5.9.5	Restore	112
5.9.6	Trace forwarder	114
5.10	Apps	114
5.10.1	SIMATIC Edge	116
5.10.2	Add-ons	117
5.10.3	App Management	119
6	Transferring data	121
6.1	Overview	121
6.2	Operating modes	123
6.3	Data transmission options	124
6.4	Setting the PG/PC interface	124
6.5	Transferring a project with WinCC	125
6.6	Backup and restore	128
6.7	Updating the operating system	131
6.7.1	Overview and important notes	131
6.7.2	Updating the operating system via WinCC	132
6.7.3	Resetting an HMI device to factory settings via ProSave	133
7	Device maintenance and repair	135
7.1	General information on maintenance and servicing	135
7.2	Clean the glass front of the HMI device	135
7.3	Using the maintenance mode	136
7.4	Spare parts and repairs	138
7.5	Recycling and disposal	138
8	Technical information	139
8.1	Software license agreements	139
8.2	Labels, certificates and approvals	139
8.3	Electromagnetic compatibility	144
8.4	Mechanical ambient conditions	146
8.4.1	Storage conditions	146
8.4.2	Operating conditions	146
8.5	Climatic ambient conditions	147
8.5.1	Long-term storage	147
8.5.2	Transport and short-term storage	147
8.5.3	Operating conditions	148
8.5.4	Climate diagram	149
8.6	Information on insulation tests, protection class and degree of protection	149

8.7	Dimension drawings.....	150
8.7.1	Dimension drawings of the MTP700 Unified Comfort.....	150
8.7.2	Dimension drawings of the MTP1000 Unified Comfort.....	151
8.7.3	Dimension drawings of the MTP1200 Unified Comfort.....	152
8.7.4	Dimension drawings of the MTP1500 Unified Comfort.....	153
8.7.5	Dimension drawings of the MTP1900 Unified Comfort.....	154
8.7.6	Dimension drawings of the MTP2200 Unified Comfort.....	155
8.8	Technical specifications	156
8.8.1	MTP700, MTP1000, MTP1200 Unified Comfort.....	156
8.8.2	MTP1500, MTP1900, MTP2200 Unified Comfort.....	158
8.9	Description of the interfaces	160
8.9.1	DC24V X80	160
8.9.2	RS422/485 X20.....	160
8.9.3	PROFINET (LAN) X1	161
8.9.4	PROFINET (LAN) X2	161
8.9.5	USB X61/X62/X63/X64	162
8.10	Communication with controllers	162
8.11	Scope of functions with WinCC.....	163
A	Technical Support.....	167
A.1	Service and support	167
A.2	Troubleshooting	168
A.3	Application examples and FAQs.....	168
A.4	System alarms	169
A.5	Information about the manufacturer.....	169
B	Markings and symbols	171
B.1	Safety-relevant symbols.....	171
C	Abbreviations	173
	Glossary	175

Overview

1.1 Product description

SIMATIC HMI Unified Comfort Panels offer you all the freedom and options you need to implement your innovative operating concepts.

In addition to significantly increased performance, the user benefits from the new possibilities of the panels in conjunction with the SIMATIC WinCC Unified visualization software as well as the functional expandability with apps via the built-in Industrial Edge functionality.

The industrial-grade multi-touch glass front of all devices from 7 to 22" offers convenient operation with an impressive high-quality display.

The most important advantages at a glance:



- Maximum user-friendliness through better legibility as well as more brilliant colors and high contrast of the display, combined with significantly higher ruggedness of the multi-touch technology.
- Integrated functionality for all device sizes from 7 to 22".
- Increased hardware performance as well as higher system limits for significantly larger applications based on a panel-based system than before. High level of IT security to protect the system against hacker attacks through a proprietary operating system.
- Project-specific requirements can be implemented quickly and easily thanks to the integrated Industrial Edge functionality for simple expansion of standard functionality through apps.
- Visualization based on SIMATIC WinCC Unified, the new web-based visualization system in the TIA Portal for scalable solutions from machine-level applications to distributed SCADA solutions.
- All devices are available in standard design with Siemens logo and in neutral design without Siemens logo.

Features of the Unified Comfort Panels

Enclosure	Rugged aluminum die-cast housing
Mounting format	Mounting and operation in landscape and portrait format The respective format must be selected during the configuration of the user interface. The display orientation must also be changed in the Control Panel of the HMI device.
Interfaces	Two PROFINET interfaces: <ul style="list-style-type: none"> • One PROFINET interface with two ports • One Gigabit PROFINET interface with one port Four USB 3.1 interfaces One RS422/485 interface
Display	High-resolution TFT display in widescreen format with 16 million colors Wide viewing angle Dimmable from 10 to 100%.
Operation	Capacitive multi-touch screen
Software	Web browser for displaying Internet pages Viewer for PDF documents Editor for Word and Excel documents and other formats File manager Media Player Runtime software with logging and scripting functionality, system diagnostics for SIMATIC controllers, display of trends (f(x), f(t)), etc.
Data storage	Two slots for memory cards <ul style="list-style-type: none"> • One "data memory card" slot for saving user data • One "system memory card slot" for using the service concept for simplified recommissioning in the event of service. Project data and device settings are updated continuously on the system memory card. No data inconsistency in the event of a power failure. Applies to the HMI device if a SIMATIC SD memory card ≥ 32 GB is inserted.
Controller	The system diagnostics of SIMATIC controllers can be read from the HMI device, which means that no additional programming device is required.

1.2 Scope of delivery

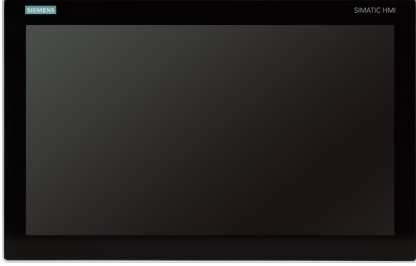
The scope of delivery of the HMI device includes the following components:

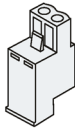
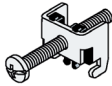
Name	Figure	Quantity	
HMI device		1	
Installation instructions (Quick Install Guide)		1	
Power supply connector		1	
Mounting clips steel, captive		8	MTP700
		12	MTP1000, MTP1200 MTP1500, MTP1900 MTP2200
Strain relief element	Strain relief	1	MTP700 MTP1000 MTP1200
	Plastic strain relief element	3	MTP700 MTP1000 MTP1200
	Strain relief	1	MTP1500 MTP1900 MTP2200

1.3 Design of the devices

This section describes the design of the Unified Comfort Panels, using the MTP1900 Unified Comfort with Siemens logo as an example. The remaining Unified Comfort Panels differ in the size of the front, the interfaces are identical for all Unified Comfort Panels.

Front view and side view



- ① Display and capacitive multi-touch screen
- ② Recesses for mounting clips
- ③ Mounting seal

Bottom view

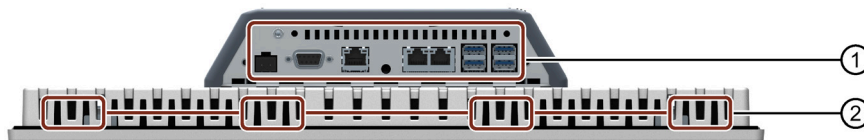

- ① Interfaces, detailed description (Page 15)
- ② Recesses for mounting clips

Rear view

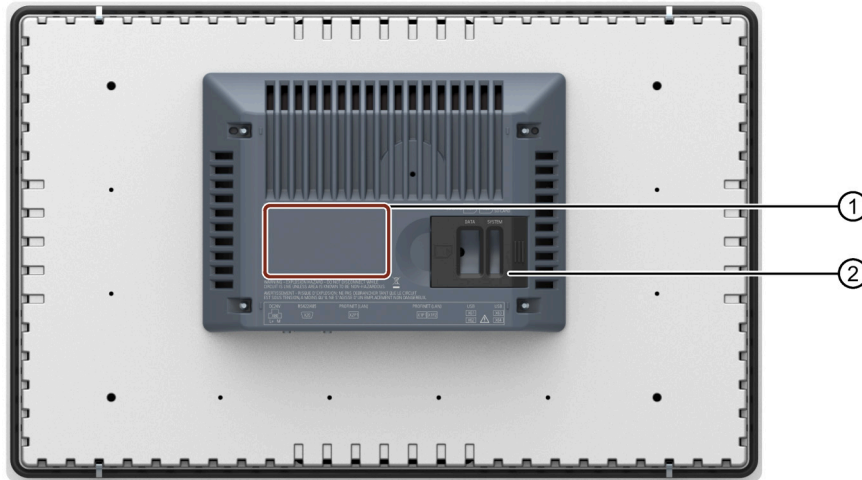

- ① Position of rating plate
- ② Safety lock for the SD memory card slot cover
 - X51: Slot for the data memory card, left
 - X50: Slot for the system memory card, right

For a detailed description, see section "Memory concept and memory cards (Page 69)"

1.4 Interfaces

The figure below shows the interfaces of the Unified Comfort Panels using the interface plate of the devices with display diagonal $\geq 15"$ as an example.

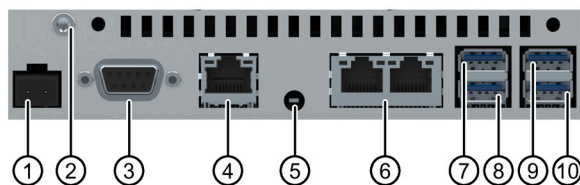

- ① X80 power supply connector
- ② Connection for equipotential bonding (functional grounding)
- ③ X20 RS422/485 (SUB-D)
- ④ X2 PROFINET (LAN), 10/100/1000 Mb
- ⑤ "Maintenance" button
- ⑥ X1 PROFINET (LAN), 10/100 Mbit
- ⑦ X61 USB
- ⑧ X62 USB
- ⑨ X63 USB
- ⑩ X64 USB

For devices with display diagonal $\leq 12"$, there is another threaded hole above the "Maintenance" button for fixing the strain relief plate.

See also

Description of the interfaces (Page 160)

1.5 Accessories

An accessory kit with the necessary accessories is included with the HMI device.

Note

This section contains a selection of accessories that is suitable for your HMI device. You can find additional variants of this selection and the complete accessories portfolio in the Industry Mall on the Internet

(<https://mall.industry.siemens.com/mall/en/WW/Catalog/Products/10144445>). Details such as the delivery quantity and technical specifications of accessories can be found in the Industry Mall under the respective article numbers.

HMI I/O components

Name	Article number
Converter RS 422 to RS 232 for connecting third-party controllers	6AV6671-8XE00-....
90° bracket adapter for RS422/RS485 interface	6AV6671-8XD00-....
Plug for the power supply of the HMI device, 2-pin, screw technology	6AV6671-8XA00-....

"...." stands for the variant key of the article number.

Protective films

Name	Article number
7" front protective film for MTP700 Unified Comfort	6AV6881-0GJ22-....
10" front protective film for MTP1000 Unified Comfort	6AV6881-0KJ22-....
12" front protective film for MTP1200 Unified Comfort	6AV6881-0MJ22-....
15" front protective film for MTP1500 Unified Comfort	6AV6881-0QJ22-....
19" front protective film for MTP1900 Unified Comfort	6AV6881-0UJ22-....
22" front protective film for MTP2200 Unified Comfort	6AV6881-0VJ22-....

"...." stands for the variant key of the article number.

Memory media

Use only the following storage media for the HMI device.

Name	Article number
SIMATIC SD memory card	6AV6881-0AP40-....
SIMATIC HMI USB stick	6AV2181-8AS20-....

"...." stands for the variant key of the article number.

Observe the notes on using the memory media in the section "Memory concept (Page 69)".

Fasteners

Name	Article number
Set with steel mounting clips	6AV6881-6AD10-....
Memory card interlock	6AV2181-4XM00-....

"...." stands for the variant key of the article number.

Input help

Name	Article number
Touch pen system for resistive and capacitive touch systems	6AV2181-8AV20-....

"...." stands for the variant key of the article number.

Additional USB accessories

Additional USB accessories can be found on the Internet in the following entry:
FAQ 19188460 (<https://support.industry.siemens.com/cs/ww/en/view/19188460>)

Other accessories

You can find additional accessories for SIMATIC HMI devices on the Internet at the following link:

Accessories (<https://mall.industry.siemens.com/mall/en/WW/Catalog/Products/10144445>)

1.6 The HMI device in the operating process

The HMI device is part a technical process. The following two phases are key to the way the HMI device is integrated in the process:

- Configuration
- Process management

Configuration

During the configuration phase, you create the user interfaces for operating and monitoring of the technical process on a configuration PC with WinCC. Project design comprises:

- Creating project data
- Saving project data
- Testing project data
- Simulating project data

Transfer

After compiling the configuration, you download the project to the HMI device.

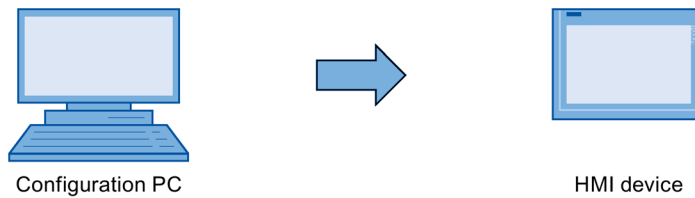

Process management

Process management is marked by two-way communication between HMI device and controller.

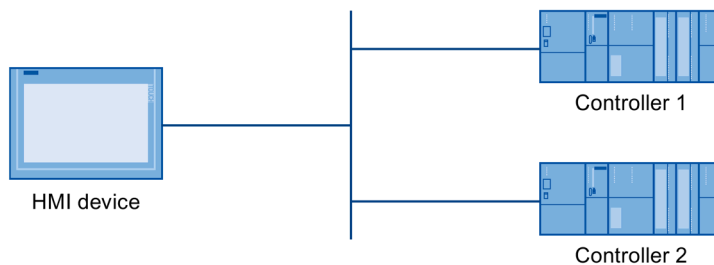

You then use the HMI device to operate and monitor the process.

1.7 Apps and software options

SIMATIC Apps

Under "SIMATIC Apps" you will find apps developed by Siemens especially for the HMI device.

SIMATIC app	Description
SIMATIC Edge	Via "SIMATIC Edge" you start the local edge management web page on the HMI device.

Add-ons

Under "Add-ons" you can find apps that were not developed by Siemens. The following apps are pre-installed license-free on the HMI device:

App	Description
Doc Viewer	With the "Doc Viewer" you can view and edit documents such as text or Word files.
E-Mail Client	With the "E-Mail Client" you can connect to your e-mail accounts, receive e-mails, send e-mails and import mail files from other applications.
File Browser	With the "File Browser" you can display and manage files on the HMI device.
Media Player	You can use the "Media Player" to play audio and video files.
PDF Viewer	You can use the "PDF Viewer" to view PDF documents.
Printer Configuration	You can display and manage pre-installed printers with the "Printer Configuration".
Web Browser	The "Web Browser" provides you with access to the Internet.

Additional information on "SIMATIC Apps", "Add-ons" and the "App Management" is available in the section "Apps (Page 114)".

Software options

In addition to the apps, software options are available for the HMI devices. Options usually have version-independent license keys. The available software options can be found on the Internet (<https://mall.industry.siemens.com/mall/en/en/Catalog/Products/10360581>).

Safety instructions

2.1 General safety instructions

The device is designed for operation in industrial areas for operating and monitoring of plant processes.

Open equipment and the Machinery Directive

 WARNING
<p>The device constitutes open equipment on the back side</p> <p>The device constitutes open equipment on the back side. This means that you must integrate the device in an enclosure or cabinet where the device is operated via its front side. The enclosure or the cabinet must provide protection against electric shock and the spread of fire. The enclosure or the cabinet must meet the requirements for mechanical strength and the degree of protection for the relevant application.</p> <p>Access to the enclosure or cabinet in which the device is installed should only be possible by means of a key or tool and only for qualified personnel.</p> <p>Electrocution risk when control cabinet is open</p> <p>When you open the control cabinet, there may be a dangerous voltage at certain areas or components.</p> <p>Touching these areas or components can cause electrocution.</p> <p>Disconnect the cabinet from the mains before opening it. Do not plug in or pull out plant components during operation.</p> <p>The device must only be used in machines which comply with the Machinery Directive</p> <p>The Machinery Directive specifies precautions to be taken when commissioning and operating machinery within the European Economic Area.</p> <p>Failure to follow these precautions is a breach of the Machinery Directive. Such failure may also cause personal injury and damage depending on the machine operated.</p> <p>The machine in which the HMI device is to be operated must conform to Directive 2006/42/EC.</p>

Observe the safety and accident prevention instructions applicable to your application in addition to the safety instructions given in the device documentation.

Strong high-frequency radiation

NOTICE
Observe immunity to high-frequency radiation
The device has an increased immunity to high frequency radiation according to the specifications on electromagnetic compatibility in the technical specifications.
Radiation exposure in excess of the specified immunity limits can impair device functions and result in malfunctions and therefore injuries or damage.
Observe the information on immunity to high frequency radiation in the technical specifications.

ESD



An electrostatically sensitive device is equipped with electronic components. Due to their design, electronic components are sensitive to overvoltage and thus to the discharge of static electricity. Observe the corresponding regulations when handling ESD.

Industrial Security

Siemens provides products and solutions with industrial security functions that support the secure operation of plants, systems, machines and networks.

In order to protect plants, systems, machines and networks against cyber threats, it is necessary to implement – and continuously maintain – a holistic, state-of-the-art industrial security concept. Siemens' products and solutions constitute one element of such a concept.

Customers are responsible for preventing unauthorized access to their plants, systems, machines and networks. Such systems, machines and components should only be connected to an enterprise network or the internet if and to the extent such a connection is necessary and only when appropriate security measures (e.g. firewalls and/or network segmentation) are in place.

For additional information on industrial security measures that may be implemented, please visit (<http://www.siemens.com/industrialsecurity>).

Siemens' products and solutions undergo continuous development to make them more secure. Siemens strongly recommends that product updates are applied as soon as they are available and that the latest product versions are used. Use of product versions that are no longer supported, and failure to apply latest updates may increase customer's exposure to cyber threats.

To stay informed about product updates, subscribe to the Siemens Industrial Security RSS Feed under (<http://www.siemens.com/industrialsecurity>).

Disclaimer for third-party software updates

This product includes third-party software. Siemens AG only provides a warranty for updates/patches of the third-party software, if these have been distributed as part of a Siemens software update service contract or officially released by Siemens AG. Otherwise, updates/patches are undertaken at your own risk. You can find more information about our Software Update Service offer on the Internet at Software Update Service (<http://www.automation.siemens.com/mcms/automation-software/en/software-update-service>).

Notes on protecting administrator accounts

A user with administrator privileges has extensive access and manipulation options in the system.

Therefore, ensure there are adequate safeguards for protecting the administrator accounts to prevent unauthorized changes. To do this, use secure passwords and a standard user account for normal operation. Other measures, such as the use of security policies, should be applied as needed.

2.2 Security management for HMI devices

Data security

Data from external sources

The HMI device has external interfaces and can be connected to the Internet. Edge management allows you to install apps from any source.

Data from untrusted sources represents a significant security risk.

Customers are responsible for transferring only data from trusted sources to the HMI device and only opening trusted files and web pages on the HMI device.

Entering passwords

If you enter passwords via an external keyboard, they can be logged and passed on unnoticed via a keylogger.

Use only the screen keyboard of the HMI device to input passwords.

Data backup to external data storage media

Data from the HMI device can be saved on USB or SD storage media via the external interfaces.

Customers are responsible for protecting HMI device data stored on external storage media against unauthorized access. For example, use a suitable encryption or password protection for external storage media. Store the external storage media in a safe place.

Additional information

You can find additional information on security management of HMI devices on the Internet at the following address:

Panel Security Guidelines (<https://support.industry.siemens.com/cs/de/en/view/109481300>)

2.3 Data protection

Siemens observes the data protection guidelines, especially the requirements regarding data minimization (privacy by design). This means the following for this SIMATIC product: The product does not process / save any personal information, but only technical functional data (e.g. time stamps). If the user links this data to other data (e.g. shift plans) or if the user saves personal information on the same medium (e.g. hard disk) and therefore creates a personal reference in the process, the user has to ensure meeting the guidelines regarding data protection.

2.4 Notes about usage

NOTICE
The HMI device is approved for indoor use only.
The HMI device may be damaged if it is operated outdoors.
Operate the HMI device indoors only.

Note

Operate the device only in a normal atmospheric environment

The technical characteristics of the device described in the operating instructions are guaranteed if you operate the device in normal ambient air conditions with usual air composition.

Note

The device is intended for operation in an SELV/PELV circuit according to IEC/EN 61131 or IEC/EN 61010-2-201 in a dry environment, which means a dry environment on the rear of the device.

Additional information is available in the section "Operating conditions (Page 148)".

Industrial applications

The HMI device is designed for industrial applications. It conforms to the following standards:

- Requirements for emissions EN 61000-6-4: 2007
- Requirements for interference immunity EN 61000-6-2: 2005

Use in mixed-use zone

Under certain circumstances you can use the HMI device in a mixed-use zone. A mixed-use zone is used for housing and commercial operations that do not have a significant impact on residents.

When you use the HMI device in a mixed-use zone, you must ensure that the limits of the generic standard EN 61000-6-3 regarding emission of radio frequency interference are observed. Suitable measures for achieving these limits for use in a mixed-use zone include:

- Installation of the HMI device in grounded control cabinets
- Use of filters in electrical supply lines

Individual acceptance is required.

Use in residential areas

Note

HMI device not intended for use in residential area

The HMI device is not intended for use in residential areas. Operation of an HMI device in residential areas can have a negative influence on radio or TV reception.

Use with additional measures

The HMI device should not be used at the following locations unless additional measures are taken:

- In locations with a high degree of ionizing radiation
- In locations with severe operating conditions, for example, due to:
 - Corrosive vapors, gases, oils or chemicals
 - Strong electrical or magnetic fields of high intensity
- At locations that require special monitoring, e.g. in:
 - Elevators
 - Highly hazardous areas

TFT displays

NOTICE

Burn-in effect

A permanently displayed two-color or multi-color picture can cause a burn-in effect, i.e. the picture remains dimly visible for a certain period of time. The longer the image is burned in, the longer the image will last. In extreme cases, the image is permanently displayed.

The image outline usually disappears on its own when the screen remains switched off for some time. Screensavers that use active black when the backlight is on reduce the burn-in effect.

- Activate the screensaver (Page 80).

Backlight

The brightness of the backlight decreases incrementally during operational life. You can extend the service life of the display and backlight by taking the following measures:

- Reduce the backlight (Page 79).
- Observe the operating hours of the backlight, see section "Technical specifications (Page 156)".

2.5 Use in hazardous areas

The following warnings apply to operating a device with Ex approval in hazardous areas.

 WARNING
Explosion Hazard Do not disconnect while circuit is live unless area is known to be non-hazardous. Substitution of components may impair suitability for Class I, Division 2 or Zone 2.
Risque d'Explosion Ne pas déconnecter pendant que le circuit est sous tension, sauf si la zone est non-dangereuse. Le remplacement de composants peut compromettre leur capacité à satisfaire à la Classe I, Division 2 ou Zone 2.

 WARNING
Do not plug or pull connectors in potentially explosive atmospheres When you plug or pull the plug-in connector during operation, there is a risk of a flashover. A flashover can cause an explosion in a hazardous area, resulting in death or severe injuries. Plugging or pulling of plug-in connectors, for example, of a 24 V DC power supply connector or even of a memory card, is prohibited in a hazardous area. Do not plug or pull a connector or a memory card until one of the two following requirements is met: The area is no longer hazardous or the device and its plug-in connections are de-energized. To shut down the device, close all open apps and the running project, and turn off the power to the device.

Also observe the enclosed documentation on using in potentially explosive areas and the information on the Ex approval in section "Labels, certificates and approvals (Page 139)".

Mounting and connecting the device

3.1 Preparing for installation

3.1.1 Checking the delivery

Check the package content for visible signs of transport damage and for completeness.

Note**Damaged parts**

A damaged part will cause the HMI device to malfunction.

Do not install parts damaged during shipment. In the case of damaged parts, contact your Siemens representative.

Check the scope of delivery of the HMI device, see section "Scope of delivery (Page 13)".

Additional documents may be included in the scope of delivery.

The documentation is part of the HMI device and is required for subsequent commissioning. Keep all enclosed documentation for the entire service life of the HMI device. You must pass along the enclosed documentation to any subsequent owner or user of the HMI device. Make sure that every supplement to the documentation that you receive is stored together with the operating instructions.

3.1.2 Checking the operating conditions

Observe the following aspects before installing the HMI device:

1. Familiarize yourself with the standards, approvals, EMC parameters and technical specifications for operation of the HMI device. This information is available in the following sections:
 - "Labels, certificates and approvals (Page 139)"
 - "Electromagnetic compatibility (Page 144)"
2. Check the mechanical and climatic ambient conditions for operation of the HMI device according to the following sections:
 - " Mechanical ambient conditions (Page 146)"
 - " Climatic ambient conditions (Page 147)"
3. Observe the notes on the local use of the HMI device in section "Notes about usage (Page 24)".
4. Observe the permissible rated current: +24 V DC

3.1.3 Permitted mounting positions

The HMI device is suitable for installation in:

- Mounting cabinets
- Control cabinets
- Switchboards
- Consoles

In the following, all of these mounting options are referred to by the general term "cabinet".

The device is self-ventilated and approved for inclined mounting at angles up to +/-35° from the vertical.

NOTICE
Damage due to overheating
An inclined installation reduces the convection by the HMI device and therefore the maximum permitted ambient temperature for operation.
If there is sufficient convection from forced ventilation, the HMI device can also be operated in the inclined mounting position up to the maximum permitted ambient temperature for vertical mounting. The HMI device may otherwise be damaged and its certifications and warranty will be void.
The working temperature ranges listed in this section apply to the rear and the front of the HMI device.

For detailed information regarding the permitted ambient temperatures, refer to section "Climatic ambient conditions (Page 147)".

Mounting position

Select one of the permitted mounting positions for your HMI device. The approved mounting positions are described in the following sections using the MTP1900 Unified Comfort HMI device as an example.

Mounting in landscape format

All Unified Comfort HMI devices are suitable for installation in landscape format.

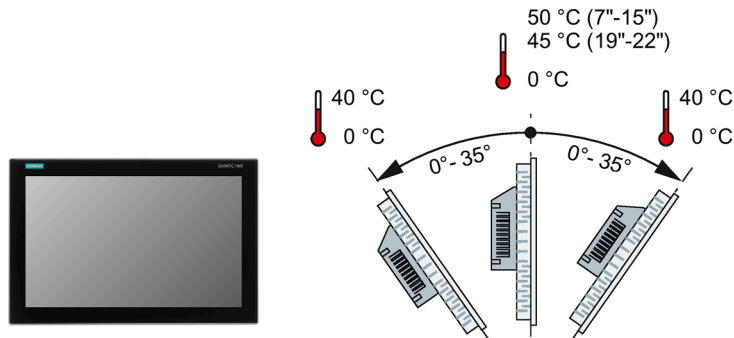

Mounting in portrait format

All Unified Comfort HMI devices are suitable for installation in portrait format. Select the appropriate screen format during configuration.

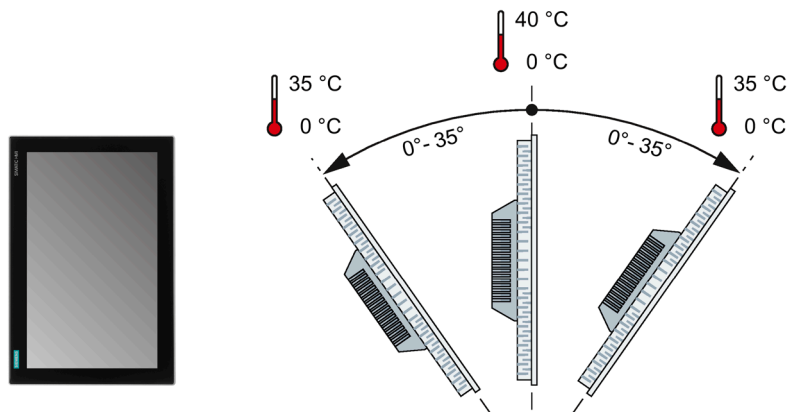

See also

Climate diagram (Page 149)

3.1.4 Checking clearances

The following clearances are required around the HMI device to ensure sufficient self-ventilation:

- At least 15 mm to both the right and left of the mounting cutout (in x direction) to allow for insertion of the mounting clips during installation
- At least 50 mm above and 50 mm below the mounting cutout (in the y direction) for ventilation
- At least 10 mm behind the rear panel of the HMI device (in the z direction)

The following figure shows the clearances for mounting the HMI devices in landscape format and portrait format using MTP1900 Unified Comfort as an example:

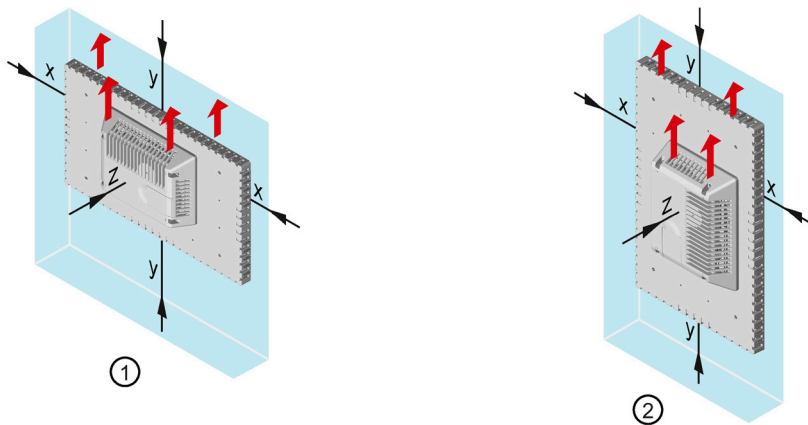

① Clearance for mounting in landscape format

② Clearance for mounting in portrait format

x At least 15 mm distance

y At least 50 mm distance

z At least 10 mm distance

Note

Ensure that the maximum ambient temperature is not exceeded when mounting the device in a cabinet and especially in a closed enclosure.

3.1.5 Preparing the mounting cutout

Note

Stability of the mounting cutout

The material in the area of the mounting cutout must provide sufficient strength to guarantee lasting and safe mounting of the HMI device.

To achieve the degrees of protection described below, it must be ensured that deformation of the material cannot occur due to the force of the mounting clips or operation of the device.

Degrees of protection

The degrees of protection of the HMI device can only be guaranteed if the following requirements are met:

- Material thickness at the mounting cutout for a degree of protection IP65 or Front face only Type 4X/Type 12 (indoor use only): 2 mm to 6 mm
- Permitted deviation from plane at the mounting cutout: ≤ 0.5 mm
This condition must be met for the mounted HMI device.
- Permissible surface roughness in the area of the seal: ≤ 120 μm (R_z 120)

Compatibility of the mounting cutout to other HMI devices

The Unified Comfort HMI devices are mounting-compatible with standard SIMATIC Industrial PCs, Industrial Flat Panels and Industrial Thin Clients with identical display diagonals.

Please note that although the dimensions for the mounting cutout are the same, the device depth of the Unified Comfort HMI devices may differ from that of compatible devices.

In addition, the following installation compatibility with the predecessor devices applies:

HMI device	Mounting cutout compatible with
MTP700 Unified Comfort	TP700 Comfort
MTP1200 Unified Comfort	TP1200 Comfort

For Unified Comfort HMI devices with display diagonal ≥ 15 ", adapter frames are available for mounting in the mounting cutout of a Comfort HMI device with the corresponding display diagonal, see section "Accessories (Page 16)".

Dimensions of the mounting cutout

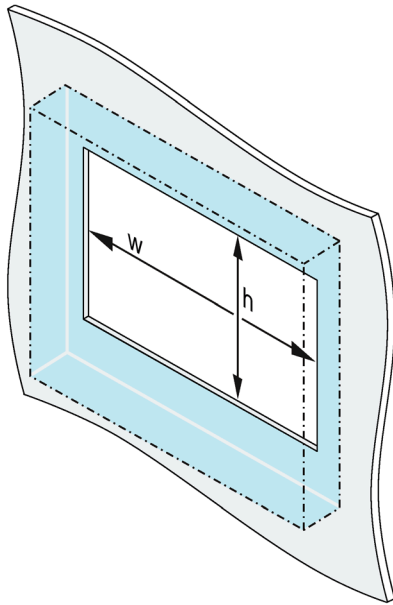

	w_0^{+1}	x	h_0^{+1}
MTP700	197	x	141 mm
MTP1000	264	x	189 mm
MTP1200	310	x	221 mm
MTP1500	382	x	241 mm
MTP1900	448	x	278 mm
MTP2200	513	x	315 mm

Width and height should be reversed accordingly when mounting in portrait format.

3.2 Mounting the device

3.2.1 Notes on installation

Before installing the device, please ensure that the installation location complies with the following:

NOTICE
Use according to IEC 61010-2-201 requires an appropriate enclosure
The rear of the built-in device is classified as "Open Equipment" according to IEC 61010-2-201 for use in industrial control equipment.
For approval and operation according to IEC 61010-2-201, the device must be installed in an enclosure or integrated in a cabinet. The enclosure or the cabinet must provide protection against electric shock and the spread of fire. The enclosure or the cabinet must meet the requirements for mechanical strength and the degree of protection for the relevant application.

- Position the device so that it is not exposed to direct sunlight.
- Position the device so that it is easily accessible for the operator. Choose a suitable installation height.
- Ensure that the air vents of the device are not covered as a result of installation.
- Observe the permitted mounting positions (Page 30).

3.2.2 Positions of the mounting clips

You fasten the built-in devices with the mounting clips from the accessory pack, which are also available as accessories (Page 16).

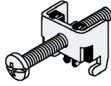

For the 7" device MTP700 Unified Comfort you need 7 mounting clips, for all other devices 12 mounting clips.

To achieve degree of protection IP65 for the respective device, the mounting clips must be installed at the positions shown below.

Device	Positions of the mounting clips
7" device	
10" device	
12" device	

3.2 Mounting the device

Device	Positions of the mounting clips
15" devices	
19" devices	
22" devices	

3.2.3 Fastening the built-in device with mounting clips

Requirement

- All packaging components and protective films have been removed from the device.
- The following material and tools are available:
 - The mounting clips from the accessory kit
 - One torque screwdriver with cross-tip insert, size 2

Procedure

Note

If the mounting seal is damaged, the degree of protection is not guaranteed.

1. Insert the device into the mounting cutout from the front.

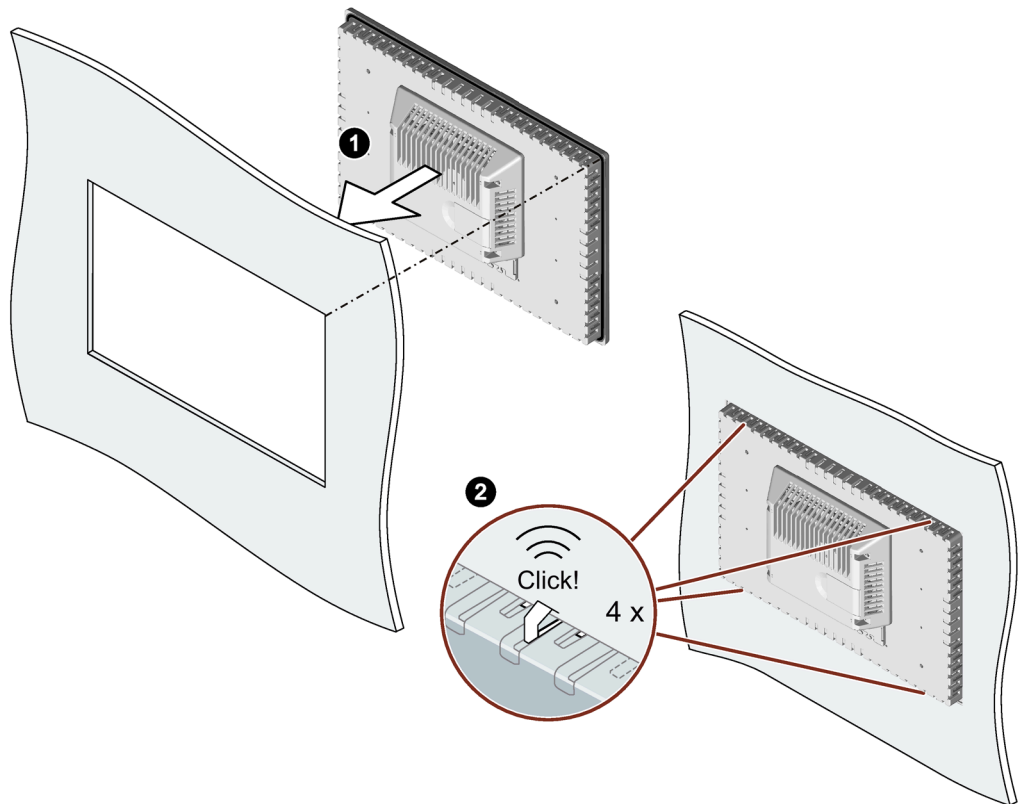

2. Make sure that all four spring locks on the top and bottom of the device fully engage. If necessary, gently press the device into the recess if it is not fully engaged.

3.3 Installing a strain relief

3. Insert a mounting clip into the cutout provided on the device. Make sure it is in the correct position; see the section "Positions of the mounting clips (Page 35)".

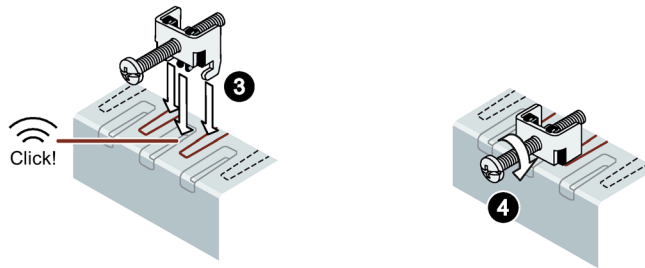

4. To secure the mounting clip, tighten the grub screw with the slot screwdriver, torque 0.5 Nm.
5. Repeat step 3 and 4 for all mounting clamps until all clamps are fastened.
6. Check the fit of the mounting seal.

3.3 Installing a strain relief

The device's scope of delivery includes a strain relief plate with the required number of fixing screws.

Note

If the strain relief plate of devices with display diagonal $\leq 12''$ is mounted, then the strain relief plate projects beyond the outer dimensions of the device. Screw on the strain relief plate of the devices with display diagonal $\leq 12''$ only after the device has been installed.

The strain relief plate of the devices with display diagonal $\geq 15''$ can be screwed on before or after the device has been installed.

Requirement

For mounting of the strain relief plate you need:

- The strain relief plate from the scope of delivery
- The supplied fixing screws
- A torque screwdriver with T20 insert

HMI devices with display diagonal $\leq 12"$

Fasten the strain relief plate to the device with a torque of 0.8 Nm using the two screws supplied.

The figure below shows the installation using the MTP700 Unified Comfort HMI device as an example.

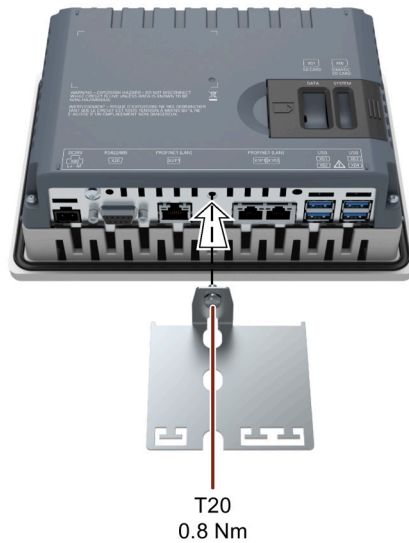

HMI devices with display diagonal $\geq 15"$

Fasten the strain relief plate to the device with a torque of 0.8 Nm using the two screws supplied.

The figure below shows the installation using the MTP1900 Unified Comfort HMI device as an example.

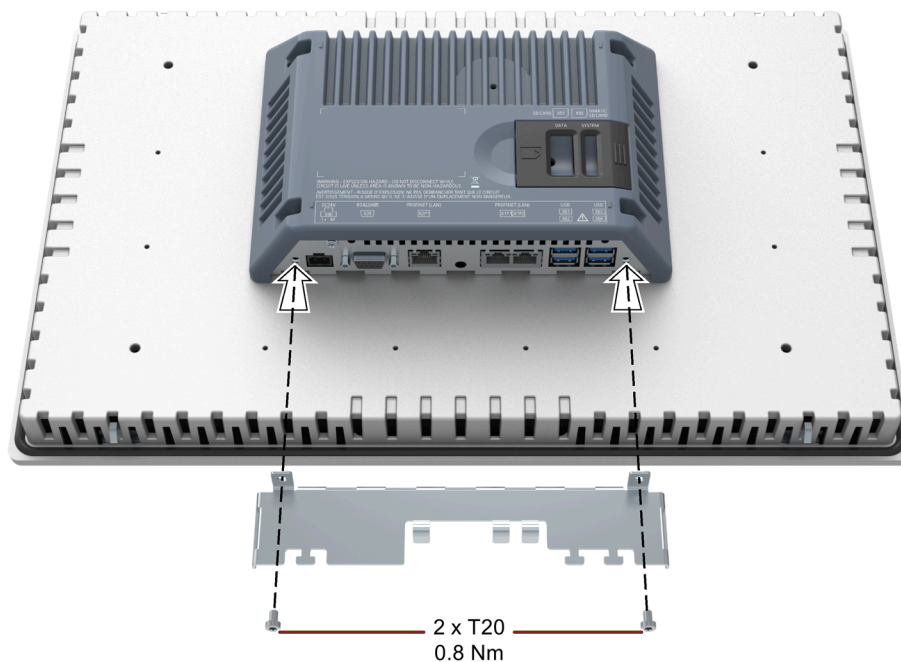

3.4 Connecting the device

3.4.1 Notes on connection

Requirement

- The HMI device must be mounted according to the specifications of these operating instructions.

Connecting cables

Note

Use copper cables on connectors with terminal connections

Use copper (Cu) cables for all supply lines that are connected to the device with terminals, e.g. 24 V DC power supply cables on the 24 V DC power supply connector.

Use only shielded standard cables as data connecting cables, order information is available in the Industry Mall (<https://mall.industry.siemens.com>).

Connection sequence

NOTICE
Damage to the HMI device
If you do not keep to the connection sequence you could damage the HMI device.
It is crucial that you connect the HMI device in the following order:

1. Equipotential bonding
2. Power supply
Perform a power-up test to ensure the power supply is connected with the correct polarity.
3. Controller
4. Configuration PC if needed
5. I/Os if needed

Disconnect the HMI device by completing the above steps in reverse order.

Connecting the cables

NOTICE

Observe local installation regulations

Observe the local installation regulations and the local installation conditions, such as protective wiring for power supply lines, when connecting the cables.

Short-circuit and overload protection

Different measures for short-circuit and overload protection are required when setting up an entire plant. The type of components and the level of obligation for the protective measures depends on the regulation that applies to your plant configuration.

- When connecting the cables, make sure that you do not bend the contact pins.
- Secure the cable connectors by fastening the connector to the socket with screws.
- Provide adequate strain relief for all connecting cables.
- The pin assignment of the ports is described in the technical specifications.

3.4.2 Connecting the equipotential bonding circuit

Differences in electrical potential

Differences in electrical potential can develop between spatially separate plant components. Such electrical potential differences can lead to high equalizing currents across the data cables and therefore to the destruction of their interfaces. Equalizing currents can develop if the cable shielding is terminated at both ends and grounded to different plant components.

Differences in potential may develop when a system is connected to different mains supplies.

General requirements for equipotential bonding

Differences in potential must be reduced by means of equipotential bonding in order to ensure trouble-free operation of the relevant components of the electronic system. The following must therefore be observed when installing the equipotential bonding circuit:

- The effectiveness of equipotential bonding increases as the impedance of the equipotential bonding conductor decreases or as its cross-section increases.
- If two plant components are interconnected by means of shielded data cables and their shielding is bonded at both ends to the grounding/protective conductor, the impedance of the additionally installed equipotential bonding cable must not exceed 10% of the shielding impedance.
- The cross-section of an equipotential bonding conductor must be capable of handling the maximum equalizing current. Equipotential bonding cables are required between two control cabinets with a minimum conductor cross-section of 16 mm².
- Use equipotential bonding conductors made of copper or galvanized steel. Establish a large surface contact between the equipotential bonding conductors and the grounding/protective conductor and protect them from corrosion.
- Clamp the shield of the data cable from the HMI device flush at the equipotential bonding rail using suitable cable clamps. The equipotential bonding rail should be as close to the HMI device as possible.
- Route the equipotential bonding conductor and data cables in parallel and with minimum clearance in between.

Note

Equipotential bonding cable

Cable shields are not suitable for equipotential bonding. Always use the prescribed equipotential bonding conductors for this. An equipotential bonding conductor between control cabinets must have a minimum cross-section of 16 mm². The cable between the ground bar and HMI device must have a minimum cross-section of 4 mm².

Wiring diagram

The following figure shows the connection of the equipotential bonding using the MTP1900 Unified Comfort as an example and similarly applies to the other Unified Comfort HMI devices.

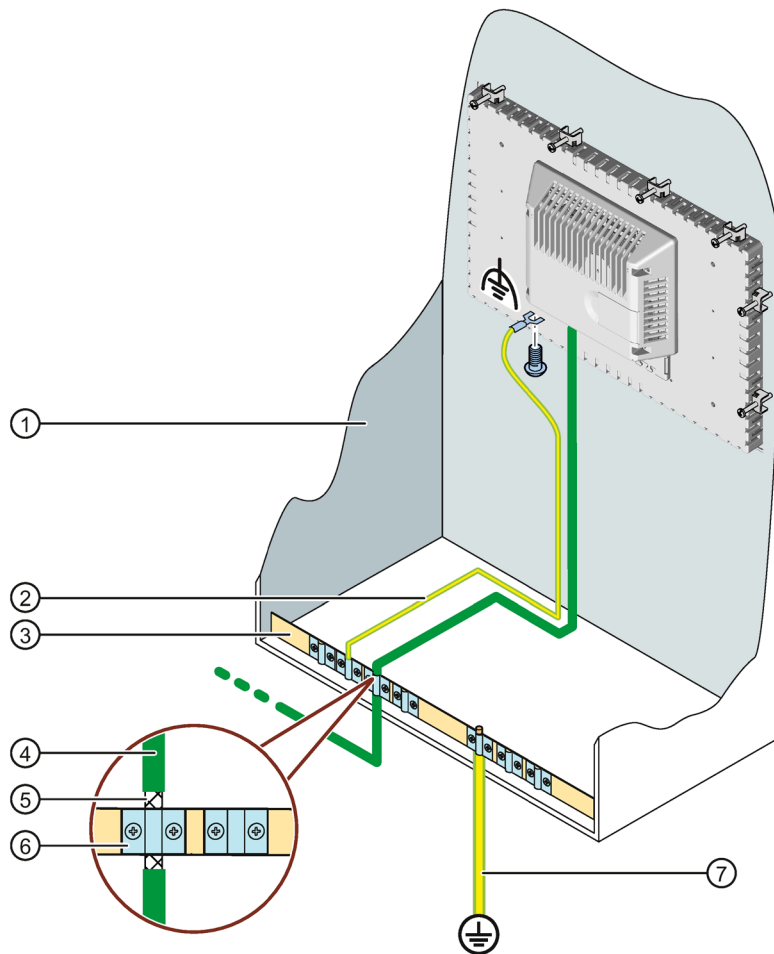

- ① Control cabinet
- ② Equipotential bonding cable, 4 mm²
- ③ Equipotential busbar for equipotential bonding cables, grounding connection and shield support of the data cables
- ④ PROFINET data cable
- ⑤ Shield of the PROFINET data cable, connected to the equipotential busbar
- ⑥ Cable clip
- ⑦ Ground bar, 16 mm²

3.4.3 Connecting the power supply

NOTICE

Safe electrical isolation

For the 24 V DC supply, only use power supply units with safe electrical isolation according to IEC 61010-2-201, e.g. according to the SELV/PELV standard.

The supply voltage must be within the specified voltage range. Otherwise, malfunctions at the HMI device cannot be ruled out.

The following applies for a non-isolated system design: Connect the GND 24 V connection from the 24 V power supply output to equipotential bonding for uniform reference potential. You should always select a central point of termination.

NOTICE

External protective circuit

An external protective circuit is required for operation with 24 V DC, see section 7 "Lightning protection and overvoltage protection" in function manual "Designing interference-free controllers (<https://support.industry.siemens.com/cs/ww/en/view/59193566>)".

Wiring diagram

The following figure shows the connection between the power supply and the HMI device with the Unified Comfort Panel with display diagonal $\geq 15"$ as an example.

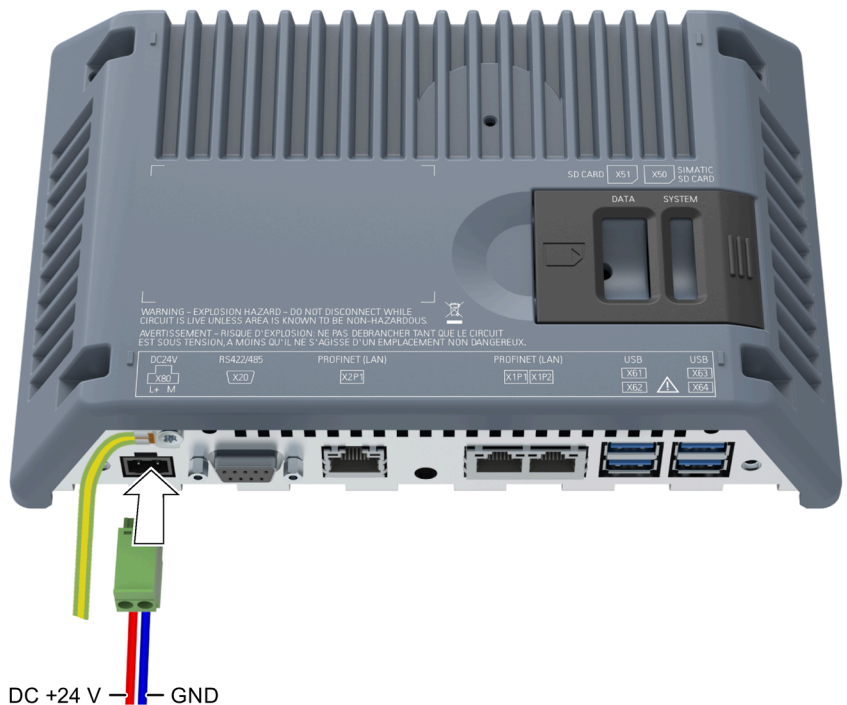

Note when connecting

The power supply connector is contained in the accessory kit. The power supply connector is designed for cables with a maximum cross-section of 1.5 mm².

Connecting the power supply connector

NOTICE
Do not damage the socket
Do not tighten the screws of the power supply connector when it is plugged into the HMI device. The pressure from the screwdriver could damage the HMI device socket.
Connect the power supply cables when the power supply connector is unplugged from the HMI device.

1. Switch off the power supply.
2. Connect the power supply cables to the power supply connector as shown in the above figure.
3. Connect the power supply connector to the corresponding socket of the HMI device as shown in the above figure. Check the correct polarity of the cables using the interface marking on the back of the HMI device.

Reverse polarity protection

The HMI device comes with electronic reverse polarity protection which prevents the device from being damaged in case the power supply cables are connected incorrectly.

3.4.4 Connecting the configuration PC

Wiring diagram

The following figure shows how to connect the HMI device to a configuration PC with a Unified Comfort Panel with display diagonal $\geq 15"$ as an example.

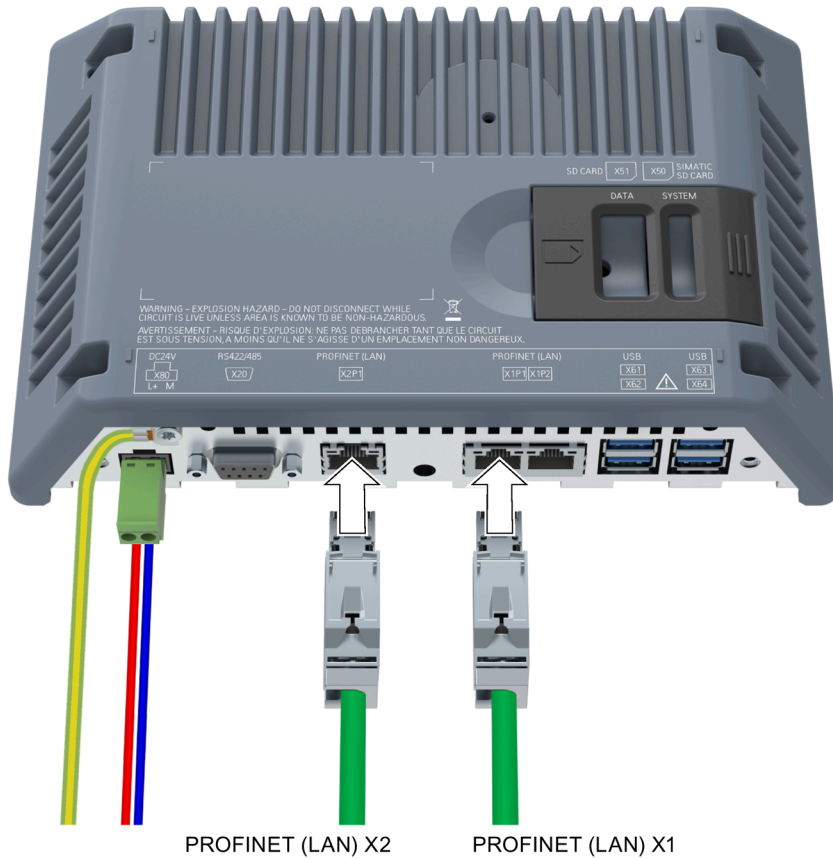

Procedure

Proceed as follows:

1. Switch off the HMI device.
2. Switch on the configuration PC.
3. Connect the HMI device to the configuration PC via the X1 or X2 interface.

Note

The technology on which the X2 is based allows a higher data transfer rate than the X1 interface.

4. Switch on the HMI device.

Result

The configuration PC and HMI device are connected. In the connection, assign an IP address to the HMI device.

Note

Updating the operating system

If there is no serviceable HMI device image on the HMI device, you can only update the operating system by restoring the factory settings via one of the two PROFINET (LAN) interfaces.

Connecting multiple HMI devices in succession

If you connect more than one HMI device with the same IP address in succession to a single configuration PC, you need to ping the configuration PC once from the HMI device on each changeover of the HMI device.

3.4.5 Connecting the controller

Wiring diagram

The following figure shows how to connect the HMI device to a controller with a Unified Comfort Panel with display diagonal $\geq 15"$ as an example.

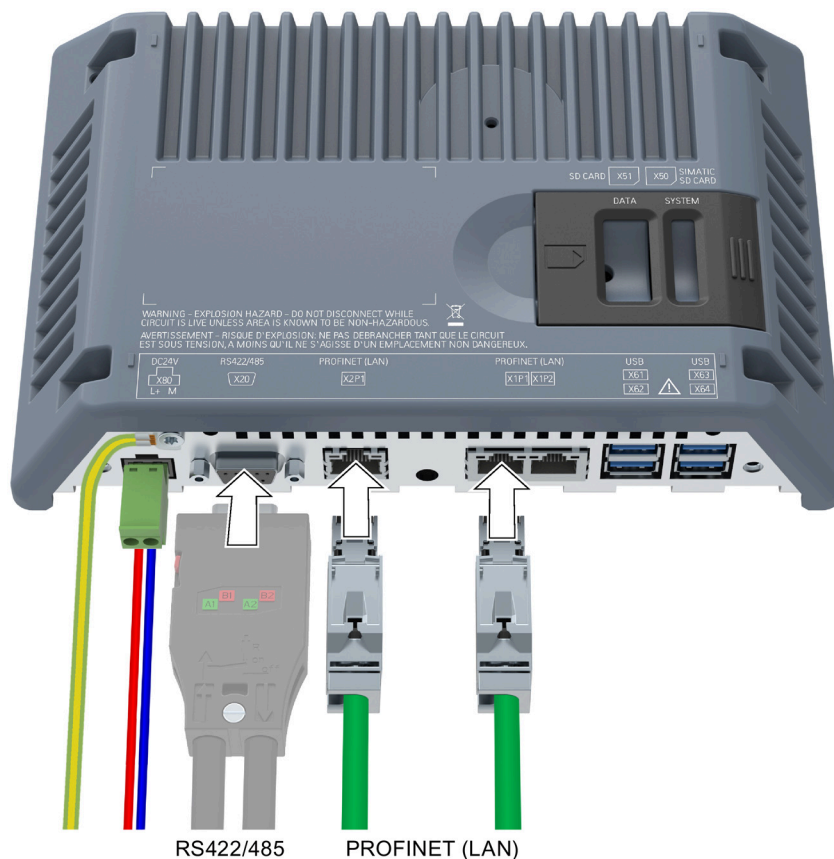

3.4 Connecting the device

Use the PROFINET (LAN) X1 or X2 interface for SIMATIC process connection. Only use the RS 422/485 interface for controllers from other manufacturers that are connected in conjunction with a CSP on the serial interface. Additional information on compatible controllers is available in the section "Communication with controllers (Page 162)".

Note

Use approved cables only

If you do not use approved cables to connect a SIMATIC S7 controller, you may experience malfunctions.

Use only approved cables to connect a SIMATIC S7 controller.

Use only straight connectors

Use only straight cables whenever possible to connect a controller. Bent connectors can cover adjacent interfaces.

Standard cables are available for the connection. You can find order information in the Industry Mall (<https://mall.industry.siemens.com>).

PROFINET

Note

Observe the instructions regarding the installation of PROFINET networks, in the "PROFINET System Description (<https://support.industry.siemens.com/cs/ww/en/view/19292127>)" manual.

The HMI device has an internal switch. You can set up a ring topology, for example, with the HMI device without an external switch. Use the interface X1 to set up a ring topology.

3.4.6 Connecting a USB device

Below are examples of industrial grade devices you can connect to the USB type A interfaces of the HMI device:

- External mouse
- External keyboard
- Printer
- USB stick
- Industrial USB Hub 4, article number 6AV6671-3AH00-0AX0
- Mobile handheld reader ("Barcode Scanner"), article number 6GF3320-0HT01 or 6GF3340-0HT01

Note

USB cable length maximum 1.5 m

USB cables with lengths of more than 1.5 m do not ensure secure data transfer.

The cable may not be longer than 1.5 m.

USB devices with a separate power supply

If you connect an external device with a 230 V power supply to the USB port in a plant that is electrically isolated, you might experience functional problems.

Use a non-isolated plant installation.

Excessive rated load of the USB interface

A USB device with too high a power load may possibly cause functional problems.

Observe the values for the maximum load rating of the USB interface, see section "Technical specifications (Page 156)".

Potential loss of data

If the HMI device accesses its data when a USB storage medium is removed, the data on the storage medium cannot be fully read or written, or it may even be destroyed.

If your process requires you to change the USB storage medium during operation, you need to take this into account by employing suitable mechanisms in the configuration.

Do not remove the USB storage medium during operation while data is being accessed.

Formatting of USB sticks

The following file systems are supported for USB sticks:

- NTFS
- FAT32

We recommend using the "NTFS" formatting method which offers greater data consistency and flexibility regarding the size of the saved files.

Connection diagram

The following figure shows the example of a Unified Comfort Panel with a screen diagonal $\geq 15"$ as you connect a USB device.

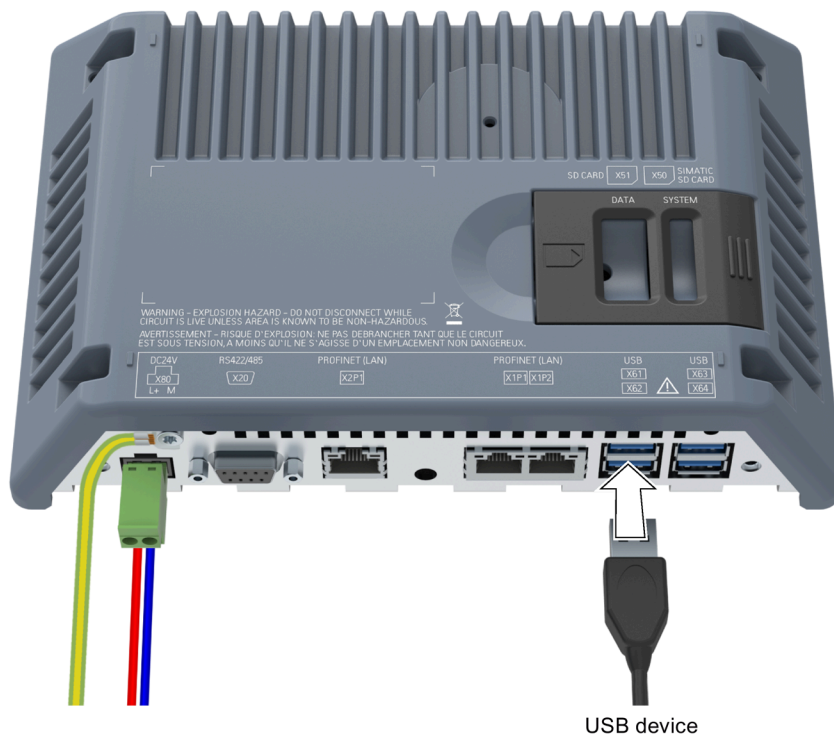

3.4.7 Connecting a printer

Wiring diagram

The following figure shows how to connect the HMI device to a printer with a Unified Comfort Panel with display diagonal $\geq 15"$ as an example.

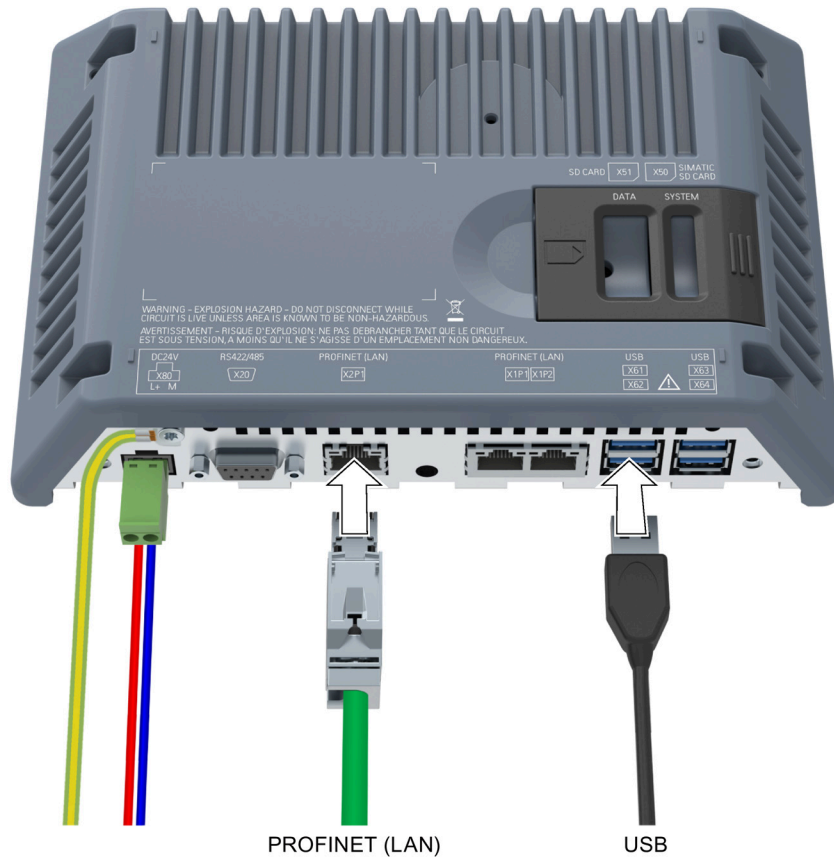

Note when connecting

Note

Cables for data exchange

If you use cables without a metallic netting shield between the HMI device and printer, you may experience functional problems.

Use cables with metal-braided shielding grounded at both ends only for connecting the HMI device and the printer.

Note

Some printers may require that you also set the ASCII character set used in the project on the printer.

Observe the supplied printer documentation when you connect the printer.

Managing printers

The printer settings of the HMI device are managed via the local web page "CUPS" (Common Unix Printing System) under "localhost:631".

To open the printer administration, proceed as follows:

1. Open the printer administration in the Control Panel under "Apps" > "Printer Configuration"> "Start".

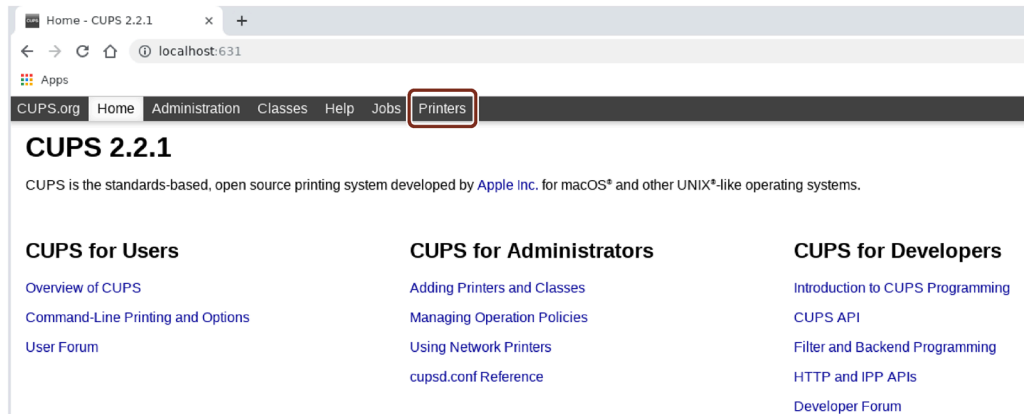

2. Select "Printers."

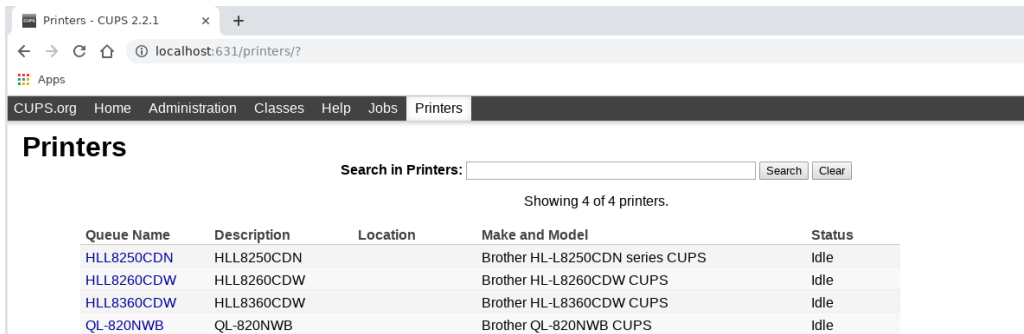

The "Printers" page shows the pre-installed printers. To change the settings of a printer, delete the printer or display the print jobs, click on the printer name in the "Queue Name" column.

3.4.8 Switching on, testing and switching off the device

Switch on the HMI device

1. Switch on the power supply. The display lights up.

If the HMI device fails to start after a longer period, you may have crossed the cables on the power supply connector. Check the connected cables and correct the polarity if necessary.

If a project is available on the HMI device, then the project is started after the defined delay time.

If there is no project on the HMI device, the Control Panel is displayed.

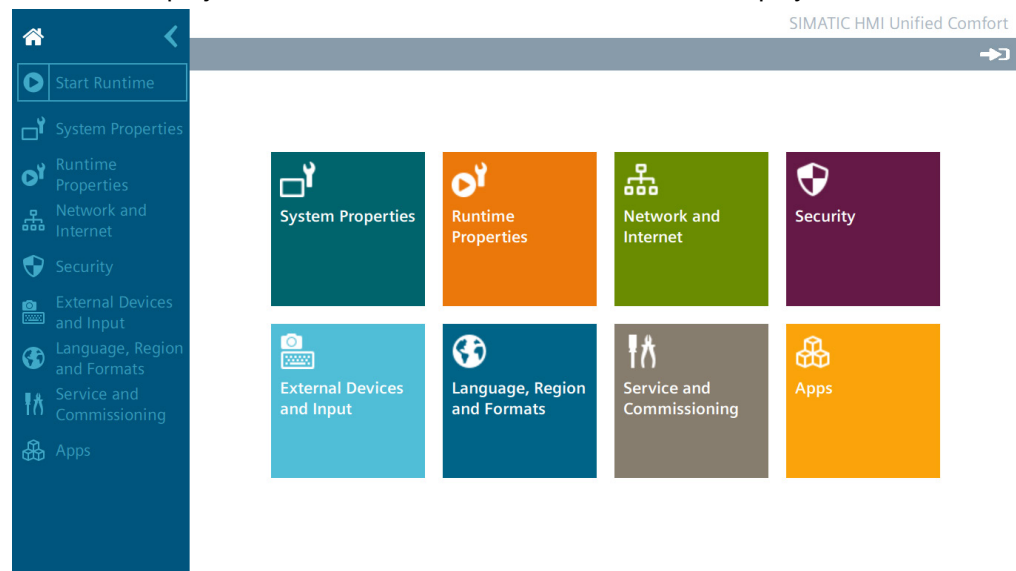

2. If desired, operate the project or configure the HMI device via the Control Panel.
If you no longer need the HMI device, switch it off.

Switching off the HMI device

1. Close the project on the HMI device.
2. Switch off the power supply.

3.4.9 Securing the cables

After the power-up test, secure the connected cables with a strain relief.

Requirement

The strain relief plate is mounted, see section "Installing a strain relief (Page 38)".

HMI devices with display diagonal $\leq 12"$

For devices with $\leq 12"$ display diagonal, secure the cables to the strain relief plate and to the plastic strain relief elements supplied.

The following figures use the MTP700 Unified Comfort as an example to show how to install the plastic strain relief elements.

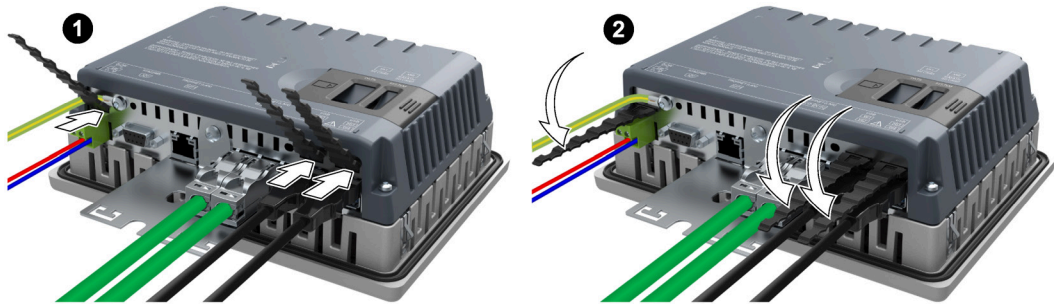

Next, use cable ties to secure the cables to the marked fixing elements.

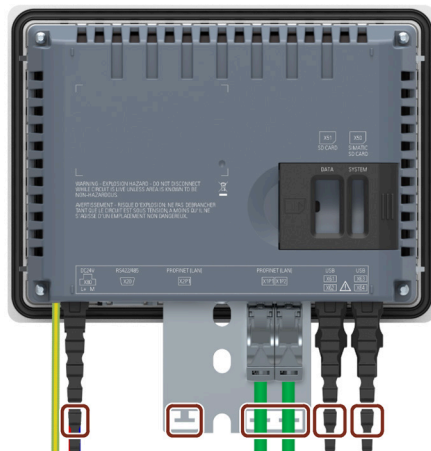

HMI devices with display diagonal ≥ 15 "

For devices with display diagonal ≥ 15 ", secure the cables to the marked fixing elements of the strain relief plate.

The figure below shows the fastening components using the MTP1900 Unified Comfort as an example.

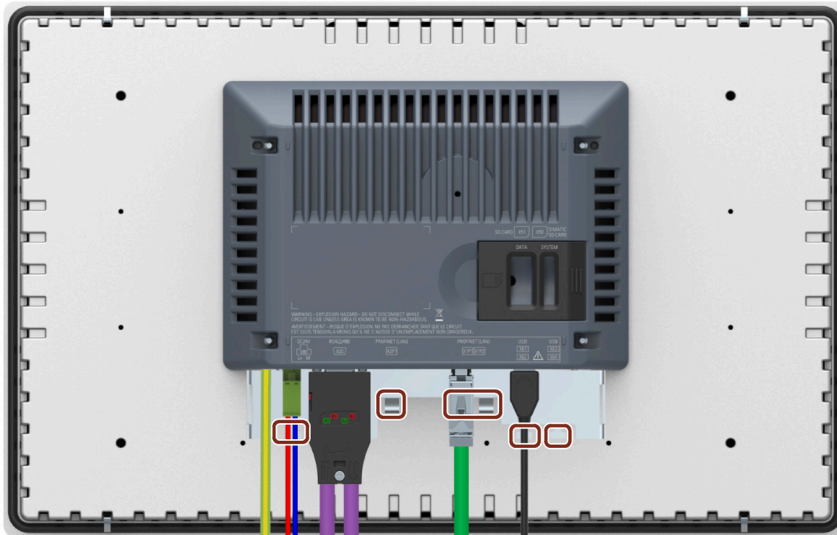

3.4.10 Securing cables for use in hazardous areas

For securing the connected cables, use the appropriate mounting elements, as described in the previous chapter.

When devices with Ex approval are used in hazardous areas, note that the connectors must be secured in a captive manner at the interfaces.

WARNING

Explosion hazard from sparks when connectors come loose

If a plug connector comes loose from the associated device interface during operation in a hazardous area, a spark over at the interface may cause an explosion. Death or serious physical injury as well as property damage may result.

For use in hazardous areas, it must be ensured that the plug connectors of the cables are fully connected to the respective interface and cannot come loose from the interfaces in any case.

Secure all connected cables directly at the transition between connector and cable to the nearest mounting element using a cable tie. Tighten up all cable ties in such a way that they fully wrap around the respective cable but do not damage the cable.

The following figure shows an example of how to secure a connector in a captive manner.

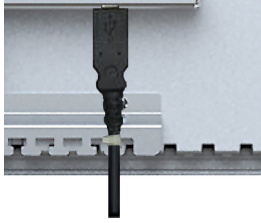

3.5 Removing the device

The HMI device is generally removed in the reverse order used for installing and connecting.

Procedure

Proceed as follows:

1. If a project is running on the HMI device, close the project with the HMI device configured for this purpose. Wait until the Control Panel is displayed.
2. Switch off power to the HMI device.
3. When you use the HMI device in a hazardous area, make sure that one of the two following requirements is met: The area is no longer hazardous or the device and its plug-in connections are de-energized.
4. Remove all cable ties on the HMI device used for strain relief.
5. Remove all plug-in connectors and the equipotential bonding cable from the HMI device.
6. Secure the HMI device so that it cannot fall out of the mounting cutout.
7. Loosen the screws of the mounting clips and remove all mounting clips.
8. Take the HMI device out of the mounting cutout.

See also

Connecting the device (Page 40)

Fastening the built-in device with mounting clips (Page 37)

Operating the device

4.1 Operator input options

Depending on the connected peripheral devices, the following operator input options are available:

- Capacitive multi-touch screen
- Screen keyboard
- External keyboard, connected via USB
- External mouse, connected via USB

If you need an external keyboard or mouse during operation, then use industrial grade devices. Devices that are not industrial grade are approved only for the commissioning.

4.2 Important notes on touch screen

You operate the capacitive multi-touch screen with one finger or with two-finger gestures.



WARNING

Personal injury or property damage due to no earth connection

An inadequate ground connection or the lack of one will cause malfunction of the capacitive multi-touch screen. Functions may not work properly. This can result in personal injury or property damage.

- Always connect the HMI device to a ground conductor.
- The ground conductor from the HMI device must be connected directly to ground with low impedance (short connection, minimum conductor cross-section 4 mm²).

You can find additional information on connecting the earth conductor in the section "Connecting the equipotential bonding circuit (Page 41)".

 **WARNING**

Personal injury or property damage due to maloperation

Incorrect operation of touch devices cannot be ruled out. This can result in personal injury or property damage.

Take the following precautions:

- Configure the plant so that safety-related functions are not operated with the touch screen.
- Only carry out an operator action if a plant screen is shown on the HMI device screen.
- Switch off the HMI device for cleaning and maintenance.

NOTICE

Damage to the touch screen

The following operation significantly reduces the service life of the touch screen and can lead to total failure:

- Touching with pointed or sharp objects
- Shock contact with hard objects.

Only touch the touch screen with a finger or a touch pen.

 **WARNING**

Danger of malfunctions due to incorrect execution of gestures on the touch screen

If gestures are executed incorrectly on the touch screen with multi-touch function, these gestures may not be recognized or could be recognized incorrectly. The entries made are then not implemented by the touch device or are implemented incorrectly or in an unintended manner.

Incorrect execution of multi-touch functions can lead to errors in the operation of the plant and thus to physical injury.

Observe when operating the capacitive multi-touch screen:

- The touch screen reacts to contact on its surface, not to pressure.
- When using a touch pen: Operate the touch screen only with a touch pen for capacitive touch.
- Avoid unintended multiple touches, for example, with your knuckles.

Before using the HMI device, familiarize yourself with the supported multi-touch functions of the operating system and the applications. Ensure that the gestures which the user executes on the multi-touch screen are recognized by the application. It is possible that certain gestures need to be trained beforehand.

Notes on operation

Note

Do not touch the capacitive multi-touch screen during startup

The HMI device automatically calibrates the capacitive multi-touch screen during startup. The touch screen is locked during calibration.

Do **not** touch the touch screen during startup. Make sure that you do **not** rest on the touch screen with the palm of your hand during startup.

Make sure that there are **no** conductive liquids on the touch screen during startup.

Note when operating the capacitive multi-touch screen:

- Surface contact with a diameter of about 5 to 20 mm is required for an operator action to be detected.
- An operation with gloves with a material thickness of < 2 mm is detected in most cases. However, check the usefulness of the gloves you are using.
- To avoid incorrect operation, certain inputs are ignored and blocked from further entry:
 - Simultaneous operation with more than 5 fingers.
 - Surface contact with a diameter of > 3 cm, for example, resting the palm of the hand on the touch screen
 - As soon as the touch screen is no longer touched, input is possible again.

Functions of the capacitive multi-touch screen

General functions

- Detection of up to 5 finger touches at a time.
- Recognition of the gestures supported by the operating system and the runtime software.
- You do not need to calibrate the capacitive multi-touch screen.

Security functions in an industrial environment

The capacitive multi-touch screen is locked for security reasons when the following disturbances occur:



- There is a conductive liquid on the touch screen with ground contact via the enclosure or the operator, for example.
- An electromagnetic disturbance that exceeds the specification in the technical data of the device exerts an influence, see section "Electromagnetic compatibility (Page 144)".

Once the interference is over, the capacitive multi-touch screen is no longer locked.

4.3 Supported gestures

4.3.1 Supported gestures in the Control Panel

The following touch gestures are available in the Control Panel.

Icon	Gesture	Behavior
	Tap	To activate an input object (such as input box, option button, selection list), tap on the input object.
	Vertical dragging with one finger	To scroll vertically in the window pane or in lists, drag vertically in the corresponding area with one finger.
	Horizontal dragging with one finger	To scroll horizontally in the window pane or in lists or to set a slider, drag horizontally in the corresponding area with one finger.

If you open an app via the Control Panel, then the gestures supported by the app are also available, for example, the "Scale" function in the "Web Browser".

4.3.2 Supported gestures in the runtime project

Various touch gestures are available for the runtime operation. Some touch gestures have different effects in the process pictures than in the controls.

Note







No operation with three or more fingers.

Only use one or two fingers when operating with touch gestures.

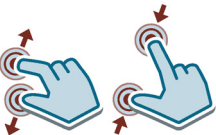

If you use more than two fingers with touch gestures, this can cause incorrect operation.

In the case of multitouch operation with several fingers, you only operate the respectively configured objects.



Supported touch gestures in process pictures

Icon	Gesture	Function
	Tap	To select an object, tap on the corresponding position in the process screen.
	Drag with one finger	To scroll horizontally or vertically, drag the process screen or the object with one finger in the desired direction. You scroll horizontal and vertical at the same time by dragging vertically in screens.
	Scale	To zoom in or zoom out, drag simultaneously with two fingers.
	Swipe	To switch between two process screens, swipe horizontally with one finger.
	Keep pressed	To call the shortcut menu, press for longer than a second on the object or the link. The function corresponds to a right-click.
	Activation gestures	To call the WinCC system dialog boxes, swipe fast vertically from top to bottom.

Supported touch gestures in controls

Icon	Gesture	Behavior	Supported WinCC controls
	Tap	To select a row, tap the row. With corresponding configuration of the control: To select a cell.	Alarm control
	Drag with two fingers	To move table and/or trends and axes, drag with two fingers in the control window.	<ul style="list-style-type: none"> • Trend control • Process control • Ruler window

4.3 Supported gestures

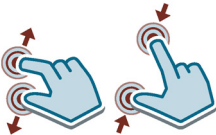
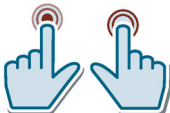
Icon	Gesture	Behavior	Supported WinCC controls
	Drag with one finger	To shift the X axis or Y axis. To navigate within a list or table.	<ul style="list-style-type: none"> Trend control Process control Ruler window
		To select multiple rows, tap a row and drag your finger up or down. With corresponding configuration of the control: To select multiple cells.	Alarm control
		To adapt the column width, tap a column grid line and drag your finger to the right or left.	
		To change the order of the columns, tap a column header and drag your finger to another column header.	
	Keep pressed	To display the tooltip of the picked value or object, press for longer than a second on the value or the object. The function corresponds to a right-click.	Trend control
	Double tap	To toggle between 2 preset zoom settings. Requirement: "Zoom +/-", "Zoom time axis +/-" or "Zoom value axis +/-" was pressed.	Trend control
	Scale	To zoom in or out in the trend control, drag with two fingers in the control window.	Trend control
	Hold a finger and tap twice with the other finger	To restore a zoomed view to 100%, follow these steps: <ul style="list-style-type: none"> Hold the control with one finger Tap twice on the control with the second finger. The operation corresponds to clicking the symbol "Original view" (1:1).	Trend control

4.4 Using the screen keyboard

4.4.1 The screen keyboards

When you touch an operating element in Runtime or in the Control Panel on the touch screen of the HMI device that requires input, the screen keyboard is displayed.

If the screen keyboard is not displayed automatically during data input, use the floating screen keyboard described at the end of this section.

The alphanumeric screen keyboard

The key layout of the screen keyboard is based on the layout of a PC keyboard in the corresponding language. The figures below show the different levels of the screen keyboard using the English layout ("QWERTY") as an example.

Lowercase letter level



The <SHIFT> button is used to switch to uppercase level.

Use the <&123> button to switch to the special character level.

Use the <Polyline> button to switch to the graphic input level.

Uppercase letter level



The <SHIFT> button is used to switch to lowercase level.

Use the <&123> button to switch to the special character level.

Use the <Polyline> button to switch to the graphic input level.

Special character level 1



Use the <1/2> button to switch to special character level 2.
Use the <ABC> button to switch to the last used letter level.

Special character level 2



Use the <2/2> button to switch to special character level 1.
Use the <ABC> button to switch to the last used letter level.

Graphic input level



In the graphic input level you can draw numbers or letters in a large touch area. The drawn numbers or letters are recognized and transferred to the active input box.
The <ABC> button is used to switch to the input of letters in the touch area.
The <123> button is used to switch to the input of numbers in the touch area.
The <Aa> button to switch to the last used letter level.

Numerical screen keyboard

If a numeric value is to be entered in a input box, the numerical screen keyboard is displayed.



Checking numerical value limits

Tags can be assigned limit values. Any entry of a value outside this limit is rejected. If an alarm view is configured, a system alarm is triggered and the original value is displayed again.

Decimal places of numerical values

The configuration engineer can define the number of decimal places for a numerical text box. The number of decimal places is checked when you enter a value in this field.

- Decimal places that exceed the limit are ignored.
- Unused decimal places are padded with "0" entries.

The floating screen keyboard

The floating screen keyboard is designed for data input in apps. The floating screen keyboard requires less display area and can be moved around the display. Use the floating screen keyboard even if the alphanumeric or numeric screen keyboard is not automatically displayed during data input.

You can open the floating screen keyboard by clicking on the following icon in the taskbar of the HMI device:



4.4 Using the screen keyboard

The levels and keys of the floating keyboard correspond to the levels and keys of the alphanumeric keyboard.

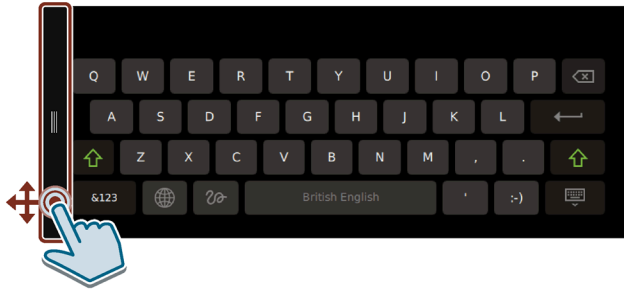















To move the floating screen keyboard, drag the floating keyboard by its left bar to the desired position.

You cannot enter data in the touch area of the graphic input level with the floating screen keyboard.

4.4.2 Control keys on the screen keyboard

The following control keys are available on the screen keyboard:

	Switch to lowercase level		Switch to special character level 1 in a letter level
	Switch to uppercase level		Switch to special character level 2 in special character level 1.
	Toggle language		Switch to special character level 1 in special character level 2.
	Delete character left of cursor		Switch to the last letter level used in a special character level Switch to letter input in the graphic input level
	Switch to graphic input level		Switch to numeric input in the graphic input level
	Switch to the last used letter level in the graphic input level.		Close screen keyboard, confirm input
	Creates a "smiley" in the active input box		Confirm entry, close the screen keyboard
	Creates three points in the active input box		

4.5 Using the taskbar

A taskbar is available for fast access to functions or apps.

You open the taskbar with a wiping gesture from bottom to top at the bottom edge of the display. If there is no operation in the taskbar for more than two seconds, the taskbar is hidden again. The following figure shows an example.

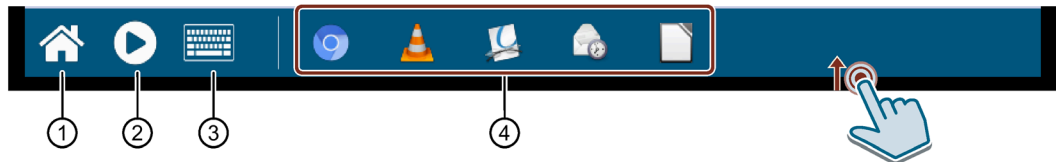

- ① Icon for opening the Control Panel from the Runtime project.
- ② "Start Runtime" icon to start the Runtime project.
- ③ Icon for opening the floating screen keyboard.
- ④ Symbols of all currently opened apps. The example shows from left to right the icons "Web Browser", "Media Player", "E-Mail Client", "PDF Viewer" and "Doc Viewer".

The buttons ① to ③ are always displayed in the taskbar, the number of app icons varies depending on the number of opened apps.

Touch a button or icon to activate the corresponding function or bring the corresponding app to the foreground.

If you operate your HMI device via an industrial grade mouse or remotely operate the HMI device via a client with mouse, then you can right-click the apps in the taskbar to close them again. If you operate the HMI device without a mouse, then close apps via the corresponding menu function or via the icon "x" on the far right in the app's title bar.

Use the floating screen keyboard for data input in apps. Additional information is available in the section "Using the screen keyboard (Page 63)".

4.6 Commissioning the HMI device

Requirement

The HMI device is mounted and connected according to these operating instructions.

Procedure

The following procedure describes how to typically include the HMI device during operation.

1. If you want to use the service concept with automatic backup, then insert a SIMATIC SD memory card ≥ 32 GB into the "X50 SYSTEM" slot.
Activate the automatic backup in the Control Panel under "Service and Commissioning" > "Automatic Backup" via the "Start" button.
2. Configure the HMI device in WinCC. When configuring, consider your security concept in the security settings. Configure a user administration. Define a user with the "Control Panel access" function right who can protect the HMI device against unauthorized access to the Control Panel.
3. Make sure that the network address of the HMI device corresponds to the configured network address.
4. Transfer your project including user administration via WinCC from the configuration PC to the HMI device.
5. If necessary, have the Control Panel protected against unauthorized access by an HMI device administrator under "Security" > "Control panel access".
6. Check the authorizations of the operators in the Control Panel under "Security" > "User management" and adjust the settings if necessary.
7. If necessary, deactivate one or more interfaces for storage media under "Devices And Input" > "Hardware interfaces".
8. Check date and time under "Language, Region and Formats" > "Date and time".
9. Set the required delay time for the start of the project under "Runtime Properties" > "Automatic runtime start".
10. Check in the Control Panel under "Apps" whether all apps required for the operation are available.
If additional apps are required, then install these via "Apps" > "App Management".

Result

Commissioning has been completed, the HMI device is ready to use. Depending on your application, further individual settings may be required in addition to the steps described.

4.7 Memory concept and memory cards

4.7.1 Memory concept

The HMI devices use the following memory types:

- **Internal memory**
- **Data memory card** for user data and logs
- **System memory card** for "automatic backup"
- USB port for a **USB storage medium** with data

Note

Use the memory card for logs

Due to the high number of read/write cycles, we recommend that you use the memory card rather than the USB interface for logs.

Internal memory

The following data is saved in the internal memory:

- Operating system
- Project file
- User administration
- Parameter sets
- Other data, such as documents or media files

Note

Cyclic write access to the internal memory is not permitted

Cyclic write access to internal memory is not permitted, because it reduces the service life of the internal memory and thus of the HMI device, for example, a configuration in which permanent system alarms or user-defined messages are generated in the alarm buffer.

Configure an alarm window, check the number and frequency of the alarms that occur. If you expect a permanent load on the internal memory from alarms, adjust the configuration accordingly.

If the alarms do not have to be stored permanently, you can disable the retentivity of the alarm buffer, see section "Alarm buffer (Page 86)".

To prolong the service life of your HMI device, you should preferably use external memory cards, e.g. the SIMATIC SD Memory Card \geq 32 GB, to store and log data.

In addition, you can activate the monitoring of the internal flash memory, see section "Performance (Page 84)".

Data memory card

The following data is saved on the memory card:

- Logs
- Data backups
- User data
- Parameter sets*)

*) To store parameter sets on the memory card, select "\\Storage Card SD\" as the path in WinCC.

You can use commercially available memory cards with "SD(IO/HC)" format as data memory card. For reasons of data consistency, Siemens recommends the use of the SIMATIC SD memory card ≥ 32 GB as data memory card, see section "Accessories (Page 16)".

Note

Data consistency

When the HMI device is switched off, the consistency of the stored data is ensured only for the SIMATIC SD memory card ≥ 32 GB.

With commercially available memory cards, switching off the device may result in the loss of saved data, for example, due to a power failure.

Frequency

Logs are stored at a frequency of approx. 0.2 Hz. This may result in small amounts of data not being saved shortly before a power failure.

Use a UPS to avoid data loss even shortly before a power failure.

System memory card

The system memory card is part of the service concept of the HMI devices. If you enable the "Automatic backup (Page 108)" function, all data from the internal memory of the HMI device is transferred to the system memory card. If the HMI device fails, you insert the system memory card into a replacement device. Once the replacement device starts, you can continue working on your project. This way you reduce your plant downtimes to a minimum.

The system memory card is not visible in the user interface of the HMI device and it cannot be used for data storage. In order for the HMI device to recognize the system memory card, you have to insert the system memory card into the slot designed for it.

Note

Type of system memory card

Only the SIMATIC SD memory card ≥ 32 GB is permitted for use as a system memory card. All other memory cards are not recognized as system memory card by the HMI device.

Slots for data and system memory cards

The slots for data memory card and system memory card are on the back of the HMI device. The memory cards are protected by a safety catch.

The figure below shows the slots with safety catch.

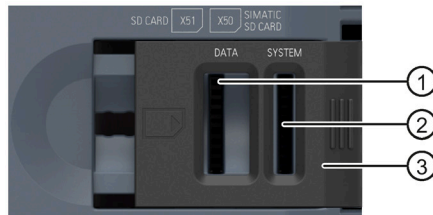

- ① Slot X51 for the data memory card in the format "SD(IO/HC)", recommendation for the card: SIMATIC SD memory card \geq 32 GB
- ② Slot X50 for the system memory card, permissible card: SIMATIC SD memory card \geq 32 GB
- ③ Safety catch, two-stage

Formatting the data memory card

The following file systems are supported for formatting the data memory card:

- FAT32
- NTFS

Use one of the supported file systems when formatting the data memory card.

Note

Using system memory card as data memory card

A memory card that has already been used as a system memory card in conjunction with the "Automatic backup" function can no longer be used as a data memory card. To use a system memory card as a data memory card, format the memory card with one of the supported file systems, preferably NTFS.

Formatting the system memory card

When you insert a SIMATIC SD memory card with 32 GB or more in slot X50 and activate the "Automatic backup (Page 108)" function, the memory card is formatted automatically.

Note

Using the data memory card as system memory card

A memory card that has been used as a data memory card must be formatted before it can be used as a system memory card. Formatting takes place automatically when you activate the "Automatic backup (Page 108)" function. All data is lost on the memory card during formatting. If necessary, back up the data on a data memory card before you use this memory card as a system memory card.

4.7.2 Changing the memory card

The memory cards are protected by a safety catch.

 WARNING
Do not plug or pull a memory card in a hazardous area
If you plug or pull a memory card during operation, you run the risk of a flashover. A flashover can cause an explosion in a hazardous area, resulting in death or severe injuries.
Plugging or pulling of a memory card in a hazardous area is prohibited .
Do not plug or pull a memory card until one of the two following requirements is met: The area is no longer hazardous or the device and its plug-in connections are de-energized.

Note

Potential loss of data

If the HMI device accesses its data when the memory card is removed, the data on the memory card cannot be fully read, written or it may even be destroyed.

If your process requires you to change the memory card during operation, you need to take this into account by employing suitable mechanisms in the configuration.

Do not remove the memory card during operation while data is being accessed. Observe the corresponding alarms on the screen.

Do not remove the system memory card for "automatic backup" during operation

If the "Automatic backup (Page 108)" function is activated, the system memory card may only be removed when the HMI device is switched off.

Removing the system memory card while the project is running

If you remove the system storage card while a project is running, the project is ended.

Requirement

There are currently no read or write accesses to the memory card.

Procedure

Note

Only use SIMATIC SD memory card ≥ 32 GB as system memory card

Only the SIMATIC SD memory card ≥ 32 GB is permitted for use as a system memory card. All other memory cards are not recognized as system memory card by the HMI device.

The following procedure describes the replacement of the system memory card as an example and applies in the same way to the data memory card.

1. Slide the safety catch to the desired position to replace the memory card.
2. To remove the memory card, briefly press-in the corresponding card. The card is released and can be removed.

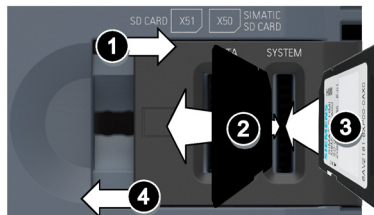

3. Insert the new memory card so that it clicks into place audibly and tangibly.
4. Slide the safety catch back into its original position.

If you have inserted the system memory card, the "System memory card plugged" dialog box is displayed. This dialog box is used to open the Control Panel and enable the "Automatic backup" function there.

Operating the Control Panel

5.1 Opening the settings

The Control Panel can be opened as follows:

- After switching on the device, if there is no project on the HMI device.
- Via an appropriately configured operating element in your project.
- By terminating the project running on the HMI device.

The following figure shows the open main window of the Control Panel:



To make the corresponding settings, select an entry in the navigation area or a tile in the window pane.

Note

Enabling password protection for the Control Panel

The password protection for the Control Panel is deactivated when the HMI device is delivered, which means that all users can make changes in the Control Panel.

To protect your HMI device against unauthorized changes, you can activate password protection for the Control Panel, see section "Control panel access (Page 99)".

Logging on in the Control Panel

The "Login" button is located on the right of Control Panel title bar.



If user administration has been configured for the HMI device and transferred to the HMI device, you can log in using the "Login" button. After logging in, you have the authorizations that were defined for your login in the configuration. To access all functions in the Control Panel, a user needs the "Control Panel access" function right.

Note

Four login attempts allowed

Four attempts are allowed to enter the correct login credentials. If the login credentials are entered incorrectly on the fifth attempt, the user involved is locked out. The user must be deleted and newly created or you must reload the user administration into the HMI device.

Ensure you enter the login credentials correctly.

After you have logged in, the "Logout" button is displayed in the title bar instead of the "Login" button.







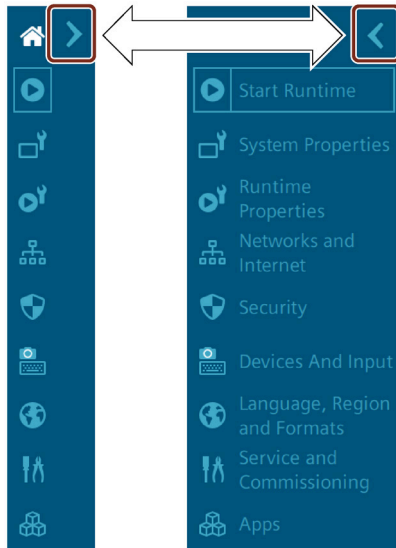





Switching the navigation area

You can switch the navigation area from the maximized display to the minimized display as follows.



5.2 Overview of functions

The table below shows the icons of the Control Panel and provides links to the corresponding function descriptions in the appropriate sections.

Icon	Assigned functions
	Open the main window of the Control Panel
 Start Runtime	Start project on the HMI device
 System Properties	Panel information (Page 78) Display (Page 79) Screensaver (Page 80) Update OS (Page 81) Reboot (Page 83) Performance (Page 84)
 Runtime Properties	Automatic runtime start (Page 85) Alarm buffer (Page 86)
 Networks and Internet	Network settings (Page 87) Remote connection (Page 91)
 Security	User management (Page 93) Certificates (Page 97) Control panel access (Page 99)
 External Devices and Input	Hardware interfaces (Page 100)
 Language, Region and Formats	Date and time (Page 101)
 Service and Commissioning	Transfer (Page 103) Update OS (Page 81) Backup (Page 106) Automatic backup (Page 108) Restore (Page 112) Trace forwarder (Page 114)
 Apps	Apps (Page 114)

5.3 System Properties

5.3.1 Panel information

Under "Panel information" you will find information specific to your HMI device, which you will need, for example, if you contact Technical Support (<https://support.industry.siemens.com/cs/ww/en/>).

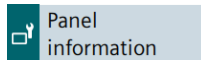

Properties

The following figure shows an example. Variable display values are shown with the wildcard character "#" or between angle brackets "<>".

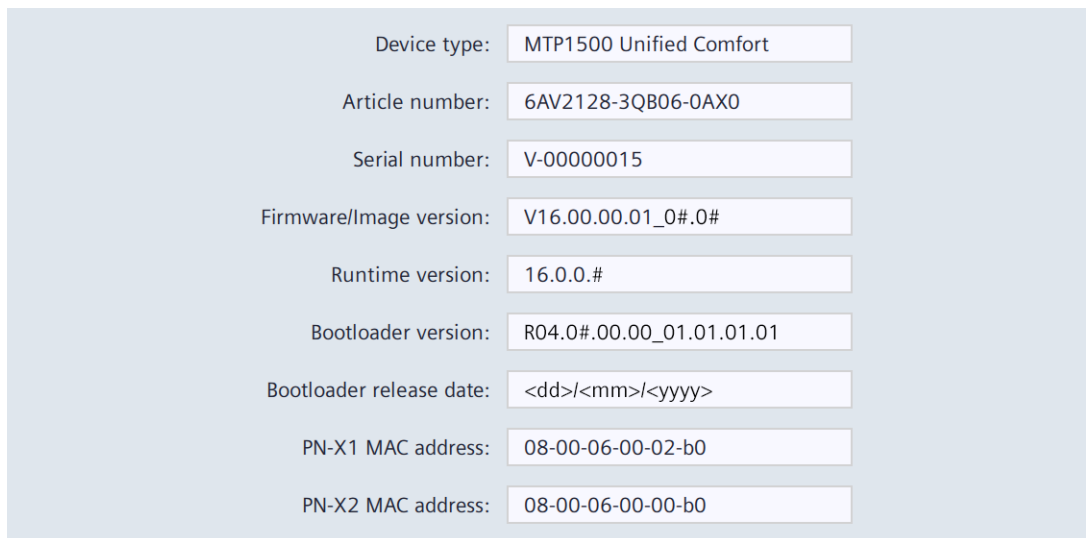

- "Device type": HMI device type designation
- "Article number": Article number of the HMI device
- "Serial number": HMI device serial number
- "Firmware/Image version": Version of the firmware and operating system.
- "Runtime version": Version of the runtime software located on the HMI device
- "Bootloader version": Version of the bootloader
- "Bootloader release date": Bootloader release date
- "PN-X1 MAC address": MAC address of the HMI device interface X1
- "PN-X2 MAC address": MAC address of the HMI device interface X2

5.3.2 Display

Under "Display" you define the display orientation and the display brightness via the intensity of the backlight.

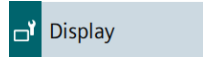

NOTICE

Backlight reduction

The brightness of the backlight decreases with increasing service life.
To avoid shortening the service life of the backlight unnecessarily, reduce the backlight.

Orientation

0° (Landscape)

90° (Portrait)

- "0° (Landscape)" (default setting): Select this option for HMI devices that have been installed and configured in landscape format.
- "90° (Portrait)": Select this option for HMI devices that have been installed and configured in portrait format.

Note

Display orientation and Runtime project

The display orientation should only be switched if no Runtime project is running on the HMI device.

If you switch the display orientation while a Runtime project is running on the HMI device, the project may not be displayed correctly on the HMI device display after switching. To display the project correctly, restart the Runtime software or the HMI device.

Brightness

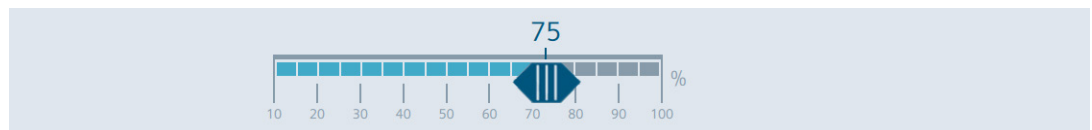

Set the desired display brightness using the slider. Value range: 10 to 100%

Default setting: 70%

The display brightness can also be set within the value range via the configuration.

5.3.3 Screensaver

Under "Screensaver" you define the time until the automatic activation of the screensaver and the brightness of the backlight when the screensaver is active.

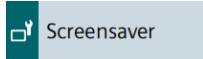

NOTICE
Activating the screensaver
If an image is displayed on the screen for long time, its outline may remain dimly visible on the display.
This effect is reversible when you use a screensaver. Therefore, activate the screensaver.

General Settings

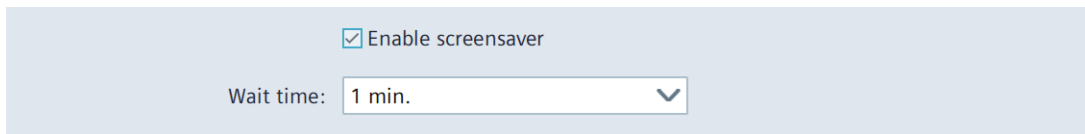

- "Enable screensaver": Select this option to activate the screensaver.
Default setting: "deactivated".
- "Wait time": Time to activate the screensaver, value range 1 to 120 minutes in 15-minute increments. Default setting is "1 min."

The screensaver is automatically activated if the HMI device is not operated within the specified period of time.

Brightness of screensaver

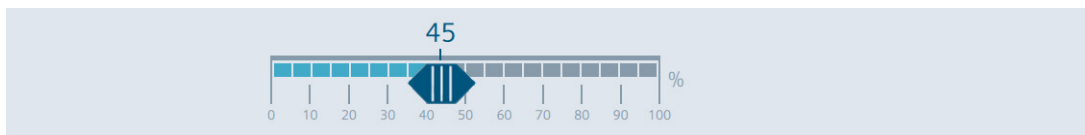

Use the slider to set the desired display brightness of the screensaver, value range 0 to 100%. Default setting is "30 %".

To deactivate the screensaver, tap the touch screen briefly. For safety reasons, this touch is not evaluated as an operator action. Therefore, no unintentional functions can be triggered.

The screensaver is also deactivated if the HMI device is accessed remotely, e.g. via Sm@rtClient or the configuration PC.

5.3.4 Update OS

Use "Update OS" to update the operating system of the HMI device. The operating system is contained in several firmware files. The master file has the extension ".fwf". The number of additional files varies; these files have the file name of the master file and a sequential number (".0", ".1", ".2", etc.) as an extension.

The "Update OS" function is available under both "System Properties" and "Service and Commissioning".

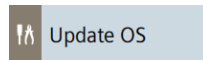
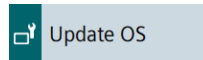

NOTICE

Updating the operating system deletes data on the HMI device

Project, parameter sets and user administration will be deleted when you update the operating system on the HMI device.

Before updating the operating system, backup the data on the HMI device, if necessary.

All settings, except the following settings which you changed in the Control Panel before updating the operating system, are retained even after the update of the operating system:

- The external interfaces become activated again (default setting), see section "Network settings (Page 87)".
- The time zone is reset to the default setting "(UTC) Coordinated Universal Time", see section "Remote connection (Page 91)".

Use a SIMATIC SD memory card with 32 GB or more or an industrial USB flash drive to load the firmware.

Firmware files for the HMI devices can be downloaded from the Internet (<https://support.industry.siemens.com/cs/ww/en/view/109746530>). Observe the documentation included with the download.

Note

Do not rename firmware files

If you change the name of the firmware files, the operating system can no longer be updated with these firmware files. The firmware files become unusable. Leave the name of the firmware files unchanged.

Copy firmware files completely

If you copy the firmware files, be sure to also copy the master file ".fwf" together with all associated firmware files (".0", ".1", ".2", etc.).

If one of the files is missing, the operating system cannot be loaded.

Alternatively to the "Update OS" function in the Control Panel, you can use the "Update OS" function in WinCC.

Panel Information

Device type:

Image version:

- "Device type": HMI device type designation.
- "Image version": Version of the firmware and operating system.

Select storage media for OS update

Use the selection list to select the storage medium on which the firmware file is located.

Firmware files on external storage

Name	Path	Image Version
UCP_7_22_V16_0.fwf	/media/simatic/data-s...	V16.00.00.01_04.01

- The list shows all firmware files that can be loaded into the HMI device.
Select the desired firmware master file (.fwf) from the list.
- "Update OS": Button for starting the loading process.
The HMI device restarts after the "Update OS" button is pressed. The loading process then begins.
A dialog with a progress bar is displayed on the HMI device for each firmware file.
The HMI device is restarted again after the completion of the loading process.
The main window of the Control Panel is displayed after the restart. The operating system on the HMI device is updated.

5.3.5 Reboot

You can restart the HMI device manually under "Reboot". The restart can be carried out normally or in maintenance mode.

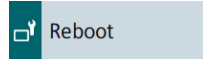

In the following cases the HMI device is automatically restarted after confirmation:

- You have made changes to the PN-X1 interface under "Ethernet parameters Port 1" or "Ethernet parameters Port 2", see section "PN-X1 (Page 87)".
- You have made changes under "General network settings", see section "General (Page 91)".
- You have switched the "Enable alarm buffer" option, see section "Alarm buffer (Page 86)".

NOTICE

Data loss

All volatile data is lost with a restart.

Make sure that no project is running on the HMI device and no data is being written to the flash memory.

Reboot panel

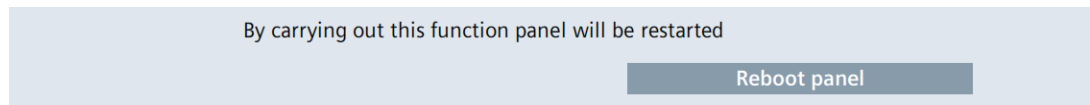

"Reboot panel": Button for a simple restart of the HMI device ("soft reboot").

Reboot in maintenance mode

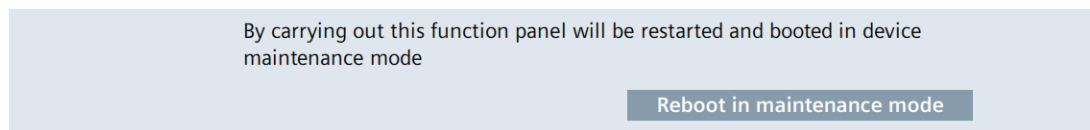

"Reboot in maintenance mode": Button for a restart in maintenance mode. The restart in maintenance mode is required to reset the HMI device to factory settings.

The HMI device restarts after the "Reboot in maintenance mode" button is pressed. The "Maintenance Mode" dialog box is displayed for a period of 10 minutes. In this period you can connect the HMI device to a configuration PC and reset the HMI device to factory settings with the ProSave software. Follow the description in section "Resetting an HMI device to factory settings via ProSave (Page 133)".

5.3.6 Performance

Under "Performance" you can activate the monitoring of the internal flash memory.

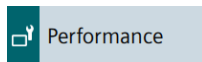

Flash Memory Monitoring Section

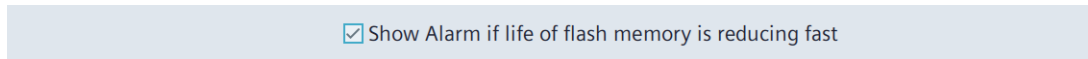

"Show Alarm if life of flash memory is reducing fast": Option to activate flash memory monitoring. The default setting is "activated".

If the option is activated, the state of the flash memory is checked cyclically. If the cyclical check results in a high load on the flash memory, the message "Flash memory life time reducing fast" is displayed regularly.

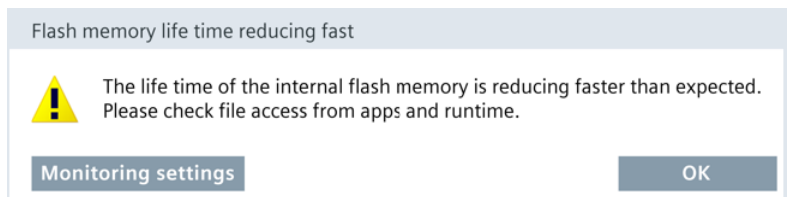

- "Monitoring Settings": Button for opening the "Performance" settings in the Control Panel. Press the button, note the cause specified under "Source" and contact the corresponding administrator or project engineer.
- "OK": Button for acknowledging the alarm.

Last alarm

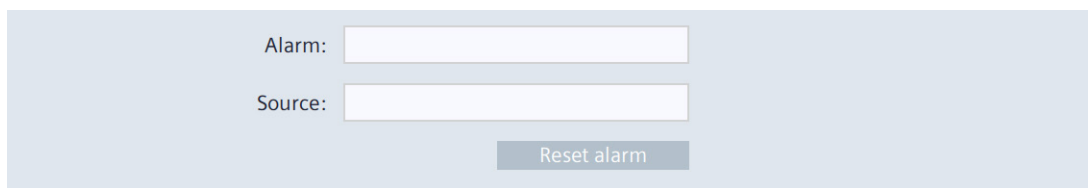

- "Alarm": Display panel with the last alarm that was displayed about the status of the flash memory.
- "Source": Display field with information on the cause of the last alarm. Pass this information on to the administrator or project engineer, who can change the settings in the corresponding app or the configuration of the HMI device so that the "Flash memory life time reducing fast" alarm no longer appears.
- "Reset alarm": Button for deactivating the regularly occurring "Flash memory life time reducing fast" alarm. The button can only be operated by users with the "Control Panel Administrator" authorization. After pressing the button, the "Flash memory life time reducing fast" alarm is only displayed again when the next cyclic check results in a high load on the flash memory.

5.4 Runtime Properties

5.4.1 Automatic runtime start

Under "Automatic runtime start" you define whether the project on the HMI device starts automatically or not after a defined delay time.

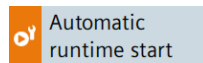

Automatic runtime start

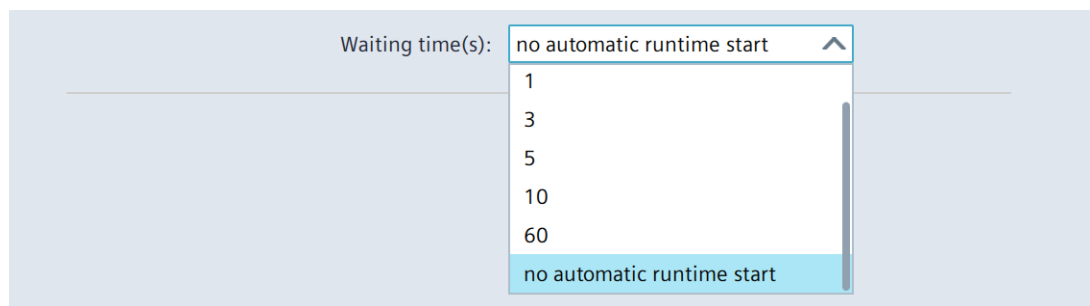

"Waiting time(s)": Selection list for determining whether the project on the HMI device starts automatically after a specified delay time or not.

Selection options:

- "0": The project is started directly after the operating system.
- "1" to "60": The project starts after a delay time of 1 to 60 seconds. The Control Panel is displayed during the delay period, and you can operate it.
- "no automatic runtime start" (default setting): The project is not started automatically, but via the "Start Runtime" button in the Control Panel.

Note

Once the project has started, you have the following options to open the Control Panel:

- Via the taskbar (Page 67).
 - Via an operating element for which the "Open Control Panel" or "Stop Runtime" function has been configured.
-

5.4.2 Alarm buffer

Under "Alarm buffer" you can activate or deactivate the retentive alarm buffer. The default setting is "deactivated".

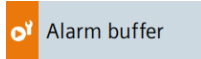

Note

Back up data before deactivating the retentivity

When you deactivate the retentivity of the alarm buffer and still need the data in the alarm buffer, back up this data before deactivating the retentivity in a log.

Alarm buffer configuration

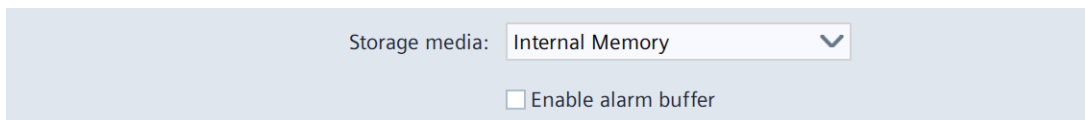

- "Storage media": Selection list for defining the storage medium for the retentive alarm buffer. Selection options:
 - "Internal Memory": Alarms are written to the internal flash memory.
- "Enable alarm buffer": Option to enable or disable the retentive alarm buffer. The default setting is "deactivated".

When the retentivity of the alarm buffer is activated, the retentive alarm data is backed up every two seconds to the selected storage medium. With a high number of alarms, the storage medium is subject to an equally high number of read and write cycles.

If the retentivity of the alarm buffer is deactivated, the alarm buffer is emptied and the retentive alarm data is no longer backed up to the selected storage medium. This means the storage medium is used less with a high number of alarms.

Switching the "Enable alarm buffer" option requires a restart, the "Enable alarm buffer" dialog is displayed. Restart the system using the "OK" button.

5.5 Network and Internet

5.5.1 Network settings

5.5.1.1 Overview

Under "Network settings", you change settings for the network and for the network interfaces X1 and X2.

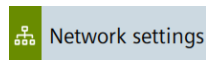

The following buttons take you to the corresponding settings.

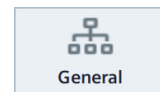
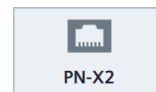

- "PN-X1": Settings for X1 interface (Page 87)
- "PN-X2": Settings for X2 interface (Page 89)
- "General": General settings (Page 91)

The settings under "Network settings" are retained after a restart or update of the operating system.

If the HMI device is reset to factory settings, all settings will be reset to their default values.

5.5.1.2 PN-X1

Under "PN-X1" you define the parameters for the X1 interface and both X1P1 and X1P2 connections.



PROFINET

Device name:	<input type="text" value="mtp1500"/>
Converted name:	<input type="text" value="mtp1500"/>
MAC address:	<input type="text" value="28-63-36-78-a4-53"/>

- "Device name": PROFINET name of the HMI device, may not contain any spaces and must be unique in the local network.
- "Converted name": Display field with the PROFINET name of the HMI device, contains the entry under "Device name", automatically converted according to PROFINET naming conventions.
- "MAC address": Display field with the MAC address of X1 interface of the HMI device.

IP address

Obtain an IP address via DHCP

Specify an IP address

IP address:

Subnet mask:

Default gateway:

- "Obtain an IP address via DHCP" (default setting): Option to automatically assign the IP address via the DHCP server.
- "Specify an IP address": Option to manually assign the IP address.
- "IP address": IP address of X1 interface for the X1P1 and X1P2 ports. The IP address must be unique in the local network. The IP addresses of X1 and X2 interfaces must be located in different subnets.
- "Subnet mask": Subnet mask for the IP address of X1 interface.
- "Default gateway": IP address of the gateway (router) if several different local networks are used.
- "Set IP address": Button for saving the specified IP address parameters.

Note

You can also configure the network address in the "Devices & Networks" editor in WinCC. You can find more information in the TIA Portal information system.

Note

If you select the option "Specify an IP address via DHCP", this setting will not be overwritten when the project is loaded. If you select the option "Specify an IP address", you can also configure the network address in the "Devices & Networks" editor in WinCC. You can find more information in the TIA Portal information system.

Ethernet parameters Port 1, Ethernet Parameters Port 2

- "Activate this port for use": Option to activate or deactivate the X1P1 or X1P2 ports. The default setting is "Activated".
- "Mode and speed": List for selecting the transmission type and transmission rate for the interface; selection options: "Automatic" (default setting) or "100Mbps / FDX" (100 Mbps, full-duplex). Use the default setting "Automatic" preferably.
- "Boundaries":
 - "End of detection of accessible nodes": DCP frames for detecting accessible nodes are not forwarded. Nodes located beyond this interface are no longer accessible.
 - "End of topology discovery": LLDP frames for topology discovery are not forwarded.

Changes under "Ethernet parameters Port 1" and "Ethernet parameters Port 2" require a restart, the "PROFINET Port Settings" dialog box is displayed. Restart the system using the "Restart" button.

5.5.1.3 PN-X2

Under "PN-X2" you define the parameters for the X2 interface.

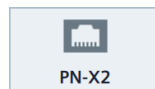

PROFINET

- "Device name": Display field with the PROFINET name of the HMI device that was defined in the settings under "PN-X1".
- "Converted name": Display field with the PROFINET name of the HMI device, contains the entry under "Device name", automatically converted according to PROFINET naming conventions.
- "MAC address": Display field with the MAC address of X2 interface of the HMI device.

IP address

Obtain an IP address via DHCP

Specify an IP address

IP address:

Subnet mask:

Default gateway:

- "Obtain an IP address via DHCP" (default setting): Option to automatically assign the IP address via the DHCP server.
- "Specify an IP address": Option to manually assign the IP address.
- "IP address": IP address of the X2 interface. The IP address must be unique in the local network. The IP addresses of X2 and X1 interfaces must be located in different subnets.
- "Subnet mask": Subnet mask for the IP address of X2 interface.
- "Default gateway": IP address of the gateway (router) if several different local networks are used.
- "Set IP address": Button for saving the specified IP address parameters.

Note

If you select the option "Obtain an IP address via DHCP", this setting will not be overwritten when the project is loaded. If you select the option "Specify an IP address", you can also configure the network address in the "Devices & Networks" editor in WinCC. You can find more information in the TIA Portal information system.

Ethernet parameters Port

Activate this port for use

Mode and speed:

- "Activate this port for use": Option to enable or disable the port. The default setting is "Activated".
- "Mode and speed": List for selecting the transmission type and transmission rate for the port.

Selection options:

- "Automatic" (default setting)
- "10Mbps / HDX" (10 Mbps, half duplex)
- "10Mbps / FDX" (10 Mbps, full duplex)
- "100Mbps / HDX" (100 Mbps, half duplex)
- "100Mbps / FDX" (100 Mbps, full duplex)

Use the default setting "Automatic" preferably.

Name servers

Name server address may be automatically assigned if DHCP is enabled on this adapter.

Primary DNS:

Secondary DNS:

- "Primary DNS": Address of the DNS server.
- "Secondary DNS": Address of the secondary DNS server.

If you have activated the "Obtain an IP address via DHCP" option under "IP address", the specifications under "Name servers" are optional.

5.5.1.4 General

You define the general network parameters under "General" .

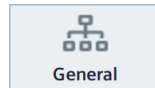

General network settings

Enable simple network management protocol (SNMP)

- "Enable simple network management protocol (SNMP)": Option to enable or disable the Simple Network Management Protocol for data transmission.

If this option is switched, a restart of the HMI device is necessary and the "PROFINET Port Settings" dialog box is displayed. Restart the system using the "Restart" button.

5.5.2 Remote connection

Change the settings for remote access to the HMI device under "Remote connection". You can define two passwords for remote access, for example, a password for the "Operate" right and a password for the "Monitor" right.

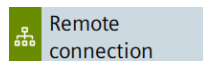

Change the settings under "Remote connection" only if no client is connected to the Sm@rtServer, because changing the settings disconnects all client connections.

Sm@rtServer

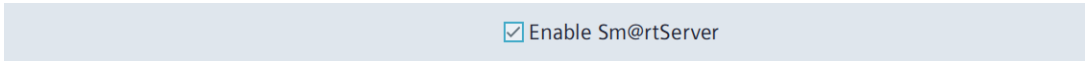

"Enable Sm@rtServer": Option to enable or disable the Sm@rtServer on the HMI device. The default setting is "deactivated".

If the Sm@rtServer is started on an HMI device, you can access the HMI device via a suitable client. Suitable clients are, for example, Tigervnc or the Sm@rtClient application. Depending on the settings under "Users", a user logged in via a client can operate or monitor the HMI device.

Users



In this area you define which rights are associated with which password. Several users can access the Sm@rtServer simultaneously via a password. If no password is specified, then users with the appropriate authorization can log in without a password.

- "Password for user 1": First password for access to the HMI device. Default setting: "No password".
 - "User 1 is allowed to remote control the panel": Option to activate the "Operate" right for a user who logs in with password 1. The default setting is "deactivated".
- "Password for user 2": Second password for access to the HMI device. Default setting: "No password".
 - "User 2 is allowed to remote control the panel": Option to activate the "Operate" right for a user who logs in with password 2. The default setting is "deactivated".

Communication

- "Secure communication via self-signed certificate": Option to enable secure communications via SSL encryption. Default setting: "activated".
Client access is only possible if the client application supports SSL encryption and if passwords have been set for both users.
For access via the Sm@rtClient application, this option must be cleared.
- "Port Configuration"
 - "Automatic" (default setting): Option to enable automatic port assignment. The default value "5900" for the port number remains unchanged.
 - "Manual": Option to enable manual port assignment.
- "Port for access from desktop application": Port number for access via the Sm@rtClient application. Default value is "5900".

5.6 Security

5.6.1 User management

A convenient user administration is available to you under "User management". The user administration is configured in WinCC, transferred to the HMI device and managed on the HMI device. To transfer the user administration from WinCC to the HMI device, the option "Keep current user administration data in runtime" must be cleared in the "Load preview" dialog box during project transfer.

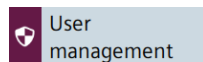

The complete user list is only visible and editable for users who have been assigned the "User administration" function right in the configuration.

Users with other function rights see their own entry in the user list and have access to the buttons in the "Current user" area.

If password protection is activated for the Control Panel, only users with the "Control Panel access" function right can access the Control Panel.

Current user

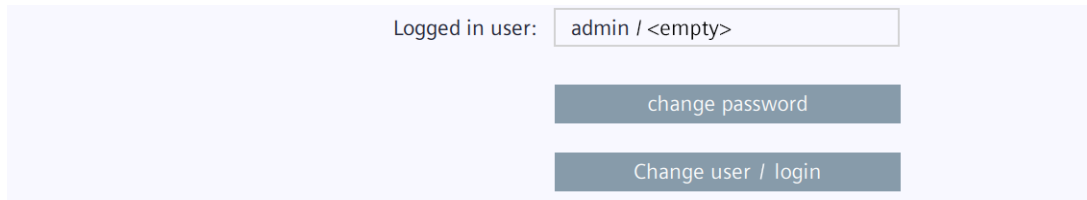

- "Logged in user": Displays the login name of the user currently logged in. If no user is currently logged in, this field is empty.
- "change password": Button to change the password for the user currently logged in. After pressing the button, the "Change password" dialog is displayed.

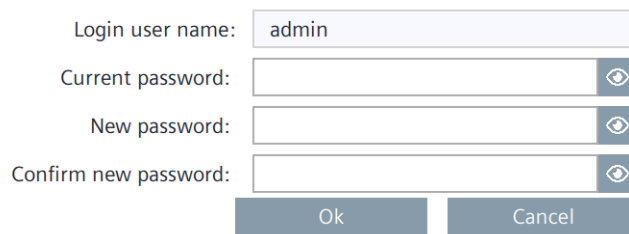

Enter the previous password once and the new password twice. The following button can be used to make the passwords visible for the display duration of the dialog box:



- "Change user": Button for changing the current user.
- "login": Button for logging in a user.

After pressing the button, the "User Login" dialog is displayed.

Please enter user name and password to gain access:



Enter the desired login name with the associated password and log in using the "Login" button.

Note

Four login attempts allowed

Four attempts are allowed to enter the correct login credentials. If the login credentials are entered incorrectly on the fifth attempt, the user involved is locked out. The user must be deleted and newly created or you must reload the user administration into the HMI device.



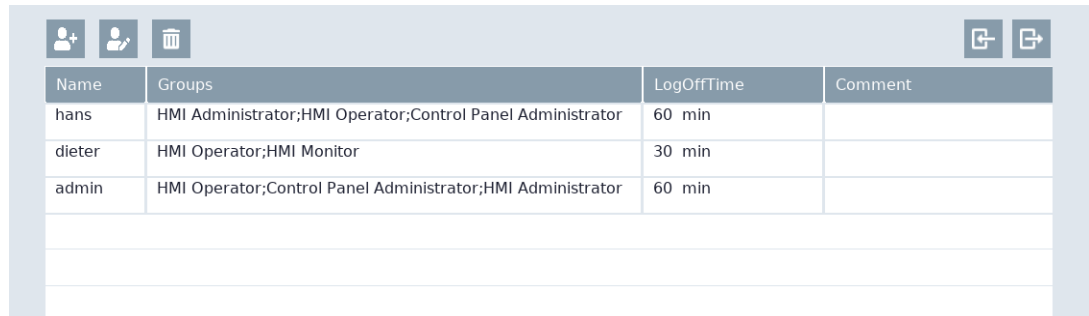

Ensure you enter the login credentials correctly.

Users



Name	Groups	LogOffTime	Comment
hans	HMI Administrator;HMI Operator;Control Panel Administrator	60 min	
dieter	HMI Operator;HMI Monitor	30 min	
admin	HMI Operator;Control Panel Administrator;HMI Administrator	60 min	

- The following buttons with the following functions are located above the user list:

	Creating a new user.
	Edit data of the user currently selected in the list.
	Delete the user currently selected in the list.
	Import complete user administration from a file in ".json" format ¹ . Note: Import completely overwrites the user administration on the HMI device.
	Export complete user administration to a file in ".json" format ¹ .

¹ For importing and exporting the user administration, the "User administration" function right is required; the "Import & export users" function right which can be configured in WinCC is not required.

- The user list displays the users available on the HMI device with the following user characteristics:
 - "Name": Login name of the user.
 - "Groups": User groups to which the user is assigned.
 - "LogOffTime": Maximum permissible login time of the user, value range 1 to 600 minutes.
 - "Comment": Comment text for the user.

Creating or editing users

The editing functions are only available for users who have been assigned the "User administration" function right in the configuration.

Use the following button to create a new user:



With the following button you edit the data of a user:



After pressing one of the two buttons, the dialog "Add user" or the dialog "Edit user" is displayed. Both dialogs boxes are identical in content.

The following figure shows an example of the "Edit user" dialog box.

- "Login user name": Display field with the login name of the user.
- "Groups": Selection list for assigning the user to one or more user groups. The user groups correspond to the roles which have been defined in the WinCC project for the HMI device and assigned the corresponding function rights. The following system-defined roles can be transferred to the HMI device:

Role designation.	Authorization in the Control Panel	Authorization in Runtime
HMI Administrator	User administration	Remote access, remote configuration, Web access, monitoring
HMI Operator	-	Web access, operation, monitoring
HMI Monitor	-	Web access, monitor

Note

Assign the "Control Panel access" function right via a user-defined role

There is no system-defined role in WinCC to which the "Control Panel access" function right is assigned. To give a user full access to the Control Panel of the HMI device, proceed as follows:

- Configure a user-defined role.
- Assign this role the "Control Panel access" and "User administration" function rights.
- Assign the user-defined role to the desired user.

You can find detailed information on creating users, roles and functional rights in the TIA Portal Information System.

- "Password": Text box for the password of the user. If you do not enter anything, the user's existing password remains unchanged.
- "Confirm password": Text box for confirming the new password.
- "Maximum session timeout": Maximum permitted login time in minutes.

- "Comment": Note on changing the user.
- "Edit user" or "Add user" Button for saving the user.
- "Cancel": Button for discarding the changes.

See also

Transferring a project with WinCC (Page 125)

5.6.2 Certificates

You can use this function to import, display and delete certificates.

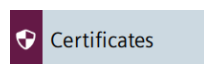

A digital certificate consists of structured data, which confirms ownership and other properties of a public key.

For information on handling certificates, observe the "General safety instructions (Page 21)" section.

Certificates on the device

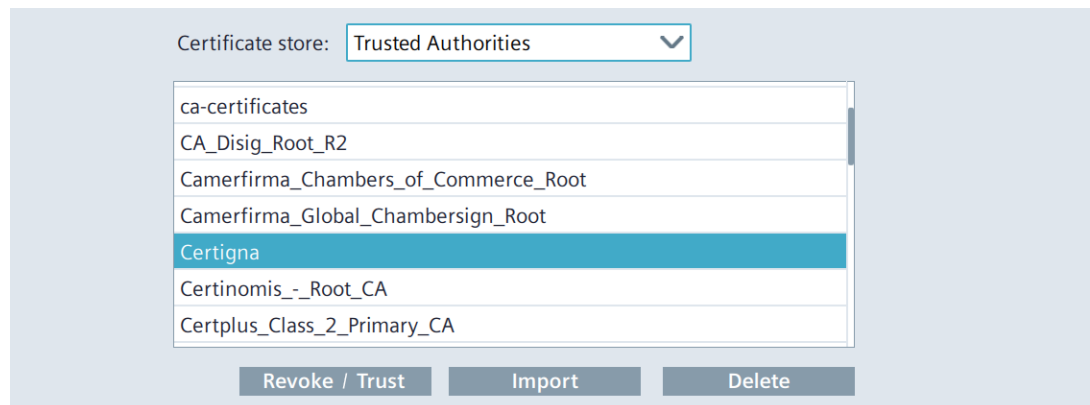

- "Certificate store": Selection list for filtering the certificate list according to the following certificate types:
 - "Trusted Authorities" for trustworthy certificates
 - "My Certificates" for your own certificates
 - "Other Certificates" for other certificates
- The certificate list displays all certificates located on the HMI device.
- "Revoke": Button to mark a certificate as not trustworthy.
"Trust": Button to mark a certificate as trustworthy.
- "Import": Button for importing one or more certificates from a data storage medium.

The "Import certificate" dialog box is displayed after the "Import" button is pressed.

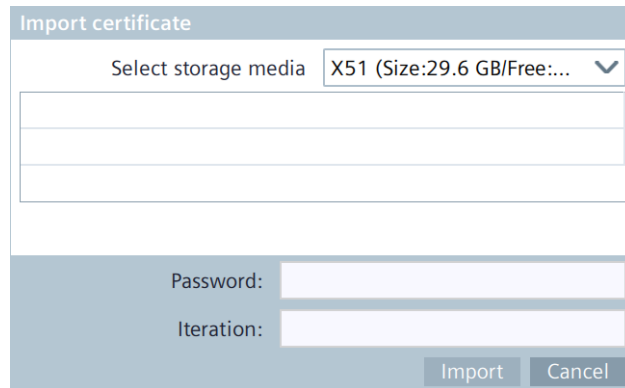

Select the storage medium and certificate file and import the certificate file using the "Import" button.

If you import an encrypted certificate with the ".enc" file extension, enter the encryption password under "Password" and confirm the password under "Iteration".

- "Delete": Button to delete the currently selected certificate in the certificate list.

Note

The selected certificate is deleted immediately without prompt.

Certificate details

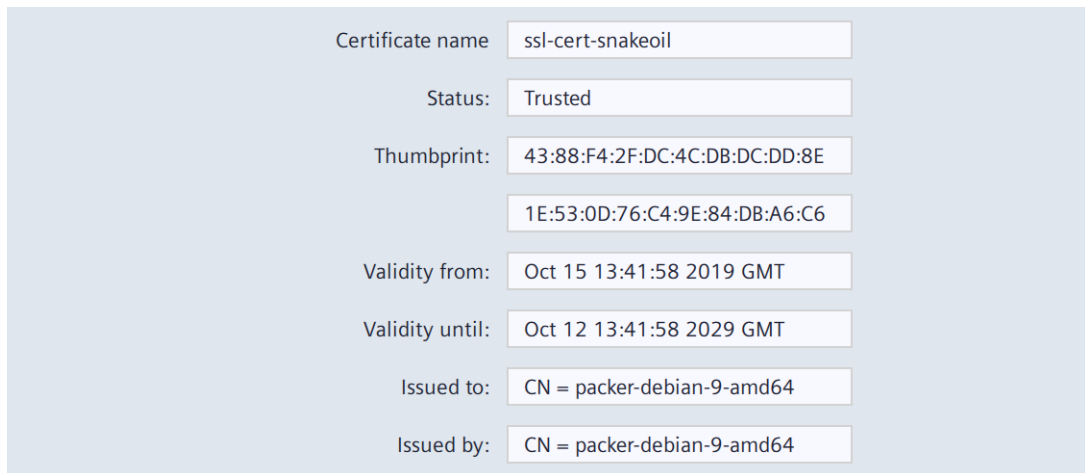

- "Certificate name": Name of the certificate.
- "Status": Status of the certificate on the HMI device ("Trusted" or "Revoked")
- "Thumbprint": Character string to prove the authenticity of the certificate.
- "Validity from": Start of the validity of the certificate.
- "Validity until": End of the validity of the certificate.
- "Issued to": Recipient of the certificate.
- "Issued by": Issuer of the certificate.

5.6.3 Control panel access

Under "Control panel access" you can protect access with a password on the Control Panel. Only users who have been assigned the "Control Panel access" function right in the configuration can change the password protection.

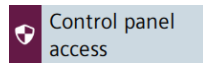

General network settings

Enable password protection for control panel

- "Enable password protection for control panel": Option to enable password protection for the Control Panel.

The password protection can only be activated or deactivated by users who have been assigned the "Control Panel access" function right in the configuration.

If you select the "Enable password protection for control panel" option, the "Access to control panel is restricted" dialog box is displayed.

 A dialog box titled "Access to control panel is restricted". Inside, it says "Please enter user name and password to gain access:". There are two input fields: "Username:" and "Password:". The "Password:" field has a small eye icon to its right. At the bottom, there are two buttons: "Login" and "Cancel".

Log in as a user with the "Control Panel access" function right to activate the password protection for the Control Panel. Use the following button to make the password visible for the display duration of the dialog:



Note

Four login attempts allowed

Four attempts are allowed to enter the correct login credentials. If the login credentials are entered incorrectly on the fifth attempt, the user involved is locked out. The user must be deleted and newly created or you must reload the user administration into the HMI device.

Ensure you enter the login credentials correctly.

If you are logged in as a user with the "Control Panel access" functional right, the "Access to control panel is restricted" dialog is no longer displayed when accessing the Control Panel.

If you are not logged in or do not have the "Control Panel access" function right, the "Access to control panel is restricted" dialog is displayed when accessing the Control Panel.

Access to the Control Panel can be triggered directly in the Control Panel or via a system function of the Runtime software.

5.7 External Devices and Input

5.7.1 Hardware interfaces

Under "Hardware interfaces", change the settings for accessing the storage media interfaces.

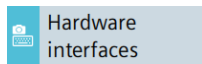

You can deactivate one or more interfaces to protect the HMI device from unauthorized external access.

The system memory card interface cannot be deactivated.

Data memory card slot

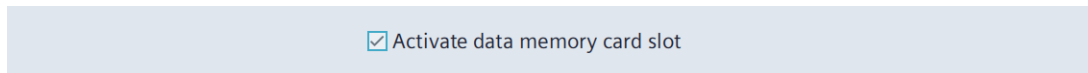

- "Activate data memory card slot": Option to enable or disable the interface for the data memory card. The default setting is "Activated".

Activate USB ports



- "X61": Option to activate or deactivate the USB port X61.
- "X62": Option to activate or deactivate the USB port X62.
- "X63": Option to activate or deactivate the USB port X63.
- "X64": Option to activate or deactivate the USB port X64.

Default setting for all USB ports is "activated".

5.8 Language, Region and Formats

5.8.1 Date and time

Under "Date and time", set the date, time, and time zone for the HMI device manually or via a time server on the network.

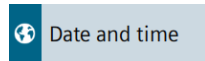

NOTICE

Time synchronization required for time-dependent reactions

A malfunction may occur in the plant if the date and time are not synchronized and time-dependent reactions are triggered in the plant via the HMI device. To avoid malfunctions, use automatic time synchronization via one or more NTP servers.

Date and Time

A screenshot of the "Date and Time" configuration interface. It features three input fields: "Date:" with the value "20 February 2020", "Current Time:" with the value "18:20:07", and "Time zone:" with a dropdown menu showing "(UTC-12:00)International Da...". Below these fields are two radio button options: "Set date and time manually" (which is selected) and "Synchronize time with a NTP(Network Time Protocol Server)".

- "Date": Display field with the current date.
- "Current time": Display field with the current clock time.
- "Time zone": Selection list for the desired time zone.

- "Set date and time manually" (default setting): Option for manual time setting on the HMI device. If you select this option, the following list is displayed below the options:

17	November	2017	15	16
18	December	2018	16	17
19	January	2019	17	18
20	February	2020	18	19
21	March	2021	19	20
22	April	2022	20	21
23	May	2023	21	22

Set Date and Time

Set the day, month, year and time by scrolling the respective list column so that the desired date and time are displayed in the framed line in the middle of the list. The "Set Date and Time" button is used to save the setting.

- "Synchronize time with a NTP(Network Time Protocol Server)": Option for automatic time synchronization via an NTP server. If you select this option, the following parameters for specifying time synchronization via NTP servers are displayed below the options:

Update rate: sec

Server 1

Address: 

Add Server

Enter the desired synchronization interval under "Update rate", value range 10 to 86400 seconds (1 day). After the input, the value is rounded to the nearest power of two based on the internal format.

Add at least one and a maximum of four NTP servers using the "Add Server" button. Specify the IP address for each NTP server and make sure that the device is set up as an NTP server.

5.9 Service and Commissioning

5.9.1 Transfer

Under "Transfer" you define whether and how data is transferred from a configuration PC to the HMI device.

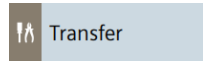

Transfer mode

A screenshot of a configuration screen for transfer mode. It features a checkbox labeled "Enable transfer" which is checked. Below it is a dropdown menu labeled "Transfer channel" with "Ethernet" selected.

- "Enable transfer": Option to enable or disable data transfer to the HMI device.
If you disable the transfer, you protect the HMI device against unintended update of the operating system and overwriting the project data.
- "Transfer channel:" Selection list to define the data channel. Selection options:
 - "Ethernet" (default setting): Standard Ethernet protocol is used for the transfer.
 - "PN/IE": Transfer is performed via PROFINET or Industrial Ethernet. This allows the HMI device to be accessed as an alternative to direct communication as follows:
 - ◊ Via routing through a controller
 - ◊ Via a switch or via a router in the local network

If possible, use the "Ethernet" data channel, which offers higher performance than "PN/IE".

Only use the "Ethernet" data channel for the "Update operating system via WinCC" function.

Encrypted project transfer

A screenshot of a password input field for encrypted project transfer. It shows a text box with the label "Password:" and a "Set Password" button.

- "Password": Password for the encrypted transfer of the project. The password must match the password specified in the configuration.
To set the password, tap the input box. The password must have a length from 8 to 120 characters and the following character must be included:
 - At least one letter (A - Z, a - z)
 - At least one number (0 - 9)
 - At least one special character (! # \$ % & () * + , - . / : ; < = > ? @ [\] _ { | } ~ ^ ` " ')
- "Set Password": Button to save the password for the encrypted project transfer.

For more information on encrypted project transfer, refer to the TIA information system.

5.9.2 Update OS

Use "Update OS" to update the operating system of the HMI device. The operating system is contained in several firmware files. The master file has the extension ".fwf". The number of additional files varies; these files have the file name of the master file and a sequential number (".0", ".1", ".2", etc.) as an extension.

The "Update OS" function is available under both "System Properties" and "Service and Commissioning".

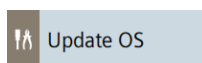
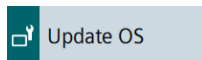

NOTICE

Updating the operating system deletes data on the HMI device

Project, parameter sets and user administration will be deleted when you update the operating system on the HMI device.

Before updating the operating system, backup the data on the HMI device, if necessary.

All settings, except the following settings which you changed in the Control Panel before updating the operating system, are retained even after the update of the operating system:

- The external interfaces become activated again (default setting), see section "Hardware interfaces (Page 100)".
- The time zone is reset to the default setting "(UTC) Coordinated Universal Time", see section "Date and time (Page 101)".

Use a SIMATIC SD memory card with 32 GB or more or an industrial USB flash drive to load the firmware.

Firmware files for the HMI devices can be downloaded from the Internet (<https://support.industry.siemens.com/cs/ww/en/view/109746530>). Observe the documentation included with the download.

Note

Do not rename firmware files

If you change the name of the firmware files, the operating system can no longer be updated with these firmware files. The firmware files become unusable. Leave the name of the firmware files unchanged.

Copy firmware files completely

If you copy the firmware files, be sure to also copy the master file ".fwf" together with all associated firmware files (".0", ".1", ".2", etc.).

If one of the files is missing, the operating system cannot be loaded.

Alternatively to the "Update OS" function in the Control Panel, you can use the "Update OS" function in WinCC.

Panel Information

Device type:	MTP1500 Unified Comfort
Image version:	V16.00.00.01_04.01

- "Device type": HMI device type designation.
- "Image version": Version of the firmware and operating system.

Select storage media for OS update

X61 (Size:7.6 GB/Free:5.04 GB) ▼

Use the selection list to select the storage medium on which the firmware file is located.

Firmware files on external storage

Name	Path	Image Version
UCP_7_22_V16_0.fwf	/media/simatic/data-s...	V16.00.00.01_04.01

Update OS

- The list shows all firmware files that can be loaded into the HMI device.
Select the desired firmware master file (.fwf) from the list.
- "Update OS": Button for starting the loading process.
The HMI device restarts after the "Update OS" button is pressed. The loading process then begins.
A dialog with a progress bar is displayed on the HMI device for each firmware file.
The HMI device is restarted again after the completion of the loading process.
The main window of the Control Panel is displayed after the restart. The operating system on the HMI device is updated.

5.9.3 Backup

Under "Backup" you can back up the operating system, applications and data from the flash memory of the HMI device to an external storage medium.

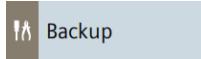

Use a SIMATIC SD memory card ≥ 32 GB or an industrial grade USB stick as storage medium.

Depending on the amount of data on the HMI device, a backup may require up to 20 GB of memory. Make sure that the storage medium has sufficient free space. Recommendation: At least 5 GB of free space on the storage medium.

Remote access to the HMI device is not possible during the backup process.

Do not turn off the HMI device during the backup process.

Choose backup type

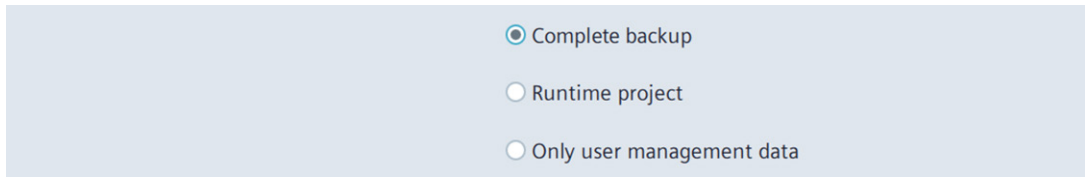

Select one of the following options:

- "Complete backup": Backup all data of the HMI device including operating system, project and user administration.
- "Runtime project": Backing up the project of the HMI device.
- "Only user management data": Backing up the user administration of the HMI device.

Backup file

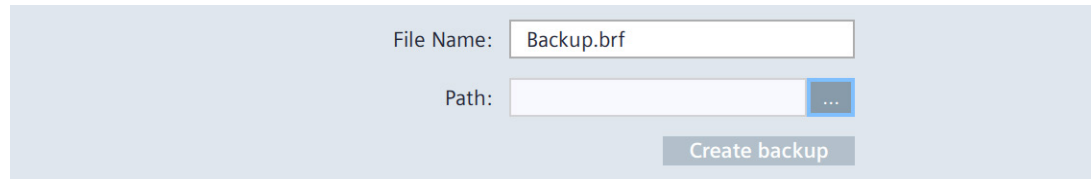

The screenshot shows a light blue background with a white form. The form has two input fields: 'File Name:' with the text 'Backup.brf' and 'Path:' with a blue button containing three dots. Below the fields is a grey button labeled 'Create backup'.

- "File Name": Name of the backup. Select a name that best identifies the backup. A backup includes multiple files. The master file has the extension ".brf". The number of additional files varies; these files have the file name of the master file and a sequential number (".0", ".1", ".2", etc.) as an extension.
 - "Path": Destination path for the backup, storage medium and path are selected using the "..." button.
 - "Create backup": Button to start the backup process.
 - The HMI device restarts after the "Create backup" button is pressed.
 - The backup is started and a dialog with a progress bar is displayed for each backup file.
 - The HMI device is restarted again after the completion of the backup process.
 - The main window of the Control Panel is displayed after the restart.
- The data of the HMI device are saved on the storage medium.

Note

Do not rename backup files on the data storage medium

If you change the name of the backup files on the data storage medium, these backup files can no longer be loaded into the HMI device using the "Restore" function.

Leave the name of the backup files on the data storage medium unchanged.

Copy backup files completely

If you copy the backup files, be sure to also copy the master file ".brf" together with all associated backup files (".0", ".1", ".2", etc.).

If one of the files is missing, the backup cannot be loaded.

See also

Accessories (Page 16)

Backup and restore (Page 128)

5.9.4 Automatic backup

Under "Automatic backup" you can activate or deactivate the "Automatic backup" function.

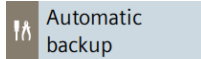

If the "Automatic backup" function is activated the data of the HMI device is automatically backed up to the system memory card during operation in form of a backup including firmware. The data on the system memory card are permanently synchronized with the data of the HMI device. You can insert the system memory card into any HMI device of the same type. After data is copied and a restart has been performed, the HMI device of the same type is operational.

Note

Only use SIMATIC SD memory card \geq 32 GB as system memory card

Only the SIMATIC SD memory card \geq 32 GB is permitted for use as a system memory card. All other memory cards are not recognized as system memory card by the HMI device.

System memory card in a device of a different type

If you use the system memory card of an HMI device in an HMI device of a different type, an error message is displayed.

For service purposes, use a system memory card only in HMI devices of the same type.

Do not remove the system memory card for "automatic backup" during operation

If the "Automatic backup" function is activated, the system memory card may only be removed when the HMI device is switched off.

Automatic backup and updating the operating system

If you want to update the operating system of the HMI device and have activated the "automatic backup" function, leave the system memory card in the HMI device before and after the entire update.

The "Automatic Backup" function is deactivated in the delivery state of the device.

The "System memory card plugged" dialog box is displayed as soon as you insert a memory card into the system memory card slot. To go to the Control Panel, click "OK". There you can activate a new system memory card or restore data from a prepared system memory card.

Automatic Backup

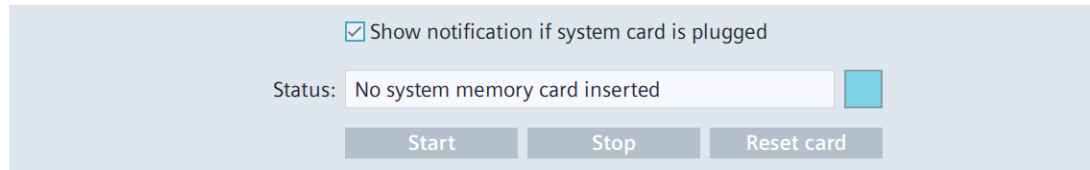

- "Show notification if system card is plugged": Option to enable or disable the automatic message "System memory card plugged".
- "Status": Status information on the system memory card in slot X50.
 - "No system memory card inserted": There is no system memory card in slot X50.
 - "System memory card is invalid": There is an unsupported or incorrectly formatted system memory card in slot X50.
 - "Backup on system memory card is not device compatible": The system memory card of a non-identical HMI device or an HMI device with different HMI device image is located in slot X50.
 - "Ready for automatic backup": There is a correctly formatted SIMATIC SD memory card in slot X50.
 - "Starting automatic backup": Status message after pressing the button "Start", the system memory card is being prepared.
 - "Synchronizing data": Status message during preparation of the system memory card.
 - "Automatic backup active": Status message when preparation of the system memory card has been completed, the "Automatic backup" function was successfully activated.
 - "Resetting system memory card": The system memory card is formatted.
- "Start": Button to activate the "Automatic backup" function.
- "Stop": Button to deactivate the "Automatic backup" function.
- "Reset card": Button for formatting the system memory card.

Use cases

We differentiate between the following use cases, depending on whether the system memory card was previously used for automatic backup.

Activating automatic backup for an empty system memory card

1. Insert the SIMATIC SD memory card without automatically saved data into slot X50. The "System memory card plugged" dialog box is displayed.

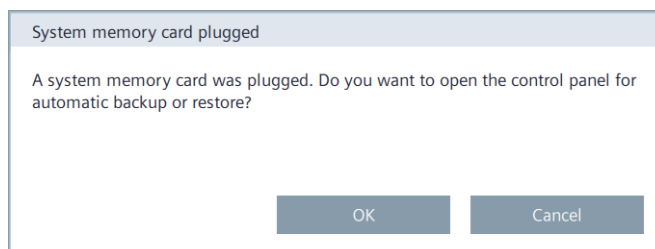

- 2. Press "OK".
The window "Service and Commissioning" > "Automatic Backup" opens in the Control Panel.
"Ready for automatic backup" is displayed in the "Status" field.

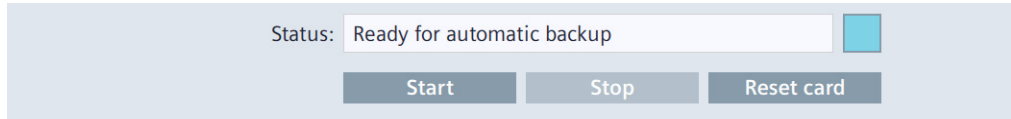

- 3. Press the "Start" button.
The "Start automatic backup" dialog box is displayed.

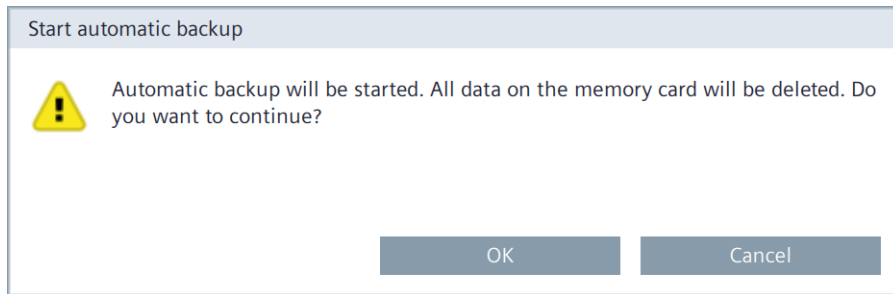

- 4. Press "OK".
The status message "Starting automatic backup" is displayed. The system memory card is being prepared.

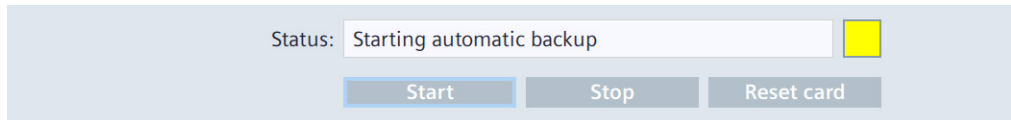

Note

Do not remove the system memory card during the preparation.

If you remove the system memory card from the HMI device during the preparation, the system memory card cannot be used for automatic backup. Leave the system memory card in its slot during the preparation process.

The status message "Synchronizing data" is displayed during the preparation.

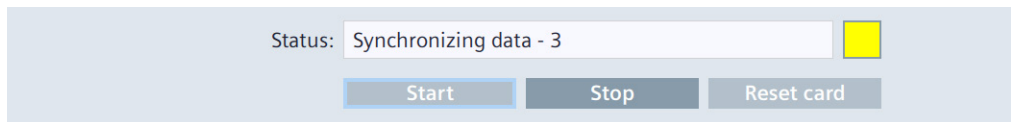

When the preparation is complete, the status message "Automatic backup active" is displayed.

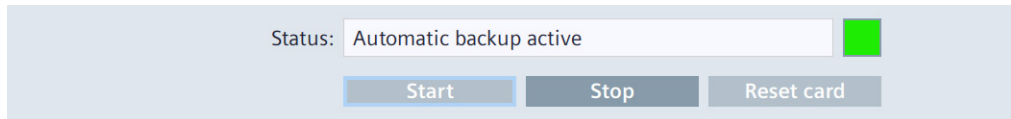

You have successfully activated the "Automatic backup" function.

Using automatic backup of a system memory card

If a system memory card already contains automatically backed-up data, the corresponding backup must first be loaded. Automatic backup can then be continued.

1. Insert the SIMATIC SD memory card with automatically backed-up data in slot X50.
The "System memory card plugged" dialog box is displayed.

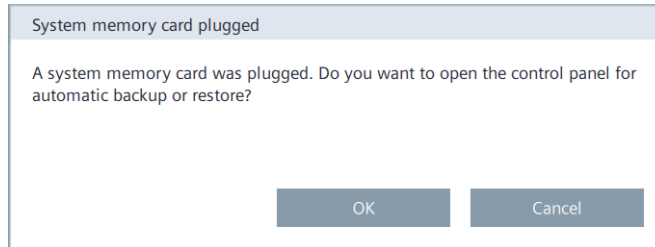

2. Press the "OK" button.
The window "Service and Commissioning" > "Restore" opens in the Control Panel.

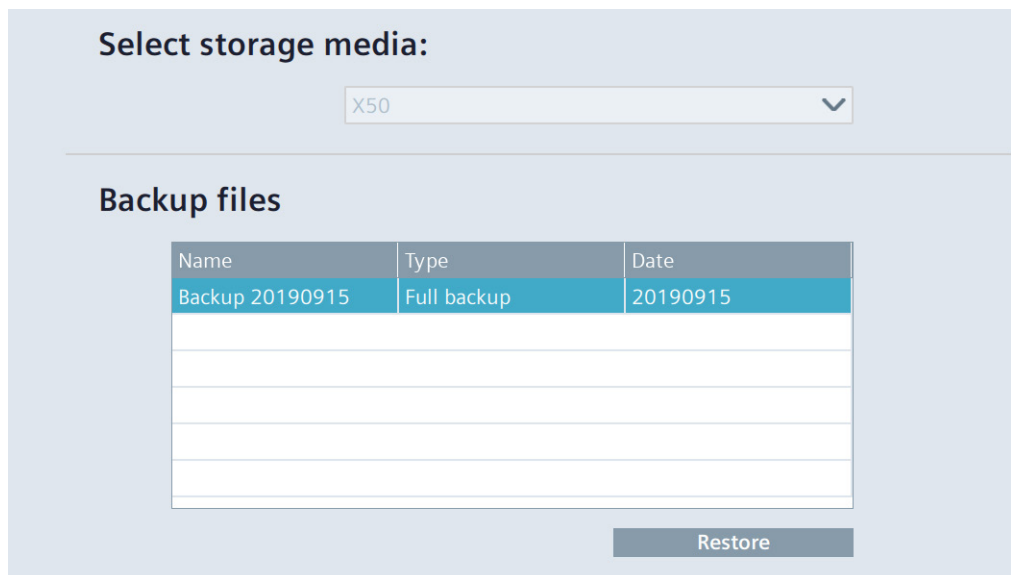

3. Select a backup file and press the "Restore" button.
The following dialog box indicates that all data on the device will be overwritten.

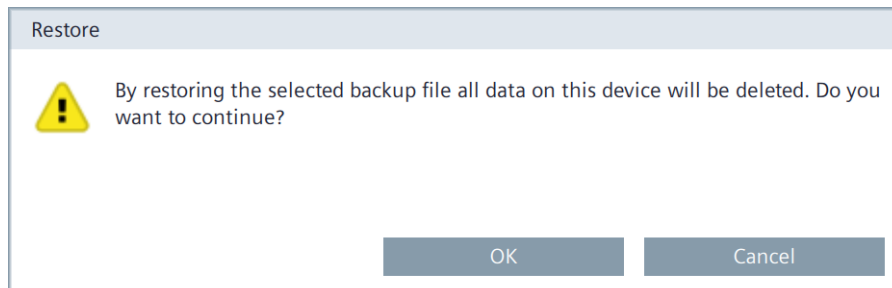

4. Start the restore process via the "OK" button or cancel the process via the "Cancel" button.

The HMI device restarts after the "OK" button is pressed. The restore process then begins.

During the restore process, the "Automatic backup restore" dialog box is displayed with a progress bar.

The HMI device is restarted again after the completion of the restore process.

The main window of the Control Panel is displayed after the restart.

After the data transfer, the state of the HMI device is the same as that of the HMI device used to generate the automatic backup.

To continue the automatic backup on the HMI device, reactivate the "Automatic backup" function under "Service and Commissioning" > "Automatic Backup" in the Control Panel.

See also

Accessories (Page 16)

Backup (Page 106)

Changing the memory card (Page 72)

5.9.5 Restore

Under "Restore", you can restore the backup of an HMI device from a storage medium.

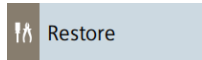

Remote access to the HMI device is not possible during the restore process.

A restore operation deletes the flash memory of the HMI device on confirmation. The data backed up on the storage medium is then transferred.

NOTICE

Data loss

All data on the HMI device, including the project and HMI device password, is deleted during a restore operation. License keys are only deleted after a security prompt.

Back up your data before the restore operation, if necessary.

Select storage media



Select the storage medium on which the backed-up data is stored.

Backup files

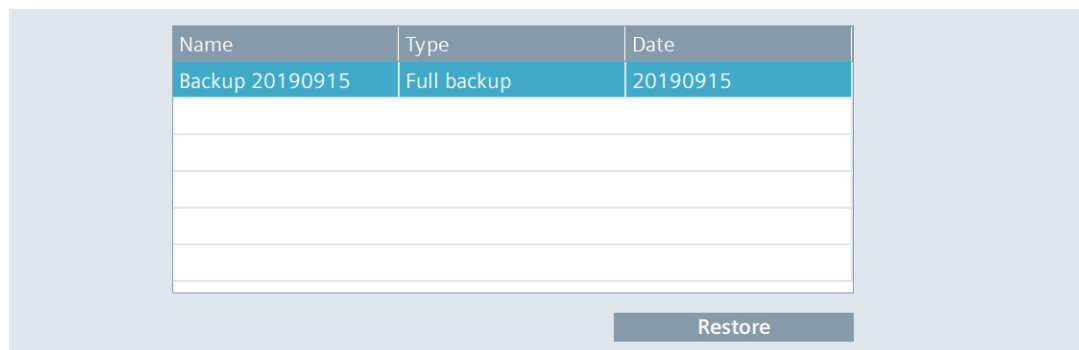

Name	Type	Date
Backup 20190915	Full backup	20190915

Restore

- The list shows all backups that can be loaded to the HMI device.
Select the desired backup from the list.
- "Restore": Button to start the restore process.
The HMI device restarts after the "Restore" button is pressed. The restore process then begins.
Do **not** switch off the HMI device during the restore process and do **not** disconnect the data source from the HMI device.
During the restore process, a dialog with a progress bar is displayed for each backup file loaded.
The HMI device is restarted again after the completion of the restore process.
The main window of the Control Panel is displayed after the restart.
The data from the storage medium is now restored on the HMI device.

Note

System behavior when the process is interrupted

If the restore process cannot be completed due to a power failure or an interrupted data connection, for example, the HMI device starts in maintenance mode and the factory settings must be restored.

See also

Resetting an HMI device to factory settings via ProSave (Page 133)

5.9.6 Trace forwarder

You specify whether or not trace outputs can be displayed under "Trace forwarder".

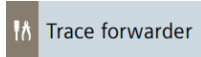

Trace forwarder

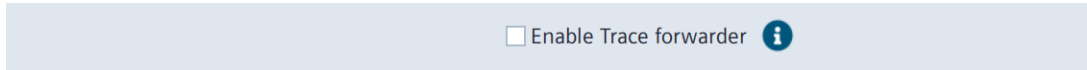

"Enable Trace forwarder": Option to enable or disable the "Tracing" function. The default setting is "Disabled".

Enable "Tracing" for diagnostics and service purposes, e.g. to display trace outputs from scripts. If you start the HMI device in maintenance mode, the "Tracing" function is automatically enabled.

See also

FAQ on configuring Trace Viewer

<https://support.industry.siemens.com/cs/ww/en/view/109777593>

5.10 Apps

The following options are available for managing apps on the HMI device under "Apps":

- Install or uninstall SIMATIC Apps via "SIMATIC Edge" or change their settings.
- Start pre-installed Apps under "Add-ons" or change their settings.
- Uninstall and start pre-installed apps via the "App management" under "Settings" or change their settings.

The following figure shows an example of the delivery state of an HMI device.

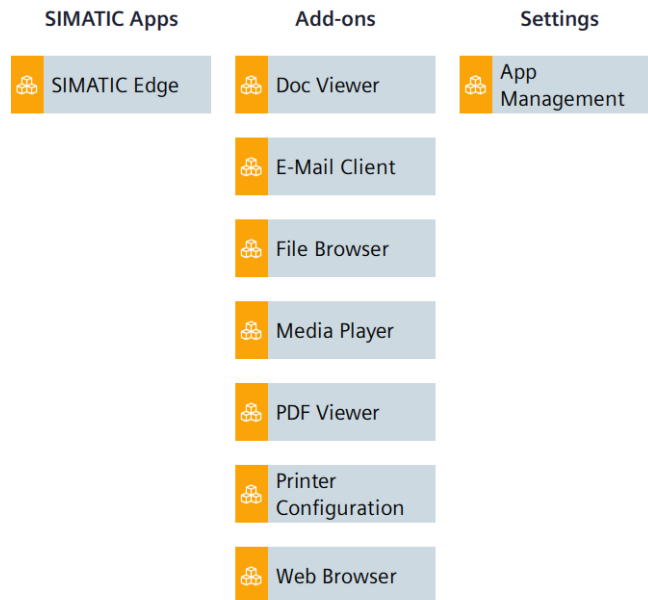

To make the settings for an app or to manage the apps, select an entry under "SIMATIC Apps", "Add-ons" or "Settings".

The following entries are available in the above example for the delivery condition:

"SIMATIC Apps"

- SIMATIC Edge (Page 116)

"Add-ons"

- Doc Viewer
- E-Mail Client
- File Browser
- Media Player
- PDF Viewer
- Printer Configuration
- Web Browser

You can find the description of the settings for the apps under "Add-ons" in section "Add-ons (Page 117)".

"Settings"

- App Management (Page 119)

Note

Data input in apps

For data input in apps, open the floating screen keyboard from the taskbar, see section "Using the taskbar (Page 67)".

5.10.1 SIMATIC Edge

Under "SIMATIC Edge", you can manage the settings for "SIMATIC Edge" and the Edge apps installed on the HMI device.

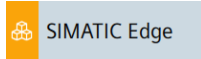

SIMATIC Edge

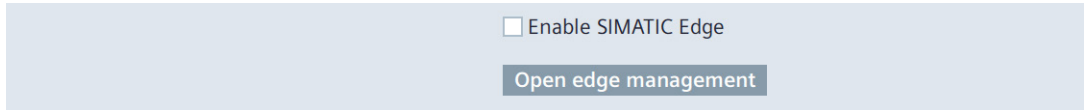

- "Enable SIMATIC Edge": Option to activate or deactivate the Edge functionality. The default setting is "deactivated".
- "Open edge management": Button to open the local Edge Management web page.

To manage Edge apps on the HMI device, log in to Edge Management using the "Sign in" link.



Log in as a user who has been assigned the "Control Panel access" function right in the configuration.

Siemens Industrial Edge

You can find detailed information on Siemens Industrial Edge and Edge Management on the Edge Management website in the programming and operating manual "Siemens Industrial Edge (<https://support.industry.siemens.com/cs/ww/en/view/109773259>)".

5.10.2 Add-ons

Under "Add-ons" you will find pre-installed apps such as "Doc Viewer", "E-Mail Client", "File Browser", "Media Player", "PDF Viewer", "Printer Configuration" and "Web Browser". The following figure shows the symbol of the "Doc Viewer" as an example.

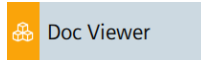

All pre-installed apps under "Add-ons" have a "Start" button, the "Autostart" function is also available for most apps.

<App name>

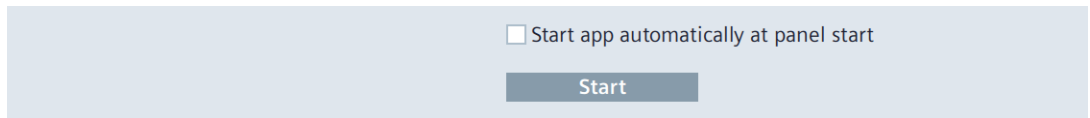

- "Start app automatically at panel start": Option to activate or deactivate the "Autostart" function for the respective app, not available for all apps. If this option is selected, the app starts immediately after the start of the Control Panel. The app is displayed in the foreground of the Control Panel.
- "Start": Button for manually starting the respective app.

The following table shows a short description of the pre-installed apps.

App	Description	"Autostart" available
Doc Viewer	With the "Doc Viewer" you can view and edit documents such as text or Word files. Note: Do not use the "Doc Viewer" to edit files that have been saved via the Runtime software or a system function. These files include, for example, parameter sets that were exported to a .tsv file.	Yes
E-Mail Client	With the "E-Mail Client" you can connect to your e-mail accounts, receive e-mails, send e-mails and import mail files from other applications. The first time the "E-Mail Client" is called, a configuration wizard is started. During configuration, enable SSL encryption for sending and receiving e-mail.	Yes
File Browser	With the "File Browser", you can find and manage files in the internal memory and on storage media of the HMI device.	No
Media Player	You can use the "Media Player" to play audio and video files.	Yes
PDF Viewer	You can use the "PDF Viewer" to view PDF documents.	Yes
Printer Configuration	You open the local web page "CUPS" for the printer management via the "Printer Configuration". For information on connecting a printer and on the "CUPS" web page, see section "Connecting a printer (Page 51)".	No
Web Browser	The "Web Browser" provides you with access to the Internet.	Yes

Starting pre-installed apps from the project

However, you can also start the pre-installed apps via an operating element in the project. To do this, use the "StartProgram" system function in your configuration.

Enter the following command under "Program name": `"/opt/siemens/App_Restriction/<Name of start script>`

Depending on the desired app, use of the following scripts for the "`<Name of start script>`":

App to be started	Associated start script
Doc Viewer	runLibreoffice.sh
E-Mail Client	runEvolution.sh
File Browser	runThunar.sh
Media Player	runVLC.sh
PDF Viewer	runOkular.sh
Web Browser	runChromium.sh

Under "Program parameters", you can specify which file is to be opened.

Example

Open the "MyPDFfile.pdf" from a USB stick connected to interface X61:

- "Program name": `"/opt/siemens/App_Restriction/runOkular.sh"`
- "Parameter": `"/media/simatic/X61/MyPDFfile.pdf"`

See also

App Management (Page 119)

5.10.3 App Management

You can uninstall pre-installed apps or change their settings under "App Management".

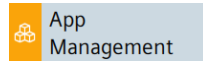

Manage apps



- The list shows all apps installed under "Add-ons".
- "Uninstall": Button to uninstall the selected app. Recommendation: Uninstall apps that you do not need.

Note

Uninstallation cannot be undone

An uninstalled app cannot be installed again. To get back all apps pre-installed in the delivery state, you must restore the factory settings of the HMI device.

- "Configure": Button to change the settings of the selected app, see section "Add-ons (Page 117)".

See also

Resetting an HMI device to factory settings via ProSave (Page 133)

Transferring data

6.1 Overview

Configuration phase

In the configuration phase, the automation process is visualized with the configuration software in the form of a project. The plant screens of the project contain operating elements and display controls for values and alarms which provide information about process statuses. After the configuration phase, the project is transferred to HMI device, followed by the process control phase.

Transferring the project to the HMI device

The project must be transferred to the HMI device to be used in process control. You have the following options for the transfer:

- Transfer the project from a configuration PC to the HMI device, see section "Transferring a project with WinCC (Page 125)".
- Insert a prepared system memory card from an identical HMI device, see section "Automatic backup (Page 108)".
- Restore the backup file of an identical HMI device from an external storage medium, see section "Restore (Page 112)".

Updating the operating system of the HMI device

The firmware and operating system version of the HMI device must be compatible with the firmware and operating system version of the installed WinCC software. If this is not the case, an error message is output before the transfer.

You can update the operating system of the HMI device in the following ways:

- Transfer of the operating system together with the project from a configuration PC to the HMI device, see section "Transferring a project with WinCC (Page 125)".
- Transfer of the operating system from a configuration PC to the HMI device, see section "Updating the operating system via WinCC (Page 132)".
- Transfer of the operating system from a data storage medium to the HMI device, see section "Update OS (Page 104)".
- Insert a prepared system memory card from an identical HMI device, see section "Automatic backup (Page 108)".
- Restore the backup file of an identical HMI device from an external storage medium, see section "Restore (Page 112)".

If the operating system cannot be updated with the above options, then you must reset the HMI device to factory settings.

You can reset the HMI device to the factory settings in the following ways:

- If the HMI device starts and you have access to the Control Panel, proceed as described in section "Resetting an HMI device to factory settings via ProSave (Page 133)".
- If the HMI device does not start or you do not have access to the Control Panel of the HMI device, then start the HMI device in maintenance mode, see section "Using the maintenance mode (Page 136)".

Process control phase

In the process control phase, the HMI device is connected online to a controller, and you can operate and monitor the plant.

Commissioning and recommissioning

Initial commissioning and recommissioning differ as follows:

- During initial commissioning, no project is available on HMI device. The HMI device has this status when delivered and after updating of the operating system.
- When recommissioning, the project already on the HMI device is replaced.

6.2 Operating modes

Operating modes

The HMI device can be in the following operating modes:

- Offline
- Online
- Transfer

Changing the operating mode

The configuration engineer must have configured appropriate operating elements to allow a change of the operating mode on the HMI device during ongoing operation.

If available, you can find additional information in your plant documentation.

"Offline" operating mode

In this mode, there is no communication between the HMI device and the controller. Even though the HMI device can be operated, it cannot exchange data with the controller.

"Online" operating mode

In this operating mode, there is a communication connection between HMI device and the controller or between HMI device and the configuration PC.

- In online operation between HMI device and controller, operate the plant with the HMI device according to the configuration.
- In online operation between HMI device and configuration PC, extended functions such as "Online & diagnostics" are available.

"Transfer" mode

In this mode, you can transfer a project from the configuration PC to the HMI device or backup and restore HMI device data, for example.

6.3 Data transmission options

The following table shows the options for data transmission between an HMI device and the configuration PC.

Interface	PROFINET (LAN)			USB	SD
	Protocol	X1	X2	X61 ... X64	X51
Backup and Restore	PN/IE *	x	x	x	x
	Ethernet	x	x		
Update operating system	PN/IE	-	-	x	x
	Ethernet	x	x		
Update operating system and Reset to factory settings	PN/IE	-	-	-	-
	Ethernet	x	x		
Transfer a project	PN/IE	x	x	-	-
	Ethernet	x	x		
S7 communication	PN/IE	x	x	-	-
NTP, Web Client, Internet access, Sm@rtClient/Sm@rtServer, Industrial Edge	Ethernet	x	x	-	-

* The PN/IE protocol is not recommended for backup and restore due to its low bandwidth.

The X20 RS422/485 interface is designed for connecting controllers from other manufacturers. Do not use the X20 interface for data transfer between the configuration PC and the HMI device.

6.4 Setting the PG/PC interface

To establish Ethernet communication between the configuration PC and the HMI device, the PG/PC interface must be set correctly.

Procedure

1. Open the Control Panel of the configuration PC.
2. Click on "Set PG/PC interface".
3. Select the entry "S7ONLINE (STEP 7)" in the first tab under "Application access point".
4. Select your Ethernet adapter with the name suffix ".TCPIP.Auto.1" under "Used interface parameterization".

Result

The PG/PC interface is set, you can connect the configuration PC to the HMI device via Ethernet and transfer data.

6.5 Transferring a project with WinCC

This section describes how to transfer a project to the HMI device via the configuration software WinCC . Before the transfer, the software checks whether the project can be loaded onto the HMI device. The result of the check is displayed in the "Load preview" dialog box. If it is not possible to load the project, you can change the transfer settings in the "Load preview" dialog box. To load the project, use the configuration software with which the HMI device was configured.

Note

Existing parameter sets are deleted during loading

When loading a project into an HMI device, all parameter sets that were saved in the internal memory or on an external storage medium from the previous project are deleted. Before loading the project, save the parameter sets entered from the previous project.

Procedure

1. If a project is running on the HMI device, close the project.
2. Connect the HMI device to the configuration PC via the X1 or X2 interface. If possible, use the X2 interface with the highest bandwidth.
3. In the Control Panel of the HMI device, select "Network and Internet".
Ensure that the port selected for data transmission is activated for the interface used ("Activate this port for use").
4. In the Control Panel of the HMI device, select "Service and Commissioning" > "Transfer".
5. Make sure that the "Enable transfer" option is activated, and select the setting "Ethernet" or "PN/IE" under "Transfer channel" .
6. Open the configuration software with which the HMI device was configured.
7. Open the project you want to transfer to the HMI device.
Make sure that the port of the interface used for data transfer is activated in the project configuration. You can find this setting under the advanced options of the interface parameters in the device configuration.
8. In the project tree, select the HMI device whose project you want to transfer.
9. Select the "Download to device > Software" command in the shortcut menu of the HMI device.
10. If there is no connection to the HMI device, the connection dialog box is displayed. In this case, select the "Ethernet" or "PN/IE" interface protocol. The setting must match the setting in the Control Panel of the HMI device. Click the "Connect" button and then click "Load".

If the connection was established successfully, the "Load preview" dialog box is displayed. The following figure shows an example.

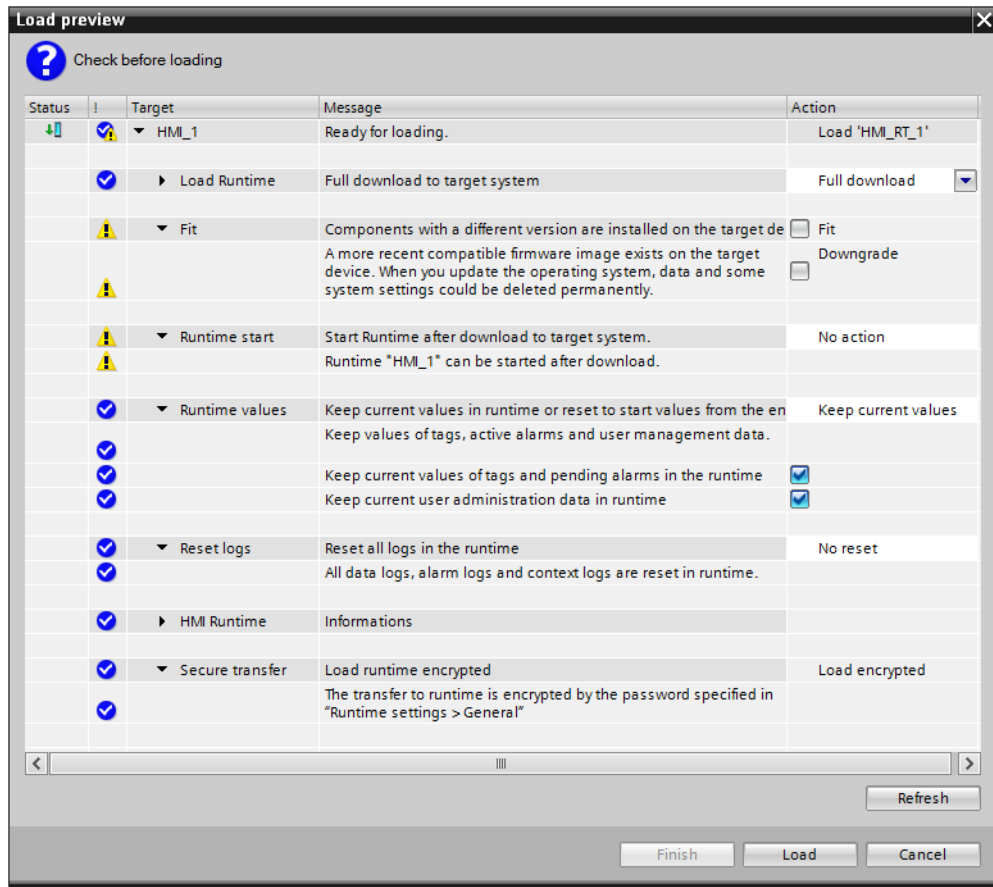

The "Load preview" dialog box contains alarms of type "Information" and "Warning".

✓	Information	The setting is compatible, the project can be loaded.
⚠	Warning It is not possible to change the setting in the "Action" column.	The setting on the HMI device differs from the settings in the configuration software. The project can still be loaded with this setting.
	Warning The setting in the "Action" column can be changed.	Note that the setting on the HMI device is different from the setting in the configuration software. The project can be loaded after the setting in the "Action" column has been changed.
✗	Error It is not possible to change the setting in the "Action" column.	The project cannot be loaded. Adapt the setting in the configuration or on the HMI device.
	Error The setting in the "Action" column can be changed.	The project cannot be loaded. The project can be loaded after the setting in the "Action" column has been changed.

11. In the "Load preview" dialog box, specify the options for the loading process.
 - "Load Runtime": Selection list for overwriting or keeping the runtime software on the HMI device.
 - "Fit": In this area you define whether the version of individual components should be adjusted if the version of the component in the configuration differs from the version of the component on the HMI device. If the version on the HMI device is more recent, you can select "Downgrade", otherwise "Upgrade".
 - "Runtime start": Selection list that allows you to specify whether the runtime software is started on the HMI device after loading or not.
 - "Runtime values": In this area you define whether the data of tags, alarms and the user administration should be retained on the HMI device or not. If the respective option is selected, the data on the HMI device will be retained. If the respective option is cleared, then the data on the HMI device will be deleted or overwritten by the data in the configuration. If you want to update user administration on the HMI device, the "Keep current user administration data in runtime" option must be cleared.
 - "Reset logs": Selection list for resetting or keeping all logs. If you select "Reset all", the data of all data logs, alarm logs and context logs are deleted on the HMI device.
 - "HMI Runtime": This area contains information about runtime and firmware/operating system version of the HMI device.
 - "Secure transfer": In this area you determine whether the project is transferred encrypted or not. Additional information is available in the section "Transfer (Page 103)".

If a warning with light red text is no longer displayed, the "Download" icon in the left "Status" column of the "Load preview" dialog is displayed in green and the "Load" button is activated.

12. Click "Load" to transfer the project to the HMI device.

The project is transferred to the HMI device. If errors or warnings occur during the transfer, alarms are displayed in the Inspector window under "Info> Download". After the successful transfer, the alarm "Load finished (errors: 0; warnings: 0)" is displayed.
13. In the Control Panel of the HMI device, select "Service and Commissioning" > "Transfer".
14. Clear the "Enable Transfer" option to protect the HMI device from an unintended transfer.

Result

The project is located on the HMI device and can be started. After the transfer, test the operating elements and screen changes in the "offline" mode. If all operating elements and screen changes function correctly, you can switch the HMI device to "online" mode.

6.6 Backup and restore

During data backup, the contents of the internal memory are saved in a backup on a configuration PC or on an external storage medium. Alarm logs and process value archives are not included in the backup. These archives are stored separately on an external storage medium. Back up these logs manually if required. If the HMI device is integrated in a network, you can also back up the data on a network drive.

The following data are saved in a backup:

- Operating system
- Control Panel settings
- Installed apps
- SIMATIC Edge data
- Project and parameter sets
- User administration

A backup includes several files. The master file has the extension ".brf". The number of additional files varies; these files have the file name of the master file and a sequential number (".0", ".1", ".2", etc.) as an extension.

Backup to the configuration PC

To back up the data of the HMI device, follow these steps:

1. If a project is running on the HMI device, close the project.
2. Connect the HMI device to the configuration PC via the X1 or X2 interface. If possible, use the X2 interface with the highest bandwidth.
3. In the Control Panel of the HMI device, select "Network and Internet". Ensure that the port selected for data transmission is activated for the interface used ("Activate this port for use").
4. In the Control Panel of the HMI device, select "Service and Commissioning" > "Transfer".
5. Make sure that the "Enable transfer" option is activated, and select the setting "Ethernet" or "PN/IE" under "Transfer channel" .
6. Open the configuration software with which the HMI device was configured.
7. In the project tree, select the HMI device whose data are to be backed up.
8. Select the "Backup" command in the menu "Online > HMI Device maintenance" .
9. If there is no connection to the HMI device, the connection dialog box is displayed. In this case, select the "Ethernet" or "PN/IE" interface protocol. The setting must match the setting in the Control Panel of the HMI device. Click on the "Connect" button and then on "Create".

If the connection was successfully established, the "Complete backup" dialog box with information about the project and the HMI device is displayed.

10. Click on the "Backup" button.
The "SIMATIC ProSave [Backup]" dialog box is displayed.
11. Under "Data type", select which data of the HMI device should be saved.
12. Enter the file name of the backup in the "Save as" field.
13. Click "Start Backup".

The backup process is started. A dialog with a progress bar is displayed for each backup file both in ProSave and on the HMI device. The update operation can take time, depending on the connection selected.

Note**Do not rename backup files on the data storage medium**

If you change the name of the saved backup files, these backup files can no longer be loaded into the HMI device using the "Restore" function. The backup files become unusable.

Leave the name of the backup files on the data storage medium unchanged.

Copy backup files completely

If you copy the backup files, be sure to also copy the master file ".brf" together with all associated backup files (".0", ".1", ".2", etc.).

If one of the files is missing, the backup cannot be loaded.

Backup to data storage medium on the HMI device

As an alternative to the configuration PC, you can also save the data via the Control Panel of the HMI device on a data storage medium that is directly connected to the HMI device, see section "Backup (Page 106)".

Restore from the configuration PC

To restore the data of the HMI device, follow these steps:

1. If a project is running on the HMI device, close the project.
2. Connect the HMI device to the configuration PC via the X1 or X2 interface. If possible, use the X2 interface with the highest bandwidth.
3. In the Control Panel of the HMI device, select "Network and Internet".
Ensure that the port selected for data transmission is activated for the interface used ("Activate this port for use").
4. In the Control Panel of the HMI device, select "Service and Commissioning" > "Transfer".
5. Make sure that the "Enable transfer" option is activated, and select the setting "Ethernet" or "PN/IE" under "Transfer channel".
6. Open the configuration software with which the HMI device was configured.

7. In the project tree, select the HMI device whose data you want to restore.
8. Select the "Restore" command in the menu "Online > HMI Device maintenance" .
9. If there is no connection to the HMI device, the connection dialog box is displayed. In this case, select the "Ethernet" or "PN/IE" interface protocol. The setting must match the setting in the Control Panel of the HMI device. Click the "Connect" button and then click "Load".

If the connection was established successfully, the "Complete restore" dialog box with information about the project and the HM device is displayed.

10. Click the "Restore" button.
The "SIMATIC ProSave [Restore]" dialog is displayed.
11. Under "Open from ..." enter path and file name of the backup.
12. Click "Start Restore".

The restore process is started. A dialog with a progress bar is displayed both in ProSave and on the HMI device for each backup file loaded. The update operation can take time, depending on the connection selected.

Do **not** switch off the HMI device during the restore process and do **not** disconnect the data source from the HMI device.

Note

System behavior when the process is interrupted

If the restore process cannot be completed due to a power failure or an interrupted data connection, for example, the HMI device starts in maintenance mode and the factory settings must be restored.

In this case, follow the procedure starting with step 6 in section "Resetting an HMI device to factory settings via ProSave (Page 133)".

Restore from a data storage medium on the HMI device

As an alternative to the configuration PC, you can also restore the data via the Control Panel of the HMI device from a data storage medium that is directly connected to the HMI device, see section "Restore (Page 112)".

6.7 Updating the operating system

6.7.1 Overview and important notes

The firmware and operating system version of the HMI device must be compatible with the firmware and operating system version of the installed WinCC software. If this is not the case, then you must update the operating system. If the operating system on the HMI device is no longer functional, you must reset the HMI device to factory settings.

NOTICE

Updating the operating system deletes data on the HMI device

Project, parameter sets and user administration will be deleted when you update the operating system on the HMI device.

Before updating the operating system, backup the data on the HMI device, if necessary.

All settings, except the following settings which you changed in the Control Panel before updating the operating system, are retained even after the update of the operating system:

- The external interfaces become activated again (default setting), see section "Hardware interfaces (Page 100)".
- The time zone is reset to the default setting "(UTC) Coordinated Universal Time", see section "Date and time (Page 101)".

When the operating system is reset to factory settings, all data of the HMI device is deleted and all settings in the Control Panel are reset to factory settings.

The operating system is contained in several firmware files. The master file has the extension ".fwf". The number of additional files varies; these files have the file name of the master file and a sequential number (".0", ".1", ".2", etc.) as an extension.

Firmware files for the HMI devices can be downloaded from the Internet (<https://support.industry.siemens.com/cs/ww/en/view/109746530>). Observe the documentation included with the download.

Note

Do not rename firmware files

If you change the name of the firmware files, the operating system can no longer be updated with these firmware files. The firmware files become unusable. Leave the name of the firmware files unchanged.

Copy firmware files completely

If you copy the firmware files, be sure to also copy the master file ".fwf" together with all associated firmware files (".0", ".1", ".2", etc.).

If one of the files is missing, the operating system cannot be loaded.

You have the following options for updating the operating system or restoring the factory settings of the HMI device, provided that access to the Control Panel of the HMI device is working:

- Updating the operating system via WinCC (Page 132)
- Updating the operating system via external storage medium (Page 104)
- Resetting an HMI device to factory settings via ProSave (Page 133)

If access to the Control Panel of the HMI device no longer works, follow the procedure described in the section "Using the maintenance mode (Page 136)".

6.7.2 Updating the operating system via WinCC

The firmware and operating system version of the HMI device must be compatible with the firmware and operating system version of the installed WinCC software. If this is not the case, then you must update the operating system.

NOTICE
Do not switch off the HMI device during data transfer
If you switch off the HMI device while the operating system of the HMI device is being updated, the HMI device no longer starts. You must repeat the procedure.
Do not turn off the HMI device during data transfer.

Procedure

To update the operating system, follow these steps:

1. If a project is running on the HMI device, close the project.
2. Connect the HMI device to the configuration PC via the X1 or X2 interface. If possible, use the X2 interface with the highest bandwidth.
3. In the Control Panel of the HMI device, select "Network and Internet".
Ensure that the port selected for data transmission is activated for the interface used ("Activate this port for use").
4. In the Control Panel of the HMI device, select "Service and Commissioning" > "Transfer".
5. Make sure that the option "Enable transfer" is selected and that the setting "Ethernet" is selected under "Transfer channel".
6. Open the configuration software with which the HMI device was configured.
7. In the project tree, select the HMI device whose operating system you want to update.
8. Select the "Update operating system" command in the menu "Online > HMI Device maintenance".

9. If there is no connection to the HMI device, the connection dialog box is displayed. In this case, select the "Ethernet" interface protocol, enter the IP address or name of the target device and click the "Connect" button and then "Update".

If the connection was established successfully, the "Update operating system" dialog box is displayed.

10. Under "Firmware file path ..." enter the path and file name of the firmware master file (.fwf) that contains the desired operating system.

11. Click "Update OS".

The update of the operating system is started. A dialog with a progress bar is displayed on the HMI device for each firmware file. The update operation can take time, depending on the connection selected.

Result

The operating system of the HMI device has been updated to the version of the selected firmware.

See also

Overview and important notes (Page 131)

Update OS (Page 104)

6.7.3 Resetting an HMI device to factory settings via ProSave

If the operating system on the HMI device is no longer functional, you must reset the HMI device to factory settings.

NOTICE
Do not switch off the HMI device during data transfer
If you turn off HMI device while the HMI device is being reset to factory settings, the HMI device will not start. You must repeat the procedure.
Do not turn off the HMI device during data transfer.

Procedure

To reset the HMI device to factory settings, follow these steps:

1. If a project is running on the HMI device, close the project.
2. Connect the HMI device to the configuration PC via the X1 or X2 interface. If possible, use the X2 interface with the highest bandwidth.

3. In the Control Panel of the HMI device, select "Network and Internet". Ensure that the port selected for data transmission is activated for the interface used ("Activate this port for use").
4. In the Control Panel of the HMI device, select "System Properties" > "Reboot".
5. Press the "Reboot in maintenance mode" button. The HMI device starts. The "Maintenance Mode" dialog box is displayed for a period of 10 minutes. In this period you can connect the HMI device to a configuration PC and reset the HMI device to factory settings with the ProSave software. If the "Maintenance Mode" dialog is not displayed, start the HMI device while pressing the "Maintenance" button, see section "Using the maintenance mode (Page 136)".
6. Open the "ProSave" software on the configuration PC in the WinCC installation directory.
7. Enter the following data in the "General" tab:
 - "Device type": Select the type of your HMI device.
 - "Connection": Select "Ethernet".
 - "Connection parameters": Specify an IP address or computer name for the HMI device. The IP address must be located in the subnet of the configuration PC.
8. Enter the following data in the "OS Update" tab:
 - Under "Opening ...", select the path and file name of the firmware master file (.fwf) containing the desired operating system.
 - Select the option "Reset to factory settings".
 - Under "MAC", enter the MAC address which is shown at the top right of the HMI device display.
 - Use the "Device status" button to display information about the device and the selected firmware.
9. Click "Update OS". A dialog box with the warning that all data on the HMI device will be overwritten is displayed.
10. Confirm the dialog box.

The update of the operating system with "Reset to factory settings" is started. A dialog with a progress bar is displayed for each firmware file both in ProSave and on the HMI device. The update operation can take time, depending on the connection selected. The HMI device restarts at the end of the process.

Result

The operating system of the HMI device has been updated to the version of the selected firmware and the HMI device is reset to factory settings.

See also

Overview and important notes (Page 131)

Device maintenance and repair

7.1 General information on maintenance and servicing

Observe the following when servicing and repairing protective equipment such as ground circuits or overvoltage protection components:

- Observe the maintenance and replacement intervals specified by the manufacturer.
- Replace plant components, including external cables, fuses and batteries only with equivalent components approved by the respective manufacturer.

7.2 Clean the glass front of the HMI device.

The HMI device is designed for low-maintenance operation. However, you should clean the glass front regularly.

Observe the information on chemical resistance (<https://support.industry.siemens.com/cs/ww/en/view/39718396>).

Important notes

Note

Avoid unintentional responses during cleaning

If you clean the glass front when it is switched on, you may cause inadvertent operations via the touch screen.

Switch off the HMI device during cleaning.

Damage to the front due to prohibited cleaning agents

The glass front may be damaged if compressed air or a steam jet is used and if aggressive solvents or abrasives are used.

Do not clean the glass front using compressed air or steam cleaners. Do not use aggressive solvents or scouring agents.

Requirement

- Damp cleaning cloth
- Dishwashing liquid or foaming screen cleaning agent

Procedure

Proceed as follows:

1. If a project is running on the HMI device, close the project.
2. Switch off the HMI device.
3. Spray cleaning agent onto the cleaning cloth.
Do not spray cleaning agent directly onto the HMI device.
4. Clean the glass front.
When cleaning the glass front, wipe from the inside to the outside.

7.3 Using the maintenance mode

Maintenance mode is used to reset the HMI to the factory settings.

When the operating system starts and the Control Panel is displayed after the HMI device is switched on, you can start the HMI device in maintenance mode by clicking the "Reboot in maintenance mode" button. Follow the description in section "Resetting an HMI device to factory settings via ProSave (Page 133)".

If the HMI starts with the boot splash screen and detects the corrupt operating system, the HMI automatically switches to maintenance mode. The "Maintenance Mode" dialog box is displayed. In this case, follow the procedure from step 6 in section "Resetting an HMI device to factory settings via ProSave (Page 133)".

If the HMI device starts with the boot splash screen and does not detect the corrupt operating system, the HMI device does **not** switch to maintenance mode. The "Maintenance Mode" dialog is **not** displayed. You must reset the HMI device to the factory settings. In this case, start the HMI device while pressing the "Maintenance" button as described in this section.

NOTICE

Operating system must be updated after startup with the "Maintenance" button

If you start the HMI device while pressing the "Maintenance" button, the HMI device is in maintenance mode. The "Waiting for Operation" and then "Waiting for Connection" dialogs are displayed in maintenance mode. The operating system **must** be updated. Even after restarting, the HMI device remains in maintenance mode until the operating system has been updated.

Only start the HMI device while pressing the "Maintenance" button if you are sure that you want to update the operating system.

Procedure

Proceed as follows:

1. Turn off the power supply of the HMI device.
2. Press the "Maintenance" button. Use a blunt, sufficiently sturdy tool made of non-conductive material, diameter approx. 5 mm.

You will find the "Maintenance" button in the opening between the two interfaces X1 and X2.

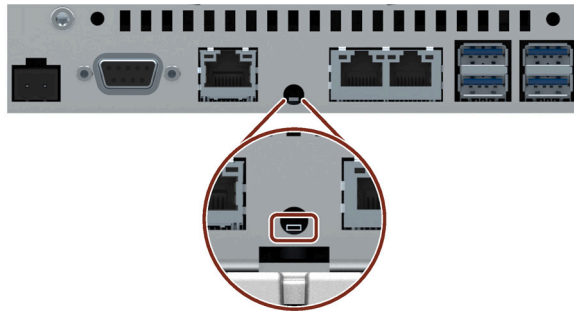

Be sure to hit the button accurately and do not slide the tool off the button.

3. Switch on the power supply of the HMI device and keep the "Maintenance" button pressed until the boot splash screen appears.

The HMI device restarts, the "Waiting for operation" and "Waiting for Connection" dialogs are displayed. Connect the HMI device to a configuration PC and reset the HMI device to the factory settings using the ProSave software. Follow the procedure from step 6 in the section "Resetting an HMI device to factory settings via ProSave (Page 133)".

7.4 Spare parts and repairs

Repairs

In case of repair, the device must be shipped to the Return Center in Erlangen. Only repair by the Return Center in Erlangen is permitted.

Depending on the work necessary to repair the device, the Center may decide to give you a credit. A credit is only granted when the sender ordered a new HMI device.

The address is:

Siemens AG
Digital Industries
Retouren-Center
c/o Geis Service GmbH, Tor 1-4
Kraftwerkstraße 25a
91056 Erlangen
Germany

Spare parts

Spare parts and accessories for the HMI device can be found in section Accessories (Page 16).

7.5 Recycling and disposal

Due to the low levels of pollutants in the HMI devices described in these operating instructions, they can be recycled.

Contact a certified disposal service company for electronic scrap for environmentally sound recycling and disposal of your old devices, and dispose of the device according to the relevant regulations in your country.

Technical information

8.1 Software license agreements

Open Source Software

Observe the software license agreements for Open Source Software on the supplied "Open Source Software License Conditions" data medium.

8.2 Labels, certificates and approvals

Note

Approvals on the rating plate

The following overview shows possible approvals.

Only the approvals specified on the rating plate apply to the device.

CE marking



The devices meet the general and safety-related requirements of the following EU directives and conform with the harmonized European standards (EN) published in the official gazettes of the European Union and confirmed in the EU Declarations of Conformity:

- 2014/35/EU "Electrical equipment for use within certain voltage limits" (Low-Voltage Directive)
- 2014/30/EU "Electromagnetic Compatibility Directive" (EMC Directive)
- 2011/65/EU "Directive of the European Parliament and of the Council of 8 June 2011 on the restriction of the use of certain hazardous substances in electrical and electronic equipment" (RoHS Directive)

When the device has Ex approval, the following also applies:

- 2014/34/EU "Equipment and protective systems intended for use in potentially explosive atmospheres" (Directive for Explosion Protection)

EU Declarations of Conformity

The EU Declarations of Conformity are available to the relevant authorities at the following address:

Siemens AG
Digital Industries
Factory Automation
DI FA AS SYS
Postfach 1963
D-92209 Amberg

You can download information on the EC Declaration of Conformity, here under the keyword "Declaration of Conformity":

Unified Comfort Panels certificates
(<https://support.industry.siemens.com/cs/ww/en/ps/26033/cert>)

UL approval

Observe the following notes:

- The device shall be supplied from an isolating source.
- Only for use in LAN, not for connection to telecommunication circuits.

Underwriters Laboratories Inc., to

- UL 61010-2-201 (E116536)
- CSA C22.2 No. 61010-2-201

or

Underwriters Laboratories Inc., to

- UL 61010-2-201 (E222109)
- CSA C22.2 No. 61010-2-201
- ANSI/ISA 12.12.01 (Hazardous Location)
- CSA C22.2 No. 213 (Hazardous Location)

Approved for use in

- Class I, Division 2, Group A, B, C, D T4 or
- Class I, Zone 2, Group IIC T4 or
- non-hazardous locations



FM Approval



Factory Mutual Research (FM) conforming to

- Approval Standard Class Number 3611, 3600, 3810, ANSI/ISA 61010-1
- CSA C22.2 No. 213
- CSA C22.2 No. 61010-1

Approved for use in

- Class I, Division 2, Group A, B, C, D T4
- Class I, Zone 2, Group IIC T4

Installation Instructions for cFMus:

WARNING – Do not remove or replace while circuit is live when a flammable or combustible atmosphere is present.

WARNING – Substitution of components may impair suitability of the equipment.

CAUTION – To prevent injury, read the manual before use. **Warning** – If the equipment is installed within an ultimate enclosure, the inner service temperature of the enclosure corresponds to the ambient temperature of the module.

WARNING – If a device is operated in an ambient temperature of more than 45 °C, the temperature of the device housing may be higher than 70 °C. The device must therefore be installed so that it is only accessible to service personnel or users that are aware of the reason for restricted access and the required safety measures at an ambient temperature higher than 45 °C.

WARNING – The equipment is intended to be installed within an enclosure/control cabinet. The inner service temperature of the enclosure/control cabinet corresponds to the ambient temperature of the module. Use cables with a maximum permitted operating temperature of at least 20 °C higher than the maximum ambient temperature.

ATEX/IECEX approval

Notes on use in hazardous areas

Observe the following FAQ regarding the use of an HMI device in hazardous areas: ATEX-FAQ (<https://support.industry.siemens.com/cs/ww/en/view/291285>)

When using the device in hazardous areas, ensure that all plugs connected to the device are secured in a captive manner, see section "Securing cables for use in hazardous areas (Page 55)".

You can find more information about explosion protection, EC/EU declarations of conformity and other certificates on the Internet at the following address:

Unified Comfort Panels certificates
(<https://support.industry.siemens.com/cs/ww/en/ps/26033/cert>)

ATEX approval

For an HMI device with "Ex" marking, the following approvals apply according to the following standards.

- Standards:
 - EN 60079-0:2018
 - EN 60079-7:2015 +A1:2018
 - EN 60079-31:2014

- Approvals:

	II 3 G	Ex ec IIC T4 Gc
	II 3 D	Ex tc IIIC T 70 °C Dc

IECEx approval

For an HMI device with "IECEx" marking, the following approvals apply according to the following standards.

- Standards:
 - IEC 60079-0:2017 (Ed. 7)
 - IEC 60079-7:2015 (Ed. 5.1)
 - IEC 60079-31:2013 (Ed. 2)

- Approvals:

	Ex ec IIC T4 Gc
	Ex tc IIIC T70°C Dc

IEC 61010-2-201

The devices meet selected requirements and criteria of the IEC 61010 standard, safety regulations for electrical equipment for measurement, control and laboratory use - Part 2-201: Special requirements for control equipment.

IEC 61131

The devices meet the requirements and criteria of IEC 61131-2, Programmable Logic Controllers, Part 2: Operating resource requirements and tests.

RCM AUSTRALIA/NEW ZEALAND



This product meets the requirements of EN 61000-6-4 Generic standards – Emission standard for industrial environments.

This product meets the requirements of the standard EN 61000-6-4 Generic standards – Emission standard for industrial environments.

KOREA

This product meets the requirements of Korean Certification (KC Mark).

이 기기는 업무용(A급) 전자파 적합기기로서 판매자 또는 사용자는 이 점을 주의하시기
바라며 가정 외의 지역에서 사용하는 것을 목적으로 합니다.

Note that this device conforms to Limit Class A for emission of radio interference. This device can be used in all areas except the residential area.

Identification for Eurasian Customs Union

- EAC (Eurasian Conformity)
- Customs union of Russia, Belarus and Kazakhstan
- Declaration of conformity according to Technical Regulations of the Customs Union (TR CU)

WEEE label (European Union)

Disposal instructions, observe the local regulations and the section "Recycling and disposal (Page 138)".

Marine approvals

The following marine approvals are provided for the device.

- ABS (American Bureau of Shipping)
- BV (Bureau Veritas)
- DNV-GL (Det Norske Veritas - Germanischer Lloyd)
- LRS (Lloyds Register of Shipping)
- Class NK (Nippon Kaiji Kyokai)
- KR (Korean Register of Shipping)
- CCS (China Classification Society)
- RINA (Registro Italiano Navale)

After acceptance you will find the certificates on the Internet (<https://support.industry.siemens.com/cs/ww/en/ps/26033/cert>).

8.3 Electromagnetic compatibility

The device fulfills, amongst others, the requirements of the EMC directive applicable to the European domestic market.

Installing the device according to EMC directive

EMC-compliant mounting of the device and the use of interference-proof cables provide the basis for interference-free operation.

Observe the following manuals in addition to these operating instructions:

- Designing interference-free controllers
(<https://support.industry.siemens.com/cs/ww/en/view/59193566>)
- Industrial Ethernet/PROFINET – Passive network components
(<https://support.industry.siemens.com/cs/ww/en/view/84922825>)

Pulse-shaped disturbance

The following table shows the electromagnetic compatibility of the modules with regard to pulse-shaped interference. The precondition for electromagnetic compatibility is that the device meets the specifications and guidelines for electrical installation.

Pulse-shaped interference	Tested with	Degree of severity
Electrostatic discharge in accordance with IEC 61000-4-2	Air discharge: 8 kV	3
	Contact discharge: 6 kV (front)	
	Contact discharge: 4 kV (rear)	2
Bursts (high-speed transient interference) in accordance with IEC 61000-4-4	2 kV power supply line 2 kV signal line, > 30 m 1 kV signal line, < 30 m	3
High-energy single pulse (surge) in accordance with IEC 61000-4-5 ¹	Asymmetrical coupling: • 1 kV supply line, DC voltage • 1 kV signal line/data cable, > 30 m	2
	Symmetrical coupling: • 0.5 kV power cable, DC voltage • 1 kV signal line, > 30 m,	2

¹ External protective circuit required, see Function Manual "Designing Interference-free Controllers", section 7 "Lightning and overvoltage protection"

You can find the Function Manual "Designing interference-free controllers" for download on the Internet (<https://support.industry.siemens.com/cs/ww/en/view/59193566>).

Sinusoidal interference

The following table shows the EMC behavior of the modules with respect to sinusoidal interference. This requires the device to meet the specifications and directives for electrical installation.

Sinusoidal interference	Test values
HF radiation (electromagnetic fields) according to IEC 61000-4-3	80% amplitude modulation at 1 kHz <ul style="list-style-type: none"> • to 10 V/m from 80 MHz to 1 GHz • to 3 V/m from 1.4 GHz to 6 GHz
HF current feed on cables and cable shields according to IEC 61000-4-6	Test voltage 10 V, with 80% amplitude modulation of 1 kHz in the 150 kHz to 80 MHz range
Magnetic field strength according to IEC 61000-4-8	50/60 Hz; 30 A/m rms

Emission of radio interference

The following table shows the interference emission from electromagnetic fields according to EN 61000-6-4, measured at the following distance.

Radiated emission (emitted interference)

Frequency range	Measuring distance	Interference emission
30 MHz to 230 MHz	10 m	< 40 dB ($\mu\text{V/m}$) quasi-peak
230 MHz to 1000 MHz	10 m	< 47 dB ($\mu\text{V/m}$) quasi-peak
1 GHz to 3 GHz	3 m	< 76 dB peak and < 56 dB average
3 GHz to 6 GHz	3 m	< 80 dB peak and < 60 dB average

Emission of radio interference voltages

Frequency range	Interference emission
0.150 MHz to 0.5 MHz	< 79 dB quasi-peak and < 66 dB average
0.5 MHz to 30 MHz	< 73 dB quasi-peak and < 60 dB average

See also

EMC information in section "Notes about usage (Page 24)".

8.4 Mechanical ambient conditions

8.4.1 Storage conditions

The following information is valid for a device that is transported and stored in its original packaging.

The device was tested according to IEC 60721-3-2 Class 2M4 with the following additions and restrictions:

Type of condition	Permitted range
Free fall	≤ 0.3 m
Vibration according to IEC 60068-2-6	5 .. 8.4 Hz, deflection 3.5 mm 8.4 ... 500 Hz, acceleration 1 g
Shock according to IEC 60068-2-27	250 m/s ² , 6 ms, 1000 shocks

8.4.2 Operating conditions

The following information applies to a device installed according to the specifications in these operating instructions.

The device was tested based on IEC 60721-3-3 Class 3M3 with the following additions and restrictions:

Type of condition	Permitted range
Vibration according to IEC 60068-2-6	5 ... 8.4 Hz, deflection 3.5 mm 8.4 ... 200 Hz, acceleration 1 g
Shock according to IEC 60068-2-27	150 m/s ² , 11 ms, 3 shocks

Shock pulses within the specified range can be transferred to the display but do not impact the functionality of the device.

8.5 Climatic ambient conditions

8.5.1 Long-term storage

The following information applies to a device that is stored in its original packaging for longer than two weeks.

The device meets the requirements according to IEC 60721-3-1 Class 1K21.

8.5.2 Transport and short-term storage

The following information applies to a device that is transported in the original packaging and weather-proof packaging and stored for some time.

The device was tested according to IEC 60721-3-2 Class 2K11 with the following additions and restrictions:

Type of condition	Permitted range
Temperature	-20 ... 60 °C
Atmospheric pressure	1140 ... 660 hPa, corresponds to an elevation of -1000 to 3500 m
Relative humidity	10 ... 90 %
Pollutant concentration	SO ₂ : < 0.5 ppm; relative humidity < 60%, no condensation H ₂ S: < 0.1 ppm; relative humidity < 60%, no condensation

Note

If dewing has developed, wait until the HMI device has dried completely before switching it on.

Do not expose the HMI device to direct radiation from a heater.

8.5.3 Operating conditions

The following information applies to a device installed according to the specifications in these operating instructions.

The HMI device is designed for weatherproof and stationary operation according to IEC 60721-3-3.

The device meets the requirements according to IEC 60721-3-3 Class 3K3 with the following additions and restrictions:

Type of condition	Mounting position	Permitted range
Temperature, Mounting in landscape format	Vertical	0 ... 50 °C ¹
	Inclined, maximum inclination 35°	0 ... 40 °C
Temperature, Mounting in portrait format	Vertical	0 ... 40 °C
	Inclined, maximum inclination 35°	0 ... 35 °C
Atmospheric pressure ² , operation elevation	1140 ... 795 hPa, corresponds to an elevation of -1000 to 2000 m	
Relative humidity	From 10 ... 90%, no condensation at the rear of the device	
Pollutant concentration	SO ₂ : < 0.5 ppm; relative humidity < 60%, no condensation at the rear of the device	
	H ₂ S: < 0.1 ppm; relative humidity < 60%, no condensation at the rear of the device	

¹ MTP1900 Unified Comfort and MTP2200 Unified Comfort: 0 ... 45 °C

² No pressure difference is allowed inside and outside the enclosure / control cabinet

Observe the Notes on use (Page 24) and section "Permitted mounting positions (Page 30)".

Also observe the climate diagram in the following section.

Note

The system components connected to the HMI device, the power supply for example, must also be suited to the respective operating conditions.

8.5.4 Climate diagram

The diagram below shows the extended range for temperature and humidity during continuous operation based on IEC 60721-3-3 Class 3K3.

The information applies to a device installed in landscape format without inclination.

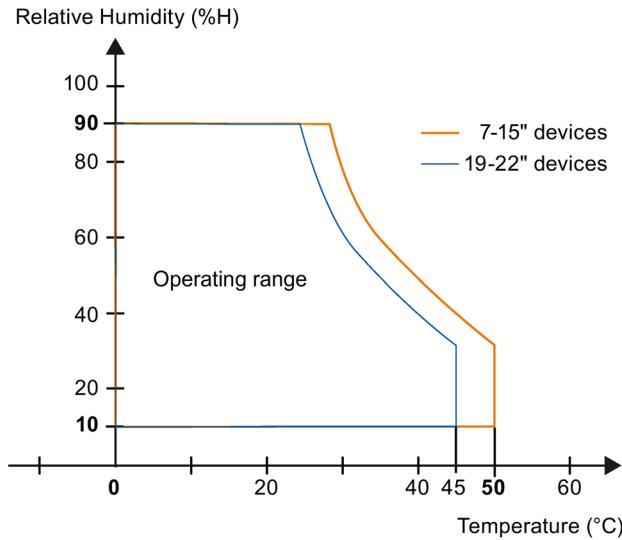

8.6 Information on insulation tests, protection class and degree of protection

Insulation test

The insulation strength is verified in the type test with the following test voltages according to IEC 61010-2-201 and IEC 61131-2:

Circuit	Insulation tested with (type test)
Rated voltage U_e 24 V	707 V DC to other circuits / to ground
Ethernet connector	1500 V AC

Degree of pollution and overvoltage category

The device meets the following requirements according to IEC 61010-2-201 and IEC 61131-2:

Degree of pollution	2
Overvoltage category	II

Protection class

Protection class III according to IEC 61010-2-201 und IEC 61131-2.

Protection against foreign objects and water

The device meets the requirements according to IEC 60529 and UL50.

Device side	Degree of protection
Front	When mounted: <ul style="list-style-type: none"> • IP65 according to IEC 60529 • Type 4X/Type 12 (indoor use only, front face only) according to UL50
Rear	IP20 Protection against contact with standard test probes. There is no protection against the ingress of water, dust and noxious gas.

The degree of protection at the front can only be guaranteed if the mounting seal lies flush against the mounting cutout. Observe the corresponding information in section "Preparing the mounting cutout (Page 33)".

8.7 Dimension drawings

8.7.1 Dimension drawings of the MTP700 Unified Comfort

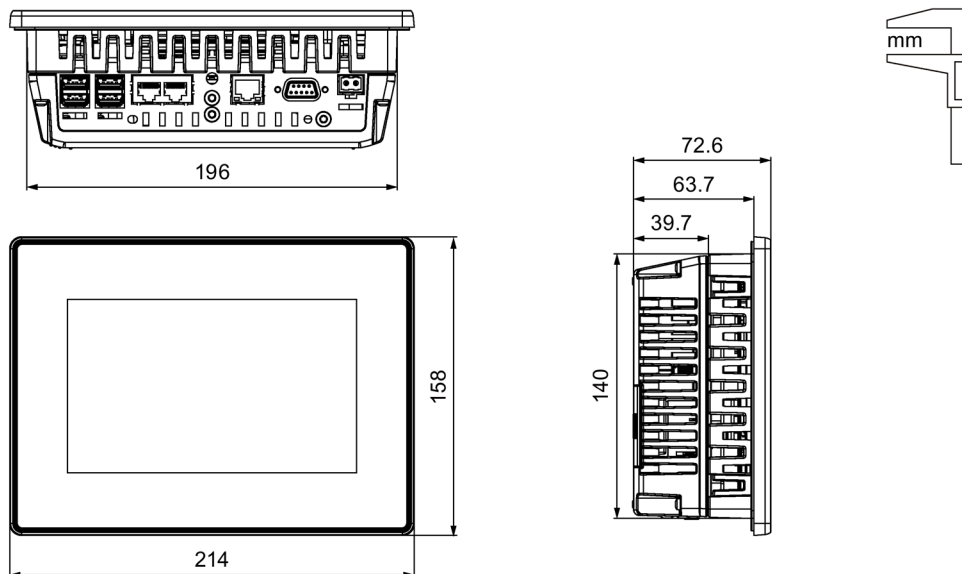

8.7.2 Dimension drawings of the MTP1000 Unified Comfort

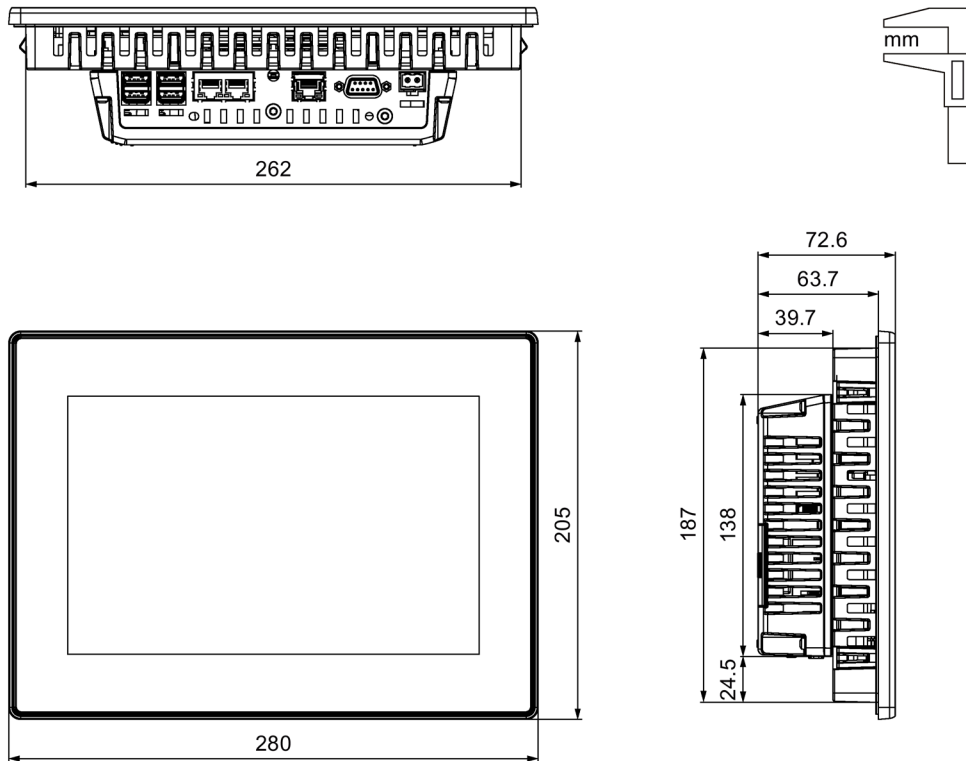

8.7.3 Dimension drawings of the MTP1200 Unified Comfort

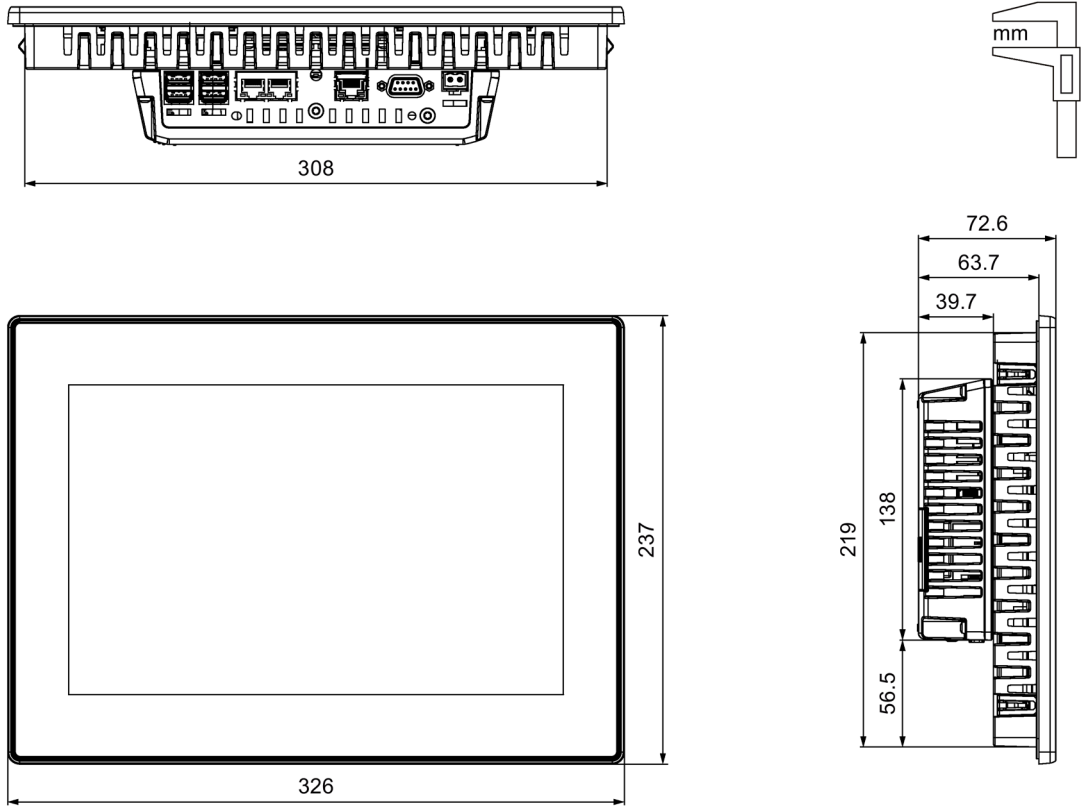

8.7.4 Dimension drawings of the MTP1500 Unified Comfort

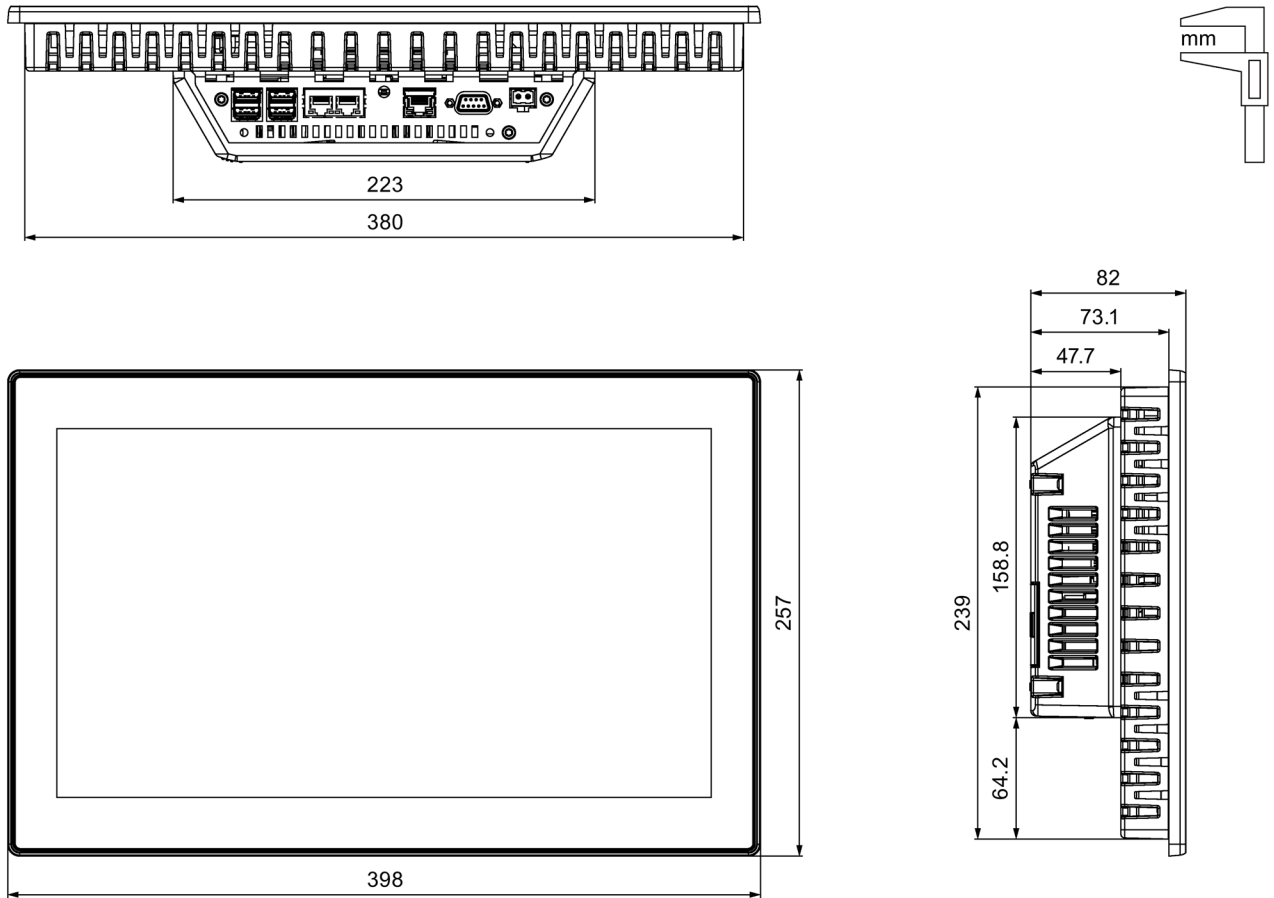

8.7.5 Dimension drawings of the MTP1900 Unified Comfort

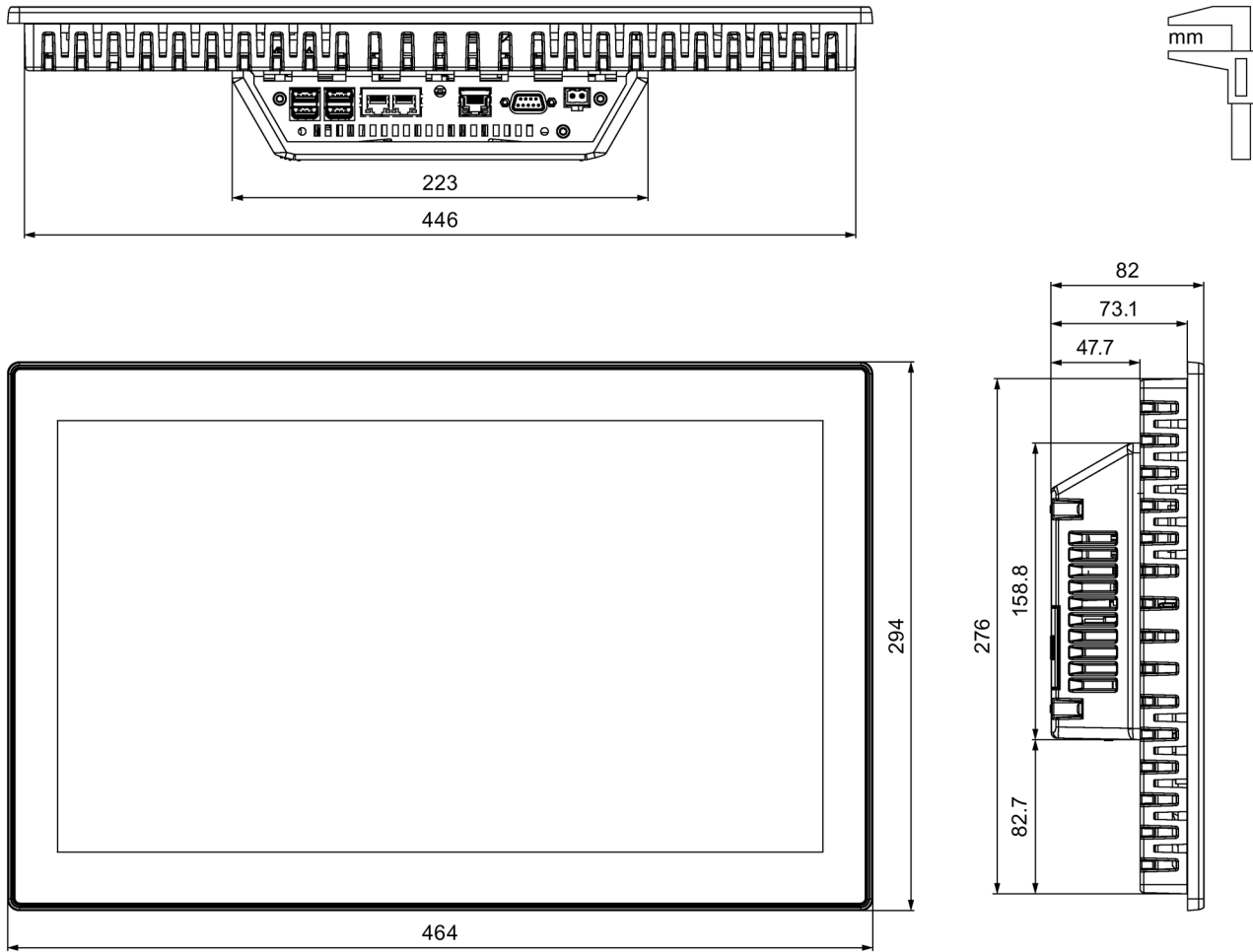

8.7.6 Dimension drawings of the MTP2200 Unified Comfort

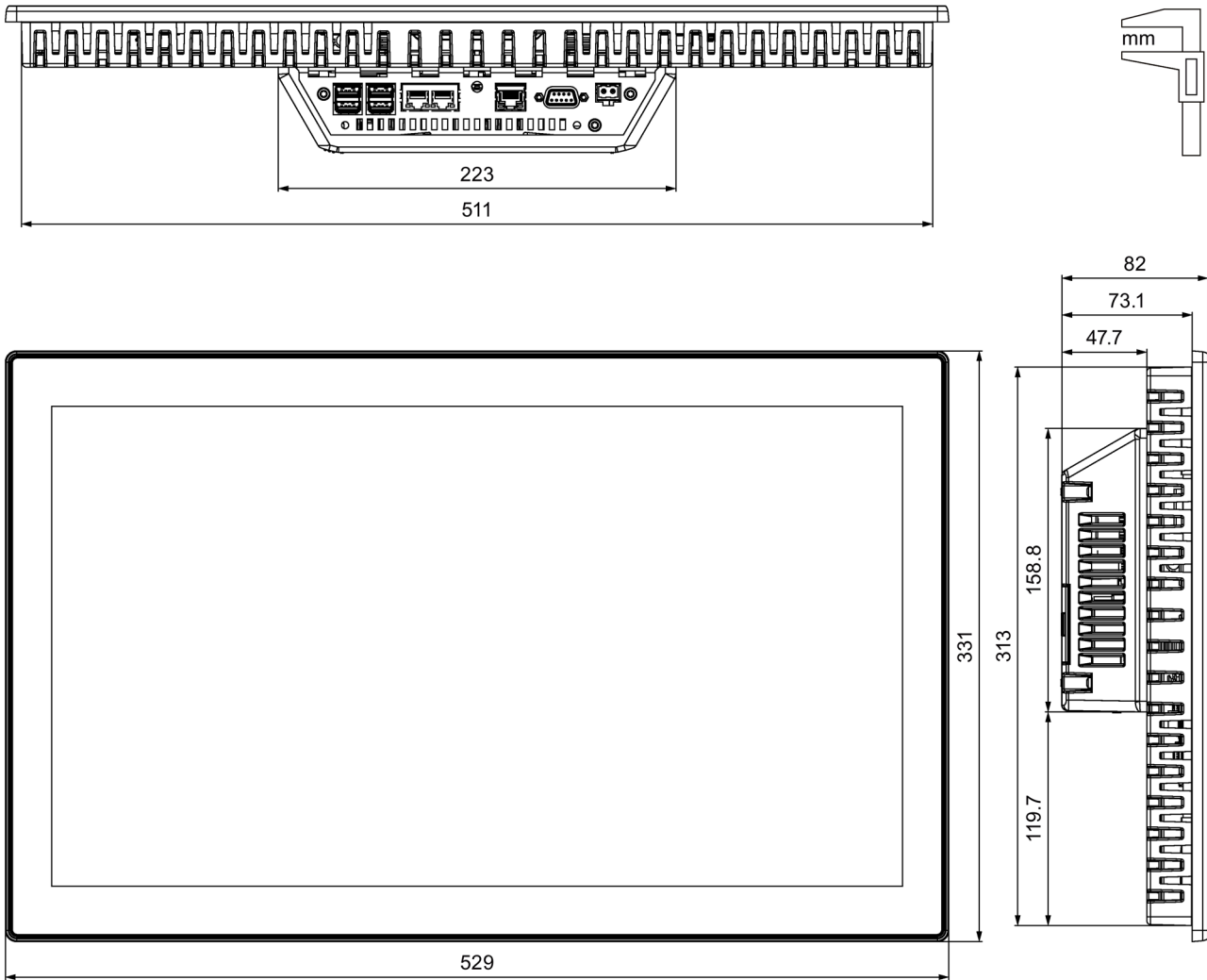

8.8 Technical specifications

8.8.1 MTP700, MTP1000, MTP1200 Unified Comfort

Weight

Unified Comfort HMI device	MTP700	MTP1000	MTP1200
Weight without packaging	1.4 kg	2.1 kg	2.8 kg

Display

Unified Comfort HMI device	MTP700	MTP1000	MTP1200
Type	LCD TFT		
Display diagonal	7.0"	10.1 "	12.1"
Active display area	152 x 91 mm	231 x 135 mm	261 x 163 mm
Resolution/pixels	800 x 480	1280 x 800	
Possible colors	Up to 16.7 million		
Brightness control via Control Panel, value range	5 ... 100 %		
Brightness control via WinCC, value range	0 ... 100 %, values below 5% are set to 5%		
Backlight	LED		
Half Brightness Life Time (MTBF ¹)	50000 h		
Pixel error class in accordance with ISO 9241-307	I		

¹ MTBF: Operating hours after which the maximum brightness is reduced by half compared to the original value. MTBF is increased by using the integrated dimming function, for example, time-controlled via screensaver or centrally via PROFlenergy.

Input device

Unified Comfort HMI device	MTP700	MTP1000	MTP1200
Multi-touch screen (capacitive)	Yes		

Memory

Unified Comfort HMI device	MTP700	MTP1000	MTP1200
Random access memory	4 GB LPDDR4-SDRAM		
Internal flash memory	32 GB eMMC pSLC		
Usable memory for application data	1 GB RAM, 2 GB flash memory		
Internal parameter set memory ¹	12 MB		
Data memory card and system memory card ²	2 x SD/SDHC/SDXC combination slot		

¹ Expandable via memory card in slot X51 or USB flash drive at interface X61 or X62

² Memory cards are available as SIMATIC HMI accessories

Interfaces

Unified Comfort HMI device	MTP700	MTP1000	MTP1200
RS 422/485	1 x SUB-D		
PROFINET (LAN)	2 x RJ45 10/100 Mbps ¹		
	1 x RJ45 10/100/1000 Mbps		
USB 3.1	4 x Host ²		

¹ With integrated switch (one IP address only)

² USB Type A; maximum load per interface: 900 mA; maximum total load of all interfaces: 1.2 A

Power supply

Unified Comfort HMI device	MTP700	MTP1000	MTP1200
Rated voltage	24 V DC		
Permitted voltage range	+19.2 V ... +28.8 V		
Mains and voltage buffering time	20 ms		
Rated current at 24 V DC, without loads	0.45 A	0.5 A	0.6 A
Rated current, load-dependent	0.45 ... 1.0 A	0.52 ... 1.1 A	0.6 ... 1.3 A
Power consumption, without loads ¹	10.8 W	12.5 W	14.4 W
Inrush current I ² t	0.5 A ² s		
Maximum permitted transient	35 V (500 ms)		
Minimum time between two transients	50 s		
Internal protection	Yes		

¹ The power loss generally corresponds to the specified value for power consumption.

The current and power specifications apply without a high permanent processor load by apps.

Miscellaneous

Unified Comfort HMI device	MTP700	MTP1000	MTP1200
Buffered real-time clock ¹	Yes		
Audio reproduction	Integrated buzzer		

¹ Buffering time typically 6 weeks

8.8.2 MTP1500, MTP1900, MTP2200 Unified Comfort

Weight

Unified Comfort HMI device	MTP1500	MTP1900	MTP2200
Weight without packaging	4.3 kg	5.5 kg	6.9 kg

Display

Unified Comfort HMI device	MTP1500	MTP1900	MTP2200
Type	LCD TFT		
Display diagonal	15.6"	18.5"	21.5"
Active display area	344 x 193 mm	409 x 230 mm	476 x 267 mm
Resolution/pixels	1366 x 768	1920 x 1080	
Possible colors	Up to 16.7 million		
Brightness control via Control Panel, value range	10 ... 100%		
Brightness control via WinCC, value range	0 ... 100 %, values below 10% are set to 10%		
Backlight	LED		
Half Brightness Life Time (MTBF ¹)	50000 h	30000 h	
Pixel error class in accordance with ISO 9241-307	I		

¹ MTBF: Operating hours after which the maximum brightness is reduced by half compared to the original value. MTBF is increased by using the integrated dimming function, for example, time-controlled via screensaver or centrally via PROFlenergy.

Input device

Unified Comfort HMI device	MTP1500	MTP1900	MTP2200
Multi-touch screen (capacitive)	Yes		

Memory

Unified Comfort HMI device	MTP1500	MTP1900	MTP2200
Random access memory	4 GB LPDDR4-SDRAM		
Internal flash memory	32 GB eMMC pSLC		
Usable memory for application data	1 GB RAM, 2 GB flash memory		
Internal parameter set memory ¹	12 MB		
Data memory card and system memory card ²	2 x SD/SDHC/SDXC combination slot		

¹ Expandable via memory card in slot X51 or USB flash drive at interface X61 or X62

² Memory cards are available as SIMATIC HMI accessories

Interfaces

Unified Comfort HMI device	MTP1500	MTP1900	MTP2200
RS 422/485	1 x SUB-D		
PROFINET (LAN)	2 x RJ45 10/100 Mbps ¹		
	1 x RJ45 10/100/1000 Mbps		
USB 3.1	4 x Host ²		

¹ With integrated switch (one IP address only)

² USB Type A; maximum load per interface: 900 mA; maximum total load of all interfaces: 1.2 A

Power supply

Unified Comfort HMI device	MTP1500	MTP1900	MTP2200
Rated voltage	24 V DC		
Permitted voltage range	+19.2 V ... +28.8 V		
Mains and voltage buffering time	20 ms		
Rated current at 24 V DC, without loads	0.7 A	1.2 A	1.0 A
Rated current, load-dependent	0.7 ... 1.3 A	1.2 A ... 1.7 A	1.0 ... 1.5 A
Power consumption, without loads ¹	16.8 W	28.8 W	24.0 W
Inrush current I ² t	0.5 A ² s		
Maximum permitted transient	35 V (500 ms)		
Minimum time between two transients	50 s		
Internal protection	Yes		

¹ The power loss generally corresponds to the specified value for power consumption.

The current and power specifications apply without a high permanent processor load by apps.

Miscellaneous

Unified Comfort HMI device	MTP1500	MTP1900	MTP2200
Buffered real-time clock ¹	Yes		
Audio reproduction	Integrated buzzer		

¹ Buffering time typically 6 weeks

8.9 Description of the interfaces

8.9.1 DC24V X80

Power supply 24 V DC 2-pin

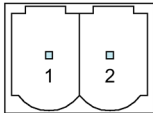

Pin	Meaning
1	+24 V DC
2	Ground

8.9.2 RS422/485 X20

Serial interface, 9-pin sub-D socket, female

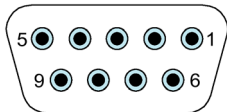

Pin	Assignment for the RS422	Assignment for the RS485
1	NC	NC
2	NC	NC
3	TxD+	Data signal B (+)
4	RxD+	RTS
5	GND 5 V, floating	GND 5 V, floating
6	+5 VDC, floating	+5 VDC, floating
7	NC	NC
8	TxD-	Data signal A (-)
9	RxD-	NC

8.9.3 PROFINET (LAN) X1

PROFINET (LAN) 10/100 Mbps, RJ45 socket

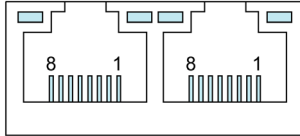

Pin	Name	Meaning
1	Tx+	Data output +
2	Tx-	Data output -
3	Rx+	Data input +
4	NC	Not assigned
5	NC	Not assigned
6	Rx-	Data input -
7	NC	Not assigned
8	NC	Not assigned

8.9.4 PROFINET (LAN) X2

PROFINET (LAN) 10/100/1000 Mbps, RJ45 socket

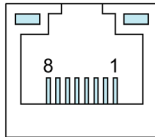

Pin	Name	Meaning
1	D1+	Bi-directional data 1+
2	D1-	Bi-directional data 1-
3	D2+	Bi-directional data 2+
4	D3+	Bi-directional data 3+
5	D3-	Bi-directional data 3-
6	D2-	Bi-directional data 2-
7	D4+	Bi-directional data 4+
8	D4-	Bi-directional data 4-

8.9.5 USB X61/X62/X63/X64

USB Type A

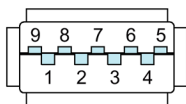

Pin	Name	Meaning
1	VBUS	+5 V, fused
2	D-	Data channel USB 2.0, bidirectional
3	D+	Data channel USB 2.0, bidirectional
4	GND	Ground
5	RX-	Data input USB 3.1
6	RX+	Data input USB 3.1
7	GND	Ground
8	TX-	Data output USB 3.1
9	TX+	Data output USB 3.1

8.10 Communication with controllers

Number of connections

The Unified Comfort Panels support a maximum of 16 connections to S7 controllers and 16 parallel connections via SIMATIC HTTP Protocol.

Controllers

The following controllers and communication drivers are supported by the HMI devices:

- SIMATIC S7-1500
- SIMATIC S7-1200
- SIMATIC S7-300/400
- SIMATIC S7-200
- LOGO!
- SIMOTION
- SIMATIC HTTP protocol

Additional controllers and communication drivers are supported via CSP. You can find the CSPs for download on the Internet

(<https://support.industry.siemens.com/cs/ww/en/view/109739698>). Observe the documentation in the respective download.

8.11 Scope of functions with WinCC

Performance features

The following tables of performance features help you to assess whether your project conforms to the system limits of an HMI device.

The specified maximum values are not additive. It cannot be guaranteed that configurations running on the devices at the full system limits will be functional.

In addition, the complexity of configuring the images, such as number of objects per screen, number of tag connections, cycle times and scripts, has a decisive influence on the image opening times and the performance in runtime.

In addition to the specified limits, observe the restrictions imposed by configuration memory resources.

Tags

Unified Comfort HMI device	Display diagonal ≤ 12"	Display diagonal ≥ 15"
Number of tags in the project		8000
Number of elements per array		1600

Alarms

Unified Comfort HMI device	Display diagonal ≤ 12"	Display diagonal ≥ 15"
Number of alarm classes		32
Number of discrete alarms		9000
Number of analog alarms		300
Length of an alarm in characters		512
Number of alarm texts per interrupt		10
Number of process values per alarm		10
Number of queued alarm events		750
Alarm buffer	Yes, configured as an alarm log	

Note

Observe the notes on using the internal memory

If too many alarms are written to the alarm buffer in short time intervals, the life of the internal memory and thus the service life of the HMI device will be reduced.

When configuring alarms, observe the notes on the internal memory in the section "Memory concept (Page 69)".

Screens

Unified Comfort HMI device	Display diagonal ≤ 12"	Display diagonal ≥ 15"
Number of screens	1200	
Number of lower-level screen windows	10	
Number of objects per screen	800	1200
Number of objects from the "Controls" area per screen	40	80
Number of tags per screen	600	800

Parameter sets

Unified Comfort HMI device	Display diagonal ≤ 12"	Display diagonal ≥ 15"
Number of parameter set types	750	
Number of parameter set type elements	1000	
Number of parameter sets	2000	
Reserved memory for data records in the internal flash ¹	12 MB	

¹ Expansion via memory card in slot X51 or USB flash drive at interface X61 or X62

Logs

Unified Comfort HMI device	Display diagonal ≤ 12"	Display diagonal ≥ 15"
Number of logs	50	
Number of logging tags, SQLite	5000	
Number of logging tags, Microsoft SQL	--	
Number of entries per log (including all log segments)	500000	

Observe the notes on using logs in the section "Memory concept (Page 69)".

Trends

Unified Comfort HMI device	Display diagonal ≤ 12"	Display diagonal ≥ 15"
Number of trends	600	
Number of trends per trend view	20	
Number of trend areas per trend view	2	5

Text lists and graphics lists

Unified Comfort HMI device	Display diagonal ≤ 12"	Display diagonal ≥ 15"
Number of graphics lists	750	
Number of text lists	750	
Number of entries per text or graphics list	750	
Number of graphic objects	6000	
Number of text elements	60000	

Scripts

Unified Comfort HMI device	Display diagonal ≤ 12"	Display diagonal ≥ 15"
Number of Java scripts	600	
Number of functions per function list	25	

Scheduler

Unified Comfort HMI device	Display diagonal ≤ 12"	Display diagonal ≥ 15"
Number of tasks, time- or event-triggered	70	

Communication

Unified Comfort HMI device	Display diagonal ≤ 12"	Display diagonal ≥ 15"
Number of S7 connections	16	
Number of HTTP connections	16	

Languages

Unified Comfort HMI device	Display diagonal ≤ 12"	Display diagonal ≥ 15"
Number of runtime languages	32	

User administration

Unified Comfort HMI device	Display diagonal ≤ 12"	Display diagonal ≥ 15"
Number of roles	50	
Number of predefined function rights	20	
Number of users	200	

Project

Unified Comfort HMI device	Display diagonal ≤ 12"	Display diagonal ≥ 15"
Size of the project files on the device	< 100 MB	

Technical Support

A.1 Service and support

You can find additional information and support for the products described on the Internet at the following addresses:

- Technical support (<https://support.industry.siemens.com/cs/ww/en/>)
- Support request form (<http://www.siemens.com/automation/support-request>)
- After Sales Information System SIMATIC IPC/PG (<http://www.siemens.com/asis>)
- SIMATIC Documentation Collection (<http://www.siemens.com/simatic-tech-doku-portal>)
- Your local representative
(<http://www.automation.siemens.com/mcms/aspa-db/en/Pages/default.aspx>)
- Training center (<http://sitrain.automation.siemens.com/sitrainworld/?AppLang=en>)
- Industry Mall (<https://mall.industry.siemens.com>)
- TIA Selection Tool (<http://w3.siemens.com/mcms/topics/en/simatic/tia-selection-tool>)

When contacting your local representative or Technical Support, please have the following information at hand:

- MLFB of the device
- BIOS version for industrial PC or image version of the device
- Other installed hardware
- Other installed software

Firmware and software

Firmware and software for your HMI device are constantly being further developed. Check regularly whether software updates or patches are available for your HMI device and install the latest versions.

You can find the latest updates and patches for your HMI device on the Internet (<https://support.industry.siemens.com/cs/ww/en/>). Enter the article number of your HMI device as a search term and filter the entries by entry type "Download".

Current documentation

Always use the current documentation available for your product. You can find the latest edition of this manual and other important documents by entering the article number of your device on the Internet (<https://support.industry.siemens.com/cs/ww/en/>). If necessary, filter the entries by entry type "Manual".

A.2 Troubleshooting

This section contains information on localizing and rectifying possible faults.

Error message	Possible cause	Remedy
"Reset system memory card failed" "Start automatic backup failed"	System memory card is defective or wrong system memory card is inserted.	Replace the defective system memory card with a new SIMATIC SD memory card \geq 32 GB.
"System card error"	The system memory card from a device of a different type has been inserted.	Replace the system memory card with the system memory card of a device of the same type. You can use the system memory card with the device without using the data of the system memory card. In this case, all the data in the " <code>System Card\SIMATIC.HMI\Active</code> " folder will be deleted.

A.3 Application examples and FAQs

Application examples

You can find application examples on the Internet at the following address:
Application Examples Unified Comfort Panels
(<https://support.industry.siemens.com/cs/ww/en/ps/26032/ae>).

FAQs

Frequently asked questions on Unified Comfort Panels are available on the Internet at the following address: FAQs Unified Comfort Panels
(<https://support.industry.siemens.com/cs/ww/en/ps/26032/faq>)

A.4 System alarms

System alarms on the HMI device provide information about internal states of the HMI device and the controller.

Note

System alarms are only displayed if an alarm window was configured. System alarms are output in the language currently set on your HMI device.

System alarm parameters

System alarms may contain encrypted parameters which are relevant to troubleshooting because they provide a reference to the source code of the runtime software. These parameters are output after the text "Error code:".

Observe the notes on configuring system alarms and using the alarm buffer in the section "Memory concept (Page 69)".

Description of the system alarms

You can find a list of system events for your HMI device in the TIA Portal information system.

A.5 Information about the manufacturer

Siemens AG is the manufacturer of the HMI devices described in this document.











The manufacturer address is:

Siemens AG
Digital Industries
Postfach 48 48
90026 NÜRNBERG
GERMANY





Markings and symbols

B.1 Safety-relevant symbols

The following table describes symbols that can be added to your SIMATIC device, to its packaging or to an enclosed document in addition to the symbols described in the manuals.

Symbol	Meaning	Reference
	General danger sign Caution / Attention You must observe the operating instructions. The operating instructions contain information on the type of the potential hazard and enable you to identify risks and implement countermeasures.	ISO 7000 No. 0434B, DIN ISO 7000 No. 0434B
	Attention, only relevant for modules with Ex approval	
	Observe the instructions	ISO 7010 M002
	Must be installed by qualified electricians only	IEC 60417 No. 6182
	Mechanical load for HMI devices	
	Connection cables must be designed for the ambient temperature	
	EMC-compliant installation	
	No mounting or pulling & plugging under voltage	
	Dangerous electrical voltage for 230V modules	ANSI Z535.2
	Protection class III, supply only with protective low voltage (SELV/PELV)	IEC 60417-1-5180 "Class III equipment"

B.1 Safety-relevant symbols

Symbol	Meaning	Reference
 <p>INDOOR USE ONLY INDUSTRIAL USE ONLY</p>	<p>Only for industrial applications and indoor areas (control cabinet)</p>	
	<p>Device is to be integrated into a control cabinet</p>	
 <p>ZONE 2 USE CABINET IP54</p>	<p>Install devices approved for Ex Zone 2 in a control cabinet with at least IP54</p>	
 <p>ZONE 22 USE CABINET IP6x</p>	<p>Install devices approved for Ex Zone 22 in a control cabinet with at least IP6x</p>	

Abbreviations

C

ANSI	American National Standards Institution
CPU	Central Processing Unit
CSP	Communication Service Package
CSV	Comma Separated Values
CTS	Clear To Send
CUPS	Common Unix Printing System
DC	Direct Current
DCD	Data Carrier Detect
DHCP	Dynamic Host Configuration Protocol
DIL	Dual-in-Line (electronic chip housing design)
DNS	Domain Name System
DP	Distributed I/O
DSN	Data Source Name
DSR	Data Set Ready
DTR	Data Terminal Ready
IO	Input and Output
ESD	Components and modules endangered by electrostatic discharge
EMC	Electromagnetic Compatibility
EN	European standard
ES	Engineering System
ESD	Components and modules endangered by electrostatic discharge
GND	Ground
HF	High Frequency
HMI	Human Machine Interface
IEC	International Electronic Commission
IF	Interface
IP	Internet Protocol
LED	Light Emitting Diode
MAC	Media Access Control
MOS	Metal Oxide Semiconductor
MPI	Multipoint Interface (SIMATIC S7)
MS	Microsoft
MTBF	Mean Time Between Failures
n. c.	Not connected
OP	Operator Panel
PC	Personal Computer

PG	Programming device
PPI	Point-to-Point Interface (SIMATIC S7)
RAM	Random Access Memory
PELV	Protective Extra Low Voltage
RJ45	Registered Jack Type 45
RTS	Request to send
RxD	Receive Data
SD Memory Card	Abbreviation for Secure Digital Memory Card
SELV	Safety Extra Low Voltage
SP	Service Pack
SUB-D	Subminiature D (plug)
TAB	Tabulator
TCP/IP	Transmission Control Protocol/Internet Protocol
TFT	Thin Film Transistor
TxD	Transmit Data
UL	Underwriter's Laboratory
USB	Universal Serial Bus
UPS	Uninterruptible power supply
WINS	Windows Internet Naming Service

Glossary

Alarm

An alarm may be a system alarm or a user-defined alarm. A user-defined alarm typically indicates a particular operating state of the plant, a system alarm typically contains information about the state of the HMI device.

Boot loader

The bootloader is used to start the operating system and is started automatically after the power on of the HMI device power. The Control Panel opens after the operating system has loaded.

Configuration PC

A configuration PC is a programming device or PC on which plant projects are created using engineering software.

Configuration software

Configuration software is used to create projects used for the purpose of process visualization. WinCC represents such configuration software, for example.

Controller

Controller is a general term for devices and systems with which the HMI device communicates, for example SIMATIC S7.

Degree of protection

The degree of protection specifies a standard of electronic equipment for a variety of ambient conditions – and the protection of humans against potential danger when using this equipment.

The degree of protection classified by IP differs from the protection class. But both involve protection against touching dangerous electric voltage. The IP degree of protection also classifies the protection of equipment against dirt and moisture.

Display duration

The display duration defines whether and for how long a message or a dialog box is displayed on the HMI device.

EMC

Electromagnetic compatibility (EMC) refers to a usually desirable state, in which technical equipment does not disturb one another with unwanted electrical or electromagnetic effects. Electromagnetic compatibility deals with technical and regulatory questions of undesired, mutual influence in electrical engineering.

Event

Functions are triggered by defined incoming events. Events can be configured. Events which can be assigned to a button include "Press" and "Release", for example.

Field

Area reserved in configured screens for the input and output of values.

Flash memory

Flash memory is a non-volatile memory with EEPROM chips that is implemented either as mobile storage medium, or as permanently installed memory module on the motherboard.

Half Brightness Life Time

Time period after which brightness is reduced to 50% of the original value. The specified value depends on the operating temperature.

HMI device

An HMI device is a device used for the operation and monitoring of machines and plants. The machine or plant states are visualized on the HMI device by means of graphic objects. The operator controls of the HMI device allow the operator to interact with the processes of the machine or plant.

HMI device image

The HMI device image is a file that can be transferred from the configuration PC or from an external storage medium to the HMI device. The HMI device image contains the operating system for the HMI device and the elements of the runtime software which are required to start and visualize the project file.

Input box

Use the input box to enter characters and values that are stored in the HMI device or transferred to the controller.

Job mail

A job mail triggers a function for the controller on the HMI device.

Object

An object is a project element such as a screen or an alarm. Objects are used to view or enter texts and values on the HMI device.

Operating element

An operating element is a component of a project used to enter values and trigger functions. A button, for example, is an operating element.

Parameter set

A parameter set is a combination of tags forming a fixed data structure. The configured data structure can be assigned data in the configuration software or on the HMI device and is then referred to as a record. The use of parameter sets ensures that all data assigned to a data record is transferred synchronously to the controller.

Plant

General term referring to machines, processing centers, systems and processes which are operated and monitored on an HMI device.

Process visualization

Process visualization is the representation of technical processes by means of text and graphic elements. Configured plant screens allow the operator to use input and output information to intervene in active plant processes.

Project

A project contains information on the visualization of the automation process and is created using a configuration software. The project normally contains several screens with embedded plant-specific objects, basic settings and alarms. A project configured with WinCC is saved in a file with extension "*.ap1x", where "x" stands for the version key. Example: "MyProject.ap16" for a WinCC V16 project.

Protection class

The protection class is used in electrical engineering to classify and identify electrical equipment in relation to existing safety measures designed to prevent electric shock. There are three protection classes for electrical equipment.

Runtime software

A project is started and visualized on the HMI device via the runtime software.

Screen

A screen is a form of visualization for all logically related process data in a plant. The representation of the process data can be visually supported by graphic objects.

Screen object

A screen object refers to objects such as rectangles, input boxes or alarm views which are configured for visualization or operation of the plant.

Tag

A tag is a defined memory location to which values can be written and from which values can be read. This can be done from the controller or the HMI device. We distinguish between external tags (process tags) and internal tags, depending on whether or not the tag is interconnected with the controller.

Trade goods

In addition to their own accessories, Siemens AG also offers high-quality accessories from well-known manufacturers as trade goods. Trade goods are qualified in a brief power-up test but do not undergo a system test by Siemens AG. The technical properties of trade goods can deviate from the properties guaranteed by comparable products of the Siemens AG. Trade goods are identified as such in the online catalog of the Siemens AG. Technical specifications, drivers, certificates, test verification documents, etc. are supplied by the respective manufacturer to Siemens AG and are also available for download in the online catalog or technical support of the Siemens AG.

Transfer

In "Transfer" mode, data is transferred from a configuration PC to the HMI device.

WinCC

WinCC (TIA Portal) is an engineering software for configuring SIMATIC HMI devices.