

General Description

V700 OPLCs are programmable logic controller that comprise a built-in operating panel containing a 7" Color Touchscreen. You can find additional information, such as wiring diagrams, in the product's installation guide located in the Technical Library at www.unitronics.com





I/O Options	Snap-in I/O Modules / I/O Expansion Modules
Screen	7" Color Touch
Keypad or Function Keys	None
Programming Com Port, Built-in	
RS232/485	Yes
Ethernet	Yes
USB device, mini-B	Yes
Com Ports, separate order, installed by user	The user may install one or both of the following ports: <ul style="list-style-type: none"> CANbus port (V100-17-CAN) RS232/RS485 port (V100-17-RS4/V100-17-RS4X)
* V700 comprises both RS232/485 and USB ports; note that only <u>one</u> channel may be used at a time.	

Standard Kit Contents



Controller	Yes
Terminal Block	Yes (3 pin)
Battery	Yes
Mounting Brackets	Yes (4 parts)
Rubber Seal	Yes

Alert Symbols and General Restrictions

When any of the following symbols appear, read the associated information carefully.

Symbol	Meaning	Description
	Danger	The identified danger causes physical and property damage.
	Warning	The identified danger could cause physical and property damage.
<i>Caution</i>	Caution	Use caution.
<ul style="list-style-type: none"> Before using this product, the user must read and understand this document. All examples and diagrams are intended to aid understanding, and do not guarantee operation. Unitronics accepts no responsibility for actual use of this product based on these examples. Please dispose of this product according to local and national standards and regulations. Only qualified service personnel should open this device or carry out repairs. 		
	Failure to comply with appropriate safety guidelines can cause severe injury or property damage.	
	<ul style="list-style-type: none"> Do not attempt to use this device with parameters that exceed permissible levels. To avoid damaging the system, do not connect/disconnect the device when power is on. 	

Environmental Considerations

	<ul style="list-style-type: none"> Do not install in areas with: excessive or conductive dust, corrosive or flammable gas, moisture or rain, excessive heat, regular impact shocks or excessive vibration, in accordance with the standards given in the product's technical specification sheet. Do not place in water or let water leak onto the unit. Do not allow debris to fall inside the unit during installation.
	<ul style="list-style-type: none"> Ventilation: 10mm space required between controller's top/bottom edges & enclosure walls. Install at maximum distance from high-voltage cables and power equipment.

UL Compliance

The following section is relevant to Unitronics' products that are listed with the UL.

The following models: V700-T20BJ is UL listed for Hazardous Locations.

The following models: V700-T20BJ, V700-T4-T20BJ-N, are UL listed for Ordinary Location.

For models from series V700, that include "T4" in the Model name, Suitable for mounting on the flat surface of Type 4X enclosure.

For examples: V700-T20BJ will be modified V700-T4-T20BJ

UL Ordinary Location

In order to meet the UL ordinary location standard, panel-mount this device on the flat surface of Type 1 or 4 X enclosures

UL Ratings, Programmable Controllers for Use in Hazardous Locations,

Class I, Division 2, Groups A, B, C and D

These Release Notes relate to all Unitronics products that bear the UL symbols used to mark products that have been approved for use in hazardous locations, Class I, Division 2, Groups A, B, C and D.

Caution



- This equipment is suitable for use in Class I, Division 2, Groups A, B, C and D, or Non-hazardous locations only.
- Input and output wiring must be in accordance with Class I, Division 2 wiring methods and in accordance with the authority having jurisdiction.
- WARNING—Explosion Hazard—substitution of components may impair suitability for Class I, Division 2.
- WARNING – EXPLOSION HAZARD – Do not connect or disconnect equipment unless power has been switched off or the area is known to be non-hazardous.
- WARNING – Exposure to some chemicals may degrade the sealing properties of material used in Relays.
- This equipment must be installed using wiring methods as required for Class I, Division 2 as per the NEC and/or CEC.

Panel-Mounting

For programmable controllers that can be mounted also on panel, in order to meet the UL Haz Loc standard, panel-mount this device on the flat surface of Type 1 or Type 4X enclosures.

Communication and Removable Memory Storage

When products comprise either USB communication port, SD card slot, or both, neither the SD card slot nor the USB port are intended to be permanently connected, while the USB port is intended for programming only.

Removing / Replacing the battery

When a product has been installed with a battery, do not remove or replace the battery unless the power has been switched off, or the area is known to be non-hazardous.

Please note that it is recommended to back up all data retained in RAM, in order to avoid losing data when changing the battery while the power is switched off. Date and time information will also need to be reset after the procedure.

UL des zones ordinaires:

Pour respecter la norme UL des zones ordinaires, monter l'appareil sur une surface plane de type de protection 1 ou 4X

Certification UL des automates programmables, pour une utilisation en environnement à risques, Class I, Division 2, Groups A, B, C et D.

Cette note fait référence à tous les produits Unitronics portant le symbole UL - produits qui ont été certifiés pour une utilisation dans des endroits dangereux, Classe I, Division 2, Groupes A, B, C et D.

Attention



- Cet équipement est adapté pour une utilisation en Classe I, Division 2, Groupes A, B, C et D, ou dans Non-dangereux endroits seulement.
- Le câblage des entrées/sorties doit être en accord avec les méthodes de câblage selon la Classe I, Division 2 et en accord avec l'autorité compétente.
- AVERTISSEMENT: Risque d'Explosion – Le remplacement de certains composants rend caduque la certification du produit selon la Classe I, Division 2.
- AVERTISSEMENT - DANGER D'EXPLOSION - Ne connecter pas ou ne débranche pas l'équipement sans avoir préalablement coupé l'alimentation électrique ou la zone est reconnue pour être non dangereuse.
- AVERTISSEMENT - L'exposition à certains produits chimiques peut dégrader les propriétés des matériaux utilisés pour l'étanchéité dans les relais.
- Cet équipement doit être installé utilisant des méthodes de câblage suivant la norme Class I, Division 2 NEC et /ou CEC.

Montage de l'écran:

Pour les automates programmables qui peuvent aussi être monté sur l'écran, pour pouvoir être au standard UL, l'écran doit être monté dans un coffret avec une surface plane de type 1 ou de type 4X.

Communication et de stockage amovible de mémoire (carte mémoire)

Produits comprend un port USB de communication, soit un port carte SD ou les deux, ni le port SD, ni le port USB ne sont censés être utilisés en permanence, tandis que l'USB est destiné à la programmation uniquement.

Retrait / Remplacement de la batterie

Lorsqu'un produit a été installé avec une batterie, retirez et remplacez la batterie seulement si l'alimentation est éteinte ou si l'environnement n'est pas dangereux.

Veillez noter qu'il est recommandé de sauvegarder toutes les données conservées dans la RAM, afin d'éviter de perdre des données lors du changement de la batterie lorsque l'alimentation est coupée. Les informations sur la date et l'heure devront également être réinitialisées après la procédure

Mounting

Dimensions

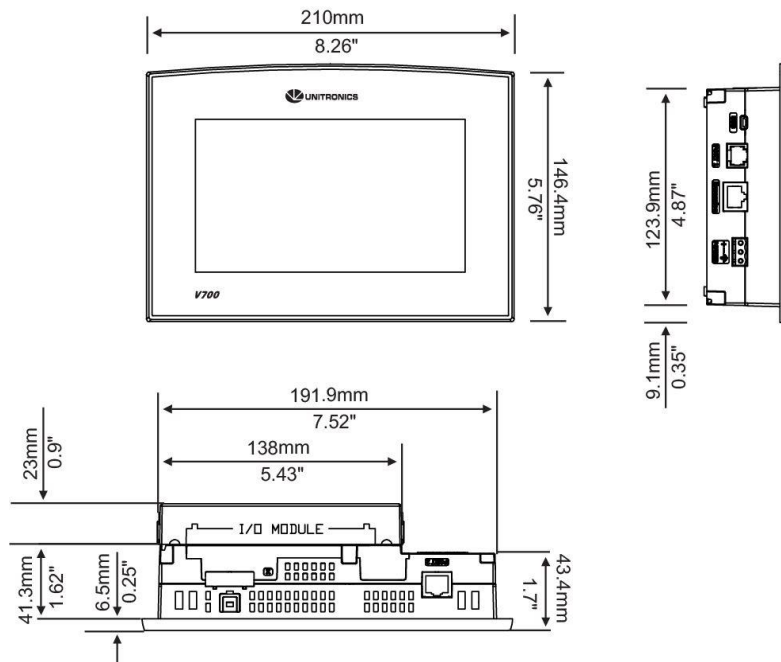

Note that the Snap-in I/O module thickness is 23 mm (0.9").

Panel Mounting

Before you begin, note that the mounting panel cannot be more than 5 mm thick.

1. Make a panel cut-out of the appropriate size:
193x125mm (7.59"x4.92").
2. Slide the controller into the cut-out, ensuring that the rubber seal is in place.
3. Push the mounting brackets into their slots on the sides of the panel as shown in the figure below.
4. Tighten the bracket's screws against the panel. Hold the bracket securely against the unit while tightening the screw.
5. When properly mounted, the controller is squarely situated in the panel cut-out as shown in the accompanying figures.

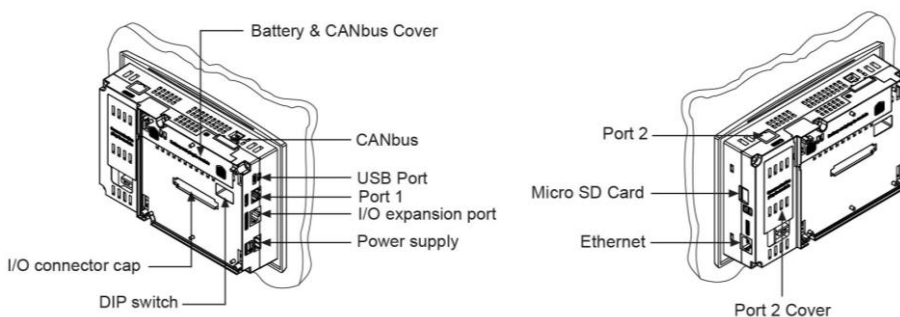
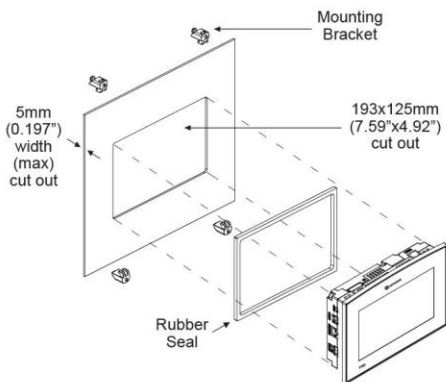



Inserting the Battery



In order to preserve data in case of power-off, you must insert the battery.

The battery is supplied taped to the battery cover on the rear of the controller.

1. Remove the battery cover.
The polarity (+) is marked on the battery holder and on the battery.
2. Insert the battery, ensuring that the polarity symbol on the battery is:
 - facing up
 - aligned with the symbol on the holder
3. Replace the battery cover.

-  Use proper precautions to prevent Electro-Static Discharge (ESD) while servicing the battery.
- Caution  To preserve back-up values for RTC and system data during battery replacement, the controller must be powered.

Wiring

-  Do not touch live wires.
- 
 - Install an external circuit breaker. Guard against short-circuiting in external wiring.
 - Use appropriate circuit protection devices.
 - Unused pins should not be connected. Ignoring this directive may damage the device.
 - Double-check all wiring before turning on the power supply.
- Caution 
 - To avoid damaging the wire, do not exceed a maximum torque of 0.5 N·m (5 kgf·cm).
 - Do not use tin, solder, or any substance on stripped wire that might cause the wire strand to break.
 - Install at maximum distance from high-voltage cables and power equipment.

Wiring Procedure



Use crimp terminals for wiring; use 3.31 mm²–0.13 mm² wire (12-16 AWG):

1. Strip the wire to a length of 7±0.5mm (0.270–0.300").
 2. Unscrew the terminal to its widest position before inserting a wire.
 3. Insert the wire completely into the terminal to ensure a proper connection.
 4. Tighten enough to keep the wire from pulling free.
- Input or output cables should not be run through the same multi-core cable or share the same wire.
 - Allow for voltage drop and noise interference with I/O lines used over an extended distance.
Use wire that is properly sized for the load.
 - The controller and I/O signals must be connected to the same 0V signal.

Power Supply

The controller requires either an external 12 or 24VDC power supply.

Note: Photo is for illustration purposes only.

-  1. The power supply must include double insulation. Outputs must be rated as SELV/PELV/Class 2/Limited Power.
2. Use separate wires to connect the functional earth terminal and the 0V terminal to the system earth ground.
3. Install an external circuit breaker. Guard against short-circuiting in external wiring.
4. Double-check all wiring before turning on the power supply.
-  5. Do not connect either the 'Neutral' or 'Line' signal of the 110/220VAC to device's 0V pin.
6. In the event of voltage fluctuations or non-conformity to voltage power supply specifications, connect the device to a regulated power supply.

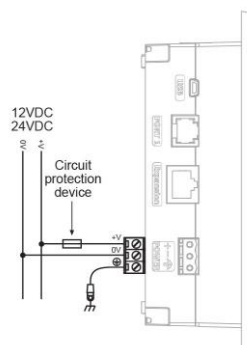

Earthing the PLC+HMI

To maximize system performance, avoid electromagnetic interference by:

- Mounting the controller on a metal panel.
- Connect each common and ground connection directly to the earth ground of your system.

For ground wiring use the shortest and thickest possible wire.

Communication Ports

The controller comprises a USB port, 1 RS232/RS485 serial port and an Ethernet port.

The user may order and install one or both of the following modules:

- An additional port (Port 2).
Available types: RS232/RS485 isolated/non-isolated
- A CANbus port

For the most updated information regarding ports and their installation, please refer to the Technical Library at www.unitronics.com.



- Turn off power before making communications connections.

Caution

- Always use the appropriate port adapters.

The USB port may be used for programming, OS download, and PC access.

Note that **COM port 1 function is suspended when this port is physically connected to a PC.**

The serial port type is RJ-11 and may be set to either RS232 or RS485 via DIP switch, in accordance with the table shown below.

Use RS232 to download programs from a PC, and to communicate with serial devices and applications, such as SCADA.

Use RS485 to create a multi-drop network containing up to 32 devices.

Pinouts

The pinouts below show PLC port signals.

To connect a PC to a port that is set to RS485, remove the RS485 connector, and connect the PC to the PLC via the programming cable. Note that this is possible only if flow control signals are not used (which is the standard case).

RS232		RS485**		Controller Port
Pin #	Description	Pin #	Description	
1*	DTR signal	1	A signal (+)	
2	0V reference	2	(RS232 signal)	
3	TXD signal	3	(RS232 signal)	
4	RXD signal	4	(RS232 signal)	
5	0V reference	5	(RS232 signal)	
6*	DSR signal	6	B signal (-)	

*Standard programming cables do not provide connection points for pins 1 and 6.

**When a port is adapted to RS485, Pin 1 (DTR) is used for signal A, and Pin 6 (DSR) signal is used for signal B.

RS232 to RS485: Changing DIP Switch Settings

The port set to RS232 by factory default.

To change the settings, first remove the Snap-in I/O Module, if one is installed, and then set the switches according to the following table.

RS232/RS485: DIP Switch Settings

	Switch Settings					
	1	2	3	4	5	6
RS232*	ON	ON	ON	OFF	ON	OFF
RS485	OFF	OFF	OFF	ON	OFF	ON
RS485 with termination**	ON	ON	OFF	ON	OFF	ON

*Default factory setting

**Causes the unit to function as an end unit in an RS485 network

Ethernet

Implement communications via TCP/IP, such as MODBUS over TCP.

RJ45 Connector Pinout

Ethernet LEDs

Pin #	Description		LED	Function
1	T+ = Positive transmit signal		Green (LNK)	ON when link exists
2	T- = Negative transmit signal			
3	R+ = Positive receive signal		Yellow (ACT)	Blinks during RX/TX
6	R- = Negative receive signal			

Installing a Snap-in I/O Module

- 1.Remove the I/O connector cap shown on Page 3.
- 2.Line the circular guidelines on the Snap-in I/O Module with the slots on the controller as shown below.
- 3 Apply even pressure on all 4 corners until you hear a distinct 'click'. The module is now installed. Check that all sides and corners are correctly aligned.

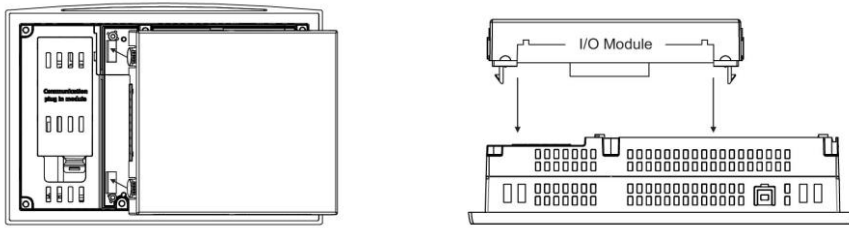

Removing a Snap-in I/O Module

- 1.Locate the four buttons on the sides of the controller, two on either side.
- 2.Press the buttons and hold them down to open the locking mechanism.
- 3.Gently rock the module from side to side, easing the module from the controller.

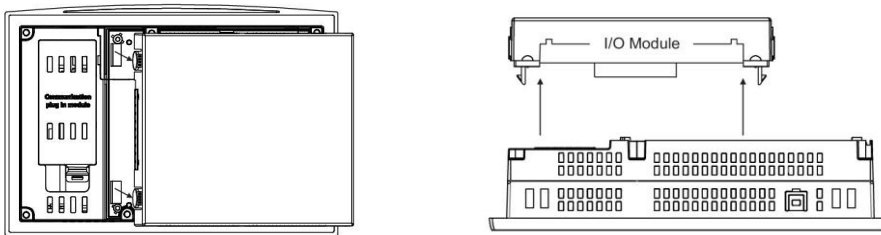

Technical Specifications

Power Supply

Input voltage	12 or 24VDC
Permissible range	10.2-28.8VDC
Max. current consumption	630mA@12V 320mA@24V

Graphic Display Screen

	See Note 1
LCD Type	TFT, LCD display
Illumination backlight	White LED
Display resolution	800x480 pixels
Viewing area	7"
Colors	65,536 (16-bit)
Touchscreen	Resistive, analog
'Touch' indication	Via buzzer
Screen brightness control	Via software (Store value to SI 9, values range: 0 to 100%)
Virtual Keypad	Displays virtual keyboard when the application requires data entry.

Notes:

- 5.Note that the LCD screen may have a single pixel that is permanently either black or white.

Program

Memory size	Application Logic – 2MB, Images – 60MB, Fonts – 1MB		
Operand type	Quantity	Symbol	Value
Memory Bits	8192	MB	Bit (coil)
Memory Integers	4096	MI	16-bit
Long Integers	512	ML	32-bit
Double Word	256	DW	32-bit unsigned
Memory Floats	64	MF	32-bit
Fast Bits	1024	XB	Bits (coil) – fast, not retained
Fast Integers	512	XI	16 bit - fast, not retained
Fast Long Integers	256	XL	32 bit - fast, not retained
Fast Double Word	64	XDW	32 bit unsigned - fast, not retained
Timers	384	T	Res. 10 ms; max 99h, 59 min, 59.99s
Counters	32	C	16-bit
Data Tables	120K dynamic RAM data (recipe parameters, datalogs, etc.) Up to 256K Flash data (read-only data, ingredient names, etc) Expandable via micro-SD card. See Removable Memory below		
HMI displays	Up to 1024		
Program scan time	9 µsec per 1K of typical application		

Removable Memory

Micro-SD card Compatible with fast micro-SD cards; store datalogs, Alarms, Trends, Data Tables, backup Ladder, HMI, and OS. See Note 6

Notes:

6. User must format via Unitronics SD tools utility.

Communication

Port 1	1 channel, RS232/RS485 and USB device. See Note 7
Galvanic isolation	Yes
Baud rate range	300 to 115200 bps
RS232	
Voltage limits	±20VDC absolute maximum
Cable length	Up to 15m (50')
RS485	
Voltage limits	-7 to +12VDC differential maximum
Nodes	Up to 32
Cable type	Shielded twisted pair, in compliance with EIA RS485
Cable length	1200m maximum (4000')
USB	See Note 8
Port type	Mini-B
Galvanic isolation	No
Specification	USB 2.0 compliant; full speed
Cable	USB 2.0 compliant; up to 3m
Ethernet	
Port type	RJ45
Transmission speed	10/100Mbps
Network topology	Star, based on external hub/switch
Cable type	Category 5 STP (shielded twisted pair) is recommended; UTP (unshielded twisted pair) may also be used
Drop line length	Up to 100 meters, controller to hub/switch or controller to controller.
Port 2 (optional)	See Note 5
CANbus (optional)	See Note 5
Profibus (optional)	See Note 5

Notes:

7. This model is supplied with a serial port: RS232/RS485 (Port 1). The standard is set to either RS232 or RS485 according to DIP switch settings. Refer to the product's Installation Guide.
8. Note that physically connecting a PC to the controller via USB suspends RS232/RS485 communications via Port 1. When the PC is disconnected, RS232/RS485 resumes.
5. The user may order and install one or both of the following modules:
- A serial RS232/RS485 isolated/non-isolated interface module in port 2.
 - A CANbus module
 - A Profibus module
- Modules documentation is available on the Unitronics website.

I/Os

	Additional I/Os may be added. Configurations vary according to module. Supports digital, high-speed, analog, weight and temperature measurement I/Os.
Snap-in I/O modules	Plugs into rear port to create self-contained PLC with up to 62 I/Os.
I/O Expansion	
Local	Via I/O Expansion Port. Integrate up to 8 I/O Expansion Modules comprising up to 128 additional I/Os. Adapter required (P.N. EX-A2X).
Remote	Via CANbus port. Connect up to 60 adapters to a distance of 1000 meters from controller; and up to 8 I/O expansion modules to each adapter (up to a total of 512 I/Os). Adapter required (P.N. EX-RC1).
Galvanic isolation	Yes

Miscellaneous

Clock (RTC)	Real-time clock functions (date and time)
Battery back-up	7 years typical at 25°C, battery back-up for RTC and system data, including variable data
Battery replacement	Yes (without opening the controller). Coin-type 3V, lithium battery, CR2450

Dimensions

Size	210 x 146.4 x 42.3mm (8.26 x 5.76 x 1.66"). See Note 6
Weight	640g (22.57 oz)

Notes:

6. For exact dimensions, refer to the product's Installation Guide.

Environment

	V700-T20B	V700-S-T20B
Operational temperature	0 to 50°C (32 to 122°F)	-30 to 60°C (-22 to 140°F)
Storage temperature	-20 to 60°C (-4 to 140°F)	-30 to 60°C (-22 to 140°F)
Relative Humidity (RH)	10% to 95% (non-condensing)	
Mounting method	Panel mounted (IP65/66/NEMA4X)	
Operating Altitude	2000m (6562 ft)	
Shock	IEC 60068-2-27, 15G, 11ms duration	
Vibration	IEC 60068-2-6, 5Hz to 8.4Hz, 3.5mm constant amplitude, 8.4Hz to 150Hz, 1G acceleration.	

The information in this document reflects products at the date of printing. Unitronics reserves the right, subject to all applicable laws, at any time, at its sole discretion, and without notice, to discontinue or change the features, designs, materials and other specifications of its products, and to either permanently or temporarily withdraw any of the foregoing from the market.

All information in this document is provided "as is" without warranty of any kind, either expressed or implied, including but not limited to any implied warranties of merchantability, fitness for a particular purpose, or non-infringement. Unitronics assumes no responsibility for errors or omissions in the information presented in this document. In no event shall Unitronics be liable for any special, incidental, indirect or consequential damages of any kind, or any damages whatsoever arising out of or in connection with the use or performance of this information.

The tradenames, trademarks, logos and service marks presented in this document, including their design, are the property of Unitronics (1989) (R'G) Ltd. or other third parties and you are not permitted to use them without the prior written consent of Unitronics or such third party as may own them.

UG_V700.dxf 07/22