

M91-2-UA2

24 VDC, 12 pnp/npn digital inputs, *2 universal inputs, high-speed counter/shaft encoder input, 10 transistor outputs, 2 analog outputs, I/O expansion port, RS232/RS485 port

Power supply	24VDC
Permissible range	20.4VDC to 28.8VDC with less than 10% ripple
Maximum current consumption	145mA@24VDC (pnp inputs) 250mA@24VDC (npn inputs)
Digital inputs	12 pnp (source) or npn (sink) inputs. See Note 1.
Nominal input voltage	24VDC. See Note 2
Input voltages for pnp (source)	0-5VDC for Logic '0' 17-28.8VDC for Logic '1'
Input voltages for npn (sink)	17-28.8VDC/<2mA for Logic '0' 0-5VDC/>6mA for Logic '1'
Input current	8mA@24VDC
Input impedance	3KΩ
Response time (except high-speed inputs)	10mS typical
Galvanic isolation	None
Input cable length	Up to 100 meters, unshielded
High-speed counter	Specifications below apply when inputs are wired for use as a high-speed counter input/shaft encoder. See Notes 3 and 4.
Resolution	16-bit
Input freq.	10kHz max.
Minimum pulse	40μs

Power supply, pnp (source) inputs

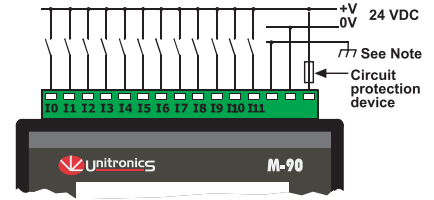

Note:
To avoid electromagnetic interference, mount the controller in a metal panel/cabinet and earth the power supply. Earth the power supply signal to the metal using a wire whose length does not exceed 10cm. If your conditions do not permit this, do not earth the power supply.

nnp (sink) inputs

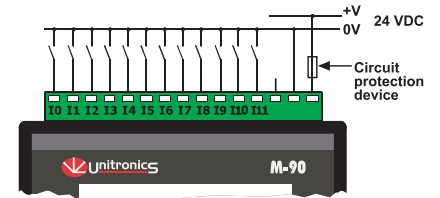

pnp (source) high-speed counter

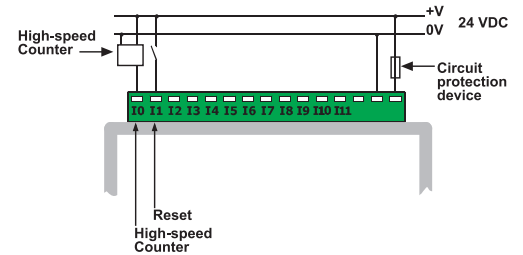

nnp (sink) high-speed counter

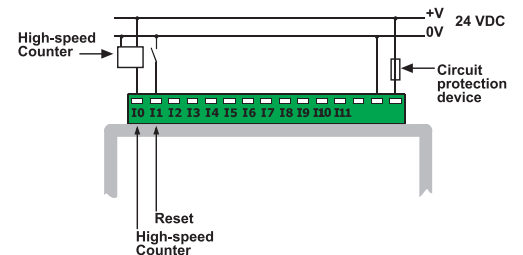

Shaft encoder

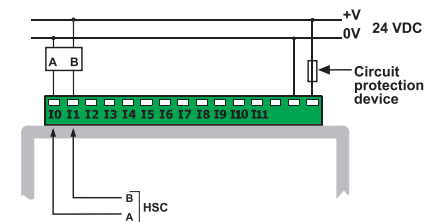

Notes:

- All 12 inputs can be set to pnp (source) or npn (sink) via a single jumper and appropriate wiring.
- nnp (sink) inputs use voltage supplied from the controller's power supply.
- Input #0 can function as either high-speed counter or as part of a shaft encoder. In each case, high-speed input specifications apply. When used as a normal digital input, normal input specifications apply.
- Input #1 can function as either counter reset, or as a normal digital input; in either case, specifications are those of a normal digital input.
This input may also be used as part of a shaft encoder.
In this case, high-speed input specifications apply.

* Certain inputs can function as normal digital inputs, analog inputs or thermocouple inputs, in accordance with jumper settings and wiring connections.



Warnings:

- Unused pins should not be connected. Ignoring this directive may damage the controller.
- Improper use of this product may severely damage the controller.
- Refer to the controller's User Guide regarding wiring considerations.
- Before using this product, it is the responsibility of the user to read the product's User Guide and all accompanying documentation.

Universal Inputs

Analog Inputs	Two 14-bit, multi-range inputs: 0-10V, 0-20mA, 4-20mA See Note 1
Conversion method	Voltage to Frequency
Input impedance	>400K Ω for voltage 500 Ω for current
Isolation	None
Resolution (except 4-20mA)	14-bit (16384 units)
Resolution at 4-20mA	3277 to 16383 (13557 units)
Conversion time	100mSec minimum (according to filter type)
Absolute max. rating	$\pm 15V$ for voltage $\pm 30mA$ for current
Linearity error	0.04% max. of full scale
Error limit	0.4% of input value
Status indication	Yes, see Note 2

Notes:

1. Input#8 and input#10 can be used as analog inputs, related to signal 0V, in accordance with jumper settings and wiring connections.

2. The analog value can also indicate faults, as shown below:

Value	Possible Cause
-1	Input value deviates slightly below the input range.
16384	Input value deviates slightly above the input range
32767	Input value deviates greatly above or below the input range.

Voltage / Current connection

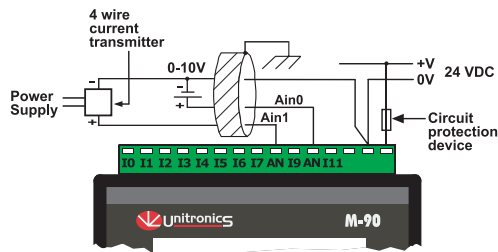

Notes:

- Shields should be connected at the signals' source.
- The 0V signal of the analog input must be connected to the controller's 0V.

Current connection

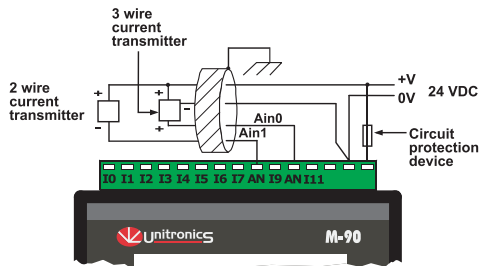

Notes:

- Shields should be connected at the signals' source.
- The 0V signal of the analog input must be connected to the controller's 0V.

Thermocouple inputs	2 differential inputs. See Note 1.
Input type	Thermocouple
Input ranges	As shown in the table below
Isolation	None
Conversion method	Voltage to Frequency
Resolution	0.1°C / 0.1°F
Conversion time	100mSec minimum (according to filter type)
Input impedance	>10M Ω
Cold junction compensation	local, automatic
Cold junction compensation error	$\pm 1.5^\circ C / \pm 2.7^\circ F$ maximum
Absolute maximum rating	± 0.6 VDC
Linearity error	0.04% max. of full scale
Error limit	0.4% of input value
Status indication	None
Warm-up time	$\frac{1}{2}$ hour typically, $\pm 1^\circ C / \pm 1.8^\circ F$ repeatability

Notes:

- Thermocouple #0: use Input#10 as positive input & Input #9 as negative input.
Thermocouple #1: use Input#8 as positive input & Input #7 as negative input.
To use inputs as thermocouple, set the relevant jumpers and use appropriate wiring.

Table 1: input ranges

Type	Temperature range	Wire color	
		ANSI (USA)	BS 1843 (UK)
mV	-5 to 56mV	-	-
B	200 to 1820°C (300 to 3276°F)	+ Grey - Red	+ None - Blue
E	-200 to 750°C (-328 to 1382°F)	+ Violet - Red	+ Brown - Blue
J	-200 to 760°C (-328 to 1400°F)	+ White - Red	+ Yellow - Blue
K	-200 to 1250°C (-328 to 2282°F)	+ Yellow - Red	+ Brown - Blue
N	-200 to 1300°C (-328 to 2372°F)	+ Orange - Red	+ Orange - Blue
R	0 to 1768°C (32 to 3214°F)	+ Black - Red	+ White - Blue
S	0 to 1768°C (32 to 3214°F)	+ Black - Red	+ White - Blue
T	-200 to 400°C (-328 to 752°F)	+ Blue - Red	+ White - Blue

Thermocouple connection

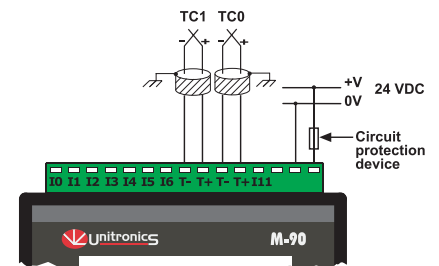

Note:

Shields should be connected at the signals' source.

Digital outputs	10 pnp (source) outputs 24VDC
Output type	P-MOSFET (open drain)
Isolation	None
Output current	0.5A max. Total current: 3A max.
Max. frequency for normal outputs	50Hz (resistive load) 0.5Hz (inductive load)
High speed output maximum frequency	2kHz (resistive load) See Note 1.
Short circuit protection	Yes
Short indication	by software
On voltage drop	0.5VDC maximum
Power supply for outputs	
Operating voltage	20.4 to 28.8VDC
Nominal operating voltage	24VDC

Note:

1. Output #0 and Output #1 may be used as high-speed outputs.

Digital outputs connection

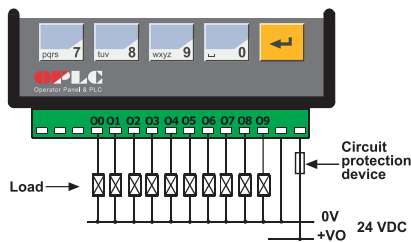

Analog outputs	Two 12-bit analog outputs: 0-10V, 4-20mA, See note 1.
Load impedance	1k Ω minimum—voltage 500 Ω maximum—current
Galvanic isolation	None
Resolution	12-bit (4096 units)
Conversion time	Synchronized to scan time
Linearity error	$\pm 0.1\%$
Operational error limits	$\pm 0.2\%$

Note :

1. Each analog output range is defined by wiring, jumpers and within the controller's software.

Analog outputs connection

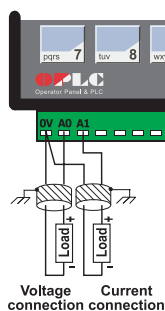

Notes:

- a. Shields should be earthed, connected to the earth of the cabinet.
- b. The 0V signal of the analog outputs must be the same 0V used by the controller's power supply.

Display	STN, LCD display
Illumination	LED yellow-green backlight
Display size	2 lines, 16 characters long
Character size	5 x 8 matrix, 2.95 x 5.55mm

Keypad	Sealed membrane
Number of keys	15

PLC program	
Ladder Code Memory (virtual)	36K
Memory Bits (coils)	256
Memory Integers (Registers)	256
Timers	64
Execution time	12 μ sec. for bit operations
Database	1024 integers (indirect access)
HMI displays	80 user-designed displays
HMI variables	64 HMI variables are available to conditionally display and modify text, numbers, dates, times & timer values. The user can also create a list of up to 120 variable text displays, totaling up to 2K.

RS232/RS485 serial port	Used for: <ul style="list-style-type: none"> • Application Download/Upload • Application Testing (Debug) • Connect to GSM or standard telephone modem: <ul style="list-style-type: none"> - Send/receive SMS messages - Remote access programming • RS485 Networking
--------------------------------	---

RS232 (see note)	1 port
Galvanic isolation	None
Voltage limits	± 20 V
RS485 (see note)	1 port
Input voltage	-7 to +12V differential max.
Cable type	Shielded twisted pair, in compliance with EIA RS485
Galvanic isolation	None
Baud rate	110 – 57600 bps
Nodes	Up to 32

Note:

RS232/RS485 is determined by jumper settings and wiring as described in the document "M91 RS485 Port Settings" packaged with the controller..

I/O expansion port	Up to 96 additional I/Os, including digital & analog I/Os, RTD and more.
---------------------------	--

Miscellaneous	
Clock (RTC)	Real-time clock functions (Date and Time).
Battery back-up	7 years typical battery back-up for RTC and system data.
Weight	270g. (9.82oz)
Operational temperature	0 to 50°C (32 to 122°F)
Storage temperature	-20 to 60°C (-4 to 140°F)
Relative Humidity (RH)	5% to 95% (non-condensing)
Mounting method	DIN-rail mounted (IP20/NEMA1) Panel mounted (IP65/NEMA4X)

The tables below show how to set a specific jumper to change the functionality of a specific input, or analog output. To open the controller and access the jumpers, refer to the directions at the end of these specifications.

Important:

Incompatible jumper settings and wiring connections may severely damage the controller.

JP2, JP3, JP6, JP8
Input#9 and Input#10 (universal input no. 0)

To use as	JP2 for Input#10	JP3 for Input#9	JP6 for Input#10	JP8 for Input#10
Normal digital inputs	A	A	A	B
Thermocouple input* (See Note 1)	B	B	A	B
Analog input - voltage (see Note 3)	B	A See Note 2	B	A
Analog input - current (see Note 3)	B	A See Note 2	B	B

Notes:

1. Thermocouple input is between Input#10 (T+) and Input#9 (T-).
2. When using Input#10 as analog input, Input#9 can be used as normal digital input.
3. Analog inputs are related to signal 0V.

JP4, JP5, JP7, JP9
Input#7 and Input#8 (universal input no. 1)

To use as	JP4 for Input#8	JP5 for Input#7	JP7 for Input#8	JP9 for Input#8
Normal digital inputs	A	A	A	B
Thermocouple input* (See Note 1)	B	B	A	B
Analog input - voltage (see Note 3)	B	A See Note 2	B	A
Analog input - current (see Note 3)	B	A See Note 2	B	B

Notes:

1. Thermocouple input is between Input#8 (T+) and Input#7 (T-).
2. When using Input#8 as analog input, Input#7 can be used as normal digital input.
3. Analog inputs are related to signal 0V.

JP10
Input type (for all digital inputs) -
 see Note 1

To use as	JP10
nnp (sink)	A
pnp (source)*	B

Note:

1. Inputs# 0-6, input #11 and #7-10 when these are set as normal digital inputs.

*Default factory setting

JP12
Analog output #0

To use as	JP12
Voltage*	A
Current	B

JP11
Analog output #1

To use as	JP11
Voltage*	A
Current	B

*Default factory setting

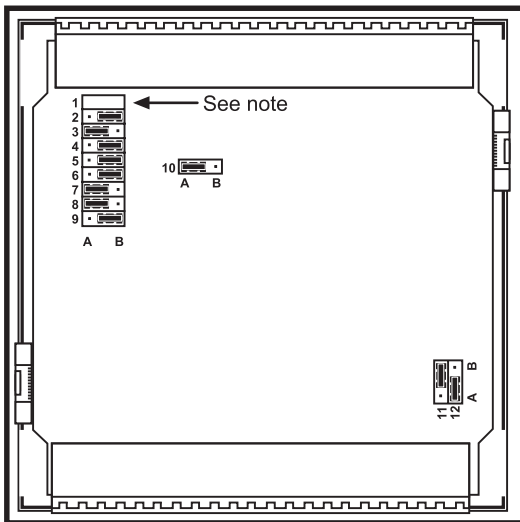

In this figure, the jumper settings will cause the inputs and the analog outputs to function as follows:

- Universal Input #0 (Input #10): Voltage input, related to 0V
- Universal Input #1 (Input #7 and Input #8): Termocouple input
- Input#9: Normal npn, 24VDC digital input
- Input#0 to Input #6 and input #11: npn, 24VDC digital inputs.

(Note that these inputs can only function as normal digital inputs.)

- Analog output #0: Voltage output
- Analog output #1: Current output

Note:
Jumper #1 is reserved - do not use.

Opening the controller enclosure

1. Locate the 4 slots on the sides of the enclosure
2. Using the blade of a flat-bladed screwdriver, gently pry off the back of the controller as shown in the figure below, exposing the controller's board.

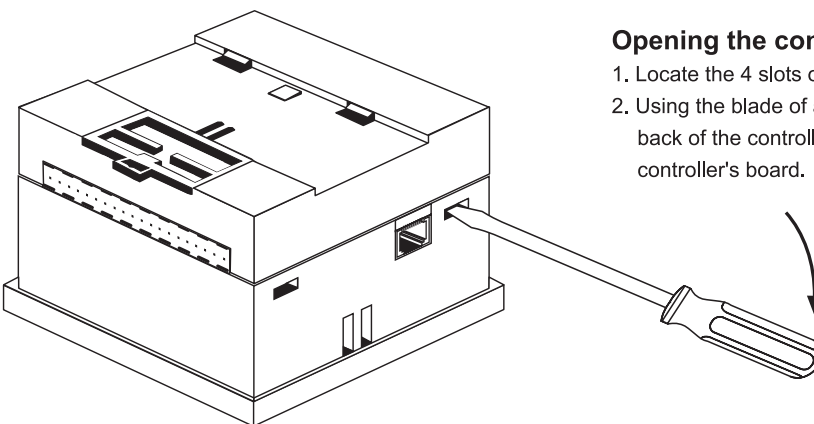

Unitronics reserves the right to revise this publication from time to time and to amend its contents and related hardware and software at any time.
Technical updates (if any) may be included in subsequent editions (if any).
Unitronics product sold hereunder can be used with certain products of other manufacturers at the user's sole responsibility.