

User Manual

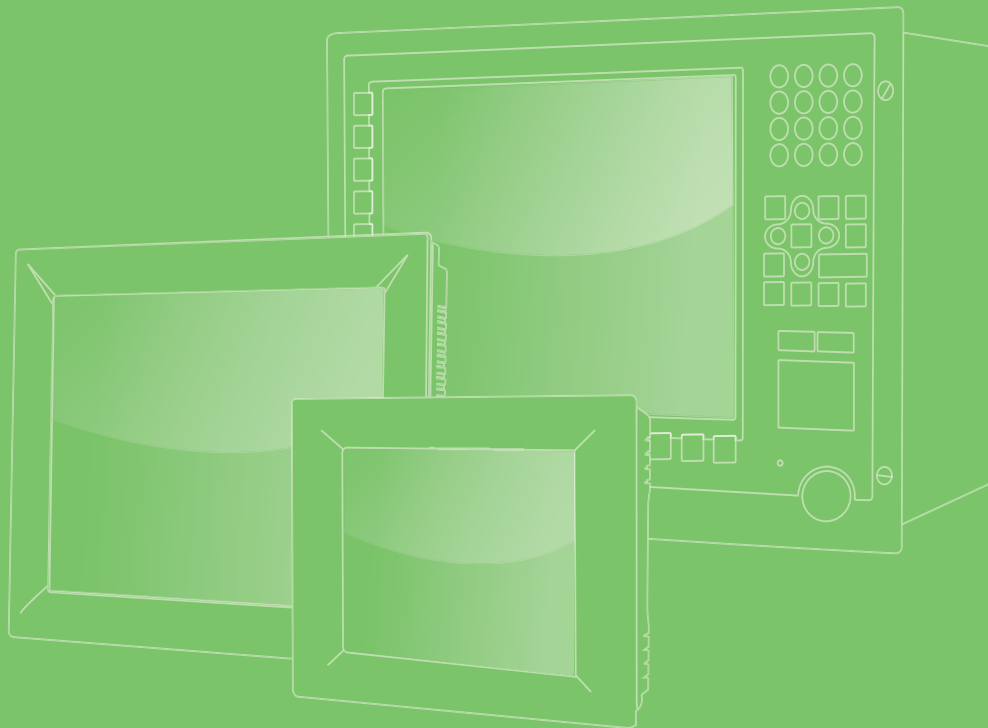

TPC-71W Series

電腦

7" ARM[®] Cortex[®]-A9 Touch
Panel Computer

ADVANTECH

VICPAS
HMI Parts Center

Enabling an Intelligent Planet

限用物質含有情況標示聲明書
Declaration of the Presence Condition of the Restricted Substances Marking

設備名稱：電腦 Equipment name		型號（型式）：TPC-71W（系列型號參次頁） Designation (Type)				
單元 Unit	限用物質及其化學符號 Restricted substances and their chemical symbols					
	鉛 Lead (Pb)	汞 Mercury (Hg)	鎘 Cadmium (Cd)	六價鉻 Hexavalent chromium (Cr ⁺⁶)	多溴聯苯 Polybrominated biphenyls (PBB)	多溴二苯醚 Polybrominated diphenyl ethers (PBDE)
電路板	—	○	○	○	○	○
內外殼	○	○	○	○	○	○
線材	○	○	○	○	○	○
其它固定 組件（螺 絲、螺柱）	—	○	○	○	○	○
顯示器	○	○	○	○	○	○
<p>備考 1. “超出 0.1 wt %” 及 “超出 0.01 wt %” 係指限用物質之百分比含量超出百分比含量基準值。 Note 1. “Exceeding 0.1 wt %” and “exceeding 0.01 wt %” indicate that the content of the restricted substance exceeds the defined concentration limit.</p> <p>備考 2. “○” 係指該項限用物質之百分比含量未超出百分比含量基準值。 Note 2. “○” indicates that the content of the restricted substance does not exceed the defined concentration limit.</p> <p>備考 3. “—” 係指該項限用物質為排除項目。 Note 3. “-” indicates that the restricted substance is not present in the product.</p>						

製造商：研華股份有限公司
地址：台北市內湖區瑞光路 26 巷 20 弄 1 號
電話：02-27927818

Copyright

The documentation and the software included with this product are copyrighted 2023 by Advantech Co., Ltd. All rights are reserved. Advantech Co., Ltd. reserves the right to make improvements in the products described in this manual at any time without notice. No part of this manual may be reproduced, copied, translated, or transmitted in any form or by any means without the prior written permission of Advantech Co., Ltd. The information provided in this manual is intended to be accurate and reliable. However, Advantech Co., Ltd. assumes no responsibility for its use, nor for any infringements of the rights of third parties that may result from its use.

Acknowledgments

NXP and Freescale are registered trademarks of NXP Semiconductors N.V.
All other product names or trademarks are properties of their respective owners.

This manual is applicable to the following models:

- TPC-71W

TPC-71W

TPC-71W-N10PA;

TPC-71W-N21PA;

TPC71WN10PA1801-T; TPC71WN10PA1802-T; TPC71WN10PA1803-T;
TPC71WN10PA1804-T; TPC71WN10PA1805-T; TPC71WN10PA1806-T;
TPC71WN10PA1901-T; TPC71WN10PA1902-T; TPC71WN10PA1903-T;
TPC71WN10PA1904-T; TPC71WN10PA1905-T; TPC71WN10PA1906-T;
TPC71WN10PA2001-T; TPC71WN10PA2002-T; TPC71WN10PA2003-T;
TPC71WN10PA2004-T; TPC71WN10PA2005-T; TPC71WN10PA2006-T;
TPC71WN10PA2101-T; TPC71WN10PA2102-T; TPC71WN10PA2103-T;
TPC71WN10PA2104-T; TPC71WN10PA2105-T; TPC71WN10PA2106-T;

TPC71WN21PA1801-T; TPC71WN21PA1802-T; TPC71WN21PA1803-T;
TPC71WN21PA1804-T; TPC71WN21PA1805-T; TPC71WN21PA1806-T;
TPC71WN21PA1901-T; TPC71WN21PA1902-T; TPC71WN21PA1903-T;
TPC71WN21PA1904-T; TPC71WN21PA1905-T; TPC71WN21PA1906-T;
TPC71WN21PA2001-T; TPC71WN21PA2002-T; TPC71WN21PA2003-T;
TPC71WN21PA2004-T; TPC71WN21PA2005-T; TPC71WN21PA2006-T;
TPC71WN21PA2101-T; TPC71WN21PA2102-T; TPC71WN21PA2103-T;
TPC71WN21PA2104-T; TPC71WN21PA2105-T; TPC71WN21PA2106-T

Product Warranty (2 years)

Advantech warrants the original purchaser that each of its products will be free from defects in materials and workmanship for two years from the date of purchase.

This warranty does not apply to any products that have been repaired or altered by persons other than repair personnel authorized by Advantech, or products that have been subject to misuse, abuse, accident, or improper installation. Advantech assumes no liability under the terms of this warranty as a consequence of such events.

Because of Advantech's high quality-control standards and rigorous testing, most customers never need to use our repair service. If an Advantech product is defective, it will be repaired or replaced free of charge during the warranty period. For out-of-warranty repairs, customers will be billed according to the cost of replacement materials, service time, and freight. Please consult your dealer for more details.

If you believe your product to be defective, follow the steps outlined below.

1. Collect all the information about the problem encountered. (For example, CPU speed, Advantech products used, other hardware and software used, etc.) Note anything abnormal and list any onscreen messages displayed when the problem occurs.
2. Call your dealer and describe the problem. Please have your manual, product, and any helpful information readily available.
3. If your product is diagnosed as defective, obtain a return merchandise authorization (RMA) number from your dealer. This allows us to process your return more quickly.
4. Carefully pack the defective product, a completed Repair and Replacement Order Card, and a proof of purchase date (such as a photocopy of your sales receipt) into a shippable container. Products returned without a proof of purchase date are not eligible for warranty service.
5. Write the RMA number clearly on the outside of the package and ship the package prepaid to your dealer.

Technical Support and Assistance

1. Visit the Advantech website at www.advantech.com/support to obtain the latest product information.
2. Contact your distributor, sales representative, or Advantech's customer service center for technical support if you need additional assistance. Please have the following information ready before calling:
 - Product name and serial number
 - Description of your peripheral attachments
 - Description of your software (operating system, version, application software, etc.)
 - A complete description of the problem
 - The exact wording of any error messages

Declaration of Conformity

CE

This product has passed the CE test for environmental specifications when shielded cables are used for external wiring. We recommend the use of shielded cables. This type of cable is available from Advantech. Please contact your local supplier for ordering information.

Test conditions for passing also include the equipment being operated within an industrial enclosure. In order to protect the product from damage caused by electrostatic discharge (ESD) and EMI leakage, we strongly recommend the use of CE-compliant industrial enclosure products.

FCC Class A

This equipment has been tested and found to comply with the limits for a Class A digital device, pursuant to part 15 of the FCC Rules. These limits are designed to provide reasonable protection against harmful interference when the equipment is operated in a commercial environment. This equipment generates, uses, and can radiate radio frequency energy and, if not installed and used in accordance with the instruction manual, may cause harmful interference to radio communications. Operation of this equipment in a residential area is likely to cause harmful interference. In this event, users are required to correct the interference at their own expense.

警告使用者

這是甲類測試產品，在居住的環境中使用時，可能會造成射頻干擾，在這種情況下，使用者會被要求採取某些適當的對策。

Warnings, Cautions, and Notes

Warning! *Warnings indicate conditions that if not observed can cause personal injury!*



Caution! *Cautions are included to help prevent hardware damage and data losses. For example,*



“Batteries are at risk of exploding if incorrectly installed. Do not attempt to recharge, force open, or heat the battery. Replace the battery only with the same or equivalent type as recommended by the manufacturer. Discard used batteries according to the manufacturer’s instructions.”

Note! *Notes provide additional optional information.*



Safety Instructions

1. Read these safety instructions carefully.
2. Retain this user manual for future reference.
3. Disconnect the equipment from all power outlets before cleaning. Use only a damp cloth for cleaning. Do not use liquid or spray detergents.
4. For pluggable equipment, the power outlet socket must be located near the equipment and easily accessible.
5. Protect the equipment from humidity.
6. Place the equipment on a reliable surface during installation. Dropping or letting the equipment fall may cause damage.
7. The openings on the enclosure are for air convection. Protect the equipment from overheating. Do not cover the openings.
8. Ensure that the voltage of the power source is correct before connecting the equipment to a power outlet.
9. Position the power cord away from high-traffic areas. Do not place anything over the power cord.
10. All cautions and warnings on the equipment should be noted.
11. If the equipment is not used for a long time, disconnect it from the power source to avoid damage from transient overvoltage.
12. Never pour liquid into an opening. This may cause fire or electrical shock.
13. Never open the equipment. For safety reasons, the equipment should be opened only by qualified service personnel.
14. If any of the following occurs, have the equipment checked by service personnel:
 - The power cord or plug is damaged.
 - Liquid has penetrated the equipment.
 - The equipment has been exposed to moisture.
 - The equipment is malfunctioning, or does not operate according to the user manual.
 - The equipment has been dropped and damaged.
 - The equipment shows obvious signs of breakage.
15. Do not leave the equipment in an environment with a storage temperature of below $-30\text{ }^{\circ}\text{C}$ ($-22\text{ }^{\circ}\text{F}$) or above $70\text{ }^{\circ}\text{C}$ ($158\text{ }^{\circ}\text{F}$) as this may damage the components. The equipment should be kept in a controlled environment.
16. CAUTION: Batteries are at risk of exploding if incorrectly replaced. Replace only with the same or equivalent type as recommended by the manufacturer. Discard used batteries according to the manufacturer's instructions.
17. In accordance with IEC 704-1:1982 specifications, the sound pressure level at the operator's position does not exceed 70 dB (A).
18. DISCLAIMER: These instructions are provided according to IEC 704-1 standards. Advantech disclaims all responsibility for the accuracy of any statements contained herein.
19. This product is not intended for use by children (this product is not a toy).
20. This equipment is not suitable for use in locations where children are likely to be present.

Caution! *Danger d'explosion si la batterie est mal remplacée. Remplacer uniquement par le même type ou équivalent recommandé par le fabricant. Jeter les piles usagées selon les instructions du fabricant.*



安全指示

1. 請仔細閱讀此安全操作說明。
2. 請妥善保存此用戶手冊供日後參考。
3. 用濕抹布清洗設備前，請從插座拔下電源線。請不要使用液體或去汙噴霧劑清洗設備。
4. 對於使用電源線的設備，設備周圍必須有容易接觸到的電源插座。
5. 請不要在潮濕環境中使用設備。
6. 請在安裝前確保設備放置在可靠的平面上，意外跌落可能會導致設備損壞。
7. 設備外殼的開口是用於空氣對流，從而防止設備過熱。**請不要覆蓋這些開口。**
8. 當您連接設備到電源插座上前，請確認電源插座的電壓是否符合要求。
9. 請將電源線佈置在人們不易絆到的位置，並不要在電源線上覆蓋任何雜物。
10. 請注意設備上的所有警告和注意標示。
11. 如果長時間不使用設備，請將其同電源插座斷開，避免設備被超標的電壓波動損壞。
12. 請不要讓任何液體流入通風口，以免引起火災或者短路。
13. 請不要自行打開設備。為了確保您的安全，請由經過認證的工程師來打開設備。
14. 如遇下列情況，請由專業人員來維修：
 - 電源線或者插頭損壞；
 - 設備內部有液體流入；
 - 設備曾暴露在過於潮濕的環境中使用；
 - 設備無法正常工作，或您無法通過用戶手冊來使其正常工作；
 - 設備跌落或者損壞；
 - 設備有明顯的外觀破損。
15. 請不要把設備保存在超出我們建議的溫度範圍的環境，即不要低於 -30°C (-22°F) 或高於 70°C (158°F)，否則可能會損壞設備。
16. **注意：**如果電池放置不正確，將有爆炸的危險。因此，只可以使用製造商推薦的同一種或者同等型號的電池進行替換。請按照製造商的指示處理舊電池。
17. 根據 IEC 704-1:1982 的規定，操作員所在位置的音量不可高於 70dB(A)。
18. **限制區域：**請勿將設備安裝於限制區域使用。
19. **免責聲明：**該安全指示符合 IEC 704-1 的要求。研華公司對其內容的準確性不承擔任何法律責任。
20. 使用過度恐傷害視力。
21. 使用 30 分鐘請休息 10 分鐘。
22. 未滿 2 歲幼兒不看螢幕，2 歲以上每天看螢幕不要超過 1 小時。
23. 本產品為國內裝置使用時，其電源僅限使用架構電源模組所提供電源直流輸入，不得使用交流電源及附加其他電源轉換裝置提供電源這者，其電源輸入電壓及電流請依說明書規定使用。

Wichtige Sicherheitshinweise

1. Bitte lesen sie Sich diese Hinweise sorgfältig durch.
2. Heben Sie diese Anleitung für den späteren Gebrauch auf.
3. Vor jedem Reinigen ist das Gerät vom Stromnetz zu trennen. Verwenden Sie Keine Flüssig-oder Aerosolreiniger. Am besten dient ein angefeuchtetes Tuch zur Reinigung.
4. Die Netzanschlussteckdose soll nahe dem Gerät angebracht und leicht zugänglich sein.
5. Das Gerät ist vor Feuchtigkeit zu schützen.
6. Bei der Aufstellung des Gerätes ist auf sicheren Stand zu achten. Ein Kippen oder Fallen könnte Verletzungen hervorrufen.
7. Die Belüftungsöffnungen dienen zur Luftzirkulation die das Gerät vor überhitzung schützt. Sorgen Sie dafür, daß diese Öffnungen nicht abgedeckt werden.
8. Beachten Sie beim. Anschluß an das Stromnetz die Anschlußwerte.
9. Verlegen Sie die Netzanschlusbleitung so, daß niemand darüber fallen kann. Es sollte auch nichts auf der Leitung abgestellt werden.
10. Es sollte auch nichts auf der Leitung abgestellt werden. Alle Hinweise und Warnungen die sich am Ger?ten befinden sind zu beachten.
11. Wird das Gerät über einen längeren Zeitraum nicht benutzt, sollten Sie es vom Stromnetz trennen. Somit wird im Falle einer Überspannung eine Beschädigung vermieden.
12. Durch die Lüftungsöffnungen dürfen niemals Gegenstände oder Flüssigkeiten in das Gerät gelangen. Dies könnte einen Brand bzw. elektrischen Schlag auslösen.
13. Öffnen Sie niemals das Gerät. Das Gerät darf aus Gründen der elektrischen Sicherheit nur von autorisiertem Servicepersonal geöffnet werden.
14. Wenn folgende Situationen auftreten ist das Gerät vom Stromnetz zu trennen und von einer qualifizierten Servicestelle zu überprüfen:
 - a. Netzkabel oder Netzstecker sind beschädigt.
 - b. Flüssigkeit ist in das Gerät eingedrungen.
 - c. Das Gerät war Feuchtigkeit ausgesetzt.
 - d. Wenn das Gerät nicht der Bedienungsanleitung entsprechend funktioniert oder Sie mit Hilfe dieser Anleitung keine Verbesserung erzielen.
15. **VORSICHT:** Explosionsgefahr bei unsachgemäßen Austausch der Batterie. Ersatz nur durch denselben oder einem vom Hersteller empfohlene-mähnlichen Typ. Entsorgung gebrauchter Batterien nach Angaben des Herstellers.
16. **ACHTUNG:** Es besteht die Explosionsgefahr, falls die Batterie auf nicht fachmännische Weise gewechselt wird. Verfassen Sie die Batterie nur gleicher oder entsprechender Type, wie vom Hersteller empfohlen. Entsorgen Sie Batterien nach Anweisung des Herstellers.
17. Der arbeitsplatzbezogene Schalldruckpegel nach DIN 45 635 Teil 1000 beträgt 70dB(A) oder weiger.
18. Haftungsausschluss: Die Bedienungsanleitungen wurden entsprechend der IEC-704-1 erstellt. Advantech lehnt jegliche Verantwortung für die Richtigkeit der in die- sem Zusammenhang getätigten Aussagen ab.

Safety Precaution - Static Electricity

Follow these simple precautions to protect yourself from harm and the products from damage.

- To avoid electrical shock, always disconnect the power from the PC chassis before manual handling. Do not touch any components on the CPU card or other cards while the PC is powered on.
- Disconnect the power before making any configuration changes. A sudden rush of power after connecting a jumper or installing a card may damage sensitive electronic components.

Contents

Chapter 1	General Information	1
1.1	Introduction	2
1.2	Specifications	2
	1.2.1 System Kernel.....	2
	1.2.2 Communication Interface	2
	1.2.3 LCD Panel.....	2
	1.2.4 Touchscreen	3
	1.2.5 Environment.....	3
	1.2.6 EMC and Safety.....	3
	1.2.7 Power.....	3
	1.2.8 External I/O.....	4
1.3	Mounting	5
1.4	Dimensions and Cutout.....	6
Chapter 2	System Setup.....	7
2.1	Transport and Unpacking.....	8
2.2	System configuration.....	8
2.3	Mini PCI Express Module Installation.....	10
2.4	USB Module Installation.....	11
2.5	System Power On	11
Chapter 3	Linux Ubuntu	13
3.1	ARM Ubuntu16.04.....	14
3.2	ARM Ubuntu 16.04 Software Support.....	14
	3.2.1 System Default Software	14
	3.2.2 Install Software Package Online Through APT Command	14
	3.2.3 The Online Installation of Command Software	14
3.3	TPC-71W Module Extension.....	15
	3.3.1 Module Information	15
	3.3.2 The Configuration and Connection of WIFI Module.....	15
3.4	Time And Date Setting	16
3.5	CAN Setting	16
3.6	Watchdog Setting.....	17
3.7	Brightness Setting	18
3.8	X11vnc Setting.....	18
Appendix A	Pin Assignments	21
A.1	MINI PCI Express Slot	22
A.2	4-pin USB Connector	23
A.3	COM Port	23

Chapter 1

General Information

1.1 Introduction

The TPC-71W series of touch panel computers consist of state-of-the-art 7" operator interface combined with ARM-based computing platform offers these key features:

- NXP® ARM Cortex®-A9 i.MX6 Dual/Quad core processor
- 7" 16:9 WSVGA LCD wide screen with PCAP multi-touch
- Up to 2G DDR3L RAM & 8G eMMC storage onboard
- 10/100/1000 Mbps LAN
- 1MB FRAM backup memory for power interruption situation
- Serial port with termination resistor 120Ω supporting CAN 2.0B protocol specification and programmable bit rate up to 1 Mb/sec
- Linux Yocto 2.1, Linux Ubuntu 16.04 and Android 6 Support
- Optional NFC and mPCIe module expansion support
- VESA and panel mounting with true-flat IP66 front panel support
- -20 ~ 60 °C wide operating temperature range

1.2 Specifications

1.2.1 System Kernel

- **CPU:**
NXP® ARM Cortex®-A9 i.MX6 Dual Core Processor
NXP® ARM Cortex®-A9 i.MX6 Quad Core Processor
- **Memory:**
Dual Core: 1GB DDR3L RAM on board
Quad Core: 2GB DDR3L RAM on board
- **Storage Memory:** 8GB eMMC on board; 1MB FRAM for data backup
- **Watchdog Timer:** Programmable as 1 second

1.2.2 Communication Interface

- **Serial Port:** 1 x DB9 selectable mode for RS-232/485 and CAN 2.0 B
- **LAN Port:** 1 x RJ45 with 10/100/1000 Mbps LAN
- **Others:**
1 x USB 2.0 Type-B Client
2 x USB 2.0 Type-A Host
1 x Micro SD

1.2.3 LCD Panel

- **Panel Type:** WSVGA TFT LCD
- **Panel Size:** 7 in (177.8 mm)
- **Max. Resolution:** 1024 x 600
- **Max. Colors:** 16.7M
- **Luminance:** 400 cd/m²
- **Viewing Angle (H/V):** 170/170
- **Backlight Life:** 50,000 hrs
- **Treatment:** Anti-glare
- **Contrast Ratio:** 800:1
- **Front Panel LED Indicator:** Yes

1.2.4 Touchscreen

- **Touch Points:** 10 Points
- **Light Transmission:** above 85%
- **Pencil Hardness:** 7H
- **Type:** Projected capacitive (P-CAP) touch

1.2.5 Environment

- **Operating Temperature:** -20 ~ 60 °C (-4 ~ 140 °F)
The Temperature of Safety Certification is from -20 ~ 50 °C (-4 ~ 140 °F)
- **Storage Temperature:** -30 ~ 70 °C (-22 ~ 158 °F)
- **Humidity:** 10 ~ 90% RH @ 40 °C, non-condensing
- **Ingress Protection:** Compliant with IP66 on front panel
- **Vibration Protection:** 2 Grms random vibration (5 ~ 500 Hz) during operation (compliant with IEC60068-2-64)
- **Shock Protection:** 10 G shock under 11 ms operation (compliant with IEC60068-2-27)

1.2.6 EMC and Safety

- **EMC:** CE, FCC Class B, BSMI
- **Safety:** CB, UL, CCC

1.2.7 Power

- **Input Voltage:** 24VDC ± 20%
- **Power Consumption:** 9W (Typical)

This product is intended to be supplied by IEC/UL 60950-1 and/or IEC/UL 62368-1 Listed adapter complies with Limited Power Source and rated from: 24 Vdc, minimum 0.6A, minimum operating temperature 50°C.

1.2.8 External I/O

The arrangement of I/O ports is shown below:

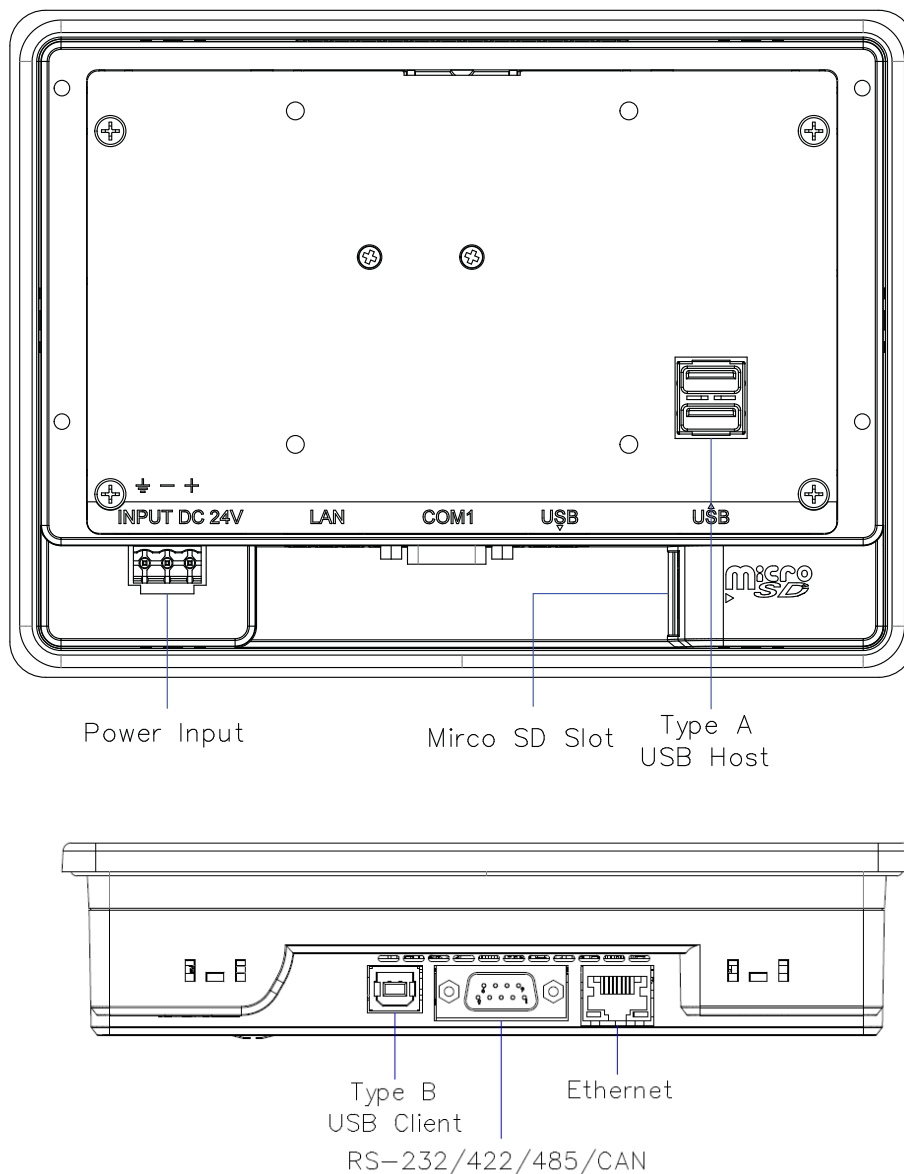

1.3 Mounting

■ VESA Mount

The TPC-71 rear cover features four VESA mounting (75 x 75 mm) holes. The VESA mounting kit needs to be installed by 4pcs M4x10L and 4pcs M4x8L screws. Please use suitable mounting apparatus to avoid risk of injury.

Le capot arrière du TPC-71 dispose de quatre trous de montage VESA (75 x 75 mm). Le kit de montage VESA doit être installé à l'aide de 4 vis M4x10L et de 4 vis M4x8L. Veuillez utiliser un appareil de montage approprié pour éviter tout risque de blessure.

■ Panel Mount

There is an adhesive waterproof gasket on the front bezel. Make sure the waterproof gasket is in position before installing a TPC-71 panel computer into the panel opening.

1. Install the TPC into the panel opening.
2. Find the six clamps and six long screws in the accessory pack. Hook the clamps to the holes around the four sides of the bezel. Insert the screws into every clamp and fasten them. These screws will push the mounting panel and fix the unit.
3. The suggested mounting panel thickness is less than 6 mm (0.236").

Il y a un joint adhésif imperméable sur le panneau avant. Assurez-vous que l'imperméable Le joint est en place avant d'installer un ordinateur à panneau TPC-71 dans l'ouverture du panneau.

1. *Installez le TPC dans l'ouverture du panneau.*
2. *Recherchez les six pinces et les six vis longues dans le pack d'accessoires. Accrocher les pinces aux trous autour des quatre côtés de la lunette. Insérez les vis dans chaque attachez-les et attachez-les. Ces vis vont pousser le panneau de montage et fixer l'unité.*
3. *L'épaisseur de panneau de montage suggérée est inférieure à 6 mm (0,236 ").*

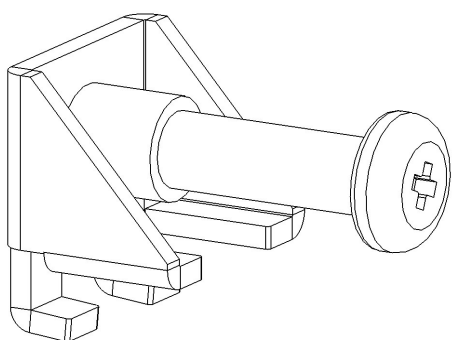

Insert the screws into each clamp and tighten them to fasten the clamp in place.

Insérez les vis dans chaque collier et serrez-les pour fixer le collier en place.

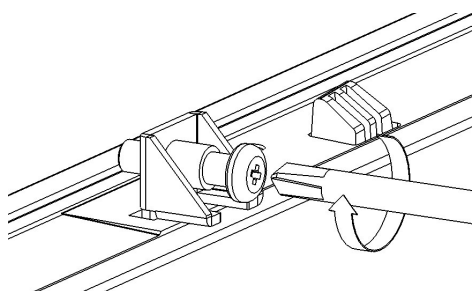

Hook the clamp into the holes and fasten the screws (Torque: 2 kgf-cm)
These screws will push the mounting panel and secure the unit.

*Accrocher la pince dans les trous et serrer les vis (couple: 2 kgf-cm)
Ces vis vont pousser le panneau de montage et sécuriser l'unité.*

1.4 Dimensions and Cutout

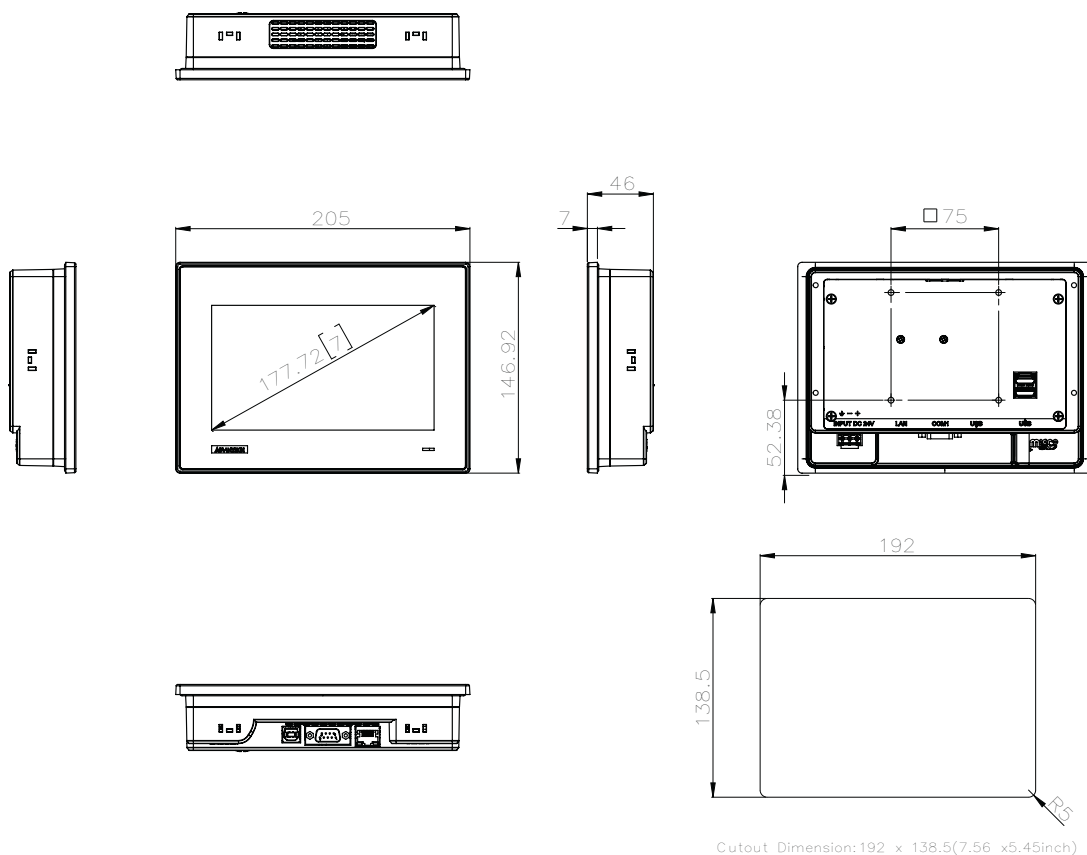

Chapter 2

System Setup

2.1 Transport and Unpacking

When accepting a delivery, please check the packaging for visible transportation damage and check the delivery for completeness by comparing it with your order form. If you notice any shipping damage or inconsistencies between the contents and your order, please inform the responsible delivery service immediately. During transportation, the TPC system should be protected from excessive mechanical stress. If the TPC system is transported or stored without packaging, shocks, vibrations, pressure, and moisture may impact the unprotected unit. Additionally, damaged packaging indicates that ambient conditions have already had a massive impact on the device. Therefore, please use the original packaging during transportation and storage. If the TPC system is transported in cold weather or is exposed to extreme variations in temperature ensure that moisture (condensation) does not build up on or inside the HMI device. Moisture can result in short circuits and damage to the device. To avoid this, store the TPC system in a dry environment and bring the system to room temperature before powering it up. If condensation occurs, a delay time of approximately 12 hours must be allowed to ensure that the system is completely dry before being switched on.

2.2 System configuration

TPC-71W is a compact touch panel with IIoT functions for industrial applications. The system setup will be completed by the dealer or system integrator prior to delivery. However, users may still need to access the system to adjust configuration, such as the interface or boot modes. Before powering on, please open the rear bracket and select the correct mode. Configuration can be set via the switch on the TPC-71W rear board as shown below.

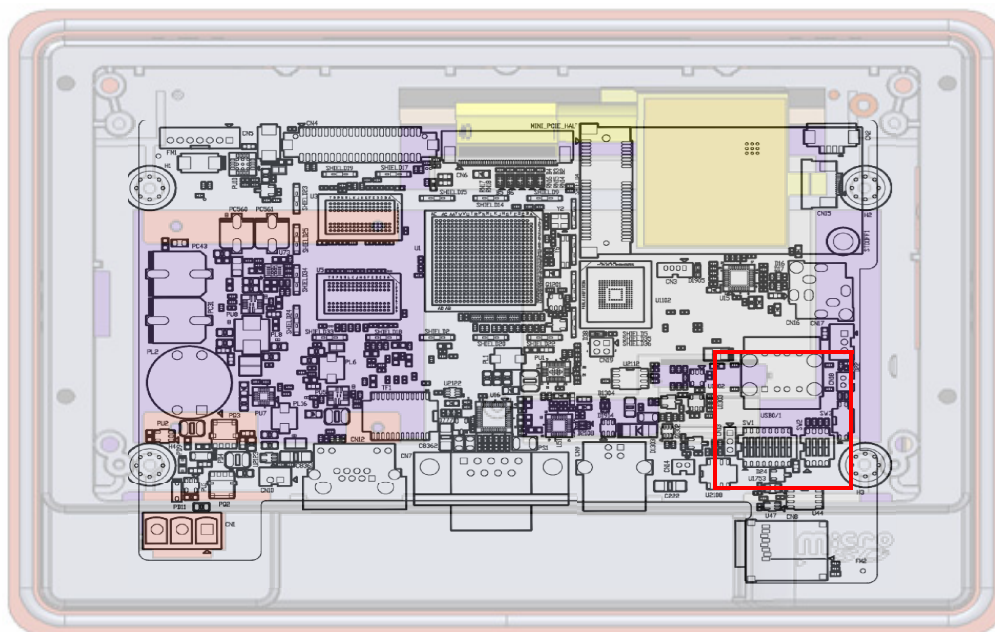

The default setting is RS232 mode and eMMC Boot. Kindly refer to the following pin definition table for mode switch.

■ COM Port Mode: RS232/RS485/CAN/RS422

RS232 Mode (Default)	SW1	Bit 1,3 ON Bit 2,4,5,6,7,8 OFF	
	SW2	Bit 2 ON Bit 1,3,4 OFF	
RS485 Mode	SW1	Bit 1,3 ON Bit 2,4,5,6,7,8 OFF	
	SW2	Bit 1,4 ON Bit 2,3 OFF	
RS485 Mode termination resistor	SW1	Bit 1,3 ON Bit 2,4,5,6,7,8 OFF	
	SW2	Bit 1,3,4 ON Bit 2 OFF	
CAN Mode	SW1	Bit 2,4,5 ON Bit 1,3,6,7,8 OFF	
	SW2	Bit 1,2,3,4 OFF	
CAN Mode termination resistor	SW1	Bit 2,4,5,6 ON Bit 1,3,7,8 OFF	
	SW2	Bit 1,2,3,4 OFF	
RS422 Mode	SW1	Bit 1,3 ON Bit 2,4,5,6,7,8 OFF	
	SW2	Bit 1,2,4 ON Bit 3 OFF	

■ Boot Mode: eMMC/SD Card

SD boot the system	SW3	Bit 2 ON Bit 1 OFF	<p>SW3</p> <p>1</p>
eMMC boot the system	SW3	Bit 1 ON Bit 2 OFF	<p>SW3</p> <p>1</p>

Warning! To avoid the system damage, the device may unable to incorrect or undefined switch may cause the system may be damaged when the power is turned on if the power source is not connected to the correct pins.



2.3 Mini PCI Express Module Installation

TPC-71W provides 1 MINI PCI Express slot and allows users to expend functions like Wi-F, Bluetooth or the other PCI Express type modules. Open the rear bracket and configure the MINI PCI Express module on MINI PCI Express slot. (Refer to Appendix B for the detailed MINI PCI Express slot pin assignments)

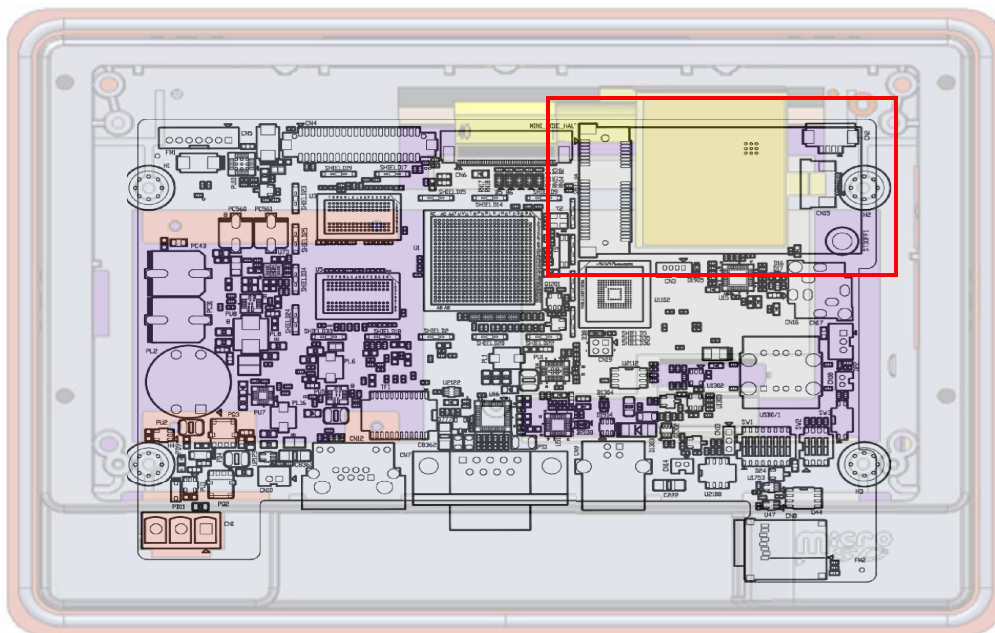

2.4 USB Module Installation

TPC-71W provides additional 1 internal 4-pin USB connector and allows users to expend the function like NFC or the other USB type modules. Please open the rear bracket and configure the USB module by USB connector. (Refer to Appendix B for the detailed USB connector pin assignments)

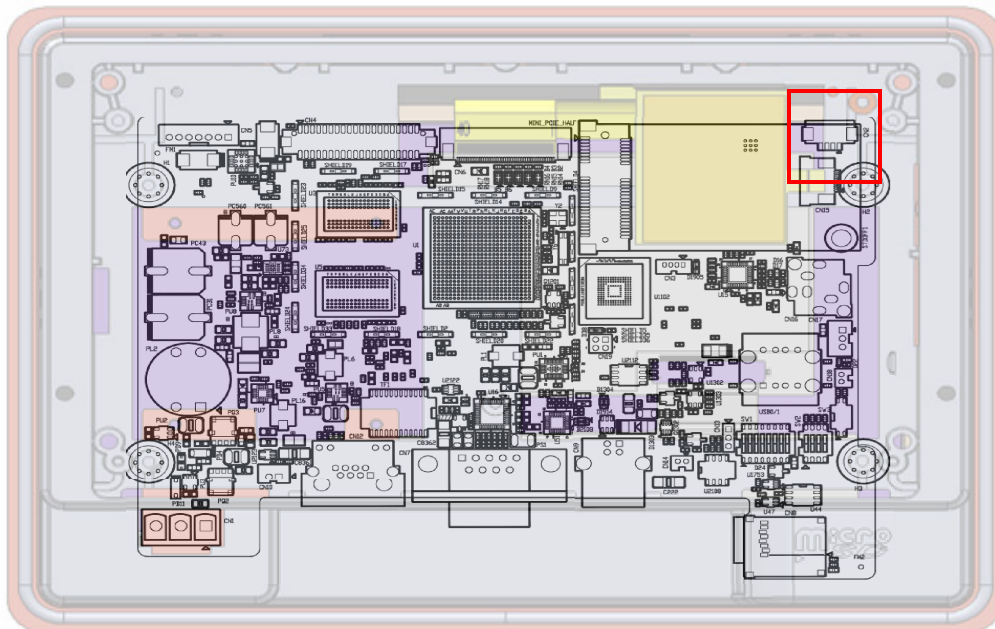

2.5 System Power On

A 3-pin power connector is included in the accessory box. Connect the power connector to 24VDC power lines and plug the power lines into the system power receptor. DC power source shall be complied with ES1 and PS3 requirements, output rating is 24 Vdc, minimum 0.6A, with minimum operating temperature 50°C, and has to be evaluated according to IEC/UL 60950-1 and/or IEC/UL 62368-1.

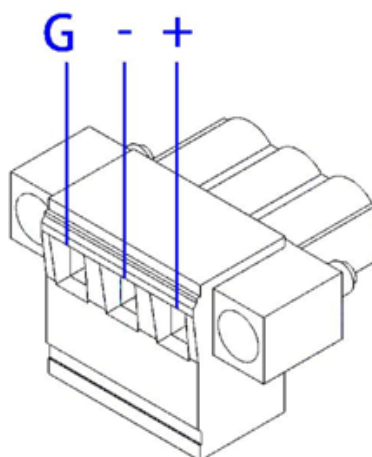

Warning! The system may get damaged when the power is turned on and the power source is not connected to the correct pins.



Chapter 3

Linux Ubuntu

3.1 ARM Ubuntu16.04

TPC-71W platform is an embedded system with Linux ARM Ubuntu 16.04. It contains all system-required shell commands and drivers ready. We do not offer IDE developing environment in TPC-71W BSP, but users can evaluate and develop under Ubuntu 16.04 LTS 64-bit environment.

ARM Linux Ubuntu 16.04 is a compact operating system that occupies less storage space and use less system resources compared with other operating systems. By its modular nature, it is possible to choose the functions that are useful for a specific application. This not only reduces the system resources required, it also reduces start-up times. In the field of industrial automation or for operator interface terminals, this is an appealing feature because the impact of downtime is minimized. Furthermore, the small storage space required makes it possible to install the operating system on a reliable solidstate disk.

3.2 ARM Ubuntu 16.04 Software Support

3.2.1 System Default Software

ARM Ubuntu 16.04 support complete IIoT function as default including:

- Chromium
- X11VNC
- SSH
- Qtcreator

3.2.2 Install Software Package Online Through APT Command

ARM Ubuntu 16.04 allows users to install software by APT, Advanced Package Tool. Rather than programming the source code for installation in image, the related software on ARM Ubuntu 16.04 can be setup by related APT commands online. APT commands can default configuration document to connect Ubuntu software server and download software from the server. If the requesting 3rd party software is not included in the official Ubuntu server, the configuration on system image source file is needed. The source file can be found under `/etc/apt/source.list`.

1. Edit source.list document and add the new image source.
2. Execute command `apt-get update` to update image source.

3.2.3 The Online Installation of Command Software

APT Command:

- Install Software Package:
`# sudo apt-get install packagename`
- Remove Software Package:
`# sudo apt-get remove packagename`
- Get New Software Package List:
`# sudo apt-get update`
- Upgrade Software If There Is Updated Version Software Available:
`# sudo apt-get upgrade`
- Search Needed Software Package:
`#apt-cache search packagename`
- List More Command and Option:
`# apt-get help`

About APT Command, please refer to Internet for more detailed. Below we list the command for common software installation

The Installation of MySQL®

```
# apt-get install mysql-server
```

The Installation of Apache Web®

```
# apt-get install apache2 apache2-dev
```

The Installation of PHP®

```
# apt-get install php
```

The Installation of Python®

```
# apt-get install python
```

The Installation of QtCreator®

```
# apt-get install qtcreator
```

3.3 TPC-71W Module Extension

TPC-71W supports one mPCIe slot and one internal USB connector which allows users to expand the functionality. There are pre-configured mPCIe Wi-Fi modules ready to use. This chapter will take mPCIe Wi-Fi module as an example to demonstrate how to use a mPCIe module on TPC-71W

3.3.1 Module Information

Advantech WiFi Module Part Number: EWM-W151H01E

3.3.2 The Configuration and Connection of WIFI Module

Configure by User Interface

1. Open terminal and load Wi-Fi module document.

```
#insmod /lib/modules/4.1.15/kernel/drivers/net/wireless/88x2bu.ko  
#insmod /lib/modules/4.1.15/kernel/drivers/net/wireless/8821ae.ko  
#insmod /lib/modules/4.1.15/kernel/drivers/net/wireless/8188eu.ko
```

2. Check the icon  on the top of the user interface.
3. Click the icon and enable Wi-Fi function.

Configure by Command mode

Connect to WPA2/PSK encrypted network:

```
root@tpc71wn10pa:~#cd /usr/Advantech/Wifi_test  
root@tpc71wn10pa:/usr/Advantech/Wifi_test#./wpa_test.sh<WIFI_ID> <WIFI_-  
PASSWD>
```

Connect to open network:

```
root@tpc71wn10pa:~# cd /usr/Advantech/Wifi_test
root@tpc71wn10pa:/usr/Advantech/Wifi_test# ./wpa_nopwd_test.sh <WIFI_ID>
```

Disconnect from network:

```
root@tpc71wn10pa:~# cd /usr/Advantech/Wifi_test
root@tpc71wn10pa:/usr/Advantech/Wifi_test# ./wpa_off.sh
```

3.4 Time And Date Setting

Set system time (2019/01/01 13:25:00):

```
root@tpc71wn10pa:~# date -s "2019/01/01 13:25:00"
```

Synchronize time from the NTP server:

```
root@tpc71wn10pa:~# ntpdate <NTPSERVERIP>
```

Reset RTC hardware clock time (use current system time):

```
root@tpc71wn10pa:~# hwclock -w
```

Reset system time (use RTC hardware clock time):

```
root@tpc71wn10pa:~# hwclock -s
```

Set system time zone (use Shanghai time):

```
root@tpc71wn10pa:~# cp /usr/share/zoneinfo/Asia/Shanghai /etc/localtime
root@tpc71wn10pa:~# sync
```

3.5 CAN Setting

TPC-71W support flexCAN. The below table shows the detailed information of flex-CAN on TPC-71W and here we list the basic command to use CAN on TPC-71W.

HW	DEVICE	MODE
flexCAN0	can0	socket can

Setting: Open flexCAN device (125000 bitrate, loopback off)

```
root@tpc71wn10pa:~# ip link set can0 down
root@tpc71wn10pa:~# ip link set can0 up type can bitrate 125000 loopback off
root@tpc71wn10pa:~# ip link set can0 up
root@tpc71wn10pa:~# ifconfig can0
can0      Link encap:UNSPEC  HWaddr 00-00-00-00-00-00-00-00-00-00-00-00-00-00-00
          UP RUNNING NOARP  MTU:16  Metric:1
          RX packets:0 errors:0 dropped:0 overruns:0 frame:0
          TX packets:0 errors:0 dropped:0 overruns:0 carrier:0
          collisions:0 txqueuelen:10
          RX bytes:0 (0.0 B)  TX bytes:0 (0.0 B)
          Interrupt:31
```

Check can0 status:

```
root@tpc71wn10pa:~# ip -details link show can0
3: can0: <NOARP,UP,LOWER_UP,ECHO> mtu 16 qdisc pfifo_fast state UNKNOWN mode DEFAULT
group default qlen 10
    link/can  promiscuity 0
    can state  ERROR-ACTIVE (berr-counter tx 0 rx 0) restart-ms 0
              bitrate 125000 sample-point 0.875
              tq 500 prop-seg 6 phase-seg1 7 phase-seg2 2 sjw 1
              flexcan: tseg1 4..16 tseg2 2..8 sjw 1..4 brp 1..256 brp-inc 1
              clock 30000000
```

Send message ("123#11") to socket can0:

```
root@tpc71wn10pa:~# cansend can0 123#11
```

Recv message from socket can0:

```
root@tpc71wn10pa:~# candump can0
```

3.6 Watchdog Setting

Enable wdt with timeout value:

```
root@tpc71wn10pa:~# cd /usr/Advantech/EAPI_test
root@tpc71wn10pa:/usr/Advantech/EAPI_test# ./testdl_wdt -s <timeout>

# For example(enable wdt & set timeout=10s):
root@tpc71wn10pa:/usr/Advantech/EAPI_test# ./testdl_wdt -s 10
MaxDelay:0 MaxEventTimeout:0 MaxResetTimeout:6553
WDT start.
WDT timeout has been set to 10 seconds.
After that, WDT will reset CPU.
```

Enable wdt for keepalive mode (timeout=20s, feed wdt each 10s):

```
root@tpc71wn10pa:~# cd /usr/Advantech/EAPI_test
root@tpc71wn10pa:/usr/Advantech/EAPI_test# ./testdl_wdt -k
MaxDelay:0 MaxEventTimeout:0 MaxResetTimeout:6553
WDT start.
WDT timeout has been set to 20 seconds.
After that, WDT will reset CPU.
WDT keep alive.
WDT keep alive.
.....
```

Disable wdt:

```
root@tpc71wn10pa:~# cd /usr/Advantech/EAPI_test
root@tpc71wn10pa:/usr/Advantech/EAPI_test# ./testdl_wdt -d
MaxDelay:0 MaxEventTimeout:0 MaxResetTimeout:6553
WDT stop.
```

3.7 Brightness Setting

Increased the brightness step by step every second:

```
root@tpc71wn10pa:~# cd /usr/Advantech/EAPI_test
root@tpc71wn10pa:/usr/Advantech/EAPI_test# ./testdl_brightness
Value: 7
Current bright: 0
Current bright: 0
Current bright: 1
Current bright: 1
Current bright: 2
Current bright: 2
Current bright: 3
Current bright: 3
Current bright: 4
Current bright: 4
Current bright: 5
Current bright: 5
Current bright: 6
Current bright: 6
Current bright: 7
Current bright: 7
```

3.8 X11vnc Setting

1. Login with debug console

```
Ubuntu 16.04.3 LTS tpc71wn21pa ttymsc0

tpc71wn21pa login: root
Password:
Welcome to Ubuntu 16.04.3 LTS (GNU/Linux 4.1.15 armv7l)

* Documentation:  https://help.ubuntu.com
* Management:    https://landscape.canonical.com
* Support:       https://ubuntu.com/advantage

352 packages can be updated.
251 updates are security updates.

root@tpc71wn21pa:~# █
```

2. Get current ethernet IP

```

root@tpc71wn21pa:~# ifconfig
eth0      Link encap:Ethernet  HWaddr c4:00:ad:26:dd:26
          inet addr:172.21.73.131  Bcast:172.21.73.255  Mask:255.255.255.0
          inet6 addr: fe80::4681:c798:ac11:7fdb/64  Scope:Link
          UP BROADCAST RUNNING MULTICAST  MTU:1500  Metric:1
          RX packets:102 errors:0 dropped:0 overruns:0 frame:0
          TX packets:54 errors:0 dropped:0 overruns:0 carrier:0
          collisions:0 txqueuelen:1000
          RX bytes:12134 (12.1 KB)  TX bytes:5808 (5.8 KB)

lo        Link encap:Local Loopback
          inet addr:127.0.0.1  Mask:255.0.0.0
          inet6 addr: ::1/128  Scope:Host
          UP LOOPBACK RUNNING  MTU:65536  Metric:1
          RX packets:50 errors:0 dropped:0 overruns:0 frame:0
          TX packets:50 errors:0 dropped:0 overruns:0 carrier:0
          collisions:0 txqueuelen:0
          RX bytes:4622 (4.6 KB)  TX bytes:4622 (4.6 KB)
    
```

3. Start x11vnc server

```

root@tpc71wn21pa:~# /usr/Advantech/X11vnc_test/start_x11vnc.sh &
[1] 5733
root@tpc71wn21pa:~# 22/04/2019 23:34:14 passing arg to libvncserver: -rfbport
22/04/2019 23:34:14 passing arg to libvncserver: 5900
#####
#0000000000000000000000000000000000000000000000000000000000000000#
#@
#@  ** WARNING ** WARNING ** WARNING ** WARNING **  @#
#@
#@          YOU ARE RUNNING X11VNC WITHOUT A PASSWORD!!  @#
#@
#@  This means anyone with network access to this computer  @#
#@  may be able to view and control your desktop.  @#
#@
#@ >>> If you did not mean to do this Press CTRL-C now!! <<<  @#
#@
#@0000000000000000000000000000000000000000000000000000000000000000#
#@
#@  You can create an x11vnc password file by running:  @#
#@
#@          x11vnc -storepasswd password /path/to/passfile  @#
#@
    
```

4. Remote desktop (use VNC Viewer 6.18.625)

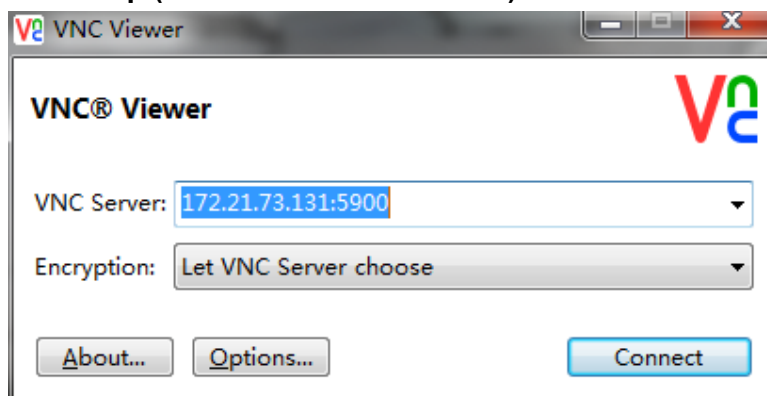

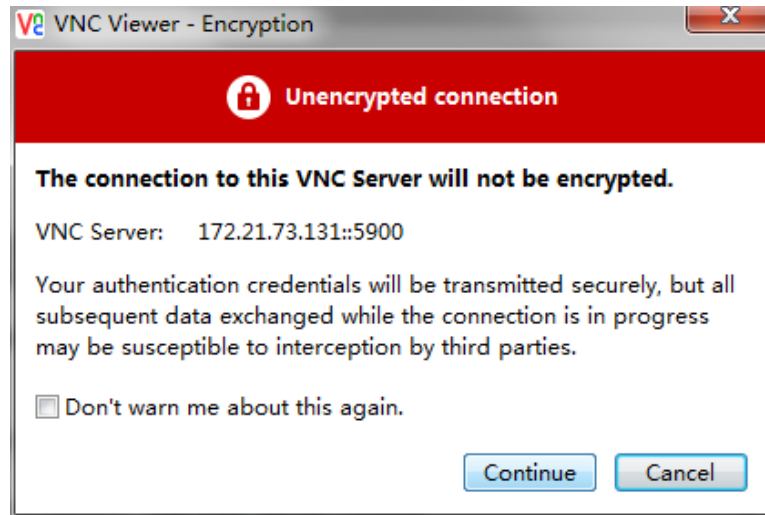

Appendix **A**

Pin Assignments

A.1 MINI PCI Express Slot

- 9.0mm half size 52 Port MINI PCI Express slot

Pin	Signal	Description	Pin	Signal	Description
52	+3.3Vaux/ +3.3V	PCI1.1 was +3.3V, PCI1.2 was +3.3Vaux	51	Reserved	NC
50	GND		49	Reserved	NC
48	+1.5V		47	Reserved	NC
46	NC	NC	45	Reserved	NC
44	NC	NC	43	PIN43_MP- CIE_PWRSEL	The pin to select the Pin 2, 52 power output for +3.3Vaux or +3.3V (PCI1.1 was reserved and PIC1.2 was GND)
42	NC	NC	41	+3.3Vaux	
40	GND		39	+3.3Vaux	
38	USB_D+	USB serial data inter- face compliant to the USB 2.0 specification	37	GND	
36	USB_D-		35	GND	
34	GND		33	PETp0	PCI Express differential transmit pair
32	SMB_DATA	SMBus data signal com- pliant to the SMBus 2.0 specification	31	PETn0	
30	SMB_CLK		29	GND	
28	+1.5V		27	GND	
26	GND		25	PERp0	PCI Express differential receive pair
24	+3.3Vaux		23	PERn0	
22	PERST#	Functional reset to the card	21	GND	
20	W_DISABLE#	Active low signal. This signal is used by the system to disable radio operation on add-in cards that implement radio frequency applica- tions. When imple- mented, this signal requires a pull-up resis- tor on the card.	19	Reserved	NC
18	GND		17	Reserved	NC
	Key	Key		Key	Key
16	NC	NC	15	GND	
14	NC	NC	13	REFCLK+	
12	NC	NC	11	REFCLK-	
10	NC	NC	9	GND	
8	NC	NC	7	CLKREQ#	Reference clock request sig- nal
6	1.5V		5	NC	NC
4	GND		3	NC	NC
2	+3.3Vaux/ +3.3V	PCI1.1 was +3.3V, PCI1.2 was +3.3Vaux	1	WAKE#	Open Drain active Low sig- nal. This signal is used to request that the system return from a sleep/sus- pended state to service a function initiated wake event.

- * Supports PCI1.1/ PCI1.2 Power Definition
- * +3.3Vaux was suspend power , power out to device +3.3V/1.1A
- * +3.3V was core power
- * +1.5V was core power , power out to device +1.5V/0.5A

A.2 4-pin USB Connector

- 1.25 mm 4-pin USB connector

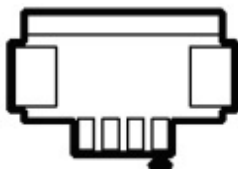

Pin	Signal	Description
1	USB VBUS	USB Power output ,USB2.0 5V/0.5A
2	USB_P-	USB2.0 date -
3	USB_P+	USB2.0 date +
4	GND	Ground for Power return

A.3 COM Port

- 9-Pin Com Port Connector

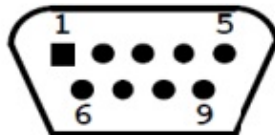

Pin	RS232	RS422	RS485	CAN
1	-	TX_Data-	Data-	-
2	RX	TX_Data+	Data+	Data-
3	TX	RX_Data+	-	GND
4	-	RX_Data-	-	-
5	GND	GND	GND	-
6	-	-	-	-
7	RTS	-	-	Data+
8	CTS	-	-	-
9	-	-	-	-

www.advantech.com

Please verify specifications before quoting. This guide is intended for reference purposes only.

All product specifications are subject to change without notice.

No part of this publication may be reproduced in any form or by any means, such as electronically, by photocopying, recording, or otherwise, without prior written permission from the publisher.

All brand and product names are trademarks or registered trademarks of their respective companies.

© Advantech Co., Ltd. 2023