

IPPC-9120/9150 Series

Rugged Pentium®III/Celeron™
Industrial panel PC with
12.1"/15" LCD display

User's Manual 
HMI Parts Center

Copyright notice

This document is copyrighted 2001, by Advantech Co. Ltd. All rights are reserved. Advantech Co., Ltd. reserves the right to alter the products described in this manual at any time without notice.

No part of this manual may be reproduced, copied, translated or transmitted in any form or by any means without the prior written permission of Advantech. Information provided in this manual is intended to be accurate and reliable. However, Advantech assumes no responsibility for use of this manual, nor for any infringements upon the rights of third parties which may result from such use.

All brand and product names mentioned herein are trademarks or registered trademarks of their respective holders.

Acknowledgments

ADAM is a trademark of Advantech Co., Ltd.

IBM and PC are trademarks of International Business Machines Corporation.

警告使用者

這是甲類的資訊產品，在居住的環境中使用時，可能會造成射頻干擾，在這種情況下，使用者會被要求採取某些適當的對策。

Part No. 2002000100

1st Edition Printed in Taiwan January 2001

FCC Class B

This equipment has been tested and found to comply with the limits for a Class B digital device, pursuant to Part 15 of the FCC Rules. These limits are designed to provide reasonable protection against harmful interference when the equipment is operated in a residential environment. This equipment generates, uses and can radiate radio frequency energy. If not installed and used in accordance with this user's manual, it may cause harmful interference to radio communications. Note that even when this equipment is installed and used in accordance with this user's manual, there is still no guarantee that interference will not occur. If this equipment is believed to be causing harmful interference to radio or television reception, this can be determined by turning the equipment on and off. If interference is occurring, the user is encouraged to try to correct the interference by one or more of the following measures:

- Reorient or relocate the receiving antenna
- Increase the separation between the equipment and the receiver
- Connect the equipment to a power outlet on a circuit different from that to which the receiver is connected
- Consult a dealer or an experienced radio/TV technician for help

Warning: Any changes or modifications made to the equipment which are not expressly approved by the relevant standards authority could void your authority to operate the equipment.

Packing List

Before setting up the system, check that the items listed below are included and in good condition. If any item does not accord with the table, please contact our dealer immediately.

The IPPC-9120/9150 Series industrial panel PCs include the following models:

1. **IPPC-9120T**
Rugged Pentium®III/Celeron™ industrial panel PC with 12.1" TFT LCD
2. **IPPC-9120T-T**
IPPC-9120T with resistive type touchscreen
3. **IPPC-9150T**
Rugged Pentium®III/Celeron™ industrial panel PC with 15" TFT LCD
4. **IPPC-9150T-T**
IPPC-9150T with resistive type touchscreen
5. **IPPC-9150T-N**
IPPC-9150T with NFI touchscreen

Packing List

Item	IPPC-9120T	IPPC-9150T
Description	Rugged Pentium® III/Celeron™ industrial panel PC with LCD display	
LCD type	12.1" TFT SVGA	15" TFT XGA
Display resolution	800 x 600	1024 x 768
Motherboard	PCM-9571B	
Floppy disk drive	3.5" slim type	
Power supply	80 W; 100 ~ 250 V _{AC}	
Items in accessory box	One utility CD-ROM	
	One CPU fan with heat sink	
	One Y-shaped adapter for PS/2 mouse and PS/2 keyboard	
Optional Devices		
Touchscreen	Resistive	Resistive or NFI
Slim type CD-ROM drive	24X slim type CD-ROM	
	One floppy disk with CD-ROM drive	

Additional Information and Assistance

1. Visit the Advantech websites at **www.advantech.com** or **www.advantech.com.tw**, where you can find the latest information about the product.
2. Contact your distributor, sales representative, or Advantech's customer service center for technical support if you need additional assistance. Please have the following information ready before you call:
 - Product name and serial number
 - Description of your peripheral attachments
 - Description of your software (operating system, version, application software, etc.)
 - A complete description of the problem
 - The exact wording of any error messages

Safety Instructions

1. Read these safety instructions carefully.
2. Keep this User's Manual for later reference.
3. Disconnect this equipment from any AC outlet before cleaning. Use a damp cloth. Do not use liquid or spray detergents for cleaning.
4. For plug-in equipment, the power outlet socket must be located near the equipment and must be easily accessible.
5. Keep this equipment away from humidity.
6. Put this equipment on a reliable surface during installation. Dropping it or letting it fall may cause damage.
7. The openings on the enclosure are for air convection. Protect the equipment from overheating. **DO NOT COVER THE OPENINGS.**
8. Make sure the voltage of the power source is correct before connecting the equipment to the power outlet.
9. Position the power cord so that people cannot step on it. Do not place anything over the power cord.
10. All cautions and warnings on the equipment should be noted.
11. If the equipment is not used for a long time, disconnect it from the power source to avoid damage by transient overvoltage.
12. Never pour any liquid into an opening. This may cause fire or electrical shock.
13. Never open the equipment. For safety reasons, the equipment should be opened only by qualified service personnel.
14. If one of the following situations arises, get the equipment checked by service personnel:
 - a. The power cord or plug is damaged.
 - b. Liquid has penetrated into the equipment.
 - c. The equipment has been exposed to moisture.
 - d. The equipment does not work well, or you cannot get it to work according to the user's manual.
 - e. The equipment has been dropped and damaged.
 - f. The equipment has obvious signs of breakage.
15. **DO NOT LEAVE THIS EQUIPMENT IN AN UNCONTROLLED ENVIRONMENT WHERE THE STORAGE TEMPERATURE IS BELOW -20° C (-4° F) OR ABOVE 60° C (140° F). THIS MAY DAMAGE THE EQUIPMENT.**

The sound pressure level at the operator's position according to IEC 704-1:1982 is no more than 70dB(A).

DISCLAIMER: This set of instructions is given according to IEC 704-1. Advantech disclaims all responsibility for the accuracy of any statements contained herein.

Wichtige Sicherheitshinweise

1. Bitte lesen sie Sich diese Hinweise sorgfältig durch.
2. Heben Sie diese Anleitung für den späteren Gebrauch auf.
3. Vor jedem Reinigen ist das Gerät vom Stromnetz zu trennen. Verwenden Sie Keine Flüssig-oder Aerosolreiniger. Am besten dient ein angefeuchtetes Tuch zur Reinigung.
4. Die NetzanschlusBsteckdose soll nahe dem Gerät angebracht und leicht zugänglich sein.
5. Das Gerät ist vor Feuchtigkeit zu schützen.
6. Bei der Aufstellung des Gerätes ist auf sicheren Stand zu achten. Ein Kippen oder Fallen könnte Verletzungen hervorrufen.
7. Die Belüftungsöffnungen dienen zur Luftzirkulation die das Gerät vor überhitzung schützt. Sorgen Sie dafür, daB diese Öffnungen nicht abgedeckt werden.
8. Beachten Sie beim. AnschluB an das Stromnetz die AnschluBwerte.
9. Verlegen Sie die NetzanschlusBleitung so, daB niemand darüber fallen kann. Es sollte auch nichts auf der Leitung abgestellt werden.
10. Alle Hinweise und Warnungen die sich am Geräten befinden sind zu beachten.
11. Wird das Gerät über einen längeren Zeitraum nicht benutzt, sollten Sie es vom Stromnetz trennen. Somit wird im Falle einer Überspannung eine Beschädigung vermieden.
12. Durch die Lüftungsöffnungen dürfen niemals Gegenstände oder Flüssigkeiten in das Gerät gelangen. Dies könnte einen Brand bzw. elektrischen Schlag auslösen.
13. Öffnen Sie niemals das Gerät. Das Gerät darf aus Gründen der elektrischen Sicherheit nur von autorisiertem Servicepersonal geöffnet werden.
14. Wenn folgende Situationen auftreten ist das Gerät vom Stromnetz zu trennen und von einer qualifizierten Servicestelle zu überprüfen:
 - a - Netzkabel oder Netzstecker sind beschädigt.
 - b - Flüssigkeit ist in das Gerät eingedrungen.
 - c - Das Gerät war Feuchtigkeit ausgesetzt.
 - d - Wenn das Gerät nicht der Bedienungsanleitung entsprechend funktioni ert oder Sie mit Hilfe dieser Anleitung keine Verbesserung erzielen.
 - e - Das Gerät ist gefallen und/oder das Gehäuse ist beschädigt.
 - f - Wenn das Gerät deutliche Anzeichen eines Defektes aufweist.
15. Bitte lassen Sie das Gerät nicht unbehehrt hinten unter -20° C (-4° F) oder oben 60° C (140° F), weil diesen Temperaturen das Gerät zerstören könnten.
Der arbeitsplatzbezogene Schalldruckpegel nach DIN 45 635 Teil 1000 beträgt 70dB(A) oder weiger.

DISCLAIMER: This set of instructions is given according to IEC704-1. Advantech disclaims all responsibility for the accuracy of any statements contained herein.

Contents

Chapter 1 General Information	1
1.1 Introduction	2
1.2 Specifications	3
General	3
Standard PC functions	3
PCI SVGA/flat panel interface	4
Audio function	4
PCI bus Ethernet interface.....	5
Analog Resistive Touchscreen (optional)	5
NFI Touchscreen (optional)	5
Optional modules	5
1.3 Dimensions	7
Chapter 2 System Setup	9
2.1 A Quick Tour of the IPPC-9120/9150 Series	10
2.1.1 PS/2 mouse and keyboard	12
2.1.2 Parallel port	12
2.1.3 Serial COM ports	13
2.1.4 VGA port	13
2.1.5 USB ports	14
2.1.6 Audio interface	14
2.1.7 Ethernet	14
2.1.8 Adjusting the LCD brightness	14
2.2 Installing SDRAM	15
2.3 Installing a CPU	16
2.4 Installing a 2.5" HDD	18
2.5 Installing a CD-ROM Drive	21
2.6 Installing Add-on Cards	23
2.7 Mounting Instructions	24
2.7.1 Panel mounting	24

2.7.2 Rack mounting	26
---------------------------	----

Chapter 3 Jumper Settings and Connectors 29

3.1 Jumpers and Connectors	30
3.1.1 Setting jumpers	30
3.1.2 Jumpers and switch	31
3.1.3 Locating jumpers and switch	32
3.1.4 Connectors	33
3.1.5 Locating connectors	34
3.2 CPU Installation	35
3.3 COM-port Interface	35
3.3.1 COM2 RS-232/422/485 setting (JP3, JP4, JP5)	35
3.3.2 COM1 / COM2 pin 9 output type setting (JP9)	36
3.3.3 COM3 / COM4 pin 9 output type setting (JP6)	37
3.4 CMOS Clear for External RTC (JP8)	37
3.5 Internal -12 V Source Enable Setting (JP1)	38
3.6 VGA Interface	38
3.6.1 LCD panel power setting	38
3.6.2 Panel type select (SW3)	38
3.7 Watchdog Timer Configuration	39
3.7.1 Watchdog activity selection (JP7)	39

Chapter 4 PCI Bus Ethernet Interface 41

4.1 Introduction	42
4.2 Installation of Ethernet Driver	42
4.2.1 Installation for Windows 95	43
4.2.2 Installation for Windows 98	46
4.2.3 Installation for Windows NT	49
4.3 Further Information	52

Chapter 5 PCI SVGA Setup 53

5.1 Introduction	54
5.1.1 Chipset	54
5.1.2 Display memory	54
5.1.3 Display types	54

5.2	Installation of SVGA Driver	54
5.2.1	Installation for Windows 95	56
5.2.2	Installation for Windows 98	59
5.2.3	Installation for Windows NT	62
5.3	Further Information	65
Chapter 6 Audio		67
6.1	Introduction	68
6.2	Installation of Audio Driver	68
6.2.1	Installation for Windows 95/98	69
6.2.2	Installation for Windows NT	71
Chapter 7 PCMCIA		75
7.1	Introduction	76
7.2	Installation of PCMCIA Driver	76
7.2.1	Installation for Windows 95	77
Chapter 8 Touchscreen		79
8.1	Introduction	80
8.1.1	General information	80
8.1.2	Analog Resistive Touchscreen Specifications	80
8.1.3	NFI Touchscreen Specifications	81
8.2	Installation of Resistive-type Touchscreen Driver	82
8.2.1	Installation for Windows 95/98	83
8.2.2	Installation for Windows NT	87
8.3	Installation of NFI touchscreen driver	90
8.3.1	Installation for Windows 95/98	90
8.3.2	Installation for Windows NT	96
Chapter 9 Award BIOS Setup		105
9.1	Award BIOS Setup	106
9.2	CMOS Setup Utility	106
9.3	Standard CMOS Setup	107
9.3.1	Hard disk configurations	108

9.4	BIOS Features Setup	109
9.5	Chipset Features Setup	113
9.6	Power Management Setup	115
9.7	PNP/PCI Configuration Setup	118
9.8	Load BIOS Defaults	119
9.9	Load Setup Defaults	120
9.10	Integrated Peripherals	120
9.11	Password Setting	122
9.12	IDE HDD Auto Detection.....	123
9.13	Save and Exit Setup	124
9.14	Exit Without Saving	124

Appendix A LCD Specifications and Selection Settings 125

Appendix B Programming the Watchdog Timer 127

B.1	Programming the Watchdog Timer	128
-----	--------------------------------------	-----

Appendix C Pin Assignments 131

C.1	AT Power Connector (J1)	132
C.2	TV Output Connector (J2) (*Reserved)	132
C.3	Inverter Power Connector (J4)	133
C.4	Internal Speaker Connector (J6) (*Reserved)	133
C.5	Front Panel Control Connector (J8) (*Reserved)	134
C.6	IR Connector (J9) (*Reserved)	134
C.7	Flat Panel Display Connector (CN2)	135
C.8	Flat Panel Display Connector (CN3)	136
C.9	PanelLink Interface (CN4) (*Reserved)	137
C.10	Floppy Drive Connector (CN10)	138
C.11	Internal COM4, mouse and touch screen power connector (CN23)	139
C.12	EIDE Hard Disk Drive Connector (CN16)	140
C.13	CD-ROM Connector (CN18)	141

C.14 CPU Fan Power Connector (FAN1)	142
C.15 System Fan Power Connector (FAN2)	142
C.16 PCI/ISA Bus Expansion Connector (SLOT1)	143
C.17 COM2	148

Figures

Figure 1-1: IPPC-9120 front view	7
Figure 1-2: IPPC-9150 front view	7
Figure 1-3: IPPC-9120/9150 Series dimensions	8
Figure 2-1: Side view	11
Figure 2-2: Rear view	11
Figure 2-3: Installing SDRAM	15
Figure 2-4: Installing a CPU	17
Figure 2-5: Removing the back case screws	19
Figure 2-6: Removing the HDD/FDD bracket screws	20
Figure 2-7: Assembling the HDD	21
Figure 2-8: Removing the back case screws	22
Figure 2-9: Attaching the connector to the CD-ROM	22
Figure 2-10: Installing an add-on card	23
Figure 2-11: Panel mounting	25
Figure 2-12: Mounting the IPPC-9120/9150 Series into a frame	26
Figure 2-13: Mounting the IPPC-9120/9150 Series and frame assembly into a rack	27
Figure 3-1: Locating jumpers on the IPPC-9120/9150 motherboard	32
Figure 3-2: Locating connectors on the IPPC-9120/9150 motherboard	34
Figure 9-1: Setup program initial screen	106
Figure 9-2: CMOS setup screen	107
Figure 9-3: BIOS features setup screen	109
Figure 9-4: Chipset features setup screen	113
Figure 9-5: Power management setup screen	115
Figure 9-6: PNP/PCI configuration setup screen	118
Figure 9-7: Load BIOS defaults screen	119
Figure 9-8: Integrated peripherals screen	120
Figure 9-9: IDE HDD auto detection screen	123
Figure 9-10: Save and exit setup screen	124

Tables

Table 3-1: Jumpers and their functions	31
Table 3-2: Panel PC connectors	33
Table 3-3: COM2 RS-232/422/485 setting (JP3, JP4)	35
Table 3-4: COM2 RS-232/422/485 setting (JP5)	35
Table 3-5: Serial port default settings	36
Table 3-6: COM1 / COM2 pin 9 output type setting (JP9)	36
Table 3-7: COM3/RI pin setting (JP6)	37
Table 3-8: Clear CMOS / External RTC (JP8)	37
Table 3-9: Internal -12 V source enable setting (JP1)	38
Table 1: Panel type select (SW3)	39
Table 3-11: Watchdog activity selection (JP7)	39
Table A-1: IPCC-9120/9150 Series LCD specifications	126
TableCD-1: AT power connector (J1)	132
Table C-2: TV output connector (J2)	132
Table C-3: Inverter power connector (J4)	133
Table C-4: Internal speaker connector (J6)	133
Table C-5: Front panel control connector (J8) (*Reserved)	134
Table C-6: IR connector (J9) (Reserved)	134
Table C-7: Flat panel display connector (CN2)	135
Table C-8: Flat panel display connector (CN3)	136
Table C-9: PanelLink Interface (CN4) (*Reserved)	137
Table C-10: Floppy drive connector (CN10)	138
Table C-11: Internal COM4, mouse and touch screen	
power connector (CN23)	139
Table C-12: EIDE hard disk drive connector (CN16)	140
Table C-13: CD-ROM connector (CN18)	141
Table C-14: CPU fan power connector (FAN1)	142
Table C-15: Fan power connector (FAN2)	142
Table C-16: PCI/ISA slot pin assignments (Pins A and B)	144
Table C-17: PCI/ISA slot pin assignments (Pins C and D)	145
Table C-18: PCI/ISA slot pin assignments (Pins E and F)	146
Table C-19: PCI/ISA slot pin assignments (Pins G and H)	147
Table C-20: COM2	148

CHAPTER
1

General Information

- Introduction
- Specifications
- Dimensions

1.1 Introduction

The IPPC-9120/9150 series industrial panel PC is specially designed to fit in space-limited environments where expansion is restricted. Its solid structure enables the system to operate under harsh industrial conditions.

Sturdy structure

The whole system is protected by a firm solid structure. The front panel is made of sturdy aluminum and has strengthened glass. It is shock resistant, and complies with NEMA4/IP65. The stainless steel case (SUS304) on the rear side is rugged and corrosion resistant, and enables the system to operate reliably in even the harshest of environments.

Easy maintenance

A back door with lock is located right above the motherboard. Thus users can easily maintain the CPU, HDD, SDRAM, FDD and CD-ROM drive. Jumpers can be easily set without removing a single screw. The lock protects the system from intruders.

Economical system

The PCM-9571B motherboard has Socket 370 architecture. It supports Pentium® III up to 850 MHz and Celeron™ up to 700MHz. Socket 370 is an economical yet powerful system. Its reliability enables the system to operate faultlessly in industrial environments.

Friendly HMI

The IPPC-9120/9150 Series is equipped with a 12.1"/15" LCD, which provides high resolution display quality (IPPC-9120: 800 x 600; IPPC-9150: 1024 x 768). The result is vivid, bright, and sharp quality images. The IPPC-9120/9150 Series is perfectly suited for "Windows" OSs. The touchscreen version enables simple operation, making the IPPC-9120/9150 Series the premier industrial digital controller interface.

1.2 Specifications

General

- **Dimensions (W x H x D):**
405 x 302 x 127 mm (15.94" x 11.88" x 5")
- **Weight:** 10 kg (22 lb)
- **Power supply:** 80 watts
Input voltage: 115 V_{AC} / 3 A ~ 230 V_{AC} / 1.5 A @ 47 ~ 63 Hz
Output voltage: +5 V @ 12 A, +12 V @ 1 A
- **Cooling fan dimensions (W x H x D):**
60 x 60 x 10 mm (2.36" x 2.36" x 0.39")
- **Disk drive housing:** Supports one 2.5" HDD, one slim size CD-ROM drive, and one slim type FDD
- **Chassis:** Aluminum front frame complies with NEMA4/IP65. SUS304 stainless steel back case

Standard PC functions

- **CPU:** Socket 370 Pentium® III up to 850 MHz;
Celeron™ up to 700 MHz
- **BIOS:** Award 256 KB Flash BIOS
- **Chipset:** 82443BX/82371EB
- **2nd level cache:** 256 KB CPU full-speed cache
- **RAM:**
One 168-pin DIMM socket accepts 32 ~ 256 MB SDRAM (3.3 V)
- **PCI bus master IDE interface:** Supports two connectors. Each connector has one channel and supports two IDE devices. Each channel supports PIO modes 0 ~ 4, DMA modes 0 ~ 2, and Ultra DMA 33 simultaneously. The secondary connector is designated for the CD-ROM drive. BIOS supports IDE CD-ROM boot-up.
- **Parallel port:** One parallel port, supports SPP/EPP/ECP parallel mode. BIOS configurable to LPT1, LPT2, LPT3 or disabled

- **Serial ports:** Four serial ports with three RS-232 ports (COM1, COM3, and *COM4) and one RS-232/422/485 port (COM2). All ports are compatible with 16C550 UARTs
- **Universal serial bus (USB) port:** Supports up to two USB ports
- **PCI/ISA bus expansion slot:**
Accepts either two PCI cards or one ISA/one PCI bus card
- **Watchdog timer:** 63-level, interval 1 ~ 63 seconds.
Automatically generates system reset or IRQ11 when the system stops due to a program error or EMI. Jumperless selection and software enabled/disabled
- **Battery:** 3.0 V @ 195 mA lithium battery

PCI SVGA/flat panel interface

- **Chipset:** Silicon Motion® Lynx3DM8
- **Display memory:** 8 MB on-die memory
- **Display type:** Simultaneously supports CRT and flat panel displays (TFT and DSTN)
- **Display resolution:** Supports non-interlaced CRT and LCD displays up to 1600x 1200

Audio function

- **Chipset:** ESS 1946S
- **Audio controller:**
16-bit codec, full-duplex stereo single-chip audio solution
- **Stereo sound:** 100% DOS game compatible (Sound Blaster or Sound Blaster Pro)
- **Audio interface:** Microphone-in, line-in, line-out, and game ports

* **Warning:** *COM port 4 on the IPPC-9120T-T, IPPC-9150T-T and IPPC-9150T-N models is reserved for a touchscreen only. Improper use of this COM port will cause system failure.*



PCI bus Ethernet interface

- **Chipset:** Realtek RTL 8139 PCI local bus Ethernet controller
- **Ethernet interface:** Fully complies with IEEE 802.3u 100Base-T and 10 Base-T specifications. Includes software drivers and boot ROM
- **100/10Base-T auto-sensing capability**

Analog Resistive Touchscreen (optional)

- **Type:** Analog resistive
- **Resolution:** Continuous
- **Light transmission:**
72% (surface meets ASTM-D-3363-92A standard, Taber abrasion test)
- **Controller:** RS-232 interface (uses COM4)
- **Power consumption:** +5 V @ 200 mA
- **Software driver:** Supports DOS, Windows 3.1, Windows 95/98/2000/ME and Windows NT 4.0

NFI Touchscreen (optional)

- **Resolution:** 1024 per axis
- **Light transmission:** >82%
- **Controller:** RS-232 interface (uses COM4)
- **Power consumption:** +5 V @ 150 mA
- **Software driver:** Supports DOS, Windows 3.1, Windows 95/98, Windows NT 4.0

Optional modules

- **IPPC-9150 Stand:** stand kit for IPPC-9150/9120 series products
- **IPPC-9150 S-ARM:** swing arm for IPPC-9150/9120 series
- **IPPC-9150 Rack-MT:** 19" rack mount kit for IPPC-9150/9120 series
- **CDR-9150-24X:** 24x CD-ROM kit for IPPC-9150/9120 series

Environmental

- **Operating temperature:** 0° ~ 50° C (32° ~ 122° F)
- **Storage temperature:** -20° ~ 60° C (-4° ~ 140° F)
- **Relative humidity:** 10 ~ 90% @ 40° C (non-condensing)
- **Shock:** 30 G peak acceleration (11 ms duration)
- **Power MTBF:** 100,000 hrs
- **Certification:** CE, FCC Class A; meets UL, BSMI

1.3 Dimensions

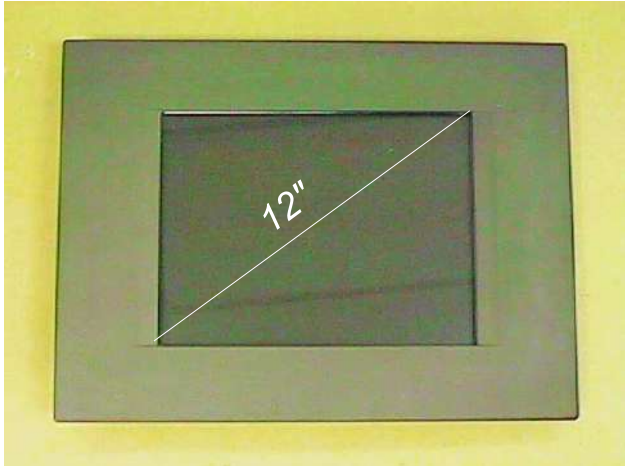

Figure 1-1: IPPC-9120 front view



Figure 1-2: IPPC-9150 front view

Dimension:

Unit:mm.

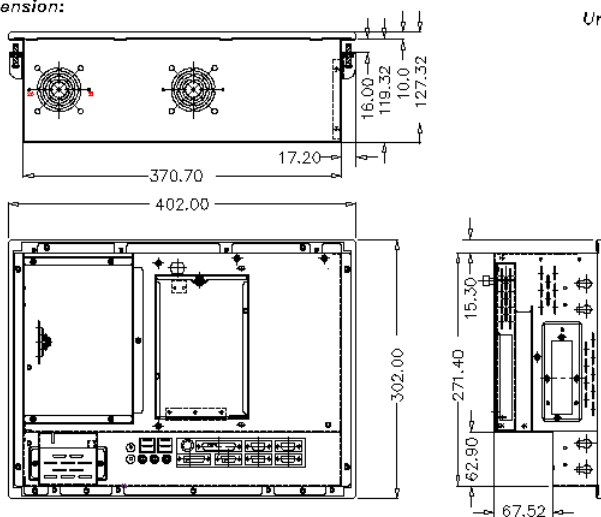

Cutout Dimensions: 374.0 mm * 275.0 mm

Figure 1-3: IPPC-9120/9150 Series dimensions

CHAPTER
2

System Setup

- General
- Installing SDRAM
- Installing a CPU
- Installing a 2.5" HDD
- Installing a CD-ROM Drive
- Installing Add-on Cards
- Mounting Instructions

2.1 A Quick Tour of the IPPC-9120/9150 Series

Before you start the computer, please follow these procedures to set up the system.

1. Check and adjusting jumpers on the motherboard (refer to Chapter 3)
2. Installing SDRAM
3. Installing a CPU
4. Installing add-on cards
5. Connect the wires, cables and accessories
6. Mounting the computer
7. Programming BIOS settings
8. Installing an operating system

Warnings: 1. Every time you access the interior of the computer, please switch it off and unplug it.

2. The motherboard inside the system is composed of many delicate ICs, chips and other integrated circuit components. These components are easily damaged by static shock. When you begin to install components, please:

Avoid touching metal parts of the motherboard.

Wear an anti-static ring when handling a CPU or SDRAM module.

Put SDRAM modules and the CPU inside an anti-static bag or similar place before installation.

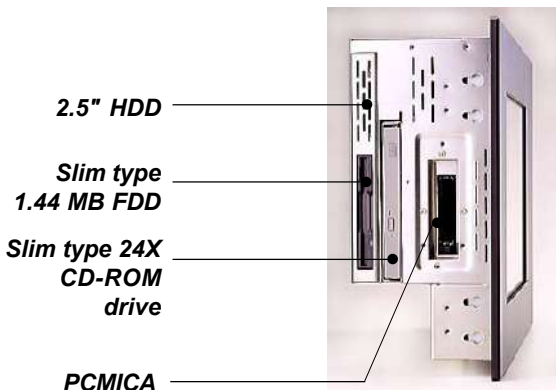

Figure 2-1: Side view

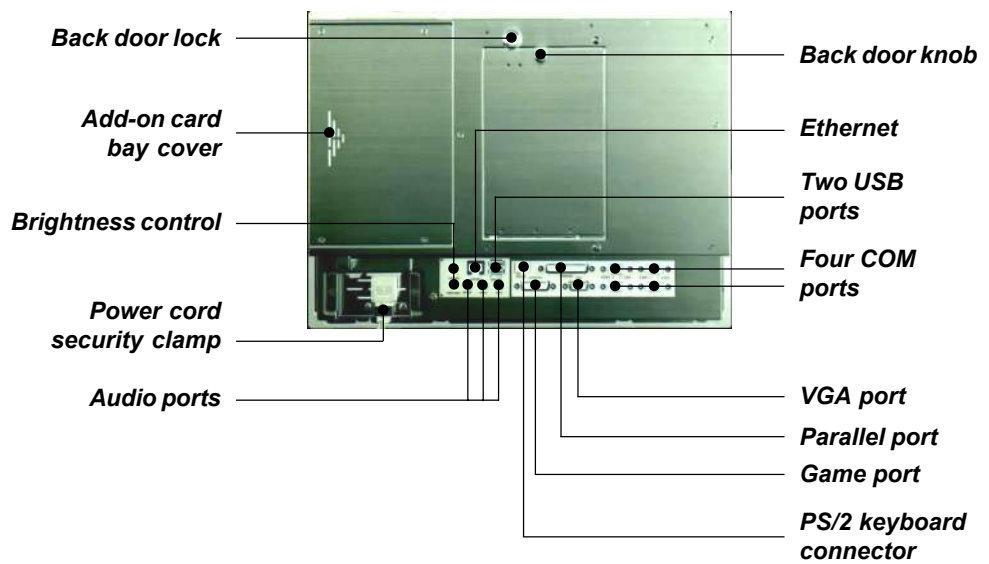

Figure 2-2: Rear view

2.1.1 PS/2 mouse and keyboard

If you wish to use a full-size desktop keyboard and PS/2 mouse with your panel PC, follow these instructions:

1. Be sure the panel PC is turned off.
2. Connect the Y-shaped adapter to the PS/2 mouse and keyboard port on the rear bottom side of the rear cover.
3. Attach the keyboard to the 5-pin port of the Y-shaped adapter.
4. Attach the PS/2 mouse to the 6-pin female PS/2 port of the Y-shaped adapter.
5. Turn on the panel PC.

2.1.2 Parallel port

The panel PC supports the latest EPP and ECP parallel port protocols for improved performance and versatility with compatible printers or other devices.

To connect the panel PC to a printer or other devices:

1. Make sure both the panel PC and the printer/devices are turned off.
2. Connect the 25-pin male connector of the printer cable to the 25-pin female port on the panel PC labelled "parallel port."
3. If necessary, attach the other end of your printer cable to your printer, and fasten any retaining screws.
4. Turn on the printer and any other peripheral devices you may have connected to the panel PC. Then turn on the panel PC.
5. If necessary, run the panel PC's BIOS setup program to configure the parallel port to respond as required by your printer and software operating environment.

2.1.3 Serial COM ports

There are four serial COM ports on the bottom of the rear cover. You can easily attach a serial device to the panel PC, such as an external modem or mouse. Follow these instructions:

1. Make sure the panel PC and any other peripheral devices you may have connected to the panel PC are turned off.
2. Attach the interface cable of the serial device to the panel PC's serial port. (See Fig. 2-2.) If necessary, attach the other end of the interface cable to your serial device. Fasten any retaining screws.
3. Turn on any other peripheral devices you may have connected to the panel PC, and then turn on the panel PC.
4. Refer to the manual(s) which accompanied your serial device(s) for instructions on configuring your operating environment to recognize the device(s).
5. Run the BIOS setup program to set the I/O address and IRQ, and configure the jumper settings to change the mode of the COM ports (refer to section 3.3).

2.1.4 VGA port

An external VGA-compatible device may be connected to the system via the 15-pin external port located on the rear of the system unit. The panel PC simultaneously supports an external CRT monitor in addition to its own LCD display.

1. Make sure the panel PC is turned off.
2. Connect the external monitor to the system.
3. Turn on the panel PC and the external monitor.

2.1.5 USB ports

An external USB device may be connected to the system via the 4-pin USB ports located on the rear side of the system unit.

1. Connect the external device to the system.
2. The USB ports support hot plug-in connection. You should install the device driver before you use the device.

2.1.6 Audio interface

The audio interface includes three jacks: microphone-in, line-out and line-in. Their functions are:

Microphone-in: Use an external microphone to record voice and sound.

Line-out: Output audio to external devices such as speakers or earphones. The built-in speaker will not be disabled when the line-out jack is connected to external audio devices.

Line-in: Input audio from an external CD player or radio.

1. Connect the audio device to the system.
2. Install the driver before you use the device.

2.1.7 Ethernet

To install the Ethernet to your system:

1. Make sure the panel PC is turned off.
2. Connect the Ethernet cable.
3. Turn on the panel PC.
4. Under DOS, run `D:\IPPC9150&9120\LAN\RSET8139.EXE` to check hardware network status before installing the Ethernet driver.
5. Run the Ethernet driver to connect up to the network.

2.1.8 Adjusting the LCD brightness

The brightness control knob allows you to adjust the brightness of the LCD display panel.

2.2 Installing SDRAM

You can install from 32 to 256 MB of SDRAM memory. The panel PC system provides one 168-pin DIMM (Double Inline Memory Module) socket, and supports 3.3 V SDRAM with a minimum speed of 12 ns.

1. Unlock the back door and open it.
2. Push the two white eject levers on each side of the DIMM outward until they are separated from the black vertical posts.
3. Insert the memory module into the socket at an angle of 90 degrees.
4. Push the two eject levers toward the vertical posts at each end of the socket until the module is upright.

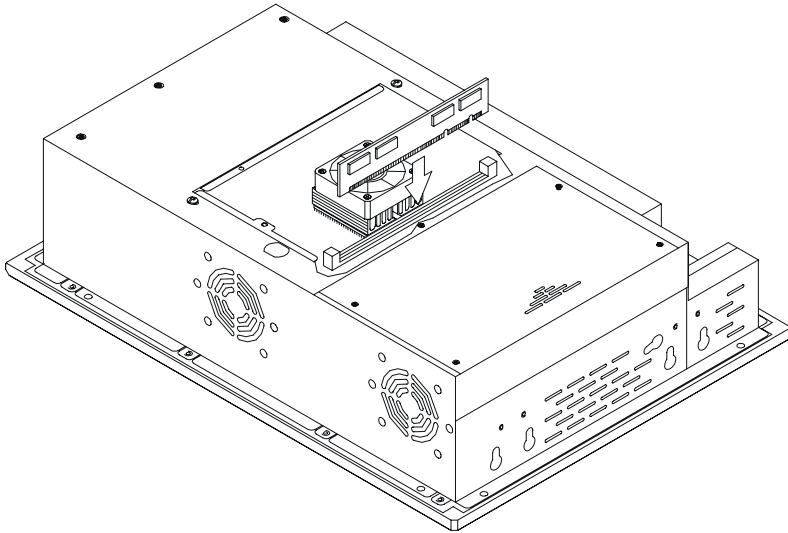

Figure 2-3: Installing SDRAM

2.3 Installing a CPU

The CPU can be upgraded to improve system performance. The system provides Socket 370 architecture which supports Pentium® III CPU up to 850 MHz, Celeron™ up to 700 MHz.

Warning: Always disconnect the power cord from your panel PC when you are working on it. Do not make connections while the power is on, because sensitive electronic components can be damaged by the sudden rush of power. Only experienced electronics personnel should open the panel PC.

1. Unlock the back door and open it.
2. The CPU board will auto-detect CPU's voltage and frequency; there are no jumper settings.
3. Open the CPU socket by pulling up the lever sideways from the socket, then upwards at an angle of 90 degrees.
4. Insert the CPU with the correct orientation. The notched corner of the CPU (with the white dot) should point toward the end of the lever. The end of the lever is the blank area where one hole is missing from the corner of the square array of pin holes. An arrowhead printed on the motherboard points to the end of the lever.
5. Slide the CPU in gently. It should insert easily. If not, pull the lever up a little more and make sure the pins of the CPU correspond with the holes of the socket. **DO NOT USE EXCESSIVE FORCE!**
6. Press the lever down. The plate will slide forward.
7. Place the heat sink on top of the CPU, and secure it with the heat sink clip.
8. Connect the CPU's cooling fan power connector.

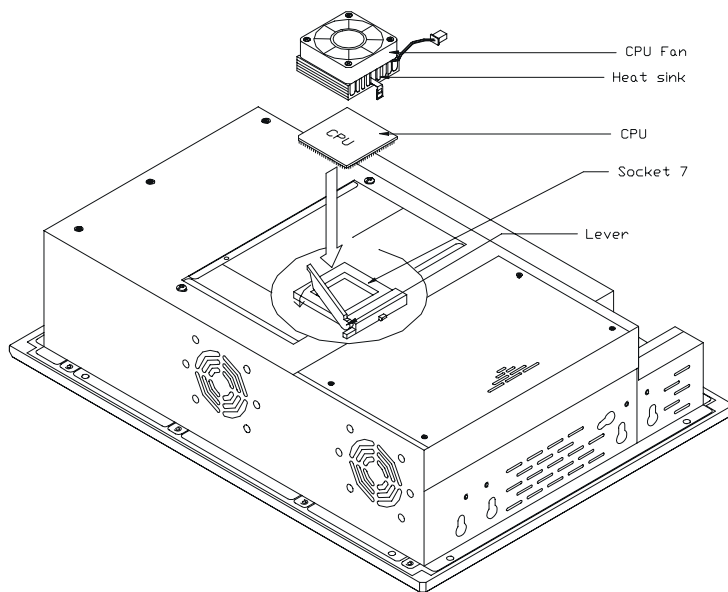

Figure 2-4: Installing a CPU

2.4 Installing a 2.5" HDD

The system supports one 2.5" slim type IDE HDD. The IDE controller, which uses a PCI local bus interface, allows the HDD to exceed 528 MB.

When installing an HDD, follow these steps:

1. Unlock the back door and open it.
2. Unscrew the bolt in the center of the HDD-FDD bracket.
3. Detach the FDD flat cable.
4. Remove the five screws on the back case (see Fig. 2-5).
5. Take out the HDD-FDD bracket.
6. Remove the four screws in the bottom of the HDD-FDD bracket (see Fig. 2-6).
7. There are two HDD support assemblies. Unscrew the two screws on the side of each HDD support assembly.
8. Mount the HDD support assemblies, one on each side of the HDD.
9. Fasten the four screws in the bottom of the HDD-FDD bracket (see Fig. 2-6).
10. Put in the HDD-FDD bracket.
11. Fasten the five screws on the back case (see Fig. 2-5).
12. Attach the FDD flat cable.
13. Fasten the bolt in the center of the HDD-FDD bracket.
14. Close the back door and lock it.

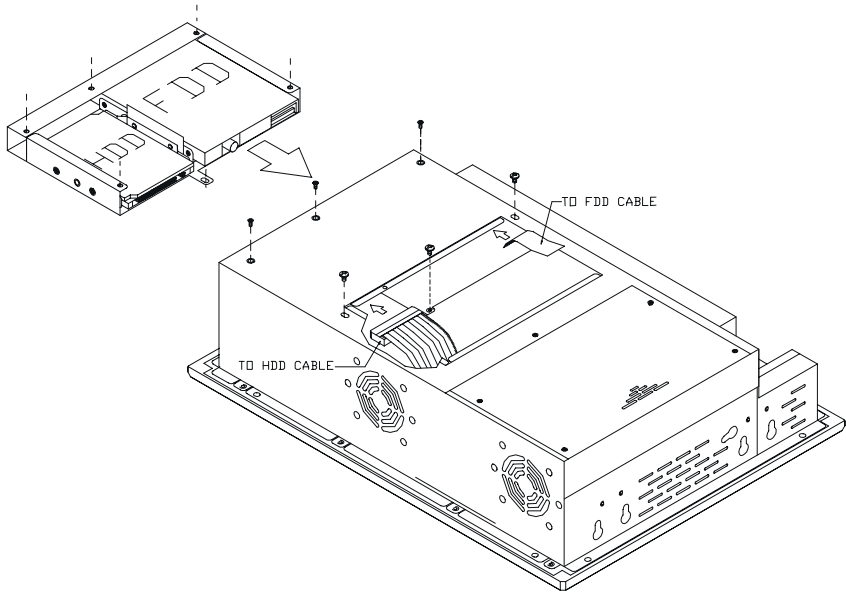

Figure 2-5: Removing the back case screws

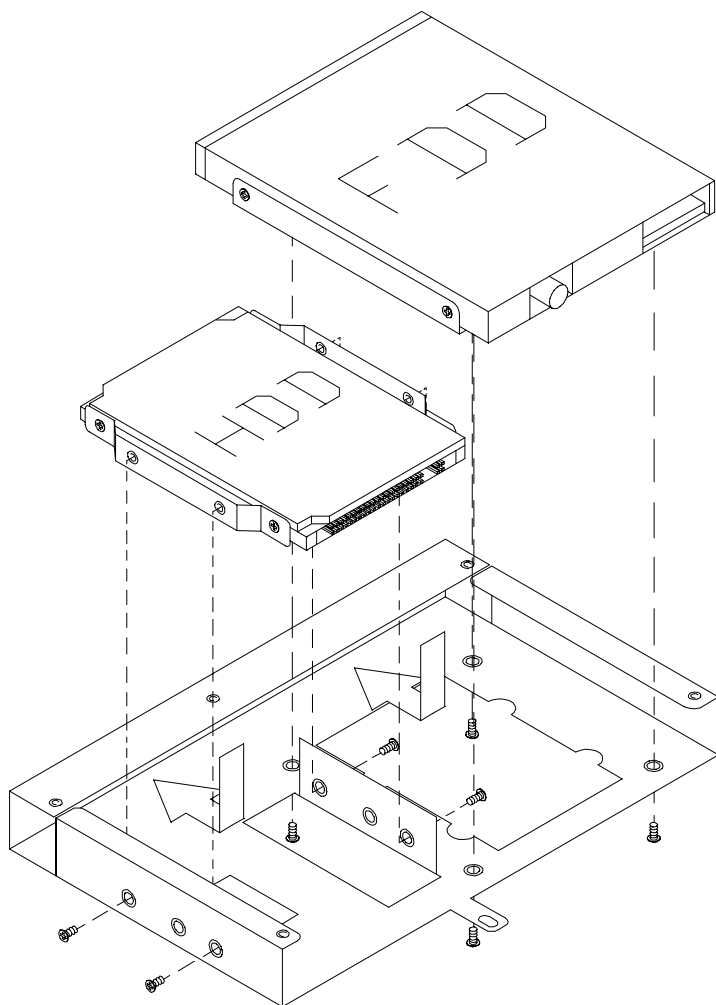

Figure 2-6: Removing the HDD/FDD bracket screws

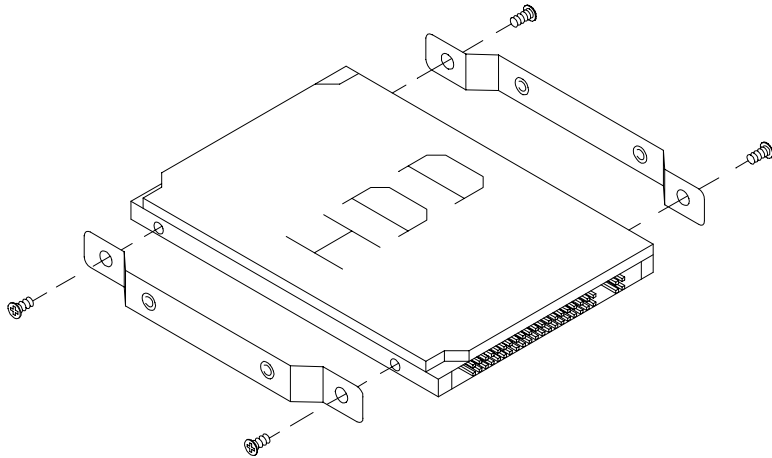

Figure 2-7: Assembling the HDD

2.5 Installing a CD-ROM Drive

One slim type CD-ROM drive can be installed in the system. Before installing the CD-ROM drive, take out the FDD-HDD bay. (Refer to Section 2.4)

1. Remove the three screws on the bottom of back case (see Fig. 2-8).
2. Pull out the drive bay cage, and attach the CD-ROM drive's cable to connector CN18 on the motherboard.
3. Install "CDR-9150-24X" into the drive bay by inserting it directly into the end. Then attach the cable to the CD-ROM drive.
4. The securing ("fix") clip is located on back of the CDR-9150-24X. Move the short arm of the clip so that the lug at its end engages into the hole in the long arm of the clip. Then press the connector tightly onto the CD-ROM. (See Fig. 2-9.)

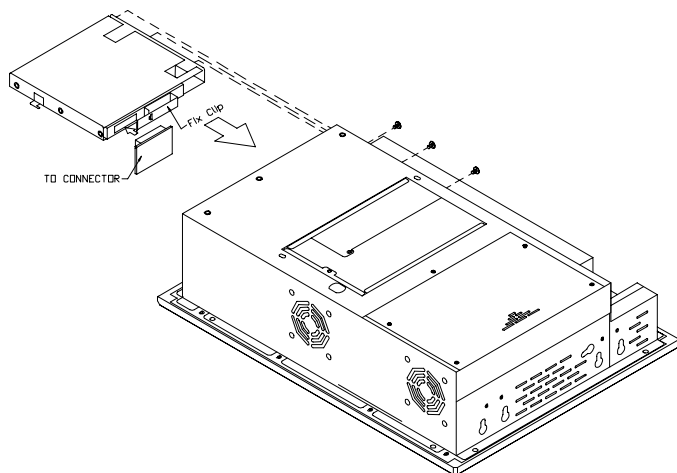

Figure 2-8: Removing the back case screws

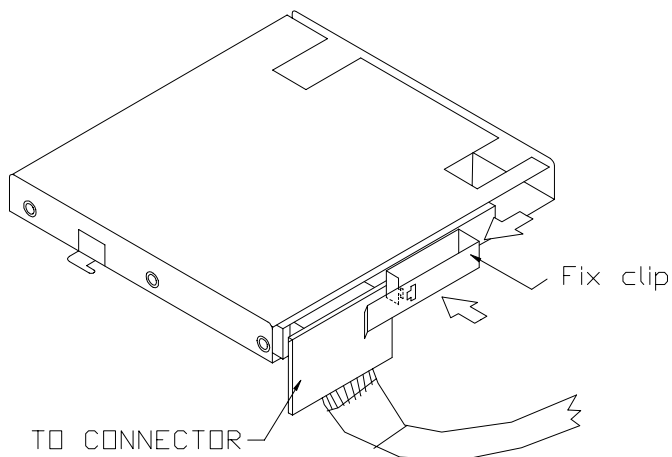

Figure 2-9: Attaching the connector to the CD-ROM

2.6 Installing Add-on Cards

This system supports two PCI cards or one PCI and one ISA expansion card.

1. Detach the five screws on the back to open the lid.
2. Take away the adapter bracket by detaching the screw which is mounted in the little box (see Fig. 2-10).
3. Insert the add-on card, and put on the lid.

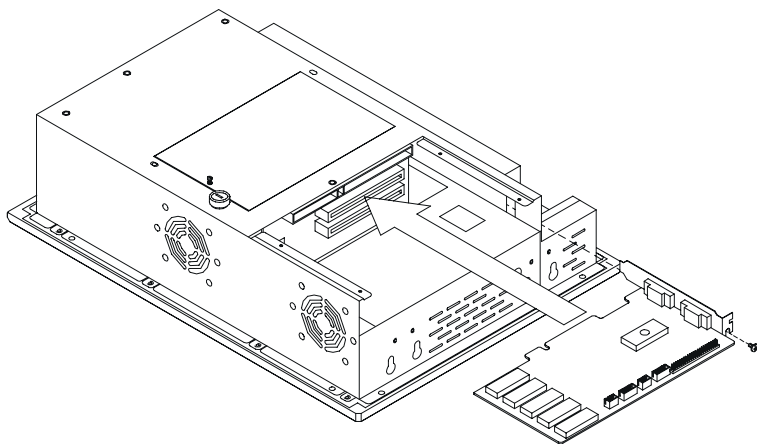

Figure 2-10: Installing an add-on card

2.7 Mounting Instructions

There are two ways to mount the system: panel mounting or rack mounting.

2.7.1 Panel mounting

1. Take the four mounting brackets out of the accessory box.
2. Attach the four mounting brackets by inserting the screws into the keyhole slots on the cover of the monitor.
3. Use the screws to secure the brackets to the cover. Tighten the screws to secure the monitor to the back panel.

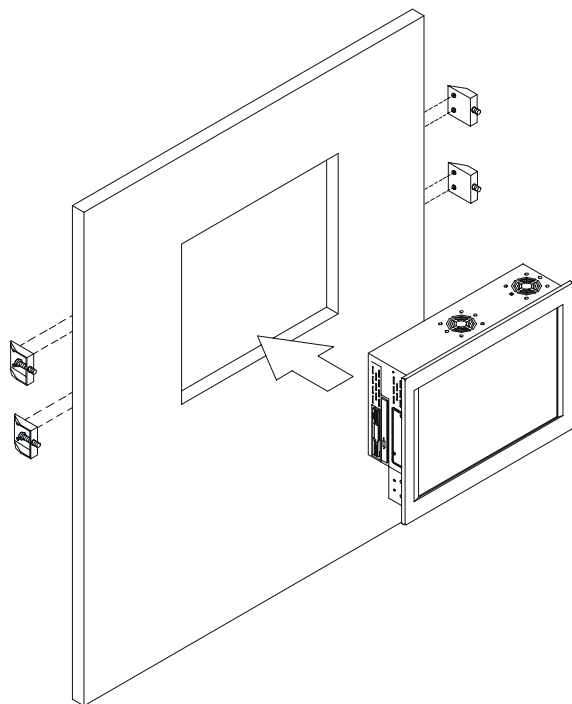

Figure 2-11: Panel mounting

2.7.2 Rack mounting

The monitor can be mounted to a 19" industrial rack. Please order the optional bracket "IPPC-9150 Rack-MT".

Mount the monitor to the bracket by following the instructions in Section 2.7.1 on the previous page. Then attach the bracket with the monitor to the 19" industrial rack. (See Fig. 2-12.)

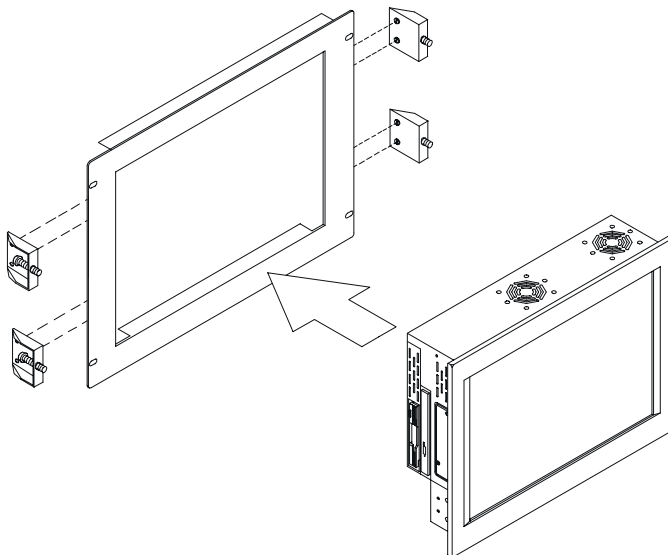
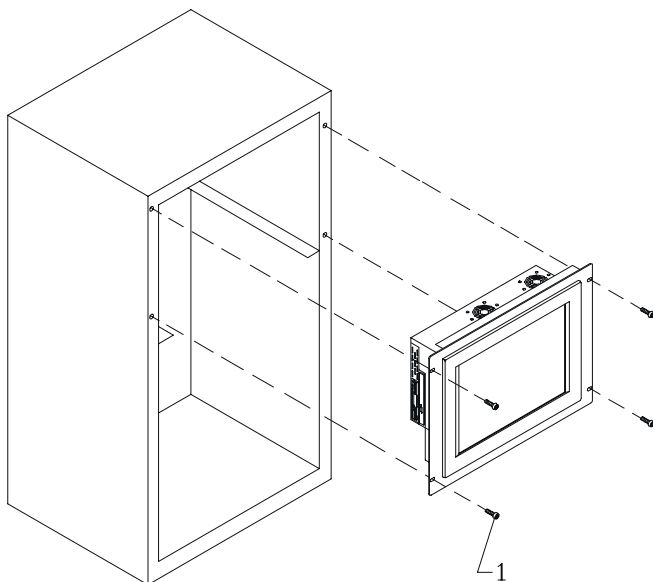

Figure 2-12: Mounting the IPPC-9120/9150 Series into a frame



Item	Part Name	Quantity
1	Screw M5x10	4

Figure 2-13: Mounting the IPPC-9120/9150 Series and frame assembly into a rack

CHAPTER 3

Jumper Settings and Connectors

This chapter tells how to set up the panel PC hardware, including instructions on setting jumpers and connecting peripherals, switches and indicators. Be sure to read all the safety precautions before you begin the installation procedures.

- Jumpers and Connectors
- CPU Installation
- CMOS Clear for External RTC (JP8)
- COM-port Interface
- Internal -12 V Source Selection Setting (JP1)
- VGA Interface
- Watchdog Timer Configuration

3.1 Jumpers and Connectors

3.1.1 Setting jumpers

You can configure your panel PC to match the needs of your application by setting jumpers. A jumper is the simplest kind of electrical switch. It consists of two metal pins and a small metal clip (often protected by a plastic cover) that slides over the pins to connect them. To “close” a jumper, you connect the pins with the clip. To “open” a jumper you remove the clip. Sometimes a jumper will have three pins, labeled 1, 2, and 3. In this case, you would connect either pins 1 and 2 or pins 2 and 3.

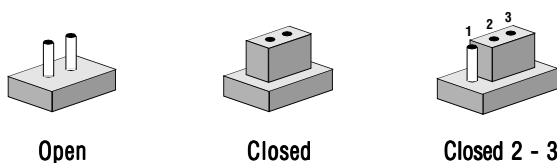

The jumper settings are schematically depicted in this manual as follows:

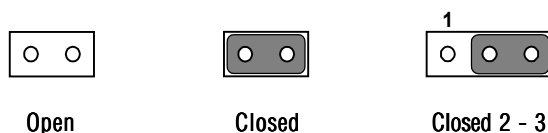

A pair of needle-nose pliers may be helpful when working with jumpers.

If you have any doubts about the best hardware configuration for your application, contact your local distributor or sales representative before you make any changes.

3.1.2 Jumpers and switch

The motherboard of the IPPC-9120/9150 has a number of jumpers that allow you to configure your system to suit your applications. The table below lists the function of each of the board's jumpers.

Table 3-1: Jumpers and their functions

Label	Function
JP1	Internal -12 V source selection setting
JP2	Wake on LAN (not used for IPPC-9120/9150)
JP3	COM2 RS-232/422/485 setting
JP4	COM2 RS-232/422/485 setting
JP5	COM2 RS-232/422/485 setting
JP6	COM3 / COM4 Pin 9 output type setting
JP7	Watchdog timer action
JP8	CMOS clear for external RTC
JP9	COM1 / COM2 Pin 9 output type setting
SW3	Panel type setting

3.1.3 Locating jumpers and switch

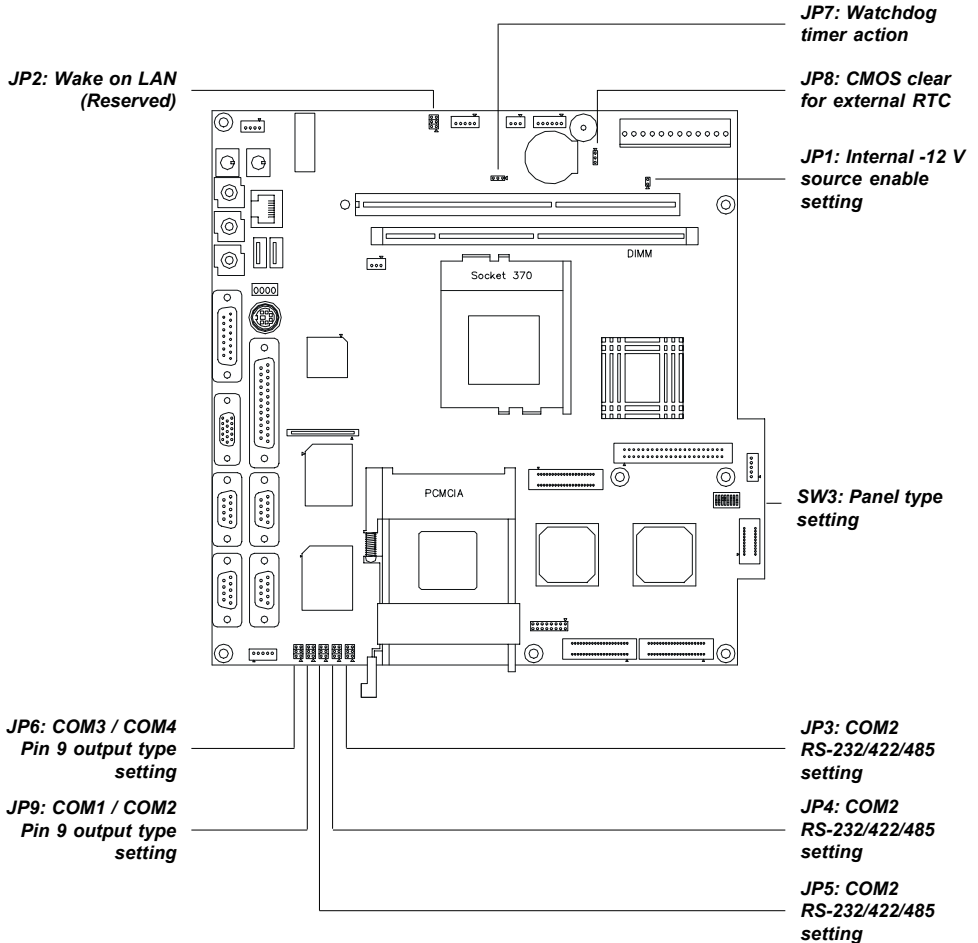

Figure 3-1: Locating jumpers on the IPPC-9120/9150 motherboard

3.1.4 Connectors

Onboard connectors link the panel PC to external devices such as hard disk drives or floppy drives. The table below lists the function of each of the board's connectors.

Table 3-2: Panel PC connectors

Label	Function
J1	AT power connector
J4	Inverter power connector
J6	Internal speaker connector (Reserved)
J8	Front panel control connector (Reserved)
J9	IR connector (Reserved)
CN2	Flat panel display connector
CN3	Flat panel display connector
CN4	PanelLink interface (Reserved)
CN10	FDD connector
CN23	Internal COM4, mouse and touchscreen power connector
CN16	EIDE hard disk drive connector
CN18	CD-ROM connector
FAN1	CPU fan power connector
FAN2	System fan power connector
SLOT1	PCI/ISA bus expansion connector

3.1.5 Locating connectors

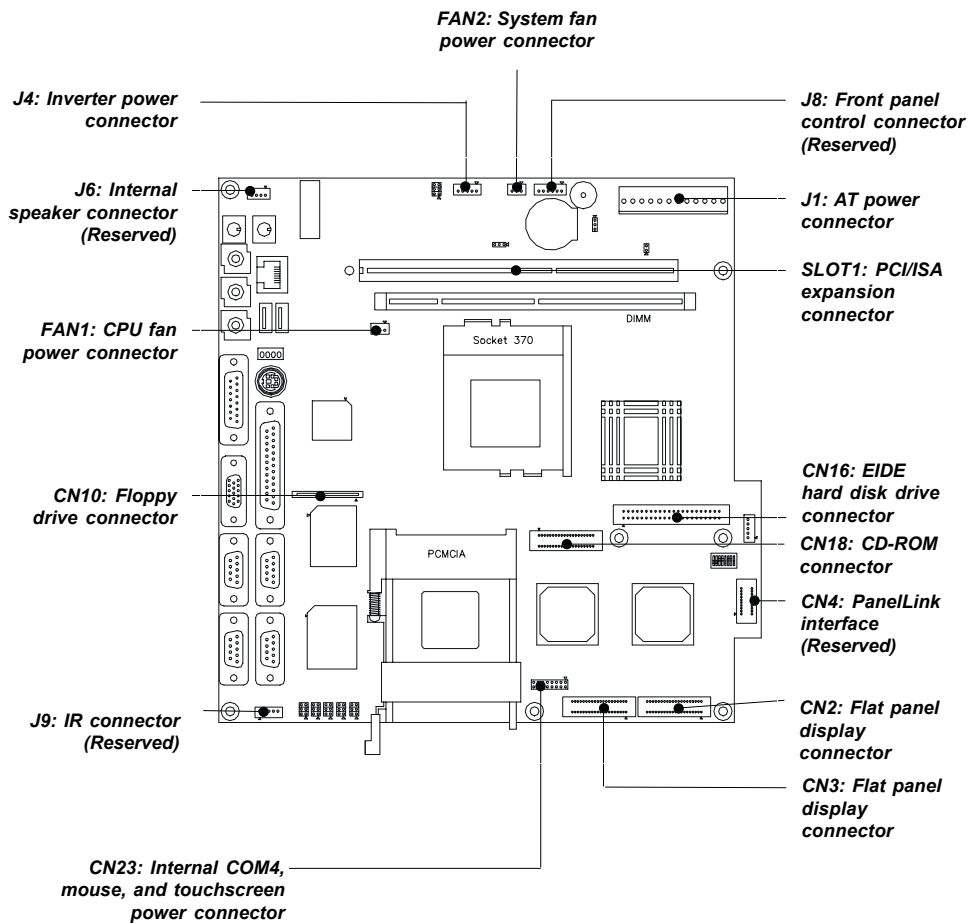

Figure 3-2: Locating connectors on the IPPC-9120/9150 motherboard

3.2 CPU Installation

You can install a Pentium® III CPU up to 850 MHz or Celeron™ CPU up to 700 without setting any frequency ratio or voltage.

3.3 COM-port Interface

The IPPC-9120/9150 provides four serial ports (COM1, 3, 4: RS-232; COM2: RS-232/422/485) in one COM port connector.

3.3.1 COM2 RS-232/422/485 setting (JP3, JP4, JP5)

COM2 can be configured to operate in RS-232, RS-422, or RS-485 mode. This is done via JP3, JP4 and JP5.

Table 3-3: COM2 RS-232/422/485 setting (JP3, JP4)

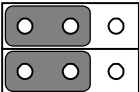
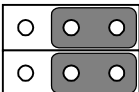
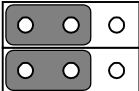
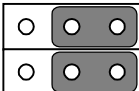
	*RS-232		RS-422/485
JP4			
JP3			

* default setting

Table 3-4: COM2 RS-232/422/485 setting (JP5)

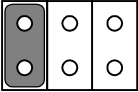
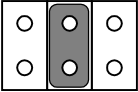
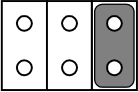
*RS-232	RS-422	RS-485
		

* default setting

The IRQ and the address ranges for COM1, 2, 3, and 4 are fixed.

However, if you wish to disable the port or change these parameters later you can do this in the system BIOS setup. The table overleaf shows the default settings for the panel PC's serial ports.

COM1 and COM2 are one set. You can exchange the address range and interrupt IRQ of COM1 for the address range and interrupt IRQ of COM2. After exchanging, COM1's address range is 2F8 ~ 2FF and its request IRQ is IRQ3; and COM2's address range is 3F8 ~ 3FF and its interrupt IRQ is IRQ4.

COM3 and COM4 are another set. Their selectable function is the same as the COM1/COM2 set.

Port	Address Range	Interrupt
COM1	3F8 ~ 3FF	IRQ4
COM2	2F8 ~ 2FF	IRQ3
COM3	3E8 ~ 3EF	IRQ10
COM4	2E8 ~ 2EF	IRQ5

3.3.2 COM1 / COM2 pin 9 output type setting (JP9)

Table 3-6: COM1 / COM2 pin 9 output type setting (JP9)

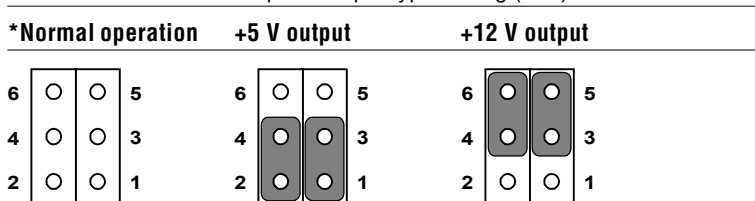

* default setting

Note: Pins 1, 3 and 5 are for COM1.
Pins 2, 4 and 6 are for COM2.

3.3.3 COM3 / COM4 pin 9 output type setting (JP6)

Table 3-7: COM3/RI pin setting (JP6)

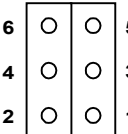
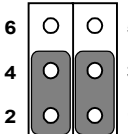
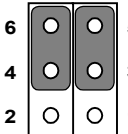
*Normal operation	+5 V output	+12 V output
		



* default setting

Note: Pins 1, 3 and 5 are for COM3.
Pins 2, 4 and 6 are for COM4.

3.4 CMOS Clear for External RTC (JP8)

Warning: To avoid damaging the computer, always turn off the power supply before setting “Clear CMOS”. Set the jumper back to “Normal operation” before turning on the power supply.

Table 3-8: Clear CMOS / External RTC (JP8)

*Normal operation	Clear CMOS
	

* default setting

3.5 Internal -12 V Source Enable Setting (JP1)

The panel PC provides an internal -12 V source to the expansion slots.

Table 3-9: Internal -12 V source enable setting (JP1)

* Enable -12 V support	Disable -12 V support
------------------------	-----------------------



* default setting

3.6 VGA Interface

The Panel PC's AGP VGA interface can drive conventional CRT displays. It is also capable of driving TFT and DSTN LCD displays. The board has two connectors to support these displays simultaneously: one for standard CRT VGA monitors, and one for flat panel displays.

CRT display port information can be found in Section 2.1.4.

Pin assignments for the flat panel display connector, backlight connector and other related connectors are shown in Appendix C.

3.6.1 LCD panel power setting

The panel PC's AGP SVGA interface supports 5 V and 3.3 V LCD displays. The LCD cable already has a built-in default setting. You do not need to adjust any jumper or switch to select the panel power.

3.6.2 Panel type select (SW3)

SW3 is an 8-pin dip switch for selecting panel type and display mode. The 800 x 600 and 1024 x 768 TFT LCDs are used in the IPPC-9120 and IPPC-9150 respectively, so the switch is preset according to the table below. The switch is already defaulted for the IPPC-9120 and IPPC-9150's LCDs, so it should not be modified. If you require modifi-

cation for a special purpose, we recommend that you consult your distributor or our sales representative for detailed information.

Table 3-10: Panel type select (SW3)

Panel type	Pin1	Pin2	Pin3	Pin4	Pin5	Pin6	Pin7	Pin8
800 x 600	ON	ON	OFF	ON	ON	OFF	ON	ON
1024 x 768 (36-bit)	ON	ON	ON	OFF	ON	OFF	OFF	ON
1024 x 768 (48-bit)	ON	ON	ON	OFF	OFF	OFF	OFF	ON

3.7 Watchdog Timer Configuration

An onboard watchdog timer reduces the chance of disruptions which EMP (electromagnetic pulse) interference can cause. This is an invaluable protective device for standalone or unmanned applications. Setup involves one jumper and running the control software. (Refer to Appendix B.)

3.7.1 Watchdog activity selection (JP7)

When the watchdog timer activates (i.e. CPU processing has come to a halt), it can reset the system or generate an interrupt on IRQ11. This can be set via jumper JP7 as shown below:

Table 3-11: Watchdog activity selection (JP7)

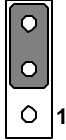
*System reset	IRQ11
	

* default setting

CHAPTER
4

PCI Bus Ethernet Interface

This chapter provides information on Ethernet configuration.

- Introduction
- Installation of Ethernet Driver
 - for Windows 95
 - for Windows 98
 - for Windows NT
- Further Information

4.1 Introduction

The IPPC-9120/9150 is equipped with a high performance 32-bit Ethernet chipset which is fully compliant with IEEE 802.3 100 Mbps CSMA/CD standards. It is supported by major network operating systems. It is also both 100Base-T and 10Base-T compatible. The medium type can be configured via the RSET8139.exe program included on the utility disk.

The Ethernet port provides a standard RJ-45 jack. The network boot feature can be utilized by incorporating the boot ROM image files for the appropriate network operating system. The boot ROM BIOS files are combined with system BIOS, which can be enabled/disabled in the BIOS setup.

4.2 Installation of Ethernet Driver

Before installing the Ethernet driver, note the procedures below. You must know which operating system you are using in your IPPC-9120/9150, and then refer to the corresponding installation flow chart. Then just follow the steps described in the flow chart. You will quickly and successfully complete the installation, even if you are not familiar with instructions for Windows.

Important: The following windows illustrations are examples only. You must follow the flow chart instructions and pay attention to the instructions which then appear on your screen.

Note 1: The CD-ROM drive is designated as "D" throughout this chapter.

Note 2: <Enter> means pressing the "Enter" key on the keyboard.

4.2.1 Installation for Windows 95

1. a. Select "Start," "Settings," "Control Panel," "System"
 - b. Click "Device Manager" and "Other Devices"
 - c. Remove "PCI Ethernet Controller" item

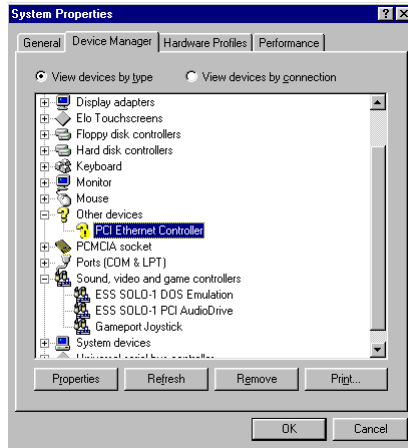

2. a. Select "Start," "Settings," "Control Panel" and "Network"
 - b. Click "Add"

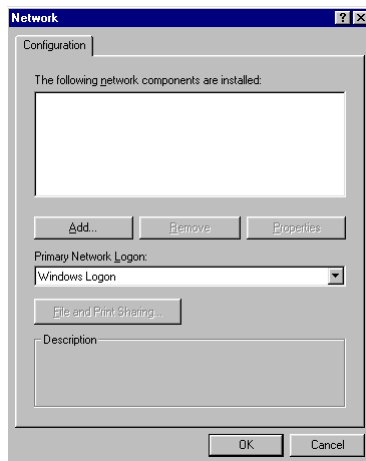

3. Select "Adapter" and then "Add"

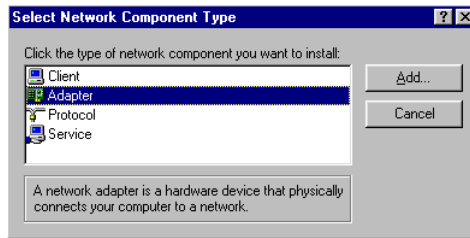

4. Press the "Have Disk..." button

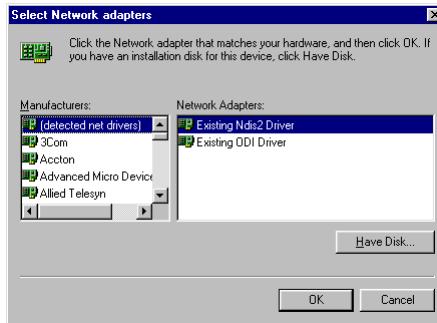

5. a. Type path "D:\IPPC9150&9120T\Lan\W95OSR2"
- b. Click "OK"

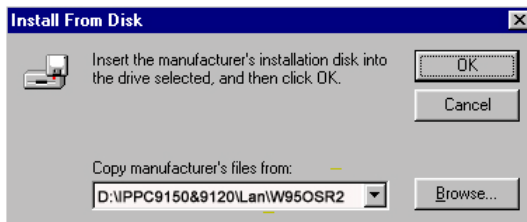

6. a. Choose "Realtek RTL8139(A/B/C/8130)PCI Fast Ethernet"
- b. Press "OK"

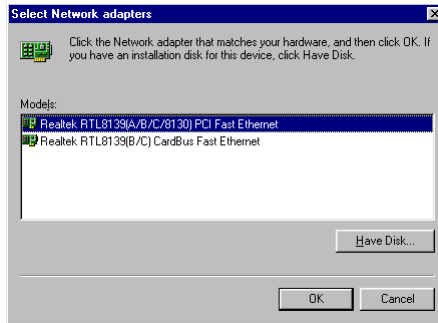

7. a. Press "Add..." to select suitable services or protocol
- b. Press "OK" to finish network configuration

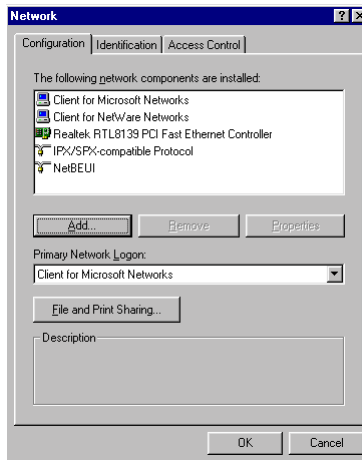

8. Press "Yes" to reboot your system

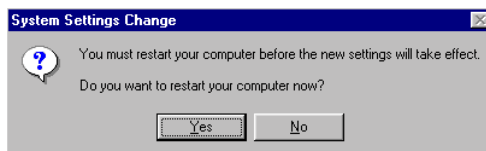

4.2.2 Installation for Windows 98

1. a. Select "Start," "Settings," "Control Panel," "System"
 - b. Click "Device Manager" and "Other Devices"
 - c. Remove "PCI Ethernet Controller" item

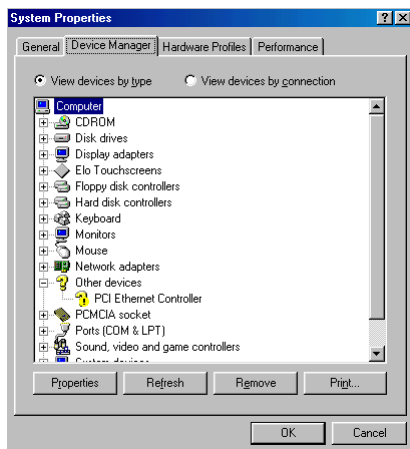

2. a. Select "Start," "Settings," "Control Panel" and "Network"
 - b. Click "Add"



3. Select "Adapter" and then "Add"

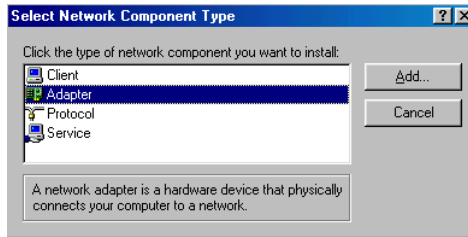

4. Press the "Have Disk..." button

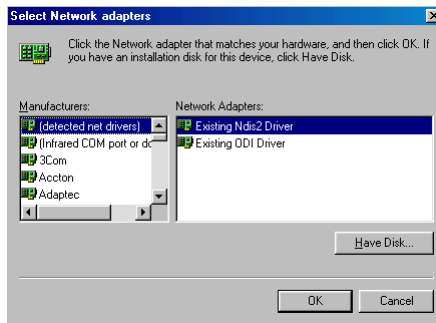

5. a. Type path "D:\PPC950&9120TLAN\WIN98"
b. Click "OK"



6. a. Choose "Realtek RTL8139(A/B/C/8130)PCI Fast Ethernet"
- b. Press "OK"

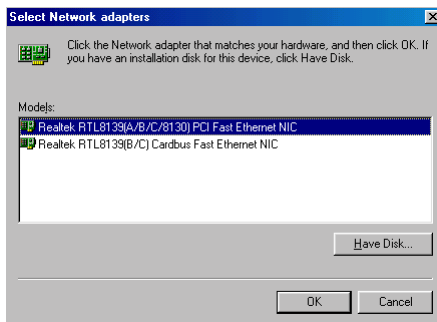

7. a. Press "Add..." to select suitable services or protocol
- b. Press "OK" to finish network configuration

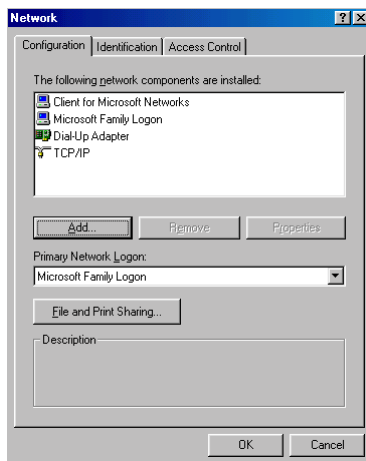

8. Press "Yes" to reboot your system

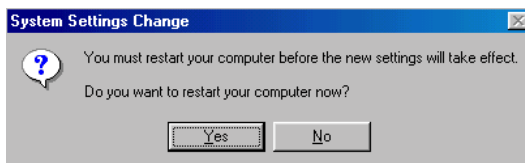

4.2.3 Installation for Windows NT

1. a. Select "Start," "Settings," "Control Panel" and double click the "Network" icon
 - b. Choose "Adapters" tab
 - c. Click "Add"

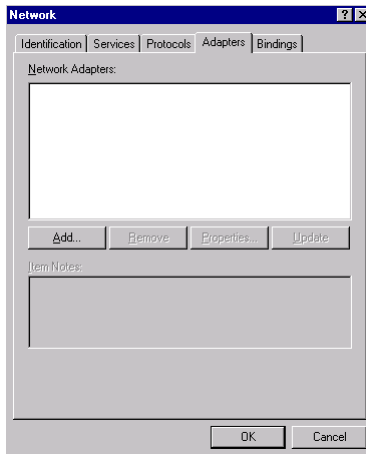

2. Press "Have Disk..."

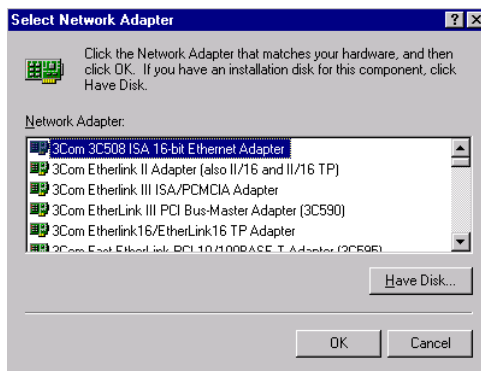

3. a. Enter the path "D:\IPPC9150&9120\LAN\Winnt4"
- b. Press "OK"

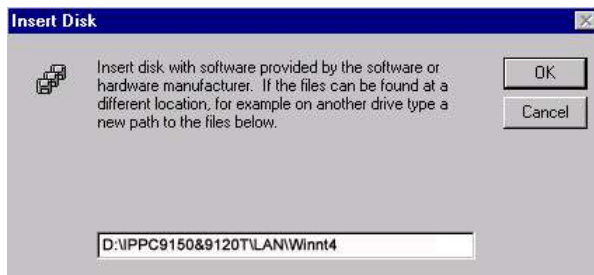

4. a. Choose "Realtek RTL8139(A/B/C/8130)PCI Fast Ethernet"
- b. Press "OK"

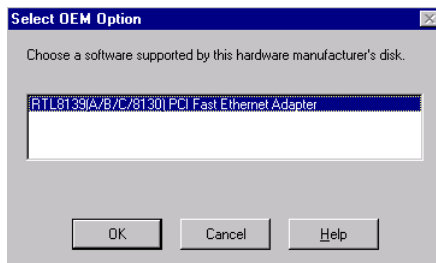

5. Choose a suitable RTL8139 Duplex mode for your application

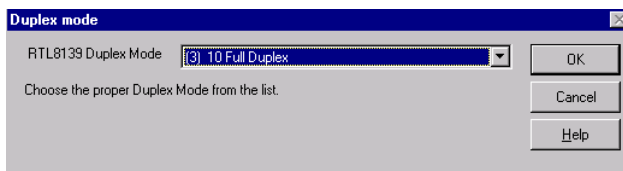

6. Finish network configuration and click "OK"

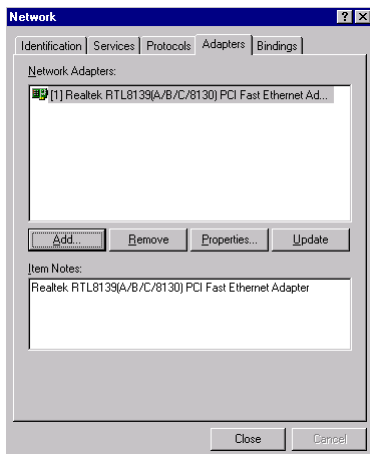

4.3 Further Information

Realtek website: www.realtek.com.tw

Advantech websites: www.advantech.com

www.advantech.com.tw

CHAPTER
5

PCI SVGA Setup

- Introduction
- Installation of SVGA Driver
 - for Windows 95
 - for Windows 98
 - for Windows NT
- Further Information

5.1 Introduction

The IPPC-9120/9150 has an onboard AGP flat panel/VGA interface. The specifications and features are described as follows:

5.1.1 Chipset

The IPPC-9120/9150 uses a Lynx3DM chipset from Silicon Motion Inc. for its AGP/SVGA controller. It supports TFT, DSTN flat panel displays and conventional analog CRT monitors. The SMI 710 VGA BIOS supports monochrome LCD, EL, color TFT and STN LCD flat panel displays. In addition, it also supports interlaced and non-interlaced analog monitors (color and monochrome VGA) in high-resolution modes while maintaining complete IBM VGA compatibility. Digital monitors (i.e. MDA, CGA, and EGA) are NOT supported. Multiple frequency (multisync) monitors are handled as if they were analog monitors.

5.1.2 Display memory

With onboard 4 MB display memory, the VGA controller can drive CRT displays or color panel displays with resolutions up to 1024 x 768 at 16 M colors.

5.1.3 Display types

CRT and panel displays can be used simultaneously. The IPPC-9120/9150 can be set in one of three configurations: on a CRT, on a flat panel display, or on both simultaneously. The system is initially set to simultaneous display mode. If you want to enable the CRT display only or the flat panel display only, contact Silicon Motion Inc. or our sales representative for detailed information.

5.2 Installation of SVGA Driver

Complete the following steps to install the SVGA driver. Follow the procedures in the flow chart that apply to the operating system that you you are using within your IPPC-9120/9150.

Important: The following windows illustrations are examples only. You must follow the flow chart instructions and pay attention to the instructions which then appear on your screen.

Note 1: The CD-ROM drive is designated as "D" throughout this chapter.

Note 2: <Enter> means pressing the "Enter" key on the keyboard.

5.2.1 Installation for Windows 95

1. a. Select "Start," " Settings," "Control Panel," "Display" and "Settings"
b. Press "Advanced Properties"

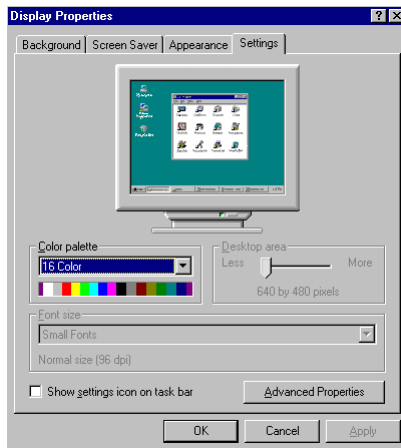

2. a. Choose "Adapter" tab
b. Press "Change"

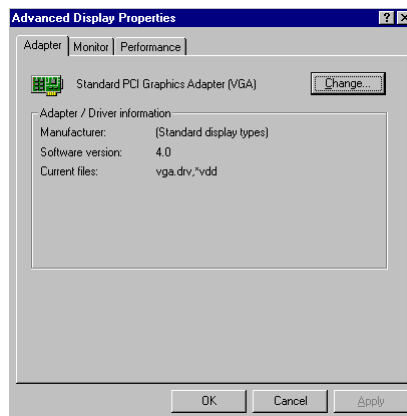

3. Press "Have Disk..."

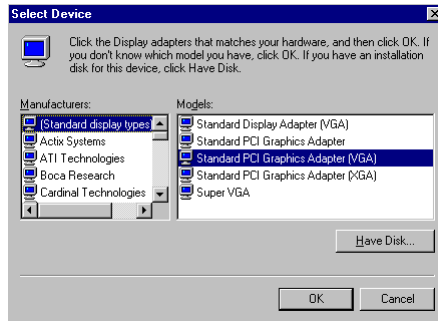

4. Enter the path "D:\IPPC9150&9120T\VGA\Win9x"



- 5. a. Select highlighted item
- b. Click "OK"

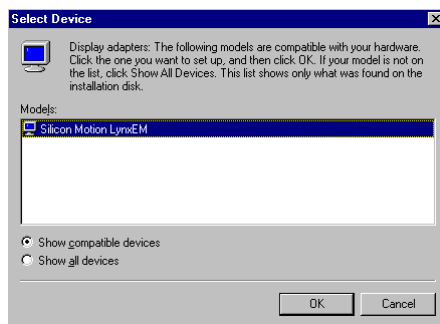

6. a. "Silicon Motion Lynx3DM" appears in the adapter label
- b. Click "Apply"
- c. Click "OK"

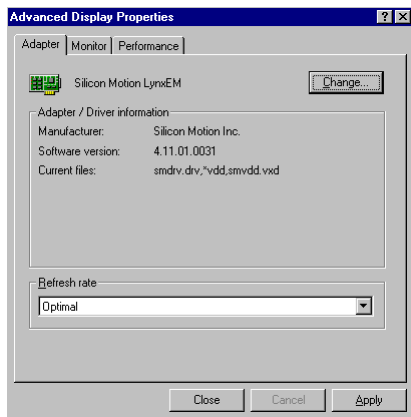

7. Press "Yes" to reboot your system

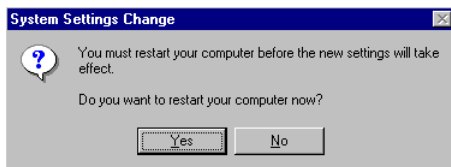

5.2.2 Installation for Windows 98

1. a. Select "Start," " Settings," "Control Panel," "Display" and "Settings"
- b. Press "Advanced Properties"

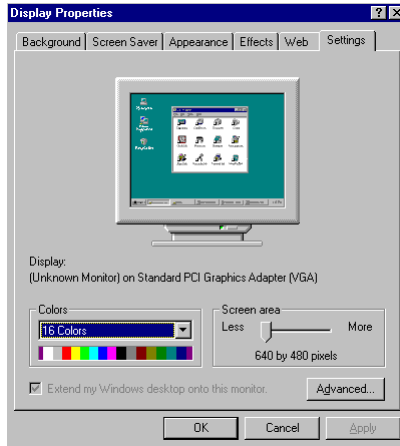

2. a. Choose "Adapter" tab
- b. Press "Change"

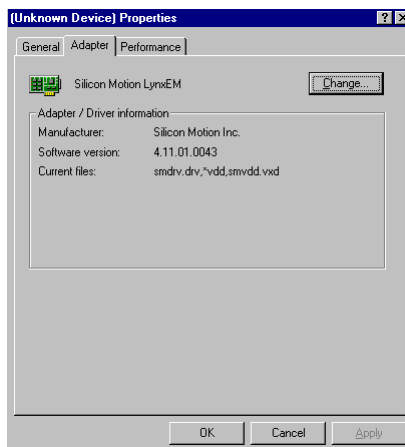

3. Choose the second option; "Display..."



4. Press "Have Disk..."

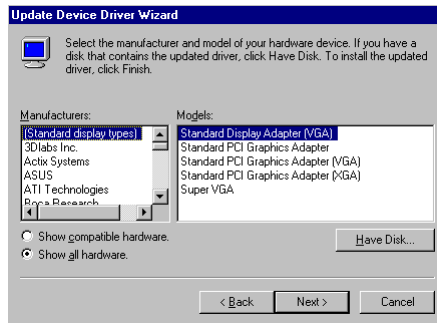

5. a. Insert the disk into the CD-ROM drive
- b. Enter the path "D:\IPPC9150&9120T\VGA\Win9x"
- c. Press "OK"



6. a. Select highlighted item
- b. Click "OK"

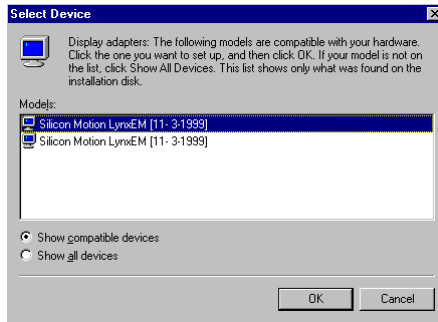

7. a. "Silicon Motion Lynx3DM" appears in the adapter label
- b. Click "Apply"
- c. Click "OK"



7. Press "Yes" to reboot your system

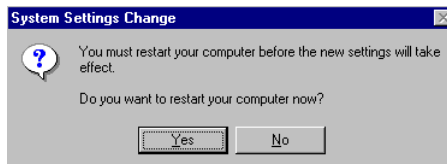

5.2.3 Installation for Windows NT

Note: Service Pack X (X = 3, 4, 5, 6, ...) must be installed first before you install the Windows NT VGA driver.

1. a. Select "Start," " Settings," "Control Panel"
- b. Double click "Display"

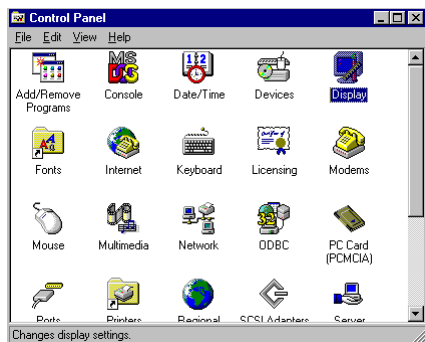

2. a. Choose "Settings" tab
- b. Press "Display Type"

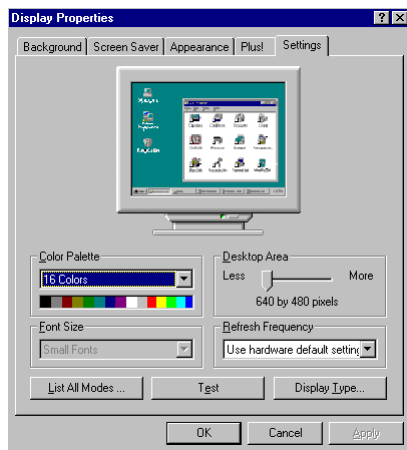

3. Press "Change..."

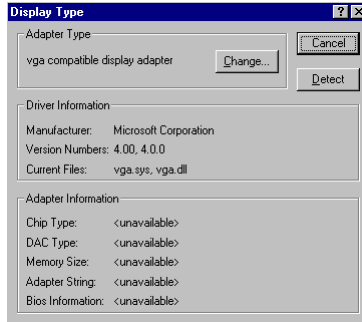

4. Press "Have Disk..."

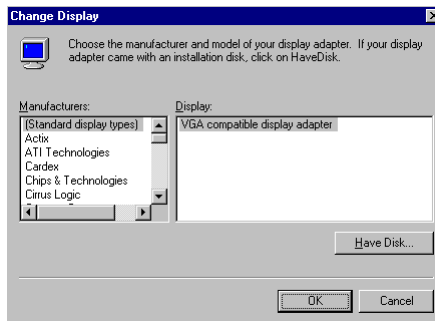

5. a. Enter the path "D:\IPPC9150&9120T\VGA\nt4"
 b. Press "OK"



6. a. Select highlighted item
- b. Click "OK"

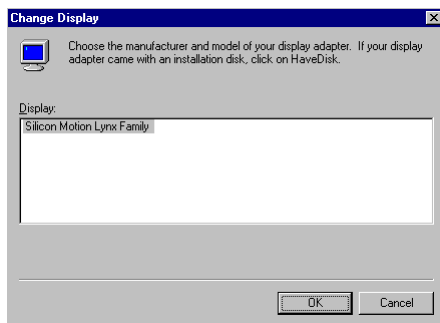

7. Press "Yes" to proceed

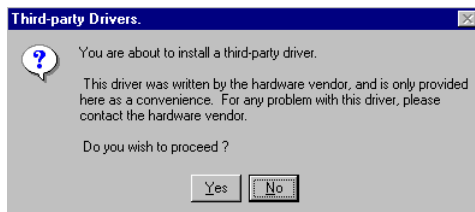

8. Press "OK" to reboot

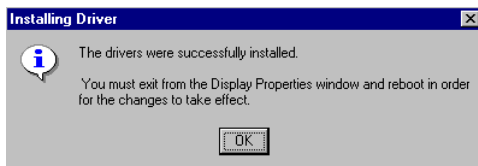

5.3 Further Information

For further information about the AGP/SVGA installation in your IPPC-9120/9150, including driver updates, troubleshooting guides and FAQ lists, visit the following web resources:

Silicon Motion website: **www.siliconmotion.com**

Advantech websites: **www.advantech.com**
www.advantech.com.tw

CHAPTER
6

Audio

- Introduction
- Installation of Audio Driver
 - for Windows 95/98
 - for Windows NT

6.1 Introduction

The IPPC-9120/9150's onboard audio interface provides high-quality stereo sound and FM music synthesis (ESFM) by using the ES1946S audio controller from ESS Technology, Inc. The audio interface can record, compress, and play back voice, sound, and music with a built-in mixer control. The IPPC 9120/9150's onboard audio interface also supports the Plug and Play (PnP) standard and provides PnP configuration for audio, FM, and MPU-104 logical devices. It is compatible with Sound Blaster, Sound Blaster Pro version 3.01, voice, and music functions. The ESFM synthesizer is register compatible with the OPL3 and has extended capabilities.

6.2 Installation of Audio Driver

Before installing the audio driver, please take note of the procedures detailed below. You must know which operating system you are using in your IPPC-9120/9150, and then refer to the corresponding installation flow chart. Just follow the steps in the flow chart. You can quickly and successfully complete the installation, even though you are not familiar with instructions for Windows.

Important: The following windows illustrations are examples only. You must follow the flow chart instructions and pay attention to the instructions which then appear on your screen.

Note 1: The CD-ROM drive is designated as "D" throughout this chapter.

Note 2: <Enter> means pressing the "Enter" key on the keyboard.

6.2.1 Installation for Windows 95/98

1. a. Select "Start" and "Run"
- b. Enter the driver path
 "D:\IPPC9150&9120T\Audio\Win9x(only)\setup.exe"

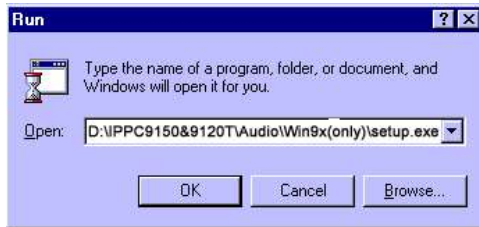

2. Click "Next" to continue



3. a. Select "Upgrade Drivers"
- b. Click "Next"

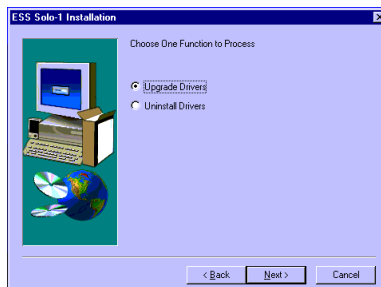

4. Click "Finish" to restart your computer



5. a. After installation, select "Start," "Settings," "Control Panel" and "System"

b. Click "Device Manager" tab to confirm installation

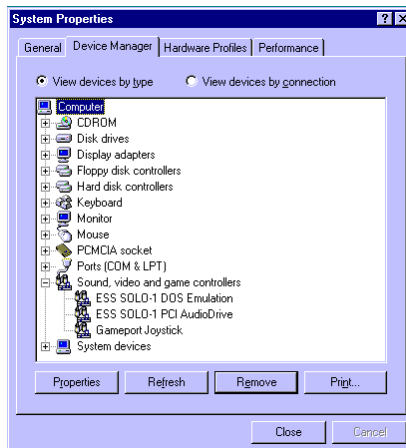

6.2.2 Installation for Windows NT

1. a. Select "Start," "Settings" and "Control Panel"
- b. Double click "Multimedia" icon



2. a. Select "Devices" tab
- b. Click "Add..."

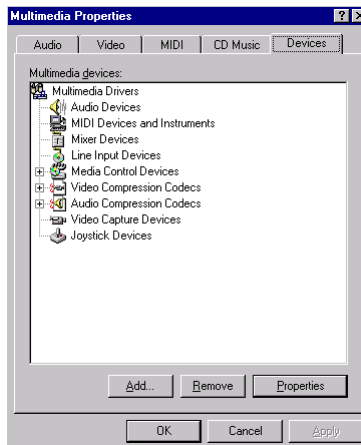

3. a. Choose "Unlisted or Updated Driver" item
- b. Click "OK"

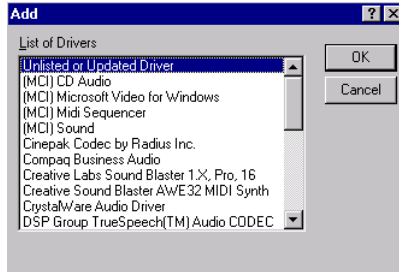

4. a. Enter the path "D:\IPPC9150&9120T\Audio\NT40"
- b. Click "OK"



5. a. Select the highlighted item
- b. Press "OK"

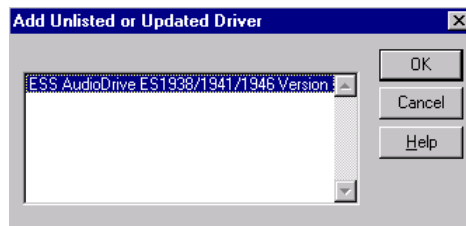

6. Press "Restart Now" to reboot your computer.

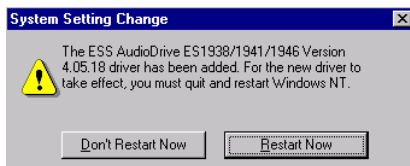

CHAPTER 7

PCMCIA

- Introduction
- Installation of PCMCIA Driver
 - for Windows 95

7.1 Introduction

The IPPC-9120/9150 is equipped with a high performance PCMCIA interface which complies with the 1995 PCMCIA card standard by using the RICOH Cardbus controller. The panel PC supports two PCMCIA card/cardbus slots. Two sockets support both a 16-bit PCMCIA card and a 32-bit Cardbus simultaneously, with hot insertion and removal.

7.2 Installation of PCMCIA Driver

The PCMCIA driver for Windows 95 is included in the "Drivers and Utilities" CD-ROM included with your IPPC-9120/9150. The installation procedure is shown in the next section in this chapter.

Other operating systems such as Windows 98 and Windows NT also support PCMCIA drivers. However, the drivers for these operating systems are not included in the "Drivers and Utilities" CD-ROM. Installation for these operating systems is not explained in this manual.

Important: The following windows illustrations are examples only. You must follow the flow chart instructions and pay attention to the instructions which then appear on your screen.

Note 1: The CD-ROM drive is designated as "D" throughout this chapter.

Note 2: <Enter> means pressing the "Enter" key on the keyboard.

7.2.1 Installation for Windows 95

1. a. Select "Start" and "Run"
 - b. Enter the path
"D:\MPPC9150&9120T\Cardbus\Win95osr2\setup.exe"



2. Click "Next"

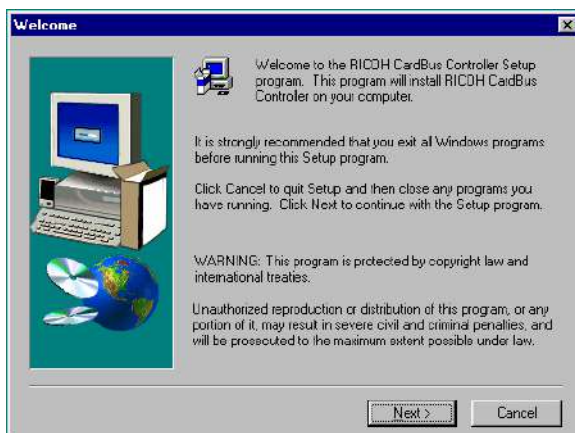

3. Click "Yes"

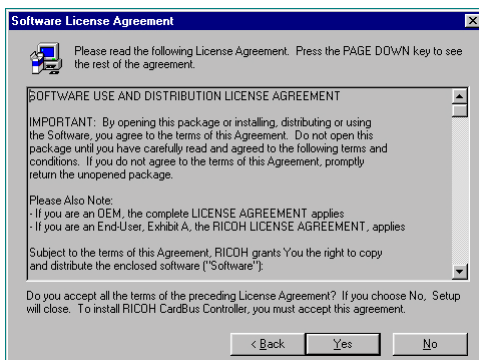

4. Click "Finish" to reboot your system



CHAPTER
8

Touchscreen

- Introduction
- Installation of Touchscreen Driver
 - for Windows 95
 - for Windows 98
 - for Windows NT

8.1 Introduction

8.1.1 General information

The IPPC-9120/9150 supports analog resistive-type and NFI-type touchscreens. Analog resistive touchscreens are popular and affordable. NFI offers advantages in exceptional brightness, clarity and readability.

8.1.2 Analog Resistive Touchscreen Specifications

Electrical

- **Contact bounce:** < 10 ms
- **Operating voltage:** 5 V (typical)
- **Contact current:** 20 mA (maximum)
- **Circuit resistance (open):** > 30 mohms
- **Circuit resistance (closed):** < 2000 mohms
- **Sheet resistance variation:** Within one screen: $\pm 5\%$ nominal
From screen to screen: $\pm 20\%$ of nominal

Durability

- **Test conditions:** 4 H hardness, 0.04" stylus pen, 350 gram load
- **Point activation:**
Single point, position of stylus controlled to $\pm 0.0005"$
Result: > 1 million activations
- **Linear activation:**
2" diagonal line, position of stylus controlled to $\pm 0.0005"$
Result: > 250,000 cycles
- **Chemical resistance:**
Hard coating is highly resistant to most solvents and chemicals

Optical

- **Visible light transmission:** 72% (typical)
- **Reflection:** > 25% @ 550 nm

Sensor board

- Chemical strengthened glass with 4 H hardness standard.
(Test condition: ASTM D3363-92A)

Ball drop test

- Able to bear a 225 g steel ball dropped from 660 mm elevation without breaking

Environmental specifications

- **Operating pressure:** 30 ~ 45 grams for finger; 10 grams for stylus pen

- **Operating temperature:** 0 ~ 50° C (humidity 20 ~ 90% RH)
- **Storage temperature:** -25 ~ 70° C (humidity 20 ~ 95% RH)

8.1.3 NFI Touchscreen Specifications

Performance

- **Touch inputs:** gloved hand or bare finger; conductive stylus
- **Touch speed:** < 20ms nominal controller response time
- **Resolution:** minimum 1024 points per axis
- **Touch positional accuracy:** +/- 1.0% in one direction and +/- 2.0% in the other direction
- **Drift:** none

Sensor

- **Optical Transmissivity:** > 83% standard product
- **Construction:** laminated layers of chemically strengthened glass
- **Touch surface:** anti-glare glass

Controller

- **Communications:** RS-232
- **Power requirements:** 5V +/- 5%, 4.75V minimum ; 150mA average, peaks to 300mA
- **Excitation signal on sensor:** 50 to 60Khz 12V p-p

Software

- **Dynapro drivers for:** MS-DOS, Windows 3.1, Windows 95/98, Windows NT4.0; support for other operating systems available
- **Utilities:** set-up and diagnostic utility included

Environmental

- **Operating temperature:** -20°C to +70°C for sensor 0°C to +70°C for controller
- **Storage temperature:** -40°C to +85°C
- **Humidity:** 95% RH non-condensing
- **ESD:** exceeds EN 61000-4-2; 8kV air discharge, 4kV contact discharge
- **EMI:** unaffected by EMI from nearby CRT's and displays, environmental EMI; complies with ENV 50140

Reliability

- **Touch life:** tested to more than 100 million touches in one location without failure
- **Surface durability:** equivalent to soda lime glass, Mohs hardness rating of 6

- **Sealing capability:** unit can be sealed to protect against splashed liquids, dirt, and dust; will not prevent NEMA12 and NEMA 4X
- **Chemical resistance:** resistant to all chemicals that do not affect soda lime glass; highly resistant to corrosives in accordance with ASTM-D-1038.
- **Impact resistance:** meets UL-1950 and CSA C22.2 No. 950 ball drop test; 5kg 50mm diameter ball dropped from height of 1.3m

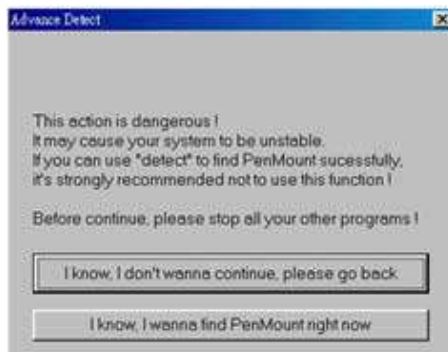

8.2 Installation of Resistive-type Touchscreen Driver

The touchscreen built into the IPPC-9120/9150 Series uses a driver for operating Windows 95, Windows 98, or Windows NT 4.0.

To facilitate installation of the touchscreen driver, you should read the instructions in this chapter carefully before you attempt installation.

Note 1: *The following windows illustrations are examples only. You must follow the flow chart instructions and pay attention to the instructions which then appear on your screen.*

Note 2: *The CD-ROM drive is designated as "D" throughout this chapter.*

8.2.1 Installation for Windows 95/98

1. a. Select "Start" and "Run"
 - b. Enter path
"D:\PPC9150&9120T\TouchDrv\PenMount\Win9xv3.3\setup.exe"
 - c. Press OK



2. Select "Advance"

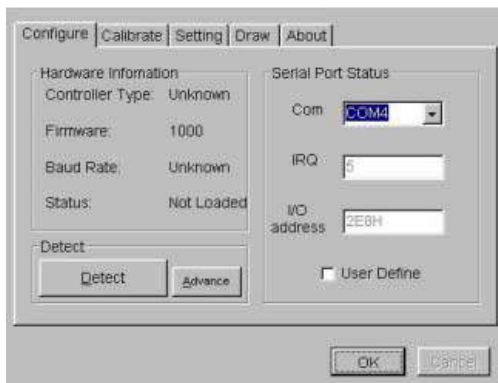

3. Select "I know, I wanna find PenMount right now"

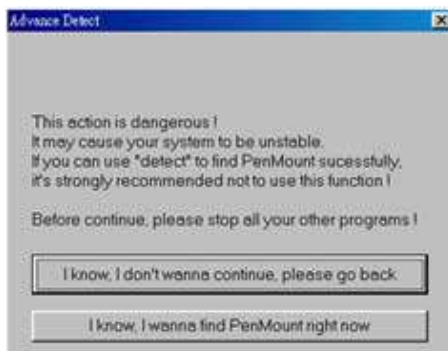

4. After COM4 is found, press "OK" to restart the system

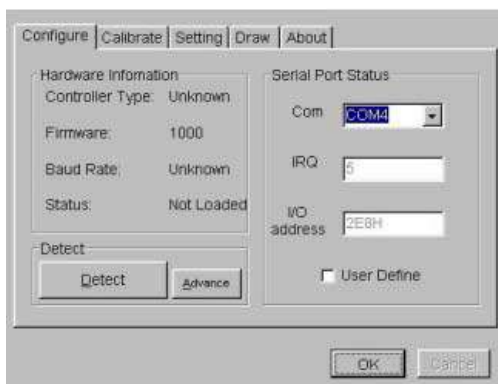

5. a. After system reboot, select "Start," "Programs," "PenMount Utilities" and "PenMount Control Panel"
- b. Press "Calibrate" tab
- c. Press "Calibrate" button on the right side



6. a. Use a soft stylus to press the little red dot located above the pointer
- b. Repeat the process at the specified locations



7. Press "OK"



8.2.2 Installation for Windows NT

1. a. Select "Start" and "Run"
 - b. Enter path "D:\IPPC9150&9120T\TouchDrv\PenMount\Winnt-ver3.11\setup.exe"
 - c. Press "OK"

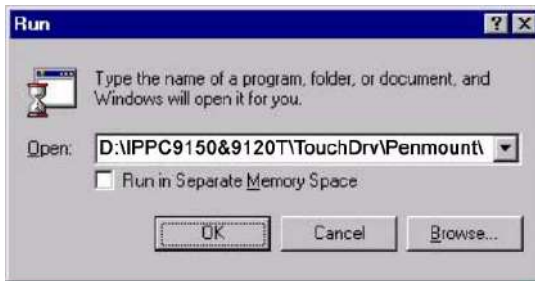

2. a. Press "Detect"
 - b. Press "OK" to reboot the system



3. a. After system reboot, select "Start," "Programs," "PenMount Utilities" and "PenMount Control Panel"
- b. Press "Calibrate" tab
- c. Press "Calibrate" button on the right side



4. a. Use a soft stylus to press the little red dot located above the pointer
- b. Repeat the process at the specified locations

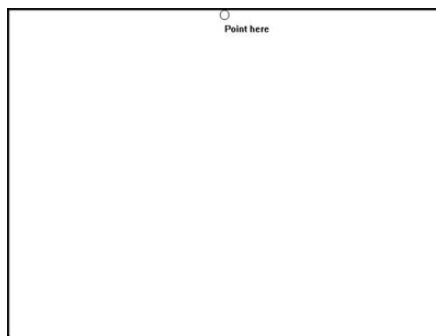

5. a. Press "OK"



8.3 Installation of NFI touchscreen driver

9.3.1 Installation for Windows 95/98

1. a. Select "Start" and "Run"
 - b. Enter "D:\IPPC9150&9120T\TouchDrv\Nfi\Win9x\install.exe"



2. Press "Next"



3. a. Select "Custom"
- b. Select the IRQ for COM4 (refer to 9.10)
- c. Select the I/O address for COM4 (refer to 9.10)



4. a. Click "Install" and the system will automatically install the driver
- b. After installation, press "Restart"



5. The following window will appear after reboot. Press "Next"



6. Press "Start." Do not touch the panel during this process

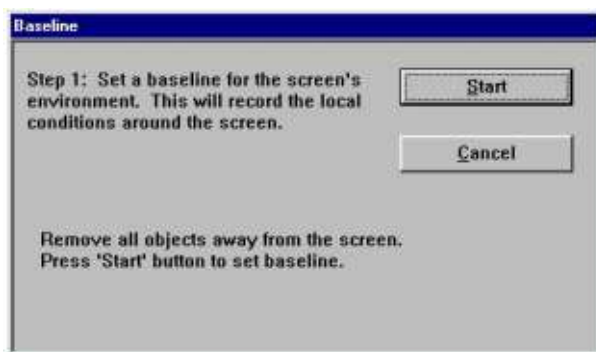

7. Click "Next"



8. Click "Next"

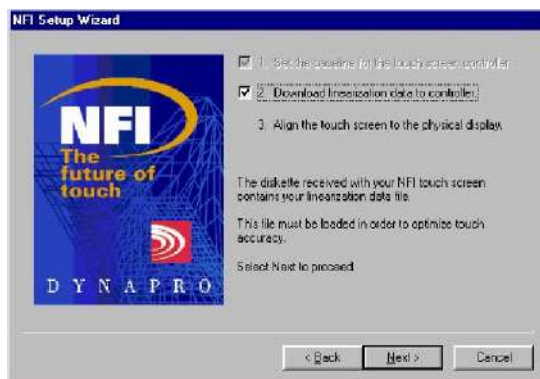

9. a. Insert linearization driver disk
- b. Browse drive A: and pick the corresponding file

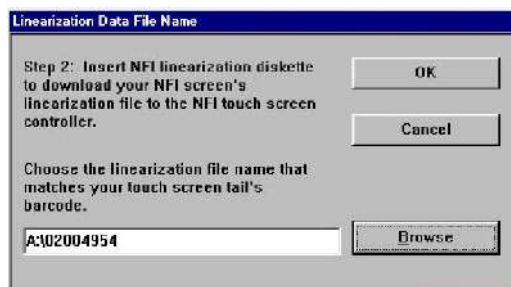

10. Click "Start"



11. Click "Finish"



12. Click "Start"

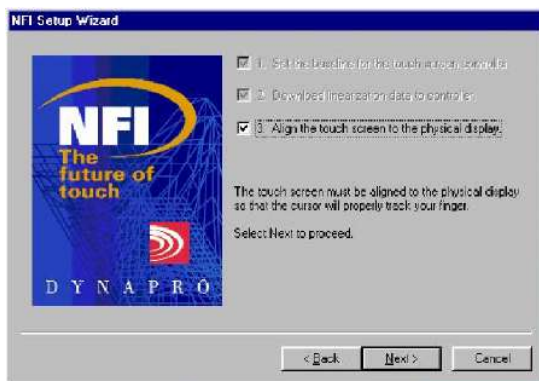

13. Click "Alignment"

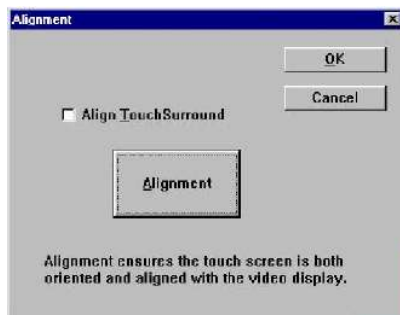

14. a. Use your finger and touch the center of the screen to define the position
- b. Repeat three times



15. Select "Done"

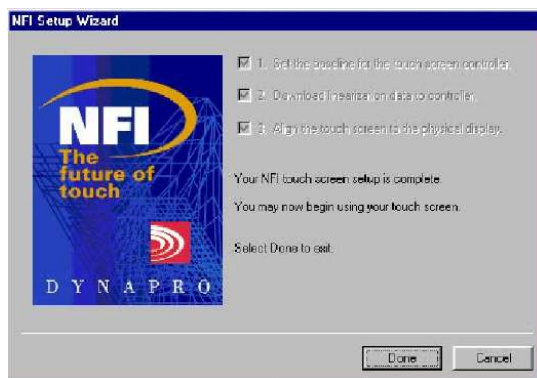

8.3.2 Installation for Windows NT

1. a. Select "Start" and "Run"
 - b. Enter path
"D:\IPPC9150&9120T\TouchDrv\Nfi\WinNT\install.exe"

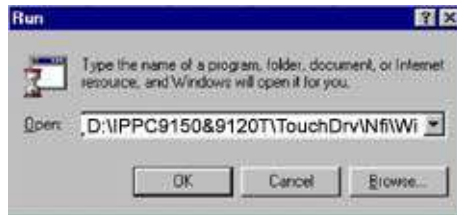

2. Press "Next"



3. a. Select port "COM4"
- b. Select interrupt "IRQ5"
- c. Select I/O address "2E8h"



4. Click "Install"



5. a. After installation, the following window will appear
b. Press "Yes" to reboot



6. a. The following window will appear after boot
b. Press "Next"



7. Click "Next"



8. a. Press "Start"

b. Do not touch the panel during the process

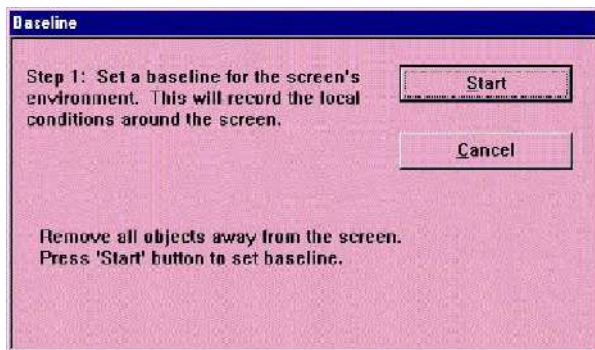

9. Click "Start"

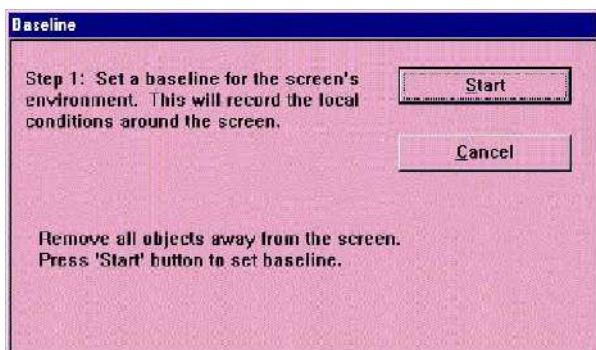

Note: Each NFI touchscreen will be given an individual linearization driver. Please keep this unique driver for system configuration. The driver's serial number can be found on the disk's label and the system's back panel. If you are missing the driver, please contact a sales representative and present the serial number for a reissue.

10. Click "Next"

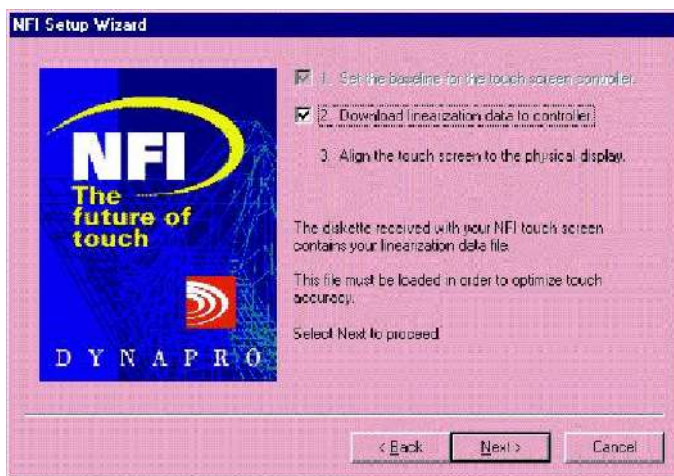

11. a. Insert linearization driver disk
 - b. Browse drive A: and choose corresponding file
 - c. Press "OK"

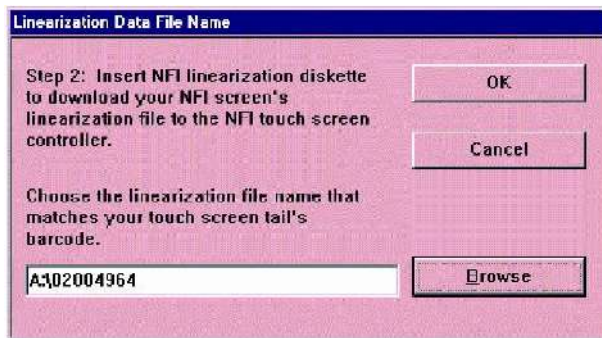

12. Click "Start"

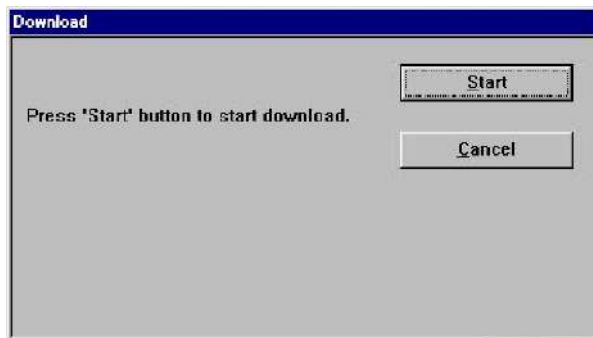

13. Click "Finish"



14. Click "Next"

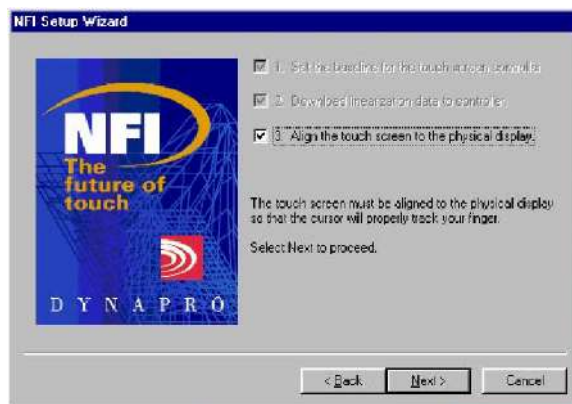

15. Press "Alignment"

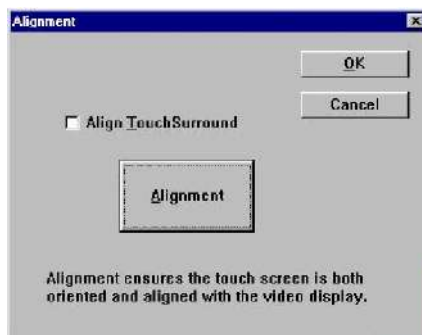

16. a. Use your finger and touch the center of the cross to define the position
- b. Repeat three times



17. Select "Done"



CHAPTER
9

Award BIOS Setup

This chapter describes how to set BIOS configuration data.

9.1 Award BIOS Setup

The IPPC-9120/9150 comes with an Award BIOS chip that contains the ROM setup for your system. This chip serves as an interface between the processor and the rest of the mainboard's components. This chapter explains the information contained in the setup program and tells you how to modify the settings according to your system configuration. Some setup items will not be explained, because it is recommended that users do not change such items.

Note: Values for the various setup items that appear on your own screen (including default values) may not be the same as the values shown on the screen figures in this chapter. This is because the BIOS is revised and updated from time to time. If in doubt, check Advantech's website for the latest BIOS versions and related information.

9.2 CMOS Setup Utility

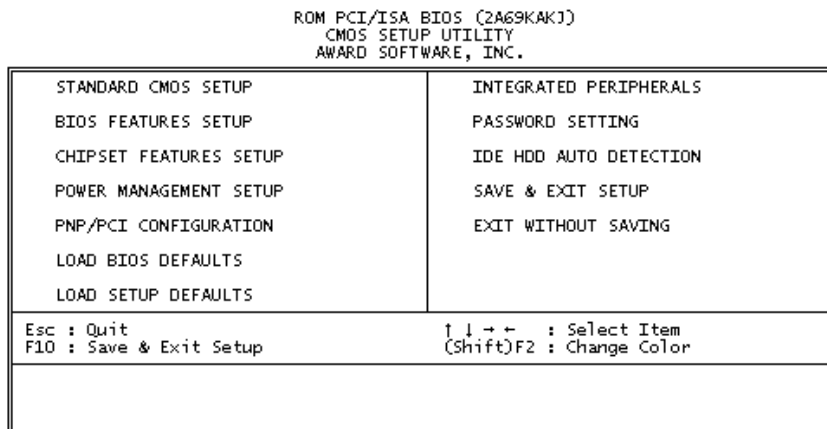

Figure 9-1: Setup program initial screen

A setup program, built into the system BIOS, is stored in the CMOS RAM that allows the configuration settings to be changed. This program is executed when the user changes the system configuration; when the user changes the system backup battery; or when the system detects a configuration error and asks the user to run the setup program. At power-on RAM testing, the message "Press DEL to enter Setup" appears. After pressing the "DEL" key, the CMOS setup utility screen will appear as shown in Fig. 9-1. Use the arrow keys to select and press "Enter" to run the selected program.

9.3 Standard CMOS Setup

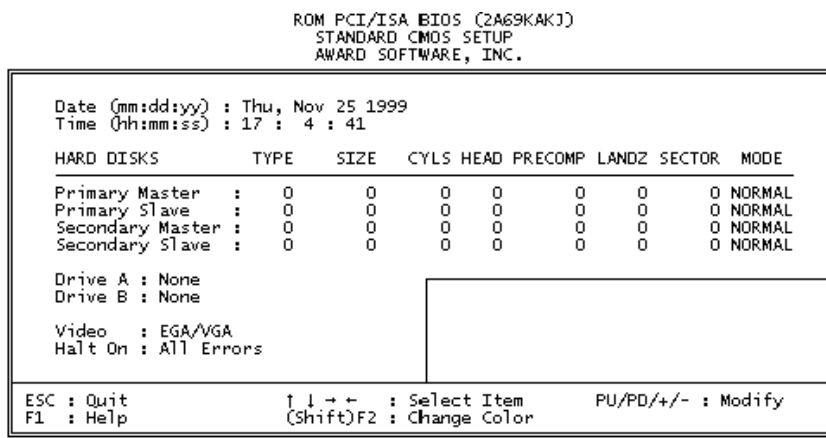

Figure 9-2: CMOS setup screen

The standard CMOS setup screen is shown above. System BIOS automatically detects memory size, so no changes are necessary. It has a few items requiring setting. Each item may have one or more optional settings. System BIOS allows you to change the system date and time, IDE hard disk, floppy disk drive types for drives A: and B:, boot-up video display mode, and POST error handling selection. Use the arrow keys to highlight the item and then use the "PgUp" or "PgDn" keys to select the value you want for each item.

9.3.1 Hard disk configurations

TYPE

Select from 1 to 45 to fill the remaining fields with predefined values for disk drives. Select "User" to fill the remaining fields. Select "Auto" to detect the HDD type automatically.

SIZE

Hard disk size. The unit is megabytes (MB).

CYLS

The cylinder number of the hard disk.

HEAD

The read/write head number of the hard disk.

PRECOMP

The cylinder number at which the disk drive changes the write timing.

LANDZ

The cylinder number where the disk drive heads (read/write) are seated when the disk drive is parked.

SECTOR

The sector number of each track defined on the hard disk.

MODE

Select "Auto" to detect the mode type automatically. If your hard disk supports the LBA mode, select "LBA" or "Large". However, if your hard disk supporting cylinder is more than 1024 MB and does not support the LBA function, you have to select "Large". If your hard disk supporting cylinder is below 1024 MB, select "Normal".

9.4 BIOS Features Setup

ROM PCI/ISA BIOS (2A69KAKJ)
BIOS FEATURES SETUP
AWARD SOFTWARE, INC.

Virus Warning	: Disabled	Video BIOS Shadow	: Enabled
CPU Internal Cache	: Enabled	C8000-CBFFF Shadow	: Disabled
External Cache	: Enabled	CC000-CFFFF Shadow	: Disabled
CPU L2 Cache ECC Checking	: Enabled	D0000-D3FFF Shadow	: Disabled
Processor Number Feature	: Enabled	D4000-D7FFF Shadow	: Disabled
Quick Power On Self Test	: Enabled	D8000-DBFFF Shadow	: Disabled
Boot From LAN First	: Disabled	DC000-DFFFF Shadow	: Disabled
Boot Sequence	: C,A,SCSI		
Swap Floppy Drive	: Disabled		
Boot Up Floppy Seek	: Enabled		
Boot Up NumLock Status	: On		
Gate A20 Option	: Fast		
Typeomatic Rate Setting	: Disabled		
Typeomatic Rate (Chars/Sec)	: 6		
Typeomatic Delay (Msec)	: 250		
Security Option	: Setup	ESC : Quit	↑↓←→ : Select Item
PS/2 mouse function control	: Enabled	F1 : Help	PU/PD/+/- : Modify
PCI/VGA Palette Snoop	: Disabled	F5 : Old Values (Shift)	F2 : Color
OS Select For DRAM > 64MB	: Non-OS2	F6 : Load BIOS Defaults	
Report No FDD For WIN 95	: Yes	F7 : Load Setup Defaults	

Figure 9-3: BIOS features setup screen

Moving around the BIOS Features and Chipset Features setup programs works the same way as moving around the Standard CMOS setup program. (Refer to the next section for Chipset Features setup.) The BIOS Features setup program is shown above. Users are not encouraged to run the BIOS and Chipset Features setup programs. Your system should have been fine-tuned before shipping. Improper setup may cause the system to fail, so consult your dealer before making any changes.

Virus Warning

When enabled, it assigns the BIOS to monitor the master boot sector and the DOS sector of the first hard disk drive.

The options are: Disabled (Default), Enabled.

CPU Internal Cache

When enabled, it improves system performance. Disable this item when testing or troubleshooting.

The options are: Enabled (Default), Disabled.

External Cache

When enabled, supports an external cache SRAM.

The options are: Enabled (Default), Disabled.

CPU L2 Cache ECC Checking

Allows the CPU L2 cache to enable the memory parity check.

The options are: Disabled (Default), Enabled.

Quick Power On Self Test

When enabled, allows the BIOS to bypass the extensive memory test.

The options are: Disabled (Default), Enabled.

Boot From LAN First

Enables the system to boot from a LAN.

The options are: Disabled (Default), Enabled.

Boot Sequence

Allows the system BIOS to first try to boot the operating system from the selected disk drive.

The options are:

C, A, SCSI (Default)

LS/ZIP, C

C (only)

SCSI, C, A

SCSI, A, C

F, A, SCSI

E, A, SCSI

D, A, SCSI

CDROM, C, A

C, CDROM, A

Swap Floppy Drive

When enabled, allows you to switch the order in which the operating system accesses the floppy drives during boot-up.

The options are: Disabled (Default), Enabled.

Boot Up Floppy Seek

When enabled, assigns the BIOS to perform floppy disk drive tests by issuing seek commands. Note that such tests are time-consuming.

The options are: Enabled (Default), Disabled.

Boot Up NumLock Status

When set to "On", allows the BIOS to automatically enable the NumLock function when the system boots up.

The options are: On (Default), Off.

Typematic Rate Setting

The term typematic means that when a keyboard key is held down, the character is repeatedly entered until the key is released. When this item is enabled, you may change the typematic repeat rate.

The options are: Disabled (Default), Enabled.

Typematic Rate (Chars/Sec)

Sets the rate of a character repeat when the key is held down.

The options are: 6 (Default), 8, 10, 12, 15, 20, 24, 30.

Typematic Delay (msec)

Sets the delay time before a character is repeated.

The options are: 250 (Default), 500, 750, 1000 milliseconds.

Security Option

Allows you to set the security level of the system.

The options are: Setup (Default), System.

PS/2 Mouse Function Control

When enabled, the PS/2 mouse is activated.

The options are: Disabled (Default), Enabled.

PCI/VGA Palette Snoop

When enabled, allows you to install an enhanced graphics adapter card. If your graphics adapter card does not support the Palette Snoop function, set at "Disabled" to avoid system malfunctions.

The options are: Disabled (Default), Enabled.

OS Select For DRAM > 64MB

If your operating system (OS) is OS2, select "OS2". Otherwise, stay with the default setting Non-OS2.

Report No FDD For WIN 95

Assigns IRQ6 for the FDD.

The options are: Yes (Default), No.

Video BIOS Shadow

When enabled, allows the BIOS to copy the video ROM code of the add-on video card to the system memory, giving faster access.

The options are: Enabled (Default), Disabled.

C8000-CBFFF Shadow through to DC000-DFFFF Shadow

When enabled, allows the BIOS to copy the BIOS ROM code of the add-on card to the system memory for faster access. It may improve the performance of the add-on card. Some add-on cards will not function properly if their BIOS ROM codes are shadowed. To use this option correctly, you need to know the memory address range used by the BIOS ROM of each add-on card.

The options are: Disabled (Default), Enabled.

9.5 Chipset Features Setup

Note: It is strongly recommended that setup items in this section NOT be changed, because advanced knowledge is required to effect such changes.

ROM PCI/ISA BIOS (2A69KAKJ)
CHIPSET FEATURES SETUP
AWARD SOFTWARE, INC.

Auto Configuration : Enabled	Power-Supply Type : AT
EDO DRAM Speed Selection : 60ns	Auto Detect DIMM/PCI Clk : Enabled
EDO CASX# MA Wait State : 2	Spread Spectrum : Disabled
EDO RASX# Wait State : 1	CPU Host Clock (CPU/PCI) : Default
SDRAM RAS-to-CAS Delay : 3	CPU Warning Temperature : Disabled
SDRAM RAS Precharge Time : 3	Current System Temp. :
SDRAM CAS latency Time : Auto	Current CPU Temperature :
SDRAM Precharge Control : Disabled	Current System Fan Speed :
DRAM Data Integrity Mode : Non-ECC	Current CPU Fan Speed :
System BIOS Cacheable : Enabled	Vcore : +3.3V :
Video BIOS Cacheable : Enabled	+ 5 V : +12 V :
Video RAM Cacheable : Enabled	-12 V :-
8 Bit I/O Recovery Time : 1	
16 Bit I/O Recovery Time : 1	
Memory Hole At 15M-16M : Disabled	ESC : Quit ↑↓←→ : Select Item
Passive Release : Enabled	F1 : Help PU/PD/+/- : Modify
Delayed Transaction : Disabled	F5 : Old Values (Shift)F2 : Color
AGP Aperture Size (MB) : 64	F6 : Load BIOS Defaults
	F7 : Load Setup Defaults

Figure 9-4: Chipset features setup screen

EDO CASX# MA Wait State

Sets the EDO CASX# MA wait state.

The options are: 1 (Default), 2.

EDO RASX# Wait State

Sets the EDO RASX# wait state.

The options are: 1 (Default), 2.

SDRAM CAS Latency Time

Sets the SDRAM CAS latency time.

The options are: Auto (Default), 2, 3.

SDRAM Data Integrity Mode

When set as Non-ECC, supports standard 64-bit DIMM RAM modules. When set as ECC, supports standard 72-bit ECC RAM modules.

The options are: Non-ECC (Default), ECC.

System BIOS Cacheable

When enabled, allows the ROM area F000H-FFFFH to be cacheable when the cache controller is activated. The recommended setting is "Disabled", especially for high speed CPUs (200 MHz and above).

Video BIOS Cacheable

When enabled, allows the system to use the video BIOS codes from SRAMs, instead of the slower DRAMs or ROMs.

The options are: Enabled (Default), Disabled.

Video RAM Cacheable

Enables video RAM to be cacheable.

The options are: Disabled (Default), Enabled.

16 Bit I/O Recovery Time

Sets 16-bit I/O signal recovery time.

The options are: 1 (Default), 2, 3, 4, N/A.

Memory Hole at 15M-16M

When enabled, the memory hole at the 15 MB address will be relocated to the 15 ~ 16 MB address range of the ISA cycle when the processor accesses the 15 ~ 16 MB address area.

When disabled, the memory hole at the 15 MB address will be treated as a DRAM cycle when the processor accesses the 15 ~ 16 MB address.

The options are: Disabled (Default), Enabled.

Delayed Transaction

When disabled, the system operates normally. When enabled, the system can support lower-speed ISA devices.

The options are: Disabled (Default), Enabled.

Spread Spectrum

When disabled, the system operates normally. When enabled, the spread spectrum will be set to 0.5% (CNTR).

The options are: Disabled (Default), Enabled.

9.6 Power Management Setup

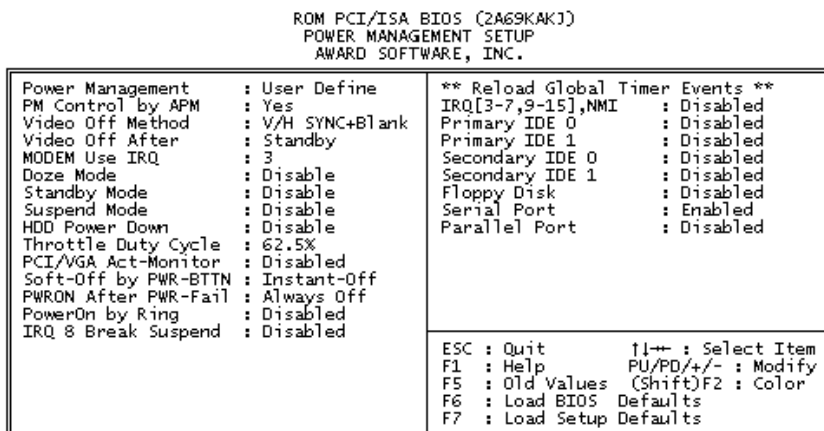

Figure 9-5: Power management setup screen

Power Management

When enabled, allows you to use Power Management features.

The options are: Disabled (Default), Enabled.

PM Control by APM

The option "No" allows the BIOS to ignore the APM (Advanced Power Management) specification. Selecting "Yes" will allow the BIOS to wait for APM's prompt before it enters Doze mode, Standby mode, or Suspend mode. If the APM is installed, it will prompt the BIOS to set the system into power saving mode after all tasks are done.

The options are: Yes (Default), No.

Video Off Option

This feature provides the selections for the video display power saving mode. The option "Susp, Stby → Off" allows the video display to go blank if the system enters Suspend or Standby mode. The option "Suspend → Off" allows the video display to go blank if the system enters Suspend mode. The option "All Modes → Off" allows the video display to go blank if the system enters Doze mode or Suspend mode. The option "Always On" allows the video display to stay in Standby mode even when the system enters Doze or Suspend mode.

The options are: Susp, Stby → Off (Default), Suspend → Off, All Modes → Off, Always On.

Video Off Method

"DPMS Supported" allows the BIOS to blank off the screen display with your VGA card which supports DPMS (Display Power Management Signaling function). "Blank Screen" allows the BIOS to blank the screen display by turning off the red-green-blue signals.

The options are: DPMS Supported (Default), Blank Screen.

MODEM Use IRQ

This feature allows you to select the IRQ# to meet your modem's IRQ#.

The options are: 3 (Default), 4, 5, 7, 9, 10, 11, NA.

Doze Mode

The system will not enter Doze mode, because this option is designated as "Disabled".

Standby Mode

The system will not enter Standby mode, because this option is designated as "Disabled".

Suspend Mode

The system will not enter Suspend mode, because this option is designated as "Disabled".

HDD POWER Down

Selecting "Disabled" will turn off the hard disk drive (HDD) motor. Selecting "1 Min.. 15 Min" allows you to define the HDD idle time before the HDD enters Power Saving Mode.

The options "1 Min.. 15 Min" and "When Suspend" will not work concurrently. When the HDD is in Power Saving Mode, any access to the HDD will wake it up.

The options are: Disabled (Default), 1 Min., 15 Min.

PNP OS Installed

Select Yes if the installed system supports the PnP function. Select No if the installed system does not support the PnP function.

The options are: No (Default), Yes.

*Note: Under certain operating systems such as Windows NT 4.0 (Build 1381), the CD auto-insertion feature might have some effect on power management. It is recommended that the CD-ROM drive use the secondary channel, and that the following Power Management Setup features be set:
HDD & FDD: Off
IRQ15 (Reserved): Secondary*

9.7 PNP/PCI Configuration Setup

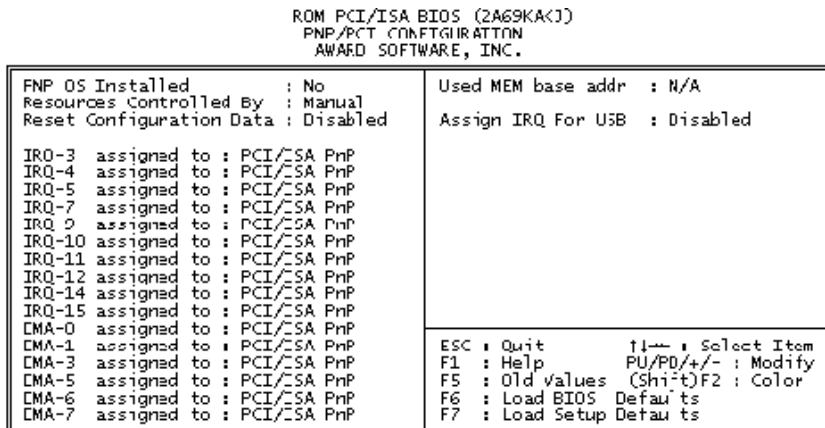

Figure 9-6: PNP/PCI configuration setup screen

PNP OS Installed

Select Yes if the installed system supports the PnP function. Select No if the installed system does not support the PnP function.

The options are: No (Default), Yes.

Resources Controlled By

If set at "Auto", the BIOS automatically arranges all system resources for you. If there are conflicts or you are not satisfied with the configuration, simply set all the resources listed in the above figure by selecting "Manual".

The options are: Manual (Default), Auto.

The manual options assigned to IRQ-/DMA- are: Legacy ISA, PCI/ISA PnP.

Reset Configuration Data

When enabled, this feature allows the system to clear the last BIOS configuration data and then reset the data with the default BIOS configuration data.

The options are: Disabled (Default), Enabled.

Used MEM base addr

Choose and use the MEM base address.

The options are: N/A (Default), C800 ~ DC00.

Assign IRQ for USB

Assigns an IRQ for the USB.

The options are: Disabled (Default), Enabled.

9.8 Load BIOS Defaults

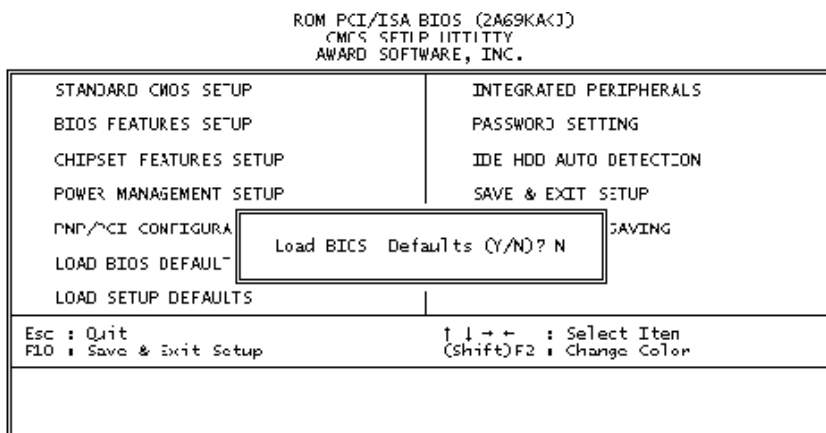

Figure 9-7: Load BIOS defaults screen

The BIOS defaults screen contains the most appropriate values of the system parameters that allow minimum system performance.

9.9 Load Setup Defaults

Selecting this field loads the factory defaults for BIOS and Chipset Features. The system will automatically detect these defaults.

9.10 Integrated Peripherals



Figure 9-8: Integrated peripherals screen

IDE HDD Block Mode

This allows your hard disk controller to use the fast block mode to transfer data to and from your hard disk drive (HDD).

The options are: Enabled (Default), Disabled.

IDE Primary/Secondary Master/Slave PIO

IDE hard disk drive controllers can support up to separate hard drives.

These drives have a master/slave relationship which is determined by the cabling configuration used to attach them to the controller. Your system supports two IDE controllers - a primary and a secondary - so you have the ability to install up to four separate hard disks.

PIO means Programmed Input/Output. Rather than having the BIOS issue a series of commands to effect a transfer to or from the disk drive, PIO allows the BIOS to tell the controller what it wants and then let the controller and the CPU perform the task by themselves.

Your system supports five modes, numbered from 0 through 4, which differ primarily in timing. When "Auto" is selected, the BIOS will choose the best available mode.

The options are: Auto, (Default), Disabled.

Primary/Secondary Master/Slave Ultra DMA

DMA means Direct Memory Access. Ultra DMA is faster than DMA. DMA is a method of transferring data to or from memory at a fast rate, without involving the CPU.

When you select "Auto", the BIOS will choose the best available mode.

The options are: Auto (Default), Disabled.

Onboard FDD Controller

When enabled, the floppy disk drive (FDD) controller is activated.

The options are: Enabled (Default), Disabled.

Onboard Serial Ports 1 & 2

If the serial ports use the onboard I/O controller, you can modify your serial port address.

The options for Port 1 are: 3F8 (Default), 2E8, Disabled, 2F8, 3E8.

The options for Port 2 are: 2F8/IRQ3 (Default), 3E8/IRQ4, 2E8/IRQ3, Disabled, 3F8/IRQ4.

Onboard Serial Ports 3 & 4

If the serial ports use the onboard I/O controller, you can modify your serial port address.

The options for Port 3 are: 3E8 (Default), 2E8, 2F8, 3F8, Disabled.

The options for Port 4 are: 2E8 (Default), Disabled, 3E8, 2F8, 3F8.

Onboard Parallel Port

If the parallel port uses the onboard I/O controller, you can modify your parallel port parameters. When you select "Disabled", the next two setup items will disappear.

The options are: 378/IRQ7 (Default), 3BC/IRQ7, 278/IRQ5, Disabled.

Parallel Port Mode

You can choose different data transfer modes for your system.

The options are: ECP & EPP (Default), SPP, EPP, ECP.

ECP Mode Use DMA

You can choose different DMA modes for data transfer.

The options are: 3 (Default), 1.

Serial Port 1/2/3/4 IRQ

The IRQ of serial port 1/2/3/4 can share the same one or not.

The options are: 4/3/10/5(default), 4/3/3/3, 4/3/10/10, 4/3/4/3, share 3, share 3, share 4, share 5, share 10 (share IRQ is reserved).

Vector Hi/Low select (Reserved)

You can select the interrupt vector level.

The options are: low (default), high

Vector Address Decoder (Reserved)

You can choose the interrupt vector address, the default is 200.

9.11 Password Setting

To enable the password setting, select the item from the Standard CMOS Setup. You will be prompted to create your own password. Type your password up to eight characters and press "Enter". You will be asked to confirm the password. Type the password again and press "Enter". You may also press "Esc" to abort the selection and not enter a password. To disable the password, press "Enter" when you are prompted to enter the password. A message will appear, confirming the password is disabled.

Under the BIOS Features setup, if "System" is selected under the Security Option field and the Supervisor Password is enabled, you will be prompted for the supervisor password every time you try to enter the

CMOS Setup utility. If "System" is selected and User Password is enabled, you will be requested to enter the user password every time you reboot the system. If "Setup" is selected under the Security Option field and User Password is enabled, you will be prompted only when you reboot the system.

9.12 IDE HDD Auto Detection

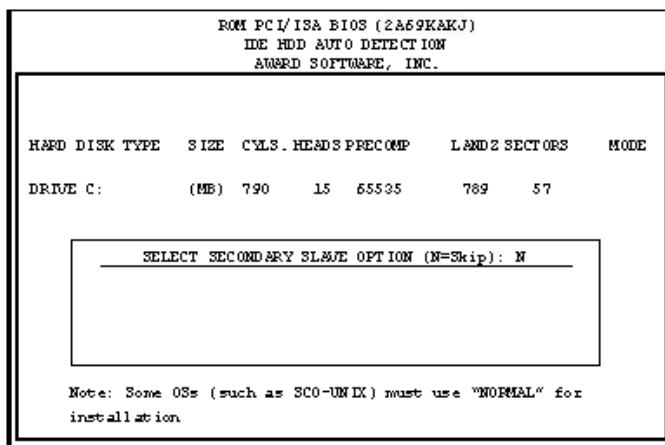

Figure 9-9: IDE HDD auto detection screen

The IDE Hard Disk Drive Auto Detection feature automatically configures your new hard disk. Use it for quick configuration of new hard disk drives. This feature allows you to set the parameters of up to four IDE HDDs. The option with "(Y)" is recommended by the system BIOS. You may also key in your own parameters instead of setting them according to the system BIOS. After keying in all settings, press "Esc" to return to the main menu. For confirmation, enter the Standard CMOS Setup feature.

9.13 Save and Exit Setup

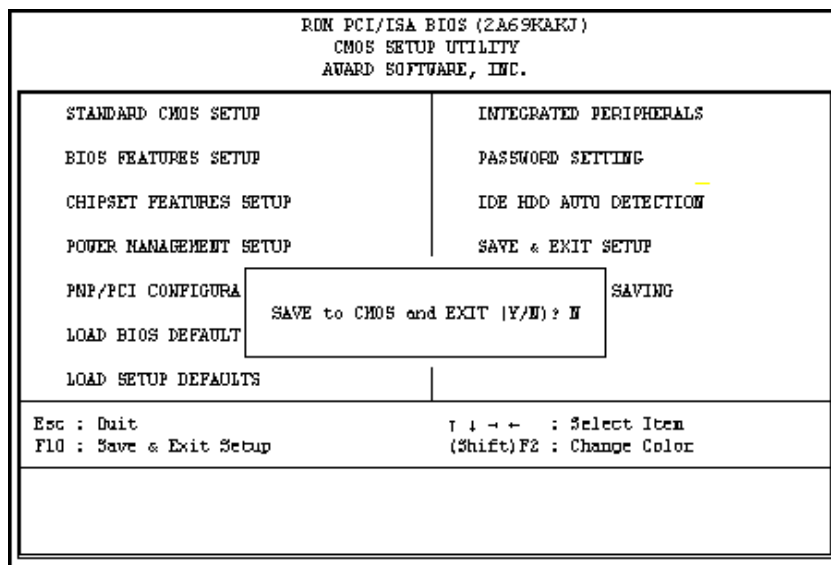

Figure 9-10: Save and exit setup screen

After you have made changes in the BIOS setup, press "Esc" to return to the main menu. Move the cursor to "Save and Exit Setup", or press "F10" and then press "Y", to change the CMOS Setup. If you did not change anything, press "Esc" again or move the cursor to "Exit Without Saving" and press "Y" to retain the setup settings. The following message will appear at the center of the screen to allow you to save data to CMOS and exit the setup utility:

SAVE to CMOS and EXIT (Y/N)?

9.14 Exit Without Saving

If you select this feature, the following message will appear at the center of the screen to allow you to exit the setup utility without saving CMOS modifications:

Quit Without Saving (Y/N) ?

APPENDIX

A

LCD Specifications and Selection Settings

Table A-1: IPPC-9120/9150 Series LCD specifications

Model	IPPC-9120T	IPPC-9150T
Display type (LCD)	12.1" TFT LCD	15" TFT LCD
Max. resolution	800 x 600	1024 x 768
Colors	256 K colors	256 K colors
Dot pitch (mm)	0.31 x 0.31	0.29 x 0.29
Viewing angle	100°(H),120°(V)	100°(H),120°(V)
Luminance	250 cd/sq meter	250 cd/sq meter
Viewing area	246 x 184.5 mm	304 x 228 mm
Power consumption	+5 V @ 1 A max.	+5 V @ 1 A max.
Operating temperature	0° ~ 50° C	0° ~ 50° C
Storage temperature	-20° ~ 60° C	-20° ~ 60° C
LCD MTBF	50,000 hours	50,000 hours
Backlight MTBF	25,000 hours	25,000 hours

Note: The color LCD display installed in the IPPC-9120/9150 Series is high-quality and reliable. However, it may contain a few defective pixels which may not always illuminate. With current technology, it is impossible to completely eliminate defective pixels. Advantech is actively working to improve this technology.

APPENDIX B

Programming the Watchdog Timer

The IPPC-9120/9150 is equipped with a watchdog timer that resets the CPU or generates an interrupt if processing comes to a standstill for any reason. This feature ensures system reliability in industrial standalone or unmanned environments.

B.1 Programming the Watchdog Timer

To program the watchdog timer, you must write a program which writes I/O port address 443 (hex). The output data is a time interval value. The value range is from 01 (hex) to 3E (hex), and the related time interval is from 1 sec. to 62 sec.

Data	Time Interval
-------------	----------------------

01	1 sec.
----	--------

02	2 sec.
----	--------

03	3 sec.
----	--------

04	4 sec.
----	--------

•	•
---	---

•	•
---	---

•	•
---	---

3E	62 sec.
----	---------

After data entry, your program must refresh the watchdog timer by rewriting the I/O port 443 (hex) while simultaneously setting it. When you want to disable the watchdog timer, your program should read I/O port 443 (hex).

The following example shows how you might program the watchdog timer in BASIC:

```
10      REM  Watchdog timer example program
20      OUT &H443, data REM  Start and restart the
      watchdog
30      GOSUB 1000 REM  Your application task #1,
40      OUT &H443, data REM  Reset the timer
50      GOSUB 2000 REM  Your application task #2,
60      OUT &H443, data REM  Reset the timer
70      X=INP (&H443) REM, Disable the watchdog timer
80      END

1000     REM  Subroutine #1, your application task
      .
      .
      .
1070     RETURN
2000     REM  Subroutine #2, your application task
      .
      .
      .
2090     RETURN
```

APPENDIX
C

Pin Assignments

- AT Power Connector (J1)
- TV Output Connector (J2) (*Reserved)
- Inverter Power Connector (J4)
- Internal Speaker Connector (J6)
(Reserved)
- Touchscreen Power Connector (J7)
- Front Panel Control Connector (J8)
(Reserved)
- IR Connector (J9) (Reserved)
- Flat Panel Display Connector (CN2)
- Flat Panel Display Connector (CN3)
- PanelLink Interface (CN4) (Reserved)
- Floppy Drive Connector (CN10)
- Internal COM4 Connector (CN15)
- EIDE Hard Disk Drive Connector
(CN16)
- CD-ROM Connector (CN18)
- CPU Fan Power Connector (FAN1)
- System Fan Power Connector (FAN2)
- PCI/ISA Expansion Connector
(SLOT1)
- COM2

C.1 AT Power Connector (J1)

TableCD-1: AT power connector (J1)

Pin	Signal
1	PS_NO #
2	+5 VSB
3	+12 V
4	-12 V
5	GND
6	GND
7	GND
8	GND
9	-5 V
10	+5 V
11	+5 V
12	+5 V

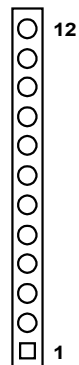

C.2 TV Output Connector (J2) (*Reserved)

Table C-2: TV output connector (J2)

Pin	Signal
1	Y
2	C
3	GND
4	GND
5	CVBS



C.3 Inverter Power Connector (J4)

Table C-3: Inverter power connector (J4)

Pin	Signal
1	+12 V
2	GND
3	ENABKL
4	Brightness Adj.
5	+5 V

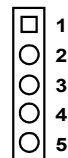

C.4 Internal Speaker Connector (J6) (*Reserved)

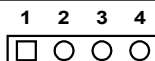

Table C-4: Internal speaker connector (J6)

Pin	Signal
1	Speaker out_R -
2	Speaker out_R +
3	Speaker out_L +
4	Speaker out_L -

C.5 Front Panel Control Connector (J8) (*Reserved)

Table C-5: Front panel control connector (J8) (*Reserved)

Pin	Signal
1	Vcc
2	GND
3	HDD LED
4	Reset SW
5	Power SW
6	NC



C.6 IR Connector (J9) (*Reserved)

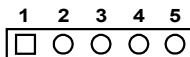

Table C-6: IR connector (J9) (Reserved)

Pin	Signal
1	V _{CC}
2	NC
3	IR_IN
4	GND
5	IR_OUT

C.7 Flat Panel Display Connector (CN2)

Table C-7: Flat panel display connector (CN2)

Pin	Signal	Pin	Signal
1	VDDSAFE5	2	VDDSAFE5
3	GND	4	GND
5	VDDSAFE3	6	VDDSAFE3
7	Vcon	8	GND
9	P0	10	P1
11	P2	12	P3
13	P4	14	P5
15	P6	16	P7
17	P8	18	P9
19	P10	20	P11
21	P12	22	P13
23	P14	24	P15
25	P16	26	P17
27	P18	28	P19
29	P20	30	P21
31	P22	32	P23
33	GND	34	GND
35	SHFCLK	36	FLM
37	M/DE	38	LP
39	ENABKL	40	ENAVEE

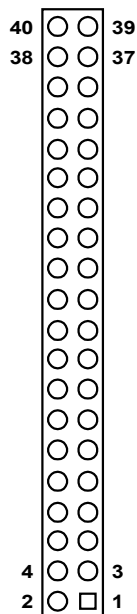

C.8 Flat Panel Display Connector (CN3)

Table C-8: Flat panel display connector (CN3)

Pin	Signal	Pin	Signal
1	VDDSAFE5	2	VDDSAFE5
3	GND	4	GND
5	VDDSAFE3	6	VDDSAFE3
7	Vcon	8	GND
9	P24	10	P25
11	P26	12	P27
13	P28	14	P29
15	P30	16	P31
17	P32	18	P33
19	P34	20	P35
21	NC	22	NC
23	NC	24	NC
25	NC	26	NC
27	NC	28	NC
29	NC	30	NC
31	NC	32	NC
33	GND	34	GND
35	SHFCLK	36	FLM
37	M/DE	38	LP
39	ENABKL	40	ENAVEE

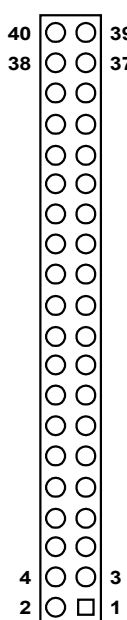

C.9 PanelLink Interface (CN4) (*Reserved)

Table C-9: PanelLink Interface (CN4) (*Reserved)

Pin	Signal	Pin	Signal
1	TXC-	11	TX1+
2	GND	12	NC
3	TXC+	13	TX2-
4	GND	14	NC
5	TX0-	15	TX2+
6	GND	16	EDGE
7	TX0+	17	2NDSDA
8	GND	18	Vcc
9	TX1-	19	2NDSCL
10	NC	20	GND

C.10 Floppy Drive Connector (CN10)

Table C-10: Floppy drive connector (CN10)

Pin	Signal	Pin	Signal
1	V _{CC} (+5 V)	14	STEP
2	INDEX	15	GND
3	V _{CC} (+5 V)	16	WRITE ENABLE
4	DRIVE SELECT	17	GND
5	V _{CC} (+5 V)	18	WRITE DATA
6	DISK CHANGE	19	GND
7	NC	20	TRACK 0
8	NC	21	GND
9	NC	22	WRITE PROTECT
10	MOTOR ON	23	GND
11	NC	24	READ DATA
12	DIRECTION	25	GND
13	DENSITY SELECT	26	SIDE 1 SELECT



C.11 Internal COM4, mouse and touch screen power connector (CN23)

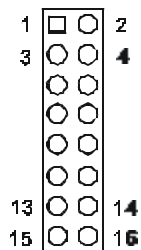

Table C-11: Internal COM4, mouse and touch screen power connector (CN23)

Pin	Signal	Pin	Signal
1	NRLSD	2	DSR
3	NRX	4	RTS
5	NTX	6	CTS
7	NDTR	8	RI
9	GND	10	GND
11	MSDAT	12	EXT MSDAT
13	MSCLK	14	EXT MSCLK
15	V _{cc}	16	V _{cc}

C.12 EIDE Hard Disk Drive Connector (CN16)

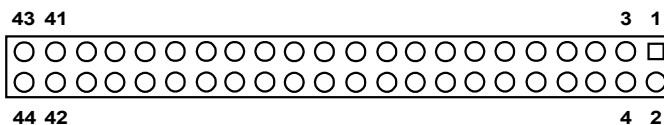

Table C-12: EIDE hard disk drive connector (CN16)

Pin	Signal	Pin	Signal
1	IDE RESET #	2	GND
3	DATA 7	4	DATA 8
5	DATA 6	6	DATA 9
7	DATA 5	8	DATA 10
9	DATA 4	10	DATA 11
11	DATA 3	12	DATA 12
13	DATA 2	14	DATA 13
15	DATA 1	16	DATA 14
17	DATA 0	18	DATA 15
19	SIGNAL GND	20	N/C
21	HDD DREQ	22	GND
23	IO WRITE	24	GND
25	IO READ	26	GND
27	HD READY	28	CABLE SELECT
29	HDACK 0 #	30	GND
31	IRQ14	32	N/C
33	ADDR 1	34	N/C
35	ADDR 0	36	ADDR 2
37	HDD SELECT 0 #	38	HDD SELECT 1 #
39	IDE ACTIVE 0 #	40	GND
41	V _{cc}	42	V _{cc}
43	GND	44	N/C

low active

C.13 CD-ROM Connector (CN18)

Table C-13: CD-ROM connector (CN18)

Pin	Signal	Pin	Signal
1	Audio_L	2	Audio_R
3	GND	4	GND
5	IDE RESET #	6	DATA8
7	DATA7	8	DATA9
9	DATA6	10	DATA10
11	DATA5	12	DATA11
13	DATA4	14	DATA12
15	DATA3	16	DATA13
17	DATA2	18	DATA14
19	DATA1	20	DATA15
21	DATA0	22	HDD DREQ
23	GND	24	IO READ
25	IO WRITE	26	GND
27	HD READY	28	HD ACK 0 #
29	IRQ 15	30	NC
31	ADDR1	32	NC
33	ADDR0	34	ADDR2
35	HDD SELECT 0 #	36	HDD SELECT 1 #
37	V _{cc} (+5 V)	38	V _{cc} (+5 V)
39	GND	40	GND

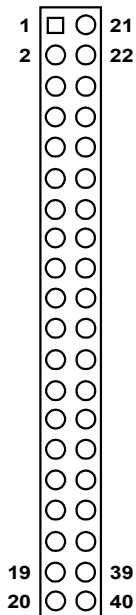

low active

C.14 CPU Fan Power Connector (FAN1)

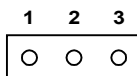

Table C-14: CPU fan power connector (FAN1)

Pin	Signal
1	GND
2	+12 V
3	FAN_DET

C.15 System Fan Power Connector (FAN2)

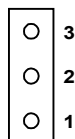

Table C-15: Fan power connector (FAN2)

Pin	Signal
1	GND
2	+12 V
3	FAN_DET

C.16 PCI/ISA Bus Expansion Connector (SLOT1)

side view

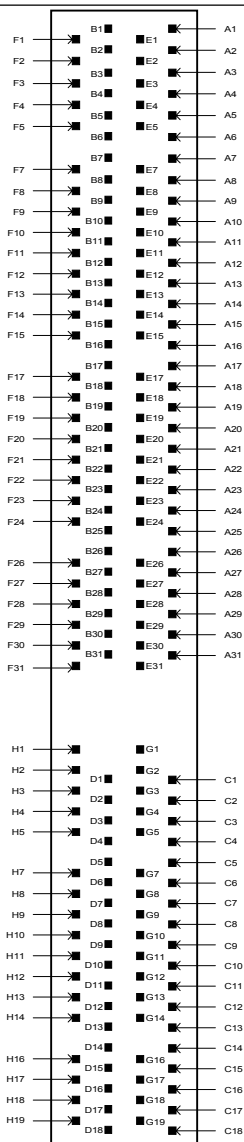

Table C-16: PCI/ISA slot pin assignments (Pins A and B)

Pin	Signal	Pin	Signal
A1	IOCHK	B1	GND
A2	SD7	B2	RST
A3	SD6	B3	V _{CC}
A4	SD5	B4	IRQ9
A5	SD4	B5	NC
A6	SD3	B6	DRQ2
A7	SD2	B7	-12 V
A8	SD1	B8	OWS
A9	SD0	B9	+12 V
A10	IORDY	B10	GND
A11	AEN	B11	SMW
A12	SA19	B12	SMR
A13	SA18	B13	IOW
A14	SA17	B14	IOR
A15	SA16	B15	DACK3
A16	SA15	B16	DRQ3
A17	SA14	B17	DACK1
A18	SA13	B18	DRQ1
A19	SA12	B19	REF
A20	SA11	B20	SCLK
A21	SA10	B21	IRQ7
A22	SA9	B22	IRQ6
A23	SA8	B23	IRQ5
A24	SA7	B24	IRQ4
A25	SA6	B25	IRQ3
A26	SA5	B26	DACK2
A27	SA4	B27	TC
A28	SA3	B28	ALE
A29	SA2	B29	V _{CC}
A30	SA1	B30	OSC
A31	SA0	B31	GND

Table C-17: PCI/ISA slot pin assignments (Pins C and D)

Pin	Signal	Pin	Signal
C1	SBHE	D1	MEM16
C2	LA23	D2	IO16
C3	LA22	D3	IRQ10
C4	LA21	D4	IRQ11
C5	LA20	D5	IRQ12
C6	LA19	D6	IRQ15
C7	LA18	D7	IRQ14
C8	LA17	D8	DACK0
C9	MEMR	D9	DRQ0
C10	MEMW	D10	DACK5
C11	SD8	D11	DRQ5
C12	SD9	D12	DACK6
C13	SD10	D13	DRQ6
C14	SD11	D14	DACK7
C15	SD12	D15	DRQ7
C16	SD13	D16	V _{CC}
C17	SD14	D17	MASTER
C18	SD15	D18	GND

Table C-18: PCI/ISA slot pin assignments (Pins E and F)

Pin	Signal	Pin	Signal
E1	GND	F1	GND
E2	GND	F2	GND
E3	INT 1	F3	INT3
E4	INT 2	F4	INT4
E5	V _{CC}	F5	V _{CC}
E6	---	F6	---
E7	V _{CC}	F7	V _{CC}
E8	RST	F8	PCLK2
E9	GNT2	F9	(V)
E10	REQ2	F10	GNT3
E11	GND	F11	GND
E12	PCLK1	F12	REQ3
E13	GND	F13	AD31
E14	AD30	F14	AD29
E15	NC	F15	NC
E16	---	F16	---
E17	NC	F17	NC
E18	AD28	F18	AD27
E19	AD26	F19	AD25
E20	AD24	F20	CBE3
E21	AD22	F21	AD23
E22	AD20	F22	AD21
E23	AD18	F23	AD19
E24	NC	F24	NC
E25	---	F25	---
E26	---	F26	NC
E27	AD16	F27	AD17
E28	FRAME	F28	IRDY
E29	CBE2	F29	DEVSEL
E30	TRDY	F30	LOCK
E31	STOP	F31	PERR

Table C-19: PCI/ISA slot pin assignments (Pins G and H)

Pin	Signal	Pin	Signal
G1	---	H1	SERR
G2	---	H2	AD15
G3	CBE1	H3	AD14
G4	PAR	H4	AD12
G5	GND	H5	GND
G6	---	H6	KEY
G7	GND	H7	GND
G8	AD13	H8	AD10
G9	AD11	H9	AD8
G10	AD9	H10	AD7
G11	CBEO	H11	AD5
G12	AD6	H12	AD3
G13	AD4	H13	AD1
G14	AD2	H14	AD0
G15	---	H15	KEY
G16	V _{CC}	H16	V _{CC}
G17	V _{CC}	H17	V _{CC}
G18	GND	H18	GND
G19	GND	H19	GND

C.17 COM2

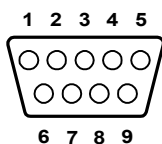

Table C-20: COM2

Pin	Signal	RS-422	RS-485
	RS-232		
1	DCD	TX-	DATA-
2	RX	TX+	DATA+
3	TX	RX+	---
4	DTR	RX-	---
5	GND	GND	---
6	DSR	---	---
7	RTS	---	---
8	CTS	---	---
9	RI	---	---
