

IPPC-6172F Series

**17" SXGA TFT LCD Celeron M
Fanless Industrial Panel PC
with 2 x PCI Slots**

User Manual

VICPAS
HMI Parts Center

Copyright

The documentation and the software included with this product are copyrighted 2008 by Advantech Co., Ltd. All rights are reserved. Advantech Co., Ltd. reserves the right to make improvements in the products described in this manual at any time without notice. No part of this manual may be reproduced, copied, translated or transmitted in any form or by any means without the prior written permission of Advantech Co., Ltd. Information provided in this manual is intended to be accurate and reliable. However, Advantech Co., Ltd. assumes no responsibility for its use, nor for any infringements of the rights of third parties, which may result from its use.

Acknowledgements

Intel and Pentium are trademarks of Intel Corporation.

Microsoft Windows and MS-DOS are registered trademarks of Microsoft Corp.

All other product names or trademarks are properties of their respective owners.

Part No. 2003617210

1st Edition

Printed in Taiwan

November 2008

Product Warranty (2 years)

Advantech warrants to you, the original purchaser, that each of its products will be free from defects in materials and workmanship for two years from the date of purchase.

This warranty does not apply to any products which have been repaired or altered by persons other than repair personnel authorized by Advantech, or which have been subject to misuse, abuse, accident or improper installation. Advantech assumes no liability under the terms of this warranty as a consequence of such events.

Because of Advantech's high quality-control standards and rigorous testing, most of our customers never need to use our repair service. If an Advantech product is defective, it will be repaired or replaced at no charge during the warranty period. For out-of-warranty repairs, you will be billed according to the cost of replacement materials, service time and freight. Please consult your dealer for more details.

If you think you have a defective product, follow these steps:

1. Collect all the information about the problem encountered. (For example, CPU speed, Advantech products used, other hardware and software used, etc.) Note anything abnormal and list any onscreen messages you get when the problem occurs.
2. Call your dealer and describe the problem. Please have your manual, product, and any helpful information readily available.
3. If your product is diagnosed as defective, obtain an RMA (return merchandize authorization) number from your dealer. This allows us to process your return more quickly.
4. Carefully pack the defective product, a fully-completed Repair and Replacement Order Card and a photocopy proof of purchase date (such as your sales receipt) in a shippable container. A product returned without proof of the purchase date is not eligible for warranty service.
5. Write the RMA number visibly on the outside of the package and ship it prepaid to your dealer.

Declaration of Conformity

CE

This product has passed the CE test for environmental specifications. Test conditions for passing included the equipment being operated within an industrial enclosure. In order to protect the product from being damaged by ESD (Electrostatic Discharge) and EMI leakage, we strongly recommend the use of CE-compliant industrial enclosure products.

FCC Class A

Note: This equipment has been tested and found to comply with the limits for a Class A digital device, pursuant to part 15 of the FCC Rules. These limits are designed to provide reasonable protection against harmful interference when the equipment is operated in a commercial environment. This equipment generates, uses, and can radiate radio frequency energy and, if not installed and used in accordance with the instruction manual, may cause harmful interference to radio communications. Operation of this equipment in a residential area is likely to cause harmful interference in which case the user will be required to correct the interference at his own expense.

Technical Support and Assistance

- Step 1. Visit the Advantech web site at **www.advantech.com/support** where you can find the latest information about the product.
- Step 2. Contact your distributor, sales representative, or Advantech's customer service center for technical support if you need additional assistance. Please have the following information ready before you call:
 - Product name and serial number
 - Description of your peripheral attachments
 - Description of your software (OS, version, software, etc.)
 - A complete description of the problem
 - The exact wording of any error messages

Safety Instructions

1. Read these safety instructions carefully.
2. Keep this User's Manual for later reference.
3. Disconnect this equipment from any AC outlet before cleaning. Use a damp cloth. Do not use liquid or spray detergents for cleaning.
4. For plug-in equipment, the power outlet socket must be located near the equipment and must be easily accessible.
5. Keep this equipment away from humidity.
6. Put this equipment on a reliable surface during installation. Dropping it or letting it fall may cause damage.
7. The openings on the enclosure are for air convection. Protect the equipment from overheating. **DO NOT COVER THE OPENINGS.**
8. Make sure the voltage of the power source is correct before connecting the equipment to the power outlet.
9. Position the power cord so that people cannot step on it. Do not place anything over the power cord.
10. All cautions and warnings on the equipment should be noted.
11. If the equipment is not used for a long time, disconnect it from the power source to avoid damage by transient overvoltage.
12. Never pour any liquid into an opening. This may cause fire or electrical shock.
13. Never open the equipment. For safety reasons, the equipment should be opened only by qualified service personnel.
14. If one of the following situations arises, get the equipment checked by service personnel:
 - a. The power cord or plug is damaged.
 - b. Liquid has penetrated into the equipment.
 - c. The equipment has been exposed to moisture.
 - d. The equipment does not work well, or you cannot get it to work according to the user's manual.
 - e. The equipment has been dropped and damaged.
 - f. The equipment has obvious signs of breakage.

15. DO NOT LEAVE THIS EQUIPMENT IN AN ENVIRONMENT WHERE THE STORAGE TEMPERATURE MAY GO BELOW -40° C OR ABOVE 85° C. THIS COULD DAMAGE THE EQUIPMENT. THE EQUIPMENT SHOULD BE IN A CONTROLLED ENVIRONMENT.

Safety Precaution - Static Electricity

Follow these simple precautions to protect yourself from harm and the products from damage.

1. To avoid electrical shock, always disconnect the power from your PC chassis before you work on it. Don't touch any components on the CPU card or other cards while the PC is on.
2. Disconnect power before making any configuration changes. The sudden rush of power as you connect a jumper or install a card may damage sensitive electronic components.

Contents

Chapter 1	General Information	2
1.1	Introduction	2
1.2	Specifications	3
1.2.1	General	3
1.2.3	Display	4
1.2.4	Audio Functions	4
1.3	Dimensions	5
Chapter 2	System Setup.....	8
2.1	General	8
2.1.1	PS/2 Mouse & Keyboard	8
2.1.2	Parallel Port	9
2.1.3	VGA port	9
2.1.4	Serial COM ports	9
2.1.5	USB ports	10
2.1.6	Audio Interface	10
2.1.7	Ethernet	10
2.2	Installing a 2.5" SATA HDD	11
2.3	Installing Add-on Cards	12
2.4	Installing Power Connector	12
2.5	Mounting Instructions	13
2.5.1	Panel Mounting	13
2.5.2	Rack Mounting	13
Chapter 3	Jumper Settings &Connectors	16
3.1	Jumper Settings	16
3.1.1	Jumpers & Switches	17
3.1.2	Connectors	18
3.1.3	LCD Power Select(JP1)	19
3.1.4	CPU VCCA Power Select (JP2)	20
3.1.5	Measure Battery Current Jumper (JP3)	20
3.1.6	Clear CMOS (JP4)	20
3.1.7	LVDS Mode Select(JP5)	21
3.1.8	Touchscreen Mode Select (JP6)	21
3.1.9	CPU Setting (CN20 and JP2)	22
Chapter 4	Software Configuration	24
4.1	Overview	24
4.2	Utilities and Drivers	24
4.2.1	Installing the IPPC-6172F Watchdog Timer Driver	26
4.2.2	How to Use the IPPC-6172F Watchdog Timer	31
4.2.3	Dual Display Setting	33
4.2.4	Touchscreen Installation & Configuration	34
Chapter 5	Award BIOS Setup.....	36

5.1	Introduction	36
5.2	Entering Setup	37
5.2.1	Standard CMOS Setup	37
5.2.2	Advanced BIOS Features Setup	38
5.2.3	Advanced Chipset Features Setup	42
5.2.4	Integrated Peripherals	44
5.2.5	Power Mangement Setup	48
5.2.6	PNP/PCI Configuration Setup	51
5.2.7	PC Health Status	53
5.2.8	Spread Spectrum Control	54
5.2.9	Load Optimized Defaults	54
5.2.10	Set Password	55
5.2.11	Save & Exit Setup	56
5.2.12	Exit Without Saving	56
Appendix A	IO & Connector Pin Assigns	58
A.1	CN1,CN2 LVDS	58
A.2	CN9 LCD INVERTER	59
A.3	CN12 Touchscreen	59
A.4	CN15/CN17 USB 6,7	60
A.5	CN19,CN21 SATA POWER	60
A.6	CN10 IDE	61
A.7	CN18 Panel Header	61
A.8	CN34 : DB-15 VGA Connector Definitions	62
A.9	CN30 : PS/2 K/b & Mouse Connector Definitions	63
A.10	CN28,CN29 : USB 0,1,2,3 Connector Definitions	63
A.11	10/100/1000Base-TX Ethernet	64
Appendix B	System Assignments	68
B.1	System I/O Ports	68
B.2	DMA Channel Assignments	69
B.3	Interrupt Assignments	69
B.4	1st MB Memory Map	70
B.5	PCI Bus Map	70
Appendix C	Watchdog Timer	72
C.1	Overview	72
C.2	Watchdog Timer Programming	72
C.3	Example Programs	75

General Information

Sections include:

- Introduction
- Specifications
- Dimensions

Chapter 1 General Information

1.1 Introduction

The IPPC-6172F series of industrial panel PCs is especially designed to fit in space-limited environments where expansion is restricted. Its solid-structure enables systems to operate under harsh industrial conditions.

Sturdy Structure

The whole system is protected by a firm solid structure. The front panel is made of sturdy aluminum and has strengthened glass. It is shock resistant, and complies with NEMA4/IP65.

Fanless

By using a low power processor, the system does not have to rely on fans, which are unreliable, and cause dust to circulate inside the equipment.

Economical

The IPPC-6172F motherboard has a Celeron M 1GHz processor, providing an economical yet powerful system. Its reliability enables the system to operate faultlessly in industrial environments.

Friendly HMI

Systems in the IPPC-6172F series are equipped with a 17" LCD screen, which provides high resolution display quality. The result is vivid, bright, and sharp quality images. The panel PC is perfectly suited for Windows OS. The touchscreen version enables simple operation, making the Panel PC a solid industrial digital controller interface. In addition friendly HMI design of the IPPC-6172F series offers front USB access port and reset key for various requirements.

1.2 Specifications

1.2.1 General

Dimensions (W x H x D):

Front Panel: 481.92 x 355.87 x 26 mm

Control Box: 362 x 285 x 112.2 mm

Cut out Dimensions: 457 x 342 mm

Weight: 13 kg (28 lb)

Power Supply: 85W

Input Voltage: 18~30Vdc, 18A

Output Voltage: +3.3V@8A,+5V@10A,+12V@4A,+5Vsb@0.75A,
-12V@1A

Disk Drive Housing: Supports 1 x 2.5" SATA HDD, 1 x slim CD-ROM

1.2.2 Standard PC Functions

CPU: Intel Celeron M ULV 1GHz

BIOS: Award 256KB Flash BIOS

Chipset: Intel 915 GM GMCH/ICH6M

2nd Level Cache: 512KB

RAM: Two 240pin 512MB 533 DRAM

Parallel Port: One parallel port, supports SPP/EPP/ECP parallel mode.
BIOS configurable to LPT1, LPT2, LPT3 or disabled

Serial Ports: One serial port with one RS-232 port (COM1)

Universal Serial Bus (USB) Port: Supports up to 5 USB (2.0) ports.

PCI Bus Expansion Slots: Two expansion slots for PCI cards(total 25W)

Watchdog Timer:255-level interval timer, setup by software, Super I/O
integrated, SMSC controller

Battery: 3.0 V @ 196 mA AH lithium battery

1.2.3 Display

Chipset: Intel 915GM chip integrated Intel Extreme Graphics 2 for 2D/3D video accelerator

Display memory: 128 MB frame buffer using system memory

Display type: Simultaneous support of CRT & flat panel displays (TFT)

Display resolution: LCD displays up to 1280 x 1024 @ 16.7M colors

1.2.4 Audio Functions

Chipset: Integrated in Intel 9151GM ICH6M South Bridge

Audio controller:

AC97 Ver.2.0 compliant interface, Multi stream, Direct sound and Direct Sound 3D acceleration

Stereo sound: 18-bit full-duplex codec

Audio interface:

Microphone-in, line-in, line-out, and game ports MPU-401.

1.2.5 PCI bus Ethernet Interface

One Intel 82573/L PCI Express Controller 10/100/1000Mb LAN support Pre-boot Execution Environment (PXE), One Intel 82562GZ for ICH6M LAN controller 10/100MB

Chipset: Intel 82573/L & Intel 82562GZ local bus.

Ethernet Interface: One Intel 82573/L PCI Express Controller 10/100/1000Mb LAN support Pre-boot Execution Environment (PXE), One Intel 82562GZ for ICH6M LAN controller 10/100MB

1.2.6 Analog Resistive Touchscreen (Optional)

Type: Analog resistive

Resolution: 1024 x 1024

Light Transmission: >80%

Controller: RS-232 interface

Power Consumption: +5.5 V @ 20 mA

Software Drivers: Supports DOS, Win 95/98/Me, Win NT, Win 2000/XP

1.2.7 Environmental

Operating Temperature: 0 ~ 50° C (32 ~ 122° F)

Storage Temperature: -20 ~ 60° C (-4 ~ 140° F)

Relative Humidity: 10 ~ 90% @ 40° C (non-condensing)

Shock: 30 G peak acceleration (11 ms duration)

Power MTBF: 100,000 hrs

Certifications: CE, CCC, FCC Class A, UL, BSMI

1.3 Dimensions

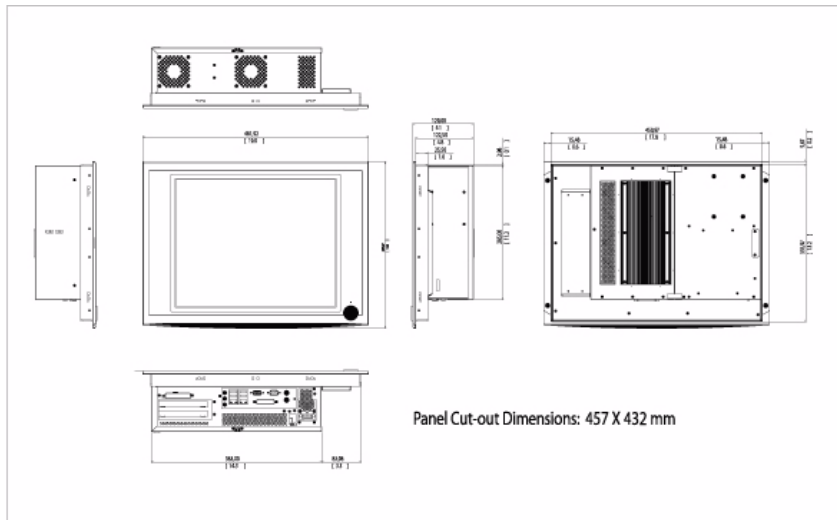

System Setup

Sections include:

- General
- Installing a 2.5" HDD
- Installing Add-on Cards
- Mounting Instructions

Chapter 2 System Setup

2.1 General

Before you start the computer, please follow these procedures for set up:

1. Check and adjust jumpers on the motherboard (see Chapter 3)
2. Install add-on cards
3. Connect the wires, cables and accessories
4. Mount the computer
5. Program the BIOS settings
6. Install an operating system.

Warning:

1. Switch off and unplug every time you access its interior.
2. The motherboard inside the system is composed of many delicate ICs, chips and other integrated circuit components. These components are easily damaged by static shock.

Installing SDRAM module by yourself may cause thermal issue. If needed, pls contact Advantech RMA center.

2.1.1 PS/2 Mouse & Keyboard

If you wish to use a full-size desktop keyboard and PS/2 mouse with your panel PC, follow these instructions:

1. Be sure the panel PC is turned off.
2. Attach the keyboard adapter to the 5-pin green port on the rear bottom side of the rear cover.
3. Attach the mouse adapter to the 5-pin purple port on the rear bottom side of the rear cover.

2.1.2 Parallel Port

IPPC's support the latest EPP and ECP parallel port protocols for improved performance with compatible printers or other devices.

To connect the panel PC to a printer or other devices:

1. Make sure both the panel PC and the printer/devices are turned off.
2. Connect the 25-pin male connector of the printer cable to the 25-pin female port on the panel PC labelled "parallel port."
3. If necessary, attach the other end of your printer cable to your printer, and fasten any retaining screws.
4. Turn on the printer and any other peripheral devices you may have connected to the panel PC. Then turn on the panel PC.
5. If necessary, run the panel PC's BIOS setup program to configure the parallel port to respond as required by your printer and software operating environment.

2.1.3 VGA port

An external VGA-compatible device may be connected to the system via 15-pin external port on the rear of the unit. The panel PC simultaneously supports an external monitor in addition to its own LCD display.

2.1.4 Serial COM ports

There is one serial COM ports on the bottom of the rear cover. You can easily attach a serial device to the panel PC, such as an external modem or mouse. Follow these instructions:

1. Make sure the panel PC and any other peripheral devices you may have connected to the panel PC are turned off.
2. Attach the interface cable of the serial device to the panel PC's serial port. If necessary, attach the other end of the interface cable to your serial device. Fasten any retaining screws.
3. Turn on any other peripheral devices you may have connected to the panel PC, and then turn on the panel PC.
4. Refer to the manual(s) which accompanied your serial device(s) for instructions on configuring your operating environment to recognize the device(s).
5. Run the BIOS setup program to set the I/O address and IRQ, and configure the jumper settings to change the mode of the COM ports (refer to section 3.3).

2.1.5 USB ports

An external USB device may be connected to the system via the 4-pin USB ports located on the rear side of the system unit.

1. Connect the external device to the system.
2. The USB ports support hot plug-in connection. You should install the device driver before you use the device.

2.1.6 Audio Interface

The audio interface includes three jacks: microphone-in, line-out and line-in. Their functions are:

Microphone-in: Use an external microphone to record voice and sound.

Line-out: Output audio to external devices such as speakers or ear-phones. The built-in speaker will not be disabled when the line-out jack is connected to external audio devices.

Line-in: Input audio from an external CD player or radio.

1. Connect the audio device to the system.
2. Install the driver before you use the device.

2.1.7 Ethernet

To install Ethernet for your system:

1. Connect the Ethernet cable.
2. Turn on the panel PC.
3. Run the Ethernet driver to connect up to the network.

2.2 Installing a 2.5" SATA HDD

You can attach one enhanced Serial Advanced Technology Attachment (SATA) hard disk drive to IPPC-6172F's internal controller which uses PCI local bus interface. Please use a wide-temperature industrial hard disk to meet the thermal requirement. The following instructions are for installation:

1. Unscrew the back cover and open it.
2. Remove the two screws and take off CD-ROM, HDD cover.
3. Remove four screws and take off HDD bracket.
4. Insert the HDD into the bracket (see figure)
5. Put the HDD bracket into the Chassis and fasten the four screws.
6. Then attach the HDD flat cable and power cable.
7. Close the rear cover

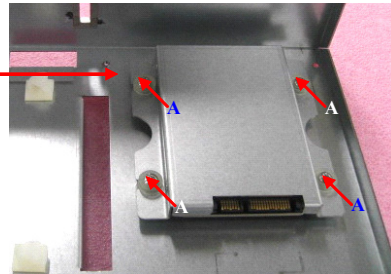
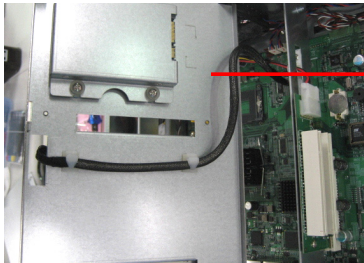

2.3 Installing Add-on Cards

This system supports two PCI expansion cards, total 25w.

1. Detach the five screws on the back to open the lid.
2. Take away the slot bracket.
3. Insert the add-on card, and put on the lid.

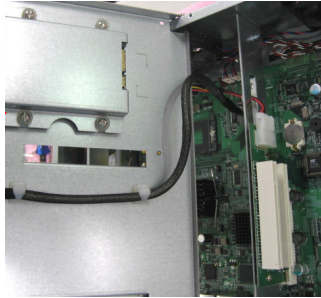

2.4 Installing Power Connector

1. Use the tool from the accessory box in the picture 1
2. Press down to open connector hole and insert power wire



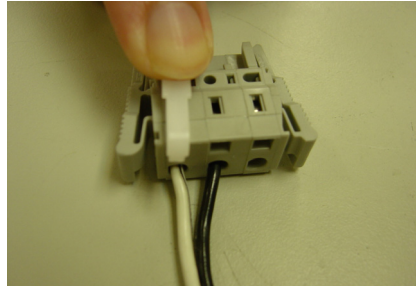
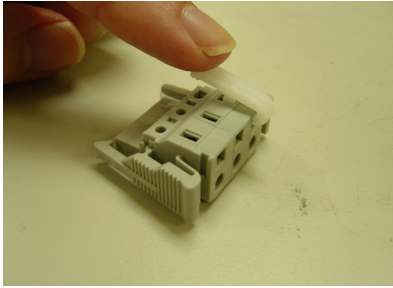

2.5 Mounting Instructions

There are two ways to mount the system: panel mounting or rack mounting.

2.5.1 Panel Mounting

1. Take the four mounting brackets out of the accessory box.
2. Use the screws to secure the brackets to the cover. Tighten the screws to secure the monitor to the back panel.

2.5.2 Rack Mounting

The monitor can be mounted to a 19" industrial rack with an optional bracket.

Jumper Settings & Connectors

Sections include:

- Jumpers Settings

Chapter 3 Jumper Settings & Connectors

3.1 Jumper Settings

This section tells how to set the jumpers to configure your card. For the locations of each jumper, see the board layout diagram depicted earlier in this chapter. You configure your card to match the needs of your application by setting jumpers. A jumper is the simplest kind of electric switch. It consists of two metal pins and a small metal cap (often protected by a plastic cover) that slides over the pins to connect them. To "close" a jumper you connect the pins with the cap. To "open" a jumper you remove the cap. Sometimes a jumper will have three pins, labeled 1, 2 and 3. In this case you connect either pins 1 and 2 or 2 and 3.

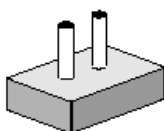

Open

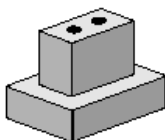

Closed

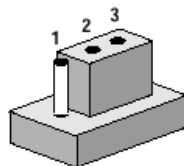

Closed 2-3

The jumper settings are schematically depicted in this manual as follows:



Open



Closed



Closed 2-3

You may find a pair of needle-nose pliers useful for setting the jumpers. If you have any doubts about the best hardware configuration for your application, contact your local distributor or sales representative before you make any changes.

3.1.1 Jumpers & Switches

The motherboard of the IPPC-6172F has a number of jumpers that allow you to configure your system to suit your applications. The table below lists the function of each of the board.s jumpers.

JP1	LCD Power Select	Select LCDPower 3.3V/5V
JP2	Select CPU VCCA	Select CPU VCCA Power 1.5V/1.8V
JP3	Measure Battery	Measure Battery of Current Jumper
JP4	Clear CMOS	Clear CMOS
JP5	LVDS Mode	LVDS Mode Select
JP6	Touchscreen Mode	Touchscreen Mode Select

3.1.2 Connectors

Onboard connectors link the panel PC to external devices such as hard disk drives or floppy drives. The table below lists the function of each of the board.s connectors.

CN1, CN2	LVDS	18/24/36/48 BIT LVDS
CN3, CN4, CN5	FAN CONNECTOR	Wafer 2.54mm 3P 180D(M) FAN CONNECTOR
CN7	ATX POWER CONNECTOR	ATX Power CONN. 10*2P STAND ATX POWER CONNECTOR
CN9	LCD INVERT POWER CONNECTOR	WAFER BOX 2.0mm 7P
CN10	IDE CONNECTOR	CONN. 40P 90D 1.25mm SMD WO/Pb DF13-40DP-1.25V -- SLIM TYPE CD-ROM
CN11	IDE CONNECTOR	BOX HEADER 22*2P 2mm IDE CONNECTOR
CN12	TOUCHSCREEN	WAFER BOX 2.0mm 9P 180D
CN13	CPU SOCKET	Micro-FCPGA 478 /P-M 1.6G,1.8G,2.0G/ C-M 1.5G
CN15/ CN17	USB PORT 6,7	WAFER BOX 2.5mm 5P USB EXT CONNECTOR
CN18	PANEL HEADER	WAFER BOX 2.0mm 9P
CN19/ CN21	SATA POWER CONNECTOR	WAFER BOX 2.5mm 8P
CN20	CPU SETTING JUMPER	PIN HEADER 4*2P 180D(M) 2.0mm SETTING CPU TYPE
CN25	PCI SOLT	PCI 32BIT/33MHZ
CN28	LAN1/USB0/ USB1	PhoneJack RJ45+USB*2 LAN1(10/100Mbase),USB port 0,1 (USB2.0)
CN29	LAN2/USB2/ USB3	PhoneJack RJ45+USB*2 LAN2(10/100/ 1000Mbase),USB port 20,3 (USB2.0)
CN30	PS2	KEYBOARD ,MOUSE
CN31	AUDIO	LINE OUT, LINE IN, MIC IN
CN32	PRINT	D-Sub 25-pin
CN34	CRT	D-Sub 15-pin
CN36	COM1	D-Sub 9-pin
SA1/2	SATA PORT	SerialATA Con 7P 180D(M) Dip 1.27mm

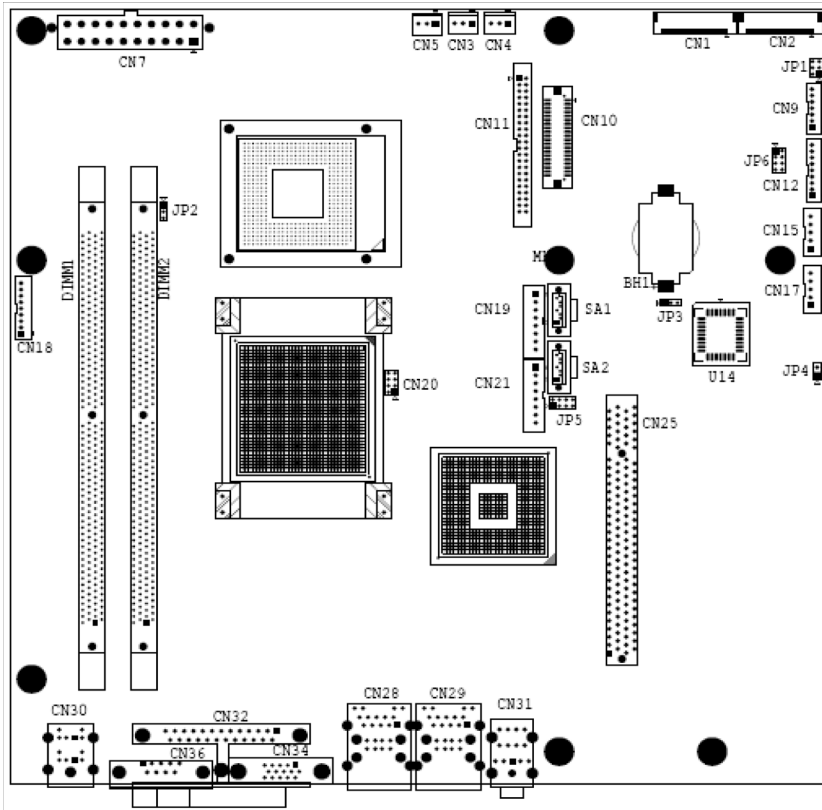



3.1.3 LCD Power Select(JP1)

This jumper is used to select LCD Power is +3.3V or +5V

LCD Power Select JP1	
+3.3V	
+5V	

3.1.4 CPU VCCA Power Select (JP2)

This jumper is used to select VCCA Power is +1.5V or +1.8V

CPU VCCA POWER Selec JP2	
+1.5V	
+1.8V	

3.1.5 Measure Battery Current Jumper (JP3)



This jumper is used measure batter curren

Normal	
Measure Current	Used series connection to Current Meter measure

3.1.6 Clear CMOS (JP4)

This jumper is used to erase CMOS data and reset system BIOS information. Follow the procedures below to clear the CMOS.

1. Turn off the system.
2. Close jumper JP1 (1-2).
3. Turn on the system. The CMOS is now cleared.
4. Turn on the system. The BIOS is reset to its default setting.

Clear CMOS JP4	
Clear	
Normal	



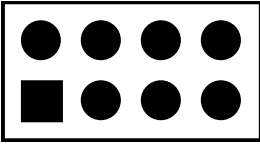
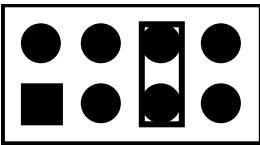
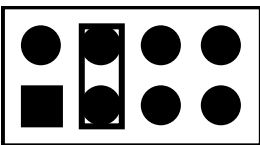

3.1.7 LVDS Mode Select(JP5)

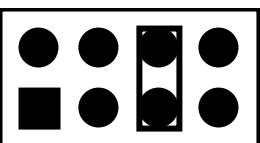
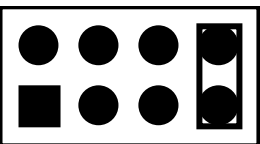
1024 * 768 (24bit)	
800 * 600 (18bit)	
1280 * 1024 (48bit)	

3.1.8 Touchscreen Mode Select (JP6)

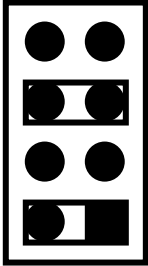
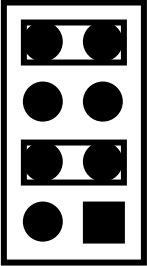
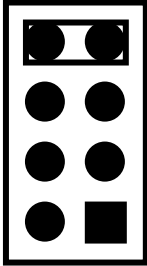
5 wire	
4 or 8 wire	

3.1.9 CPU Setting (CN20 and JP2)

<p>CN20 : CPU Setting</p> <p>JP2 : CPU VCCA Setting</p>		
<p>Dothan</p> 	<p>Banias 533Mhz</p> 	<p>Banias 400MHz</p> 
		

Intel Chipset

Sections include:

- Overview
- Utilities and Drivers
- Dual Display Setting
- Touchscreen Installation & Configuration

Chapter 4 Software Configuration

4.1 Overview

In IPPC-6172F , Advantech provides a CD-ROM with utilities and drivers included. Please install the Chipset INF driver, VGA graphics driver, LAN driver, audio driver, Touch Screen driver , Watchdog Timer (WDT) driver sequentially.

4.2 Utilities and Drivers

The following utilities and drivers are provided with IPPC-6172F. You can also find out the updated description of the utilities and drivers in the ReadMe.txt file on the CD-ROM.

Intel Chipset Software Installation Utility

Path: \INF\

Available for the OS's below,

- Microsoft Windows 2000
- Microsoft Windows XP

VGA Drivers (Intel(R) Graphics Driver)

Path: \VGA\

Available for the OS's below,

- Microsoft Windows 2000
- Microsoft Windows XP

Intel Network Driver

Path: \Lan\

Available for the OS's below,

- Microsoft Windows 2000
- Microsoft Windows XP

Audio Driver

Path: \ audio\

Available for the OS's below,

- Microsoft Windows 2000
- Microsoft Windows XP

Touchscreen Driver

Path: \ Pen mount \

Available for the OS's below,

- Microsoft Windows 2000
- Microsoft Windows XP and more, on the driver CD-ROM.

WatchDog Timer Driver

Path: \WDT\

Available for the OS's below:

- Microsoft Windows 2000
- Microsoft Windows XP

Watchdog Timer (WDT) Driver Installation

In order to ensure reliable and fail-safe performance, IPPC-6172F has a built-in Watchdog Timer to handle unexpected system failures. IPPC-6172F provides the drivers and a utility to activate and configure the timer for Windows2000/XP operating systems. The following is a brief introduction, using Windows2000 as an example, for the installation and configuration procedures.

4.2.1 Installing the IPPC-6172F Watchdog Timer Driver

1. Insert the companion CD-ROM into your CD-ROM drive. Open Path:\WDT

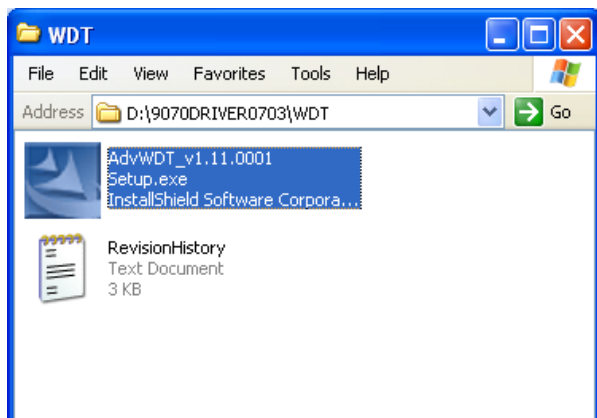

2. Use Windows Explorer (or Windows Run command) to execute SETUP.EXE from the companion CD-ROM.

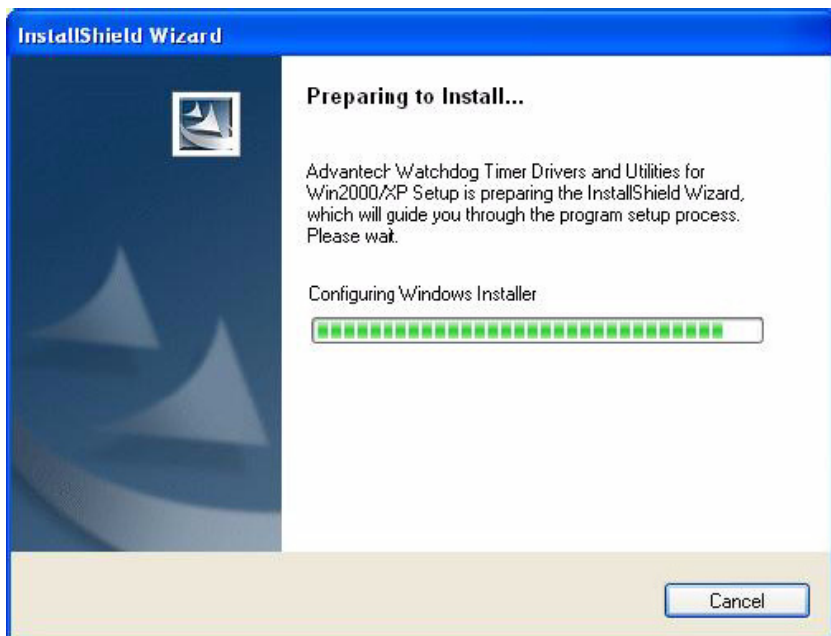

3. Click Next to proceed.

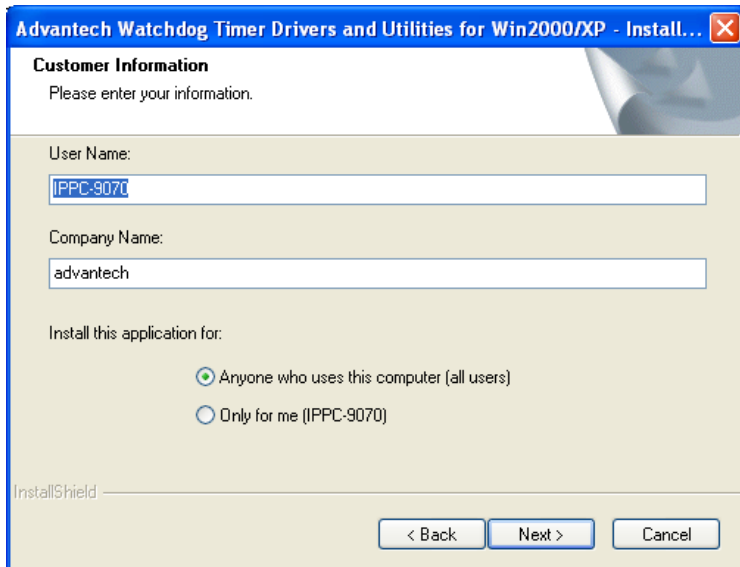

4. Click Next to confirm the customer information.

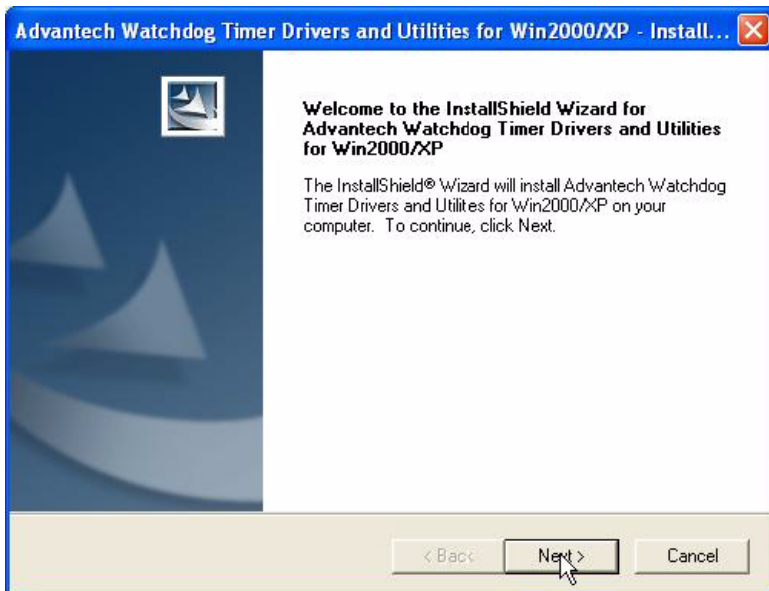

- Select Advantech [W83627HF] Watchdog Timer and click Next.

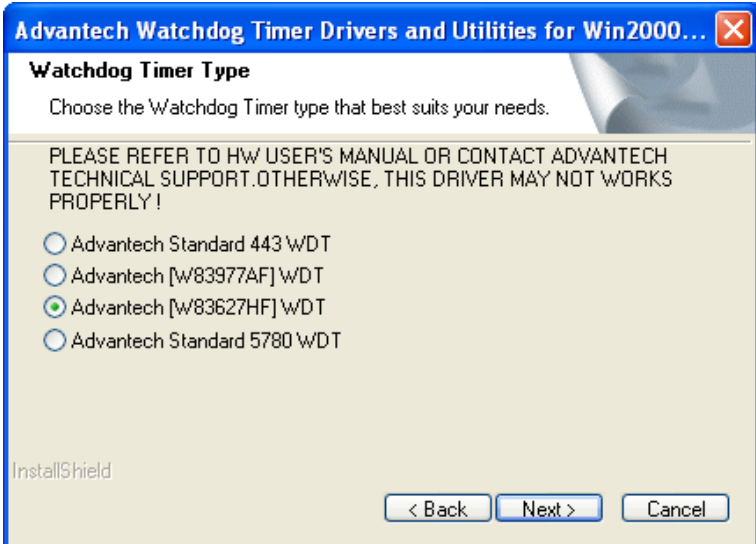

- Click Next to confirm selecting the Typical setup type.

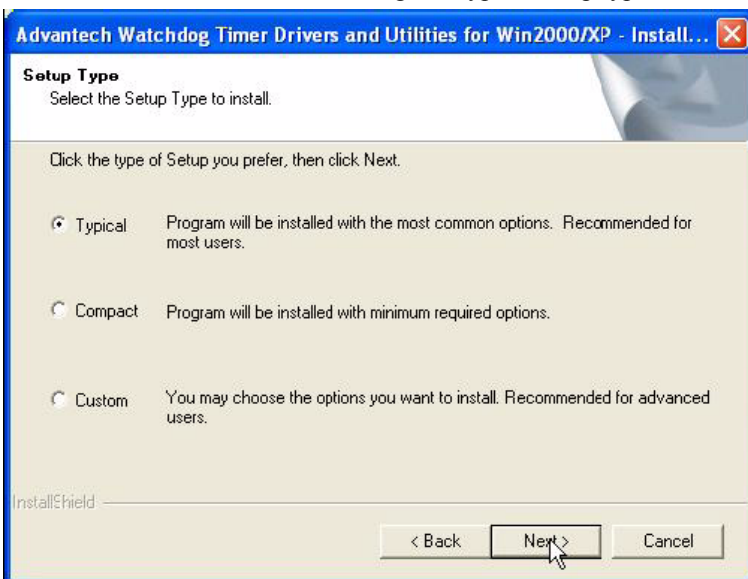

7. Click Next to proceed.

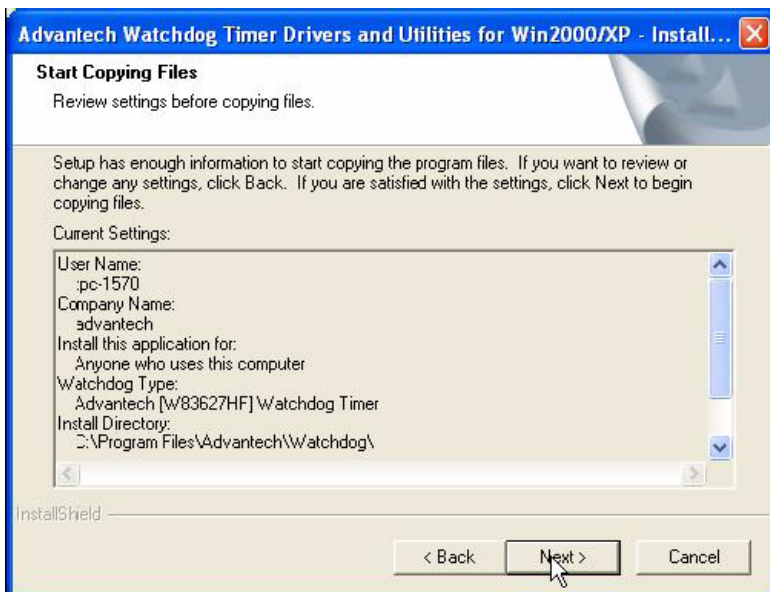

8. Click Finish to complete the procedure.

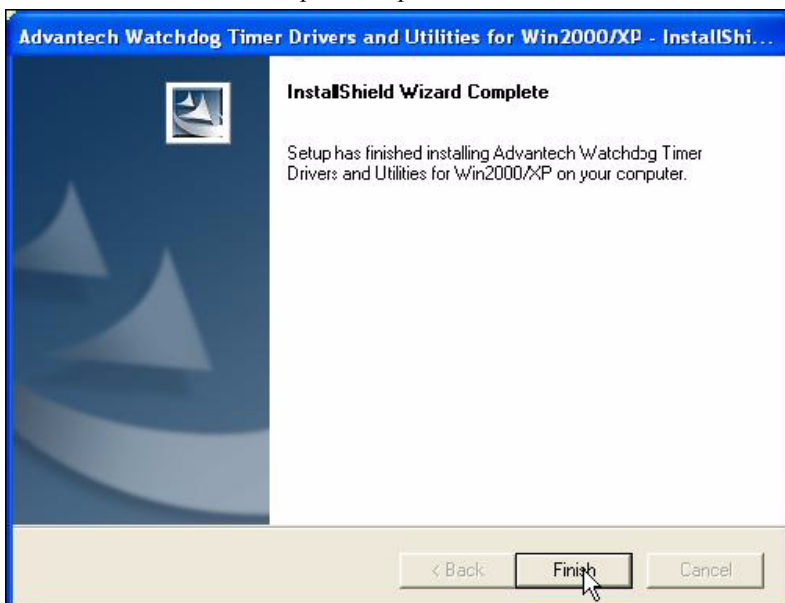

9. Click OK to restart the system and activate the Watchdog Timer.



4.2.2 How to Use the IPPC-6172F Watchdog Timer

1. Open the Control Panel and click Watchdog Service Configuration.



2. Click the Start Service button.

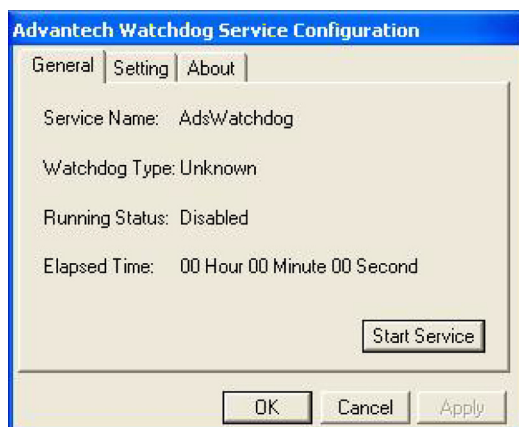

3. Click Setting to select the setting page.

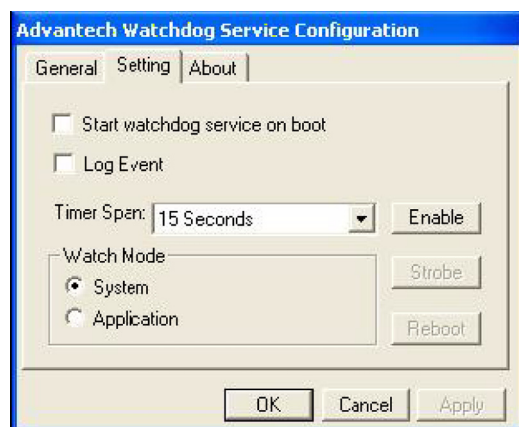

- Select the Timer Span that meets your application requirement.

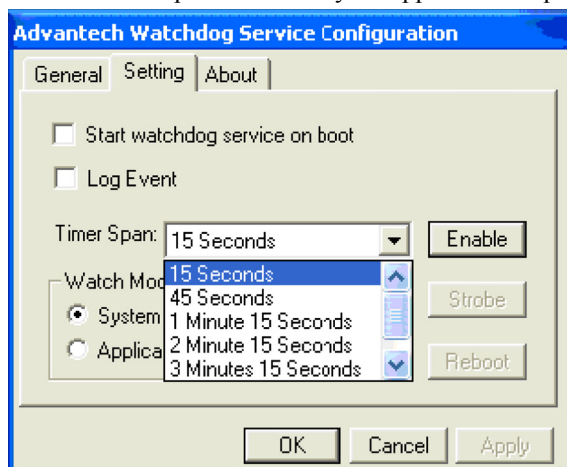

- Click Enable to enable the setting.



6. Check the Start watchdog service on boot to enable the Watchdog-timer to start automatically after the system boots every time.



7. Click OK, then the configuration procedure is finished.

Note Use advantech WDT Driver. WDT was enable, and WDT LED was 1Hz glisten.

4.2.3 Dual Display Setting

If you use CRT monitor, you must Connections to CRT port in during system boot up. During system boot up, the system will set CRT parameter. If you have multiple devices, you can set them.

1. Click Intel graphic icon from the toolbars



2. Select Graphics properties

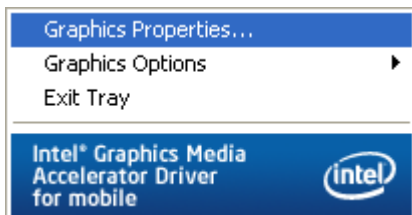

3. This control allows selection of a device page. The currently active is indicated by a checkmark on the icon. If you have multiple devices, activation of an alternate device is accomplished by selecting that device icon. Then, select either Apply or OK button. Intel Dual Display Clone is for CRT monitor and IPPC-6172F LCD as the below.

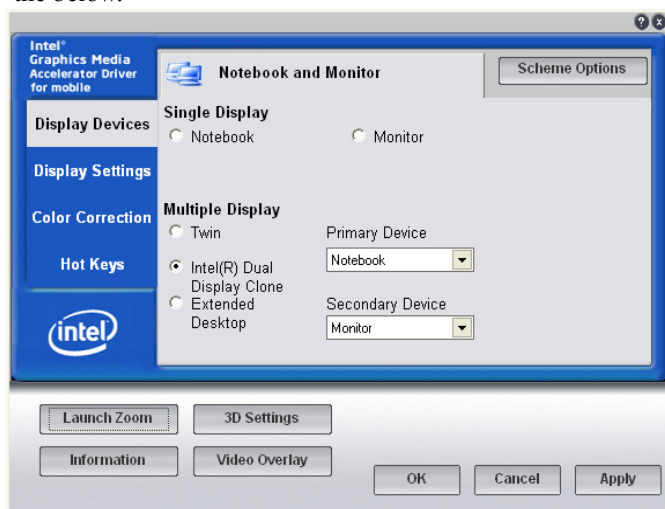

4.2.4 Touchscreen Installation & Configuration

Driver Installation

For driver installation, please insert the support CD and refer to the path:
\\Touchscreen Driver\DMC 6000 (Combo)\Manual\PenMount Win2K&XP&2003&Vista Universal Driver Manual V1.02.pdf

Award BIOS Setup

Sections include:

- Introduction
- Entering Setup

Chapter 5 Award BIOS Setup

5.1 Introduction

Once you enter the Award BIOS CMOS Setup Utility, the Main Menu (Figure 5-1) will appear on the screen. The Main Menu allows you to select between nine setup functions and two exit choices. Use the arrow keys to select among the items and press <Enter> to accept or enter the submenu.

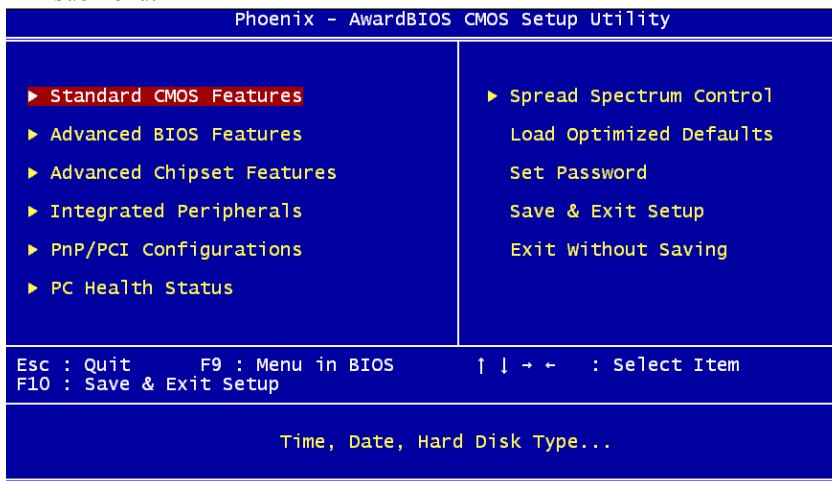

Award's BIOS ROM has a built-in Setup program that allows users to modify the basic system configuration. This type of information is stored in battery-backed CMOS so that it retains the Setup information when the power is turned off.

5.2 Entering Setup

Turn on the computer and press to enter the BIOS setup..

5.2.1 Standard CMOS Setup

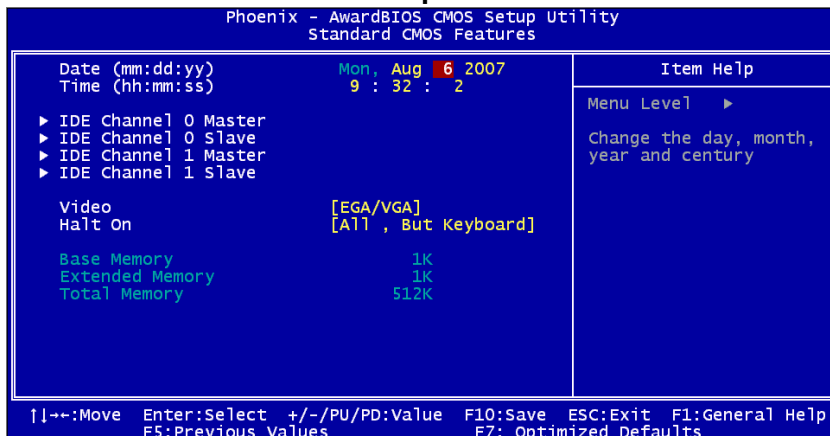

Date

The date format is <week>, <month>, <day>, <year>.

Time

The time format is <hour> <minute> <second>, based on 24-hour clock.

IDE Primary Master/ Secondary Master/ Secondary Slave

- IDE HDD Auto-Detection: Press “Enter” to select this option for automatic device detection.
- IDE Device Setup:

Auto: Automatically detects IDE devices during POST

None: Select this when no IDE device is used. The system will skip the auto-detection step to make system start up faster.

Halt On

This category determines whether system start-up will halt or not when an error is detected during power up.

The options are: No Errors/All Errors/All, But Keyboard/All, But Diskette/All, But Disk/Key

Memory

This category displays base memory, extended memory, and total memory detected during POST (Power On Self Test).

5.2.2 Advanced BIOS Features Setup

The "Advanced BIOS FEATURES" screen will appear after the BIOS FEATURES SETUP item from the CMOS SETUP UTILITY Menu was chosen. This screen allows the user to configure the board according to his particular requirements. Below are some major items that are provided in the BIOS FEATURES SETUP screen:

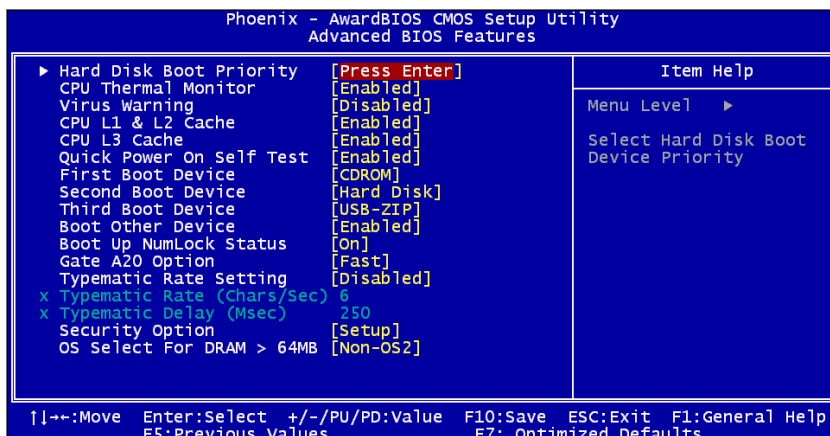

Hard Disk Boot Priority

Set hard disk boot device priority.

CPU Thermal Monitor

The Intel Thermal Monitor Automatic Mode. There are two Automatic modes called Intel Thermal Monitor 1 (TM1) and Intel Thermal Monitor 2 (TM2). And IPPC-9070 Auto dete C-M or P-M. When CPU was C-M BIOS running in TM1, another running TM2.

TM1: When Intel Thermal Monitor 1 is enabled, and a high temperature situation exists, the clocks will be modulated by alternately turning the clocks off and on at a 50% duty cycle. Cycle times are processor speed dependent and will decrease linearly as processor core frequencies increase. After the temperature has returned to a non-critical level, modulation ceases and the TCC goes inactive.

TM2: When Intel Thermal Monitor 2 is enabled, and a high temperature situation exists, the processor will perform an Enhanced Intel SpeedStep technology transition to a lower operating point. When the processor temperature drops below the critical level, the processor will make an Enhanced Intel SpeedStep technology transition to the last requested operating point. Intel Thermal Monitor 2 is the recommended mode on the Intel Pentium M processor

Enabled (default) Enable Thermal Monitor

Disabled Disable Thermal Monitor

Virus Warning

During and after the system boots up, any attempt sector or partition table of the hard disk drive will this happens, a warning message will be displayed. anti-virus program to locate the problem. If the Virus disabled, no warning message will appear if anything access the boot sector or hard disk partition.

CPU L1 & L2 Cache

Enabled (default) Enable cache

Disabled Disable cache

Note: The internal cache is built into the processor.

Quick Power On Self Test

This category speeds up Power On Self Test (POST) after you power on the computer. If this is set to Enabled, BIOS will shorten or skip some check items during POST.

Enabled (default) Enable quick POST

Disabled Normal Normal POST

First/Second/Third Boot Device and Boot Other Device

The BIOS attempts to load the operating system from the devices in the sequence selected in these items. The settings are Hard Disk, CDROM, USB-FDD, USB-ZIP, USB-CDROM, LAN 1, LAN 2 and Disabled.

First boot device (default) USB-CDROM

Second boot device Hard Disk

Third boot device CDROM

NOTE: When you boot by USB- CDROM, please install WinXP with SP1 or Win 2000 with SP3.

Boot Up NumLock Status

On (default) Keypad: numeric keys

Off Keypad: arrow keys

Gate A20 Options

Normal A20 signal is controlled by k/b controller or chipset.

Fast (default) A20 signal is controlled by port 92 or chipset specific.

Typematic Rate Setting

Keystrokes repeat at a rate determined by the keyboard controller. When enabled, the typematic rate and typematic delay can be selected. The settings are: Enabled/Disabled. The default setting is Disabled.

Typematic Rate (Chars/Sec)

Set the number of times a second to repeat a keystroke key down. The settings are: 6, 8, 10, 12, 15, 20, 24, 30.

Typematic Delay (Msec)

Sets the delay time after the key is held down before it the keystroke. The settings are: 250, 500, 750, 1000.

Security Option

This category allows you to limit access to the system and/or to Setup.

Setup(default) The system will boot, but access to Setup will be denied if the correct password is not entered at the prompt.

System The system will not boot and access to Setup will be denied if the correct password is not entered at the prompt.

OS Select For DRAM > 64MB

Allows OS2 to be used with > 64 MB of DRAM. Settings are Non-OS/2 (default) and OS2. Set to OS/2 if using more than 64MB and running OS/2.

5.2.3 Advanced Chipset Features Setup

The Advanced Chipset Features Setup option is used to change the values of the chipset registers. These registers control most of the system options in the computer. Choose the "Advanced Chipset Features" from the main menu and the following screen will appear.

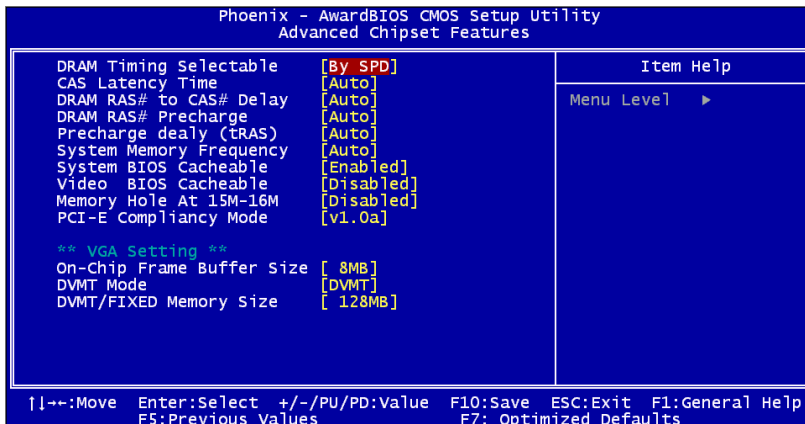

DRAM Timing Configuration

This field lets you select system memory timing data. Manual and BY SPD are two options. Default is "BY SPD"

CAS Latency Time

When synchronous DRAM is installed, the number of clock cycles of CAS latency depends on DRAM timing. The settings are: 3,4,5 and Auto.

DRAM RAS# to CAS# Delay

This field is used to insert a timing delay between the CAS and RAS strobe signals, used when DRAM is written to, read from, or refreshed. Fast gives faster performance; and Slow gives more stable performance.

This field applies only when synchronous DRAM have been installed in the system. The settings are: 2,3,4,5 and auto.

DRAM RAS# Precharge

If an insufficient number of cycles is allowed for the RAS to accumulate its charge before DRAM refresh, the refresh may be incomplete and the DRAM may fail to retain data. Fast gives faster performance; and Slow gives more stable performance. This field applies only when synchronous DRAM is installed in the system. The settings are: 2,3,4,5 and Auto.

Precharge Delay (tRAS)

If an insufficient number of cycles is allowed for the RAS to accumulate its charge before DRAM refresh, the refresh may be incomplete and the DRAM may fail to retain data. Fast gives faster performance; and Slow gives more stable performance. This field applies only when synchronous DRAM is installed in the system. The settings are: Auto and 2,3,4,5,6,7,8,9,10

System Memory Frequency

Default auto :The bios detect memory frequency is by SPD. The settings are: Auto and 333MHz,400MHz,533MHz.

System BIOS Cacheable

Selecting Enabled allows caching of the system BIOS ROM at F0000h-FFFFFh, resulting in better system performance. However, if any program writes to this memory area, a system error may result. The settings are: Enabled (Default) and Disabled.

Video BIOS Cacheable

Select Enabled allows caching of the video BIOS, resulting in better system performance. However, if any program writes to this memory area, a system error may result. The settings are: Enabled and Disabled (Default).

Memory Hole At 15M-16M

You can reserve this area of system memory for ISA adapter ROM. When this area is reserved, it cannot be cached. The user information of peripherals that need to use this area of system memory usually discusses their memory requirements. The settings are: Enabled and Disabled (Default).

PCI-E Compliancy Mode

This allows the user to select the PCI-E compliant mode. The options are [v1.0], and [v1.0a].

On-Chip Video Memory Size

This field let you select On-Chip buffer size. The settings are: 1 and 8.

DVMT Mode

We have three options (Fixed, DVMT and Both). The default is DVMT.

DVMT/FIXED Memory Size

We have 64Mb and 128MB. The default is 128MB.

5.2.4 Integrated Peripherals

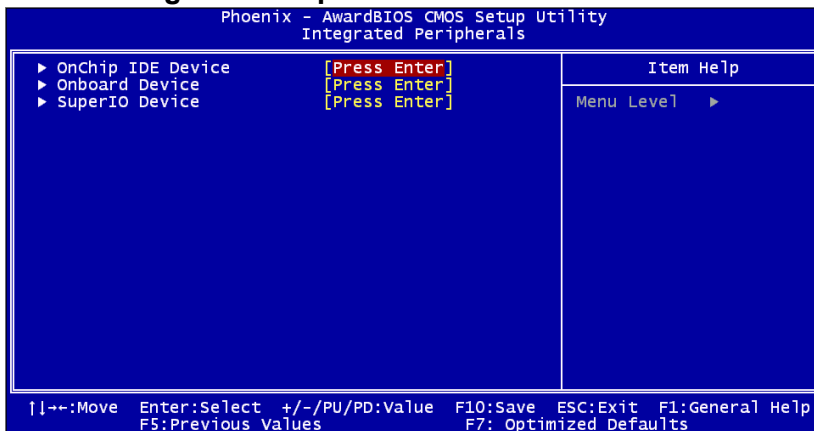

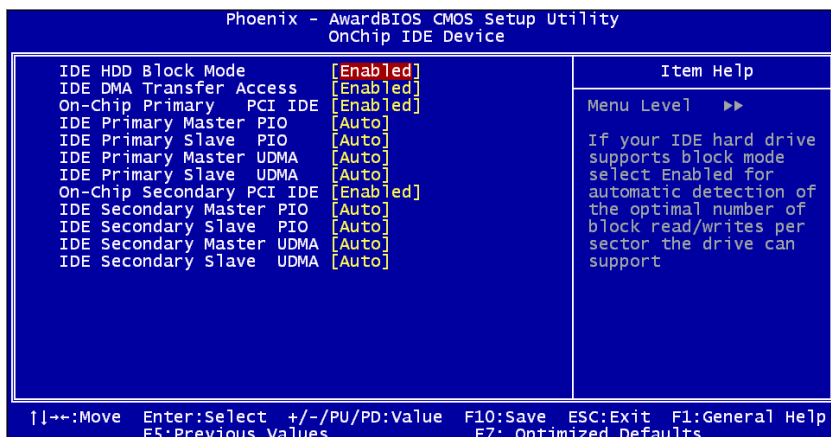

IDE HDD Block Mode

Block mode is also called block transfer, multiple commands, or multiple sector read/write. If your IDE hard drive supports block mode (most new drives do), select Enabled for automatic detection of the optimal number of block read/writes per sector the drive can support. The settings are: Enabled (Default), Disabled.

On-Chip Primary (SATA) / Secondary (PATA) PCI IDE

The integrated peripheral controller contains an IDE interface with support for two IDE channels. Select Enabled to activate each channel separately. The settings are: Enabled (Default) and Disabled.

IDE Primary/Secondary Master/Slave PIO

The four IDE PIO (Programmed Input/Output) fields let you set a PIO mode (0-4) for each of the four IDE devices that the onboard IDE interface supports. Modes 0 through 4 provide successively increased performance. In Auto mode, the system automatically determines the best mode for each device. The settings are: Auto (Default), Mode 0, Mode 1, Mode 2, Mode 3, Mode 4.

IDE Primary/Secondary Master/Slave UDMA

Ultra DMA/33 implementation is possible only if your IDE hard drive supports it and the operating environment includes a DMA driver (Windows 95 OSR2 or a third-party IDE bus master driver). If your hard drive and your system software both support Ultra DMA/33 and Ultra DMA/66 and Ultra DMA/100, select Auto to enable BIOS support. The settings are: Auto (Default), Disabled.

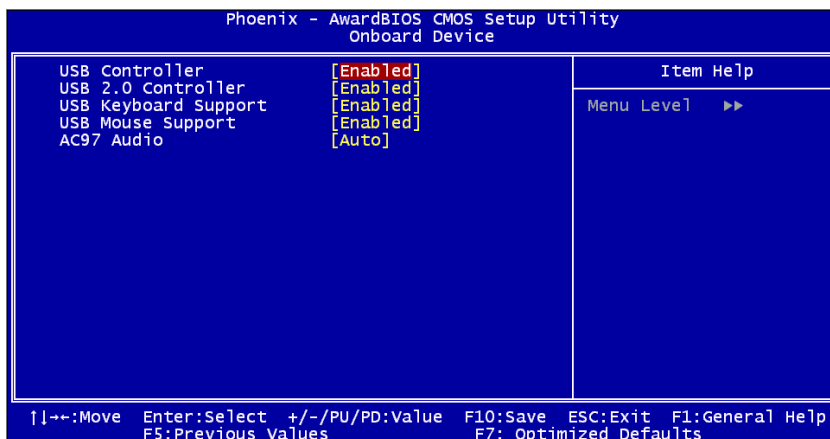

USB Controller

Select enabled if your system contains a Universal Serial Bus (USB) 1.1 controller. The settings are: Enabled (Default), Disabled.

USB 2.0 Controller

Select enabled if your system contains a Universal Serial Bus (USB) 2.0 controller. The settings are: Enabled (Default), Disabled.

USB Keyboard Support

Select enabled if you use USB Keyboard in DOS mode. Enable (Default)

USB Mouse Support

Select enabled if you use USB Mouse in DOS mode. Disabled (Default)

AC97 Audio

Select “Disable” if you do not want to use AC-97 audio. Options are “Auto”, and “Disabled”.

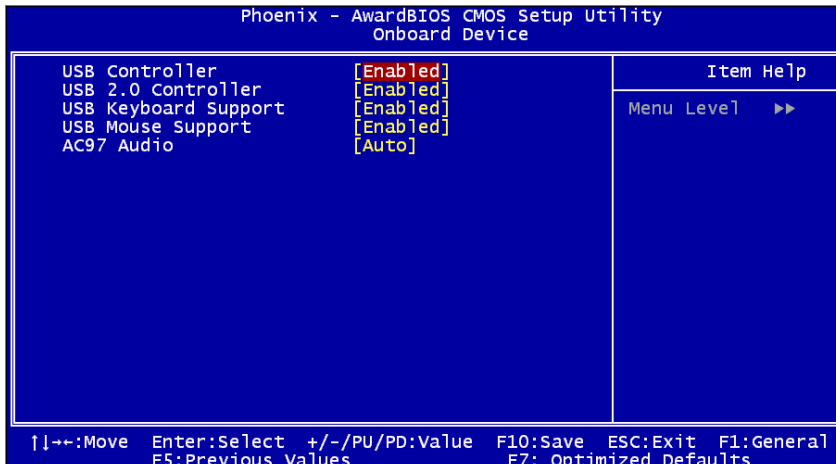

Onboard Serial Port 1

The settings are “3F8/IRQ4”, “2F8/IRQ3”, “3E8/IRQ4”, “2E8/IRQ3”, and “Disabled” for the on-board serial connector.

Onboard Serial Port 2

The settings are “3F8/IRQ4”, “2F8/IRQ3”, “3E8/IRQ4”, “2E8/IRQ3”, and “Disabled” for the on-board serial connector.

Onboard Parallel Port

There is a built-in parallel port on the onboard Super I/O chipset that provides Standard, ECP, and EPP features. It has the following options: Disabled, 378/IRQ7 (Default), 278/IRQ5, 3BC/IRQ7 and Disabled. for the on-board serial connector.

Parallel Port Mode

This field allows you to set the operation mode of the parallel port. The setting "SPP" allows standard speed operation. "EPP" allows bidirectional parallel port operation at maximum speed. "ECP" allows the parallel port to operate in bidirectional mode and at a speed faster than the maximum data transfer rate. "ECP + EPP" allows normal speed operation in a two-way mode.

EPP Mode Select

This field allows you to select EPP port type 1.7 or 1.9. The choices: EPP1.7, 1.9.

ECP Mode Use DMA

This selection is available only if you select "ECP" or "ECP + EPP" in the Parallel Port Mode field. In ECP Mode Use DMA, you can select DMA channel 1, DMA channel 3, or Disable. Leave this field on the default setting

5.2.5 Power Management Setup

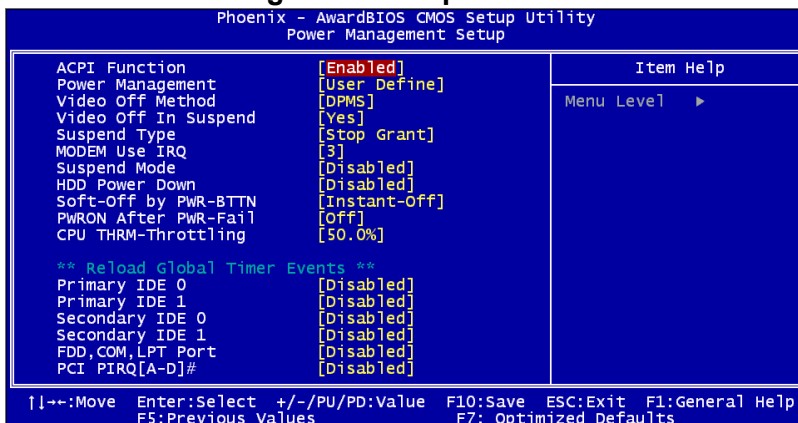

ACPI Function

This category allows you to select if ACPI power management are enabled or not. The options: Enabled (Default) and Disabled.

Power Management

This category allows you to select the type (or degree) of power saving and is directly related to the following modes:

1. HDD Power Down
2. Suspend Mode

There are four selections for Power Management, three of which have-fixed mode settings.

User Defined(Default) Allows you to set each mode individually. When not disabled,each of the ranges are from 1 min. to 1 hr. except for HDD Power Down which ranges from 1 min. to 15 min.and disable.

Min Saving Minimum power management., Suspend Mode = 1 hr.and HDD Power Down = 15 min.

Max Saving Maximum power management., Suspend Mode = 1 min.and HDD Power Down = 1 min.

Video Off Method

Use this to select the method to turn off the video. The choices are :
"Blank Screen", "V/H SYNC+ Blank", "DPMS".

Video Off In Suspend

When system is in suspend, video will turn off.

Suspend Type

The choices are : "Stop Grant", "PwrOn Suspend."

Modem Use IRQ

This determines the IRQ in which the MODEM can use.The choices: 3, 4, 5, 7, 9, 10, 11, NA.

Suspend Mode

Please refer to 3.7.3

HDD Power Down

You can choose to turn the HDD off after one of the time intervals listed, or when the system is in Suspend Mode. If the HDD is in a power saving mode, any access to it will wake it up.

Soft-Off by PWR-BTTN

If you choose Instant-Off, then pushing the ATX soft power switch button once will switch the system to System Off power mode. You can choose Delay 4 sec. If you do, then pushing the button for more than 4 seconds will turn off the system, whereas pushing the button momentarily (for less than 4 seconds) will switch the system to Suspend Mode.

PWRON After PWR-Fail

Use this to set up the system after power failure. The "Off" will keep the system powered off after power failure, the "On" will boot up the system after failure, and the "Former-Sts" will return the system to the status

CPU THRM-Throttling

This field allows you to select the CPU THRM-Throttling rate. The choices: 12.5%, 25.0%, 37.5%, 50.0%, 62.5%, 75.0%, 87.5%.

Primary IDE 0 (1) and Secondary IDE 0 (1)

When Enabled, the system will resume from suspend mode if Primary IDE 0 (1) or Secondary IDE 0 (1) is active. The choice: Enabled, Disabled.

FDD, COM, LPT PORT

When Enabled, the system will resume from suspend mode if FDD, COM port, or LPT port is active. The choice: Enabled, Disabled.

PCI PIRQ [A-D]#

When Enabled, the system will resume from suspend mode if interrupt occurs. The choice: Enabled, Disabled.

5.2.6 PNP/PCI Configuration Setup

This section describes configuring the PCI bus system. PCI, or Personal Computer Interconnect, is a system that allows I/O devices to operate at speeds nearing the speed the CPU itself uses when communicating with its own special components. This section covers some very technical items and it is strongly recommended that only experienced make any changes to the default settings.

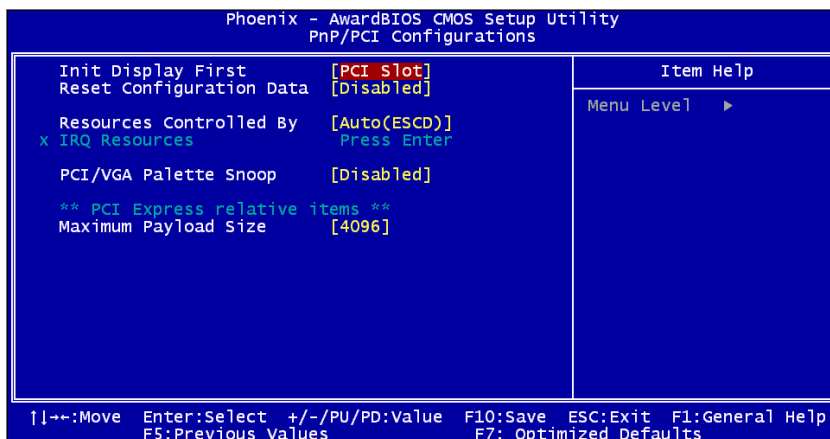

Init Display First

The default is PCI Slot. Select PCI Slot to boot VGA in extended VGA Card.

Reset Configuration Data

The default is Disabled. Select Enabled to reset Extended System Configuration Data (ESCD) if you have installed a new add-on card, and system configuration is in such a state that the OS cannot boot.

Resource Controlled By

The Award Plug and Play BIOS has the capacity to automatically configure all the boot and Plug and Play compatible devices. However, this capability means absolutely nothing unless you are using a Plug and Play operating system such as Windows® 95/98. If you set this field to "manual," choose specific resources by going into each of the sub menus that follow this field (a sub menu is preceded by a "Y"). The settings are: Auto (ESCD) (Default), Manual.

IRQ Resources

When resources are controlled manually, assign each system interrupt a type, depending on the type of device using the interrupt.

PCI/VGA Palette Snoop

Leave this field at Disabled. The settings are Enabled, Disabled (Default).

Maximum Payload Size

This allows you to set the maximum TLP payload size for PCI Express devices. The options are [128 bytes], [256 bytes], [512 bytes], [1024 bytes], [2048 bytes], and [4096 bytes].

5.2.7 PC Health Status

This section shows the Status of you CPU, System Temp, Warning for overall system status. This is only available if there is Hardware Monitor onboard.

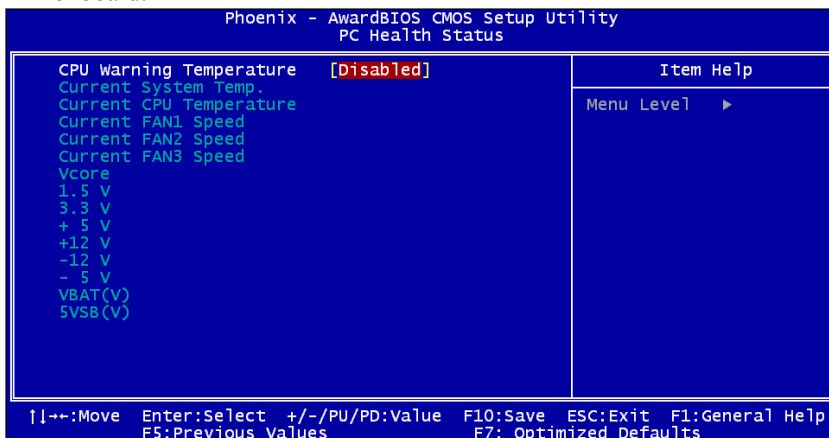

CPU Warning Temperature

This item will prevent the CPU from overheating. The choices are “Disabled”, “50C/122F”, “53C/127F”, “56C/133F”, “60C/140F”, “63C/145F”, “66C/151F”, “70C/158F”, “75C/167F”, “80C/176F”, “85C/185F”, “90C/194F”, and “95C/205F”.

Current System/CPU Temp./ Fan1/Fan2/Fan3/Vcore/1.5V/3.3V/+5V/+12V/-12V/-5V/Vbat/5Vsb

This shows system health status.

5.2.8 Spread Spectrum Control

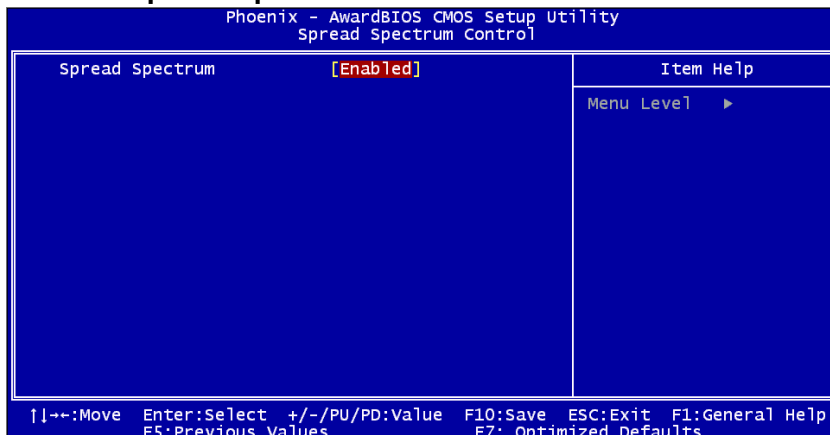

Spread Spectrum

This item allows you to enable spread spectrum function. Default is "Disabled."

5.2.9 Load Optimized Defaults

When you press <Enter> on this item, you get a confirmation dialog box with a message similar to: Load Optimized Defaults (Y/N) ? N Pressing 'Y' loads the default values that are factory settings for optimal performance system operations.

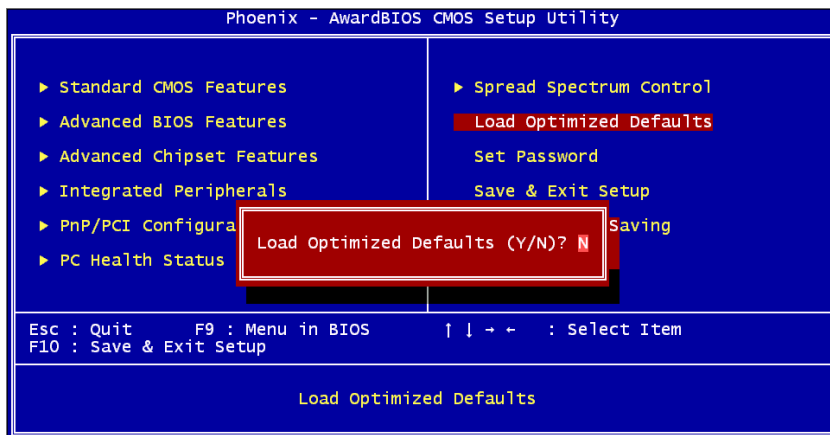

5.2.10 Set Password

To change, confirm, or disable the password, choose the "PASSWORD SETTING" option from the Setup main menu and press [Enter]. The password can be at most 8 characters long. Remember, to enable this feature. You must first select the Security Option in the Advanced BIOS Features Setup to be either "Setup" or "System." Pressing [Enter] again without typing any characters can disable the password setting function.

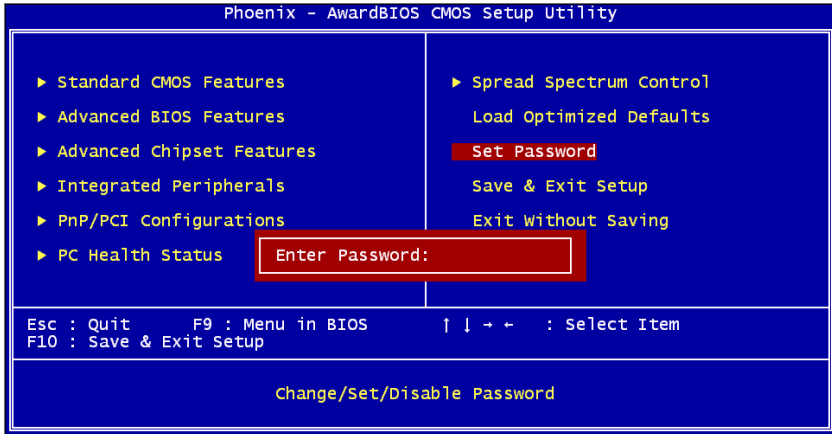

5.2.11 Save & Exit Setup

If you select this and press the [Enter] key, the values entered in the setup utilities will be recorded in the CMOS memory of the chipset. The microprocessor will check this every time you turn your system on and compare this to what it finds as it checks the system. This record is required for the system to operate.

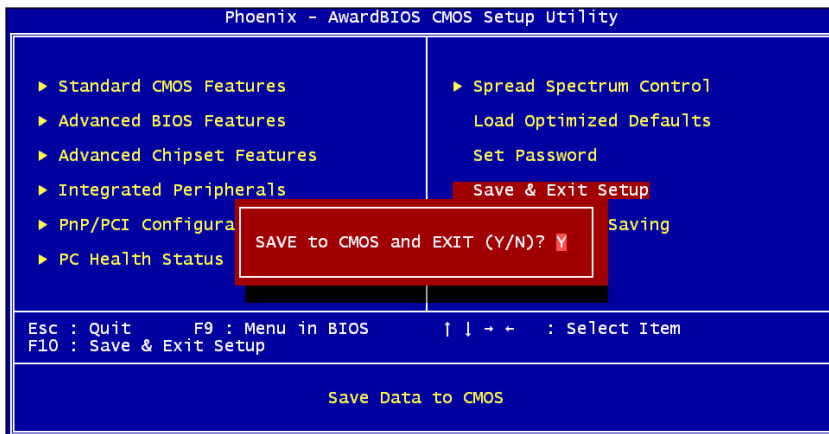

5.2.12 Exit Without Saving

Selecting this option and pressing the [Enter] key lets you exit the Setup program without recording any new values or changing old ones.

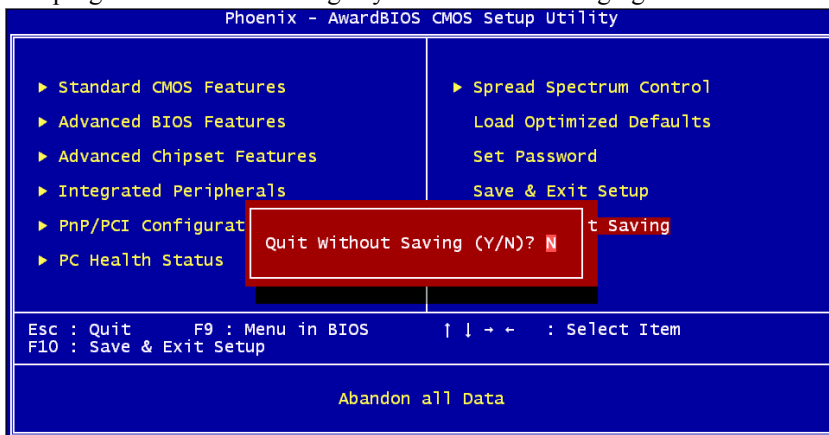

IO & Connector Pin Assignments

Appendix A IO & Connector Pin Assigns

A.1 CN1,CN2 LVDS

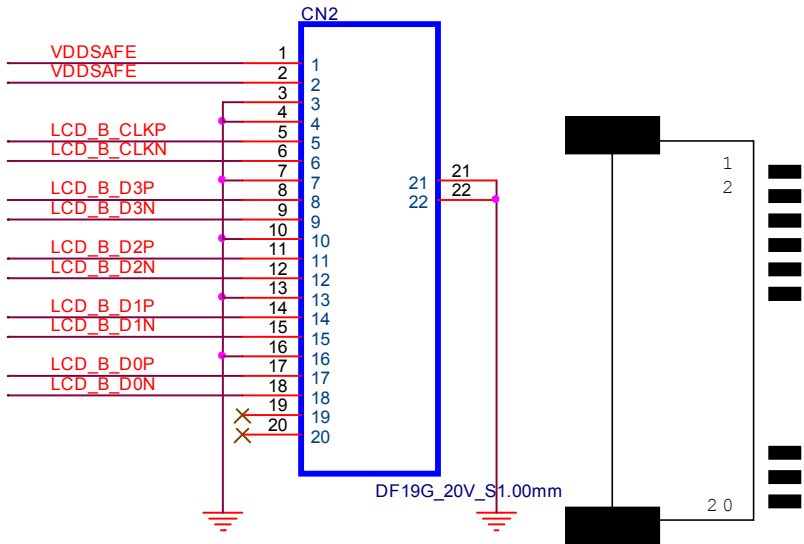
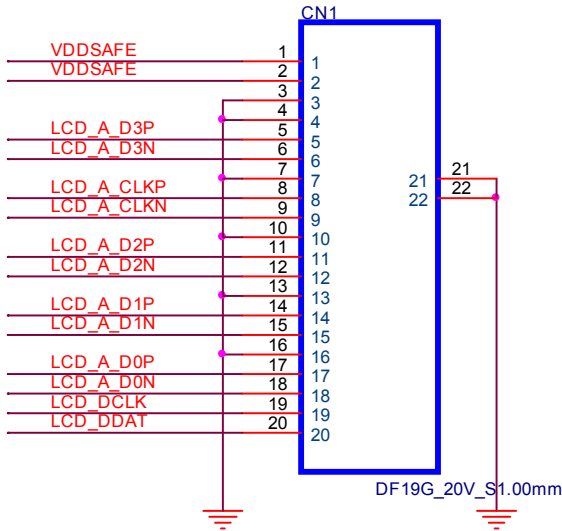

A.2 CN9 LCD INVERTER

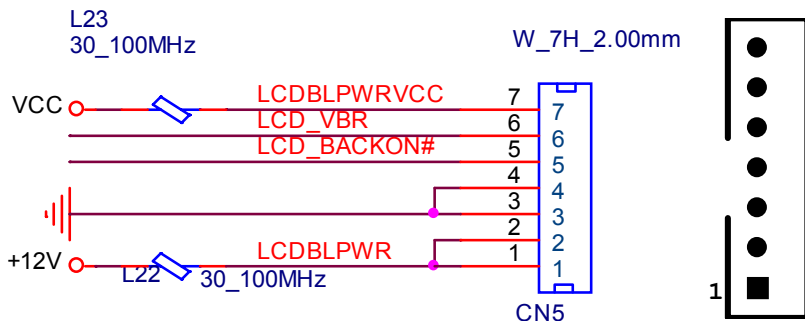

A.3 CN12 Touchscreen

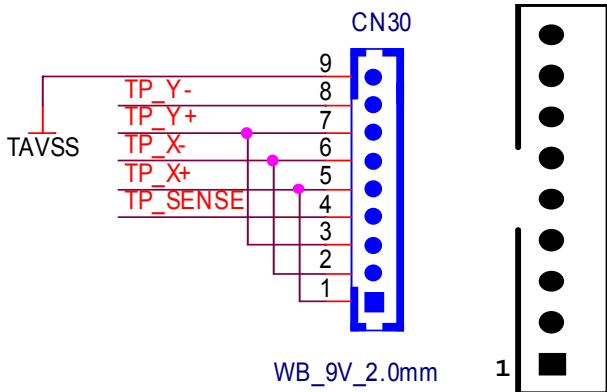

A.4 CN15/CN17 USB 6,7

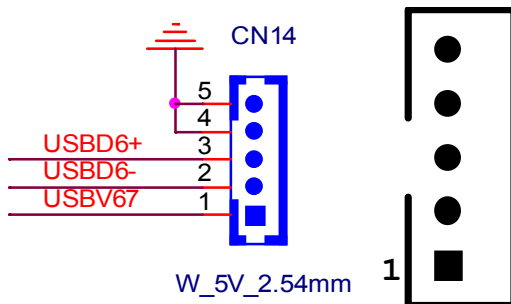

A.5 CN19,CN21 SATA POWER

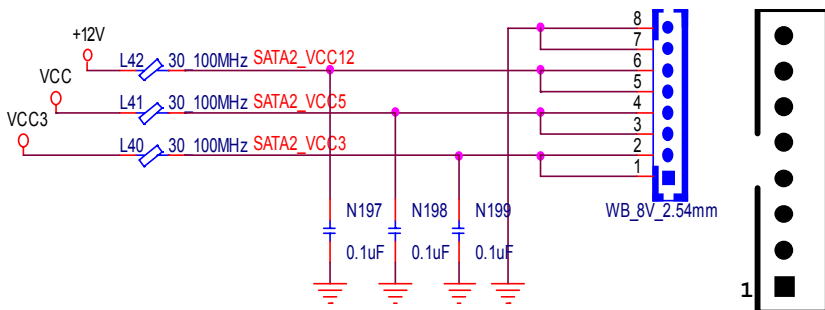

A.6 CN10 IDE

SLIM TYPE CD-ROM

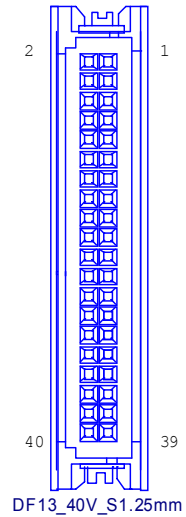
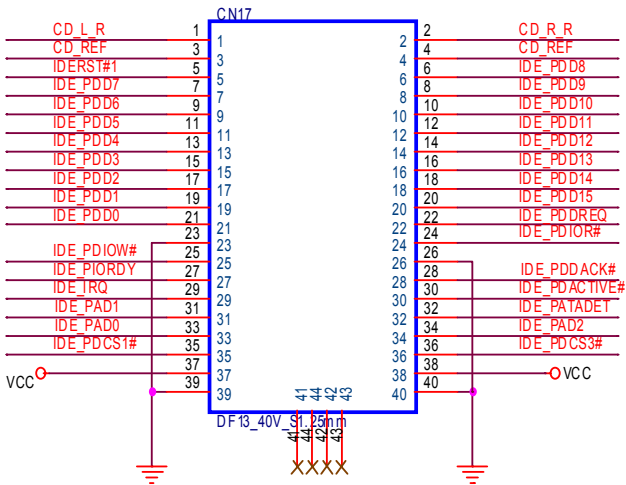

A.7 CN18 Panel Header

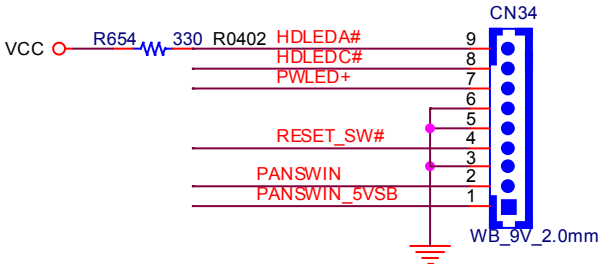

- Pin1-2 : POWER BUTTON
- Pin3-4 : RESET BUTTON
- Pin6-7 : POWER LED
- Pin8-9 : HDD LED

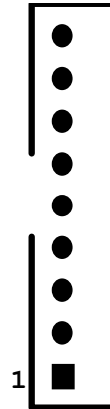

A.8 CN34 : DB-15 VGA Connector Definitions

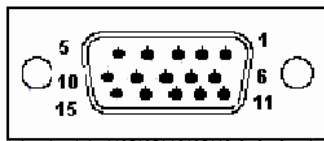

Pin	Signal
1	RED
2	GREEN
3	BLUE
4	N/C
5	GND
6	GND
7	GND
8	GND
9	N/C (VGAVCC)
10	GND
11	N/ C
12	VGA_SDA
13	HSYNC
14	VSYNC
15	VGA_SCL

A.9 CN30 : PS/2 K/b & Mouse Connector Definitions

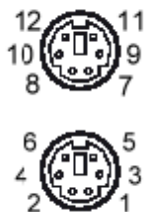

Pin	Signal
1	KB DATA
2	
3	GND
4	VCC
5	KB CLOCK
6	
7	MS DATA
8	
9	GND
10	VCC
11	MS CLOCK
12	

A.10 CN28,CN29 : USB 0,1,2,3 Connector Definitions

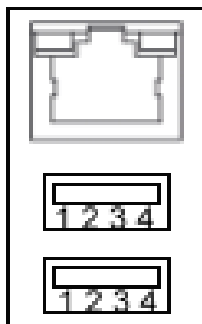
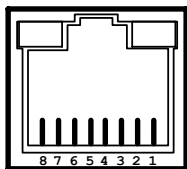

A.11 10/100/1000Base-TX Ethernet

Pin	10/100Base-TX Signal	10/100/1000Base-TX Signal
1	TD+	MDIAX1+
2	TD-	MDIAX1-
3	RD+	MDIAX2+
4	N/C	MDIAX3+
5	N/C	MDIAX3-
6	RD-	MDIAX2-
7	N/C	MDIAX4+
8	N/C	MDIAX4-

LED Indicator Definition

Left		Right
10Mbps	Off	flick active/link mode
100Mbps	Green	
1000Mbps	Orange	

USB Ports Pin Definitions

Pin	Signal
1	VCC
2	USB_P-
3	USB_P+
4	GND

2F-CN10-Secondary IDE 44pin 2mm Connector

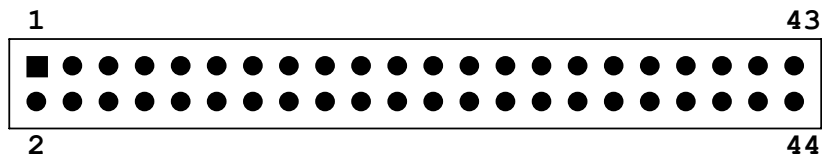

For direct installation 2.5" IDE HDD (2F-CN17)

Secondary IDE Connector for 2.5" HDD Pin Definitions

Pin	Signal	Pin	Signal
1	IDERST*	2	GND
3	SDD7	4	SDD8
5	SDD6	6	SDD9
7	SDD5	8	SDD10
9	SDD4	10	SDD11
11	SDD3	12	SDD12
13	SDD2	14	SDD13
15	SDD1	16	SDD14
17	SDD0	18	SDD15
19	GND	20	N/C
21	SDDREQ	22	GND
23	SDIOW*	24	GND
25	SDIOR*	26	GND
27	SDIORDY	28	GND
29	SDDACK*	30	GND
31	IRQ15	32	N/C
33	SDA1	34	S66DET
35	SDA0	36	SDA2
37	SDCS*1	38	SDCS*3
39	HDD_LED	40	GND
41	+5V	42	+5V
43	GND	44	N/C

*Low Active

CN36 : Serial port 1,2 RS232 Connector Definitions

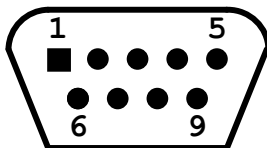

Pin	Signal
1	NDCD
2	NRX
3	NTX
4	NDTR
5	GND
6	NDSR
7	NRTS
8	NCTS
9	NRI

2F-SA0 : Serial ATA0 (7pin connector)

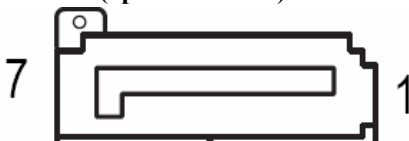

Pin	Signal
1	GND
2	TX+
3	TX-
4	GND
5	RX-
6	RX+
7	GND

System Assignments

Appendix B System Assignments

B.1 System I/O Ports

Addr. Range (Hex)	Device
000-01F	DMA controller
020-021	Interrupt controller 1, master
022-023	Chipset address
040-05F	8254 timer
060-06F	8042 (keyboard controller)
070-07F	Real-time clock, non-maskable interrupt (NMI) mask
080-09F	DMA page register
0A0-0BF	Interrupt controller 2
0C0-0DF	DMA controller
0F0	Clear math co-processor
0F1	Reset math co-processor
0F8-0FF	Math co-processor
1F0-1F8	Fixed disk
278-27F	Parallel printer port 2 (LPT3)
290-297	On-board hardware monitor
2F8-2FF	Serial port 2
360-36F	Reserved
378-37F	Parallel printer port 1 (LPT2)
3C0-3CF	Reserved
3D0-3DF	Color/graphics monitor adapter
3F0-3F7	Diskette controller
3F8-3FF	Serial port 1

B.2 DMA Channel Assignments

Channel	Function
0	Available
1	Available
2	Available
3	Available
4	Cascade for DMA controller 1
5	Available
6	Available
7	Available

B.3 Interrupt Assignments

Priority	Interrupt#	Interrupt Source
1	NMI	Parity error detected
2	IRQ0	Interval timer
3	IRQ1	Keyboard
	- IRQ2	Interrupt from controller 2 (cascade)
4	IRQ8	Real-time clock
5	IRQ9	Cascaded to INT 0A (IRQ 2)
6	IRQ10	Available
7	IRQ11	Available
8	IRQ12	PS/2 mouse
9	IRQ13	INT from co-processor
10	IRQ14	Fixed disk controller
11	IRQ15	Available
12	IRQ3	Serial communication port 2
13	IRQ4	Serial communication port 1
14	IRQ5	Parallel port 2
15	IRQ6	Available
16	IRQ7	Parallel port 1 (print port)

B.4 1st MB Memory Map

Addr. range (Hex)	Device
E0000h - FFFFFh	System ROM
CC000h - DFFFFh	Unused
C0000h - CBFFFh	VGA BIOS
A0000h - BFFFFh	VGA buffer
00000h - 9FFFFh	Base memory

B.5 PCI Bus Map

Function Signals:	Device ID	INT# Pin	GNT# Pin
Onboard LAN1	AD24	INT E	
PCI slot 2	AD29	INT B,C,D,A	GNT2#
PCI slot 3	AD30	INT C,D,A,B	GNT1#
PCI slot 4	AD31	INT D,A,B,C	GNT0#

Watchdog Timer

Appendix C Watchdog Timer

C.1 Overview

The IPPC-9070 cards' watchdog timer can be used to monitor system software operation and take corrective action if the software fails to function after the programmed period. This section describes the operation of the watchdog timer, and how to program it. The watchdog timer is built into the super I/O controller W83627HF. It provides the following functions for user programming:

- Can be enabled and disabled by user's program.
- Timer can be set from 1 to 255 seconds or 1 to 255 minutes.
- Generates an interrupt or resets signal if the software fails to reset the timer after time-out.

C.2 Watchdog Timer Programming

The I/O port address of the watchdog timer is 2E(hex) and 2F(hex), 2E(hex) is the address port. 2F(hex) is the data port. You must first assign the address of register by writing address value into address port 2E(hex), then write/read data to/from the assigned register through data port 2F(hex).

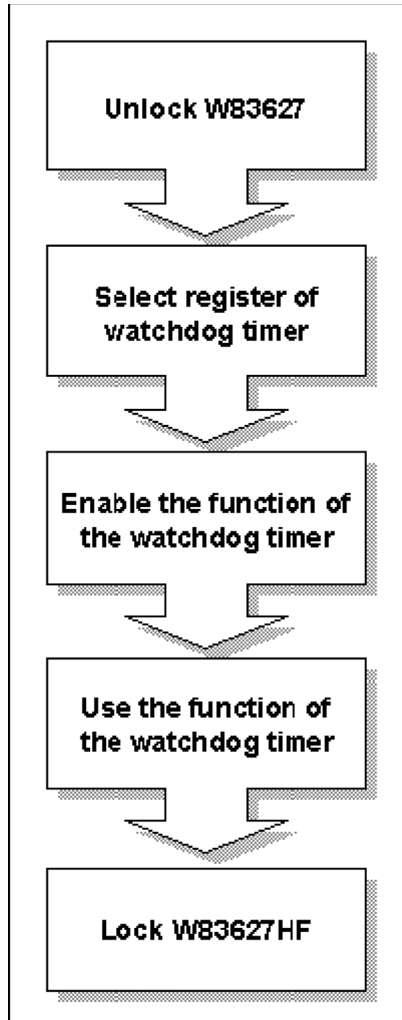

Register Address (2E)	Attribute	Description
Read/Write	Value (2F) and description	
87 (hex)	-----	Write this address to I/O address port 2E (hex) twice to unlock the W83627HF
07 (hex)	write	Write 08 (hex) to select register of watchdog timer.
30 (hex)	write	Write 01 (hex) to enable the function of the watchdog timer. Disabled is set as default.
F5 (hex)	write	Set seconds or minutes as units for the timer.
Write 0 to bit 3: set second as counting unit. [default]		
Write 1 to bit 3: set minute as counting unit		
F6 (hex)	write	0: stop timer [default]01~FF (hex): The amount of the count, in seconds or minutes, depends on the value set in register F5 (hex). This number decides how long the watchdog timer waits for strobe before generating an interrupt or reset signal. Writing a new value to this register can reset the timer to count with the new value.
F7 (hex)	rd/wr	Bit 6: Write 1 to enable keyboard to reset the timer, 0 to disable.[default] Bit 5: Write 1 to generate a timeout signal immediately and automatically return to 0. [default=0] Bit 4: Read status of watchdog timer, 1 means timer is "time out".
AA (hex)	-----	Write this address to I/O port 2E (hex) to lock the watchdog timer.2

C.3 Example Programs

1. Enable watchdog timer and set 10 sec. as timeout interval

```
;-----  
Mov dx,2eh ; Unlock W83627HF  
Mov al,87h  
Out dx,al  
Out dx,al  
;-----  
Mov al,07h ; Select registers of watchdog timer  
Out dx,al  
Inc dx  
Mov al,08h  
Out dx,al  
;-----  
Dec dx ; Enable the function of watchdog timer  
Mov al,30h  
Out dx,al  
Inc dx  
Mov al,01h  
Out dx,al  
;-----  
Dec dx ; Set second as counting unit  
Mov al,0f5h  
Out dx,al  
Inc dx  
In al,dx  
And al,not 08h  
Out dx,al  
;-----  
Dec dx ; Set timeout interval as 10 seconds and start counting  
Mov al,0f6h  
Out dx,al  
Inc dx  
Mov al,10  
Out dx,al  
;-----  
Dec dx ; lock W83627HF
```

```
Mov al,0aah
Out dx,al
```

2. Enable watchdog timer and set 5 minutes as timeout interval

```
;-----
Mov dx,2eh ; unlock W83627H
Mov al,87h
Out dx,al
Out dx,al
;-----
Mov al,07h ; Select registers of watchdog timer
Out dx,al
Inc dx
Mov al,08h
Out dx,al
;-----
Dec dx ; Enable the function of watchdog timer
Mov al,30h
Out dx,al
Inc dx
Mov al,01h
Out dx,al
;-----
Dec dx ; Set minute as counting unit
Mov al,0f5h
Out dx,al
Inc dx
In al,dx
Or al,08h
Out dx,al
;-----
Dec dx ; Set timeout interval as 5 minutes and start counting
Mov al,0f6h
Out dx,al
Inc dx
Mov al,5
Out dx,al
;-----
```

```
Dec dx ; lock W83627HF
Mov al,0aah
Out dx,al
```

3. Enable watchdog timer to be reset by mouse

```
;-----
Mov dx,2eh ; unlock W83627H
Mov al,87h
Out dx,al
Out dx,al
;-----
Mov al,07h ; Select registers of watchdog timer
Out dx,al
Inc dx
Mov al,08h
Out dx,al
;-----
Dec dx ; Enable the function of watchdog timer
Mov al,30h
Out dx,al
Inc dx
Mov al,01h
Out dx,al
;-----
Dec dx ; Enable watchdog timer to be reset by mouse
Mov al,0f7h
Out dx,al
Inc dx
In al,dx
Or al,80h
Out dx,al
;-----
Dec dx ; lock W83627HF
Mov al,0aah
Out dx,al
```

4. Enable watchdog timer to be reset by keyboard

```
;-----
Mov dx,2eh ; unlock W83627H
```

```
Mov al,87h
Out dx,al
Out dx,al
```

```
-----
```

```
Mov al,07h ; Select registers of watchdog timer
Out dx,al
Inc dx
Mov al,08h
Out dx,al
```

```
-----
```

```
Dec dx ; Enable the function of watchdog timer
Mov al,30h
Out dx,al
Inc dx
Mov al,01h
Out dx,al
```

```
-----
```

```
Dec dx ; Enable watchdog timer to be strobed reset by keyboard
Mov al,0f7h
Out dx,al
Inc dx
In al,dx
Or al,40h
Out dx,al
```

```
-----
```

```
Dec dx ; lock W83627HF
Mov al,0aah
Out dx,al
```

5. Generate a time-out signal without timer counting

```
-----
```

```
Mov dx,2eh ; unlock W83627H
Mov al,87h
Out dx,al
Out dx,al
```

```
-----
```

```
Mov al,07h ; Select registers of watchdog timer
Out dx,al
Inc dx
```

```

Mov al,08h
Out dx,al
;-----
Dec dx ; Enable the function of watchdog timer
Mov al,30h
Out dx,al
Inc dx
Mov al,01h
Out dx,al
;-----
Dec dx ; Generate a time-out signal
Mov al,0f7h
Out dx,al ;Write 1 to bit 5 of F7 register
Inc dx
In al,dx
Or al,20h
Out dx,al
;-----
Dec dx ; lock W83627HF
Mov al,0aah
Out dx,al

```

