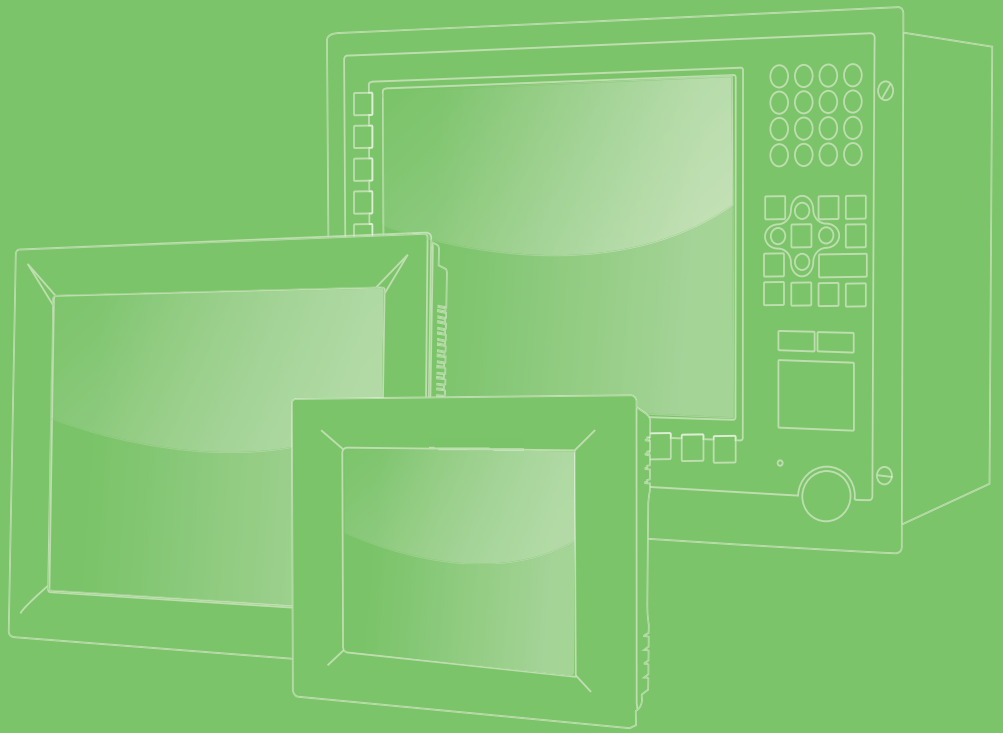


User Manual



# TPC-300 Series TPC-B510

Industrial Touch Panel Computer with  
8th Gen. Intel® Core™ Processor

VICPAS  
HMI Parts Center

ADVANTECH

*Enabling an Intelligent Planet*

## Copyright

The documentation and the software included with this product are copyrighted 2020 by Advantech Co., Ltd. All rights are reserved. Advantech Co., Ltd. reserves the right to make improvements in the products described in this manual at any time without notice. No part of this manual may be reproduced, copied, translated or transmitted in any form or by any means without the prior written permission of Advantech Co., Ltd. Information provided in this manual is intended to be accurate and reliable. However, Advantech Co., Ltd. assumes no responsibility for its use, nor for any infringements of the rights of third parties, which may result from its use.

## Acknowledgments

Intel and Pentium are trademarks of Intel Corporation.

Microsoft Windows and MS-DOS are registered trademarks of Microsoft Corp.

All other product names or trademarks are properties of their respective owners.

This manual is applicable to the following models:

- TPC-312-R833A
- TPC-312-R853A
- TPC-312-R873A
- TPC-315-R833A
- TPC-315-R853A
- TPC-315-R873A
- TPC-317-R833A
- TPC-317-R853A
- TPC-317-R873A
- TPC-324W-P833A
- TPC-324W-P853A
- TPC-324W-P873A
- TPC-B510-833AE
- TPC-B510-853AE
- TPC-B510-873AE

## Product Warranty (2 years)

Advantech warrants the original purchaser that each of its products will be free from defects in materials and workmanship for two years from the date of purchase.

This warranty does not apply to any products that have been repaired or altered by persons other than repair personnel authorized by Advantech, or that have been subject to misuse, abuse, accident, or improper installation. Advantech assumes no liability under the terms of this warranty as a consequence of such events.

Because of Advantech's high quality-control standards and rigorous testing, most customers never need to use our repair service. If an Advantech product is defective, it will be repaired or replaced free of charge during the warranty period. For out-of-warranty repairs, customers are billed according to the cost of replacement materials, service time, and freight. Please consult your dealer for more details.

If you believe your product is defective, follow the steps outlined below.

1. Collect all the information about the problem encountered. (For example, CPU speed, Advantech products used, other hardware and software used, etc.) Note anything abnormal and list any onscreen messages displayed when the problem occurs.
2. Call your dealer and describe the problem. Have your manual, product, and any relevant information readily available.
3. If your product is diagnosed as defective, obtain a return merchandise authorization (RMA) number from your dealer. This allows us to process your return more quickly.
4. Carefully pack the defective product, a completed Repair and Replacement Order Card, and a proof of purchase date (such as a photocopy of your sales receipt) into a shippable container. Products returned without proof of purchase date are not eligible for warranty service.
5. Write the RMA number visibly on the outside of the package and ship it prepaid to your dealer.

## Declaration of Conformity

### CE

This product has passed the CE test for environmental specifications when shielded cables are used for external wiring. We recommend the use of shielded cables. This type of cable is available from Advantech. Contact your local supplier for ordering information.

### FCC Class A

This equipment has been tested and found to comply with the limits for a Class A digital device, pursuant to part 15 of the FCC Rules. These limits are designed to provide reasonable protection against harmful interference when the equipment is operated in a commercial environment. This equipment generates, uses, and can radiate radio frequency energy and, if not installed and used in accordance with the instruction manual, may cause harmful interference to radio communications. Operation of this equipment in a residential area is likely to cause harmful interference. In such cases, users are required to correct the interference at their own expense.\

## 甲類警語

警告使用者：這是甲類資訊產品，在居住的環境中使用時，可能會造成射頻干擾，在這種情況下，使用者會被要求採取某些適當對策。

## Technical Support and Assistance

1. Visit the Advantech website at [www.advantech.com/support](http://www.advantech.com/support) to obtain the latest product information.
2. Contact your distributor, sales representative, or Advantech customer service center for technical support if you need additional assistance. Please have the following information ready before calling:
  - Product name and serial number
  - Description of your peripheral attachments
  - Description of your software (operating system, version, application software, etc.)
  - A complete description of the problem
  - The exact wording of any error messages

## Warnings, Cautions, and Notes

**Warning!** *Warnings indicate conditions that if not observed can cause personal injury!*



**Caution!** *Cautions are included to prevent hardware damage and data losses. For example,*



*“Batteries are at risk of exploding if incorrectly installed. Replace the battery only with the same or equivalent type as recommended by the manufacturer. Discard used batteries according to the manufacturer's instructions.”*

**Note!** *Notes provide additional optional information.*



## Safety Instructions

1. Read these safety instructions carefully.
2. Retain this user manual for future reference.
3. Disconnect the equipment from all power outlets before cleaning. Use only a damp cloth for cleaning. Do not use liquid or spray detergents.
4. For pluggable equipment, the power outlet socket must be located near the equipment and easily accessible.
5. Protect the equipment from humidity.
6. Do not expose the equipment to direct sunlight, or install the equipment in an environment with direct sunlight, as this may cause damage.
7. Place the equipment on a reliable surface during installation. Dropping or letting the equipment fall may cause damage.
8. The openings on the enclosure are for air convection. Protect the equipment from overheating. Do not cover the openings.
9. Ensure that the voltage of the power source is correct before connecting the equipment to a power outlet.
10. Position the power cord away from high-traffic areas. Do not place anything over the power cord.
11. All cautions and warnings on the equipment should be noted.
12. If the equipment is not used for a long time, disconnect it from the power source to avoid damage from transient overvoltage.
13. Be aware that the rear cover may become quite hot during operation. To avoid scalding or personal injury, do not touch the rear cover.
14. Never pour any liquid into an opening. This may cause fire or electric shock.
15. Never open the equipment. For safety reasons, the equipment should be opened only by qualified service personnel.
16. If one of the following occurs, have the equipment checked by qualified service personnel:
  - The power cord or plug is damaged.
  - Liquid has penetrated the equipment.
  - The equipment has been exposed to moisture.
  - The equipment is malfunctioning or does not work according to the user manual.
  - The equipment has been dropped and damaged.
  - The equipment shows obvious signs of breakage.
17. Do not leave the equipment in an environment with a storage temperature of below -20 °C (-4 °F) or above 60 °C (140 °F) as this may cause damage. The equipment should be located in a controlled environment.
18. Batteries are at risk of exploding if incorrectly replaced or installed. Replace only with the same or equivalent type recommended by the manufacturer. Discard used batteries according to the manufacturer's instructions.
19. Danger d'explosion si la pile est remplacée de façon incorrecte. Remplacez seulement avec le même type ou équivalent recommandé par le fabricant. Disposer des piles usagées selon les instructions du fabricant.
20. The equipment is intended to be installed on a wall or in a cabinet with the following conditions: access is restricted to service personnel or users who are aware of all precautions that must be taken when using the equipment; access can only be gained with the use of a key or other means of security; access is controlled by the authority responsible for the location.
21. In accordance with the IEC 704-1:1982 specifications, the sound pressure level at the operator's position does not exceed 70 dB (A).

22. **DISCLAIMER:** These instructions are provided in accordance with IEC 704-1 specifications. Advantech disclaims all responsibility for the accuracy of any statements contained herein.

## Document Feedback

To assist us with improving this manual, we welcome all comments and constructive criticism. Please send all feedback in writing to [support@advantech.com](mailto:support@advantech.com).

# Contents

<b>Chapter 1</b>	<b>General Information .....</b>	<b>1</b>
1.1	Introduction .....	2
1.2	Specifications .....	2
1.2.1	General .....	2
1.2.2	System Hardware .....	3
1.2.3	LCD Panel.....	4
1.2.4	Touchscreen .....	5
1.2.5	Safety and Environmental.....	5
1.2.6	Operating Systems .....	6
1.3	I/O Layout.....	6
	Figure 1.1 I/O Layout .....	6
1.4	Dimensions and Cutouts .....	7
1.4.1	TPC-312 Series .....	7
	Figure 1.2 TPC-312 Dimensions .....	7
1.4.2	TPC-315 Series .....	8
	Figure 1.3 TPC-315 Dimensions .....	8
1.4.3	TPC-317 Series .....	9
	Figure 1.4 TPC-317 Dimensions .....	9
1.4.4	TPC-324W Series .....	10
	Figure 1.5 TPC-324W Dimensions .....	10
1.4.5	TPC-B510 Series .....	11
	Figure 1.6 TPC-B510 Dimensions .....	11
<b>Chapter 2</b>	<b>Installation.....</b>	<b>13</b>
2.1	Transport and Unpacking.....	14
2.1.1	Transport.....	14
2.1.2	Unpacking .....	14
	Figure 2.1 Power Connector and Power Lines .....	14
	Figure 2.2 Power Connector .....	15
2.2	Panel Mounting .....	15
	Figure 2.3 Panel Mounting – Positioning .....	15
	Figure 2.4 Panel Mounting – Clamp Attachment .....	16
	Figure 2.5 Panel Mounting – Clamp Fixing.....	16
2.3	VESA Mounting.....	17
	Figure 2.6 VESA Mounting .....	17
2.4	Cabinet Installation and Grounding.....	17
2.4.1	Cabinet Installation .....	18
	Figure 2.7 Cabinet Installation .....	18
2.4.2	System Wiring.....	18
	Figure 2.8 System Wiring Diagram.....	19
2.5	Power/Digital Ground and Earth/Ground .....	20
	Figure 2.9 TPC Chassis and Power Supply .....	20
<b>Chapter 3</b>	<b>Windows Embedded Features .....</b>	<b>21</b>
3.1	Windows Embedded Features .....	22
3.2	Unified Write Filter (UWF) .....	22
	Figure 3.1 Enabling UWF - Step 1 .....	22
	Figure 3.2 Enabling UWF - Step 2 .....	23
3.3	UWF Overlay.....	23
	Figure 3.3 UWF Overlay Settings - Step 1 .....	24
	Figure 3.4 UWF Overlay Settings - Step 2 .....	24

	Figure 3.5 UWF Overlay Settings - Step 3 .....	25
	Figure 3.6 UWF Overlay Settings - Step 4 .....	25
	Figure 3.7 UWF Overlay Settings - Step 5 .....	26
3.4	HORM .....	26
	Figure 3.8 HORM Settings - Step 1 .....	27
	Figure 3.9 HORM Settings - Step 2 .....	27

## Appendix A Serial Port Settings ..... 29

A.1	Jumper and Connector Locations .....	30
A.1.1	Board Layout .....	30
	Figure A.1 Board Layout - Top View .....	30
	Figure A.2 Board Layout - Underside View .....	30
	Table A.1: Connectors and Jumpers .....	30
A.2	Jumper Settings, and Descriptions .....	31
A.2.1	CMOS Clear Function (JP1) .....	31
	Table A.2: CMOS Clear Function (JP1) .....	31
A.3	Connector Pin Definition .....	31
A.3.1	SATA Connector (CN37) .....	31
	Table A.3: SATA Connector (CN37) .....	31
A.3.2	SATA Power Connector (CN24) .....	32
	Table A.4: SATA Power Connector (CN24) .....	32
A.3.3	Mini PCIe Slot (CN31 MINIPCI-E) .....	33
	Table A.5: Mini PCIe Slot (CN31 MINIPCI-E) .....	33
A.3.4	M.2 (M-Key) Slot (CN17 NVMe/SATA Storage) .....	34
	Table A.6: M.2 (M-Key) Slot (CN17 NVMe/SATA Storage) .....	34
A.3.5	M.2 (B-Key) Slot (CN26 PCIe/USB/SATA) .....	35
	Table A.7: M.2 (B-Key) Slot (CN26 PCIe/USB/SATA) .....	35
A.3.6	Power Input Connector (CN1) .....	36
	Table A.8: Power Input Connector (CN1) .....	36
A.3.7	LAN RJ45 Connector (CN9) .....	36
	Table A.9: LAN RJ45 Connector (CN9) .....	36
	Table A.10: LED .....	37
A.3.8	USB Connectors (CN19, CN20, CN21) .....	37
	Table A.11: USB Connector (CN19, CN20) .....	37
	Table A.12: USB Connector (CN21) .....	38
A.3.9	COM1 RS-232/422/485 Connector (COM1) .....	38
	Table A.13: COM1 RS-232/422/485 Connector (COM1) .....	38
A.3.10	COM2 RS-232 Connector (COM2) .....	39
	Table A.14: COM2 RS-232 Connector (COM2) .....	39
A.3.11	DisplayPort Connector (CN36) .....	39
	Table A.15: DisplayPort Connector (CN36) .....	39
A.3.12	Audio Connector (CN38) .....	40
	Table A.16: Audio Connector (CN38) .....	40
A.3.13	SIM Connector (CN10) .....	41
	Table A.17: SIM Connector (CN10) .....	41

## Appendix B Driver Installation & Configuration . 43

B.1	Intel Chipset Software Installation Utility .....	44
B.2	Intel Graphics Driver Installation .....	46
B.3	LAN Driver Installation .....	49
B.4	Intel Management Engine Installation .....	52
B.5	Touch Driver Installation .....	55

## Appendix C BIOS Setup ..... 59

C.1	Entering Setup .....	60
-----	----------------------	----



C.1.1	Main Setup.....	61
C.1.2	Advanced BIOS Features Setup.....	62
C.1.3	Chipset Configuration .....	71
C.1.4	Security .....	73
C.1.5	Boot.....	74
C.1.6	Save & Exit .....	75



# Chapter 1

## General Information

## 1.1 Introduction

The TPC-300 series touch panel computers are human machine interfaces (HMIs) equipped with an Intel® Core™ i3-8145UE dual-core (2.20 GHz)/i5-8365UE quad-core (1.60 GHz)/i7-8665UE quad-core (1.70 GHz) processor and feature displays that range from 12" to 23.8" in size.

TPC-B510 is a modular computing box that features an Intel® Core™ i3-8145UE dual-core (2.20 GHz)/i5-8365UE quad-core (1.60 GHz)/i7-8665UE quad-core (1.70 GHz) processor that can be flexibly integrated with Advantech's FPM display modules according to specific usage requirements. For information about the FPM display module series, visit the Advantech website.

### Key Features

- **True-Flat Touchscreen**  
True-flat touchscreen with IP66-rated ingress protection
- **Fanless Design**  
The fanless system design, combined with a low-power processor, minimizes the accumulation and circulation of dust and other contaminants
- **Dual-Channel DDR4 SODIMM**  
Dual memory slots support up to 32GB of memory
- **NVMe High-Speed Storage**  
M.2 (M key) connector supports NVMe PCIe x4 for high-speed storage
- **iDoor Technology**  
Supports Advantech's iDoor technology for integrating additional I/O, isolated DI/O, and fieldbus modules
- **DisplayPort and Audio Line-Out/Mic-In**  
Supports multimedia
- **TFT LED LCD Display**  
The TFT LED LCD display provides high-quality imaging, ideal for industrial applications
- **Wide Operating Temperature Range**
- **Isolation Protection**

## 1.2 Specifications

### 1.2.1 General

- **BIOS:** AMI UEFI BIOS
- **Certification:** BSMI, CCC, CE, FCC Class A, CB/UL
- **Cooling System:** Fanless design
- **Dimensions (L x W x H):**
  - TPC-312: 410.4 x 343.4 x 68 mm/16.16 x 13.52 x 2.68 in
  - TPC-315: 383.2 x 307.3 x 66.5 mm/15.09 x 12.1 x 2.62 in
  - TPC-317: 410.4 x 343.4 x 68 mm/16.16 x 13.52 x 2.68 in
  - TPC-324W: 595.9 x 374.1 x 70 mm/23.46 x 14.73 x 2.76 in
  - TPC-B510: 269 x 203 x 40 mm/10.6 x 8.0 x 1.6 in
- **Enclosure:**
  - Front bezel: Die cast aluminum alloy
  - Rear housing: Die cast aluminum alloy
- **Mount Options:** VESA, desktop, wall, or panel
- **Power Input:** 24 V<sub>DC</sub> ± 20%

- **Watchdog Timer:** 15 ~ 255 sec (system)
- **Weight (Net):**
  - TPC-315: 5.8 kg/12.79 lb
  - TPC-324W: 9.3 kg/20.5 lb
  - TPC-B510: 2.6 kg/5.73 lb
- **Power Consumption:**  
This product is intended to be supplied by a IEC/UL 60950-1/IEC/UL 62368-1-recognized limited power source that is rated as follows:
  - TPC-315: 36.79 W (typical)  
24 V<sub>DC</sub>, minimum 5A, minimum operating temperature 55 °C/131 °F
  - TPC-324W: 56.31 W (typical)  
24 V<sub>DC</sub>, minimum 5A, minimum operating temperature 50 °C/122 °F
  - TPC-B510: 28.64 W (typical)  
24 V<sub>DC</sub>, minimum 5A, minimum operating temperature 55 °C/131°F

## 1.2.2 System Hardware

- **CPU:** 8th gen. Intel® Core™ i

Model Number	Processor
TPC-312-R833A	Intel® Core™ i3- 8145UE, 2.20 GHz
TPC-312-R853A	Intel® Core™ i5-8365UE, 1.60 GHz
TPC-312-R873A	Intel® Core™ i7-8665UE, 1.70 GHz
TPC-315-R833A	Intel® Core™ i3- 8145UE, 2.20 GHz
TPC-315-R853A	Intel® Core™ i5-8365UE, 1.60 GHz
TPC-315-R873A	Intel® Core™ i7-8665UE, 1.70 GHz
TPC-317-R833A	Intel® Core™ i3- 8145UE, 2.20 GHz
TPC-317-R853A	Intel® Core™ i5-8365UE, 1.60 GHz
TPC-317-R873A	Intel® Core™ i7-8665UE, 1.70 GHz
TPC-324W-P833A	Intel® Core™ i3- 8145UE, 2.20 GHz
TPC-324W-P853A	Intel® Core™ i5-8365UE, 1.60 GHz
TPC-324W-P873A	Intel® Core™ i7-8665UE, 1.70 GHz
TPC-B510-833AE:	Intel® Core™ i3- 8145UE, 2.20 GHz
TPC-B510-853AE:	Intel® Core™ i5-8365UE, 1.60 GHz
TPC-B510-873AE:	Intel® Core™ i7-8665UE, 1.70 GHz

- **Memory:** 8GB DDR4 SODIMM (built-in)
- **LAN:** 2 x 10/100/1000BASE-T
- **Expansion Slot:** 1 x Full-size mini PCIe
- **Storage Slots:**
  - 1 x M.2 (M-key): 2280 SATA; NVMe PCIe x4
  - 1 x M.2 (B-key): 2242 SATA; 3042/3052 LTE/5G slot 7
  - 1 x 2.5" SATA SSD
- **I/O Ports:**
  - 2 x RS-232/422/485
  - 1 x USB 2.0
  - 4 x USB3.2 (Gen 2)
  - 1 x iDoor slot
  - 1 x DisplayPort (video output)
  - 1 x Audio Line-Out/Mic-In

## 1.2.3 LCD Panel

### TPC-312

- **Display Type:** XGA TFT LED LCD
- **Display Size:** 12" (4:3)
- **Max. Resolution:** 1024x768
- **Max. Color:** 16.2M
- **Luminance (cd/m<sup>2</sup>):** 300
- **Viewing Angle (H°/V°):** 178°/178°
- **Backlight Life:** 50,000 hrs
- **Contrast Ratio:** 1000:1

### TPC-315

- **Display Type:** XGA TFT LED LCD
- **Display Size:** 15" (4:3)
- **Max. Resolution:** 1024x768
- **Max. Color:** 16.7M
- **Luminance (cd/m<sup>2</sup>):** 300
- **Viewing Angle (H°/V°):** 176°/176°
- **Backlight Life:** 70,000 hrs
- **Contrast Ratio:** 2000:1

### TPC-317

- **Display Type:** SXGA TFT LED LCD
- **Display Size:** 17" (4:3)
- **Max. Resolution:** 1280x1024
- **Max. Color:** 16.7M
- **Luminance (cd/m<sup>2</sup>):** 300
- **Viewing Angle (H°/V°):** 160°/140°
- **Backlight Life:** 50,000 hrs
- **Contrast Ratio:** 800:1

### TPC-324W

- **Display Type:** FHD TFT LED LCD
- **Display Size:** 23.8" (16:9)
- **Max. Resolution:** 1920x1080
- **Max. Color:** 16.7M
- **Luminance (cd/m<sup>2</sup>):** 350
- **Viewing Angle (H°/V°):** 178°/178°
- **Backlight Life:** 50,000 hrs
- **Contrast Ratio:** 1000:1

## 1.2.4 Touchscreen

### TPC-312

- **Lifespan:** 36 million touches at a single point
- **Light Transmission:** Above 75%
- **Resolution:** Linearity
- **Type:** 5-wire analog resistive

### TPC-315

- **Lifespan:** 36 million touches at a single point
- **Light Transmission:** Above 75%
- **Resolution:** Linearity
- **Type:** 5-wire analog resistive

### TPC-317

- **Lifespan:** 36 million touches at a single point
- **Light Transmission:** Above 75%
- **Resolution:** Linearity
- **Type:** 5-wire analog resistive

### TPC-324W

- **Light Transmission:** 90% ± 3%
- **Type:** Projected capacitive

**Note!** *The TPC-B510 modular computing box does not come with a display or touch panel.*



## 1.2.5 Safety and Environmental

### 1.2.5.1 Safety

- FCC Class A
- CE certified

### 1.2.5.2 Environmental

#### TPC-312

- **Humidity:** 10 ~ 95% RH @ 40 °C/104 °F, non-condensing
- **Ingress Protection:** IP66-rated front panel
- **Operating Temperature:** -10 ~ 55 °C/14 ~ 131 °F (without airflow)
- **Storage Temperature:** -20 ~ 70 °C/-4 ~ 158 °F
- **Vibration Protection:** With SSD: 1 Grms (5 ~ 500 Hz) (operating, random)

#### TPC-315

- **Humidity:** 10 ~ 95% relative humidity @ 40 °C/104 °F, non-condensing
- **Ingress Protection:** IP66-rated front panel
- **Operating Temperature:** -10 ~ 55 °C/14 ~ 131 °F (without airflow)
- **Storage Temperature:** -20 ~ 70 °C/-4 ~ 158 °F
- **Vibration Protection:** With SSD: 1 Grms (5 ~ 500 Hz) (operating, random)

### TPC-317

- **Humidity:** 10 ~ 95% RH @ 40 °C/104 °F, non-condensing
- **Ingress Protection:** IP66-rated front panel
- **Operating Temperature:** -10 ~ 55 °C/14 ~ 131 °F (without airflow)
- **Storage Temperature:** -20 ~ 70 °C/-4 ~ 158 °F)
- **Vibration Protection:** With SSD: 1 Grms (5 ~ 500 Hz) (operating, random)

### TPC-324W

- **Humidity:** 10 ~ 95% relative humidity @ 40 °C/104 °F, non-condensing
- **Ingress Protection:** IP66-rated front panel
- **Operating Temperature:** -10 ~ 50 °C/14 ~ 122 °F (without airflow)
- **Storage Temperature:** -20 ~ 70 °C/-4 ~ 158 °F
- **Vibration Protection:** With SSD: 1 Grms (5 ~ 500 Hz) (operating, random)

### TPC-B510

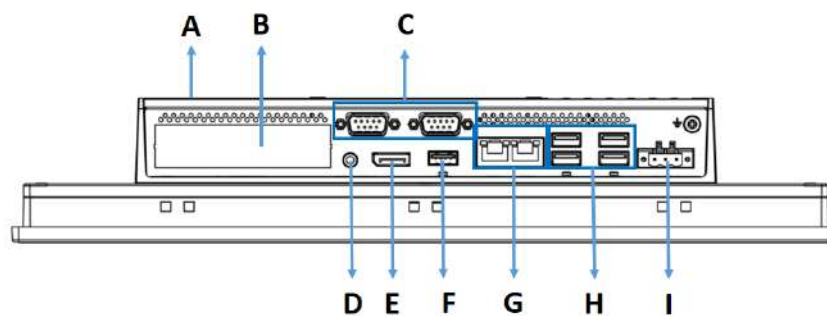
- **Humidity:** 10 ~ 95% relative humidity @ 40 °C/104 °F, non-condensing
- **Ingress Protection:** IP66-rated front panel
- **Operating Temperature:** -10 ~ 55 °C/14 ~ 131 °F (without airflow)
- **Storage Temperature:** -20 ~ 70 °C/-4 ~ 158 °F
- **Vibration Protection:** With SSD: 1 Grms (5 ~ 500 Hz) (operating, random)

## 1.2.6 Operating Systems

- Windows 10
- Android
- AdvLinux

## 1.3 I/O Layout

The I/O the layout for TPC-300 Series and TPC-B510 is shown in Figure 1.1.



- |                          |                      |
|--------------------------|----------------------|
| A. HDD/SSD bay (default) | F. USB 2.0           |
| B. iDoor slot            | G. LAN (10/100/1000) |
| C. RS-232/422/485        | H. USB 3.2 (Gen2)    |
| D. Audio Line-Out/Mic-In | I. Power input       |
| E. DisplayPort           |                      |

**Figure 1.1 I/O Layout**



## 1.4 Dimensions and Cutouts

### 1.4.1 TPC-312 Series

- **Weight (Net):** TBD
- **Dimensions (L x W x H):** 410.4 x 343.4 x 68 mm/16.16 x 13.52 x 2.68 in
- **Cutout Dimensions (L x H):** 303 x 229 mm/11.93 x 9.02 in

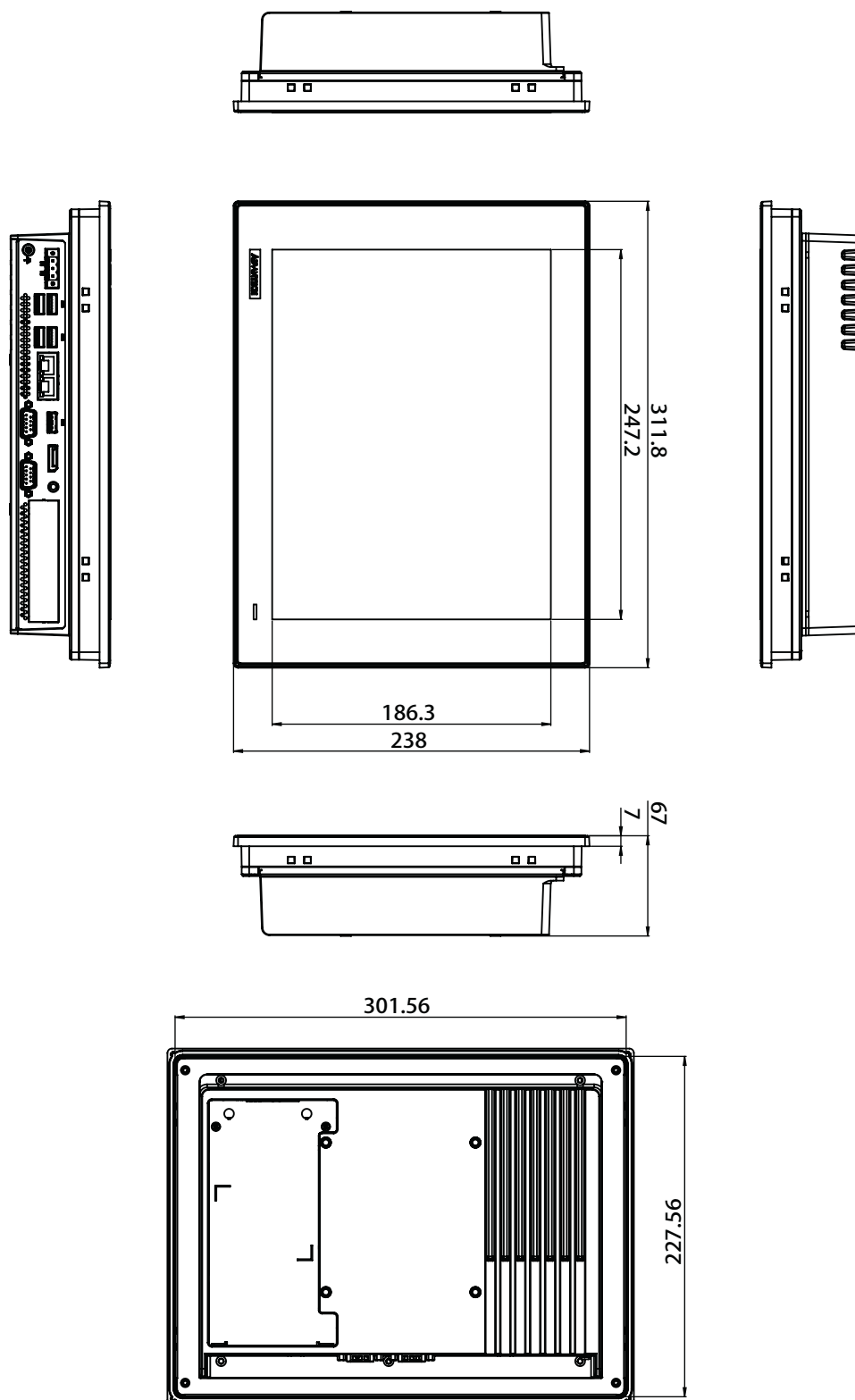


Figure 1.2 TPC-312 Dimensions

## 1.4.2 TPC-315 Series

- **Weight (Net):** 5.8 kg/12.79 lb
- **Dimensions (L x W x H):** 383.2 x 307.3 x 66.5 mm/15.09 x 12.1 x 2.62 in
- **Cutout Dimensions (L x H):** 374.5 x 298.5 mm/14.74 x 11.75 in

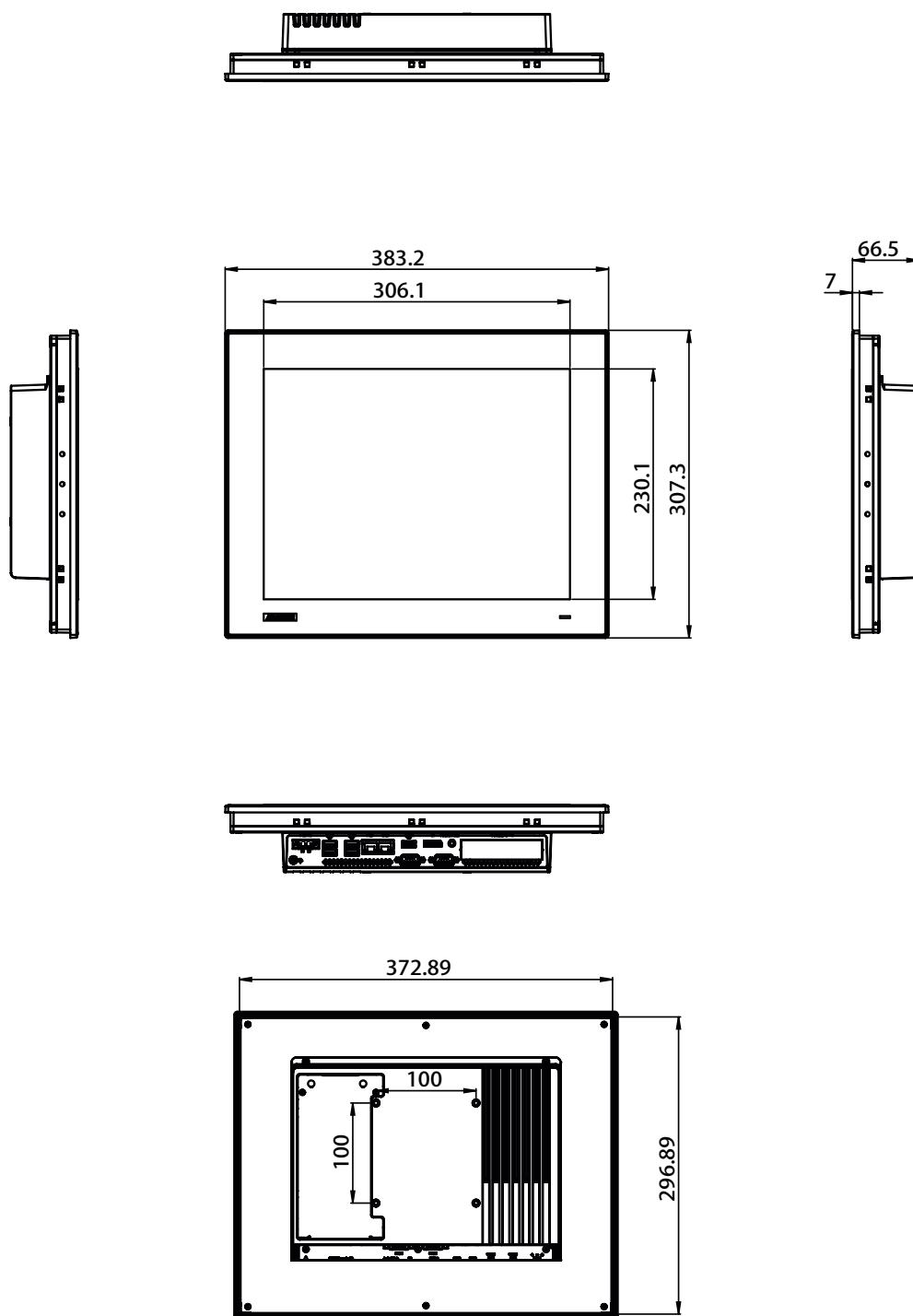


Figure 1.3 TPC-315 Dimensions

### 1.4.3 TPC-317 Series

- **Weight (Net):** TBD
- **Dimensions (L x W x H):** 410.4 x 343.4 x 68 mm/16.16 x 13.52 x 2.68 in
- **Cutout Dimensions (L x H):** 401.3 x 334.8 mm/15.80 x 13.18 in

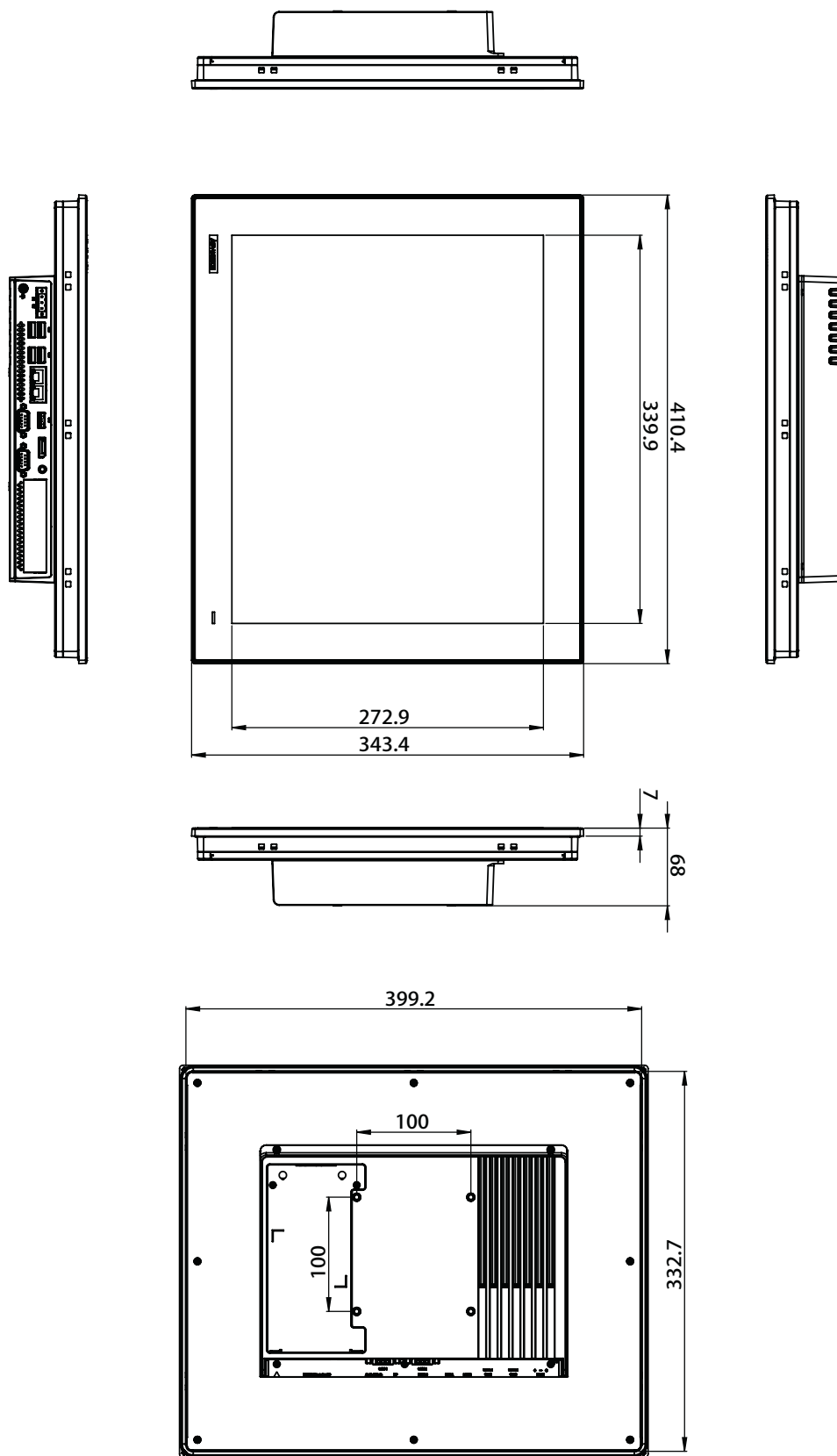


Figure 1.4 TPC-317 Dimensions

### 1.4.4 TPC-324W Series

- **Weight (Net):** 9.3 kg/20.5 lb
- **Dimensions (L x W x H):** 595.9 x 374.1 x 70 mm/23.46 x 14.73 x 2.76 in
- **Cutout Dimensions (L x W):** 587 x 365.3 mm/23.11 x 14.38 in

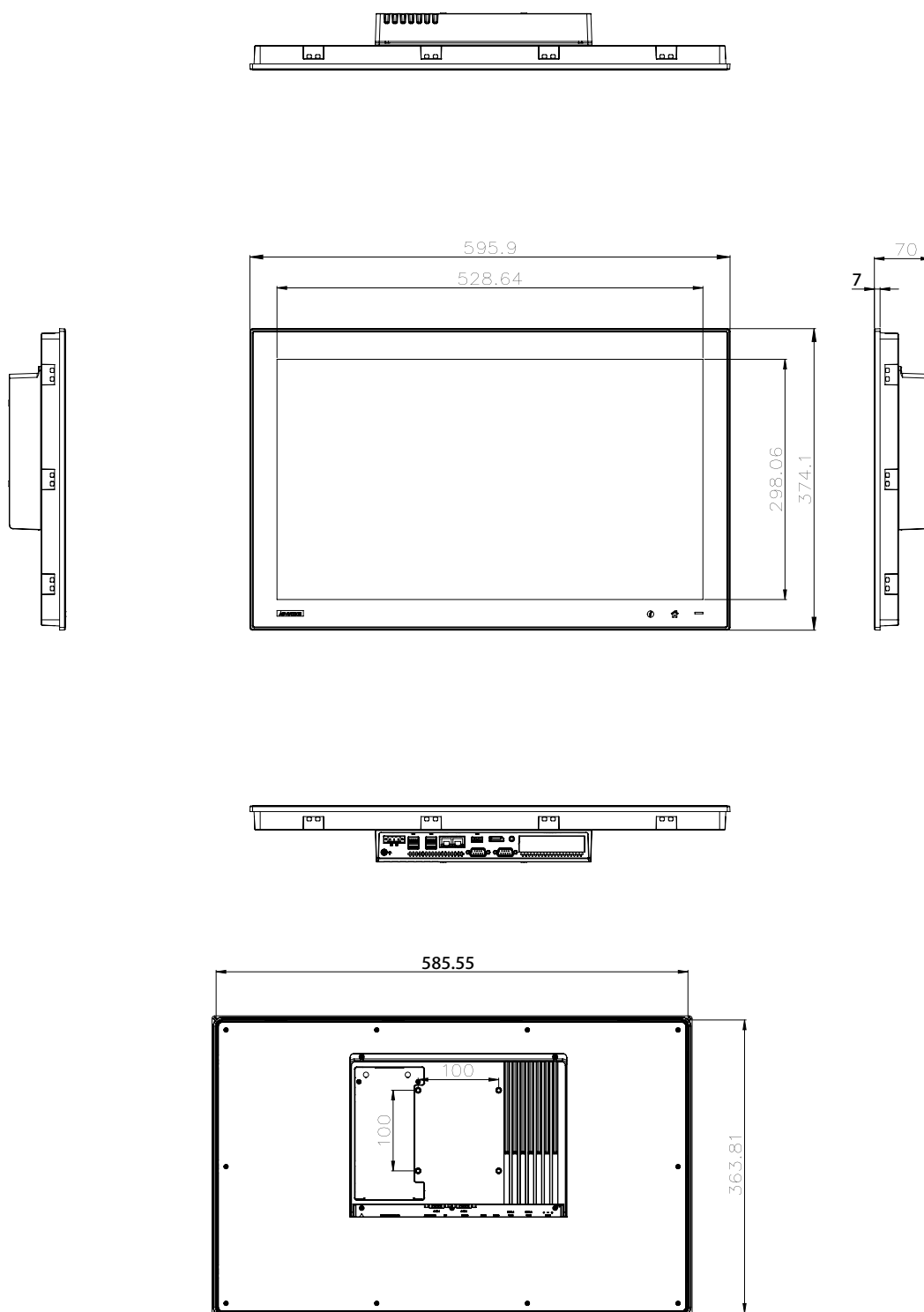


Figure 1.5 TPC-324W Dimensions

### 1.4.5 TPC-B510 Series

- **Weight (Net):** 2.6 kg/5.73 lb
- **Dimensions (L x W x H):** 269 x 203 x 40 mm/10.6 x 8.0 x 1.6 in

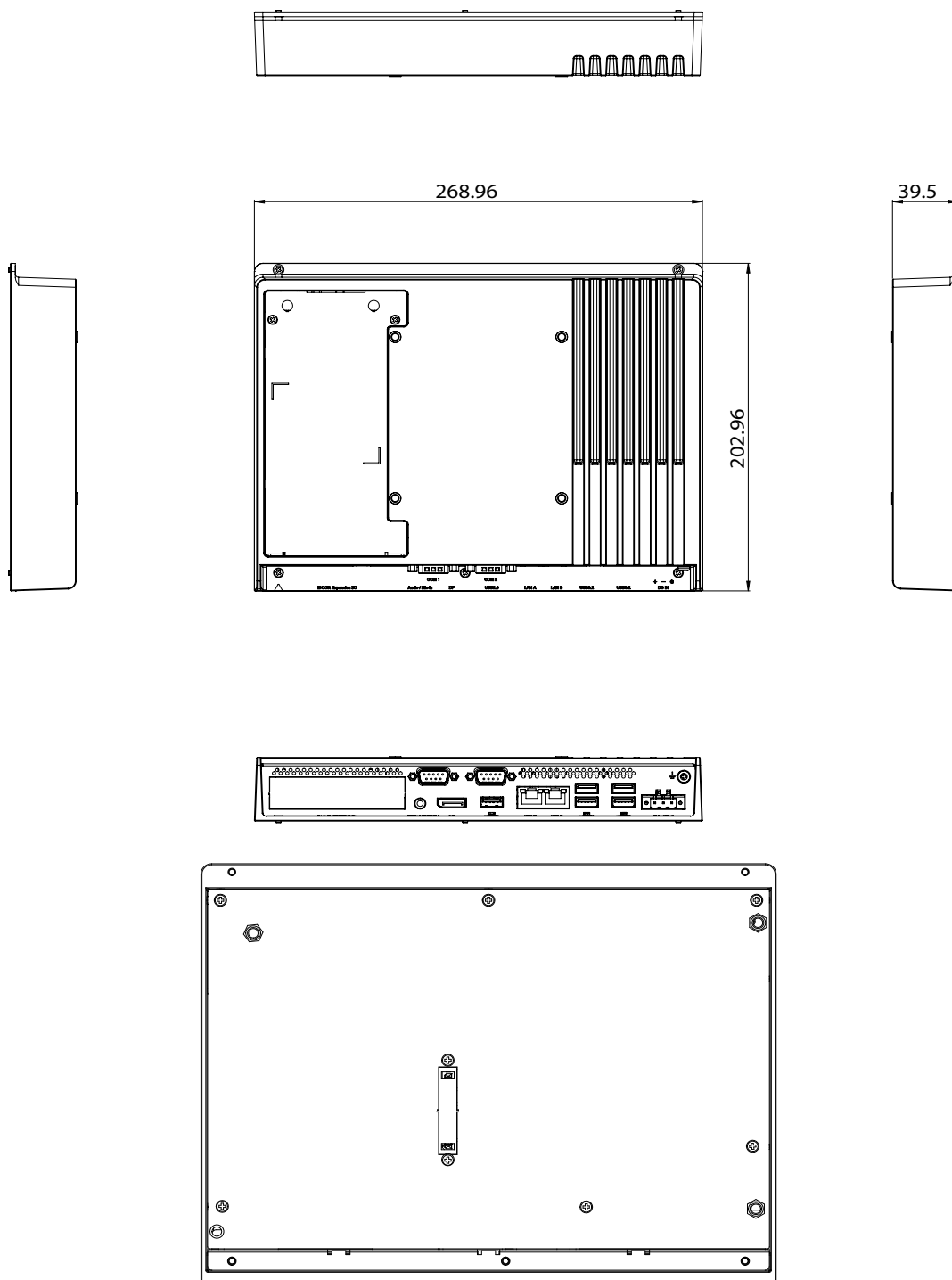


Figure 1.6 TPC-B510 Dimensions



# Chapter 2

## Installation

## 2.1 Transport and Unpacking

### 2.1.1 Transport

After accepting delivery of the product, check the packaging for visible signs of damage during transit. Additionally, check the contents of the shipment for completeness by comparing it with the order details. If you notice any shipping damage or inconsistencies between the contents and your order, inform the responsible delivery service immediately.

During transportation, the product should be protected from excessive mechanical stress. If the product is transported or stored without packaging, shocks, vibrations, pressure, and moisture may impact the unprotected unit. Damaged packaging indicates that ambient conditions have already had a massive impact on the device. Therefore, we recommend using the original packaging during transportation and storage.

If the device is transported in cold weather or exposed to extreme temperature variations, ensure that moisture (condensation) does not accumulate on or inside the device. Moisture can cause electrical circuits to short and damage the device. To avoid exposure to moisture, store the device in a dry place. Additionally, ensure the device is at room temperature before switching it on. If you notice condensation has occurred, wait for approximately 12 hours to allow the device to dry completely before switching it on.

### 2.1.2 Unpacking

1. Unpack the TPC device.
2. Connect the power connector to the 24 V<sub>DC</sub> power lines of a power adapter or in-house power source.

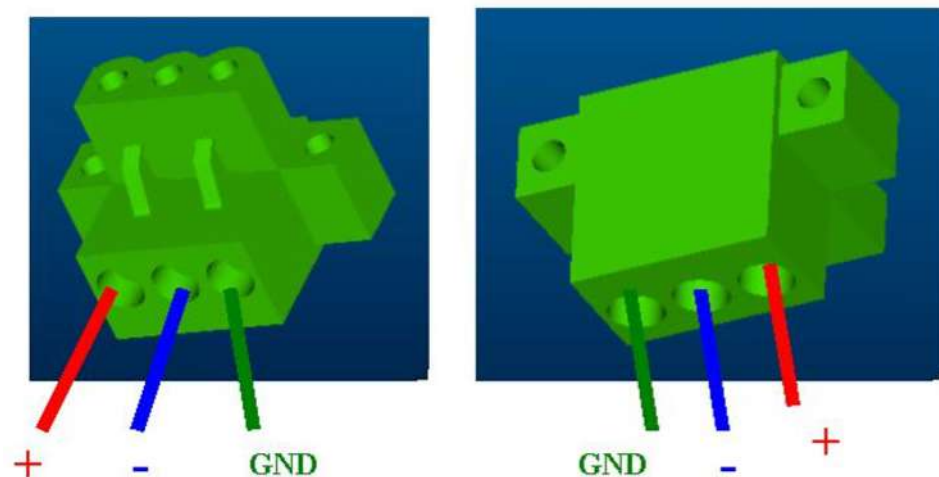
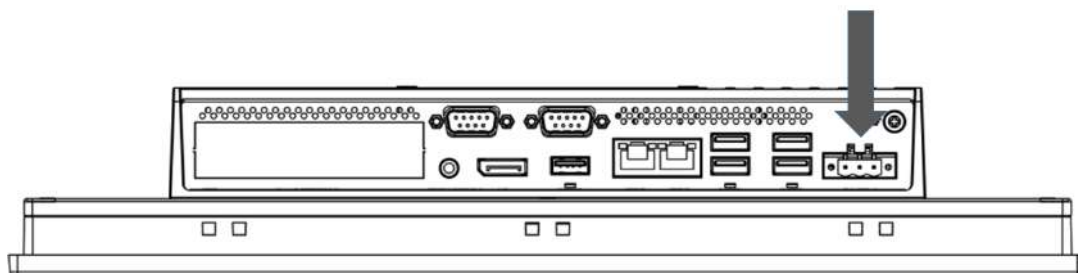


Figure 2.1 Power Connector and Power Lines



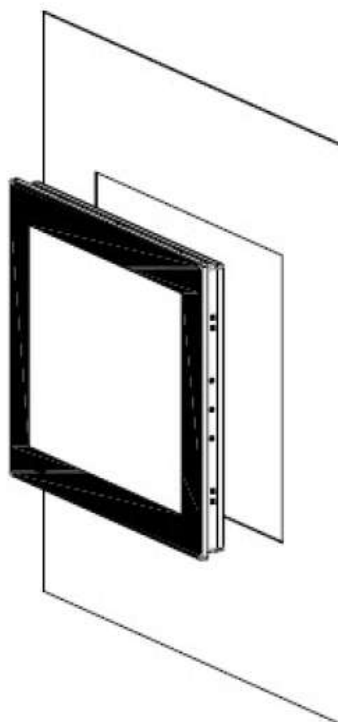


**Figure 2.2 Power Connector**

3. Plug the power lines into the system power receptor.
4. Power on the system.
5. Calibrate the touchscreen.

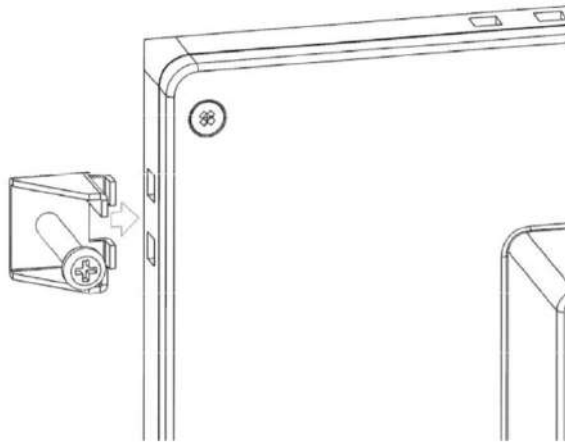
## 2.2 Panel Mounting

1. Position the TPC panel computer against the panel mount.



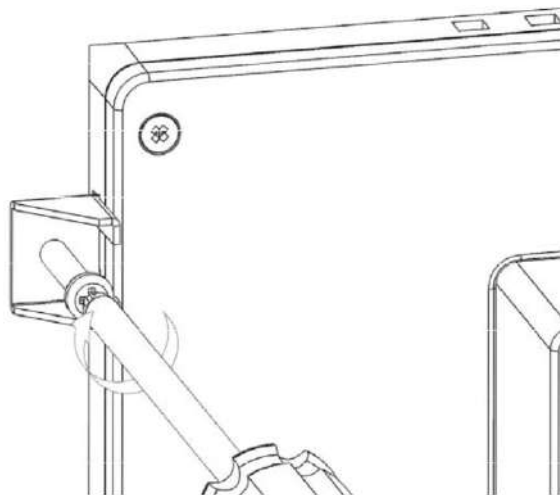
**Figure 2.3 Panel Mounting – Positioning**

2. Attach clamps to the side of the TPC panel computer.



**Figure 2.4 Panel Mounting – Clamp Attachment**

3. Secure the clamps in place using the M4 x 25L screws provided in the accessory box.  
Torque: 5 kgf-cm (0.5 Nm)



**Figure 2.5 Panel Mounting – Clamp Fixing**

## 2.3 VESA Mounting

1. The TPC-300 series and TPC-B510 support VESA mounting (100x100).
2. M4 x 10 screws are recommended for attaching the TPC devices to the VESA mount bracket.
3. Affix the VESA mount bracket at the top of the rear of the TPC device and fasten in place using four M4 screws.

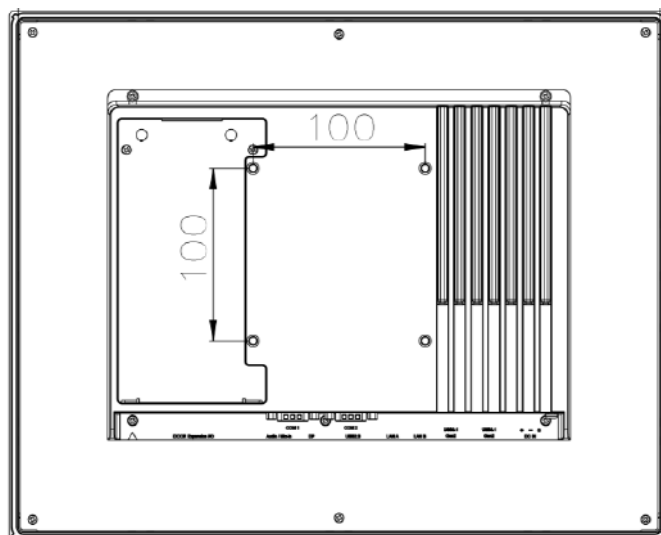


Figure 2.6 VESA Mounting

## 2.4 Cabinet Installation and Grounding

Follow these instructions to install the TPC device into a cabinet. The grounding pin should be physically connected to the earth/ground. The TPC device is designed for optimum EMI immunity, ESD immunity, surge immunity, and system isolation. If the TPC device is installed in a cabinet, the TPC device ground, cabinet ground, and earth/ground should be connected together.

## 2.4.1 Cabinet Installation

1. Connect the cabinet to the earth/ground.
2. Install the TPC device into the cabinet without I/O or power cables.

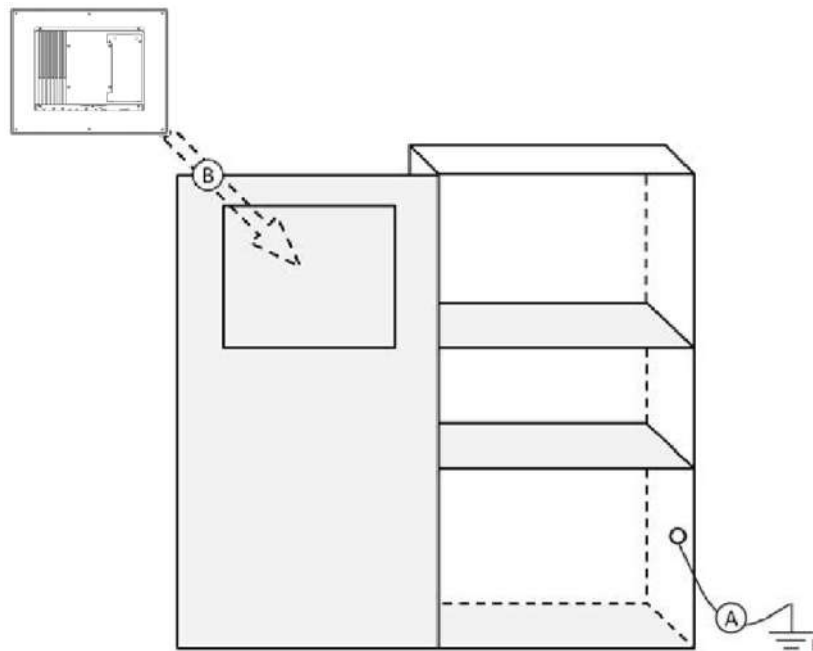
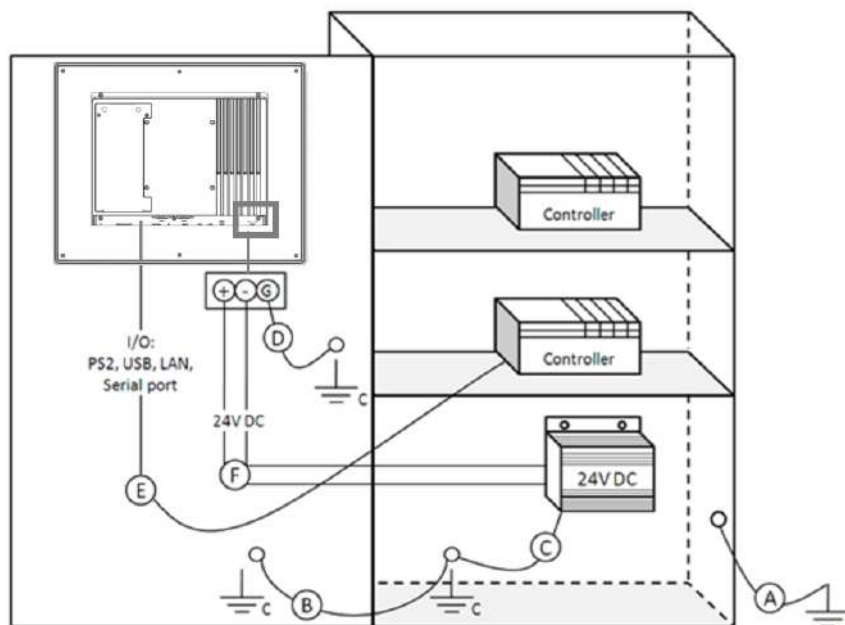


Figure 2.7 Cabinet Installation

## 2.4.2 System Wiring

1. Connect the cabinet to the earth/ground.
2. Ensure that all cabinets have been grounded together.
3. Connect the ground of the power supply to the cabinet.
4. Connect the ground pin of TPC device to the cabinet.
5. Connect the I/O to the controller if needed.
6. Connect the V+ and V- of the power supply to the TPC device.
7. After completing the above steps, activate the power supply.



**Figure 2.8 System Wiring Diagram**

**Note!** *Ensure all wiring follows the installation guidelines to avoid performance issues.*



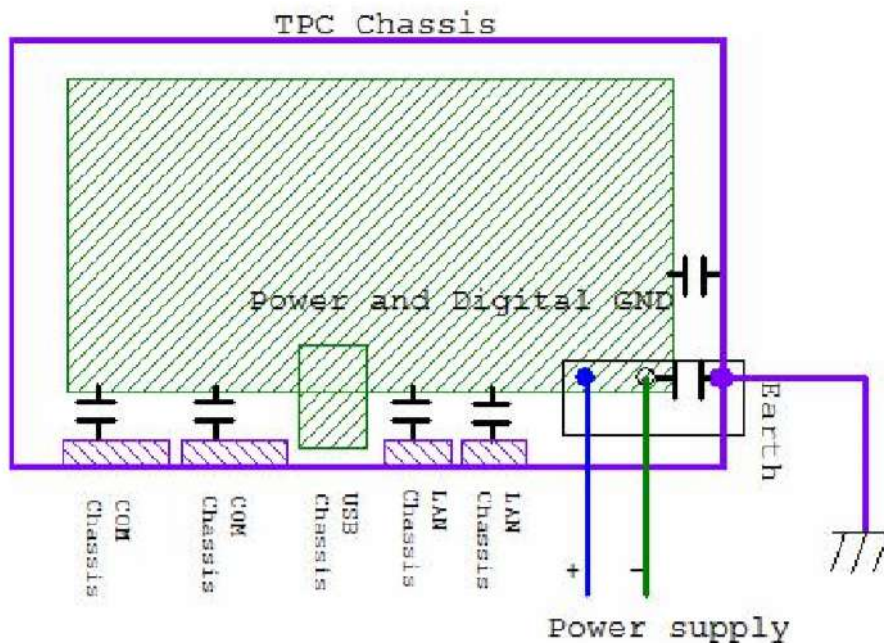
**Note!** *If a USB device or mini PCIe card is installed in the TPC device, double check the voltage between V- and earth/ground. If the voltage is not equal, short the V- and earth/ground wires.*



## 2.5 Power/Digital Ground and Earth/Ground

The power/digital ground blocks external electrical interference to the chassis, thereby ensuring that bad grounding does not cause electric shocks. This is known as Level 1 isolation, which is not typically implemented in consumer-grade devices.

- TPC chassis and ground (Power Pin 3) are short.
- TPC chassis and power/digital ground are open.



**Figure 2.9 TPC Chassis and Power Supply**

The TPC devices are industrial-grade products. The hardware is designed to protect against external interference and eliminate the risk of electric shock. To ensure isolation protection, the following must be considered:

- The Ethernet connection is isolated. LAN connections will not affect the isolation design.
- General USB devices are built to minimize EMI and ESD issues, such as a chassis or digital short. The TPC devices block EMI and ESD, protecting USB devices from damage. The devices are designed to use Power GND as a vent path to ensure Power GND and Chassis GND do not differ abnormally.
- For various COM port designs, long-distance connections can cause voltage differences between the two COM port chassis. Therefore, the shell ground of the cable must be isolated to the signal digital ground.

Use of a third-party device or cable can disrupt Level 1 isolation. In such circumstances, users should short all grounds (Power GND/Digital GND/Earth GND) and ensure adequate earth/ground connection.

# Chapter 3

## Windows Embedded Features

## 3.1 Windows Embedded Features

The TPC devices support embedded Windows platforms. This chapter outlines the important features (UWF and HORM) that are provided with the Windows 10 Enterprise LTSC operating system.

## 3.2 Unified Write Filter (UWF)

A Unified Write Filter (UWF) intercepts all write attempts to a protected volume and redirects those write attempts to a virtual overlay. This improves the reliability and stability of your device and reduces the wear on write-sensitive media, such as flash memory media like SSDs.

- **Important**

UWF is unable to protect external removable drives, USB devices, or flash drives.

The overlay does not mirror the entire volume, but dynamically grows to keep track of redirected writes. Generally the overlay is stored in system memory, although a portion of the overlay can be cached on a physical volume.

- **Note**

UWF fully supports the NTFS file system; however, during device startup, NTFS file system journal files can write to a protected volume before UWF has loaded and started protecting the volume. Advantech provides a utility to operate UWF. Refer to the steps below to enable the utility.

1. Click Start Menu -> Advantech -> Embedded Lockdown Manager -> Enable Unified Write Filter

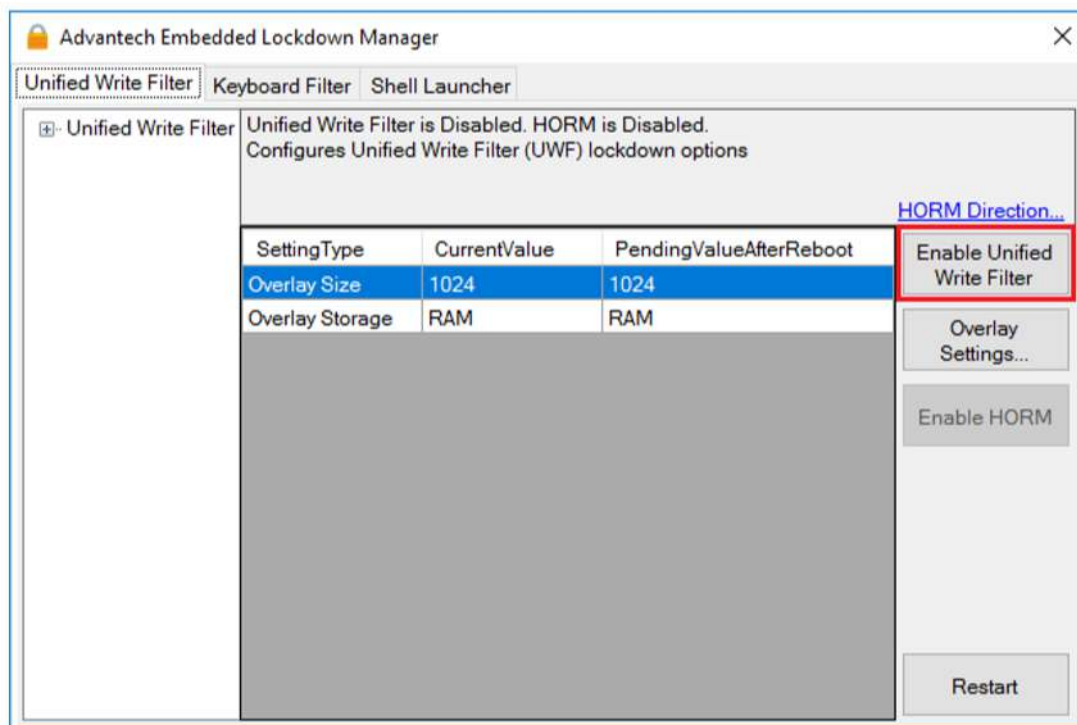


Figure 3.1 Enabling UWF - Step 1



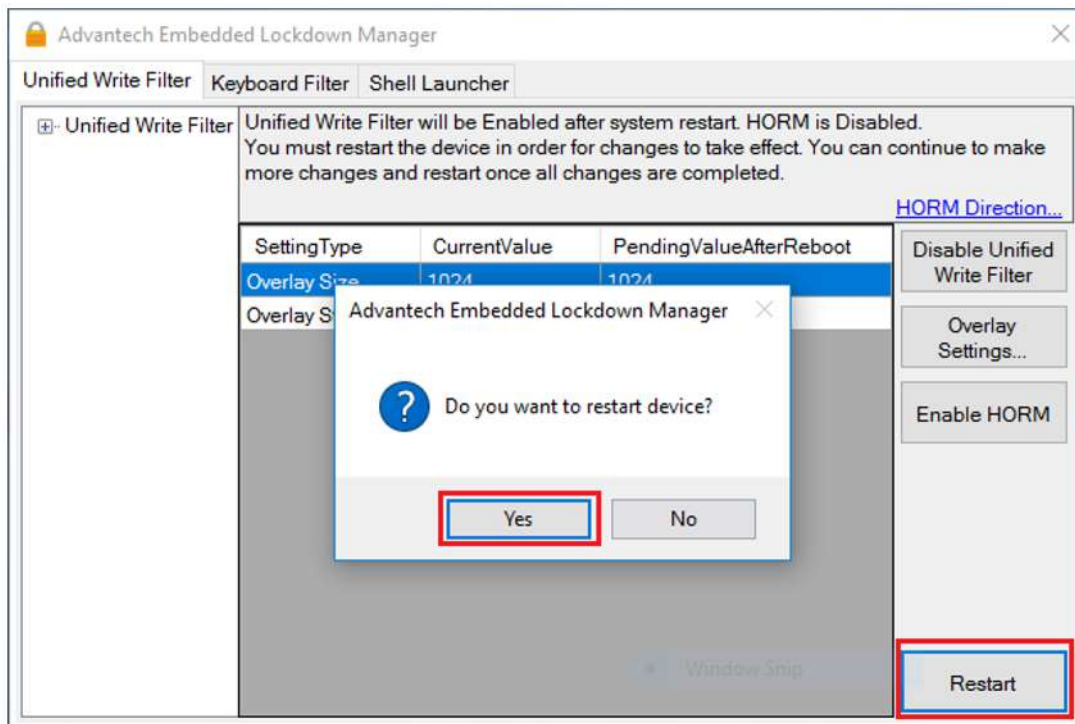


Figure 3.2 Enabling UWF - Step 2

### 3.3 UWF Overlay

UWF protects the contents of a volume by redirecting all write operations on that volume to the overlay, which is a virtual representation of the changes to the volume. Conceptually, an overlay is similar to a transparency overlay on an overhead projector. Any change that is made to the transparency overlay affects the projected picture as it is seen by the viewer. However, if the transparency overlay is removed, the underlying picture remains unchanged.

UWF can store the overlay either entirely on RAM (RAM-based) or in a pre-allocated file on the system volume (disk-based). Advantech provides a utility for configuring a UWF overlay. Refer to the steps below to enable this function.

- Note**  
 UWF function must be disabled in order to configure a UWF overlay. After the configuration is complete, UWF function can be enabled again.

1. Click Start Menu -> Advantech -> AdvELM -> Overlay Settings

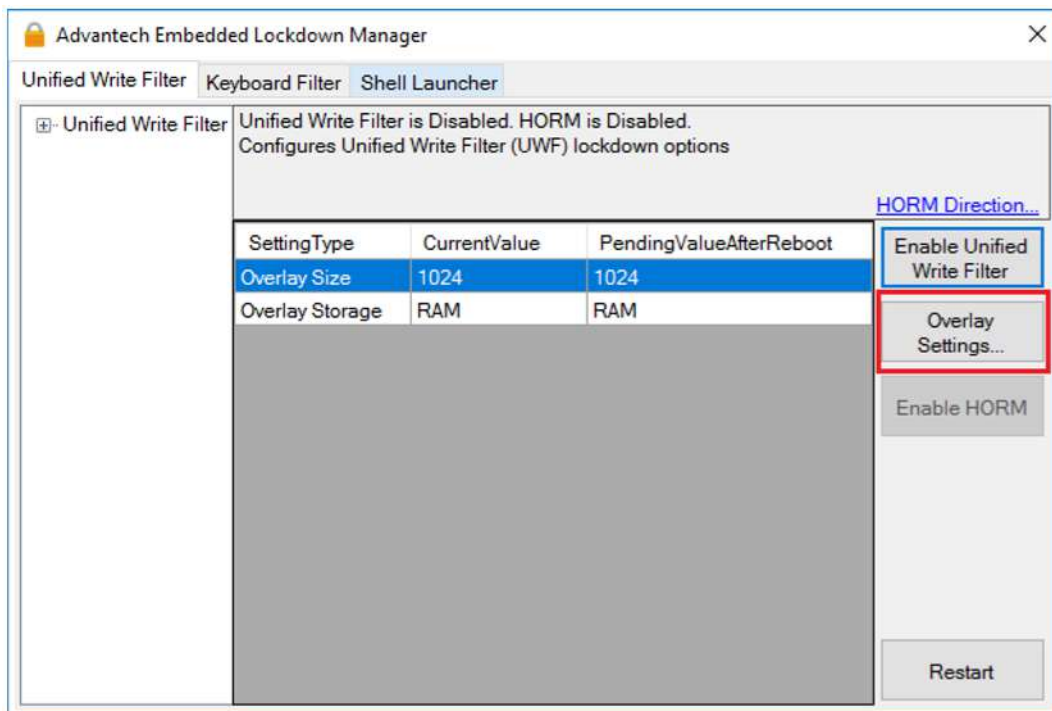


Figure 3.3 UWF Overlay Settings - Step 1

2. Input the desired size (MB).

■ **Important**

When setting up a RAM-based overlay, be sure to leave sufficient available RAM to meet the minimum RAM requirements for system operation. For example, if the OS requires at least 2GB of RAM, and your device has 4GB of RAM, set the size of the overlay to 2GB or less.

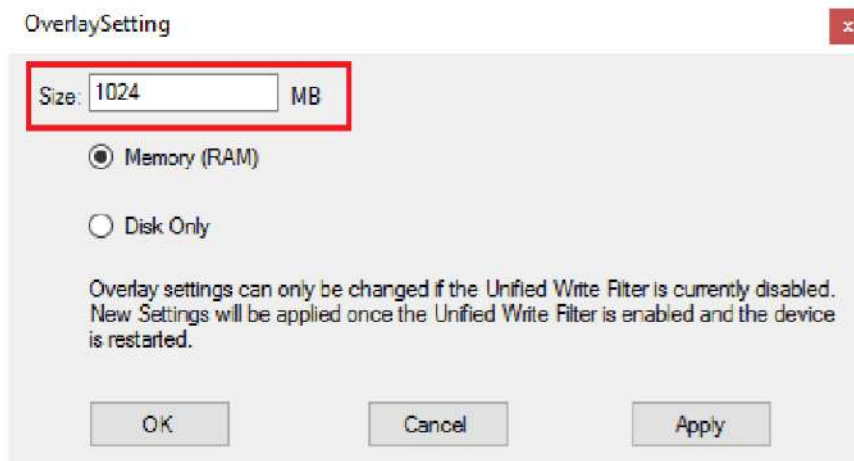
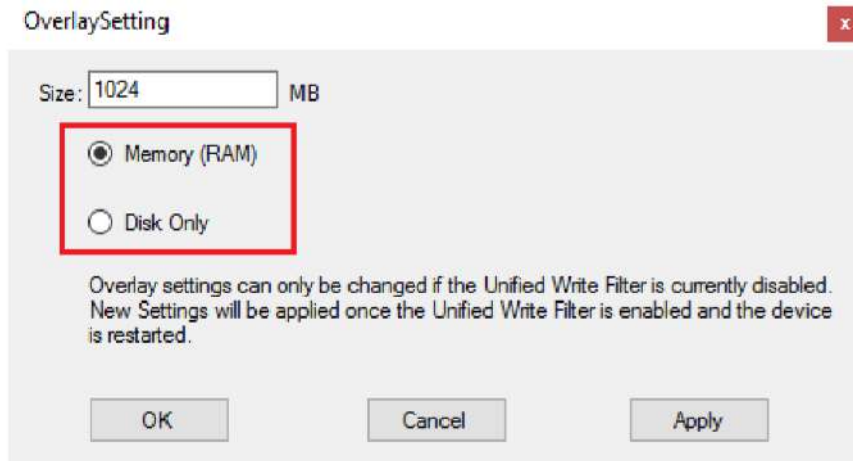


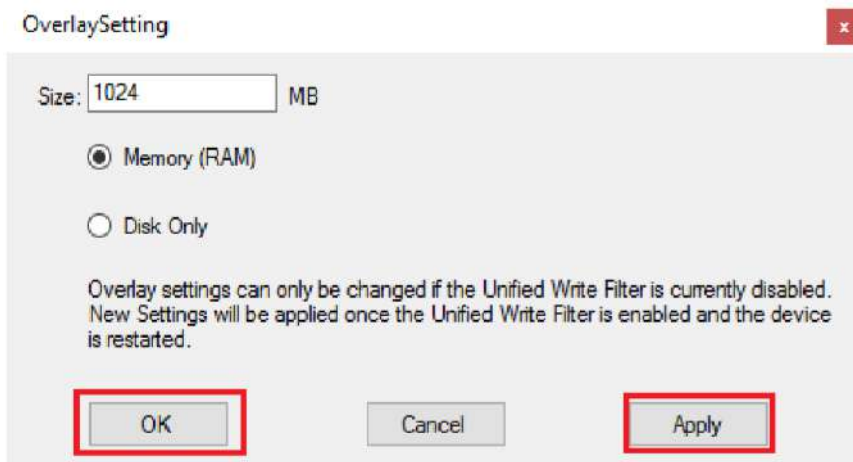
Figure 3.4 UWF Overlay Settings - Step 2

3. Select the mode (RAM or Disk).



**Figure 3.5 UWF Overlay Settings - Step 3**

4. Click OK or Apply.



**Figure 3.6 UWF Overlay Settings - Step 4**

- Click Restart and select Yes to reboot the system. The size will be changed upon boot up.

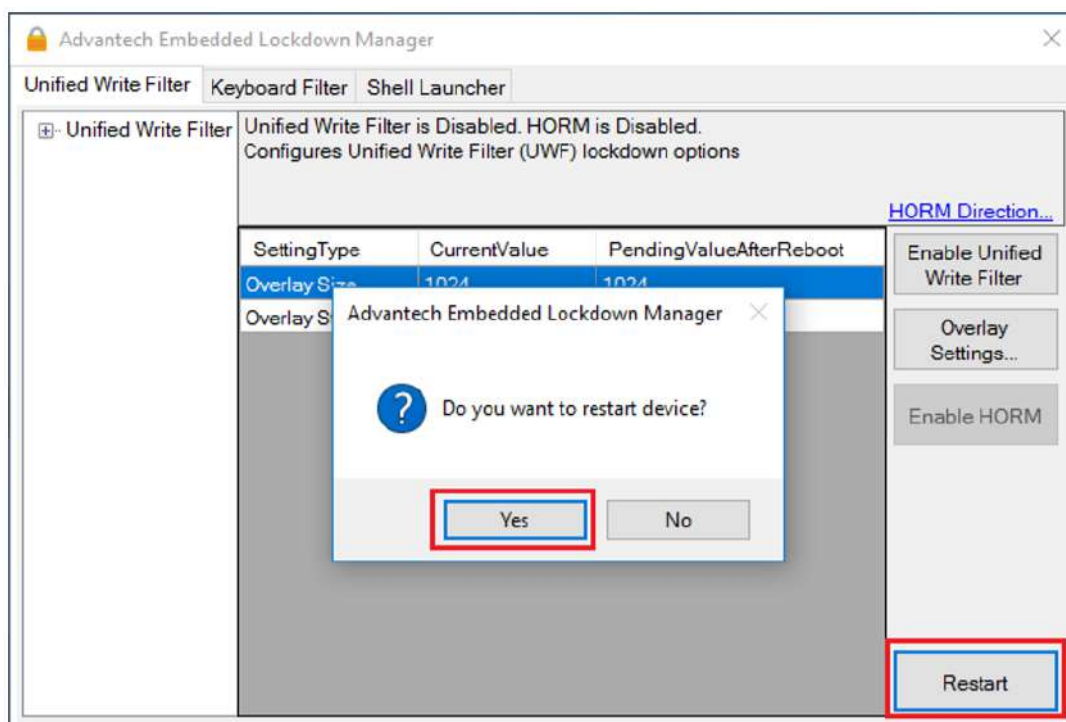


Figure 3.7 UWF Overlay Settings - Step 5

## 3.4 HORM

HORM stands for Hibernate Once/Resume Many. Devices with HORM enabled can be quickly shut down and restarted into a preconfigured state, even in the event of a sudden power loss.

- Important**  
 To setup a HORM environment, follow the steps below.
  - Ensure UWF is enabled.
  - Ensure that the volume(s) is protected.
  - The system must not have any file, folder, or registry exclusions configured for UWF.
  - The UWF overlay must be set to RAM-based mode because HORM does not support disk-based mode.
- Note**  
 HORM cannot be used on a Unified Extensible Firmware Interface (UEFI) device. The installation procedure for UEFI always creates a hidden system partition and the UWF cannot protect hidden partitions. Because HORM requires all fixed partitions to be protected, HORM cannot be used on any devices that contain a hidden partition, including UEFI-capable devices.

1. Click Start Menu -> Advantech -> Embedded Lockdown Manager -> Enable HORM

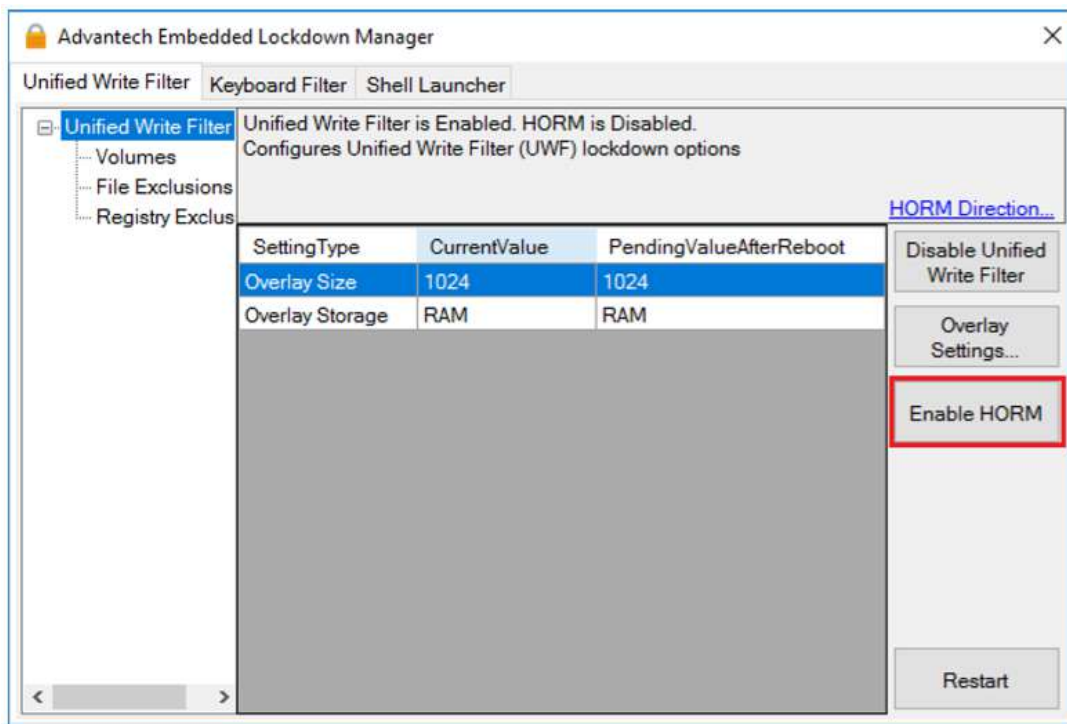


Figure 3.8 HORM Settings - Step 1

2. Click Yes in the popup dialog window.

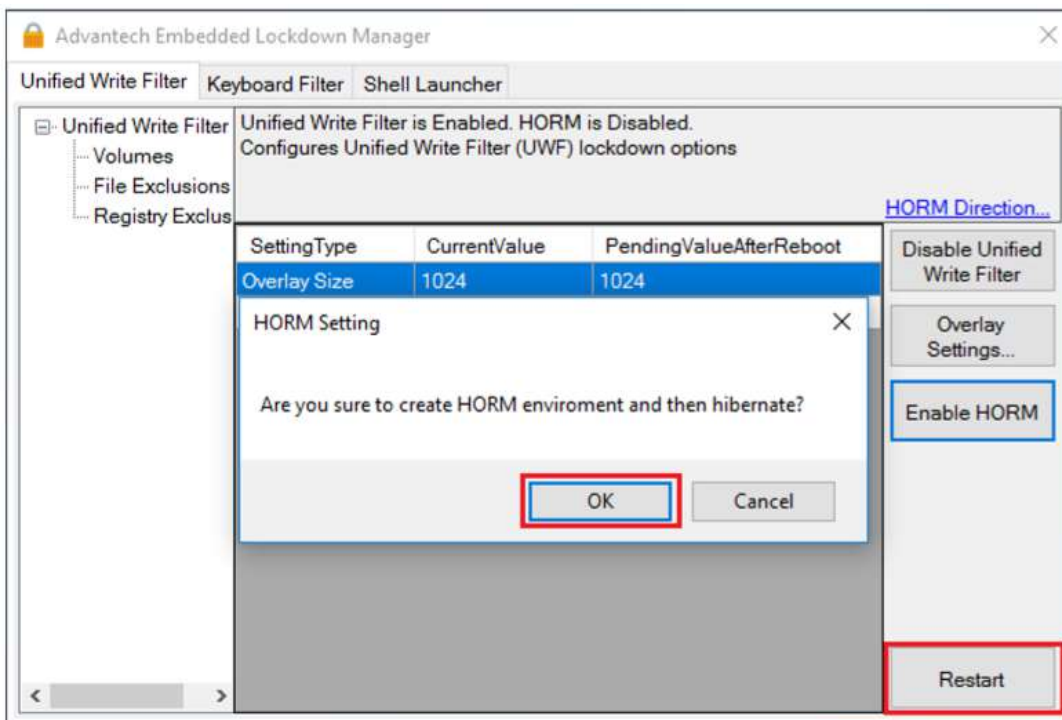


Figure 3.9 HORM Settings - Step 2



# Appendix **A**

## Serial Port Settings

## A.1 Jumper and Connector Locations

### A.1.1 Board Layout

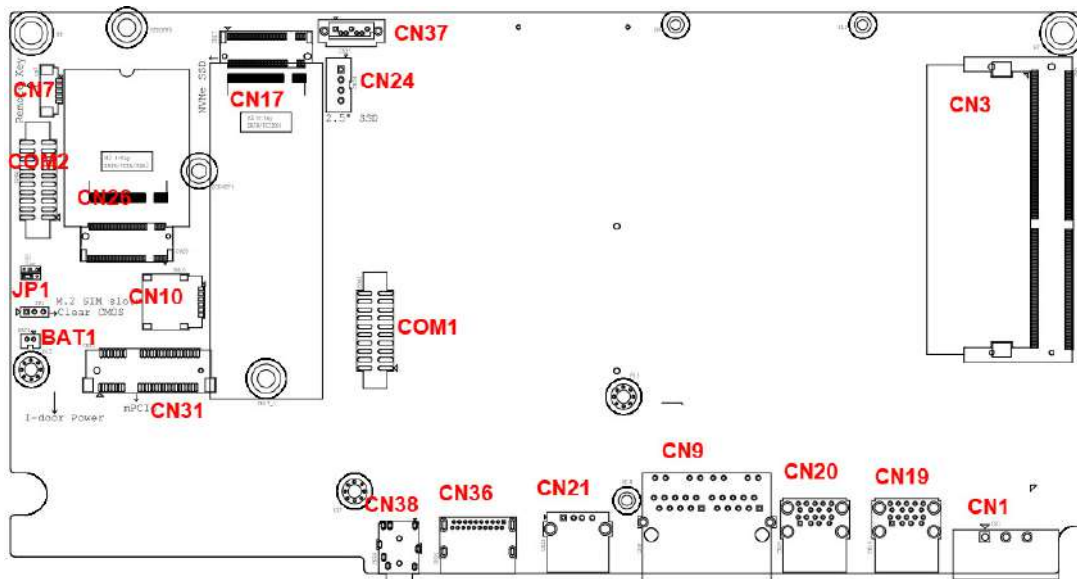


Figure A.1 Board Layout - Top View

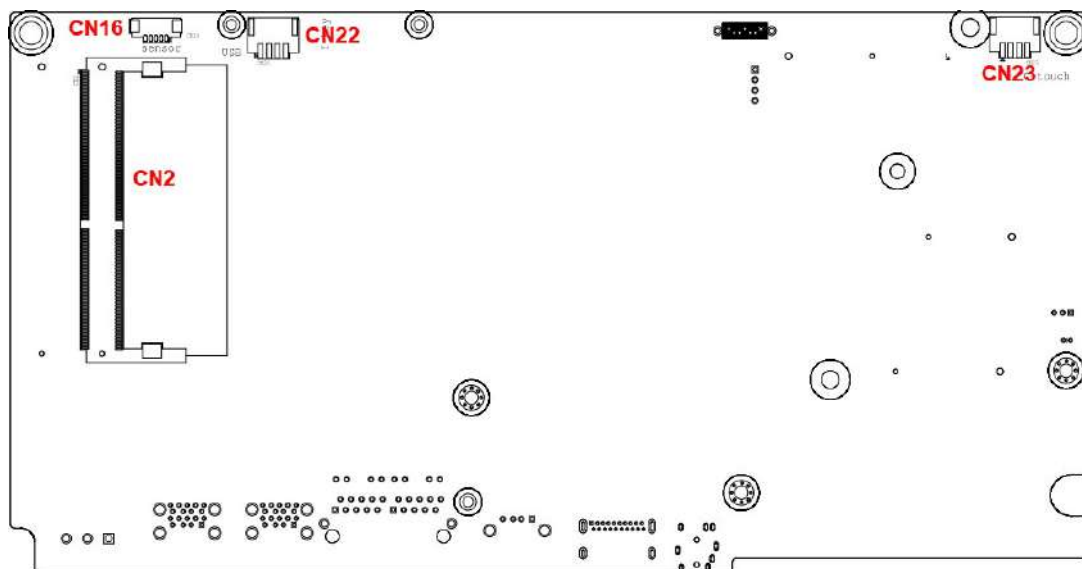


Figure A.2 Board Layout - Underside View

**Table A.1: Connectors and Jumpers**

Top	
Label	Function
BAT1	
CN1	Power input connector
CN3	DDR4 SODIMM I
CN7	Remote power button
CN9	LAN RJ45 connector
CN10	SIM connector



**Table A.1: Connectors and Jumpers**

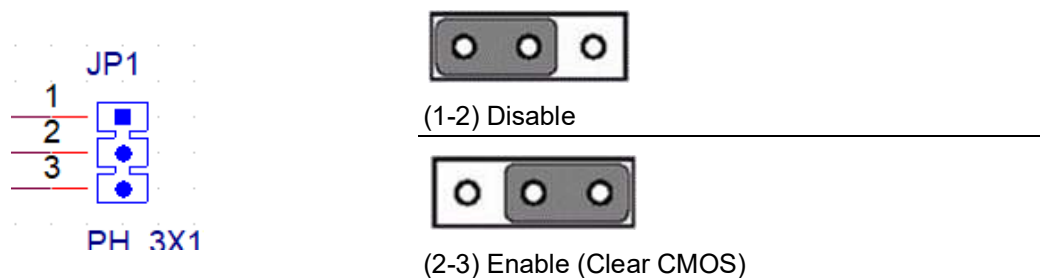
CN17	M.2 (M-Key) slot (NVMe/SATA storage)
CN19	USB connectors
CN20	USB connectors
CN21	USB connectors
CN24	SATA power connector
CN26	M.2 (B-Key) slot (PCIe/USB/SATA)
CN31	Mini PCIe slot
CN36	DisplayPort connector
CN37	SATA connector
CN38	Audio connector
COM1	COM1 RS-232/422/485 connector
COM2	COM2 RS-232 connector
JP1	CMOS clear function
<b>Bottom</b>	
CN2	DDR4 SODIMM II
CN16	Light sensor connector
CN22	Internal USB connector
CN23	Reserved connector (P-CAP touch)

## A.2 Jumper Settings, and Descriptions

### A.2.1 CMOS Clear Function (JP1)

**Table A.2: CMOS Clear Function (JP1)**

Description	This jumper is used to enable/disable the CMOS clear function.
Default	(1-2)
(2-3)	Enable (Clear CMOS)
(1-2)	Disable



## A.3 Connector Pin Definition

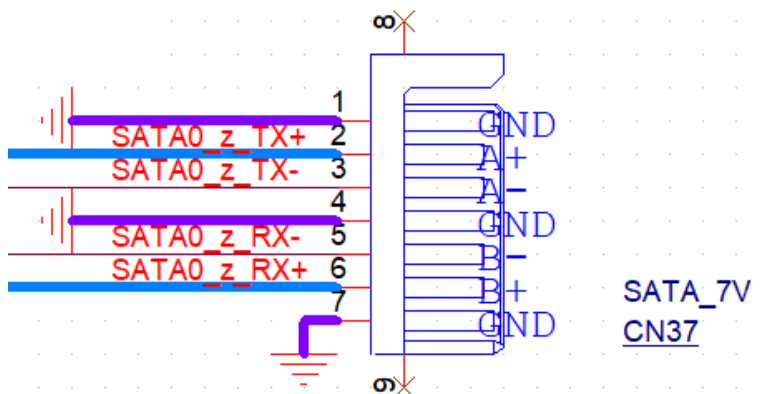
### A.3.1 SATA Connector (CN37)

**Table A.3: SATA Connector (CN37)**

Pin	Signal	Description
-----	--------	-------------

**Table A.3: SATA Connector (CN37)**

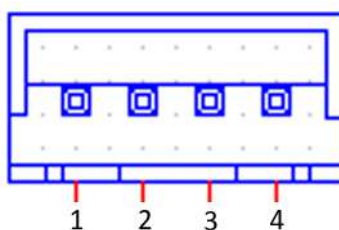
1	GND	GND
2	A+	Signal pair A: TX+/- (Transmit)
3	A-	
4	GND	GND
5	B-	Signal pair B: RX+/ (Receive)
6	B+	
7	GND	GND



### A.3.2 SATA Power Connector (CN24)

**Table A.4: SATA Power Connector (CN24)**

Pin	Signal	Description
1	+V5SATA	SATA power output 5V/1A
2	GND	GND
3	GND	GND
4	+V12SATA	SATA power output 12V/0.5A



### A.3.3 Mini PCIe Slot (CN31 MINIPCIE)

**Table A.5: Mini PCIe Slot (CN31 MINIPCIE)**

Pin	Signal	Description	Pin	Signal	Description
52	+3.3V aux/ +3.3V	PCI1.1 was +3.3V, PCI1.2 was +3.3V aux	51	Reserved	NC
50	GND		49	Reserved	NC
48	+1.5V		47	Reserved	NC
46	NC	NC	45	Reserved	NC
44	NC	NC	43	PIN43_MP- CIE_PWR- SEL	The pin to select the Pin 2, 52 power output for +3.3V aux or +3.3V (PCI1.1 is reserved and PIC1.2 is GND)
42	NC	NC	41	+3.3V aux	
40	GND		39	+3.3V aux	
38	USB_D+	USB serial data inter- face is compliant with USB 2.0 specifications	37	GND	
36	USB_D-		35	GND	
34	GND		33	PETp0	PCI express differential transmit pair
32	SMB_DATA	SMBus data signals are compliant with SMBus 2.0 specifications	31	PETn0	
30	SMB_CLK		29	GND	
28	+1.5V		27	GND	
26	GND		25	PERp0	PCI express differential receive pair
24	+3.3Vaux		23	PERn0	
22	PERST#	Functional reset to the card	21	GND	
20	NC		19	Reserved	NC
18	GND		17	Reserved	NC
	Key	Key		Key	Key
16	NC	NC	15	GND	
14	NC	NC	13	REFCLK+	
12	NC	NC	11	REFCLK-	
10	NC	NC	9	GND	
8	NC	NC	7	CLKREQ#	Reference clock request signal
6	1.5V		5	NC	NC
4	GND		3	NC	NC
2	+3.3V aux / +3.3V	PCI1.1 was +3.3V , PCI1.2 was +3.3V aux	1	WAKE#	Open drain active low signal. This signal is used to request that the system return from a sleep/suspended state to service a function- initiated wake event.

\* +3.3V aux is suspend power; power output to device +3.3V/1.1A

\* +3.3V is core power

\* +1.5V is core power; power output to device +1.5V/0.5A

### A.3.4 M.2 (M-Key) Slot (CN17 NVMe/SATA Storage)

**Table A.6: M.2 (M-Key) Slot (CN17 NVMe/SATA Storage)**

Pin	Signal	Pin	Signal
		75	GND
74	3.3V	73	VIO_CFG(I) or GND
72	3.3V	71	GND
70	3.3V	69	PEDET = GND (SATA), PEDET = NC (PCIe)
68	SUSCLK (O) (0/1.8V/3.3V)	67	NC
	Connector key M		Connector key M
	Connector key M		Connector key M
	Connector key M		Connector key M
	Connector key M		Connector key M
58	NC	57	GND
56	NC	55	REFCLKp
54	PEWAKE# (I/O) (0/1.8V/3.3V) or NC	53	REFCLKn
52	CLKREQ# (I/O) (0/1.8V/3.3V) or NC	51	GND
50	PERST# (O) (0/1.8V/3.3V) or NC	49	PETp0/SATA-A+
48	NC	47	PETn0/SATA-A-
46	NC	45	GND
44	ALERT# (I) (0/1.8V)	43	PETp0/SATA-B-
42	SMB_DATA (I/O)(0/1.8V)	41	PETn0/SATA-B+
40	SMB_CLK (I/O) (0/1.8V)	39	GND
38	DEVSLP (O) (SATA) or GND (USB)	37	PETp1
36	USB_D- or NC	35	PETn1
34	USB_D+ or NC	33	GND
32	NC or GND (USB)	31	PERp1
30	PLA_S3# (I) (0/1.8V/3.3V) or NC	29	PERn1
28	NC	27	GND
26	NC	25	PETp2
24	NC	23	PETn2
22	VIO 1.8V or NC	21	GND
20	NC	19	PERp2
18	3.3V	17	PERn2
16	3.3V	15	GND
14	3.3V	13	PETp3
12	3.3V	11	PETn3
10	DAS/DSS (I/O)/ LED_1# (I) (0/3.3V)	9	GND
8	PLN# (O)(0/1.8/3.3V) or NC	7	PERp3
6	PWRDIS (O)(0/1.8/3.3V) or NC	5	PERn3
4	3.3V	3	GND
2	3.3V	1	GND

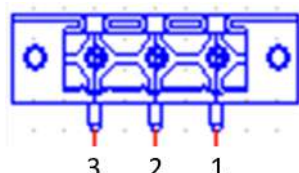
### A.3.5 M.2 (B-Key) Slot (CN26 PCIe/USB/SATA)

Table A.7: M.2 (B-Key) Slot (CN26 PCIe/USB/SATA)			
Pin	Signal	Pin	Signal
		75	CONFIG_2
74	3.3V/VBAT	73	VIO_CFG (I) or GND
72	3.3V/VBAT	71	GND
70	3.3V/VBAT	69	CONFIG_1
68	SUSCLK (O) (0/1.8V/3.3V)	67	RESET# (O) (0/1.8V)
66	SIM DETECT (O)	65	ANTCTL3 (I)(0/1.8V)
64	COEX_RXD (I) (0/1.8V)	63	ANTCTL2 (I)(0/1.8V)
62	COEX_TXD (O) (0/1.8V)	61	ANTCTL1 (I)(0/1.8V)
60	COEX3 (I/O) (0/1.8V)	59	ANTCTL0 (I)(0/1.8V)
58	NC	57	GND
56	NC	55	REFCLKp
54	PEWAKE# (I/O) (0/1.8V/3.3V)	53	REFCLKn
52	CLKREQ# (I/O) (0/1.8V/3.3V)	51	GND
50	PERST# (O) (0/1.8V/3.3V)	49	PETp0/SATA-A-
48	GPIO_4 (I/O) (0/1.8V)	47	PETn0/SATA-A-
46	GPIO_3 (I/O) (0/1.8V)	45	GND
44	GPIO_2 (I/O)/ALERT# (I)/(0/1.8V)	43	PETp0/SATA-B-
42	GPIO_1 (I/O)/SMB_DATA (I/O)/(0/1.8V)	41	PETn0/SATA-B+
40	GPIO_0 (I/O)/SMB_CLK (I/O)/(0/1.8V)	39	GND
38	DEVSLP (O)	37	PERp1/USB3.1-Tx+/SSIC-TxP
36	UIM_PWR (I)	35	PERn1/USB3.1-Tx-/SSIC-TxN
34	UIM_DATA (I/O)	33	GND
32	UIM_CLK (I)	31	PERp1/USB3.1-Rx+/SSIC-RxP
30	UIM_RESET (I)	29	PERn1/USB3.1-Rx-/SSIC-RxN
28	PLA_S2# (I) GPIO_8 (I/O) (0/1.8V)	27	GND
26	GPIO_10 (I/O)(0/1.8V)	25	DPR (O) (0/1.8V)
24	GPIO_7 (I/O)(0/1.8V)	23	GPIO_11 (I/O) (0/1.8V)
22	GPIO_6 (I/O)(0/1.8V)	21	CONFIG_0
20	GPIO_ (I/O)(0/1.8V)		Connector key B
	Connector key B		Connector key B
	Connector key B		Connector key B
	Connector key B		Connector key B
	Connector key B		Connector key B
	Connector key B	11	GND
10	GPIO_9/DAS/DSS (I/O)/ LED_1# (I) (0/3.3V)	9	USB_D-
8	W_DISABLE1# (O) (0/1.8V/3.3V)	7	USB_D+
6	FULL_CARD_POWER_OFF# (O) (0/18.V or 3.3V)	5	GND
4	3.3V	3	GND
2	3.3V	1	CONFIG_3

### A.3.6 Power Input Connector (CN1)

**Table A.8: Power Input Connector (CN1)**

Pin	Signal	Description
1	Power In V+	24V <sub>DC</sub> +-20% Power in
2	Power In V- (GND)	
3	GND_EARTH	Used to connect a screw hole to the chassis GND for shorting.



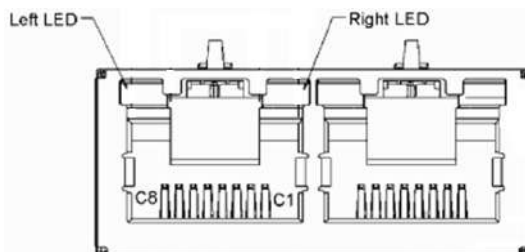
### A.3.7 LAN RJ45 Connector (CN9)

**Table A.9: LAN RJ45 Connector (CN9)**

RJ45 Pin	Signal	Description
1	MDI0+	In BASE-T: Media-dependent interface[0]: 1000BASE-T:
2	MDI0-	In MDI configuration, MDI[0]+/- corresponds to BI_DA+/- and in MDI-X configuration MDI[0]+/- corresponds to BI_DB+/-. 10BASE-T and 100BASE-TX: In MDI configuration, MDI[0]+/- is used for the transmit pair and in MDIX configuration MDI[0]+/- is used for the receive pair.
3	MDI1+	In BASE-T: Media-dependent interface[1]: 1000BASE-T:
6	MDI1-	In MDI configuration, MDI[1]+/- corresponds to BI_DB+ and in MDI-X configuration MDI[1]+/- corresponds to BI_DA+/-. 10BASE-T and 100BASE-TX: In MDI configuration, MDI[1]+/- is used for the receive pair and in MDI-X configuration MDI[1]+/- is used for the transmit pair.
4	MDI2+	In BASE-T: Media-dependent interface[3:2]:
5	MDI2-	1000BASE-T:
7	MDI3+	In MDI and in MDI-X configuration, MDI[2]+/- corresponds to BI_DC+/- and MDI[3]+/- corresponds to BI_DD+/-.
8	MDI3-	100BASE-TX: Unused. 10BASE-T: Unused.

**Table A.10: LED**

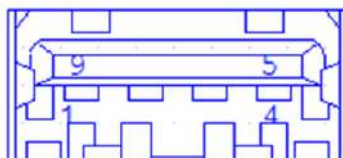
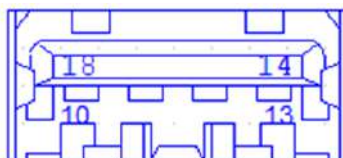
	Left LED		Right LED
10 Link	100 Link	1000 Link	Active
Off	Orange	Green	Green



### A.3.8 USB Connectors (CN19, CN20, CN21)

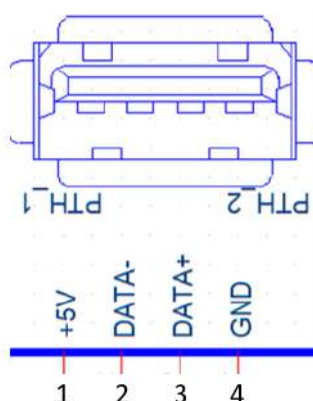
**Table A.11: USB Connector (CN19, CN20)**

Pin	Signal	Description
1, 10	USB VBUS	USB power output, USB 3.0 5V/0.9A
2, 11	USB_P-	USB2.0 data -
3, 12	USB_P+	USB2.0 data +
4,13	GND	Ground for power return
5	SSRX-	USB3.0 RX -
6	SSRX+	USB3.0 RX +
7	GND_DRAIN	Ground for signal return
8	SSTX-	USB3.0 TX -
9	SSTX+	USB3.0 TX +

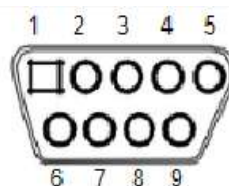


**Table A.12: USB Connector (CN21)**

Signal	Description
USB VBUS	USB power output, USB 2.0 5V/0.5A and USB 3.0 5V/0.9A
USB_P-	USB2.0 data -
USB_P+	USB2.0 data +
GND	Ground for power return



### A.3.9 COM1 RS-232/422/485 Connector (COM1)



**Table A.13: COM1 RS-232/422/485 Connector (COM1)**

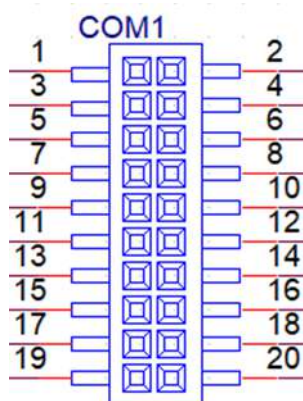
Pin	RS232	RS422	RS485
1	DCD	TX-	Data-
2	RX	TX+	Data+
3	TX	RX+	
4	DTR	RX-	
5	GND	GND	GND
6	DSR		
7	RTS		
8	CTS		
9	RI		



### A.3.10 COM2 RS-232 Connector (COM2)

**Table A.14: COM2 RS-232 Connector (COM2)**

Pin	RS232	Pin	RS232
1	DCD	2	DCD
3	RX	4	RX
5	TX	6	TX
7	DTR	8	DTR
9	GND	10	GND
11	DSR	12	DSR
13	RTS	14	RTS
15	CTS	16	CTS
17	RI	18	RI
19	NC	20	NC



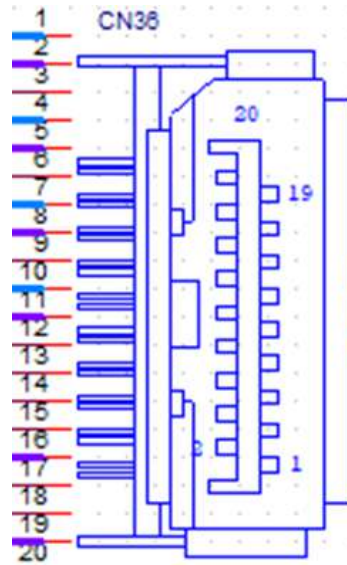
### A.3.11 DisplayPort Connector (CN36)

**Table A.15: DisplayPort Connector (CN36)**

Pin	Signal
1	DP_TX 0(p)
2	GND
3	DP_TX 0(n)
4	DP_TX 1(p)
5	GND
6	DP_TX 1(n)
7	DP_TX 2(p)
8	GND
9	DP_TX 2(n)
10	DP_TX 3(p)
11	GND
12	DP_TX 3(n)
13	AUX_EN
14	DP_config
15	AUX_CH(p)

**Table A.15: DisplayPort Connector (CN36)**

16	GND
17	AUX_CH(n)
18	Hot plug
19	GND
20	DP_PWR



### A.3.12 Audio Connector (CN38)

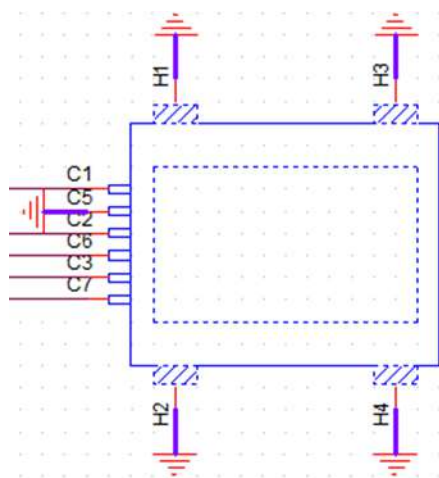
**Table A.16: Audio Connector (CN38)**

Pin	Signal
1	LOUT1_L
2	LOUT1_R
3	GND
4	MIC
5	HP_detection
6	GND

### A.3.13 SIM Connector (CN10)

**Table A.17: SIM Connector (CN10)**

Pin	Signal
1	PWR
2	RESET
3	CLK
4	NA
5	GND
6	VPP
7	DATA





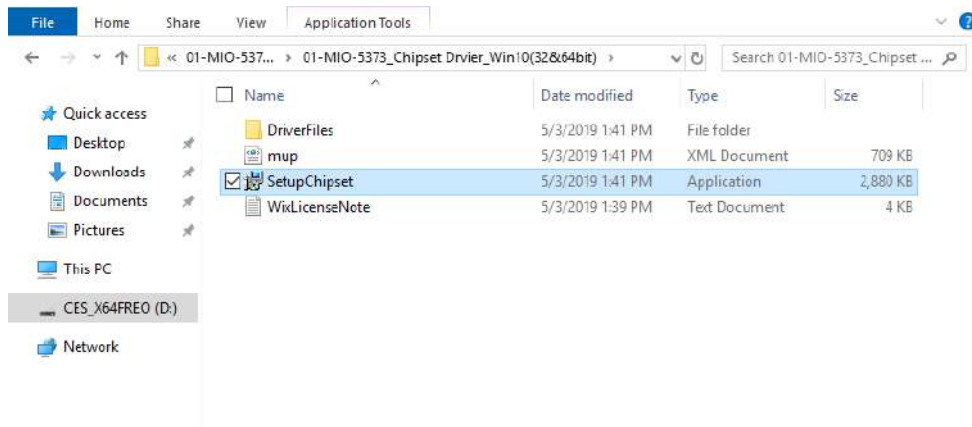
# Appendix **B**

## Driver Installation & Configuration

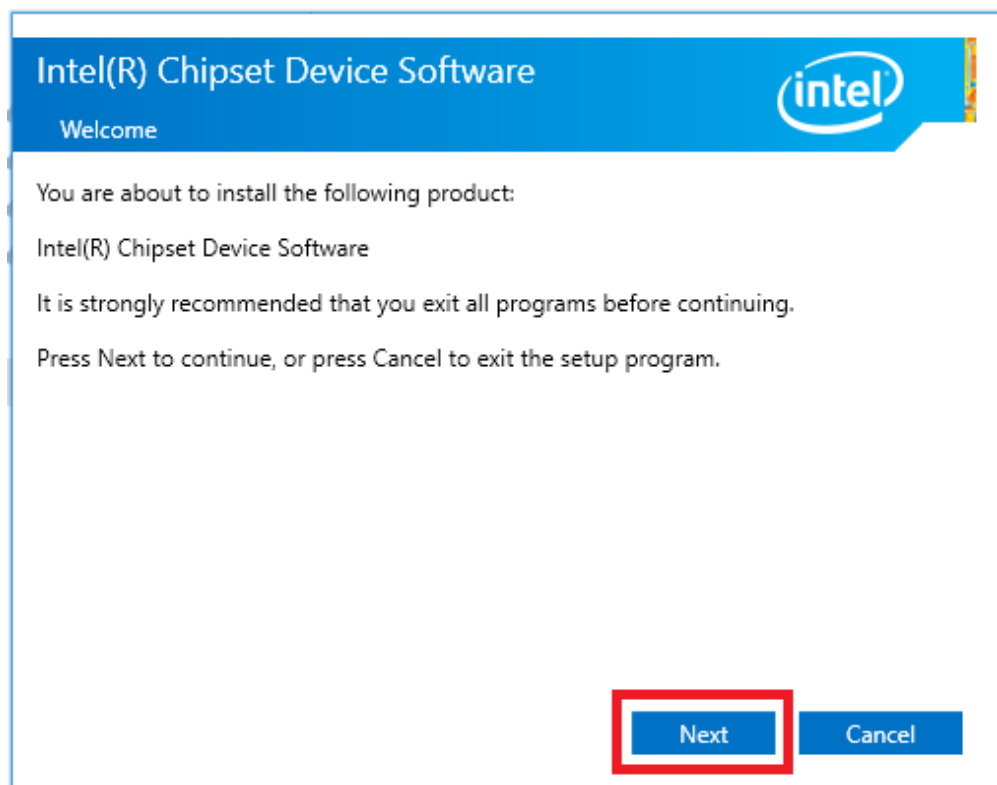
## B.1 Intel Chipset Software Installation Utility

Follow the steps below to install the Intel Chipset Software Installation Utility.

1. Launch <Driver Root Path>\01-MIO-5373\_Chipset Driver\_Win10(32&64bit).
2. Install SetupChipset.exe.



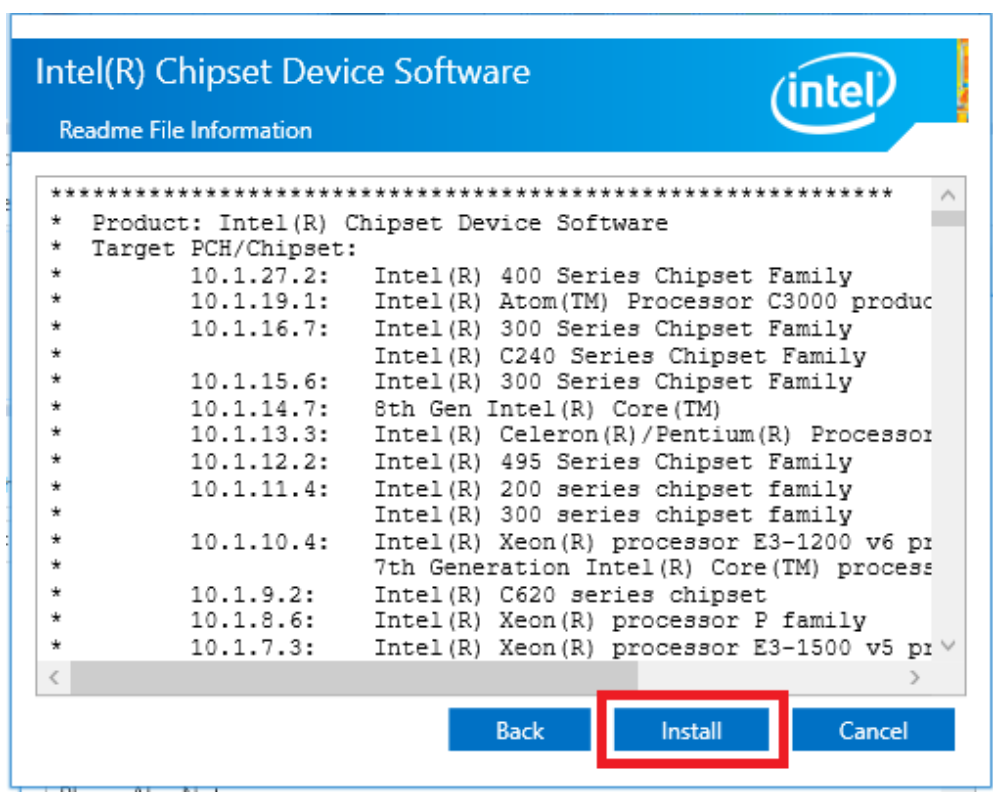
3. Click Next.



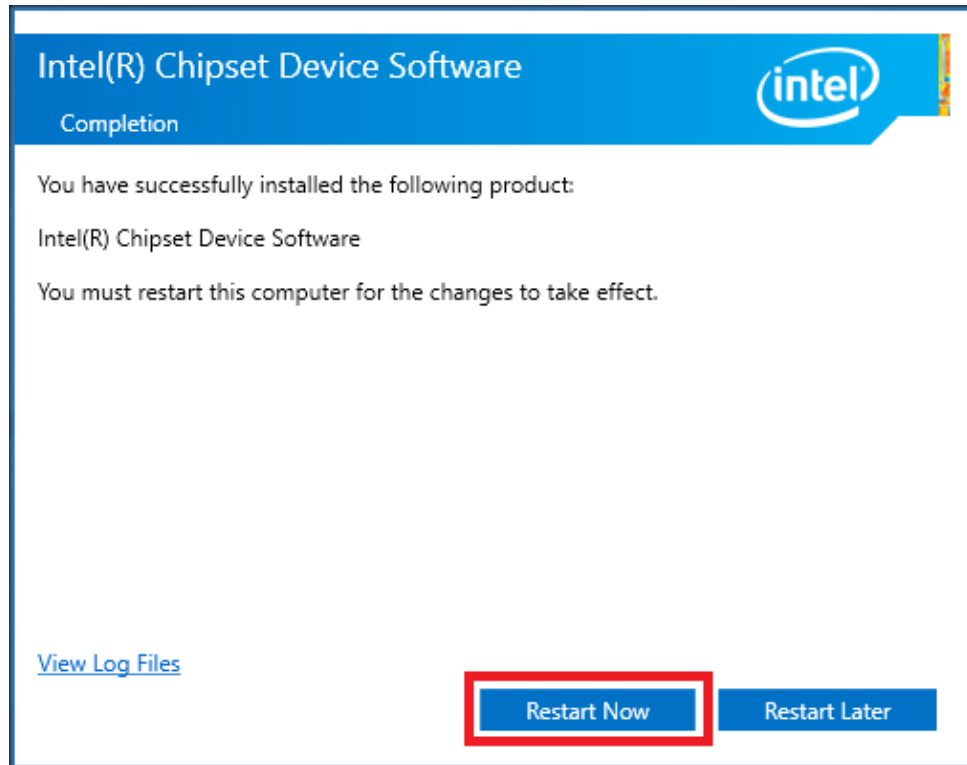
4. Click Accept.



5. Click Install.



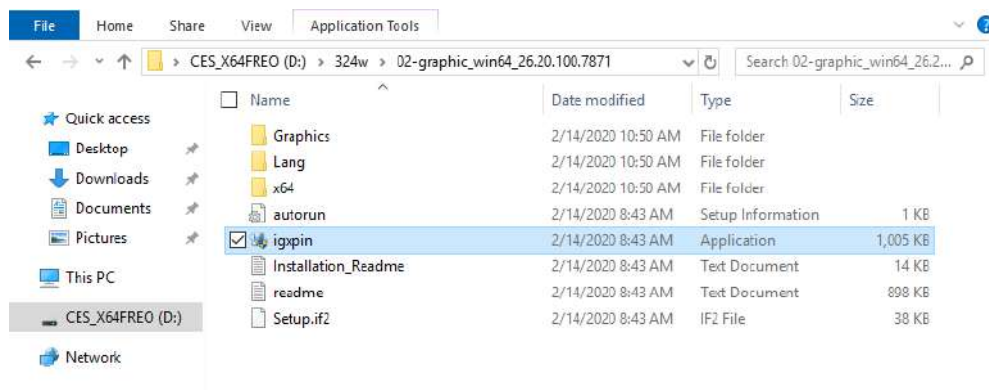
- Click Restart Now to complete the installation.



## B.2 Intel Graphics Driver Installation

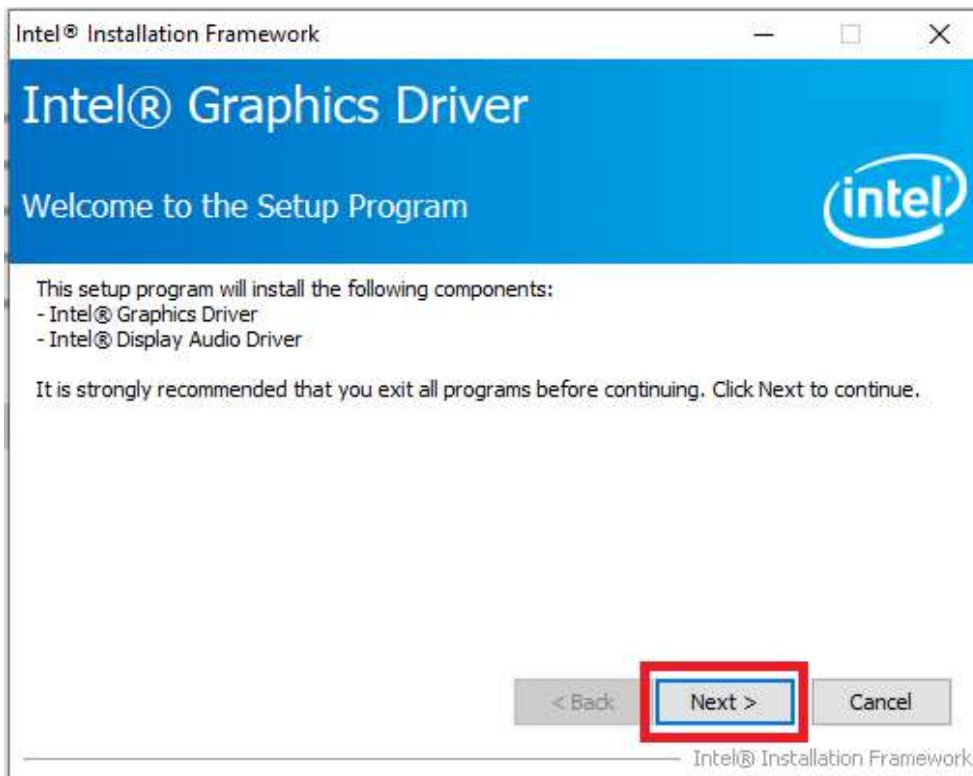
Follow the steps below to install the Intel graphics driver.

- Launch folder <Driver Root Path>\02-graphic\_winXX\_26.20.100.7871.
- Install Setup.exe.

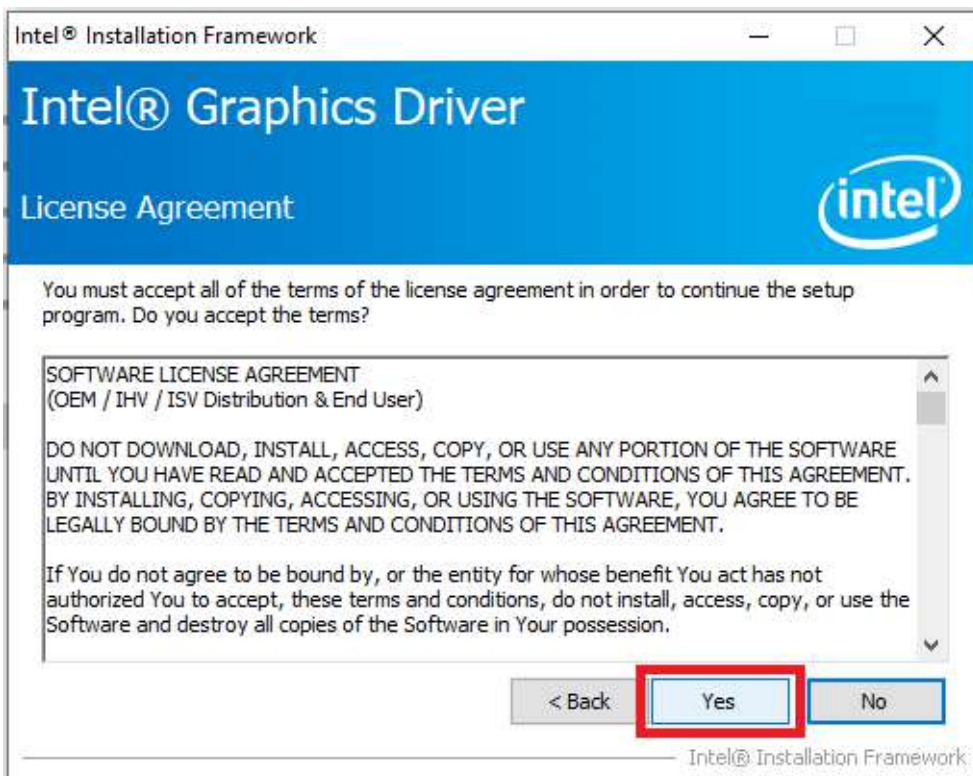




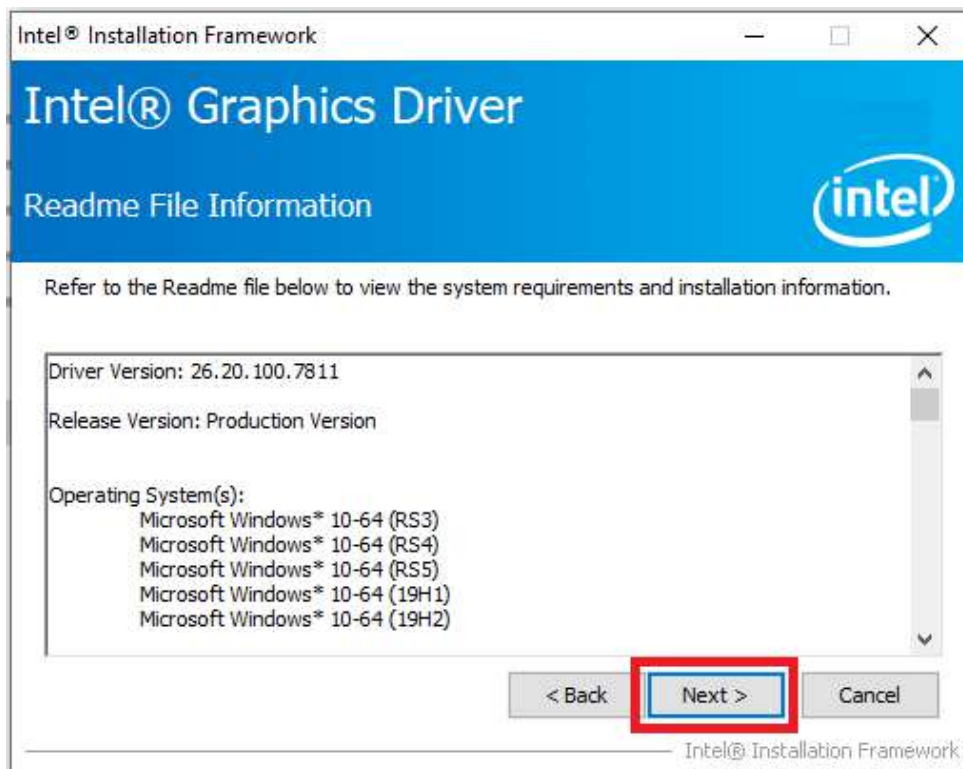
3. Click Next.



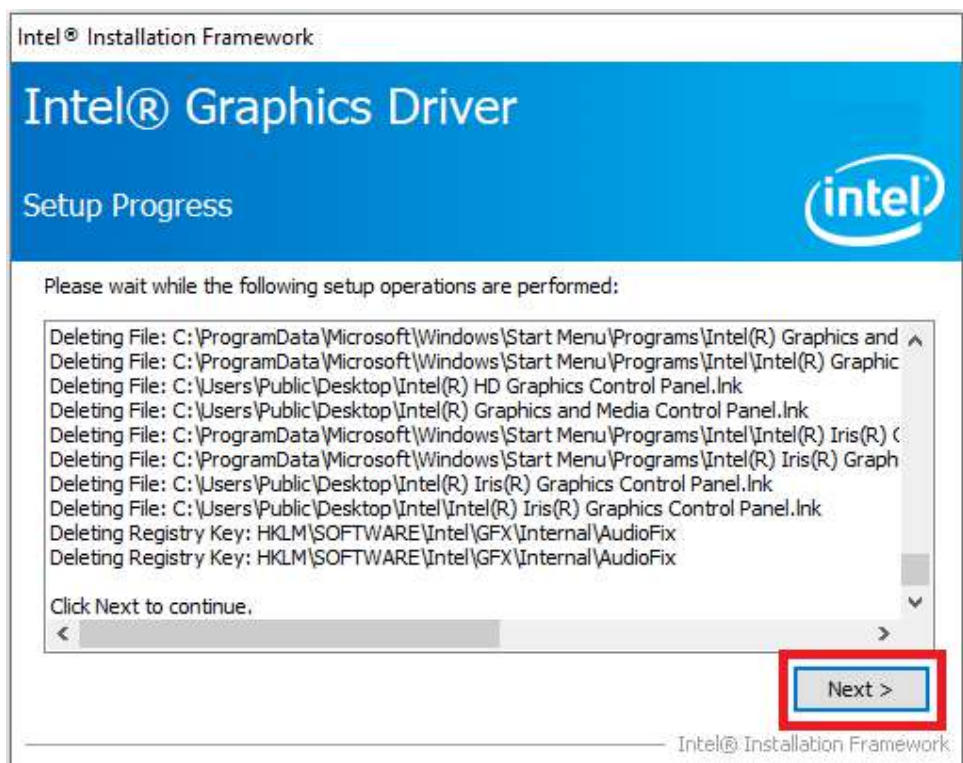
4. Click Yes.



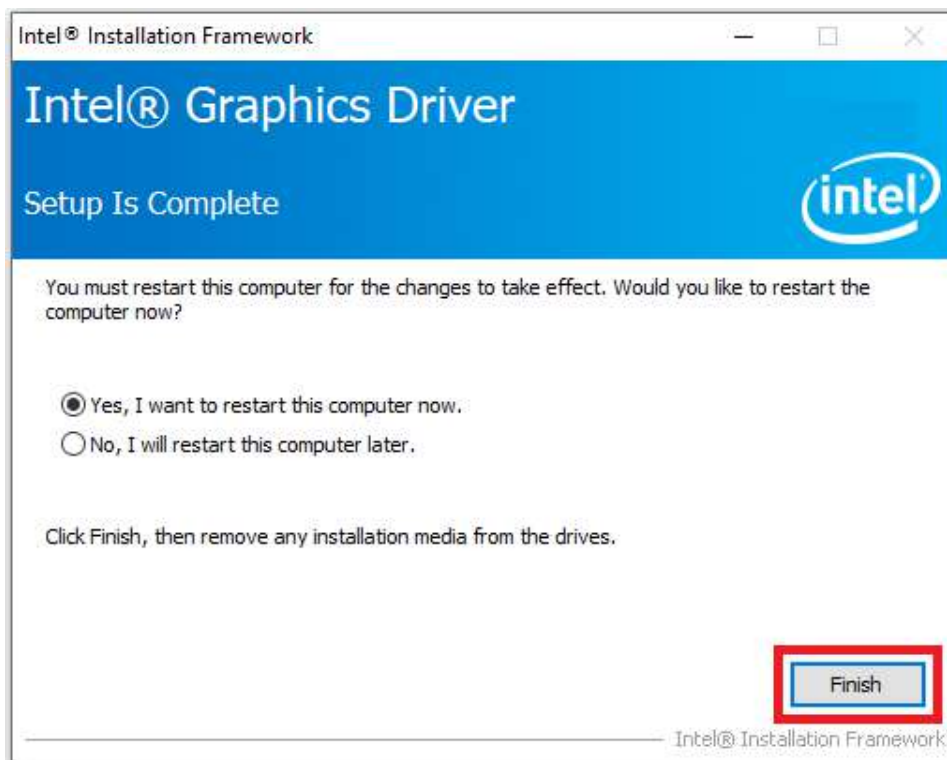
5. Click Next.



6. Click Next.



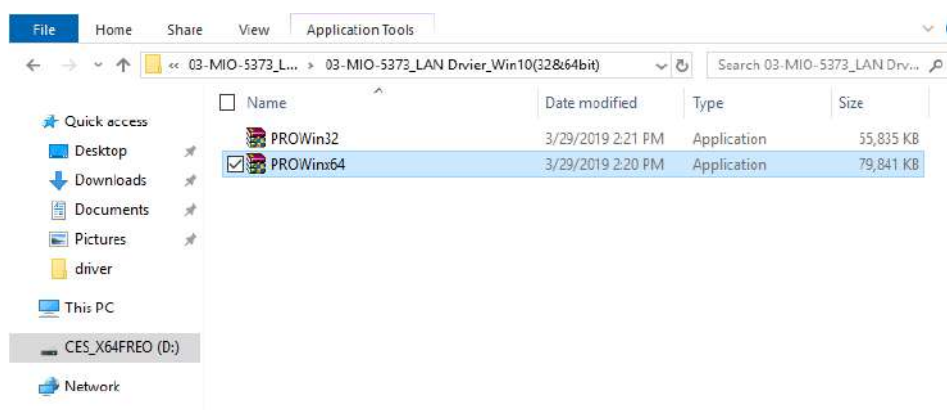
7. Select “Yes, I want to restart this computer now.” Then click Finish.



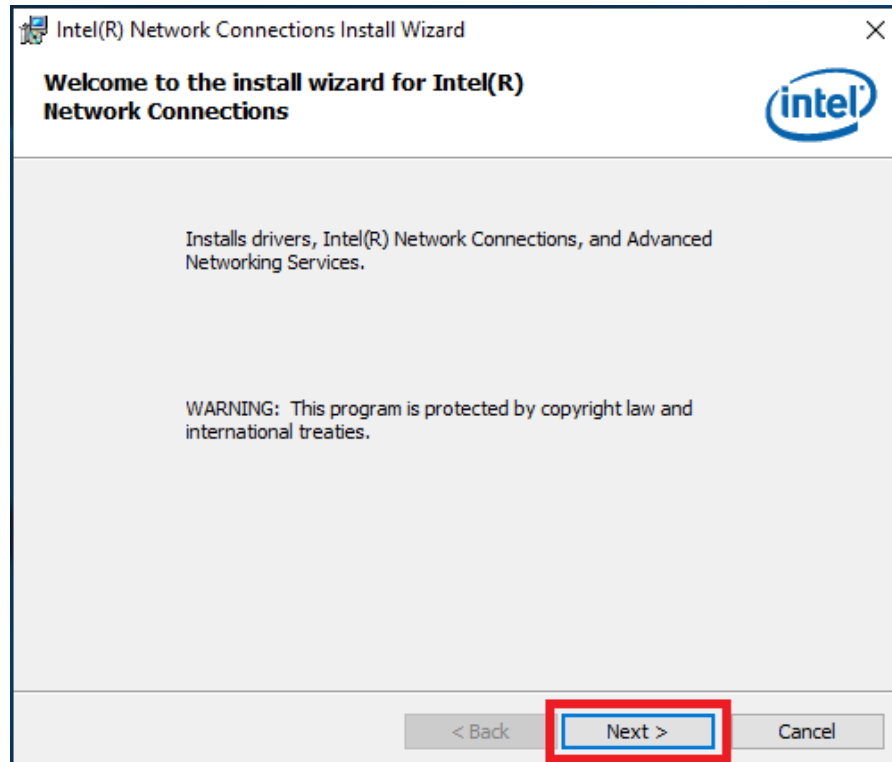
## B.3 LAN Driver Installation

Follow the steps below to install the LAN driver.

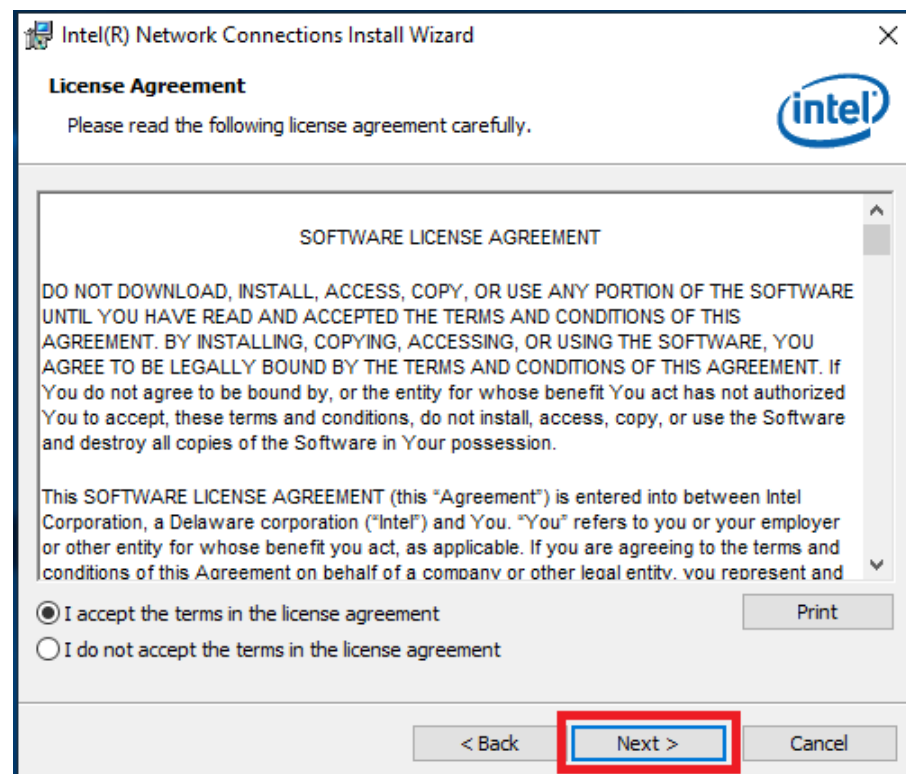
1. Launch folder <Driver Root Path>\03-MIO-5373\_LAN Driver\_Win10(32&64bit).
2. Install Setup.exe.



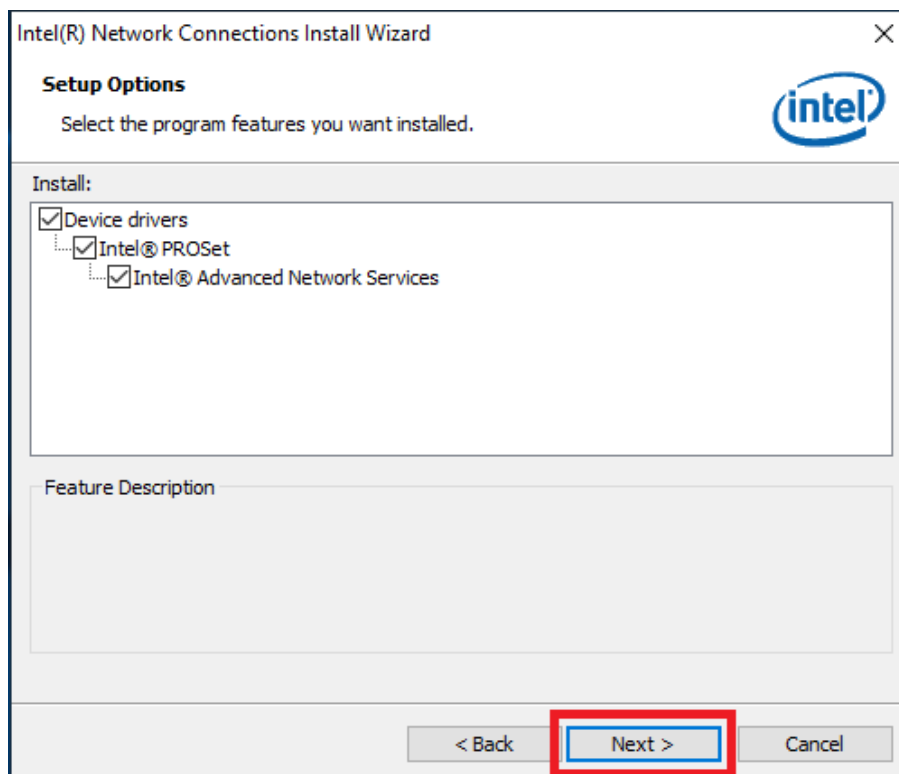
3. Click Next.



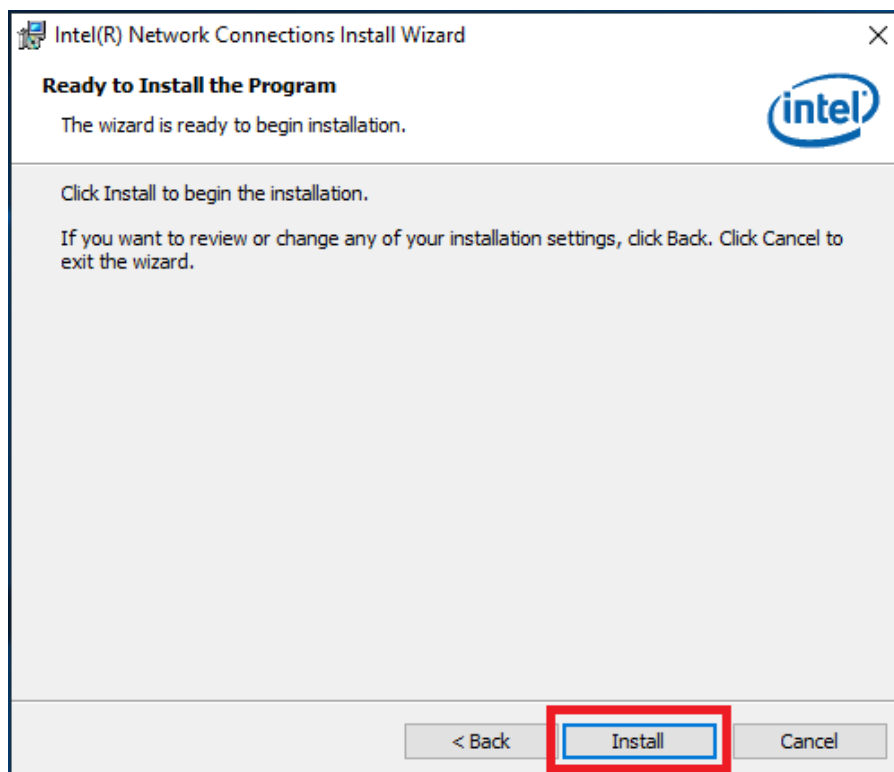
4. Click Next.



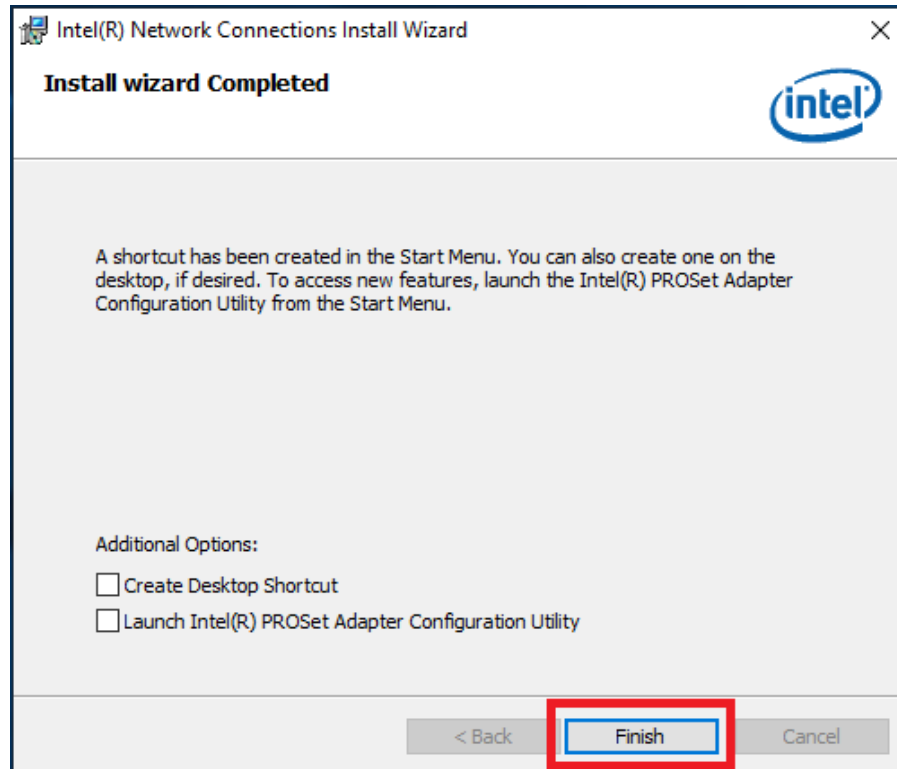
5. Click Next.



6. Click Install.



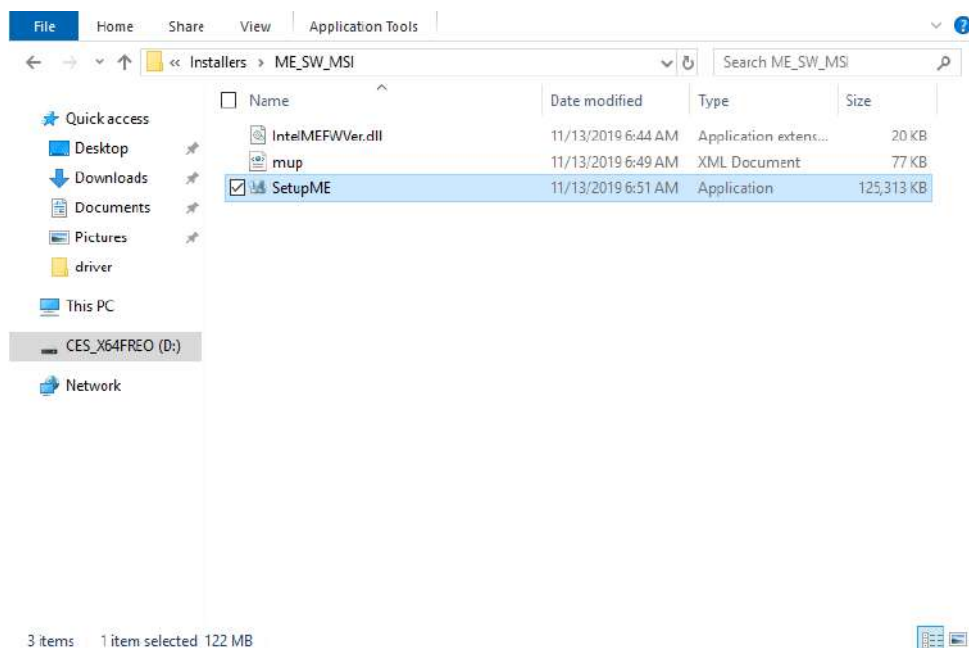
7. Click Finish.



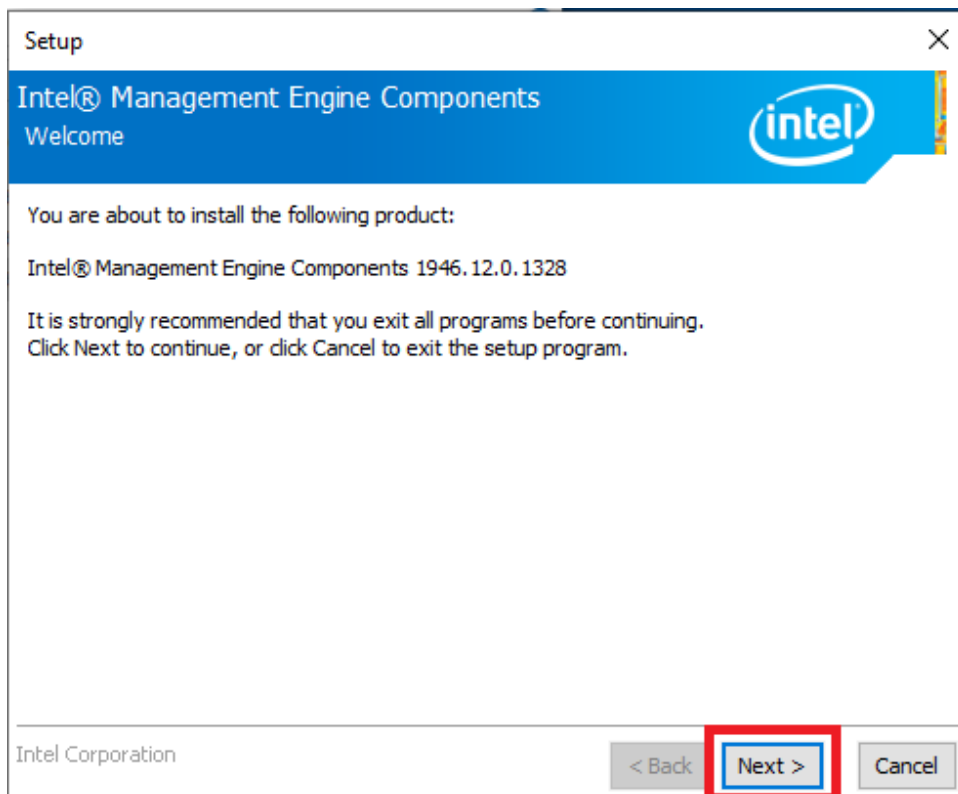
## B.4 Intel Management Engine Installation

Follow the steps below to install the Intel Trusted Execution Engine driver.

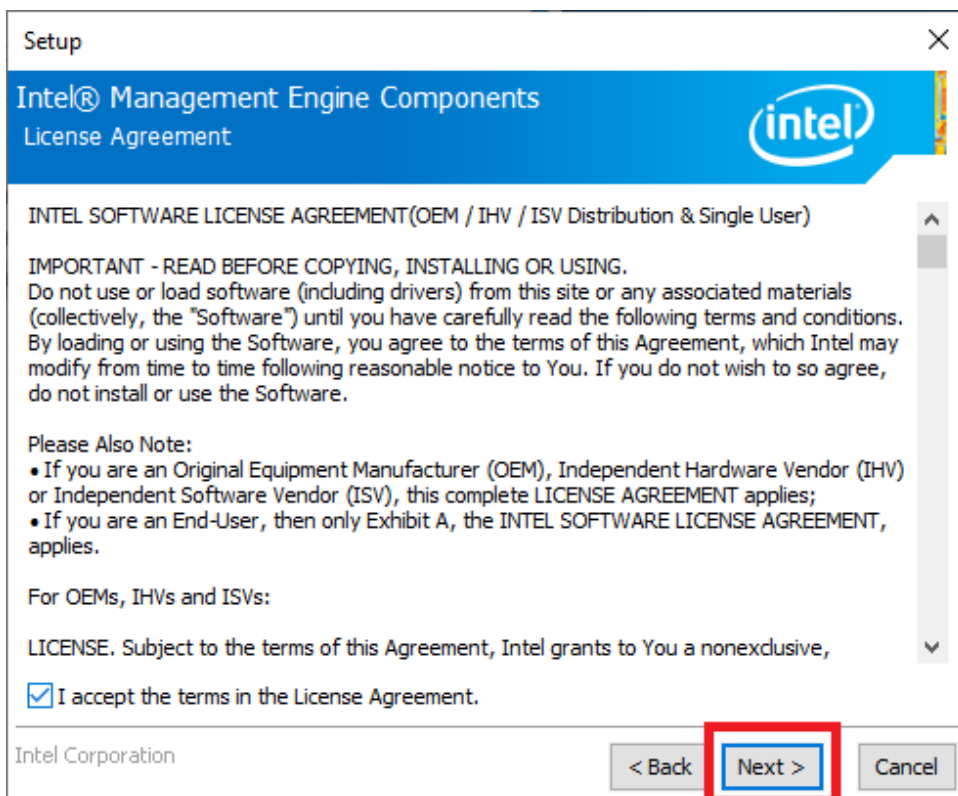
1. Launch folder <Driver Root Path>\LANWin7 \Install\_Win7\_7077\_XXX-XXXXXXX.
2. Install SetupME.exe.



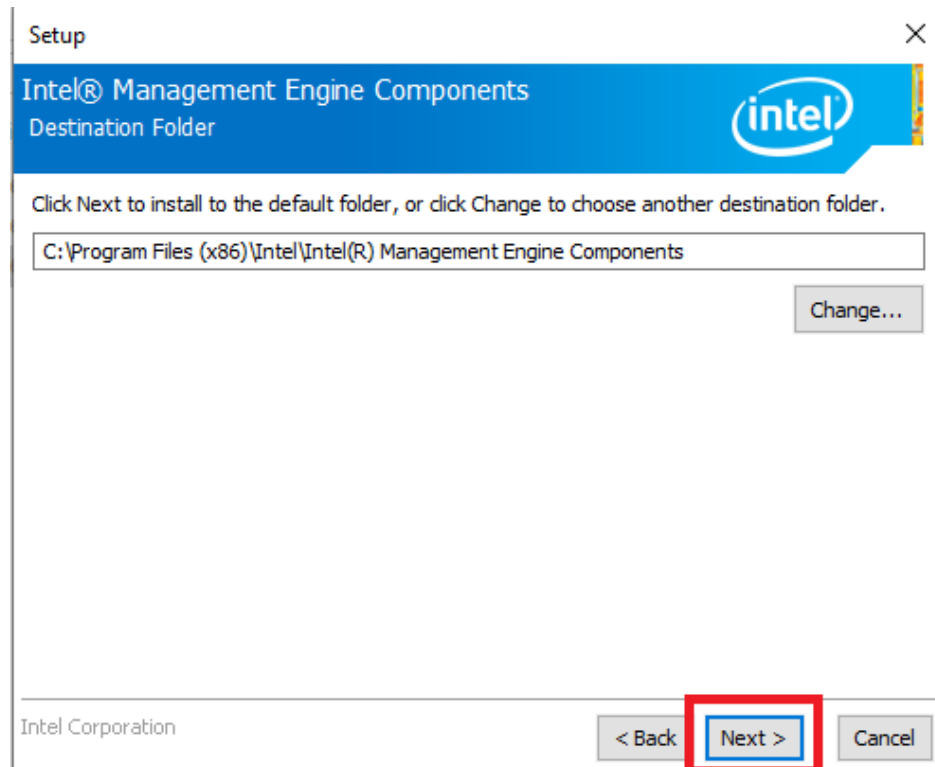
3. Click Next.



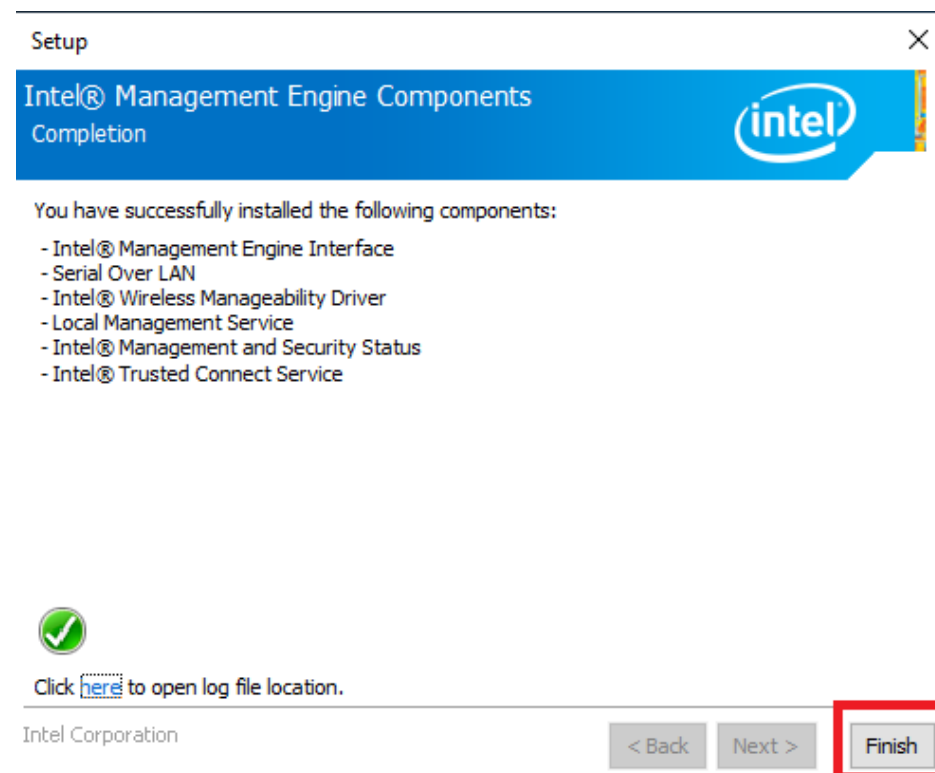
4. Click Next.



5. Click Next.



6. Click Finish.



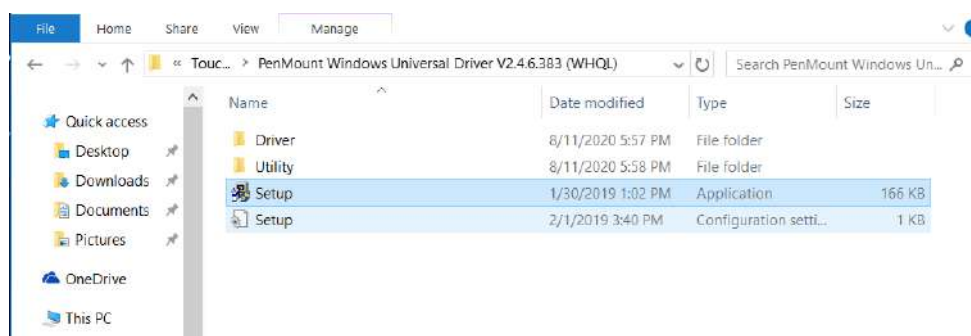


## B.5 Touch Driver Installation

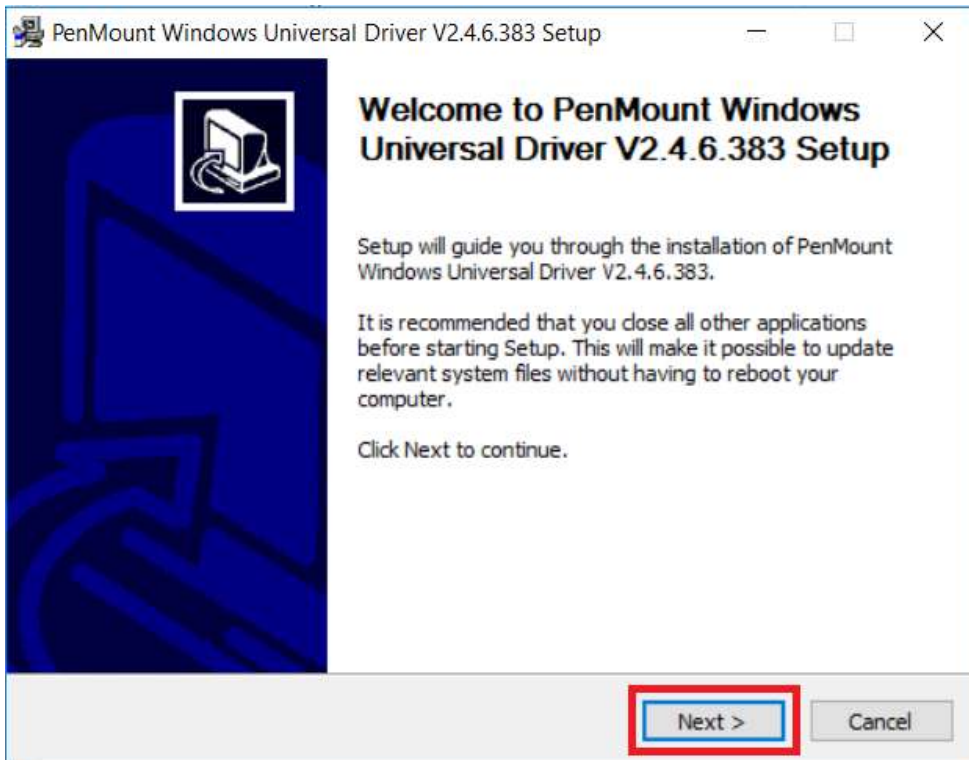
The PenMount touch driver is essential for the following TPC models. The driver must be installed before operation.

- TPC-312-R833A
- TPC-312-R853A
- TPC-312-R873A
- TPC-315-R833A
- TPC-315-R853A
- TPC-315-R873A
- TPC-317-R833A
- TPC-317-R853A
- TPC-317-R873A
- TPC-B510 series (when paired with a FPM-D12T panel module)

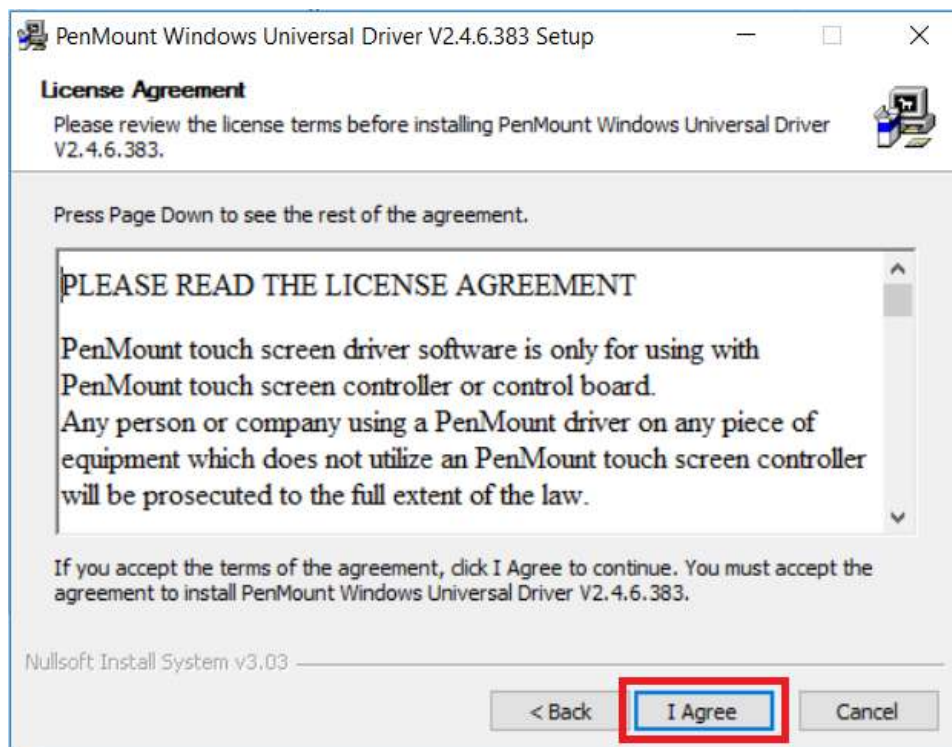
1. Launch folder <Driver Root Path>\PenMount Windows Universal Driver V2.4.6.383 (WHQL).
2. Install Setup.exe.



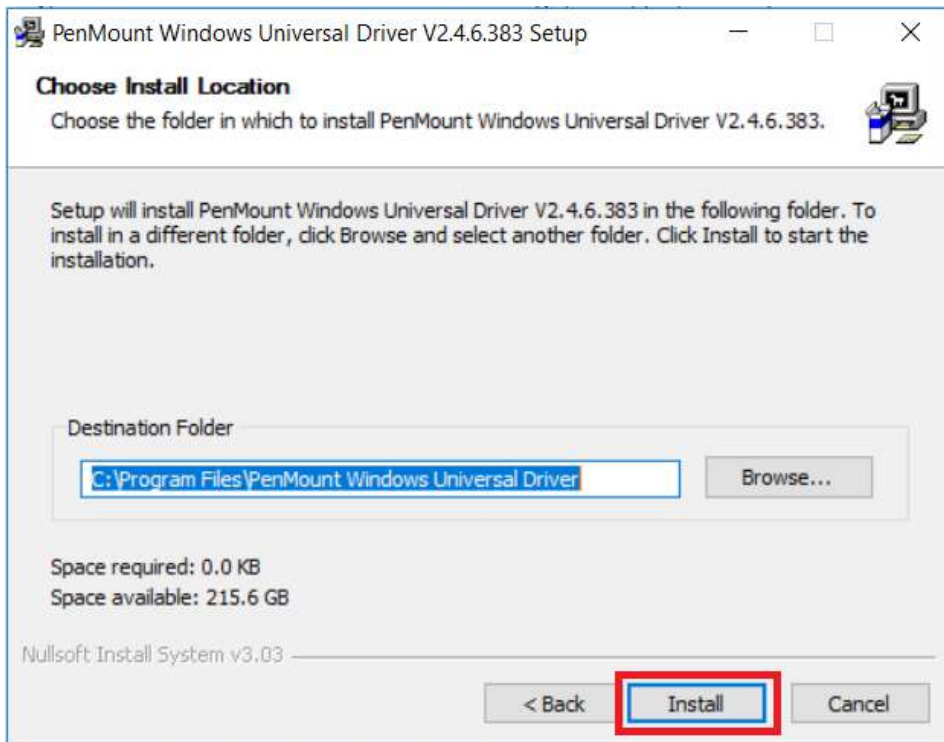
3. Click Next.



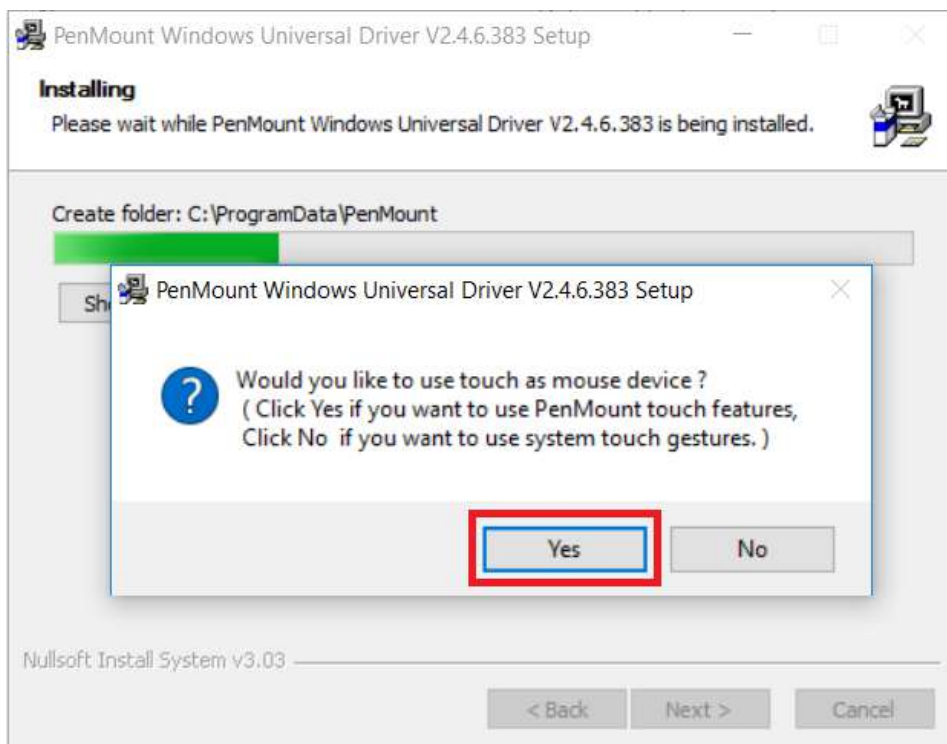
4. Click I Agree.



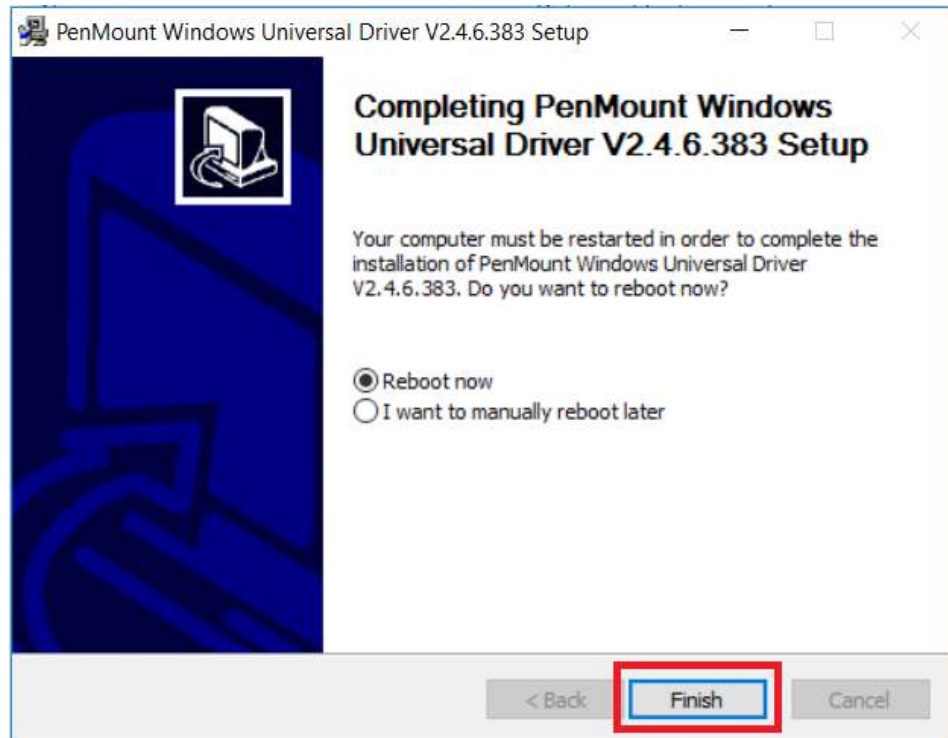
5. Click Install.



6. Click Yes.



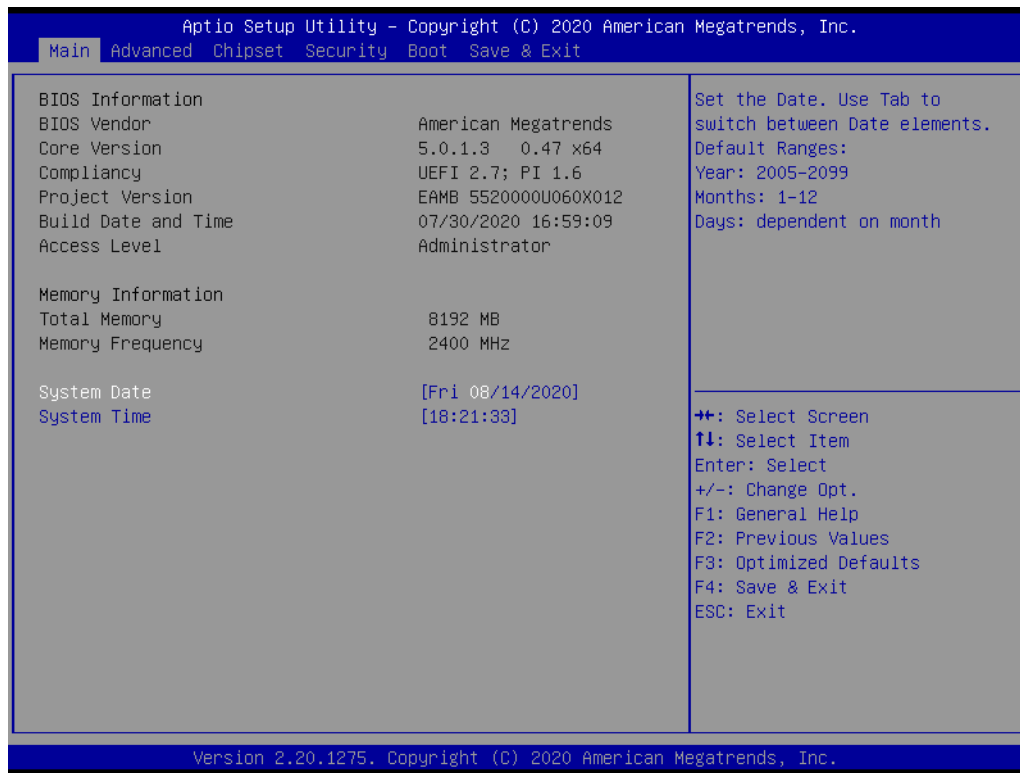
7. Click Finish.



# Appendix **C**

## BIOS Setup

With the AMI BIOS Setup program, users can modify the BIOS settings and control various system features. This chapter describes the basic navigation of the BIOS Setup Utility.



AMI's BIOS ROM has a built-in setup program that allows users to modify the basic system configuration. The setup information is stored in flash ROM to ensure it is retained when the system is powered off.

## C.1 Entering Setup

Turn on the computer and check for the patch code. If there is a number assigned to the patch code, it means that the BIOS supports your CPU. If there is no number assigned to the patch code, contact an Advantech application engineer to obtain an up-to-date patch code file. This will ensure that the CPU status is valid. After ensuring that you have a number assigned to the patch code, press <DEL> to access the BIOS Setup Utility.

## C.1.1 Main Setup

Upon entering the BIOS Setup Utility, users will be on the Main setup screen. At any point during the configuration, users can return to the Main setup screen by selecting the Main tab. There are two Main setup options, which are described in this section. The Main setup screen is shown below.



The Main setup screen has two main frames. The left frame displays all the options that can be configured. Grayed-out options cannot be configured, whereas options presented in blue can be configured. The right frame displays the key legend.

Above the key legend is an area reserved for a text message. When an option is selected in the left frame, it is highlighted in white. Often a text message will accompany an option.

### ■ System Time/System Date

Use this option to change the system time and date. Highlight System Time or System Date using the <Arrow> keys. Enter new values via the keyboard. Press the <Tab> key or the <Arrow> keys to move between fields. The date must be entered in MM/DD/YY format. The time must be entered in HH:MM:SS format.

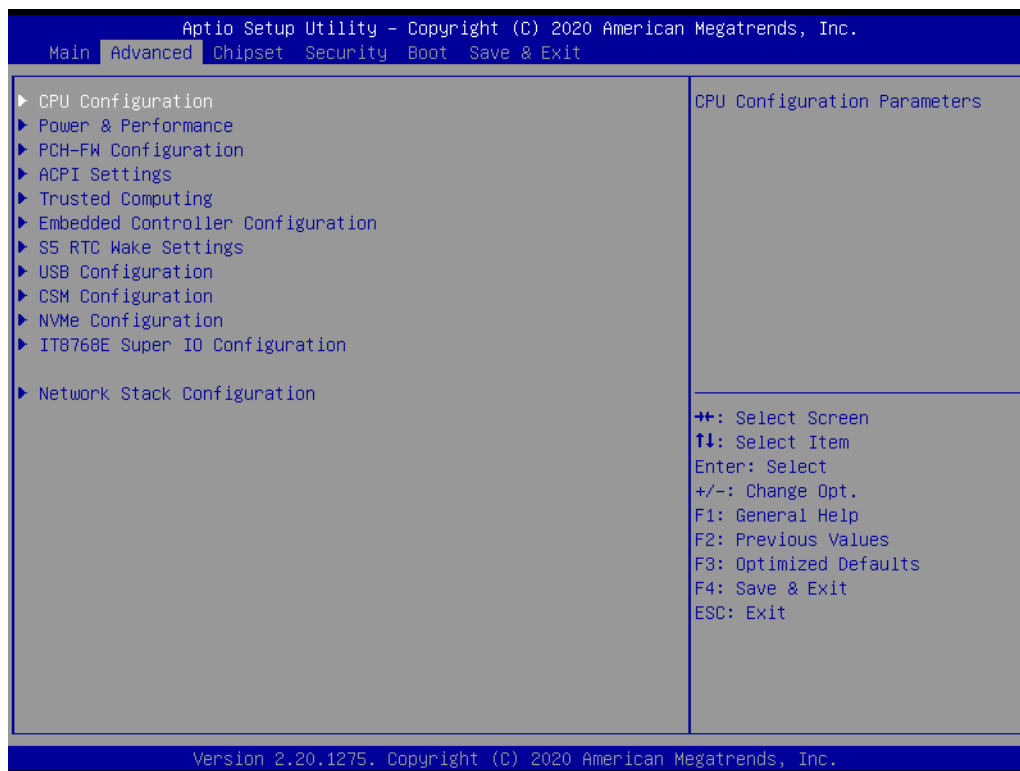
**Note!** *Before installing a WinCE image, IDE configuration is required. Additionally, the SATA mode must be set to IDE mode in the BIOS to enable boot up.*



## C.1.2 Advanced BIOS Features Setup

Select the Advanced tab from the UNO-3272G setup screen to enter the Advanced BIOS Setup screen. Users can select any of the items in the left frame of the screen, such as ACPI Settings and hit <enter> to access the sub menu for that item. Users can display an Advanced BIOS Setup option by highlighting it using the <Arrow> keys. All Advanced BIOS Setup options are described in this section. The Advanced BIOS setup screen is shown below. The sub menus are described on the following pages.

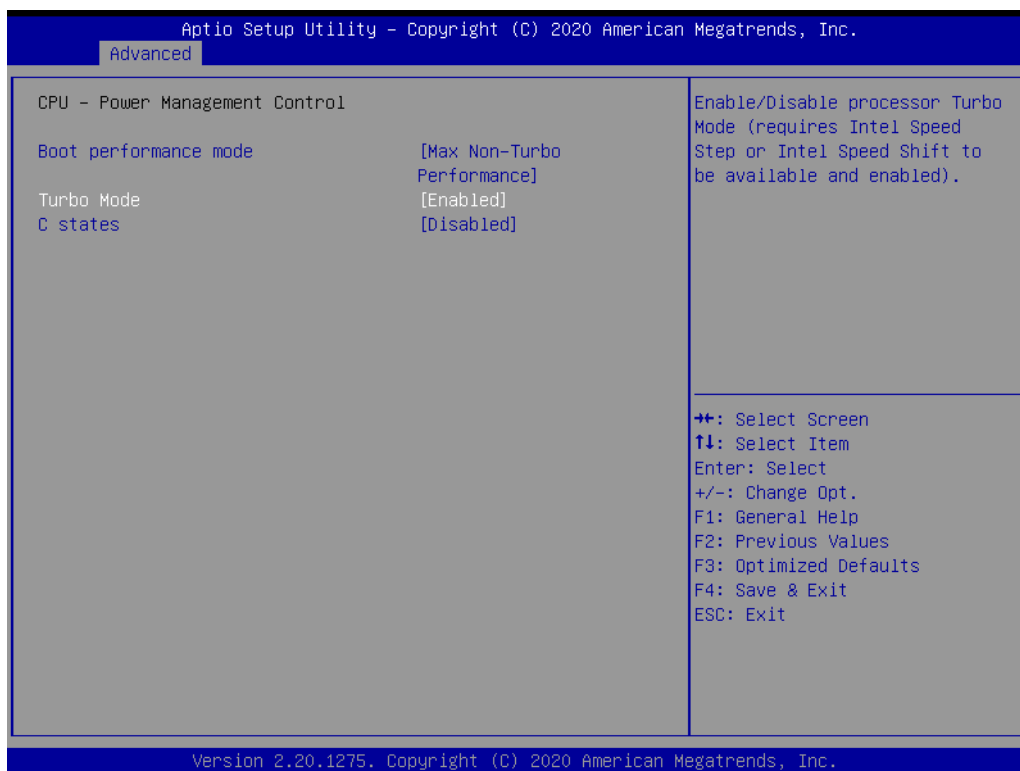
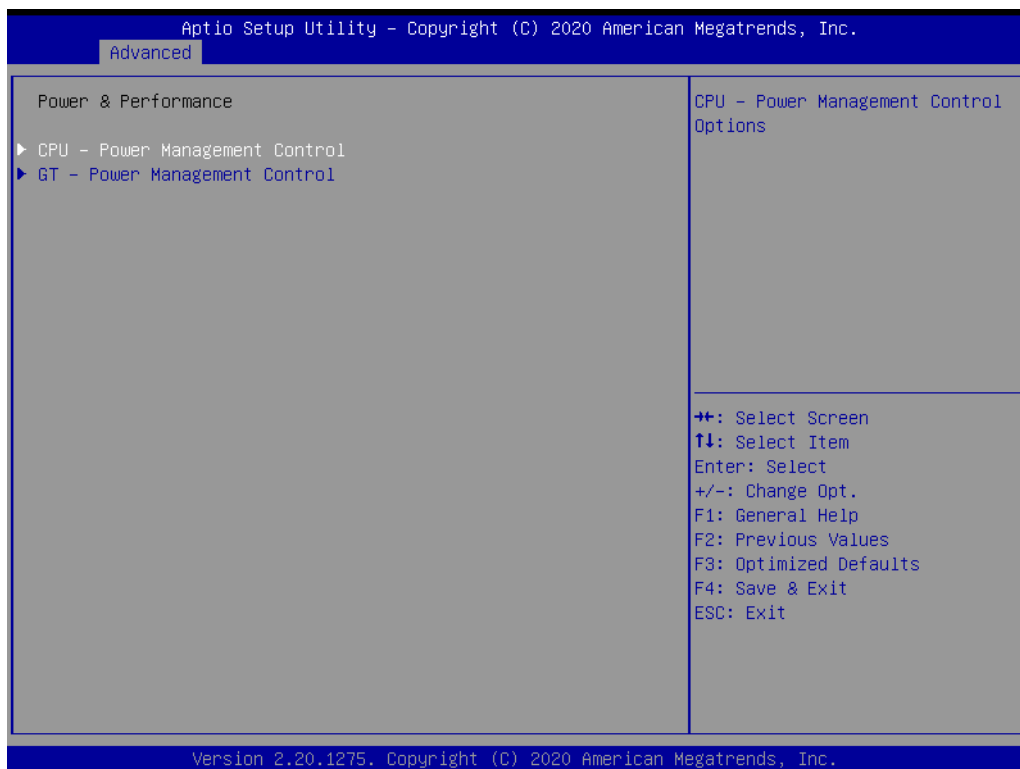
### C.1.2.1 CPU Configuration



#### ■ CPU Configuration Parameters



### C.1.2.2 Power & Performance



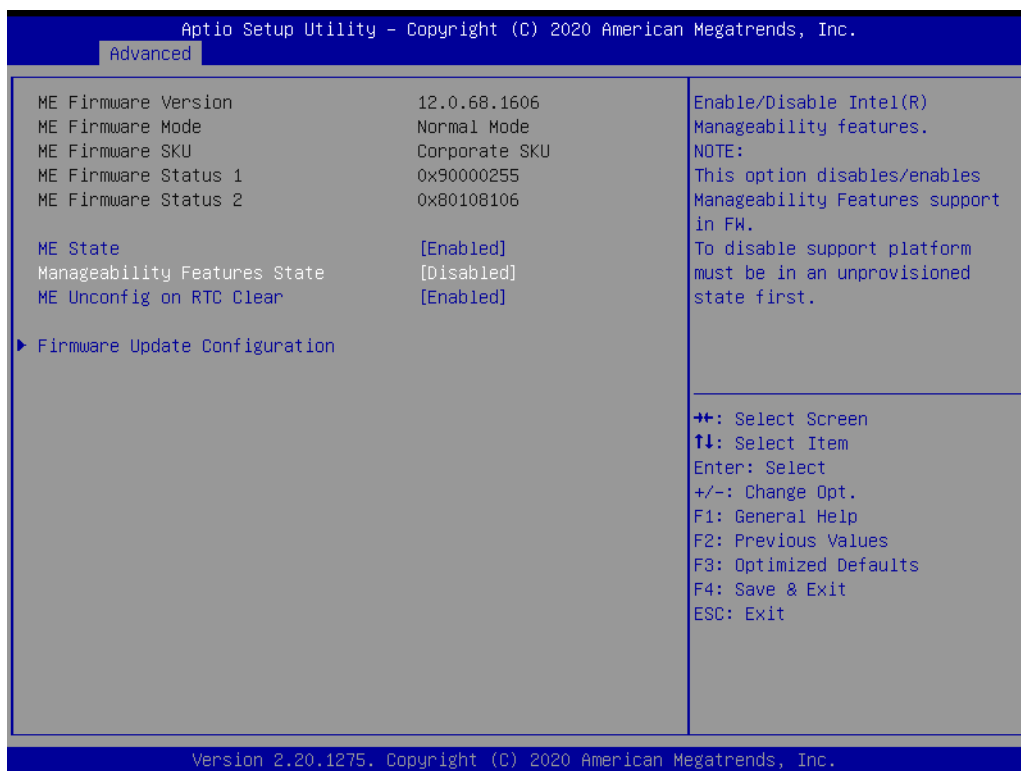
■ **CPU – Power Management Control**

- Boot performance mode
- Turbo mode

This item allows users to enable/disable processor turbo mode (regular Intel Speed Step or Intel Speed Shift are available and should be enabled).

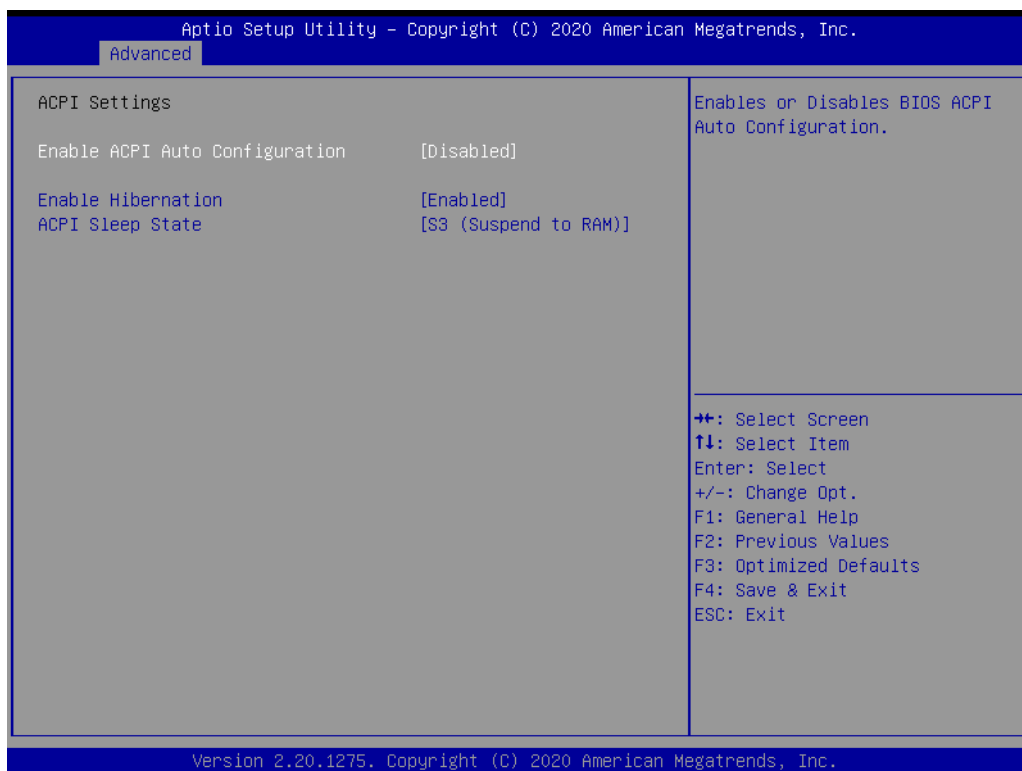
- C States  
This item allows users to enable/disable CPU power management. This will enable the CPU to go to C states when not 100% utilized.
- **GT - Power Management Control**
  - RC6 (Render Standby)
  - Maximum GT Frequency  
The maximum GT frequency can be configured by the user. Choose between 300 MHz (RPN) and 1000 MHz (RPO). Values outside this range will be clipped to min/max supported by the SKU.
  - Disable Turbo GT Frequency  
Enabled: Turbo GT frequency will be disabled. Disabled: GT frequency is not limited.

### C.1.2.3 PCH-FW Configuration



- **ME State**
- **Manageability Features State**  
This item allows users to enable/disable Intel (R) manageability features. This option disables/enables firmware support for manageability features. To disable this item, the support platform must be in an unprovisioned state first.
- **ME Unconfig on RTC Clear**  
When disabled, ME will not be unconfigured on RTC Clear.
- **Firmware Update Configuration**  
This item allows users to configure the management engine technology parameters.

### C.1.2.4 ACPI Settings



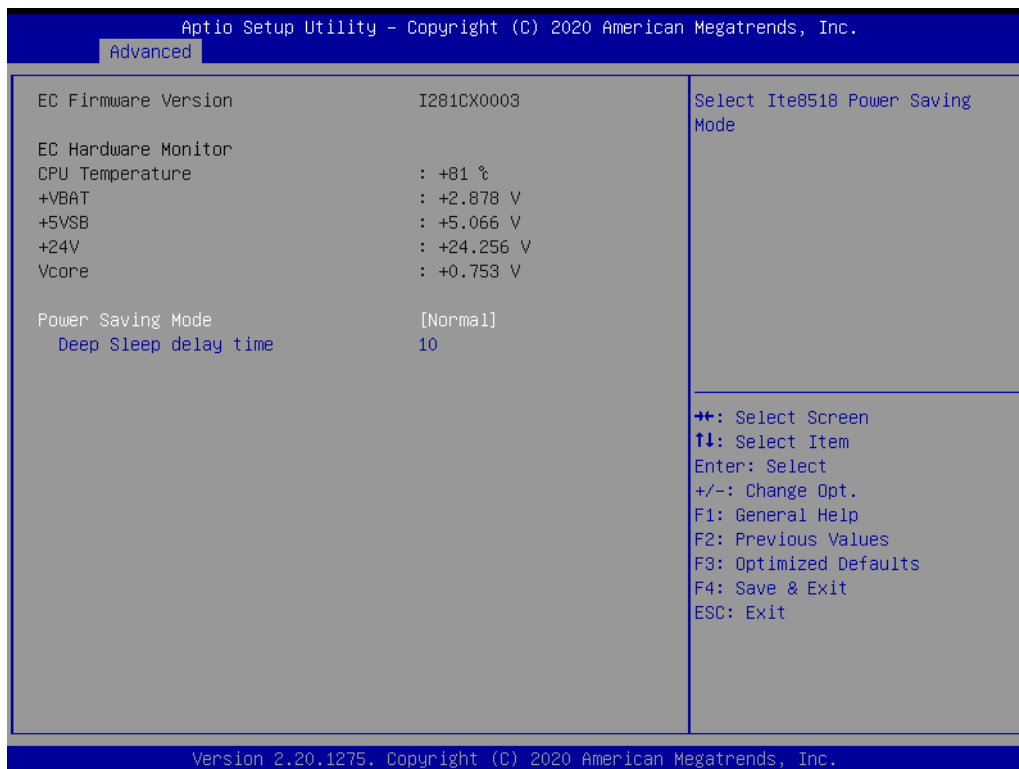
- **Enable ACPI Auto Configuration**  
This item allows users to enable/disable BIOS ACPI auto configuration.
- **Enable Hibernation**  
This item allows users to enable/disable the system hibernation function (OS/S4 Sleep State). This option may not be available with some operating systems.
- **ACPI Sleep State**  
This item allows users to select the highest ACPI sleep state when the Suspend button is pressed.

### C.1.2.5 Trusted Computing



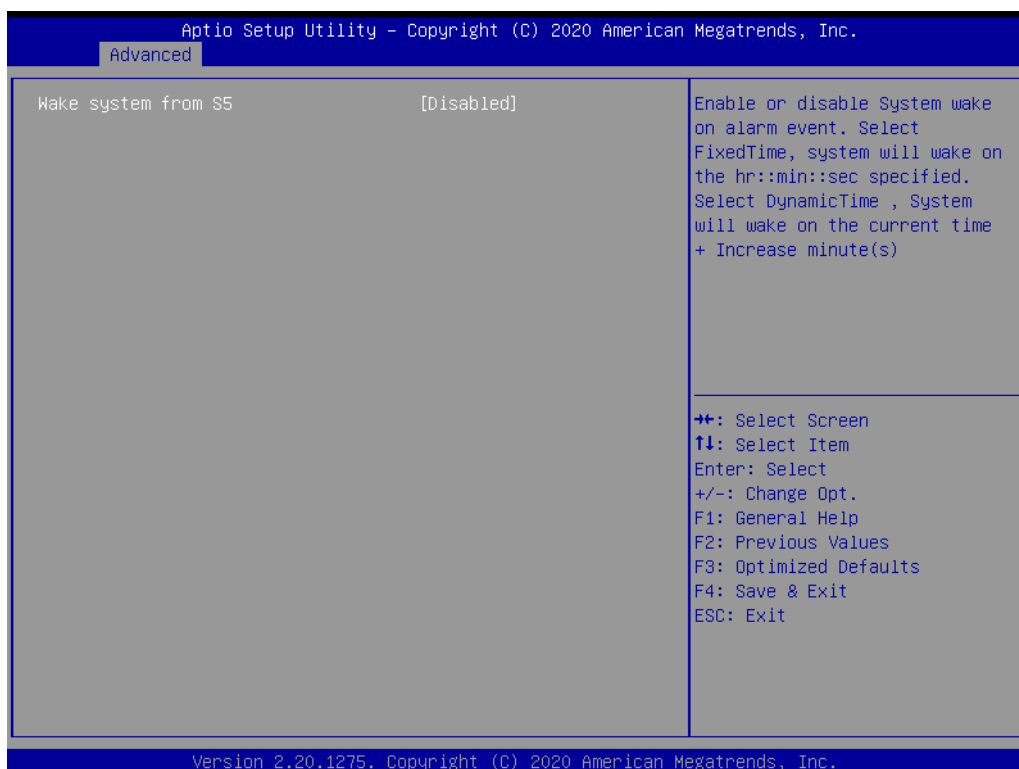
- **Security Device Support**  
This item allows users to enable/disable BIOS support for security devices. The OS will not show the security devices. The TCG EFI protocol and INT1A interface will not be available.
- **SHA-1 PCR Bank**  
This item allows users to enable/disable SHA-1 PCR bank.
- **SHA256 PCR Bank**  
This item allows users to enable/disable SHA256 PCR bank.
- **Pending Operation**  
This item allows users to schedule an operation for the security device.  
**Note:** The computer must be restarted to change the security device state.
- **Platform Hierarchy**  
This item allows users to enable/disable platform hierarchy.
- **Storage Hierarchy**  
This item allows users to enable/disable storage hierarchy.
- **Endorsement Hierarchy**  
This item allows users to enable/disable endorsement hierarchy.
- **TPM2.0 UEFI Spec Version**  
This item allows users to select the TCG2 spec version supported.  
TCG\_1\_2: The compatible mode for Win8/10.  
TCG\_2: Supports new TCG2 protocol and event formats for Win10 or later.
- **Physical Presence Spec Version**  
This item allows users to enable support for PPI spec version 1.2 or 1.3.  
**Note:** Some HCK tests may not support version 1.3.

### C.1.2.6 Embedded Controller Configuration



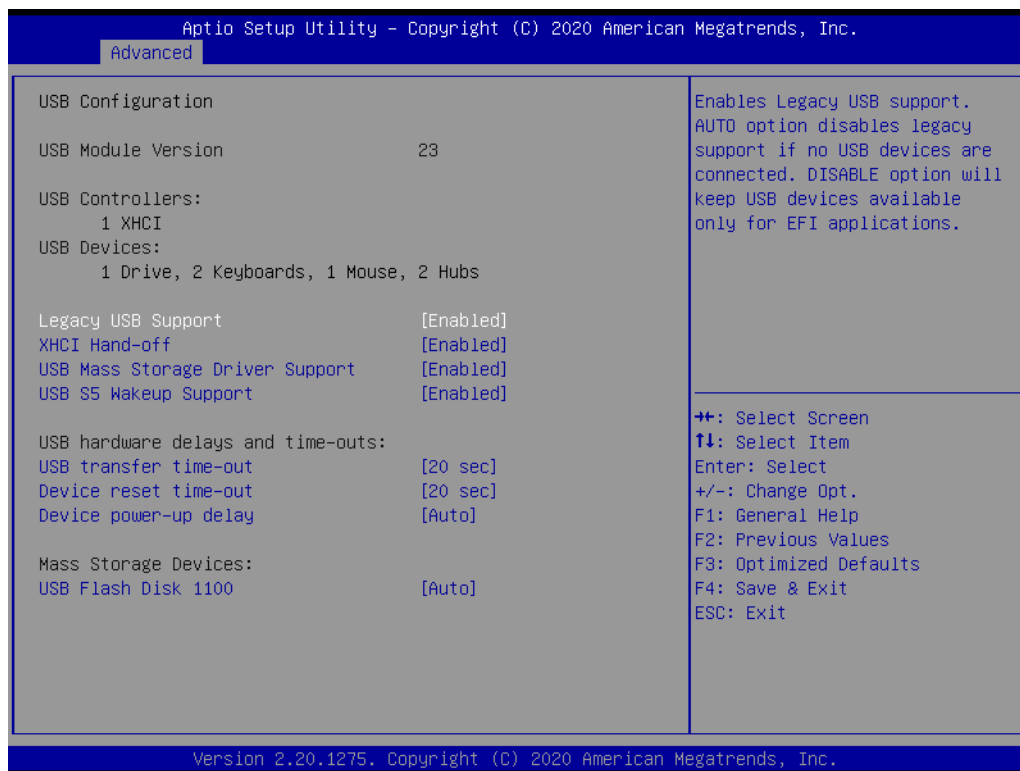
- **Power Saving Mode**  
This item allows users to select the Ite8518 power saving mode.
- **Deep Sleep Delay Time**  
This item allows users to set the delay time for Deep Sleep mode.

### C.1.2.7 S5 RTC Wake Settings



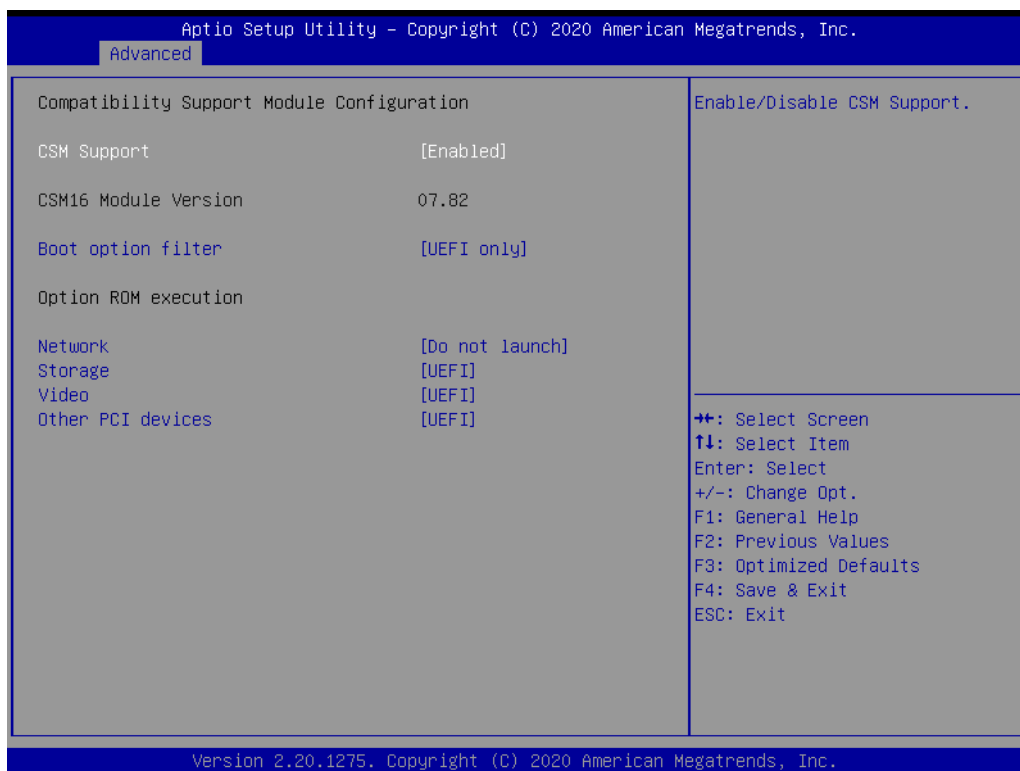
- Wake System From S5**  
 This item allows users to enable/disable system-wake-on alarm events. Select FixedTime, system will wake on the hr:min:sec specified. Select DynamicTime, system will wake on the current time + added minute(s).

### C.1.2.8 USB Configuration



- Legacy USB Support**  
 This item allows users to enable/disable legacy USB support. The Auto option disables legacy support if no USB devices are connected. The Disable option reserves USB devices for EFI applications.
- XHCI Hand-Off**  
 This is a workaround for operating systems without XHCI hand-off support. The XHCI ownership change should be conducted by the XHCI driver.
- USB Mass Storage Driver Support**  
 This item allows users to enable/disable USB mass storage driver support.
- USB S5 Wakeup Support**  
 This item allows users to enable/disable USB S5 wakeup support.
- USB Transfer Time-Out**  
 This item allows users to set the time-out value for Control, Bulk, and Interrupt USB mass storage device transfers.
- Device Reset Time-Out**  
 This item allows users to set the device reset command time-out.
- Device Power-Up Delay**  
 This item allows users to Set the maximum time the device will take before reporting itself to the Host Controller. The Auto option uses the default value, which is 100 ms for a Root port. For a Hub port, the delay time is obtained from the Hub descriptor.
- USB Flash Disk 1100**  
 Mass storage device emulation type. The Auto option emulates devices according to media format. Optical drives are emulated as “CDROM” drives. No media is emulated according to driver type.

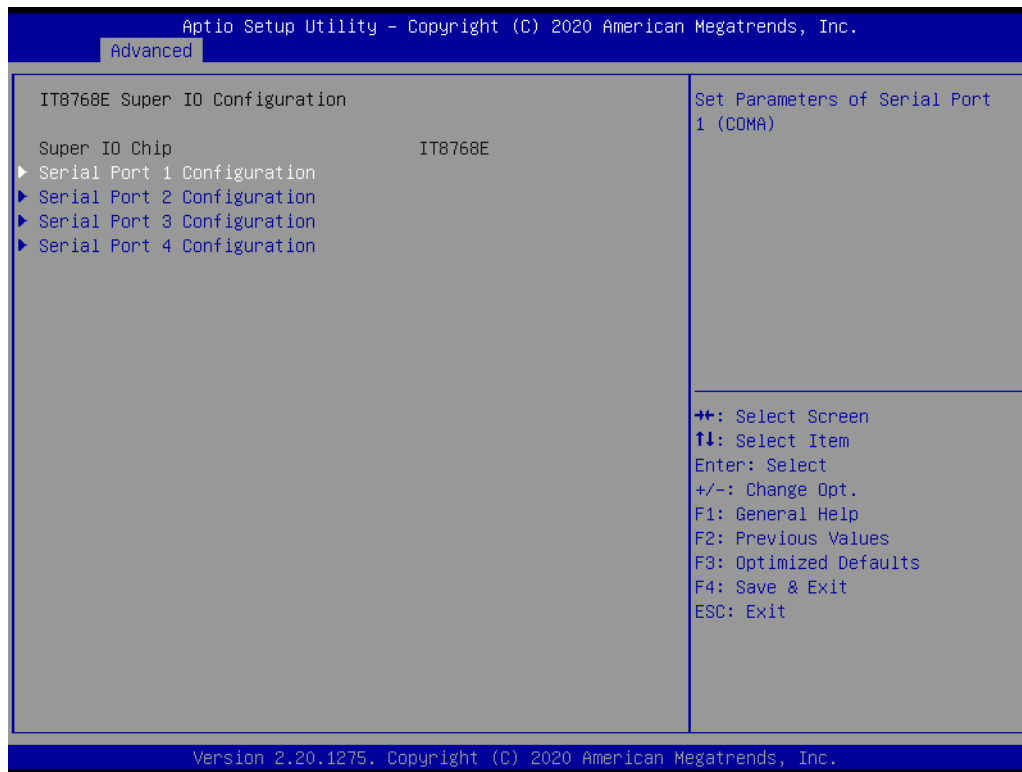
### C.1.2.9 CSM Configuration



- **CSM Support**  
This item allows users to enable/disable CSM support.
- **Boot Option Filter**  
This item allows users to control the priority of legacy/UEFI ROMs.
- **Network**  
This item allows users to control the execution of UEFI and legacy network OpROM.
- **Storage**  
This item allows users to control the execution of UEFI and legacy storage OpROM.
- **Video**  
This item allows users to control the execution of UEFI and legacy video OpROM.
- **Other PCI Devices**  
This item allows users to determine the OpROM execution policy for devices other than network, storage, and video.

### C.1.2.10 NVMe Configuration

### C.1.2.11 IT8768E Super IO Configuration



- **Serial Port 1 Configuration**  
This item allows users to set the parameters of Serial Port 1 (COM A).
- **Serial Port 2 Configuration**
- **Serial Port 3 Configuration**
- **Serial Port 4 Configuration**



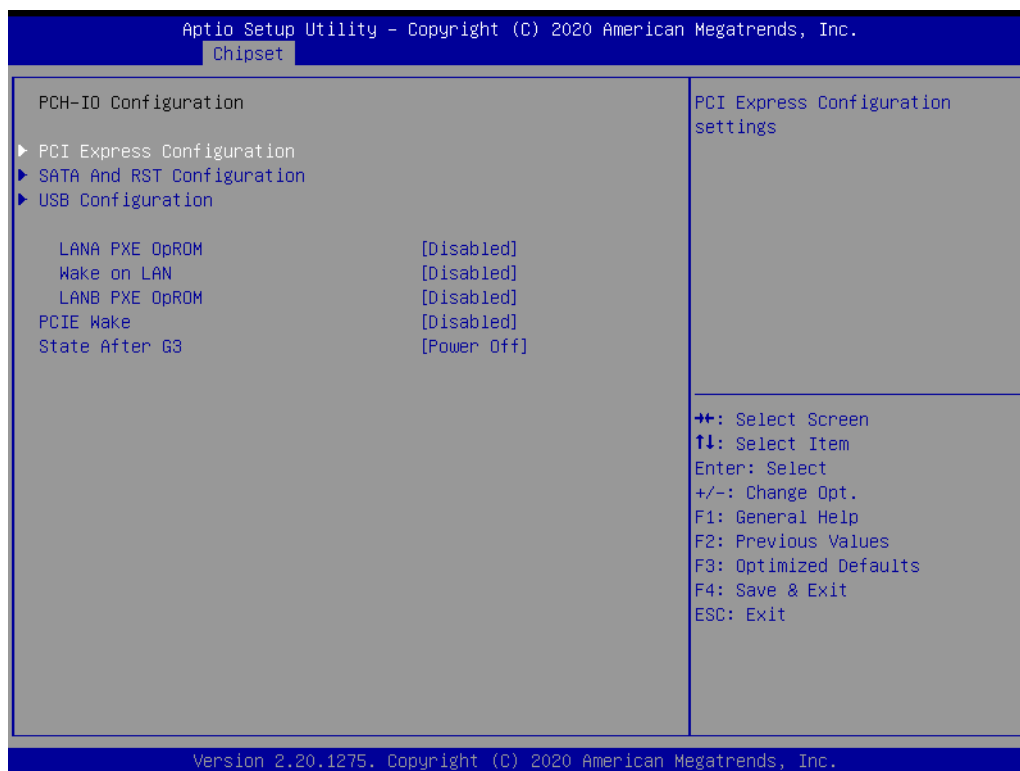
## C.1.3 Chipset Configuration

### C.1.3.1 System Agent (SA) Configuration



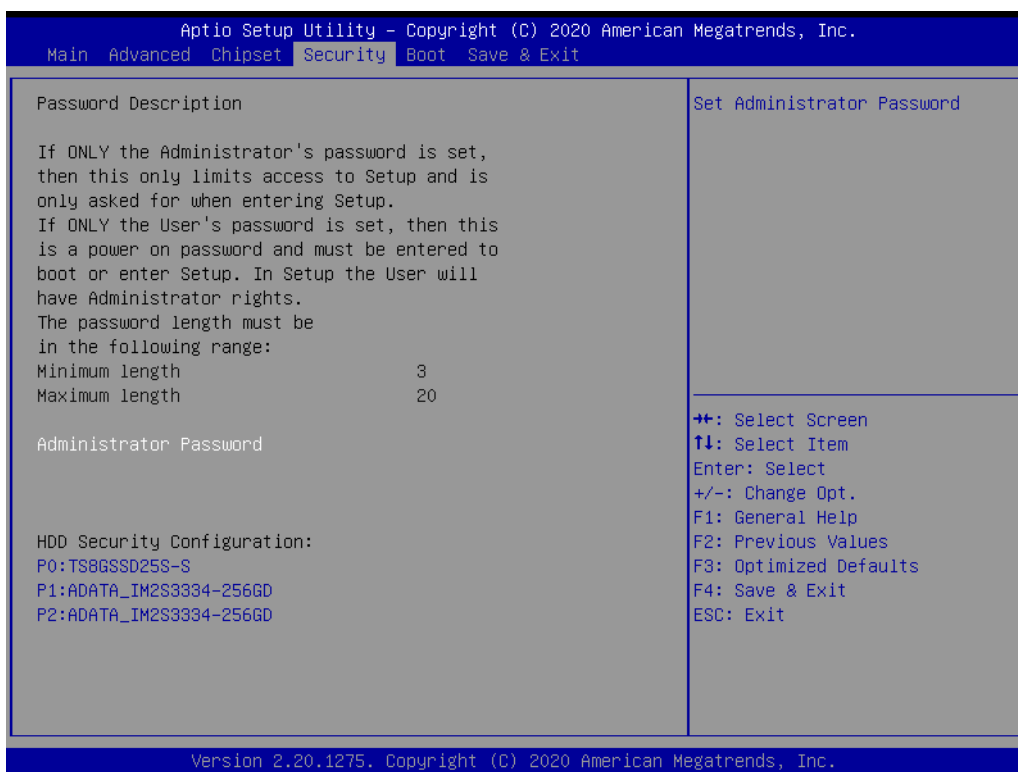
- **Memory Configuration**  
This item allows users to set the memory configuration parameters.
- **Graphics Configuration**

### C.1.3.2 PCH-IO Configuration



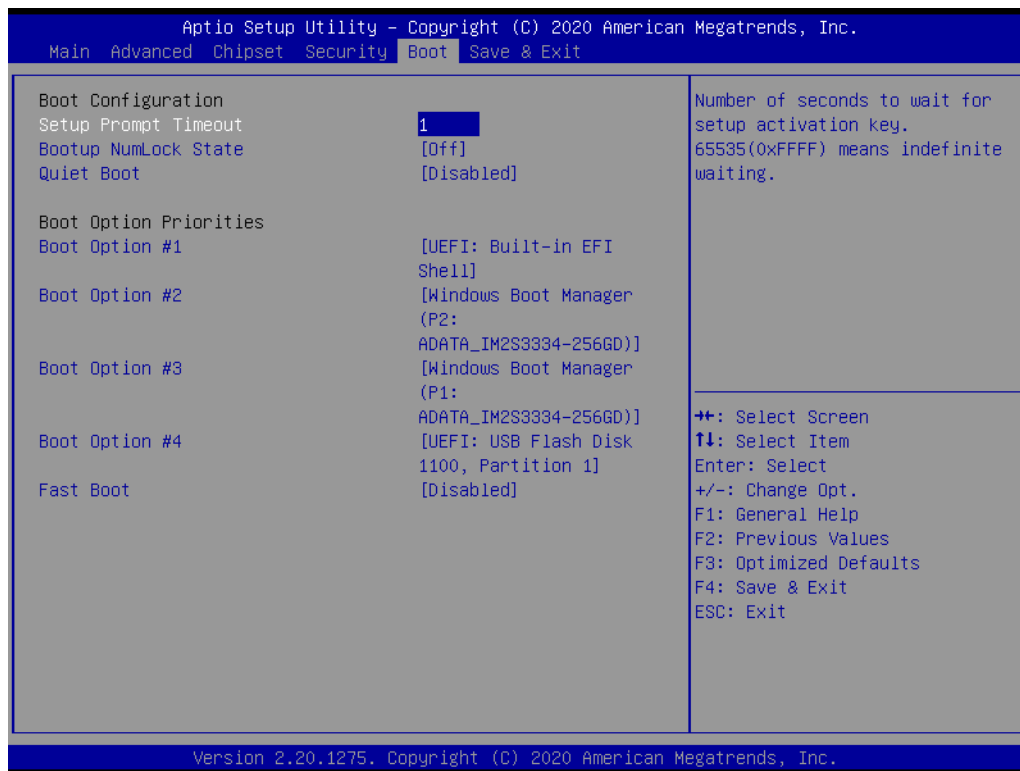
- **PCI Express Configuration**  
This item allows users to set the PCI express configuration settings.
- **SATA and RST Configuration**
- **USB Configuration**
- **XHCI Compliance Mode**  
This item allows users to enable/disable Compliance mode. The default setting is disabled. This option must be enabled for Compliance mode testing.
- **USB Port Disable Override**  
This item allows users to selectively enable/disable the corresponding USB port from reporting a device connection to the controller.

## C.1.4 Security



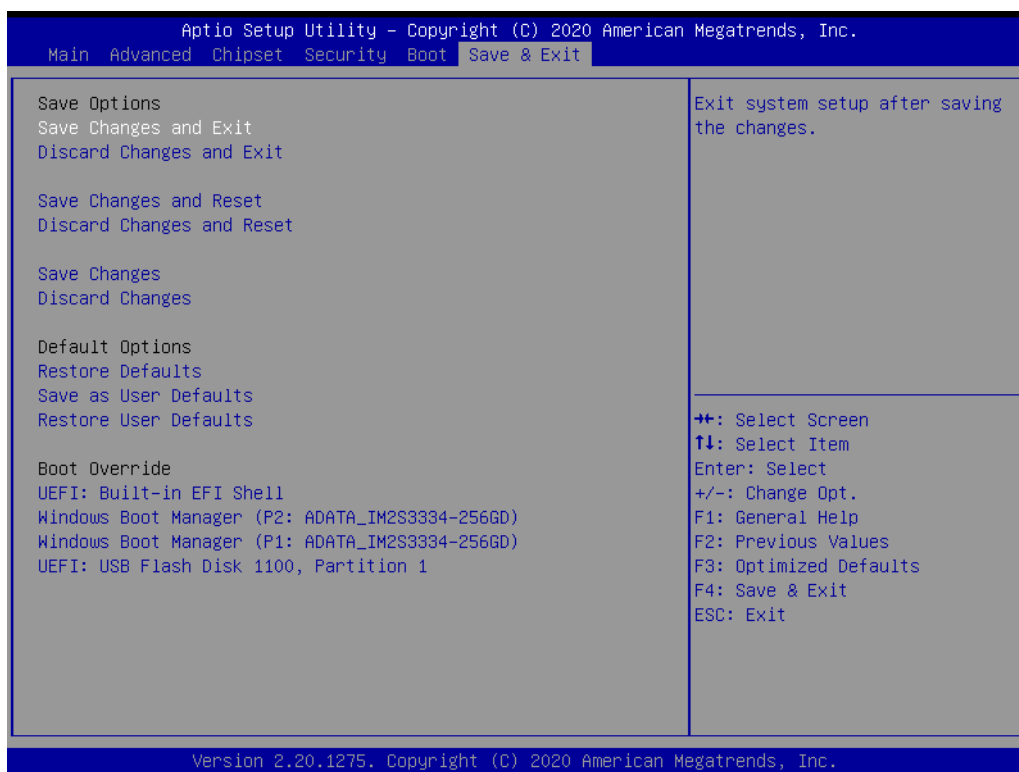
### ■ Set Administrator Password

## C.1.5 Boot



- **Setup Prompt Timeout**  
This item allows users to set the number of seconds to wait for setup activation key. 65535 (0xFFFF) means indefinite waiting.
- **Bootup NumLock State**  
This item allows users to select the keyboard NumLock state.
- **Quiet Boot**  
This item allows users to enable/disable quiet boot option.
- **Boot Option #1**
- **Boot Option #2**
- **Boot Option #3**
- **Boot Option #4**
- **Fast Boot**  
This item allows users to enable/disable fast boot, where a minimal set of devices is launched for active boot. This item does not affect BBS boot options.

## C.1.6 Save & Exit



- **Save Charges and Exit**  
This item allows users to exit the system setup after saving changes.
- **Discard Changes and Exit**  
This item allows users to exit the system setup without saving changes.
- **Save Changes and Reset**  
This item allows users to reset the system after saving changes.
- **Discard Changes and Reset**  
This item allows users to reset the system without saving changes.
- **Save Changes**  
This item allows users to save any changes to the setup options.
- **Discard Changes**  
This item allows users to discard any changes to the setup options.
- **Restore Defaults**  
This item allows users to restore/load default values for all setup options.
- **Save as User Defaults**  
This item allows users to save all current settings as user defaults.
- **Restore User Defaults**  
This item allows users to restore all setup options to the user default values.





## [www.advantech.com](http://www.advantech.com)

Please verify specifications before quoting. This guide is intended for reference purposes only.

All product specifications are subject to change without notice.

No part of this publication may be reproduced in any form or by any means, such as electronically, by photocopying, recording, or otherwise, without prior written permission from the publisher.

All brand and product names are trademarks or registered trademarks of their respective companies.

© Advantech Co., Ltd. 2020