



Think Automation and beyond...



IDEC FT1A SmartAXIS

Value. Versatility. The New Breed of Controllers.



Value. Versatility. The New Breed of Controller!

The ideal solution for a variety of applications.

Presenting FT1A, the newest family of SmartAXIS controllers from the industry's original manufacturer of micro PLCs. FT1A controllers deliver affordability without compromise. Features and functions are already built in, so engineers can now enjoy more versatility and more choices for their automation needs than ever before.

Designed to give you the most bang for your buck, these simple, powerful controllers deliver an exceptional value. FT1A controllers are available with 12, 24, 40, or 48 I/O, while a 3.8-inch HMI + PLC with sophisticated features and a super-bright LCD screen is also available.

All FT1A controllers meet the highest industry standards for quality and safety. The FT1A SmartAXIS family is CE compliant, cULus listed, has an ABS type approval and is Class I Division 2 rated for hazardous locations. Whatever your application requires, the FT1A SmartAXIS family has a solution!



A Breed of Its Own

The perfect combination of PLC processing and HMI monitoring and control, the 3.8-inch FT1A Touch is an all-in-one touchscreen interface and logic controller. With a compact body and full complement of features, FT1A Touch is perfect for small systems that require a graphical user interface along with versatile I/O controls at a truly affordable price.

Analog Expansion Cartridge (Output Models)

- Up to 2 analog expansion adap on the FT1A Touch with 12-bit
- Maximum combination of 2in/6in/2out analog I/O can be cor

RS232C and RS485 ports

- Built-in RS232C, RS422/485 interface for serial communication.
- Communication with IDEC or other PLCs also supported through this serial port.

Relay or Transistor Outputs

- Relay output type equipped with 10A contact, relays required.
- Transistor output type equipped with 300mA

Analog Outputs (Transistor Output Models)

2 built-in 0-10VDC, 4-20mA analog outputs.

Digital, Analog and High-s

- 8 built-in DC inputs
- 2 inputs (I6 and I7) can be co or 4-20mA analog inputs (tr – 10-bit resolution
 - 4 high-speed counters – Up to 10kHz

Harsh Env

- Class I, Di
- -20 to 55°

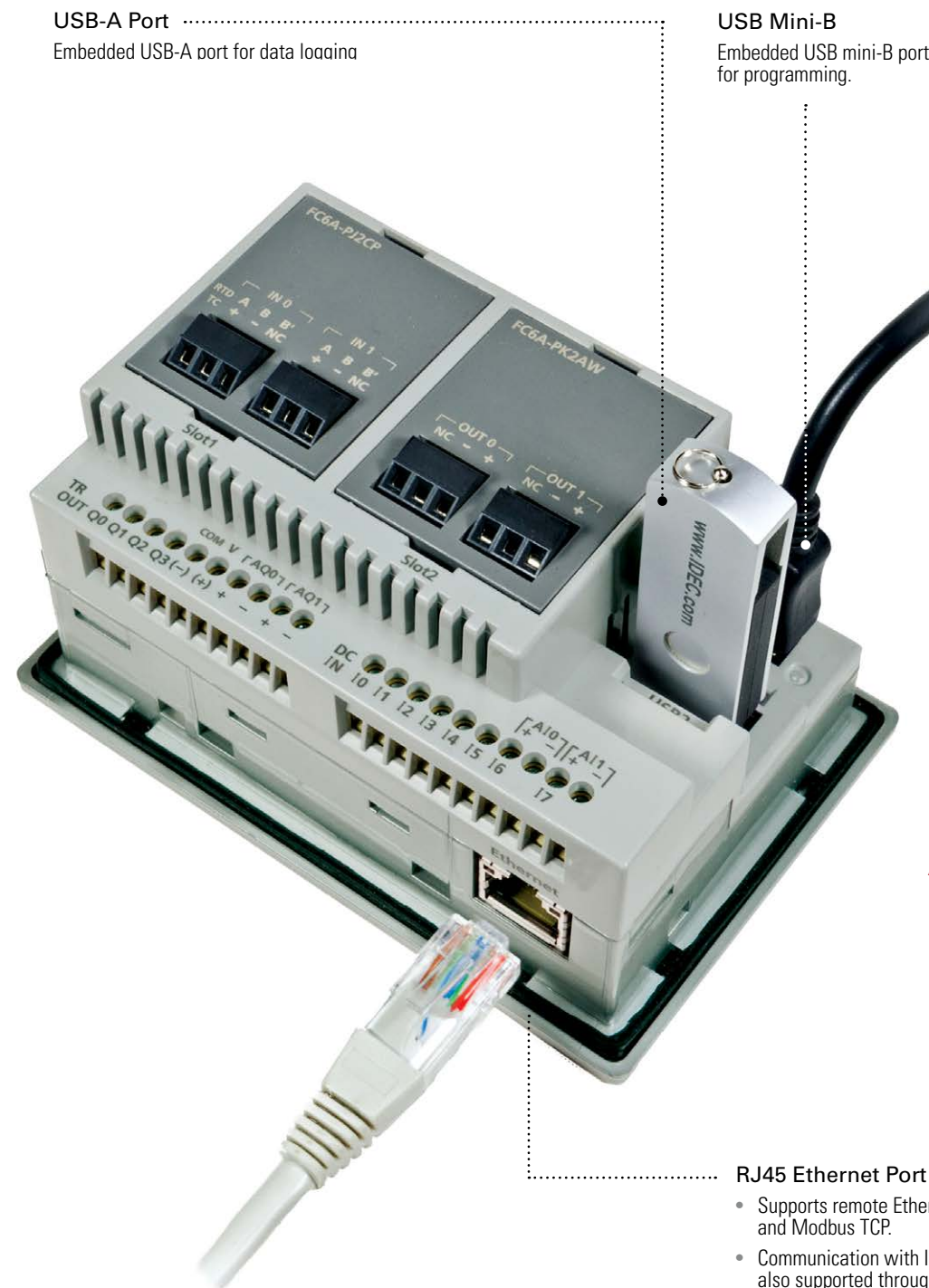

USB-A Port
Embedded USB-A port for data loading

USB Mini-B
Embedded USB mini-B port for programming.

3 Bezel Colors
Available in silver, light gray and dark gray bezel.

STN Monochrome or 65K TFT Color

- 400cd/m² color
- 740cd/m² monochrome

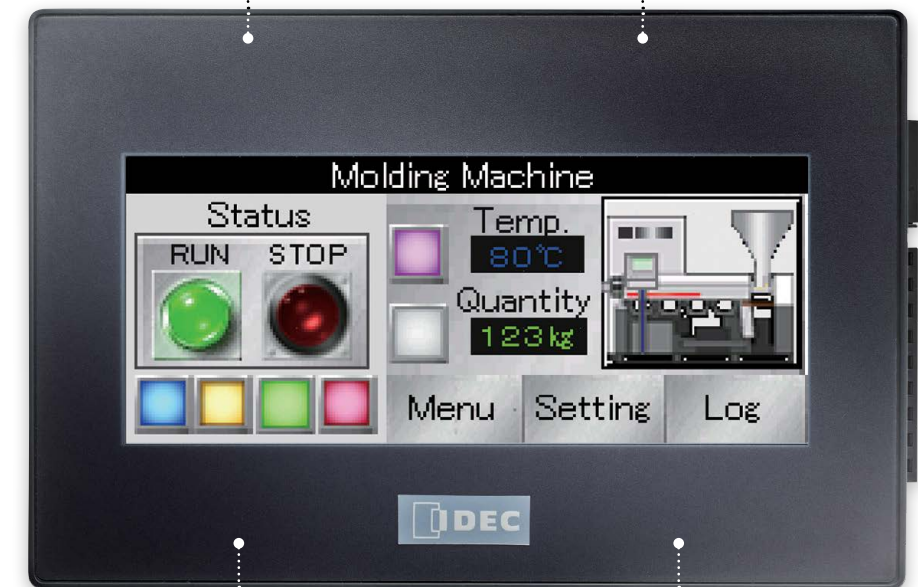

Actual Size

IP66f (water and oil tight),
NEMA 4X (indoor) and 13

5MB Screen Editing Memory
Provides users with more flexibility and stress-free programming.

RJ45 Ethernet Port

- Supports remote Ethernet communication and Modbus TCP.
- Communication with IDEC or other PLCs also supported through the Ethernet port.

800.262.4332

www.IDEC.com/FT1A

Control Functions

Fast Processing Speed

Basic instructions can be processed in 1850µs per 1000 steps of programming.

Data Logging

Critical data can be saved and logged into a USB memory stick then retrieved over an Ethernet connection or by removing the USB memory stick from the FT1A Touch and inserting it into a laptop or PC.

	A	B	C	D
1	Project Name	FT1A Touch Modbus RTU	5.01	
2	File Type	Data Log Data		
3	Channel No.	1		
4	Source	#D 0		
5	Sampling Method	Fixed Period		
6	Time[Sec]	10		
7				
8	Sampling Time	Data001		
9	06/05/2013 15:46:25		10	
10	06/05/2013 15:46:35		19	
11	06/05/2013 15:46:45		28	
12	06/05/2013 15:46:55		37	
13	06/05/2013 15:47:05		46	
14	06/05/2013 15:47:15		55	
15	06/05/2013 15:47:25		64	
16	06/05/2013 15:47:35		73	
17	06/05/2013 15:47:45		83	
18	06/05/2013 15:47:55		92	
19	06/05/2013 15:48:05		101	
20	06/05/2013 15:48:15		110	
21	06/05/2013 15:48:25		119	
22	06/05/2013 15:48:35		128	
23	06/05/2013 15:48:45		137	
24	06/05/2013 15:48:55		146	
25	06/05/2013 15:49:05		155	

Easy Program File Transfer

Project files can be transferred between a USB memory stick and the FT1A Touch. It is a quick and convenient way for an OEM to program multiple units and for users to quickly update ladder and HMI programs.



Digital and Analog Inputs

The FT1A Touch is equipped with 8 digital inputs, two of which can be configured as 0-10V DC or 4-20mA analog inputs with 10-bit resolution, reducing overall system cost.

High-speed Counters

With 8 built-in inputs, 4 can be configured as high-speed counters, with a maximum frequency (range) of 10kHz for single-phase or 5kHz for dual-phase.

Remote I/O

Up to three FT1A controllers (24, 40 and 48 I/O) can be configured as remote I/O slaves for the FT1A Touch, expanding your system's potential. A maximum of 158 I/O can be achieved.

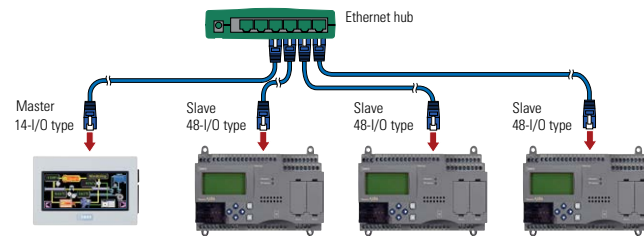

Analog Expansion Cartridges

Using analog expansion cartridges, FT1A Touch can accept 0-10V DC, 4-20mA, RTD and Thermocouple inputs, with 12 to 15-bit resolution.

PID Controls

With an improved PID algorithm and easier-to-configure dialog box, PID controls can be monitored using a single screen. Advanced PID control functions, such as auto-tuning, ARW (anti-reset windup) and bumpless transfer, are also supported.

Large Programming Memory

With 47.4KB of logic controls programming memory, complex PLC programs can be constructed without much restriction. And with 5MB of configuration memory for the display, a unique and professional display interface can be easily configured.

10A Relay Outputs

With 10A contact ratings on all four of the relay outputs, the FT1A Touch can be directly connected to a solenoid valve or motor, which eliminates interposing relays and reduces wiring.

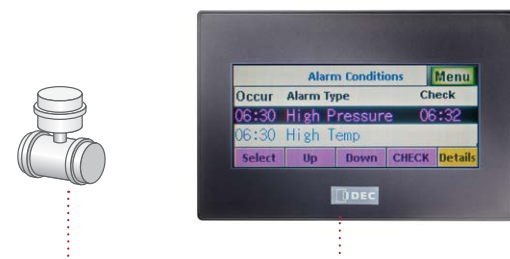

Display Functions

Ethernet Connectivity

With the embedded RJ45 Ethernet port, FT1A project files can be remotely uploaded or downloaded over an Ethernet connection. Critical logging data can also be retrieved quickly.

Modbus TCP or RTU

The built-in Ethernet ports allow the FT1A Touch to be configured as a Client (Master) or Server (Slave) on the Modbus network. Modbus RTU (Master/Slave) is also supported. With these capabilities, FT1A Touch can communicate with other PLCs or devices using Modbus protocol.

Ladder Program and I/O status

Ladder programs can easily be monitored and controlled on the 3.8" (3.7" monochrome) display. It is a unique tool to debug the system without using WindLDR software and a PC. I/O status and any control parameter such as data register, timer, and internal relay can also be monitored and controlled.



65,536 TFT Color LCD

With so many color combinations, an intuitive and crisp graphical user interface can be constructed with unparalleled visibility.

Super-Bright LED

The 65K TFT color unit is rated at 400cd/m², while the monochrome unit is rated at 740cd/m². With 32 levels of brightness control, the backlight can even be adjusted according to the surrounding conditions.

Drivers for IDEC and other PLCs

FT1A Touch can easily be configured to communicate with IDEC or other PLCs such as Siemens, Automation Direct, Mitsubishi, Omron, and more.

Fast Start-up

Once power is applied to the FT1A Touch, it takes only 3 seconds for it to be fully functional. The fast start-up allows for fast, easy debugging and stress-free operation.



800.262.4332

www.IDEC.com/FT1A

FT1A Controllers

FT1A controllers are designed for a range of applications that demand powerful and abundant features. Available with 12, 24, 40 and 48 I/O with and without embedded LCD/keypad, these controllers enable engineers to design cost-effective solutions.

Universal Voltages
24V DC or 100-240V AC

Digital, Analog and High-speed Inputs

Inputs on the 24V DC power models can be configured as digital, 0-10V DC analog or high-speed counters. Up to 8 analog inputs with 10-bit resolution and up to 6 HSC 100kHz can be configured.



RJ45 Ethernet Port

The embedded Ethernet port on the FT1A controllers provides users with easy access for remote maintenance and communication. It also supports industry standard Modbus TCP protocol. With Ethernet Remote I/O capability, the FT1A controller's I/O can be easily expanded.

Smart LCD Screen

The display (24 digits x 4 lines) can provide visual feedback of system status, I/O status, user configurable messages with dynamic data, bar graph, and ladder program monitor and controls.

Non-LCD Model

FT1A controllers are also available without embedded LCD/keypad. It's a cost-effective, tamper-proof solution.

USB mini-B

With the USB mini-B port, communication with FT1A controllers is extremely convenient as standard USB Type A to mini-B cables can be used.

Real-Time Clock

Every FT1A controller is equipped with an embedded real-time clock for time-controlled applications. With the built-in, real-time clock, log data can also be tracked and, with just a click, daylight savings time can easily be setup.

RS232C and RS485 Ports

Up to two RS232C and/or RS485 communication cartridges can be plugged into the FT1A controllers to allow the PLC to communicate with other serial devices. It also supports industry standard Modbus RTU protocol.

Large Programming Memory

With up to 47.4KB (11,850 steps) of programming memory, FT1A controllers have enough memory for even complex PLC programming.

SD Memory Card

With the embedded SD memory slot, critical data can be easily logged and retrieved over Ethernet connections or simply remove the SD card and plug it into your PC.



Actual Size

Memory Cartridge

The optional memory cartridge can be used to easily transfer programs from the internal ROM memory of FT1A controllers to a memory cartridge or vice versa. It's a convenient method to update the PLC program in the field.

10A Relay and High-speed Outputs

The FT1A controller with relay outputs is equipped with four 10A relay contacts. The transistor outputs model is also equipped with two 100kHz high-speed outputs for simple positioning controls. With remote I/O capability, additional outputs can easily be added.



Note: Features available on specific models. See page 14 for selection guide.

800.262.4332

www.IDEC.com/FT1A

From Connecting to Remote Access

From connectivity to remote access to visual display, FT1A leads the way with versatile, full-featured controllers. No other controllers offer such a broad range of capabilities at such a competitive price.

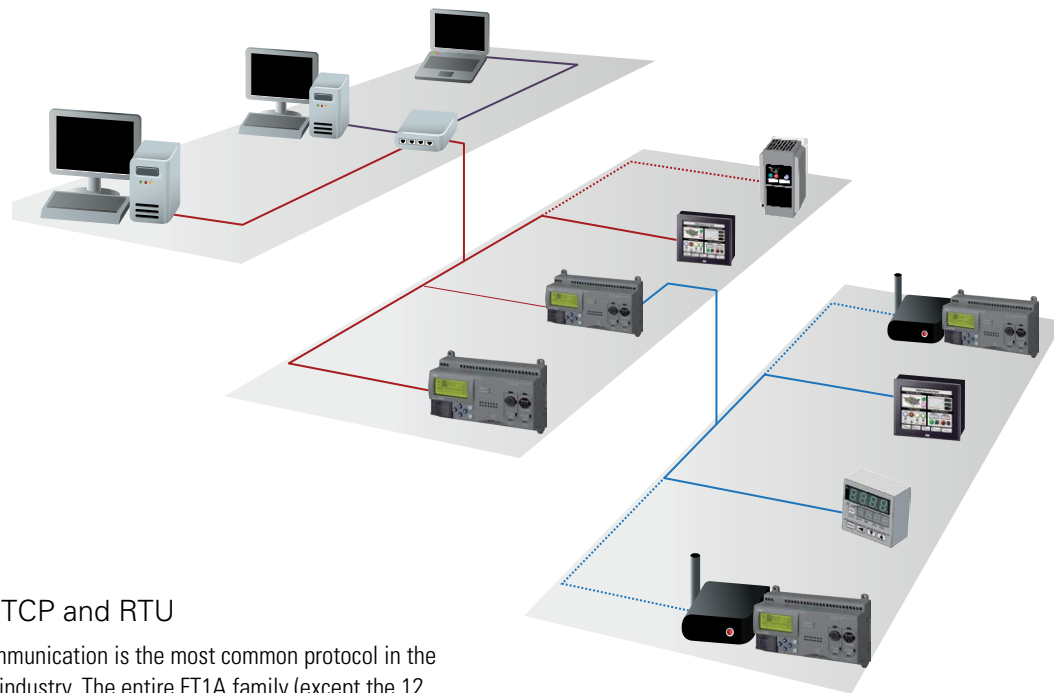

Modbus TCP and RTU

Modbus communication is the most common protocol in the automation industry. The entire FT1A family (except the 12 I/O CPU) supports Modbus TCP and Modbus RTU, making communication with other devices a breeze.

Ethernet Connectivity

Thanks to the embedded RJ45 Ethernet port (on all models except 12 I/O), FT1A controllers can be easily accessed from remote locations. Using WindLDR software, PLC programs can be updated remotely and critical parameters monitored and controlled. Remote connectivity is a critical part of today's control environment, and FT1A controllers meet every challenge with fast, easy, and reliable Ethernet connectivity.

SD Memory Card

FT1A 40 and 48 I/O controllers are equipped with an SD memory slot for data logging. Memory cards up to 32GB are supported. Log data is time/date stamped and stored in .CSV format, making it simple to review and analyze critical system data.

Smart LCD Display

With the embedded LCD screen, I/O status, system menus, customized dynamic messages, and bar-graph readouts can all be configured and displayed. Ladder programs can be displayed and controlled as well. You can configure up to 50 customized messages, all with dynamic values (24 digits by 4 lines max.). The backlight can be turned on or off. Scrolling and flashing are also supported.

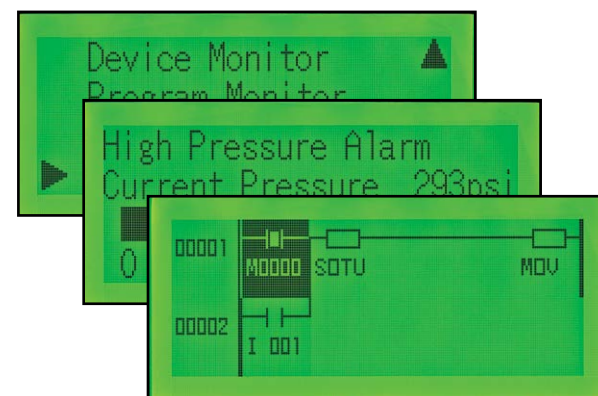

Remote I/O

The FT1A remote I/O, available in all Ethernet-capable modules, enables you to expand the number of inputs and outputs by simply connecting separate FT1A modules via Ethernet as remote I/O slaves. The FT1A remote I/O can monitor and control a total of 192 points of I/O.

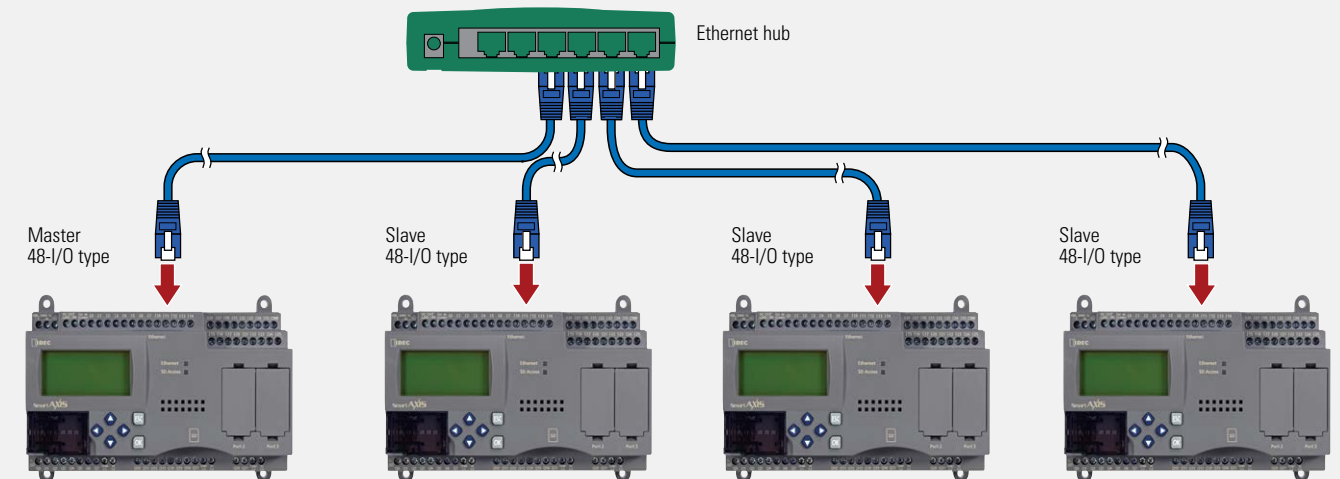

48-I/O type (master) + 48-I/O type (slave) + 48-I/O type (slave) + 48-I/O type (slave) = 192 I/O
 (30 inputs, 18 outputs) + (30 inputs, 18 outputs) + (30 inputs, 18 outputs) + (30 inputs, 18 outputs) = 120 inputs, 72 outputs

Built-in Analog Inputs

The FT1A controllers support up to 8 built-in, 0-10V DC analog inputs with 10-bit resolution, depending on the model. Having the option to configure the analog inputs on the CPU saves you time, space and money.

100kHz, High-Speed Counters and Outputs

Models with transistor outputs feature two 100kHz high-speed outputs for positioning control and all FT1A controllers are equipped with up to six 100kHz high-speed counters.

10 Amp Relay Contacts

FT1A controllers with relay outputs offer 10 Amp rated contacts. Traditional PLC relays are only rated for 2 Amps. Therefore, FT1A controllers reduce the need for, and spare you the cost of, using interposing relays.

Built-in Real Time Clock

Equipped with a real-time clock for use with any time-controlled applications, FT1A controllers have built-in support for US, Canadian, European, and Australian daylight savings time. The option for the user to configure their own custom daylight savings schedule is also available, providing the utmost in flexibility.

USB Maintenance Port

A convenient USB mini-B maintenance port is standard on all FT1A controllers, which means any standard Type A to mini-B USB cable can be used. No special cable is necessary.

800.262.4332

www.IDEC.com/FT1A

A Complete Automation Suite: All-in-one Configuration Software

Automation Organizer (AO) is a powerful software suite containing WindLDR PLC programming software, WindO/I-NV2 HMI configuration software, WindO/I-NV3 FT1A Touch configuration software, and WindCFG system configuration software. AO is an all-in-one automation software package for IDEC PLCs and IDEC HMIs. The news gets even better, because AO software upgrades are always FREE.

WindO/I-NV3

WindO/I-NV3 is our exclusive configuration software for the FT1A Touch. Using the same platform as WindO/I-NV2 HG HMI programming software, WindO/I-NV3 provides users with the same intuitive experience. Users can easily display alarm screens, trend and bar graphs, scrolling texts and meters. With thousands of industry-standard bitmap libraries, creating a professional interface is just a click away.

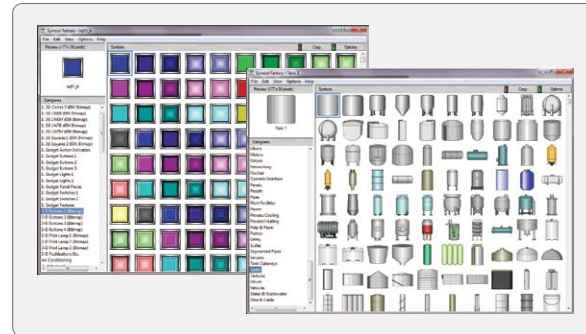

WindLDR

All IDEC PLCs—including the FT1A family—are programmed with WindLDR software. This icon-driven programming tool combines logic and intuition with an incredibly easy-to-use interface. Offline simulation, I/O Force and program bookmarks are just some of the standard features you'll find in WindLDR. Newly added for FT1A are Function Block Diagram (FBD) and Script programming. Over the years, WindLDR has proven to be the most user-friendly, intuitive software available for beginners and advanced programmers alike.

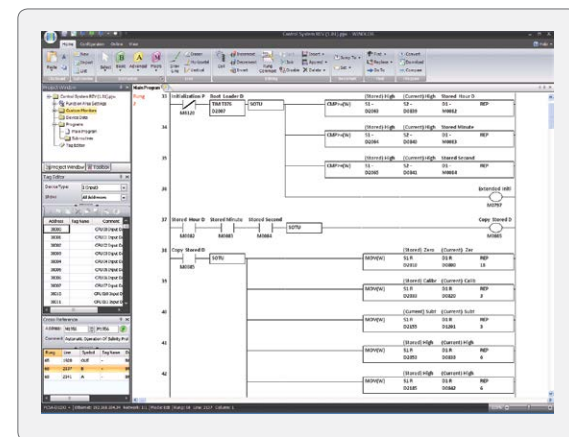

Simulation Mode

WindLDR allows you to simulate ladder and Function Block Diagram (FBD) programs in FT1A. You can easily test and verify functionality of your ladder and FBD programs without having to connect any hardware.

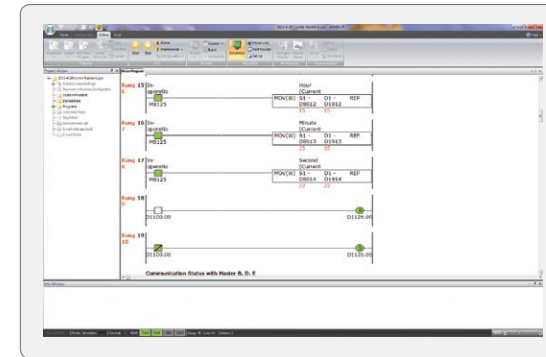

Comment Download Settings

The comment download settings allow you to choose whether to download Tag names, rung comments, custom monitor dialog boxes or file names. The biggest advantage of utilizing these settings is that once a program is retrieved from the PLC, all these important parameters will be available.

Function Block and Scripting

In addition to ladder logic, WindLDR now supports Function Block Diagram (FBD) and Script programming. With the FT1A controllers, you now have the flexibility and convenience of programming using any or all of these methods.

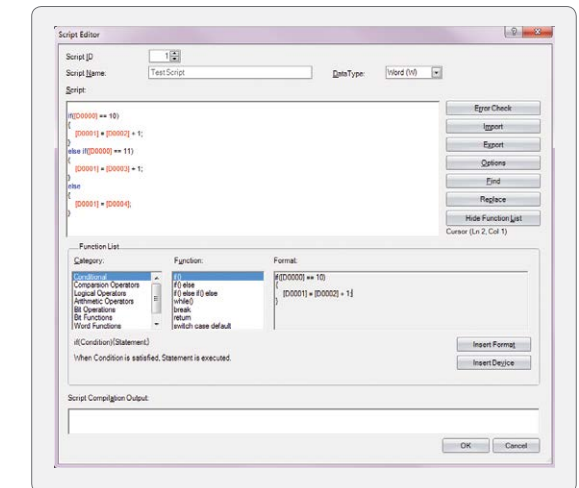

Free 30-Day Demo

Curious to see how an IDEC FT1A SmartAXIS controller might complement your design? Find out for yourself!

Just go to www.IDEC.com/download and download your free 30-day demo.

800.262.4332

www.IDEC.com/FT1A

Touch Part Numbers

Touch	Part Number	Screen Type	Total I/O	Input Type	Embedded Analog Inputs	Embedded Analog Outputs	Output Type	Analog Expansion Cartridges	Power Voltage	Remote I/O Master
	FT1A-M14KA-W	3.7" STN Monochrome (8 shades)	14 I/O (8 in, 6 out)	Source	2pt (0-10VDC, 4-20mA, 10-bit Resolution)	2pt (0-10VDC, 4-20mA, 10-bit Resolution)	Transistor Sink	Yes, up to 2 cartridges	24V DC	Yes
	FT1A-M14KA-B									
	FT1A-M14KA-S									
	FT1A-M14SA-W									
	FT1A-M14SA-B									
	FT1A-M14SA-S	3.8" TFT 65,536 colors	14 I/O (8 in, 6 out)	Sink	2pt (0-10VDC, 4-20mA, 10-bit Resolution)	2pt (0-10VDC, 4-20mA, 10-bit Resolution)	Transistor Source	Yes, up to 2 cartridges	24V DC	Yes
	FT1A-C14KA-W									
	FT1A-C14KA-B									
	FT1A-C14KA-S									
	FT1A-C14SA-W									
	FT1A-C14SA-B	3.7" STN Monochrome (8 shades)	12 I/O (8 in, 4 out)	Sink	2pt (0-10VDC, 10-bit Resolution)	—	Relay	—	—	—
	FT1A-M12RA-W									
	FT1A-M12RA-B									
	FT1A-M12RA-S									
	FT1A-C12RA-W									
	FT1A-C12RA-B	3.8" TFT 65,536 colors	12 I/O (8 in, 4 out)	Sink	2pt (0-10VDC, 10-bit Resolution)	—	Relay	—	—	—
	FT1A-C12RA-S									

Touch Starter Kits

Part Number	Description
KIT-TOUCH-□KW	FT1A Touch Starter Kit, Transistor sink output type, Light bezel, USB cable, 30W PS and software
KIT-TOUCH-□KB	FT1A Touch Starter Kit, Transistor sink output type, Dark bezel, USB cable, 30W PS and software
KIT-TOUCH-□KS	FT1A Touch Starter Kit, Transistor sink output type, Silver bezel, USB cable, 30W PS and software
KIT-TOUCH-□SW	FT1A Touch Starter Kit, Transistor source output type, Light bezel, USB cable, 30W PS and software
KIT-TOUCH-□SB	FT1A Touch Starter Kit, Transistor source output type, Dark bezel, USB cable, 30W PS and software
KIT-TOUCH-□SS	FT1A Touch Starter Kit, Transistor source output type, Silver bezel, USB cable, 30W PS and software
KIT-TOUCH-□W	FT1A Touch Starter Kit, Relay output type, Light bezel, USB cable, 30W PS and software
KIT-TOUCH-□B	FT1A Touch Starter Kit, Relay output type, Dark bezel, USB cable, 30W PS and software
KIT-TOUCH-□S	FT1A Touch Starter Kit, Relay output type, Silver bezel, USB cable, 30W PS and software

In place of □ insert code for display type: C = color, M = monochrome

Touch Accessories

Part Number	Description
FC6A-PJ2A	2-pt 0-10V, 4-20mA Analog input cartridge
FC6A-PJ2CP	2-pt RTD, Thermocouple cartridge
FC6A-PK2AV	2-pt 0-10V Analog output cartridge
FC6A-PK2AW	2-pt 4-20mA Analog output cartridge
FT9Z-1D3PN05	FT1A Touch screen protective sheet (5 per pack)
FT9Z-1E3PN05	FT1A Touch protective cover (5 per pack)
FT9Z-1A01	FT1A Touch rear mount adapter
FT9Z-1T09	FT1A Touch extra communication terminal block
FT9Z-1X03	FT1A Touch extra power supply terminal block
HG9Z-4K2PN04	FT1A Touch extra mounting brackets (4 per pack)
HG9Z-XU1PN05	USB cable lock-in (5 per pack)
HG9Z-XCM2A	USB programming cable
SW1A-W1C	Automation Organizer Software Suite

Controller Accessories

Part Number	Description
FT1A-PC1	RS232C communication adapter, mini-DIN type
FT1A-PC2	RS485 communication adapter, mini-DIN type
FT1A-PC3	RS485 communication adapter, screw terminal type
FT1A-PM1	Optional memory cartridge
FT9Z-PSP1PN05	Extra direct mounting hook (5 per pack)
SW1A-W1C	Automation Organizer Software Suite
HG9Z-XCM2A	USB programming cable

800.262.4332

www.IDEC.com/FT1A

Controller Part Numbers

12 I/O CPU	Part Number	Power Voltage	Total I/O	Input Type	Output Type	Ethernet Port	Screen Type	Embedded Analog Inputs	High-Speed Counter	SD Memory Slot	RS232C, RS485 Port
	FT1A-H12RC	100-240V AC	12 I/O (8 in, 4 out)	Contact	Relay	—	2.1" Monochrome	—	—	—	—
	FT1A-H12RA	24V DC		Sink							
	FT1A-B12RC	100-240V AC		Contact							
	FT1A-B12RA	24V DC		Sink							
	FT1A-H24RC	100-240V AC	24 I/O (16 in, 8 out)	Sink/Source	Relay	Yes	2.1" Monochrome	4pt, 0-10VDC, 10-bit	6 x 100kHz	—	Optional Adapter
	FT1A-H24RA	24V DC		Sink							
	FT1A-B24RC	100-240V AC		Sink/Source							
	FT1A-B24RA	24V DC		Sink							
	FT1A-H40RC	100-240V AC	40 I/O (24 in, 16 out)	Sink/Source	Relay	Yes	2.1" Monochrome	6pt, 0-10VDC, 10-bit	6 x 100kHz	Yes	Optional Adapters (x2)
	FT1A-H40RKA	24V DC		Source	Relay/Trans. Sink						
	FT1A-H40RSA			Sink	Relay/Trans. Source						
	FT1A-B40RC	100-240V AC		Sink/Source	Relay						
	FT1A-B40RKA	24V DC		Source	Relay/Trans. Sink						
	FT1A-B40RSA			Sink	Relay/Trans. Source						
	FT1A-H48SC	100-240V AC	48 I/O (30 in, 18 out)	Sink/Source	Transistor Source	Yes	2.1" Monochrome	8pt, 0-10VDC, 10-bit	6 x 100kHz	Yes	Optional Adapters (x2)
	FT1A-H48SA	24V DC		Sink	Transistor Sink						
	FT1A-H48KC	100-240V AC		Sink/Source	Transistor Sink						
	FT1A-H48KA	24V DC		Source	Transistor Sink						
	FT1A-B48SC	100-240V AC		Sink/Source	Transistor Source						
	FT1A-B48SA	24V DC		Sink	Transistor Source						
	FT1A-B48KC	100-240V AC		Sink/Source	Transistor Sink						
	FT1A-B48KA	24V DC		Source	Transistor Sink						

Controller Starter Kits

Type	Part Number	Description
12 I/O CPU	KIT-SMART-12-□AC	SmartAXIS Starter Kit, 12 I/O AC, USB cable and software
	KIT-SMART-12-□DC	SmartAXIS Starter Kit, 12 I/O DC, USB cable and software
24 I/O CPU	KIT-SMART-24-□AC	SmartAXIS Starter Kit, 24 I/O AC with display/keypad, USB cable and software
	KIT-SMART-24-□DC	SmartAXIS Starter Kit, 24 I/O DC, USB cable and software
40 I/O CPU	KIT-SMART-40-□AC-R	SmartAXIS Starter Kit, 40 I/O AC, USB cable and software
	KIT-SMART-40-□DC-RK	SmartAXIS Starter Kit, 40 I/O DC, USB cable and software
48 I/O CPU	KIT-SMART-40-□DC-RS	SmartAXIS Starter Kit, 40 I/O DC, Source outputs, USB cable, 30W PS and software
	KIT-SMART-48-□AC-K	SmartAXIS Starter Kit, 48 I/O AC with display/keypad Sink, USB cable and software
	KIT-SMART-48-□AC-S	SmartAXIS Starter Kit, 48 I/O AC Source outputs, USB cable and software
	KIT-SMART-48-□DC-K	SmartAXIS Starter Kit, 48 I/O DC Sink outputs, USB cable, 30W PS and software
	KIT-SMART-48-□ADC-S	SmartAXIS Starter Kit, 48 I/O DC Source outputs, USB cable, 30W PS and software

In place of □ insert code: H = includes display/keypad, B = without display/keypad

General Specifications

Touch (PLC + HMI)	
Part Number	FT1A-*12RA-* / FT1A-*14KA-* / FT1A-*14SA-*
Output	Relay output / Transistor output
Rated Power Voltage	24V DC
Allowable Voltage Range	20.4 to 28.8V DC (including ripple)
Power Consumption	9.2W maximum / 10.1W maximum
Allowable Momentary Power Interruption	10ms maximum
Dielectric Strength	Between power terminal and FG: 500V AC, 5mA, 1 minute, Between power terminal and output terminal: 2,300V AC, 5mA, 1 minute / Between power terminal and FG: 500V AC, 5mA, 1 minute, Between power terminal and output terminal: 500V AC, 5mA, 1 minute
EMC Immunity	IEC/EN 61131-2:2007 compliant
Inrush Current	50A maximum (5ms maximum)
Operating Temperature	Color display: -20 to +55°C, Monochrome display: 0 to +55°C ^{Note 2}
Storage Temperature	-20 to +60°C (no freezing)
Relative Humidity	10 to 95% RH (no condensation)
Pollution Degree	2 (IEC 60664-1)
Corrosion Immunity	Atmosphere free from corrosive gases
Degree of Protection	IP66F, Type 4X & 13 (Panel front) ^{Note 1} , IP20 (Rear)
Ground	Functional grounding
Protective Grounding Conductor	UL1007 AWG16
Vibration Resistance	5 to 8.4Hz half amplitude 3.5mm, 8.4Hz to 150Hz acceleration 9.8m/s ² (1G), 2 hours per axis on each of three mutually perpendicular axis (IEC 61131-2)
Shock Resistance	147m/s ² , 11ms, X, Y, Z directions 3 times (IEC 61131-2)
Mounting Structure	Panel mount
Weight (approx.)	300g / 250g

1. Operation not guaranteed when used with certain types of oils. 2. FT1A-*12RA-* hardware version V130 and earlier is UL, c-UL listed at 0 to +50°C.

Pro/Lite (LCD Model/No LCD Model)		12-I/O Type	24-I/O Type	40-I/O Type	48-I/O Type
Part Number		H12RC / H12RA B12RC / B12RA	H24RC / H24RA B24RC / B24RA	H40RC / H40RKA / H40RSA B40RC / B40RKA / B40RSA	H48KC / H48SC / H48KA / H48SA B48KC / B48SC / B48KA / B48SA
Rated Power Voltage		AC power: 100 to 240V AC, DC power: 24V DC			
Allowable Voltage Range		AC power: 85 to 264V AC, DC power: 20.4 to 28.8V DC (including ripple)			
Rated Power Frequency		AC power: 50 to 60Hz (47 to 63Hz)			
Power Consumption	AC Power	12-I/O: 18VA maximum, 24-I/O: 41VA maximum, 40-I/O: 48VA maximum, 48-I/O: 43VA maximum			
	DC Power	12-I/O: 4.3W maximum, 24-I/O: 4.8W maximum, 40-I/O: 7.9W maximum, 48-I/O: 6.0W maximum			
Allowable Momentary Power Interruption		AC power: 20ms maximum; DC power: 10ms maximum			
Dielectric Strength		AC power type: Between power/input and PE terminals: 1,500V AC, 5mA, 1 minute Between transistor output and PE terminals: 1,500V AC, 5mA, 1 minute Between relay output and PE terminals: 2,300V AC, 5mA, 1 minute Between power and input terminals: 1,500V AC, 5mA, 1 minute Between power/input and transistor output terminals: 1,500V AC, 5mA, 1 minute Between power/input and relay output terminals: 2,300V AC, 5mA, 1 minute DC power type: Between power/input and FE terminals: 500V AC, 5mA, 1 minute Between transistor output and FE terminals: 500V AC, 5mA, 1 minute Between relay output and FE terminals: 2,300V AC, 5mA, 1 minute Between power/input and transistor output terminals: 500V AC, 5mA, 1 minute Between power/input and relay output terminals: 2,300V AC, 5mA, 1 minute			
EMC Immunity		IEC/EN 61131-2:2007 compliant			
Inrush Current		AC power: 35A maximum (Cold start with Ta=25°C, 200V AC), DC power: 30A maximum (5ms maximum)			
Operating Temperature		0 to +55°C ^{Note 1}			
Storage Temperature		-25 to +70°C (no freezing)			
Relative Humidity		10 to 95% RH (no condensation)			
Pollution Degree		2 (IEC 60664-1)			
Corrosion Immunity		Atmosphere free from corrosive gases			
Degree of Protection		IP20 (IEC 60529)			
Ground		D-type ground (Class 3 ground)			
Protective Grounding Conductor		UL1007 AWG16			
Vibration Resistance		5 to 8.4Hz half amplitude 3.5mm, 8.4Hz to 150Hz acceleration 9.8m/s ² (1G), 2 hours per axis on each of three mutually perpendicular axis(IEC 61131-2)			
Shock Resistance		147m/s ² , 11ms, X, Y, Z directions 3 times (IEC 61131-2)			
Mounting Structure		DIN rail or direct mount			
Weight (approx.)	AC Power	12-I/O: 230g, 24-I/O: 400g, 40-I/O: 580g, 48-I/O: 540g			
	DC Power	12-I/O: 190g, 24-I/O: 310g, 40-I/O: 420g, 48-I/O: 380g			

FT1A Version V110 are UL, c-UL Listed at 0 to +50°C.

		Touch (PLC + HMI)			Pro/Lite FT1A (LCD Model/No LCD Model)						
Part Number		FT1A-*12RA-* (Relay)	FT1A-*14KA-* (Sink) FT1A-*14SA-* (Source)	H12RA B12RA	H12RC B12RC	H24RA B24RA	H24RC B24RC	H40RKA H40RSA B40RKA B40RSA	H40RC B40RC	H48KA H48SA B48KA B48SA	H48KC H48SC B48KA B48SC
Control System		Stored program system									
Instruction Words		42 types									
Basic Instructions		98 types / 99 types / 98 types / 103 types / 102 types / 110 types / 104 types / 110 types / 109 types									
Advanced Instructions		98 types / 99 types / 98 types / 103 types / 102 types / 110 types / 104 types / 110 types / 109 types									
Program Capacity		Program size: 47.4KB Configuration memory capacity: 5MB Flash ROM (100,000 times)									
User Program Storage		Built-in Flash ROM (10,000 times rewritable)									
Processing Time		Basic Instruction: 1850µs/1,000 steps END Processing: 5msec minimum									
Function Block ^{Note 1}		37 types / 37 types / 38 types / 37 types / 38 types / 37 types / 45 types / 39 types / 45 types / 44 types									
Function Block Program Capacity		Program size: 38KB Configuration memory capacity: 5MB									
No of Function Blocks		1,000 / 200 / 200 / 200 / 200 / 200 / 200 / 200 / 200 / 200									
Timer (T) / Counter (C)		200 / 200									
Processing Time		Basic Instruction: 4ms/100 END Processing: 5ms minimum									
I/O Points		Inputs / Outputs: 8 / 4 / 8 / 6 / 2 / - / 2 / 2									
Analog Input / Output		8 / 4 / 2 / - / 4 / - / - / 6 / - / - / 8 / - / -									
Internal Relays / Shift Registers		1024 / 128 / 256 / 128 / 1024 / 128									
Data Registers / Special Data Registers		2000 / 200 / 400 / 200 / 2000 / 200									
Adding/Reversible Counters		200 / 100 / 200									
Timer (1ms, 10ms, 100ms, 1s)		200 / 100 / 200									
Clock		Precision: ±30 seconds/month (25°C, typical)									
Backup Data / Backup Duration		Internal relays, shift registers, counters, data registers, clock data / Approximately 30 days (typical) at 25°C after backup battery is fully charged									
Battery / Charging Time		Lithium secondary battery / Approximately 15 hours required to charge from 0 to 90%									
Replaceability		Not possible									
Self-Diagnostic Functions		Keep data check, power failure check, clock error check, watchdog timer check, timer/counter preset value change error check, user program syntax check, user program execution check, system error check, memory cartridge transfer error check (Pro/Lite only)									
Input Filter		No filter, 3 to 15ms (selectable in increments of 1ms)									
Catch Input / Interrupt Input		4 / 4 / 4 / 4 / 6 / 6									
High-speed Counter		Maximum Counting Frequency & Points: Single/two-phase Selectable: 1 (5kHz, multiple 2/4, single phase not available) / Single-phase: 4 (x 10kHz) / Counting Range: 0 to 4,294,967,295 (32 bits) / Operation Mode: Rotary encoder mode and adding counter mode									
Points		2 / 2 / None / 4 / None / 6 / None / 8 / None									
Analog Voltage Inputs		Input Range: 0 to 10V DC / 0 to 10V DC (voltage input) / 4 to 20mA (current input) / 0 to 10V DC / Input Impedance: 78kΩ / 78kΩ (voltage input) / 250Ω (current input) / 78kΩ / Digital Resolution: 0 to 1,000 (10 bits)									
Output Type		10A Relay / Transistor / 10A Relay ^{Note 6} / 10A Relay ^{Note 6} / 10A Relay ^{Note 6} / Transistor									
Analog Output		Built-in Points: - / Output Range: - / 0 to 10V DC (voltage output) / 4 to 20mA (current output) / Digital Resolution: - / 0 to 1,000 (10 bits)									
Pulse Outputs		100 kHz: No. of Outputs: - / Function: - / 5 kHz: No. of Outputs: - / Function: -									
External Output Power Supply for Sensor		Output Voltage: - / Output Current: - / Overload Detection: - / Insulation: -									
USB-mini B ^{Note 3}		X / - / X / - / X / - / X / -									
USB-A ^{Note 3}		X / - / - / - / - / - / - / -									
RS232C ^{Note 3}		X / - / - / - / X ^{Note 4} / X ^{Note 4} / X ^{Note 4} / X ^{Note 4}									
RS485/422 ^{Note 3}		X / - / - / - / X ^{Note 4} / X ^{Note 4} / X ^{Note 4} / X ^{Note 4}									
Ethernet		X / - / - / - / X / X / X / X									
Expansion Communication Ports		Port 2: - / Port 3: -									
Memory Cartridge		- / X / X / - / X / X / X / X									
SD Memory Card		- / - / - / - / X ^{Note 5} / X ^{Note 5} / X ^{Note 5} / X ^{Note 5}									
Analog Cartridge Interface		Number of Ports: - / 4 / - / - / - / - / - / - / - / - / -									
Connectable Cards		- / 2 / - / - / - / - / - / - / - / - / -									

1. Except for timer, counter, input Function Block, and output Function Block. 2. 100kHz when single-phase, 50kHz when two-phase multiple 2.4. 3. Not isolated from internal circuits. 4. When communication cartridge is installed. 5. The maximum capacity is 32 GB. DLOG and TRACE instructions are used to write data. 6. First four outputs are 10A. Remaining are 2A.

Display Specifications

Touch/Pro (PLC + HMI/Built-In LCD)			
Model	Touch		Pro (Built-in LCD)
Display Element	TFT color LCD	STN monochrome LCD	STN monochrome LCD
Colors/Shades	65,536 colors	Monochrome 8 shades	Monochrome
Effective Display Area	88.92 W x 37.05 H mm	87.59 W x 35.49 H mm	47.98 W x 18.22 H mm
Display Resolution	240 W x 100 H pixels		192 W x 64 H pixels
View Angle	Left/right 40°, top 20°, bottom 60°	Left/right/top/bottom: 45°	Left/right 30°, top 20°, bottom 40°
Contrast Adjustment	Not Available	32 levels	Not Available
Backlight	LED	LED (white, red, pink)	LED (green)
Backlight Life	50,000 hours ^{Note 1}		—
Brightness	400cd/m ² ^{Note 2}	740cd/m ² ^{Note 2}	45cd/m ² ^{Note 2}
Brightness Adjustment	32 levels		Not Available
Backlight Control	On/off		
Backlight Replacement	Not Available		
Display Character Size	1/4 Size	8 x 8 pixels (Japanese Katakana, JIS 8-bit code, ISO 8859-1 [Latin 1], ANSI 1250 [Central Europe]), ANSI 1257 (Baltic), ANSI 1251 (Cyrillic)	—
	1/2 Size	8 x 16 pixels (Japanese Katakana, JIS 8-bit code, ISO 8859-1 [Latin 1], ANSI 1250 [Central Europe]), ANSI 1257 (Baltic), ANSI 1251 (Cyrillic)	8 x 16 pixels Japanese Katakana, JIS 8-bit code, ISO 8859-1 (Latin 1), ANSI 1251 (Cyrillic)
		16 x 32 pixels, 24 x 48 pixels, 32 x 64 pixels (Western European languages: ISO 8859-1)	—
	Full Size	16 x 16 pixels (Japanese JIS first and second level characters, simplified Chinese, traditional Chinese, Korean)	16 x 16 pixels (Japanese JIS first level characters, Chinese)
	Double Size	32 x 32 pixels (Japanese JIS first level characters, Mincho font)	—
No. of Characters	1/4 Size	30 characters x 12 lines/screen	—
	1/2 Size	30 characters x 6 lines/screen	24 characters x 4 lines
	Full Size	15 characters x 6 lines/screen	12 characters x 4 lines
	Double Size	7 characters x 3 lines/screen	—
Character Magnification	0.5x, 1x, 2x, 3x, 4x, 5x, 6x, 7x, 8x, vertically and horizontally		—
Character Attributes	Blink, reverse, bold, shadowed (blink is 1 or 0.5sec)		Blink, reverse
Graphics	Line, polyline, polygon, rectangle, circle, ellipse, arc, pie, equilateral polygons (3, 4, 5, 6, 8), fill, picture		—
Window Display	3 pop-up screens + 1 system screen		—

1. The backlight life refers to the time until the brightness reduces by half after use at 25°C.

2. Brightness of LCD only (monochrome LCD: when lit white).

Operation Specifications

Touch/Pro (PLC + HMI/LCD Models)		
Model	Touch	Pro (Built-in LCD)
Switching Element	Analog resistive membrane (touch panel)	Rubber switches
Operating Force	0.2 to 2.5N	2.0N minimum
Mechanical Life	1 million operations	10,000 operations
Acknowledgment Sound	Electric Buzzer	Not provided
Multiple Press	Not possible	Possible

Analog Cartridge Specifications (Touch Transistor Output Model)

Part No.	FC6A-PJ2A	FC6A-PJ2CP	FC6A-PK2AV	FC6A-PK2AW
Type	Voltage/Current Input	Temperature Input	Voltage Output	Current Output
Rated Voltage	5.0V, 3.3V (supplied from the Touch)			
Consumption Current	5.0V: — 3.3V: 30mA		5.0V: 70mA 3.3V: 30mA	5.0V: 185mA 3.3V: 30mA
Weight	15g			

800.262.4332

www.IDEC.com/FT1A

Input Specifications

Part No.	FC6A-PJ2A		FC6A-PJ2CP		
Input Type	Voltage Input	Current Input	Resistance Thermometer	Thermocouple	
Input Range	0 to 10V DC	4 to 20mA DC 0 to 20mA DC	Pt100: -200 to +850°C Pt1000: -200 to +600°C Ni100: -60 to +180°C Ni1000: -60 to +180°C 3-wire RTD	K: -200 to 1300°C J: -200 to 1000°C R: 0 to 1760°C S: 0 to 1760°C B: 0 to 1820°C E: -200 to 800°C T: -200 to 1300°C C: 0 to 2315°C	
Input Impedance	1MΩ min.	250Ω max.	1MΩ min.		
Allowable Conductor Resistance	—		10Ω max		
Input Detection Current	—		Typ: 0.2mA, 1.0mA max.		
A/D Conversion	Sample Duration Time	10ms	250ms		
	Sample Interval	20ms	500ms		
	Total Input System Transfer Time	20ms + 1 scan		500ms + 1 scan	
	Type of Input	Single-ended input			
	Operating Mode	Self-Scan			
	Conversion Method	SAR			
	Maximum Error at 25°C	±0.1% of full scale	±0.1% of full scale	±0.1% of full scale Cold junction compensation accuracy ±4.0°C or less. Exceptions R, S thermocouple error: ±6.0°C (0 to 200°C range only) B thermocouple error: Not guaranteed (0 to 300°C range only) K, J, E, T, N thermocouple error: ±0.4% of full scale (0°C or lower range only)	
Temperature Coefficient	±0.02%/°C of full scale				
Reproducibility After Stabilization Time	±0.5% of full scale				
Non-linearity	±0.01% of full scale				
Maximum Error	±1.0% of full scale				
Data	Digital Resolution	4096 increments (12 bit)		Pt100: 10,500 (14bit) Pt1000: 8000 (13 bit) Ni100: 2400 (12 bit) Ni1000: 2400 (12bit)	
	LSB Input Value	2.44mV (0 to 10V DC)	4.88μA (DC0 to 20mA) 3.91μA (DC4 to 20mA)	0.1°C 0.18°F	
	Data Format in Application	Can be arbitrarily set for each channel in the range of -32,768 to 32,773			
	Monotonicity	Yes			
Noise Resistance	Maximum Temporary Deviation During Electrical Noise Tests	±4.0% full scale max.			
	Recommended Cable	Shielded twisted pair			
	Crosstalk	1LSB max.			
Isolation	None				
Effect When Input is Incorrectly Wired	No damage				
Maximum Allowable Constant Load (non-destructive)	13V DC	40mA	13V DC		
Input Type Modification	Software programming				
Calibration to Maintain Rated Accuracy	Impossible				

Output Specifications

Part No.	PC6A-PK2AV	FC6A-PK2AW	
Type	Voltage Output	Current Output	
Output Type	Voltage Output	0 to 10V DC	
Output Type	Current Output	—	
Output Type	Current Output	4 to 20mA DC	
Load	Impedance	2kΩ min.	
Load	Impedance	500kΩ max.	
D/A Conversion	Load Type	Resistance Load	
	Cycle Time	20ms	
	Settling Time	40ms max.	20ms max.
Total Output System Transfer Time	60ms+1 scan	40ms+1 scan	
Output Error	Maximum Error at 25°C	±0.3% of full scale	
	Temperature Coefficient	±0.02%/°C of full scale	
	Reproducibility after Stabilization Time	±0.4% of full scale	
	Non-linearity	±0.01% of full scale	
	Output Ripple	30mV max.	
	Overshoot	0%	
	Maximum Error	±1.0% of full scale	
Effect of Improper Output Terminal Connection	No damage		
Data	Digital Resolution	4096 increments (12 bits)	
	LSB Output Value	2.44mV (0 to 10V)	3.91μA (4 to 20mA)
	Data Format in Application	0 to 4095 (0 to 10V)	
	Monotonicity	Yes	
Noise Resistance	Open Current Loop	—	Cannot be detected
	Maximum Temporary Deviation During Electrical Noise Tests	±4.0 full scale max.	
	Recommended Cable	Shielded twisted pair	
Crosstalk	1 LSB max.		
Isolation	None		
Calibration to Maintain Rated Accuracy	Impossible		
Selection of Output Signal Type	Voltage output only	Current output only	

Applicable Wire

Cartridge Part No.	FC6A-PJ2A	FC6A-PJ2CP	FC6A-PK2AV	FC6A-PK2AW
Applicable Wire	0.3mm ² (AWG22) shielded twisted pair	0.3mm ² (AWG22) cable	0.3mm ² (AWG22) shielded twisted pair	

Get Intensive Hands-on PLC and HMI Training

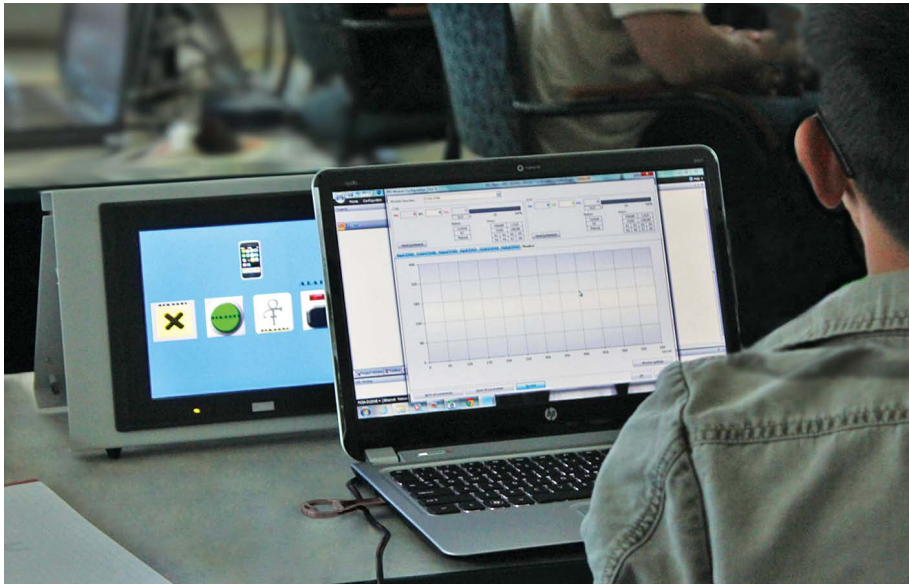

Looking to improve your knowledge of PLCs and HMIs? IDEC's training course combine hands-on instruction and real-world examples. Some of the covered topics include:

- Start/stop and latching circuits
- Timers and counters
- Modbus/TCP communications
- Email/Text and web page setup
- PID configuration
- Pushbuttons, pilot lights
- Data displays and data inputs
- Graphics and animation
- Alarms and passwords
- Remote control and monitor

The training course covers programming for SmartAXIS and MicroSmart Pentra PLCs, SmartAXIS Touch (HMI+PLC) and HG series HMIs and includes Q&A sessions with our experts to discuss your specific application.

Choose from five kits featuring introductory-level products all the way up to our most advanced HMIs and PLCs! For detailed information, our current schedule and to sign up for a class, visit <http://training.IDEC.com>.

In-class Training Kits



PLC/HMI Training Kit



SmartAXIS Training Kit

www.IDEC.com

USA

IDEC Corporation
Tel: (408) 747-0550
opencontact@IDEC.com

Australia

IDEC Australia Pty. Ltd.
Tel: +61-3-8523-5900
sales@au.IDEC.com

Canada

IDEC Canada Ltd.
Tel: (905) 890-8561
sales@ca.IDEC.com

Japan

IDEC Corporation
Tel: +81-6-6398-2571
marketing@IDEC.co.jp

China

IDEC (Beijing) Corporation
Tel: +86-10-6581-6131

IDEC (Shanghai) Corporation
Tel: +86-21-6135-1515
idec@cn.IDEC.com

IDEC (Shenzhen) Corporation
Tel: +86-755-8356-2977

Germany

IDEC Elektrotechnik GmbH
Tel: +49-40-253054-0
service@IDEC.de

Hong Kong

IDEC (H.K.) Co., Ltd.
Tel: +852-2803-8989
info@hk.IDEC.com

Singapore

IDEC Asia Pte. Ltd.
Tel: +65-6746-1155
info@sg.IDEC.com

Taiwan

IDEC Taiwan Corporation
Tel: +886-2-2698-3929
service@tw.IDEC.com

Thailand

IDEC Asia (Thailand) Co., Ltd.
Tel: +662-392-9765
sales@th.IDEC.com

United Kingdom

IDEC Electronics Ltd.
Tel: +44-1256-321000
sales@uk.IDEC.com