

SIEMENS

SINUMERIK 840C **Software Version 1 to 6**

Planning Guide

09.2001 Edition

Interface Description **Part 2: Connection Conditions**

SINUMERIK 840C

Software Version 1, 2, 3, 4, 5 and 6

Interface Description

Part 2: Connection Conditions

Planning Guide

Applies to:

Control

SINUMERIK 840C/CE
(Standard/Export Version)

Software Version

1, 2, 3, 4, 5 and 6

09.2001 Edition

Printing history

Brief details of this edition and previous editions are listed below.

The status of each edition is shown by the code in the "Remarks" column.

Status code in "Remarks" column:

A ... New documentation.

B ... Unrevised reprint with new Order No.

C ... Revised edition with new status.

If factual changes have been made on the page since the last edition, this is indicated by a new edition coding in the header on that page.

Edition	Order No.	Remarks
11.92	6FC5 197-0AA10-1BP0	A
06.93	6FC5 197-2AA10-0BP0	C
12.93	6FC5 197-3AA10-0BP0	C
06.94	6FC5 197-3AA10-0BP1	C
03.95	6FC5 197-4AA10-0BP0	C
02.96	6FC5 197-5AA10-0BP0	C
01.97	6FC5 197-5AA10-0BP2	C
03.98	6FC5 197-6AA10-0BP0	C
01.99	6FC5 197-6AA10-0BP1	C
07.99	6FC5 197-6AA10-0BP2	C
09.01	6FC5 197-6AA10-0BP3	C

This manual is included in the documentation on CD-ROM (**DOCONCD**)

Edition	Order No.	Remarks
10.01	6FC5198-6CA00-0BG2	C

Trademarks

SIMATIC®, SIMATIC HMI®, SIMATIC NET®, SIROTEC®, SINUMERIK® and SIMODRIVE® are trademarks of Siemens AG. All other product and system names are registered trademarks of their respective companies and must be treated accordingly.

You will find further information in the Internet under:
<http://www.ad.siemens.de/sinumerik>

This publication was produced on the Siemens 5800 Office System .

The reproduction, transmission or use of this document or its contents is not permitted without express written authority. Offenders will be liable for damages. All rights, including rights created by patent grant or registration of a utility model or design, are reserved.

© Siemens AG 1992-2001
All Rights Reserved

Other functions not described in this documentation might be executable in the control. This does not, however, represent an obligation to supply such functions with a new control or when servicing.

We have checked that the contents of this publication agree with the hardware and software described herein. The information given in this publication is reviewed at regular intervals and any corrections that might be necessary are made in the subsequent printings. Suggestions for improvement are welcome at all times.

Subject to change without prior notice.

Preliminary Remarks

Instructions to the reader

The documentation is intended for manufacturers of machine tools using SINUMERIK 840C. It describes the installation arrangements and wiring between the control and the machine, as well as the signals between the PLC and the machine.

The SINUMERIK documentation comprises four parts:

- General documentation
- User documentation
- Manufacturer documentation and
- Service documentation

The **Manufacturer Documentation** for the **SINUMERIK 840C** control is divided into the following sections:

- Planning Guides
 - Interface Part 1: Signals
 - Interface Part 2: Connection Conditions
- Planning Guide PLC 135 WB/WB2/WD
- Function Macros
- Function Block Packages
 - Package 0 : Basic Functions
 - Package 1 : Tool Management
 - Package 4/5: Computer Link
 - Package 7 : Code Carriers
 - Package 8 : PLC Controlled Data Input, Output

In addition, there are SINUMERIK publications applying to all SINUMERIK controls (e.g. Universal Interface, Measuring Cycles, CL800 Cycle Language).

Please contact your Siemens regional office for further details.

Technical Notes

Having switched the control off, you must wait at least 5 seconds before switching it on again!

- When signal charts are shown, thick lines represent interface signals and thin lines mean symbolic signal parts or internal messages.
- Signals marked with an * in front of the signal name are so-called inverse signals, i.e. they are not effective at 1 signal but at 0 signal (e.g. *TEMPERATURE ERROR).

In the following Sections you will come across order numbers with a for inserting a number if several versions of a component are available. The complete order number is listed in Section 2, Subsection Hardware overview with order numbers.

This documentation is valid for software versions 1, 2, 3, 4, 5 and 6!

Safety guidelines

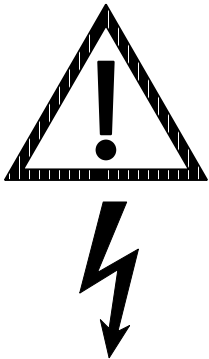
	WARNING
	<p>When electrical devices are in operation, certain parts of them are inevitably subjected to hazardous voltages.</p> <p>Improper interference with the device/system or failure to observe the warning advice can result in serious physical injury or material damage. Only appropriately trained personnel familiar with the assembly, installation, starting up or operation of the product are permitted to interfere with this device/system.</p>

Qualified personnel

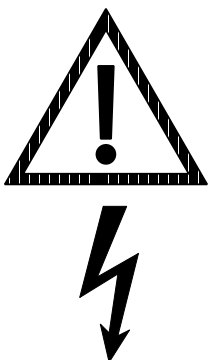
	WARNING
	<p>As far as the safety advice (contained in the documentation or as a sticker on the product) is concerned, "qualified personnel" refers to persons who, for instance:</p> <ul style="list-style-type: none">• have received training or instruction and authorization to energize and deenergize, earth and tag electric circuits and devices according to established safety practices.• have received training or instruction according to established safety practices in the care, use and repair of appropriate safety equipment.• have received training or instruction in working with electrostatically sensitive components or modules.• have been instructed as operators to work with automation technology equipment and are familiar with the contents in the Operator's and/or Programming Guide referring to operation.

When planning, installing, starting up, operating and repairing the control, the personnel concerned must be familiar with the documentation relevant to their jobs.

Notes on danger

The following notes are provided for your personal safety and to protect the product described here or connected devices and machines against damage.

Safety advice and warnings intended to avert danger to human life and health and to avoid material damage are highlighted in the Manual by the terms defined here. The terms have the following meanings in the context of this Manual and the remarks on the product itself:

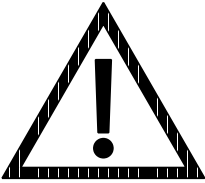
	DANGER
	As far as this Manual and the warning advice on the products themselves are concerned, "danger" refers to instances where death, serious physical injury or considerable material damage will result if proper precautions are not taken.

	WARNING
	As far as this Manual and the warning advice on the products themselves are concerned, "warning" refers to instances where death, serious physical injury or considerable material damage can result if proper precautions are not taken.

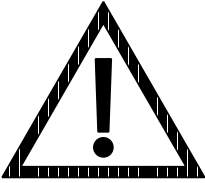
	CAUTION
	As far as this Manual and the warning advice on the products themselves are concerned, "caution" refers to instances where slight physical injury or material damage can result if proper precautions are not taken.

	CAUTION
	This warning notice (without warning triangle) means that a material damage can result if the appropriate precautions are not taken.

	NOTICE
	This warning notice means that an undesired event or an undesired state can result if the appropriate notices are not observed.

"Note" refers to important items of information about the product or the part of the Manual to which particular attention must be paid.

Intended use

- The device/system and system components must be used only for the applications envisaged in the Catalog and Reference Manual and only in conjunction with such non-Siemens devices and components as have been recommended and approved by Siemens.
- The product described in the Manual has been developed, manufactured, tested and documented in compliance with the relevant safety standards. Provided that the handling instructions and safety guidelines described for planning, assembling, proper operation and maintenance are observed, the product will not normally be a source of danger as regards material damage or physical injury.

Active and passive faults in automation equipment

- Depending on the particular task for which the electronic automation equipment is used, both active and passive faults can represent dangerous faults. In the case of a drive control, for example, active faults are generally dangerous because they lead to unauthorized startup of the drive. On the other hand, a passive fault can result in a dangerous operating state not being reported to the operator.
- This differentiation between possible faults and their task-related classification as dangerous and non-dangerous faults is important for all the safety considerations in respect of the product supplied.

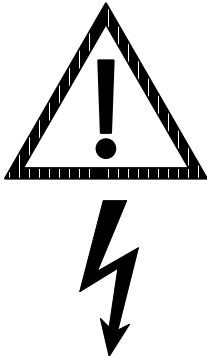
	WARNING
	Wherever a fault in the automation equipment can cause serious material damage or even physical injury, in other words wherever dangerous faults can occur, additional external precautions must be taken or devices provided which will ensure or enforce safe operating conditions even in the event of a fault (e.g. by means of independent limit switches, mechanical interlocks etc.).

Notes on product planning

As the product is generally part of larger systems or plants, these notes are intended as a guideline for safe integration of the product in its environment.

Note the following in particular:

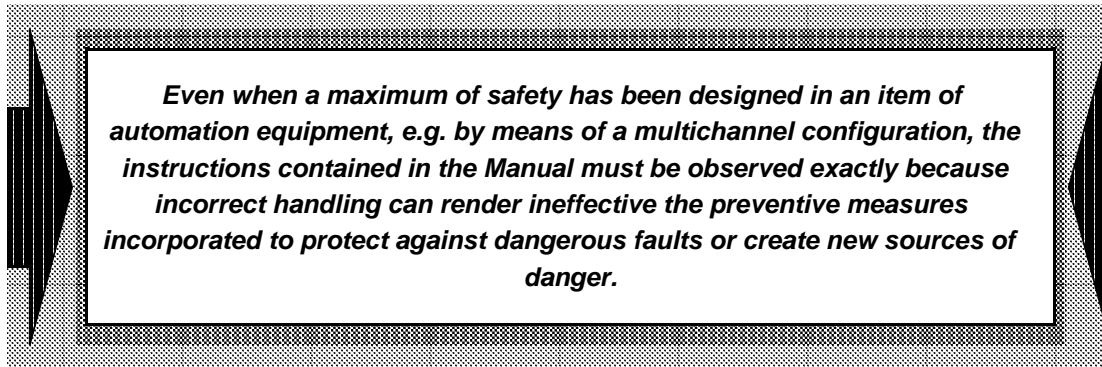

Additional notes

If measuring or testing work is required on an active piece of equipment, the stipulations and implementation instructions of the VBG 4.0 accident prevention regulation, in particular § 8 "Permissible departures when working on active parts", must be observed. Suitable electrical tools must be used.

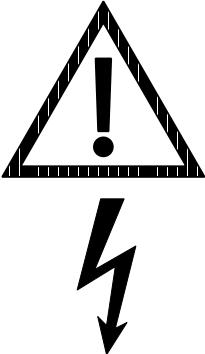
	WARNING
	<ul style="list-style-type: none">• Repairs to equipment supplied by us must be made only by the Siemens customer service or by repair services authorized by Siemens. Use only parts contained in the Spare Parts List when renewing parts or components. Unauthorized opening and improper repairs can lead to fatal or serious physical injury and considerable material damage.• Always pull out the mains connector or open the disconnecting switch before opening the device. Check that the device is not connected to the power supply and ensure that it cannot be switched on.• Use only the specified types when renewing fuses.• Do not throw batteries into fires and do not solder on the cell casing owing to the risk of explosion (max. temperature 100°C). Do not open and do not recharge lithium batteries or batteries containing mercury. Use only the same types when replacing.• All types of batteries must be disposed of as special waste.• When using monitors: Improper intervention, in particular changes to the high voltage or installation of a different type of picture tube, can lead to intensified X-rays. Equipment modified in this way no longer complies with the approval and must not be used.• Dismounted backlight tubes are to be disposed of according to national regulations which also apply to fluorescent tubes.

In the following Sections you will come across order numbers with a for inserting a number if several versions of a component are available. The complete order number is listed in Section 2.2.

System Configuration	1
Connections	2
Connection Conditions	3
Distributed Machine Peripherals (DMP)	4
External Devices and Accessories	5
Cables and Connectors	6
Terms and Abbreviations	7
EC Declaration of Conformity	A

Contents

	Page
1 System Configuration	1-1
1.1 SINUMERIK 840C system configuration with 14" color screen	1-1
1.2 SINUMERIK 840C system configuration with 9.5"/10" color/monochrome slimline operator panel	1-2
1.3 Connection diagram for SINUMERIK 840C with 14" color screen	1-3
1.4 Connection diagram for SINUMERIK 840C with 14" color screen and pushbutton module	1-4
1.5 Connection diagram for SINUMERIK 840C with slimline operator panel (version from 02.95)	1-5
1.6 Connection diagram for SINUMERIK 840C with 9.5" slimline operator panel and pushbutton module	1-6
1.7 Central controller interfaces	1-7
1.8 SINUMERIK 840C peripherals	1-8
2 Connections	2-1
2.1 Hardware overview with order numbers	2-1
2.2 Operator unit components 6FC5 103-0AB 1-0AA	2-12
2.2.1 14" color screen	2-12
2.2.1.1 Configuration	2-12
2.2.1.2 Location of interfaces and operator control and display elements	2-13
2.2.2 19" operator panel with 10.4" display (replacement part for operator panel with 14" screen)	2-15
2.2.2.1 Location of interfaces, operator control and display elements	2-16
2.2.3 NC keyboard 6FC5 103-0AC -0AA	2-22
2.2.3.1 Structure	2-22
2.2.3.2 Location of interfaces and operator control and display elements	2-23
2.2.4 Slimline operator panel	2-24
2.2.4.1 10" color/monochrome display 6FC5 103-0AB -0AA0	2-24
2.2.4.1.1 Configuration	2-24
2.2.4.1.2 Location of interfaces and operator control and display elements	2-26
2.2.4.1.3 Replacing the backlight	2-30
2.2.4.2 9.5" color/monochrome display 6FC5 103-0AB - AA	2-33
2.2.4.2.1 Configuration	2-33
2.2.4.2.2 Position of the interfaces, operator control and display elements	2-35
2.2.4.2.3 Adjustment with test pattern	2-41
2.2.4.2.4 Replacing the display	2-44
2.2.4.2.5 Replacing the backlight	2-47
2.2.4.3 10.4" color display (as from SW 6) 6FC5 103-0AB 3- AA3	2-48
2.2.4.3.1 Configuration	2-48
2.2.4.3.2 Location of interfaces, operator controls and display elements	2-49
2.2.4.3.3 Settings/adjustments	2-53

2.2.4.3.4	Replacing the display	2-58
2.2.4.3.5	Backlight für 10.4" color display 6FC5147-0AA00-0AA1	2-60
2.2.5	Machine control panel	2-62
2.2.5.1	Configuration	2-62
2.2.5.2	Operator control elements of the machine control panel	2-63
2.2.5.3	Location of the interfaces and the operator control and display elements	2-70
2.2.6	Keyboard interface	2-71
2.2.6.1	Configuration 230 V AC (old)	2-71
2.2.6.2	Configuration 230 V AC (new) 6FC5 103-0AE01-0AA1 24 V DC (new) 6FC5 103-0AE01-1AA1	2-75
2.2.6.3	Description of interfaces X211 and X221	2-79
2.2.7	Cable sets 1, 2 and 3	2-81
2.2.8	Configuring the machine control panel	2-82
2.2.8.1	Processing of machine control panel signals	2-83
2.2.8.2	Input/output assignment of machine control panel	2-85
2.2.9	The pushbutton module 6FX2 006-0AB00	2-97
2.2.9.1	Configuration and functionality	2-97
2.2.9.2	Position of the interfaces	2-98
2.2.9.3	Hardware interface	2-99
2.2.10	Voltage converter module UTS 840C	2-104
2.2.10.1	Connection overview	2-104
2.2.10.2	Hardware interface	2-105
2.2.10.3	Software interface	2-108
2.2.11	Interface changeover switch	2-111
2.2.11.1	Interface changeover switch, old version	2-111
2.2.11.2	Interface changeover switch, new version	2-114
2.2.11.3	Connection of one operator panel of one color monitor to several NC controls	2-117
2.2.11.4	Connection of several operator panels/color monitors to an NC control	2-118
2.2.12	Floppy drive FD-E2	2-120
2.3	Central controller	2-122
2.3.1	Configuration	2-122
2.3.1.1	Fan unit 6FC5 147-0AA07-0AA0 Amplified fan unit 6FC5 147-0AA07-0AA1	2-125
2.3.2	Subrack assignment	2-126
2.3.2.1	Subrack assignment central controller 1, 12 slots	2-126
2.3.2.2	Subrack assignment central controller 2, 18 slots	2-127
2.3.2.3	Subrack assignment central controller 3, 18 + 3 AT slots	2-128
2.3.3	CPU modules	2-129
2.3.3.1	NC CPU 386DX 6FC5 110-0BA01-1AA0	2-129
2.3.3.1.1	EPROM submodule (SW version 1 only)	2-131
2.3.3.2	NC CPU 486DX	2-132
2.3.3.3	NC CPU 486 DX VB (from 08.94) 6FC5 110-0BB0 -0AA	2-134
2.3.3.4	PLC CPU 135 WB2	2-136
2.3.3.4.1	EPROM submodule 256 Kbytes	2-138
2.3.3.5	PLC CPU 135 WD	2-139
2.3.3.6	MMC CPU 386SX 6FC5 110-0DA0 -0AA0	2-142
2.3.3.7	MMC CPU 486 SX/DX (SW 2 and higher)	2-145

2.3.4	I/O modules	2-148
2.3.4.1	ANALOG measuring circuit module without/with EXEs 6FC5 111-0BA0 -0AA0	2-148
2.3.4.1.1	EXE 5/10-fold	2-154
2.3.4.2	HMS measuring circuit module	2-155
2.3.4.2.1	SERVO COMMAND submodule	2-160
2.3.4.2.2	SIPOS absolute encoder submodule	2-161
2.3.4.2.3	I/V hybrid	2-162
2.3.4.3	IN ANALOG I/O module	2-163
2.3.4.4	MIXED I/O module 6FC5 111-0CB02-0AA0	2-170
2.3.5	Interfaces	2-177
2.3.5.1	PLC interface	2-177
2.3.5.2	DMP interface	2-180
2.3.5.3	EU interface, 16 bit	2-183
2.3.5.4	PROFIBUS DP interface	2-184
2.3.5.5	Adapter kit for IM308C (as from SW 6)	2-185
2.3.5.6	Bus interface SINEC CP 231A	2-187
2.3.5.6.1	System software submodule for CP 231 6FC5 154-0AX01-1AE0 System software submodule for CP 315	2-189
2.3.5.7	CP 315 – ACTIVE V.24 module	2-190
2.3.5.8	CP 315/CP 373 – ACTIVE V.24 module with submodule	2-192
2.3.5.9	SINEC CP 1476 (MAP 3.0)	2-193
2.3.5.10	MMC interface	2-194
2.3.6	Monitoring module and power supply	2-197
2.3.6.1	CENTRAL SERVICE BOARD (old CSB)	2-197
2.3.6.2	CENTRAL SERVICE BOARD (new CSB)	2-203
2.3.6.3	Cable distributor	2-207
2.3.6.4	Power supply of central controller	2-214
2.3.7	Blanking plates	2-215
2.3.8	AT rack expansion on central controller 3	2-216
3	Connection Conditions	3-1
3.1	Technical data	3-1
3.1.1	Climatic environmental conditions	3-1
3.1.1.1	Installation and operation	3-2
3.1.1.2	Transportation and storage	3-2
3.1.2	Exposure to contaminants	3-4
3.1.2.1	Hazardous gases	3-4
3.1.2.2	Hazardous dust	3-5
3.1.3	Electromagnetic compatibility (EMC)	3-5
3.1.3.1	Interference suppression	3-5
3.1.3.2	Immunity to noise	3-5
3.1.4	Miscellaneous	3-6
3.1.4.1	Colors	3-6
3.1.4.2	Data protection, stored energy times	3-6
3.2	Technical data of the individual components	3-7
3.2.1	Mechanical data and temperature ranges of the individual components	3-7

3.2.2	Electrical data of the individual components	3-10
3.2.2.1	Requirements for power supply	3-11
3.2.2.2	Connected load and power loss calculation	3-13
3.2.3	Standards	3-16
3.3	Mechanical installation	3-18
3.3.1	Operator panel with 14" color screen	3-18
3.3.1.1	Dimension drawings	3-18
3.3.1.2	Panel cutout	3-20
3.3.1.3	Installation notes	3-22
3.3.1.4	Heat removal	3-23
3.3.2	19" operator panel with 10.4" display (spare part for operator panel with 14" screen)	3-25
3.3.2.1	Dimension drawings	3-25
3.3.3	9.5",10" and 10.4" color/monochrome slimline operator panel	3-28
3.3.3.1	Dimension drawings	3-28
3.3.3.2	Panel cutout (9.5", 10", 10.4")	3-32
3.3.3.3	Installation notes	3-33
3.3.3.4	Heat removal	3-35
3.3.4	NC keyboard	3-37
3.3.4.1	Dimension drawings	3-37
3.3.4.2	Panel cutout	3-38
3.3.5	Machine control panel	3-39
3.3.5.1	Dimension drawings	3-39
3.3.5.2	Panel cutout	3-40
3.3.6	Voltage converter module UTS 840C	3-40
3.3.7	Central controller	3-41
3.3.7.1	Dimension drawings	3-41
3.3.7.2	Heat removal	3-47
3.3.8	Floppy drive FD-E2	3-48
3.3.8.1	Dimension drawings	3-48
3.3.8.2	Panel cutout	3-49
3.3.9	Cable strain relief and shielding on CPU modules	3-50
3.4	Electrical installation	3-51
3.4.1	Installation codes of practice	3-51
3.4.1.1	Installation of equipotential bonding conductors	3-52
3.4.1.2	Laying signal and power lines	3-55
3.4.1.3	Potential connection with external 24 V power supply	3-56
3.4.1.4	Potential connection with 230 V AC power supply	3-56
3.4.2	Shock hazard protection	3-56
3.5	Maintenance and servicing	3-56
3.5.1	Electrostatically sensitive devices (ESD)	3-56
3.5.2	Handling the modules	3-57
3.5.3	Cleaning	3-58
3.5.4	Replacing batteries	3-58
3.5.5	Recommendations for hard disks	3-59
3.6	Disposing of components	3-64

4	Distributed Machine Peripherals (DMP)	4-1
4.1	General	4-1
4.2	Examples of application	4-2
4.3	DMP terminator	4-6
4.4	DMP terminal block and DMP modules	4-7
4.4.1	DMP terminal block	4-7
4.4.2	DMP module 16 I/16 O	4-8
4.4.3	DMP module 32 I	4-11
4.5	DMP compact terminal block and DMP compact modules	4-13
4.5.1	DMP compact terminal block	4-13
4.5.2	DMP compact module 8 O	4-15
4.5.3	DMP compact module 16 O	4-17
4.5.4	DMP compact module 16 I	4-19
4.5.5	DMP compact module ANALOG OUT	4-20
4.5.6	DMP compact module ANALOG IN	4-22
4.6	DMP terminal block with DMP module 6FC5 111-0CA72-0AA0 in IP 65 design	4-26
4.7	Machine control panel as DMP station	4-31
4.8	Handheld unit and distribution box	4-31
4.8.1	Handheld unit with casing	4-32
4.8.1.1	Distribution box for handheld unit	4-39
4.8.2	Handheld unit for mounting without housing	4-41
4.8.3	A-MPC handheld unit with casing	4-43
4.8.3.1	Distribution box for handheld unit 6FX2 006-1BC0	4-53
4.8.4	Earthing concept for distributed machine peripherals	4-55
5	External Devices and Accessories	5-1
5.1	Devices and accessories	5-1
5.2	Electronic handwheels	5-3
5.2.1	Electronic handwheel, large	5-3
5.2.2	Electronic handwheel, small	5-4
5.2.3	Electronic handwheel with housing 6FC9 320-5DE00	5-5
5.3	3.5" FD-E1 built-in floppy drive	5-6
5.4	Spring disk coupling with clamp	5-7
5.5	INDUCTOSYN converter 6FC9 320-3GK INDUCTOSYN pre-amplifier 6FC9 320-4FC	5-8
5.5.1	Wiring	5-8
5.5.2	Dimension drawings	5-10

5.6	Terminal strip converter, 37-pin, for input module and mixed input/output module (with LEDs) 6FC9 302-2BD01	5-11
5.7	400 V AC power supply units	5-12
5.8	Standard PC keyboard (MF-II)	5-13
5.9	Streamers	5-15
5.9.1	VALITEK PST 160 streamer 6FC9 310-1NB00	5-15
5.9.2	VALITEK PST 2-M1200 streamer 6FX2 007-2AA00	5-15
5.10	Encoders	5-16
5.10.1	High-resolution rotary encoder for rotary axes	5-16
5.10.2	Incremental rotary encoder and main spindle encoder	5-17
5.10.3	Combined rotary encoder for spindle and C axis 6FC9 320-3KT00	5-18
5.10.4	SIPOS encoders	5-19
6	Cables and Connectors	6-1
6.1	Tabular overview of cables	6-1
6.2	Tabular overview of connectors	6-5
6.3	Cable diagrams and connector assignment	6-6
6.4	Description of cables and connectors	6-39
7	Terms and Abbreviations	7-1
A	EC Declaration of Conformity	A-1

1 System Configuration

1.1 SINUMERIK 840C system configuration with 14" color screen

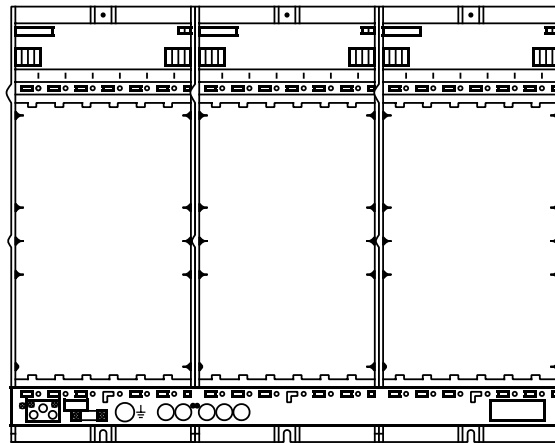
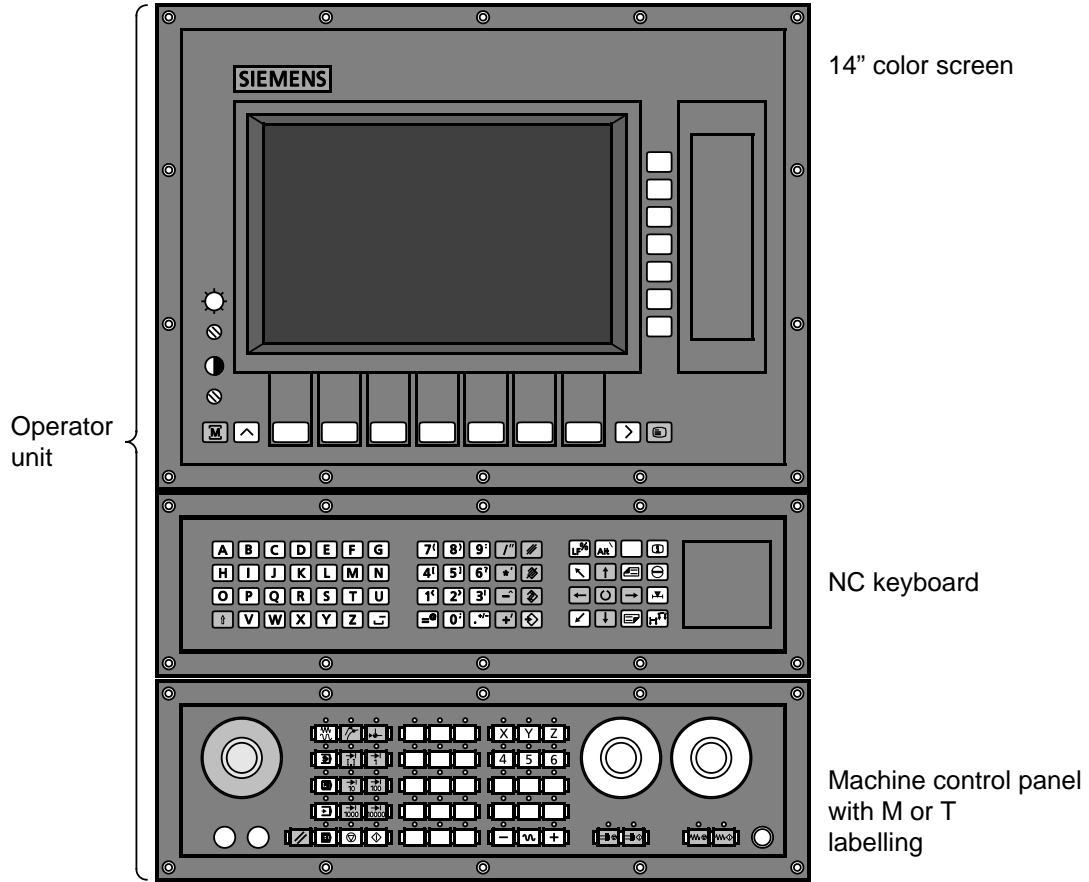

Subrack – central controller, not equipped, with 12 or 18 slots (see left) or 18+3 AT slots (SW 3 and higher)

1.2 SINUMERIK 840C system configuration with 9.5"/10"/10.4" color/monochrome slimline operator panel

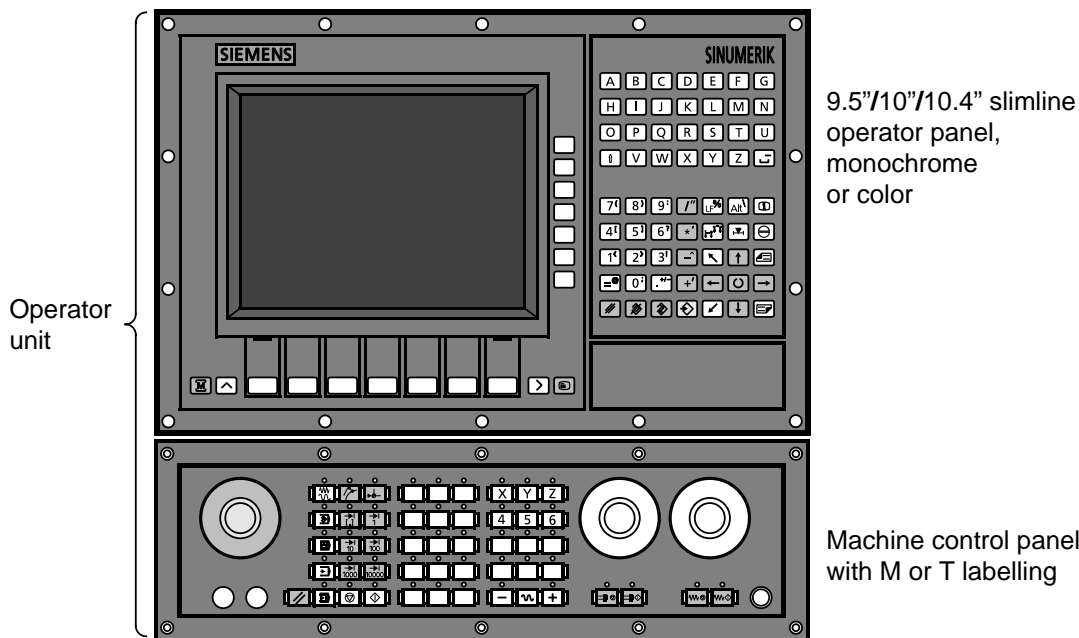

9.5"/10"/10.4" slimline operator panel, monochrome or color

Machine control panel, with M or T labelling

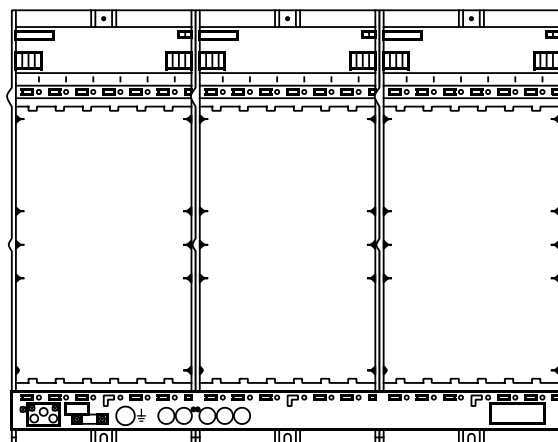

Subrack – central controller, not equipped, with 12 or 18 slots (see left) or 18+3 AT slots (SW 3 and higher)

1.3 Connection diagram for SINUMERIK 840C with 14" color screen

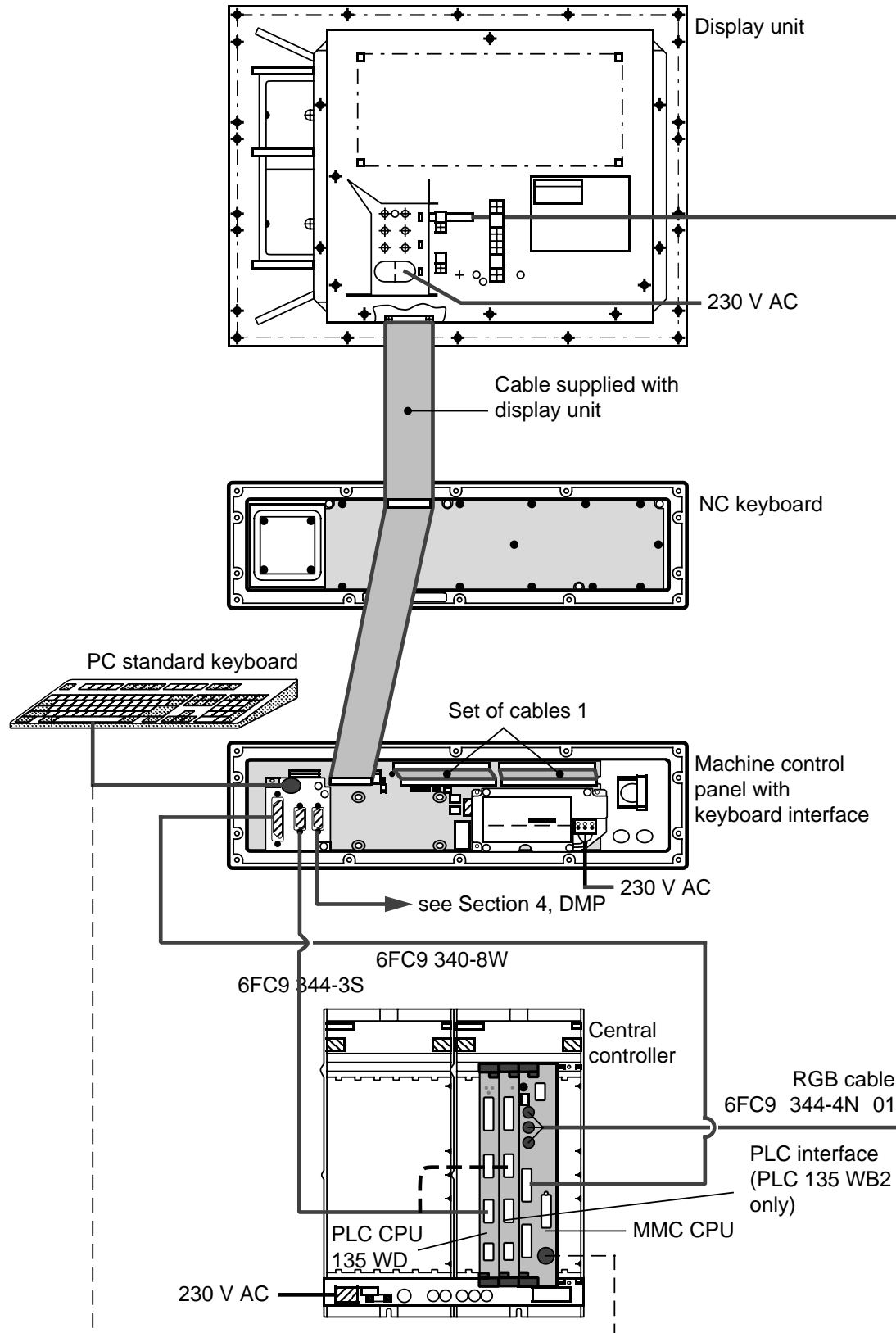

1.4 Connection diagram for SINUMERIK 840C with 14" color screen and pushbutton module

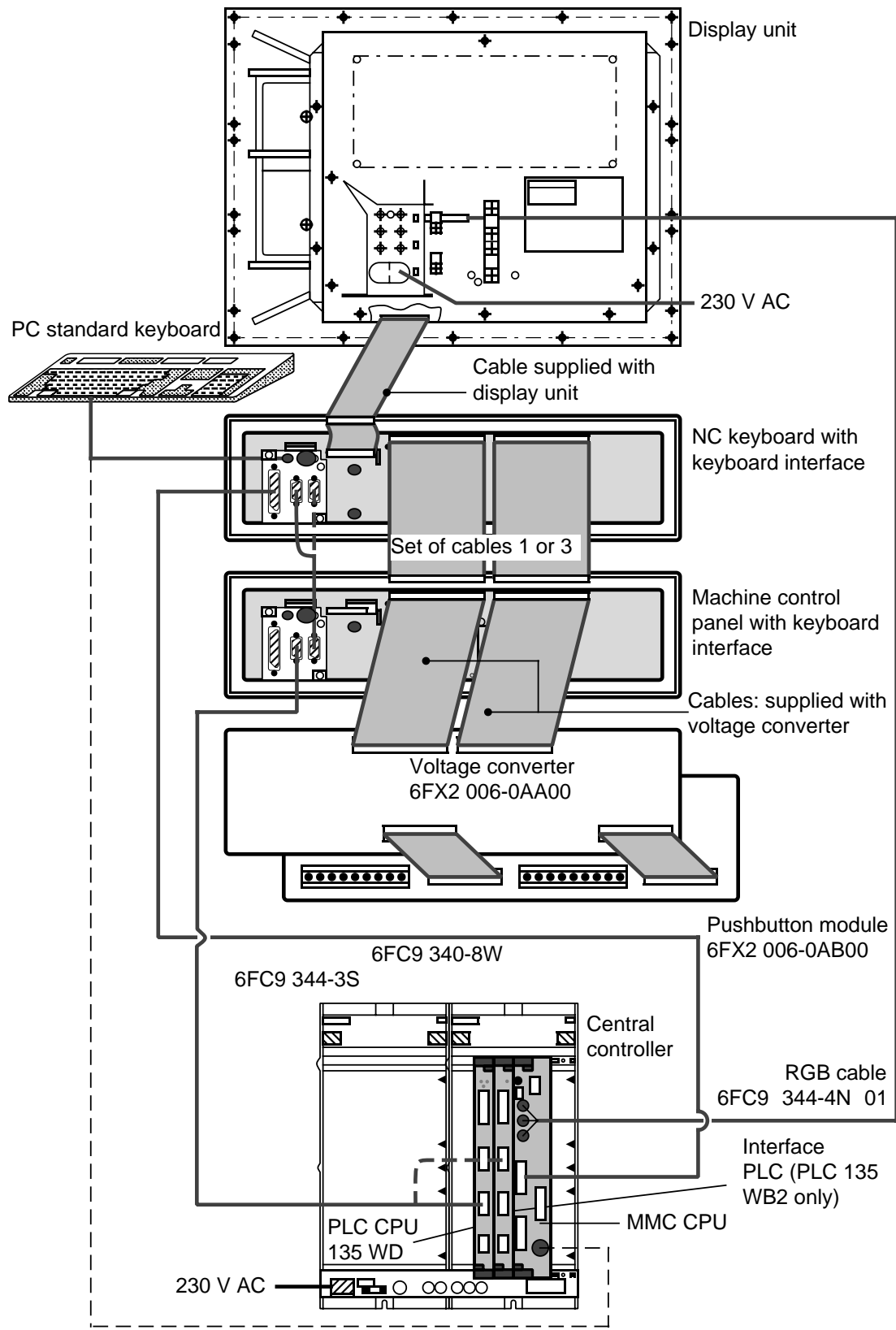

1.5 Connection diagram for SINUMERIK 840C with slimline operator panel (version from 02.95)

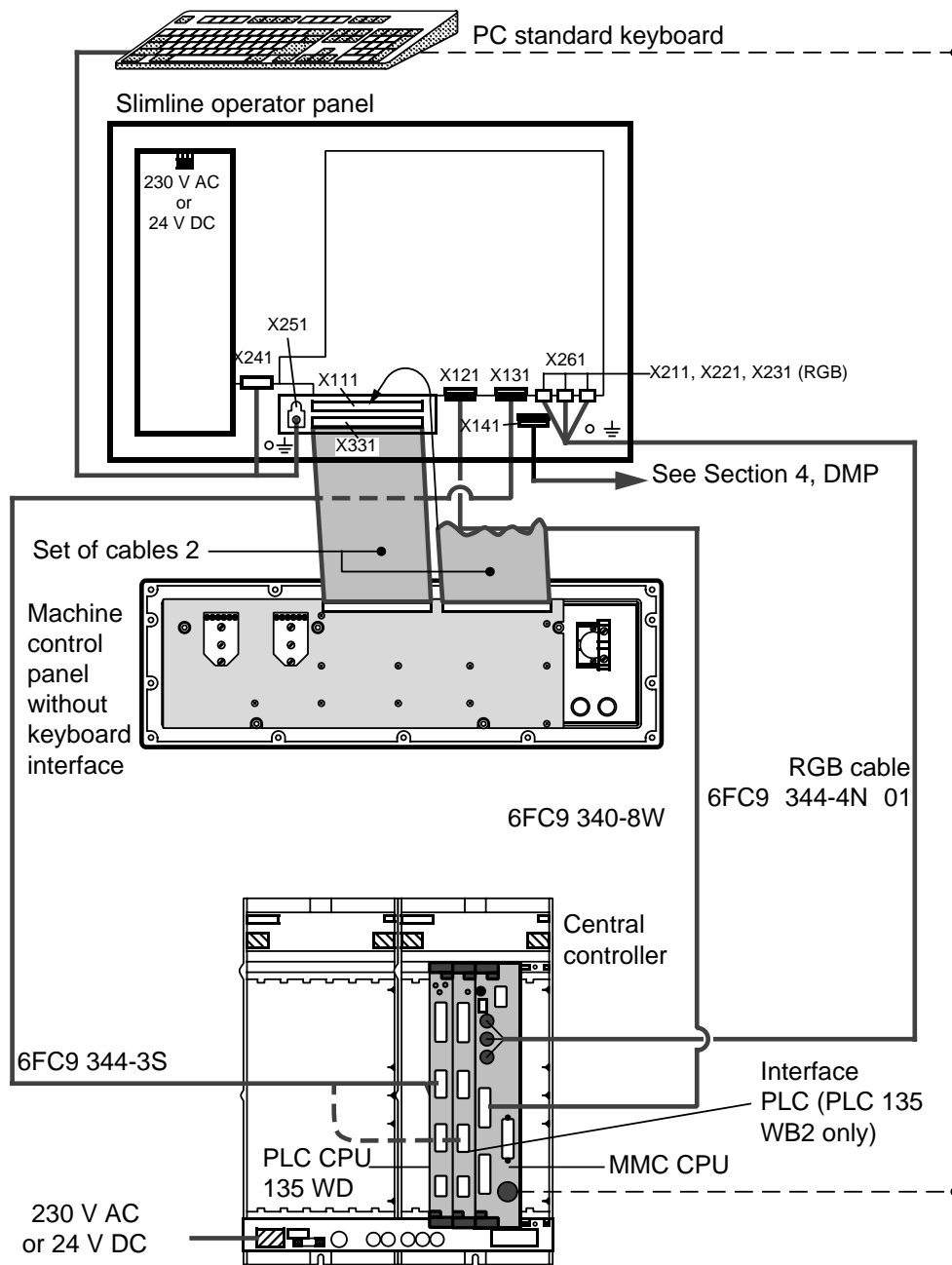

1.6 Connection diagram for SINUMERIK 840C with 9.5" slimline operator panel and pushbutton module

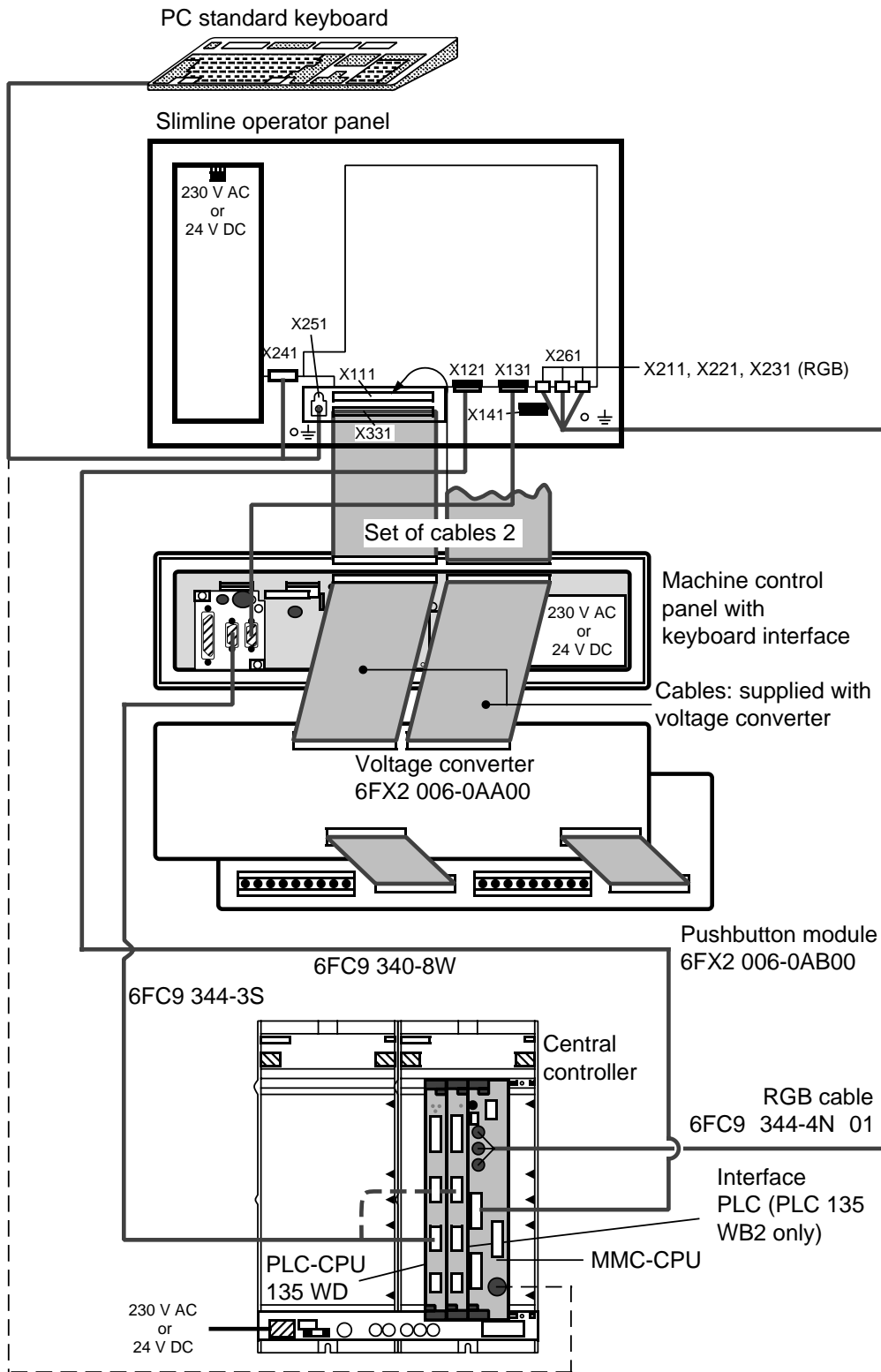

1.7 Central controller interfaces

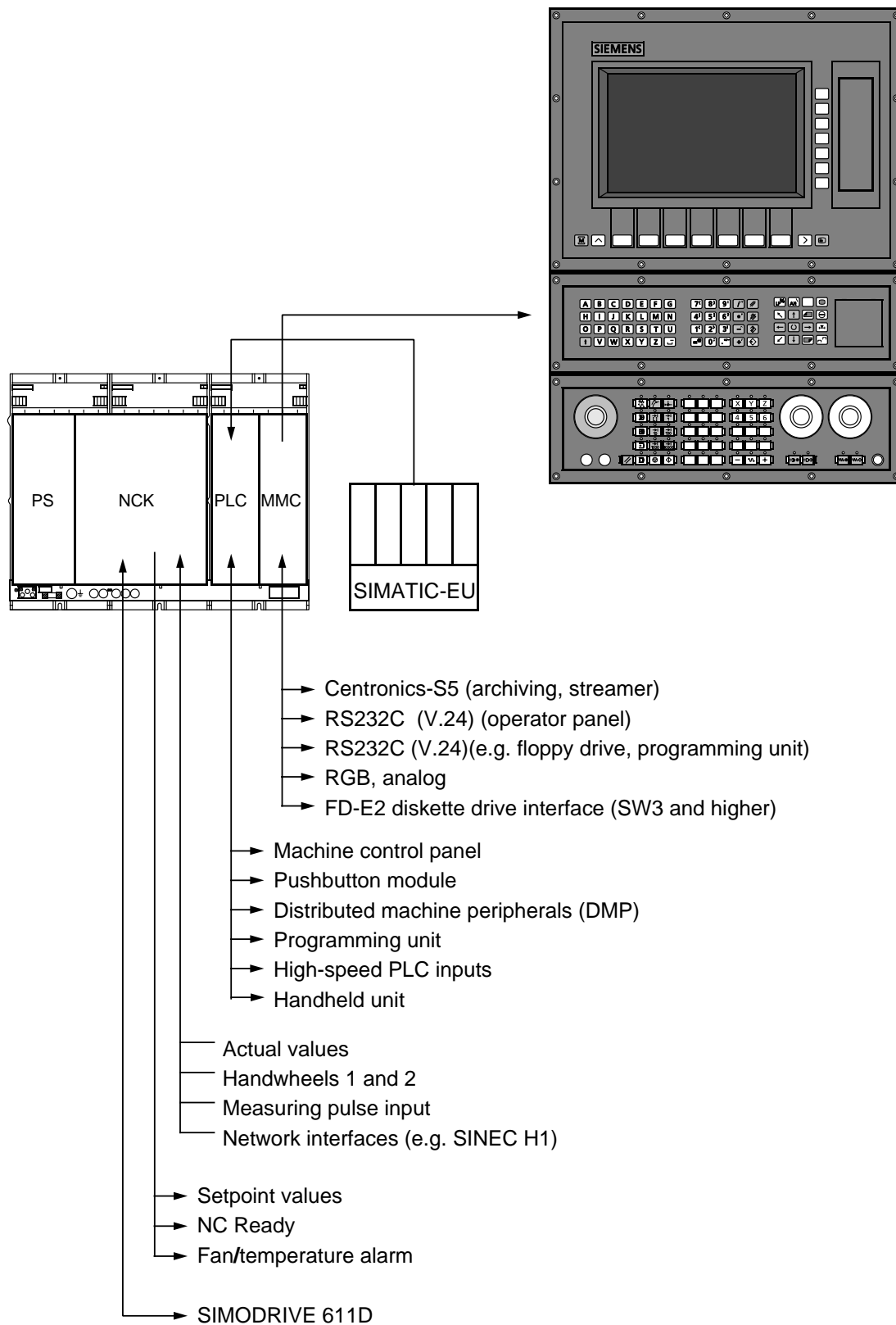

1.8 SINUMERIK 840C peripherals

For SINUMERIK 840C systems, the inputs/outputs from/to the machine can be connected either in

- a central configuration via the central controller modules
- a distributed configuration via an RS 485/MPC link or
- a distributed configuration via a 16-bit link.

I/O interfaces: SINUMERIK 840C (maximum configuration) – example

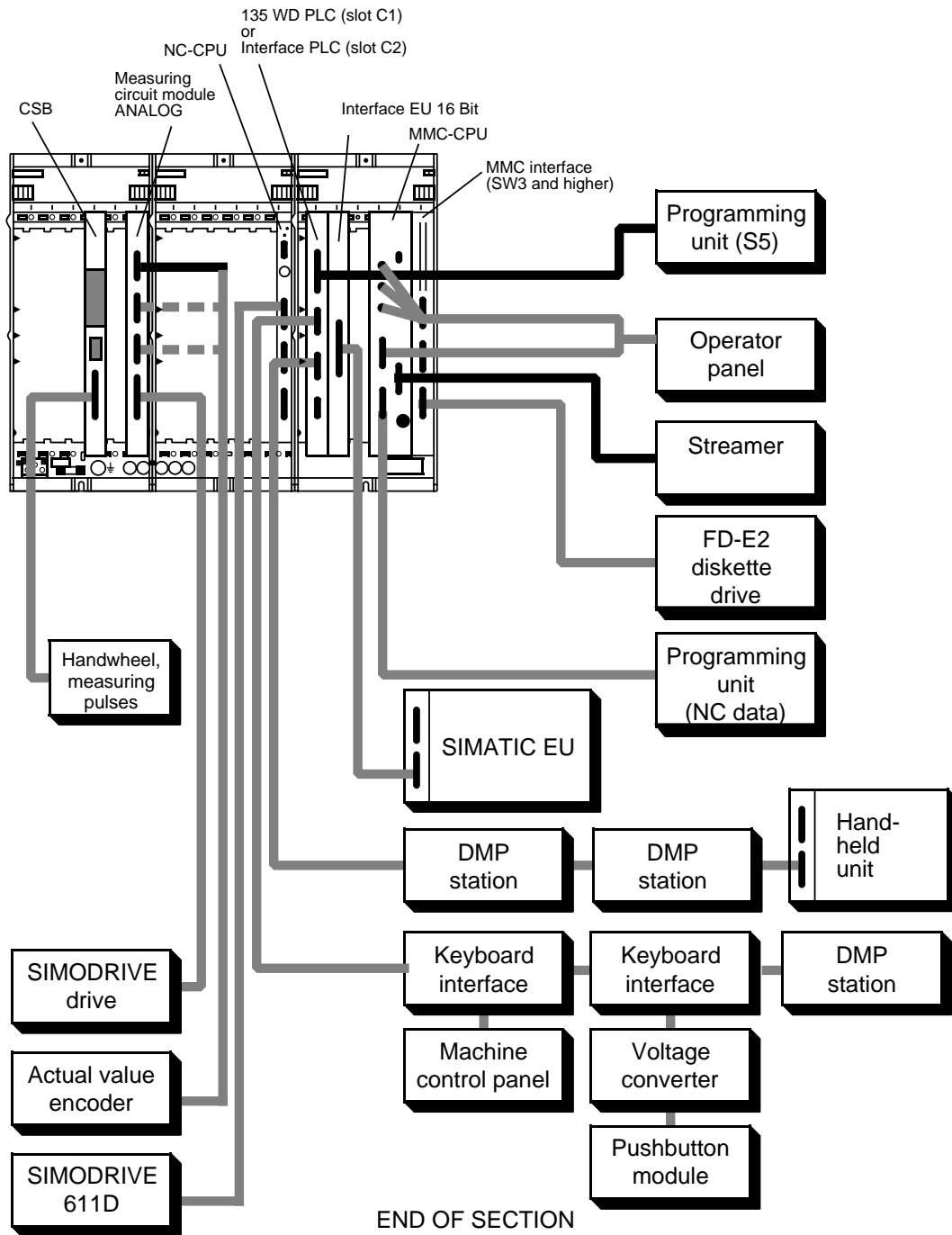

2 Connections

2.1 Hardware overview with order numbers

Tabular overview

The devices and units constituting the SINUMERIK 840C control are listed below.

Item	Name	Order number of unit (also spare parts)	Comments
1	Components of complete operator panel		
1.1	Slimline operator panel with 10" monochrome display, 230 V AC power supply, standard layout	6FC5 103-0AB02-0AA0	replaced by 6FC5 103-0AB02-0AA1 from 05.95
1.1.1	Slimline oper. panel with 9.5" monochrome LC display, 230 V AC power supply, standard layout	6FC5 103-0AB02-0AA1	replaced by 6FC5 103-0AB02-0AA2 from 01.96
	Slimline oper. panel with 9.5" monochrome LC display, 230 V AC power supply, standard layout	6FC5 103-0AB02-0AA2	from 01.96
1.1.2	Slimline oper. panel with 9.5" monochrome LC display, 24 V DC power supply, standard layout	6FC5 103-0AB02-1AA1	replaced by 6FC5 103-0AB02-1AA2 from 01.96
	Slimline oper. panel with 9.5" monochrome LC display, 24 V DC power supply, standard layout	6FC5 103-0AB02-1AA2	from 01.96
1.2	Slimline operator panel with 10" monochrome display, 230 V AC power supply, US layout	6FC5 103-0AB12-0AA0	replaced by 6FC5 103-0AB12-0AA1 from 05.95
1.2.1	Slimline oper. panel with 9.5" monochrome LC display, 230 V AC power supply, US layout	6FC5 103-0AB12-0AA1	replaced by 6FC5 103-0AB12-0AA2 from 01.96
	Slimline oper. panel with 9.5" monochrome LC display, 230 V AC power supply, US layout	6FC5 103-0AB12-0AA2	from 01.96
1.2.2	Slimline oper. panel with 9.5" monochrome LC display, 24 V DC power supply, US layout	6FC5 103-0AB12-1AA1	replaced by 6FC5 103-0AB12-1AA2 from 01.96
	Slimline oper. panel with 9.5" monochrome LC display, 24 V DC power supply, US layout	6FC5 103-0AB12-1AA2	from 01.96
1.3	Slimline operator panel with 10" color TFT display, 230 V AC power supply, standard layout	6FC5 103-0AB03-0AA0	replaced by 6FC5 103-0AB03-0AA1 from 05.95
1.3.1	Slimline operator panel with 9.5" color TFT display, 230 V AC power supply, standard layout	6FC5 103-0AB03-0AA1	replaced by 6FC5 103-0AB03-0AA2 from 01.96
1.3.2	Slimline operator panel with 9.5" color TFT display, 230 V AC power supply, standard layout	6FC5 103-0AB03-0AA2	from 01.96
1.3.3	Slimline operator panel with 9.5" color TFT display, 24 V DC power supply, standard layout	6FC5 103-0AB03-1AA1	replaced by 6FC5 103-0AB03-1AA2 from 01.96
1.3.4	Slimline operator panel with 9.5" color TFT display, 24 V DC power supply, standard layout	6FC5 103-0AB03-1AA2	from 01.96
1.3.5	Slimline operator panel with 10.4" color display, 230 V AC power supply, standard layout	6FC5 103-0AB03-0AA3	
1.3.6	Slimline operator panel with 10.4" color display, 24 V DC power supply, standard layout	6FC5 103-0AB03-1AA3	
1.4	Slimline operator panel with 10" color TFT display, 230 V AC power supply, US layout	6FC5 103-0AB13-0AA0	replaced by 6FC5 103-0AB13-0AA1 from 05.95
1.4.1	Slimline operator panel with 9.5" color TFT display, 230 V AC power supply, US layout	6FC5 103-0AB13-0AA1	replaced by 6FC5 103-0AB13-0AA2 from 01.96
1.4.2	Slimline operator panel with 9.5" color TFT display, 230 V AC power supply, US layout	6FC5 103-0AB13-0AA2	from 01.96
1.4.3	Slimline operator panel with 9.5" color TFT display, 24 V DC power supply, US layout	6FC5 103-0AA13-1AA1	replaced by 6FC5 103-0AB13-1AA2 from 01.96
1.4.4	Slimline operator panel with 9.5" color TFT display, 24 V DC power supply, US layout	6FC5 103-0AA13-1AA2	from 01.96
1.4.5	Slimline operator panel with 10.4" color display, 230 V AC power supply, US layout	6FC5 103-0AB13-0AA3	
1.4.6	Slimline operator panel with 10.4" color display, 24 V DC power supply, US layout	6FC5 103-0AB13-1AA3	

2.1 Hardware overview with order numbers

Item	Name	Order number of unit (also spare parts)	Comments
1.4.5	Spare parts: 9.5" monochrome display	6FC5 247-0AA15-0AA0	
1.4.6	Spare parts: 9.5" color display	6FC5 247-0AA16-0AA0	
1.4.7	Spare parts: 1 backlight for 9.5" color display	6FC5 147-0AA00-0AA0	from 01.96
	Spare parts: 10 backlights for 9.5" color display	6FC5 147-0AA02-0AA0	from 01.96
1.5	Spare parts: Monitor shield, non-reflecting for 10" display slimline operator panel	6FC5 148-0AC01-0AA0	
	Spare parts: Monitor shield, non-reflecting for 9.5" display slimline operator panel	6FC5 148-0AC01-0AA1	
	Display shield, non-reflecting for 10.4" display	6FC5 148-0AC01-0AA2	
1.6	Spare parts: backlight for 10" color display	6FC5 147-0AA10-0AA0	
	Backlight for 10.4" display, 1 piece	6FC5 147-0AA10-0AA1	
1.7	14" color screen with softkey bars, standard layout	6FC5 103-0AB01-0AA0	replaced by 6FC5 103-0AB01-0AA1
1.7.1	14" color screen with softkey bars, standard layout; diskette drive can be fitted	6FC5 103-0AB01-0AA1	from 12.95 with US key caps
1.7.2	19" operator panel with 10.4" display	6FC5 103-0AB01-0AA2	Spare part for operator panel with 14" screen
1.8	14" color screen with softkey bars, US layout	6FC5 103-0AB11-0AA0	replaced by 6FC5 103-0AB11-0AA1
1.8.1	14" color screen with softkey bars, US layout; diskette drive can be fitted	6FC5 103-0AB11-0AA1	replaced by 6FC5 103-0AB01-0AA1 from 12.95
1.9	NC keyboard without keyboard interface, standard layout	6FC5 103-0AC01-0AA0	
1.10	NC keyboard without keyboard interface, US layout	6FC5 103-0AC11-0AA0	
1.11	NC keyboard with keyboard interface, standard layout	6FC5 103-0AC02-0AA0	replaced by 6FC5 103-0AC02-0AA1 from 05.95
1.11.1	NC keyboard with keyboard interface, standard layout	6FC5 103-0AC02-0AA1	from 05.95
1.12	NC keyboard with keyboard interface, US layout	6FC5 103-0AC12-0AA0	from 05.95 6FC5 103-0AC12-0AA1
1.12.1	NC keyboard with keyboard interface, US layout	6FC5 103-0AC12-0AA1	from 05.95
1.13	Machine control panel T version without keyboard interface, standard layout	6FC5 103-0AD01-0AA0	
1.14	Machine control panel T version without keyboard interface, US layout	6FC5 103-0AD11-0AA0	
1.15	Machine control panel M version without keyboard interface, standard layout	6FC5 103-0AD03-0AA0	
1.16	Machine control panel M version without keyboard interface, US layout	6FC5 103-0AD13-0AA0	
1.17	Machine control panel T version with keyboard interface, standard layout	6FC5 103-0AD02-0AA0	from 05.95 6FC5 103-0AD02-0AA1
1.18	Machine control panel T version with keyboard interface, US layout	6FC5 103-0AD12-0AA0	from 05.95 6FC5 103-0AD12-0AA1
1.19	Machine control panel M version with keyboard interface, standard layout	6FC5 103-0AD04-0AA0	from 05.95 6FC5 103-0AD04-0AA1
1.20	Machine control panel M version with keyboard interface, US layout	6FC5 103-0AD14-0AA0	from 05.95 6FC5 103-0AD14-0AA1
1.21	Keyboard interface for NC keyboard and machine control panel with 230 V AC power supply	6FC5 103-0AE01-0AA0	
	Keyboard interface for NC keyboard and machine control panel with 230 V AC power supply	6FC5 103-0AE01-0AA1	replaces 6FC5 103-0AE01-0AA0 from 05.95
	Keyboard interface for NC keyboard and machine control panel with 24 V DC power supply	6FC5 103-0AE01-1AA1	can be ordered from 05.95
1.22	Set of cables 1 (between machine control panel and keyboard interface) consisting of: – 2 x ribbon cables, 64-wire	6FC5 147-0AA03-0AA0	

VB = Version B

Item	Name	Order number of unit (also spare parts)	Comments
1.23	Set of cables 2 (between machine control panel and oper. panel interface on slimline panel) consisting of: – 1 x ribbon cable 64-wire – 1 x ribbon cable 64-wire	6FC5 147-0AA04-0AA0	
1.24	Set of cables 3 (between second machine control panel and keyboard interface) consisting of: 2 x 100 m	6FC5 103-0AC03-0AA0	
1.25	Standard PC keyboard with special NC keys (MF II)	6FC5 103-0AC03-0AA0	
	Standard PC keyboard (MF II)	6FC5 203-0AC01-0AA0	
1.26	Hand-held unit with handwheel	6FC5 103-0AD20-0AA0	
1.27	Distribution box for hand-held unit 6FC5 103-0AD20-0AA0	6FC5 147-0AA05-0AA0	
1.28	FD E2 diskette drive for 3.5" diskettes (built-in)	6FC5 135-0AA01-0AA0	can be ordered with SW 3 and higher
1.29	A-MPC hand-held unit with handwheel (3.5 m)	6FX2 007-1AB00	available from 07.94
	A-MPC hand-held unit with handwheel (3.5 m)	6FX2 007-1AB01	replaces 6FX2 007-1AB00
	A-MPC hand-h. unit w. 1-channel emerg. stop (10 m)	6FX2 007-1AB10	
	A-MPC hand-h. unit w. 2-channel emerg. stop (10 m)	6FX2 007-1AB11	
	A-MPC HHU w. 2-ch. em. st., 2nd enab. butt. (3.5 m)	6FX2 007-1AB02	
	A-MPC HHU w. 2-ch. em. st., 2nd enab. butt. (10 m)	6FX2 007-1AB12	
	A-MPC hand-held unit w. 2-channel emerg. stop, 2nd enabling button, electr. isolation, handwheel (3.5 m)	6FX2 007-1AB03	
	A-MPC hand-held unit w. 2-channel emerg. stop, 2nd enabling button, electr. isolation, handwheel (10 m)	6FX2 007-1AB13	
1.30	Distribution box for hand-held unit 6FX2 007-1AB00	6FX2 006-1BC00	available from 06.95 replaces 6FX2 006-1BB00
	Distribution box for hand-held unit 6FX2 007-1B	6FX2 006-0BC01	replaces 6FX2 006-1BC00
1.31	Voltage converter module UTS 840C	6FX2 006-0AA00	
1.32	Pushbutton module	6FX2 006-0AB00	
1.33	Rotary switch for MCP	6FC5 247-0AA21-0AA0	
1.34	Switches and keys for MCP	6FC5 247-0AA22-0AA0	
1.35	Keyboard covers grey	6FC5 148-0AA13-0AA0	
1.35	Keyboard covers transparent	6FC5 148-0AA14-0AA2	
1.36	230 V AC power supply for slimline operator panel (all the 230 V versions)	6FC5 147-0AA14-0AA2	
1.37	24 V DC power supply for slimline operator panel (all the 24 V versions)	6FC5 147-0AA14-1AA2	
2	CPU modules		
2.1	NC CPU		
2.1.1	NC CPU 386 DX	6FC5 110-0BA01-0AA0	can only be used with SW1; no longer available
2.1.2	NC CPU 386 DX with Restart EPROM	6FC5 110-0BA01-1AA0	can be used with SW 1; also spare part for SW 1
2.1.3	NC CPU 486 DX 33MHz with SIMODRIVE 611D interface	6FC5 110-0BB02-0AA0	available with 611D interface from 12.93
	NC-CPU 486 DX VB-33MHz with SIMODRIVE 611D interface	6FC5 110-0BB02-0AA1	replaces 6FC5 110-0BB02-0AA0 from 08.94
2.1.4	NC CPU 486 DX2-66MHz with SIMODRIVE 611D interf.	6FC5 110-0BB03-0AA0	
	NC-CPU 486 DX2 VB-66MHz with SIMODRIVE 611D interface	6FC5 110-0BB03-0AA1	
2.1.5	NC-CPU 486 DX VB-33MHz with SIMODRIVE 611D interface	6FC5 110-0BB01-0AA1	replaces 6FC5 110-0BA01-1AA0 from 08.94
2.1.6	NC-CPU 486 DX2 VB-66MHz with SIMODRIVE 611D interface	6FC5 110-0BB01-0AA2	can be used from SW 3.9 to 3.x and with SW 4.5 and higher
2.1.7	NC-CPU 486 DX4 VB-100MHz with SIMODRIVE 611D interface	6FC5 110-0BB04-0AA1	can be used from SW 3.9 to 3.x and with SW 4.5 and higher
2.2	MMC CPU		
2.2.1	MMC CPU 386 SX, 4/8 Mbyte RAM, with basic software	6FC5 110-0DA01-0AA0	<ul style="list-style-type: none"> with 8 Mbyte RAM from 12.93, 4 Mbyte RAM only up to SW 2 from 08.94 replaced by 486 SX VB, 8 MB (6FC5 110-0DB01-0AA1)
2.2.2	MMC CPU 386 SX/387 SX, 8 Mbyte RAM, with basic software	6FC5 110-0DA02-0AA0	replaced by 6FC5 110-0DA02-0AA1 from 08.94-12.94
2.2.3	MMC CPU 386 SX, 16 Mbyte RAM, with basic software	6FC5 110-0DA04-0AA0	with SW 1 or higher; replaced by 6FC5 110-0DB04-0AA1 from 08.94

VB = Version B

2.1 Hardware overview with order numbers

Item	Name	Order number of unit (also spare parts)	Comments
2.2.4	MMC CPU 486 DX, 8 Mbyte RAM, with basic softw.	6FC5 110-0DB02-0AA0	
	MMC CPU 486 DX VB-33 MHz, 8 Mbyte RAM, with basic software	6FC5 110-0DB02-0AA1	replaces 6FC5 110-0DB02-0AA0 from 08.94 and 6FC5 110-0DA02-0AA1 from 01.95
	MMC CPU 486 DX2 VB-66 MHz, 8 Mbyte RAM, with basic software	6FC5 110-0DB02-0AA2	available from 02.96; replaces 6FC5 110-0DB02-0AA1
2.2.5	MMC CPU 486 DX, 16 Mbyte RAM, with basic softw.	6FC5 110-0DB03-0AA0	
	MMC CPU 486 DX VB-33 MHz, 16 MB RAM, with basic software	6FC5 110-0DB03-0AA1	• OEM only • replaces 6FC5 110-0DB03-0AA0 from 08.94
	MMC CPU 486 DX2 VB-66 MHz, 16 Mbyte RAM, with basic software	6FC5 110-0DB03-0AA2	available from 02.96; replaces 6FC5 110-0DB03-0AA1
2.2.6	MMC CPU 486 SX VB-33 MHz, 8 MB RAM, with basic software	6FC5 110-0DB01-0AA1	replaces 6FC5 110-0DA01-0AA0 from 08.94
	MMC CPU 486 SX VB-33 MHz, 16 MB RAM, with basic software	6FC5 110-0DB04-0AA1	replaces 6FC5 110-0DA04-0AA0 from 08.94
2.2.7	MMC CPU 486 DX4 100MHz, 32 MB RAM, with basic software	6FC5 110-0DB03-0AA3	available from 08.98; replaces 6FC5 110-0DB03-0AA2
2.3	PLC CPU		
2.3.1	PLC CPU 135 WB2	6FC5 110-0CA01-0AA0	only available as spare part
2.3.2	PLC CPU 135 WD	6FC5 110-0CB01-0AA0	with SW 3 and higher
3	NC/servo I/O modules		
3.1	Measuring circuit module ANALOG; 20 mm, not for use with EXEs	6FC5 111-0BA01-0AA0	
3.2	Measuring circuit module ANALOG, 40 mm, prepared for EXEs	6FC5 111-0BA00-0AA0	
	Measuring circuit module ANALOG, 40 mm equipped with 1 x 5/10fold EXE,	6FC5 111-0BA02-0AA0	no longer available
	Measuring circuit module ANALOG; 40 mm equipped with 2 x 5/10fold EXE,	6FC5 111-0BA03-0AA0	no longer available
	Measuring circuit module ANALOG, 40 mm equipped with 3 x 5/10fold EXE,	6FC5 111-0BA04-0AA0	no longer available
3.3	5/10fold EXE,	6FC5 111-0BA06-0AA0	
3.4	HMS measuring circuit module, 20 mm for 3 actual values comprising: – 1 HMS servo interface	6FC5 111-0BA40-0AA0	can be ordered until 12.96, after which only available as spare part
	as above, equipped with 1 * I/V hybrid on axis 1	6FC5 111-0BA41-0AA0	can only be ordered until 08.93
	as above, equipped with 2 * I/V hybrid on axes 1 and 2	6FC5 111-0BA42-0AA0	can only be ordered until 08.93
	as above, equipped with 3 * I/V hybrid on axes 1,2 and 3	6FC5 111-0BA43-0AA0	can only be ordered until 08.93
3.5	HMS measuring circuit module, 40 mm for 3 actual values and 3 setpoints comprising: – 1 HMS servo interface – 1 servo command submodule	6FC5 111-0BA44-0AA0	can be ordered until 12.96, after which only available as spare part
	as above, equipped with 1 * I/V hybrid on axis 1	6FC5 111-0BA45-0AA0	can only be ordered until 08.93
	as above, equipped with 2 * I/V hybrid on axes 1 and 2	6FC5 111-0BA46-0AA0	can only be ordered until 08.93
	as above, equipped with 3 * I/V hybrid on axes 1,2 and 3	6FC5 111-0BA47-0AA0	can only be ordered until 08.93

VB = Version B

Item	Name	Order number of unit (also spare parts)	Comments
	as above, equipped with 3 * I/V hybrid on axes 1,2 and 3	6FC5 111-0BA47-0AA0	can only be ordered until 08.93
3.6	HMS measuring circuit module, 40 mm for 3 actual values and 6 setpoints comprising: – 1 HMS servo interface – 2 servo command submodules	6FC5 111-0BA50-0AA0	can be ordered until 12.96, after which only available as spare part
	as above, equipped with 1 * I/V hybrid on axis 1	6FC5 111-0BA51-0AA0	can only be ordered until 08.93
	as above, equipped with 2 * I/V hybrid on axes 1 and 2	6FC5 111-0BA52-0AA0	can only be ordered until 08.93
	as above, equipped with 3 * I/V hybrid on axes 1,2 and 3	6FC5 111-0BA53-0AA0	can only be ordered until 08.93
3.7	HMS measuring circuit module, 40 mm for 3 actual values and 9 setpoints comprising: – 1 HMS servo interface – 3 servo command submodules	6FC5 111-0BA54-0AA0	can be ordered until 12.96, after which only available as spare part
	as above, equipped with 1 * I/V hybrid on axis 1	6FC5 111-0BA55-0AA0	can only be ordered until 08.93
	as above, equipped with 2 * I/V hybrid on axes 1 and 2	6FC5 111-0BA56-0AA0	can only be ordered until 08.93
	as above, equipped with 3 * I/V hybrid on axes 1,2 and 3	6FC5 111-0BA57-0AA0	can only be ordered until 08.93
3.8	HMS measuring circuit module, 40 mm for 3 absolute actual values and 3 setpoints comprising: – 1 HMS servo interface – 1 ID 70408296 absolute encoder submodule – 1 servo command submodule	6FC5 111-0BA58-0AA0	can be ordered until 12.96, after which only available as spare part
3.9	I/V hybrid (quantity: 3)	6FC5 147-0AA08-0AA0	can be ordered from 08.93
3.10	Servo command submodule	6FC5 111-0BA60-0AA0	can be ordered from 08.93
3.11	Absolute encoder submodule	6FC5 111-0BA61-0AA0	can be ordered from 08.93
4	PLC I/O modules		
4.1	DMP terminal block in IP 65 with assembly parts	6FC5 111-0CA72-0AA0	can only be ordered until 12.95
4.2	DMP module to IP 65 (8... 16 I, 8 ... 0 O) 24 V, floating	6FC5 111-0CA22-0AA0	can only be ordered until 12.95
4.3	DMP compact terminal block (1 ... 8 compact modules can be inserted)	6FC5 111-0CA73-0AA0	replaced by 6FC5 111-0CA73-0AA1
	DMP compact terminal block (1 ... 8 compact modules can be inserted)	6FC5 111-0CA73-0AA1	
4.4	DMP compact module, 8 outputs, 24 V/2 A, floating	6FC5 111-0CA03-0AA0	replaced by 6FC5 111-0CA03-0AA1
	DMP compact module, 8 outputs, 24 V/2 A, floating	6FC5 111-0CA03-0AA1	replaced by 6FC5 111-0CA03-0AA2
	DMP compact module, 8 outputs, 24 V/2 A, floating	6FC5 111-0CA03-0AA2	
4.5	DMP compact module, 16 outputs, 24 V/0.5 A, floating	6FC5 111-0CA02-0AA0	replaced by 6FC5 111-0CA02-0AA1
	DMP compact module, 16 outputs, 24 V/0.5 A, floating	6FC5 111-0CA02-0AA1	replaced by 6FC5 111-0CA02-0AA2
	DMP compact module, 16 outputs, 24 V/2 A, floating	6FC5 111-0CA02-0AA2	
4.6	DMP compact module, 16 inputs, 24 V, floating	6FC5 111-0CA01-0AA0	
4.7	DMP compact module, ANALOG OUT, floating	6FC5 111-0CA05-0AA0	
4.8	DMP compact module, ANALOG IN, floating	6FC5 111-0CA04-0AA0	can be used with SW 3 and higher
4.9	DMP terminal block for 32 I or 16 I/16 O submodules	6FC5 111-0CA71-0AA0	

2.1 Hardware overview with order numbers

Item	Name	Order number of unit (also spare parts)	Comments
4.10	DMP I/O module 16 I/16 O, 24 V/2 A, short-circuit proof	6FC5 111-0CA20-0AA0	
4.11	DMP I/O module 32 inputs, 24 V, short-circuit proof	6FC5 111-0CA21-0AA0	
4.12	DMP terminator	6FC5 111-0CA70-0AA0	
4.13	IN ANALOG I/O module, 8 analog inputs, ± 10 V, 20 mm	6FC5 111-0CB01-0AA0	
4.14	MIXED I/O module, 16 digital I/O, 4 analog outputs, ± 10 V, 20 mm	6FC5 111-0CB02-0AA0	
5	Link modules/interface modules		
	NC		
5.1	Bus link SINEC CP 231A connection to SINEC H1 without system software	6FC5 112-0EA01-0AA0	
5.2	System software submodule for CP 231 (EPROM submodule for SINEC H1)	6FC5 154-0AX01-1AE0	
5.3	1 active serial interface (RS 232 C) with CP 315 comprising: – CP 315 module without software submodule	6FC5 112-0EA02-0AA0	
5.4	Systems software submodule for CP 315 (EPROM submodule for active RS 232 C)	6FC5 154-0AX02-1AE0	
5.5	CP 315 linked with CP 373 comprising: – CP 315 module, 1 active serial interface – CP 315 module, 3 additional active serial interfaces	6FC5 112-0EA03-0AA0	
5.6	SINEC CP 1476 (MAP 3.0)	6GK1 147-6MA01	
	PLC		
5.7	PLC interface	6FC5 112-0CA01-0AA0	up to SW 2
5.8	16 bit EU interface	6FC5 112-0CA03-0AA0	
5.9	DMP interface (for DMP submodule, machine control panel, EU)	6FC5 112-0CA02-0AA0	
5.10.1	Profibus DP slave module interface, IM 328N	6FC5 012-0CA01-0AA0	replaced by 6FC5 012-0CA03-0AA0
5.10.2	Profibus DP master/slave module interface, IM 329N	6FC5 012-0CA02-0AA0	
	MMC		
5.11	MMC interface	6FC5 112-0DA01-0AA0	can be ordered with SW3 and higher
	MMC interface (new)	6FC5 112-0DA01-0AA1	available from 01.96; replaces 6FC5 112-0DA01-0AA0
6	Memory submodules		
6.1	EPROM submodule, 2 Mbytes, not programmed	6FC5 130-0CA01-0AA0	SW 1 only
6.2	PLC restart EPROM submodule	6FC5 152-1BX01-1AE0	For upgrading PLC 135 WB2 to SW 3 and SW 4
7	Drives		
7.1	VALITEK PST 160 streamer with empty cartridge	6FC9 310-1NB00	
	VALITEK PST2-M1200 streamer with empty cartridge	6FC9 310-2AA00	
7.2	Ext. floppy drive (3.5" FD-E1 built-in floppy drive)	6FC9 310-1NA00	
7.3	FD-E2 floppy drive for 3.5" diskettes (built-in)	6FC5 135-0AA01-0AA0	can be ordered with SW3 and higher

Item	Name	Order number of unit (also spare parts)	Comments
8	Mechanical components/ additional units		
8.1	Cable distributor for CSB	6FC5 147-0AA01-0AA0 (old) 6FC5 006-1BA01 (new)	replaced by 6FX2 006-1BA01 from 08.94
9	Hardware accessories		
9.1	Interface changeover switch (operator panel changeover switch) complete, comprising:		
	– Base plate (old)	6FC9 310-1MA00	replaced by 6FC9 310-1MA01 from 08.94
	– Base plate (new)	6FC9 310-1MA01	
	– RGB (monitor) changeover switch (old)	6FC9 310-1MD00	replaced by 6FC9 310-1MD01
	– RGB (monitor) changeover switch (new)		6FC9 310-1MD01
	– RS 232 C (keyboard) changeover switch (old)	6FC9 310-1MB00	replaced by 6FC9 310-1MB01
	– RS 232 C (keyboard) changeover switch (new)	6FC9 310-1MB01	
9.2	10 front blanking plates	6FC5 148-0AA01-0AA0	
9.3	Blind plug for "Emergency stop" mounting opening (22.5 mm), black (pack of 50)	3SB1 902-0AR	
10	Central controller/basic version control		
10.1	1 central controller 1, 840C, 12 slots with module complement, comprising:	6FC5 100-0AA01-0AA0 (order no. on packaging only)	can be ordered up to SW 2
10.1	1 central controller 1, 840C, 12 slots with module complement, comprising:	replaced by 6FC5 100-0AA01-0AA1	can be ordered with SW 3 and higher
	1 central controller 1, 840C, subrack, 12 slots, without module complement		6FC5 101-0AA01-0AA0
	Spare part: fan unit		6FC5 147-0AA07-0AA0
	Spare part: fan unit amplified		6FC5 147-0AA07-0AA1
	1 230 V AC power supply		6FC5 114-0AA01-0AA0 replaced by 6FC5 114-0AA01-0AA1 replaced by 6FC5 114-0AA01-0AA2 or 6FC5 114-0AB01-0AA0 replaced by 6FC5114-0AB01-0AA1
	1 central service board, complete, comprising: – 1 central service board – 1 9V battery		6FC5 114-0AA02-0AA0
	1 PLC CPU 135 WD module with restart EPROM		6FC5 110-0CB01-0AA0
	1 log book		6FC3 987-7AV
10.2	1 central controller 2, 840C, 18 slots with module complement, comprising:	6FC5 100-0AB01-0AA0 (order number on packaging only)	can be ordered up to SW2
	1 central controller 2, 840C, subrack, 18 slots, without module complement		6FC5 101-0AB01-0AA0
	1 230 V AC power supply		6FC5 114-0AA01-0AA0 replaced by 6FC5 114-0AA01-0AA1 replaced by 6FC5 114-0AA01-0AA2 or 6FC5 114-0AB01-0AA0 replaced by 6FC5114-0AB01-0AA1

2.1 Hardware overview with order numbers

Item	Name	Order number of unit (also spare parts)	Comments
	1 central service board, complete comprising: – 1 central service board – 1 9V battery		6FC5 114-0AA02-0AA0
	1 PLC CPU assembled, as described below: 1 PLC CPU 135 WB2 module with 1 grip comprising: – 1 PLC CPU 135 WB2 with ACOP 2 with max. 256 Kbyte user program memory – 1 grip (submodule front panel) (slot 1) 1 PLC system software on EPROM submodule (slot 3): – PLC system software package – EPROM submodule (256 Kbytes) 1 PLC user program memory submodule (slot 2): – EPROM submodule not programmed		is only supplied assembled in central controller 6FC5 110-OCA01-0AA0 6FC5 152- AX01- AA0 6FC5 130-OCA01-0AA0
	1 PLC interface		6FC5 112-OCA01-0AA0
	1 log book		6FC3 987-7AV
10.2	1 central controller 2, 840C, 18 slots with module complement, comprising:	6FC5 100-0AB01-0AA1 (order number on packaging only)	can be ordered with SW3 and higher
	1 central controller 2, 840C, subrack, 18 slots, without module complement		6FC5 101-0AB01-0AA0
	1 230 V AC power supply		6FC5 114-0AA01-0AA0 replaced by 6FC5 114-0AA01-0AA1 replaced by 6FC5 114-0AA01-0AA2 or 6FC5 114-0AB01-0AA0 replaced by 6FC5114-0AB01-0AA1
	1 central service board, complete comprising: – 1 central service board – 1 9 V battery		6FC5 114-0AA02-0AA0
	1 PLC CPU 135 WD module with restart EPROM		6FC5 110-0CB01-0AA0
	1 log book		6FC3 987-7AV
10.2	1 central controller 3 with AT subrack expansion, 840C, 18 slots + 3 AT slots, with module complement, comprising:	6FC5 100-0AB02-0AA0 (order number on packaging only)	can be ordered with SW3 and higher
	1 central controller 3, 840C, subrack, 18 slots + 3 AT slots, without module complement		6FC5 101-0AB02-0AA0
	1 230 V AC power supply		6FC5 114-0AA01-0AA0 replaced by 6FC5 114-0AA01-0AA1 replaced by 6FC5 114-0AA01-0AA2 or 6FC5 114-0AB01-0AA0 replaced by 6FC5114-0AB01-0AA1
	1 central service board, complete, comprising: – 1 central service board – 1 9 V battery		6FC5 114-0AA02-0AA0
	1 PLC CPU 135 WD module with restart EPROM		6FC5 110-0CB01-0AA0
	1 log book		6FC3 987-7AV
10.3	Loose-leaf file	6FC5 195-0AA00-0AP0	
10.4	Assembly of hardware	6FC5 188-0AA01-0AA0	
10.5	24 V DC power supply ¹⁾		6FC5 114-0AA01-1AA0

1) The central controller subrack and modules must be ordered separately for the 24 V DC version.

Handling of modules

Please refer to the Sections, Electrostatically sensitive devices (ESD) and Handling the modules, in Section 3.

Cables and connectors

The cables you require together with the length that can be ordered are listed in Section 6, Cables.

Jumperings

The jumperings (jumpers, switches, ...) mentioned in the following sections must always be open or closed, as specified.

Explanation of symbols:

- Jumper/switch open
- Jumper/switch closed or equipped with 0 resistor

Adhesive labels

The following adhesive labels can be attached to the modules:

- **Type plate** (on bus connectors)

Color: White

SIEMENS Made in Germany Fert.-Nr. 222	Product version	A B C D E F G H
	570 320.9001.	00 01 02 03 04 05 06 07

or



SIEMENS Made in Germany 730 695	Product version	A B C D E F G H
	570 320.9001.01	J K L M N P Q R

or other formats

Example:	Internal components	570 320.9001.01	} Must always be specified with technical enquiries!
	or item number:	(last cross)	
	Product version:	E (last cross)	
	Production number:	222	

- **Label** (on frontplate, with order no.)

Color: Brown

	or		Must always be specified with technical enquiries!
---	----	---	---

Module type: Where submodule has EPROM fitted and programmed at factory, information is given about the software used.

- **Product version**

Component product version according to the PRODOK version in the PRODOK List of Alterations and Order No.

Color: Light beige



- **Test mark**

Color: Blue, red or green



- **Inspection mark**

Color: White



- **ESD symbol**

Color: Black/yellow

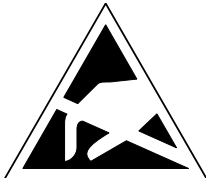

	CAUTION
	The module includes electrostatically sensitive devices (ESD) . Please observe the protective measures specified in Section 3, Electrostatically sensitive devices (ESD).

- **Layout of barcode labels**

Type and barcoder label 462008.0128.50
 Dimensions 46 x 38 mm

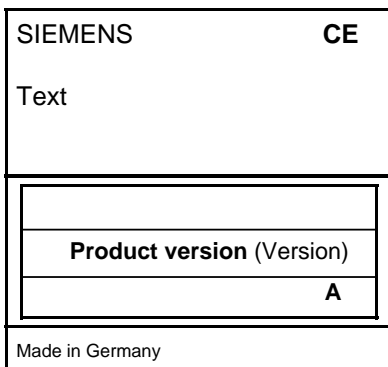

Order No. (20 digits, single line, barcode with text)
 This number is used when ordering a component listed in our planning and ordering data.

Unique item No. (19 digits, single line, barcode with text)
 Unique production serial number

Component No. (12 digits, single line, barcode with text)
 Internal component number

Barcode label 462008.0343.00
 Dimensions 46 x 17 mm

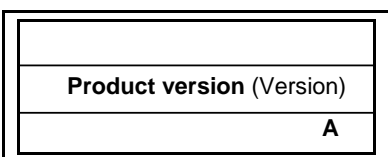

Component product version:
 (version, 1 or 2 characters)
 Indicates the component version (according to the PRODOK version in the PRODOK List of Alterations).
 If changes are made to the component a superscript is added depending on the extent and effect of the changes.
 This index superscript does not indicate the index version of the drawings and part lists.

Total current (see Section CPU modules and others)

The current drawn at different voltages is given for each central controller component (module internal consumption only) in a table ("Total current").

The table also gives the maximum current which can be drawn at the external interfaces (e.g. for encoder).

Using the values given in the table for the current input of the central controller components and the actual current input at the external interfaces, it is possible to determine the actual connected load and power loss of the control. For this, use the tables in Section 3, Connected load and power loss calculation.

	CAUTION
	<p>The maximum permissible current withdrawal from external interfaces refers only to the module itself and not to any components connected to it (e.g. power supply unit or external components).</p> <p>The supply voltage outputs at the external interface are not short-circuit proof and not provided with any fuses.</p>

	WARNING
	<p>The capacitive circuitry of the outputs only compensates for the inductances of the connected cables.</p> <p>If contactors, relays, valves etc. are connected, then additional interference suppression (e.g. RC circuits, free-wheeling diode) must be connected in parallel to these inductive loads (DIN IEC 550 / DIN VDE 0113, Part 200).</p> <p>Non-compliance can result in damage to the outputs.</p> <p>Exceptions (e.g. DP compact module) are documented.</p>

2.2 Operator unit components

2.2.1 14" color screen

6FC5 103-0AB 1-0AA

2.2.1.1 Configuration

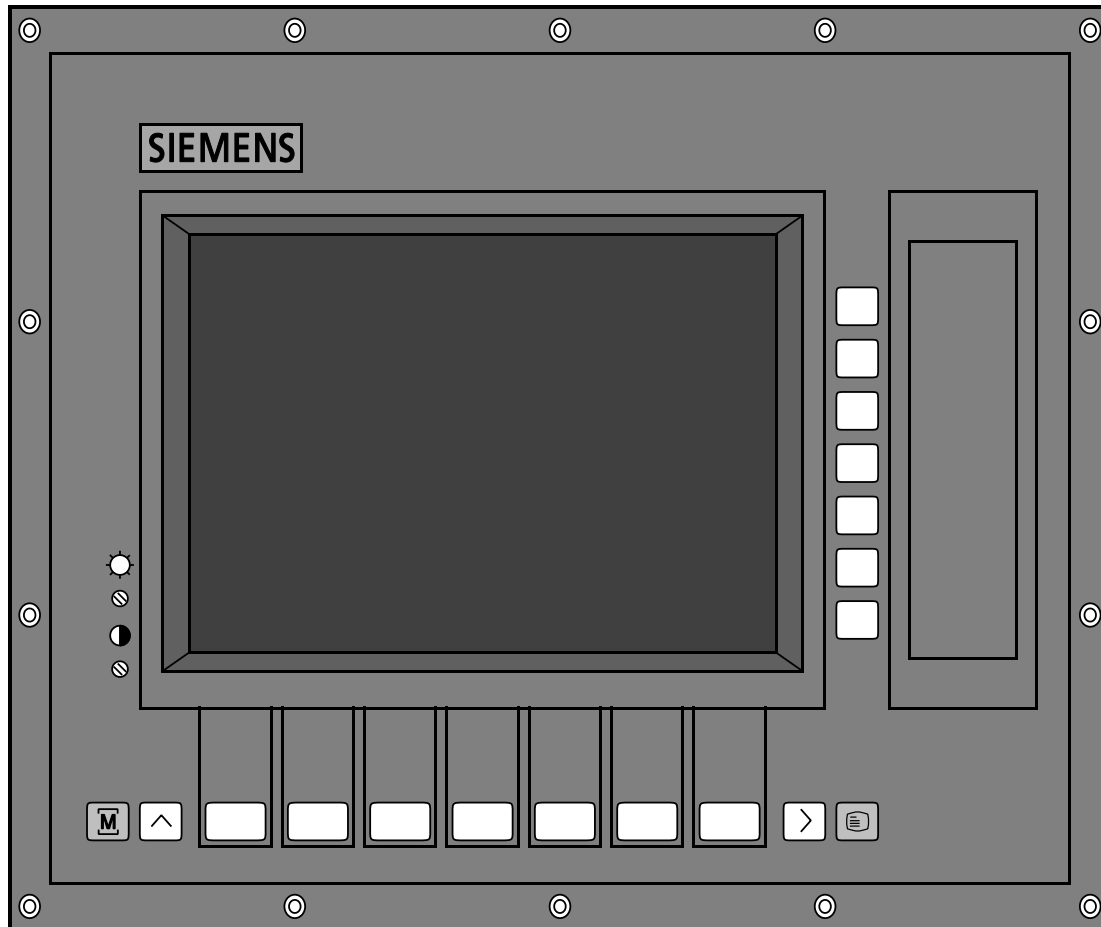

This unit incorporates the following:

- 14" CRT monitor (color); visible display 240 x 180 mm
- Softkey bars (horizontal/vertical)
- Rotary dimmer (brightness/contrast)
- NC keyboard interface
- Blanking plate for optional diskette drive FD E2 (not with 6FC5 103-0AB 1-0AA0)
- Pack of US keys for replacement (as from 12.95)

Adjusting facility for brightness and contrast

Contrast and brightness can be adjusted from the front with a screwdriver.

2.2.1.2 Location of interfaces and operator control and display elements

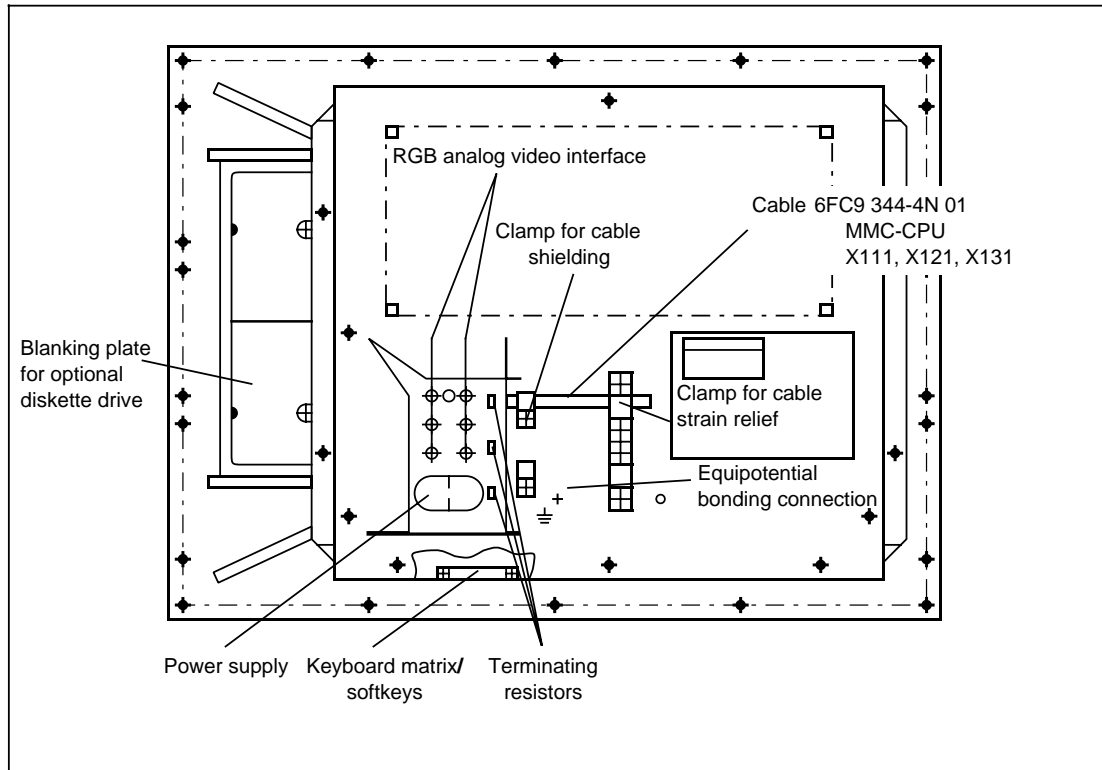

The interfaces are located at the rear of the unit:

- X12 Keyboard matrix/softkeys
- RGB analog video interface
- \equiv Equipotential bonding connection
- 230 V AC power supply

Control elements:

- Terminating resistors

	CAUTION
	High voltage of approx. 16 kV in monitor unit, at high-voltage transformer, at anode line and anode connection of picture tube.

Note:

The X-rays produced in the monitor are sufficiently shielded by an "intrinsically safe cathode ray tube". The maximum beam potential is < 30 kV.

Interface keyboard matrix/softkeys

Connector designation: **X12** softkeys

Connector type: Ribbon cable connector DIN 41651, 20-pin

A ribbon cable with 3 ribbon cable connectors is part of the scope of supply of the 14" color screen.

- Total length of ribbon cable: 540 mm
- Length between:
 - X12 (14" color screen) and X111 (NC key panel): 260 mm
 - X111 (NC key panel) and X231 (key interface): 280 mm

RGB analog video interface

Connector designation: **X211** red
X221 green/BAS
X231 blue

Connector type: BNC sockets

The monitor contact is designed as RGB analog video interface. The cable is to be mounted below the cable clamps at the monitor rear panel.

Terminating resistors

Designation: 3 x 75 Ω /high-impedance (75/H)

Note:

The 3 terminating resistors of the monitor are set to 75 Ω in the factory.

**2.2.2 19" operator panel with 10.4" display
(replacement part for operator panel with 14" screen)
6FC5 103-0AB01-0AA2**

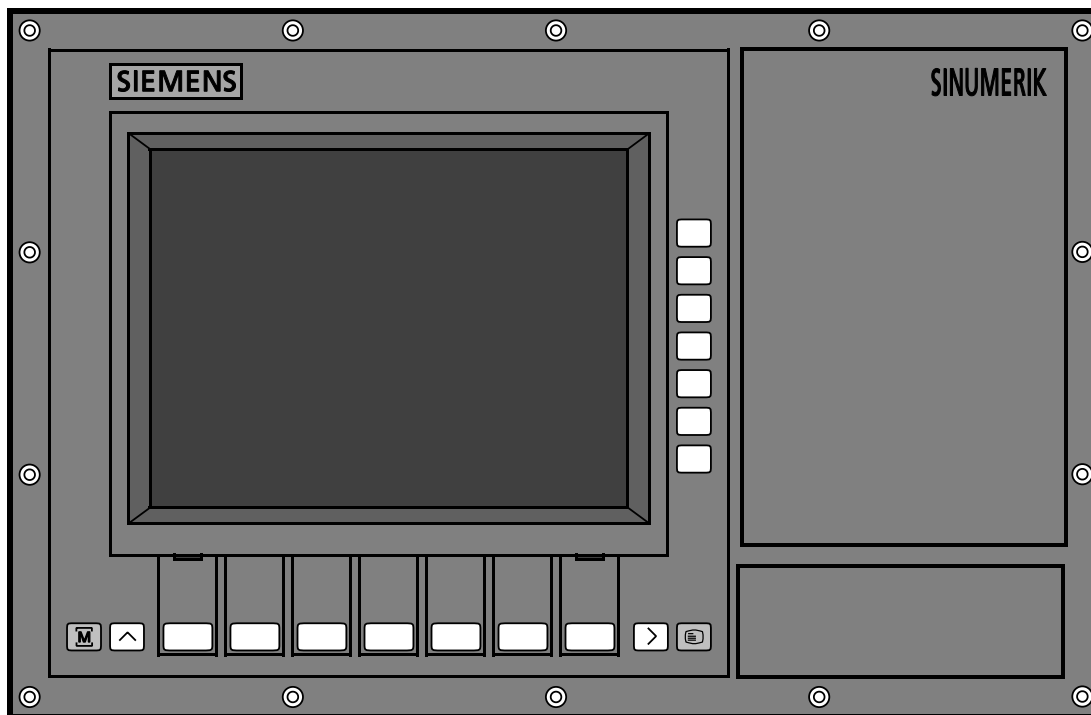

The operator panel incorporates the following:

- Flat display 10.4" (visible screen: 211 x 158 mm)
- Softkey bars
- Operator panel electronics with power supply
- Blanking plate for optional diskette drive FD-E2
- Pack of US keys for replacement

Note:

Caused by the manufacturing process, the displays might occasionally show defective pixels. It can be a maximum of 10 light and 10 dark pixels, but within a circle of 10 mm diameter it can be a maximum of 5 defects only. Less defects do not give reason for complaint.

2.2.2.1 Location of interfaces, operator control and display elements

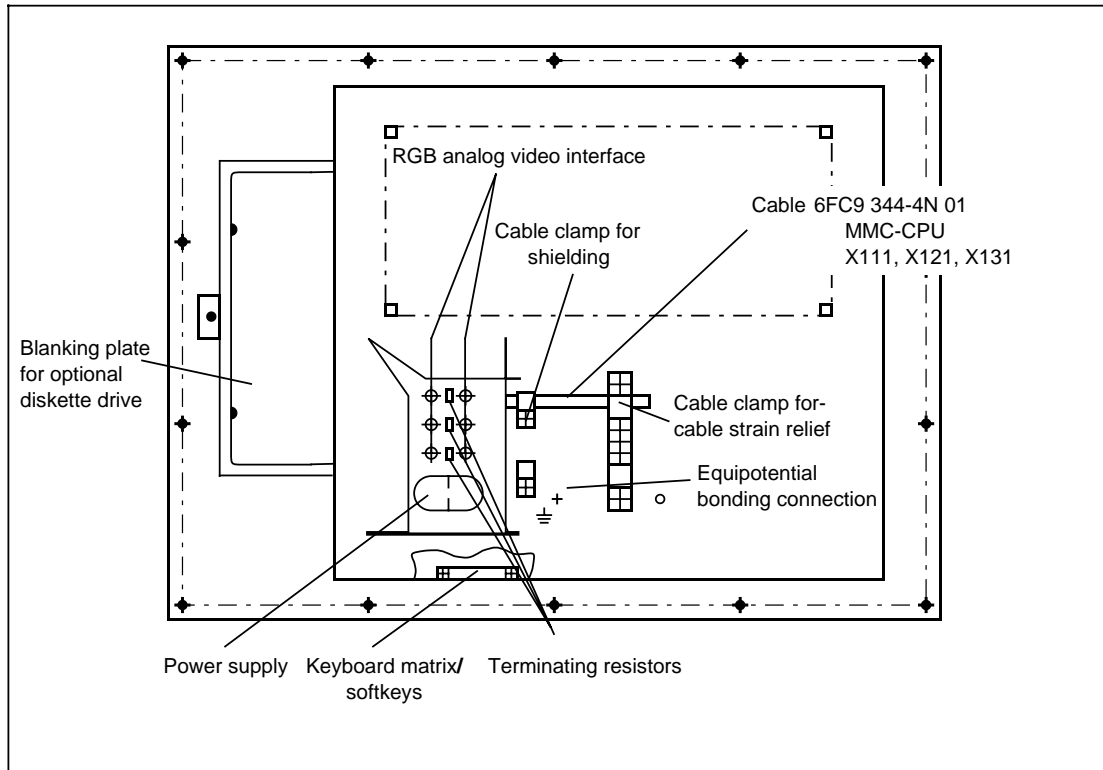

The interfaces are located on the rear of the interface unit:

- X12 Keyboard matrix/softkeys
- RGB analog video interface
- \perp Equipotential bonding connection
- 230 V AC power supply
- Terminating resistors

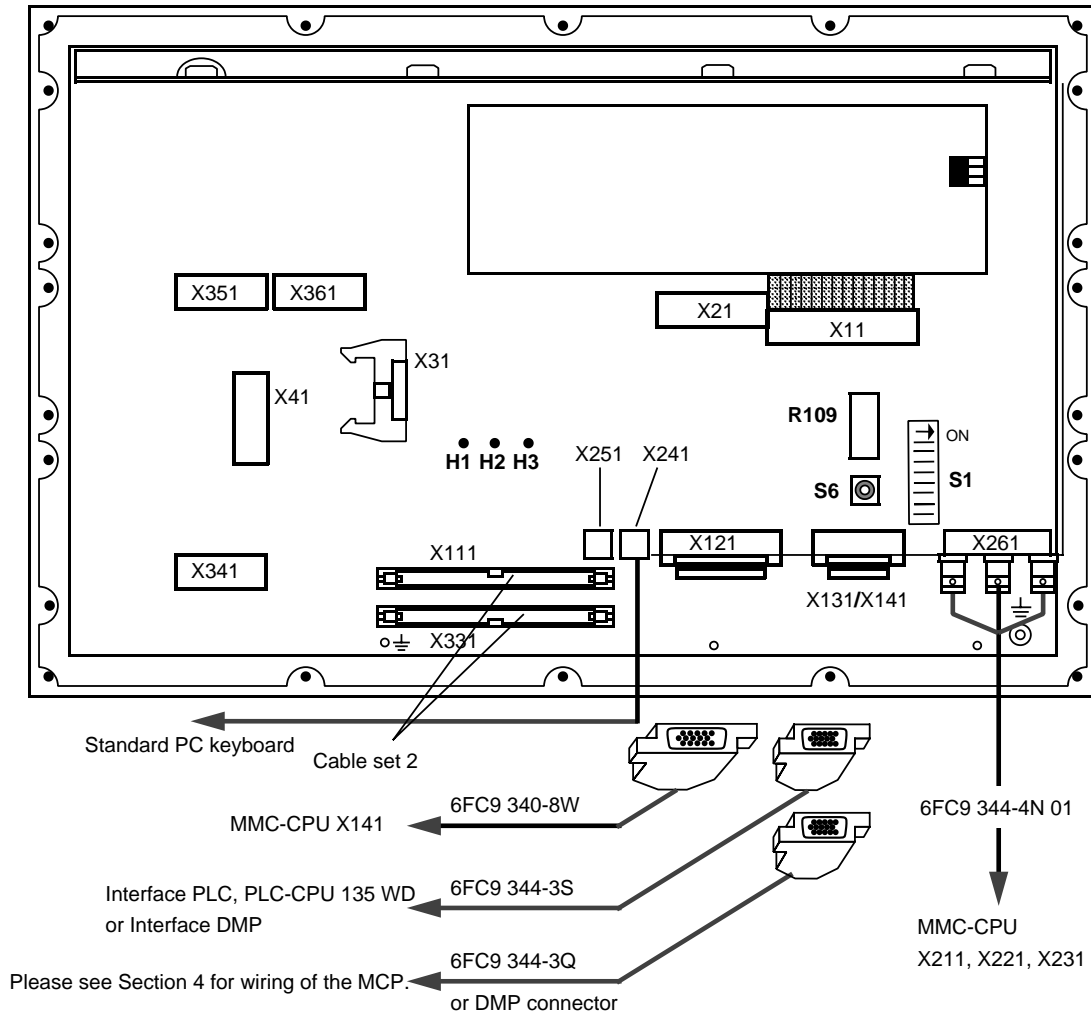
Depiction without interface unit:

The interfaces are located on the rear of the operator panel interface:

- X11 interface to power supply unit
- X21 interface to NC keyboard
- X31 interface to softkey bar
- X41 interface to display
- X111 interface to MCP (not used)
- X121 serial interface RS 232 (not used)
- X131 RS-485/MPC interface 1
- X141 RS-485/MPC interface 2
- X211 RGB analog video interface red (not used)
- X221 RGB analog video interface green/composite video signal (not used)
- X231 RGB analog video interface blue (not used)
- X241 interface to standard PC keyboard (not used)
- X251 interface to standard PC keyboard (mini DIN socket) (not used)
- X261 VGA interface (linked to connection board)
- X331 interface to MCP
- X341 interface to backlight
- X351 interface to backlight
- X361 interface to power supply for backlight
- \perp 230 V AC power supply (connected to rear wall)
- \perp Equipotential bonding connector (not used)

The operating elements are located on the rear of the operator panel interface:

- S1 DIP switch
- S6 Rotary switch (not used)
- R109 Potentiometer for power factor adjustment

On the front:

- Key combination for adjusting the image position
- Key combination for adjusting the brightness

RGB analog video interface (connection board)

Connector designation:	Operator panel interface X3-X8
	X3, X6 red
	X4, X7 green/composite video signal
	X5, X8 blue
Connector type:	BNC sockets

The connection is compatible to 14" color screens.

Interface keyboard matrix/NC keyboard

X12 is compatible to 14" color screens.

Settings/adjustments

Coding switch S1

By setting the coding switch S1, the following configurations are determined:

1. Selection of the SINUMERIK, to which the operator panel is connected
2. Adaptation of the video timing
3. Distinction between internal and external CNC keyboard

Coding switch S1 - switch no. 1

ON position: Operation with RS422 adapter
 OFF position: Operation without RS422 adapter not possible (standard setting)

Coding switch S1 - switch no. 2 and 3

Selection of the SINUMERIK, to which the operator panel is connected:

1	2	3	4	5	6	7	8	SINUMERIK	Flat display	Mode
	OFF	OFF	OFF					840C	10.4" color	VGA*
	ON	OFF	OFF					840	10.4" color	VGA*
	OFF	ON	OFF					805	10.4" color	VGA*
	ON	ON	OFF					880	10.4" color	VGA*
	OFF	OFF	ON					840C	10.4" color	RGB
	ON	OFF	ON					840	10.4" color	RGB
	OFF	ON	ON					805	10.4" color	RGB
	ON	ON	ON					880	10.4" color	RGB

Standard
setting

* For service purposes only

Coding switch S1 - switch no. 4

RGB/BGA switchover:

The switch is principally in "ON" position.

Coding switch S1 - switch no. 5

ON position: operation with external keyboard interface and NC keyboard (standard setting)
 OFF position: no operation with external keyboard interface and NC keyboard (screen merely to be used for observation without any operating function)

Coding switch S1 - switch no. 6, 7 and 8

If several operator panels are connected in series, the terminating resistors of the last operator panel (as seen from the MMC CPU) must be active and the corresponding switches must be in the ON position. The operator panels connected in front of it, must have inactive terminating resistors.

Switch S1 with switch nos. 6, 7 and 8 must be in the "OFF" position (standard setting).

The terminating resistors are set with the three switches S7, S8 and S9 on the connection board (on the rear of the operator panel).

Switches S7, S8 and S9, position 1 (75): terminating resistors
Switches S7, S8 and S9, position 2: no terminating resistors

Coding switch S6

Serves for setting the DMP node nos. 1 through 15 (not used).

Summary of the standard settings made by the manufacturer:

- 19" operator panel with 10.4" display (replacement part for operator panel with 14" screen):

	1	2	3	4	5	6	7	8
Coding switch S1	OFF	OFF	OFF	ON	ON	OFF	OFF	OFF
Coding switch S6	E							









Coding switch S7, S8, S9 on connection board: all in position 1 (terminating resistors)

R109 potentiometer









The potentiometer is used to adjust the image definition of vertical edges.

Setting the image position and brightness

The image position can be adjusted via 4 key combinations on the CNC keyboard

Image up			<Toggle> + <Cursor home>
Image down			<Toggle> + <Cursor end>
Image to the right			<Toggle> + <Cursor right>
Image to the left			<Toggle> + <Cursor left>

The brightness of the screen can be increased or decreased via two key combinations on the CNC keyboard or the softkey bar.

Increase whiteness			<Toggle> + <Cursor up> or
			<Operating area> + <Recall>
Decrease whiteness			<Toggle> + <Cursor down> or
			<Operating area> + <Menu continuation>

Caution:

The key combinations are transferred to the MMC and evaluated according to their function. Therefore, the adjustment of the screen position and brightness should be made in the basic display of the machine.

Backlight switch-off

In order to achieve a maximum service life of the backlight, it should be left switched off for at least 1 hour. Turning it darker for less than 1 hour will not increase the service life.

a) Switch off backlight



<Shift> + <Actual value display>

The information "backlight switched off" will be transferred to the MMC

b) Switch off backlight



<Operating area> + <Machine>

The information "backlight switched off" will not be transferred to the MMC.

Backlight switch-on

Pressing any key of the alphanumeric keyboard, the backlight will be switched on again. The first pressing of a key to reactivate the screen will not be evaluated according to its function in the case of a), but only used to increase the brightness.

Caution:

In case of b), the corresponding key pressed will be evaluated.

Note:

See chapters 2.2.4.3.4 and 2.2.4.3.5 for change of image and backlight.

2.2.3 NC keyboard

6FC5 103-0AC -0AA

2.2.3.1 Structure

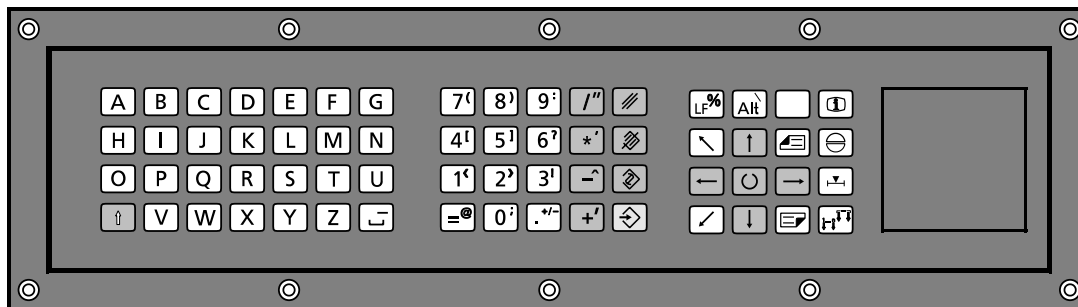

The NC keyboard requires 5 V DC. The NC keyboard is available with and without keyboard interface.

NC keyboard without keyboard interface

- 64 inputs (64 keys)
- Interface for keyboard interface

NC keyboard with keyboard interface

The NC KEYBOARD WITH KEYBOARD INTERFACE module consists of the following components:

- NC keyboard
- Keyboard interface (see "Keyboard interface" Section)

For operating the NC keyboard, a keyboard interface is necessary.

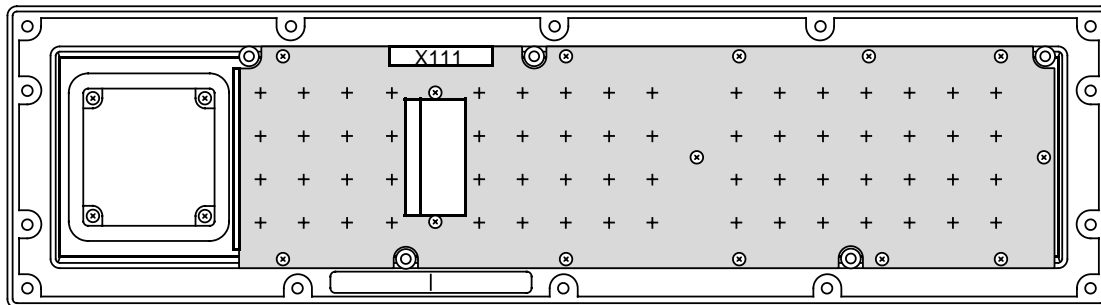
2.2.3.2 Location of interfaces and operator control and display elements

The interface is located at the rear of the NC keyboard (without keyboard interface):

- X111 Interface to keyboard matrix/softkeys

Interface keyboard matrix/softkeys

Connector designation: **X111** softkeys

Connector type: Ribbon cable connector DIN 41651, 20-pin

The 14" color screen is connected via the interfaces:

NC key panel X111 X12 14" color screen

NC key panel X111 X231 Keyboard interface

The cable required is part of the scope of supply of the 14" color screen.

2.2.4 Slimline operator panel

2.2.4.1 10" color/monochrome display 6FC5 103-0AB -0AA0

2.2.4.1.1 Configuration

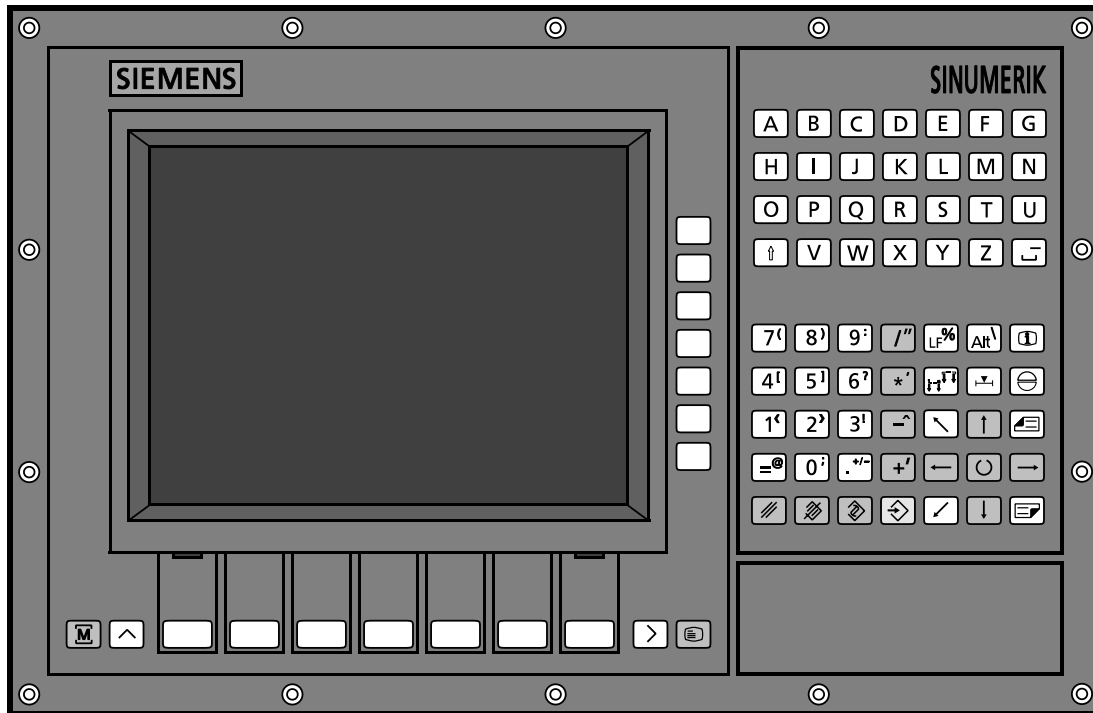

The slimline operator panel incorporates the following:

- 10" flat screen (visible display: 211 x 158 mm)
- NC keyboard
- Softkey bars
- Operator panel electronics with power supply
- Optional connection of a machine control panel without interface (see "Machine control panel" Section)

The operator panel interface is connected to the slimline operator panel as an active component. The design of the control panel interface is identical for the color and monochrome versions and features the following:

- Keyboard interface
- Video converter

The operator panel electronics enable the data entered via

- NC keyboard,
- softkeys
- full keyboard and
- machine control panel

to be assigned to the RS232C (V.24) interface and the RS-485/MPC interface.

Setting color or grey levels

The R43 potentiometer (see following hardware interface) is on the back of the flat screen for setting the color or grey levels.

Procedure:

- Search for a monitor display showing black areas.
- Turn the color down via the R43 potentiometer until the black areas become visible.

Note:

As from SW 4.7 a test pattern is available for white and phase adjustment (cf. Section 2.2.4.2.3, Adjustment with test pattern).

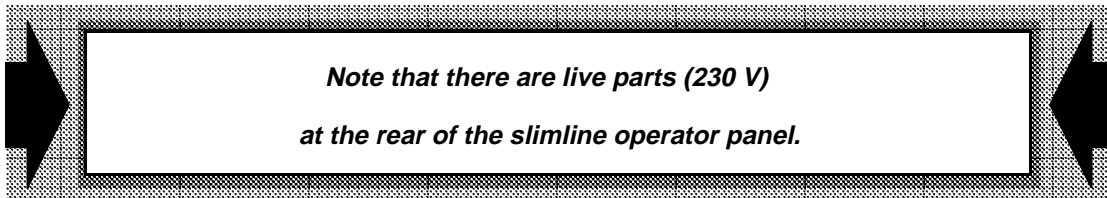

2.2.4.1.2 Location of interfaces and operator control and display elements

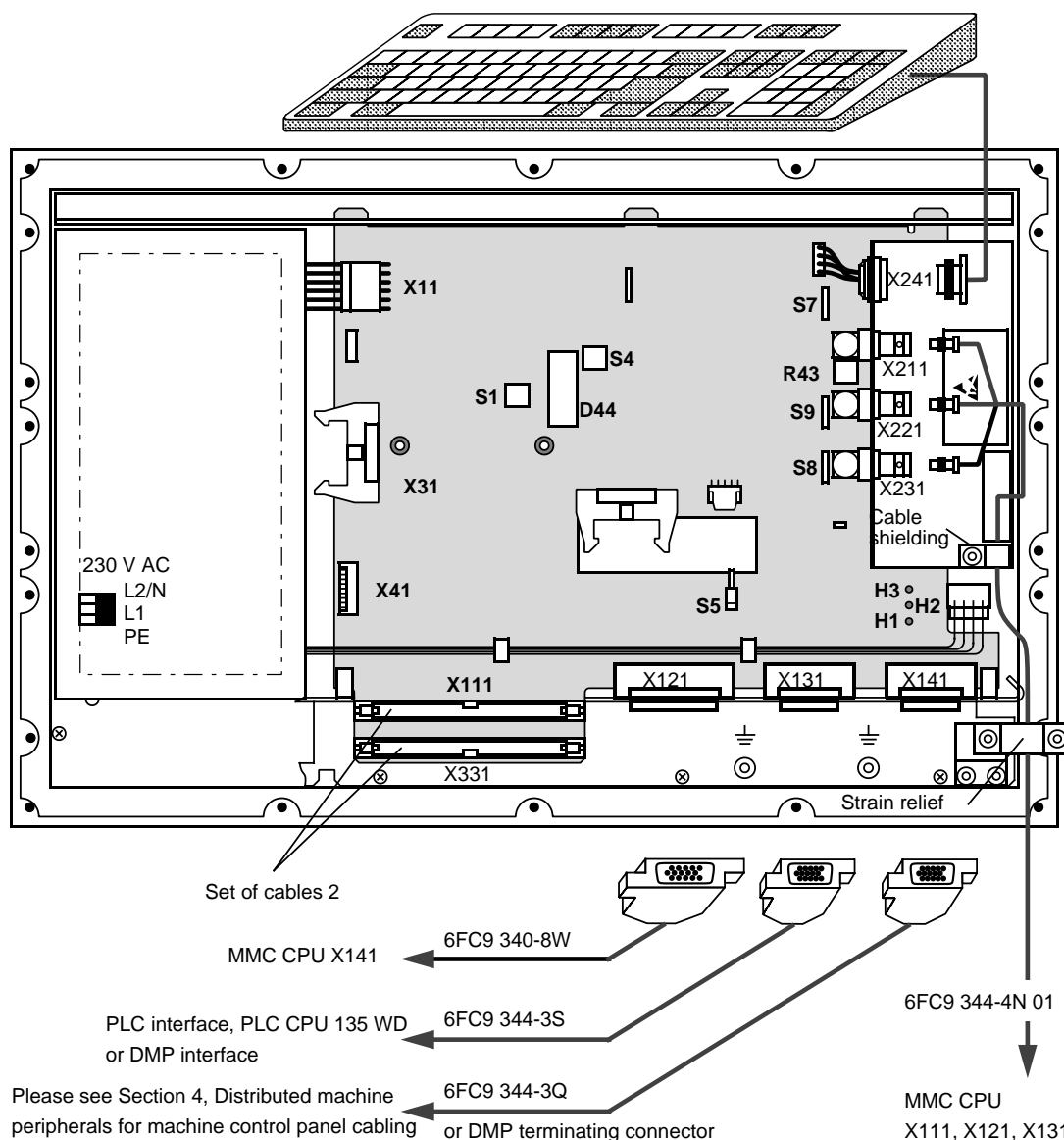

The following interfaces are located at the back of the operator panel interface:

- X111 Interface to machine control panel
- X121 Serial interface RS232
- X131 RS-485/MPC interface 1
- X141 RS-485/MPC interface 2
- X211 RGB analog video interface, red
- X221 RGB analog video interface, green/BAS
- X231 RGB analog video interface, blue
- X241 Interface to PC standard keyboard
- X331 Interface to machine control panel
- D44 EPROM location
- 230 V AC power supply
- ⚡ Equipotential bonding connection

Display elements:

- H1, H2, H3 RGB analog video interface

Control elements:

- S1 Rotary switch
- S4 Rotary switch
- S5 RESET pushbutton
- S7, S8, S9 Jumpers (must be closed to terminate the RGB signal)
- R43 Potentiometer for analog level of RGB signal

Interface to machine control panel

Connect the interfaces by means of the ribbon cables 6FC5 147-0AA04-0AA0 (see Section 2, "Keyboard interface") (see Figure below):

Slimline operator panel	X111	X121	Machine control panel
Slimline operator panel	X331	X111	Machine control panel

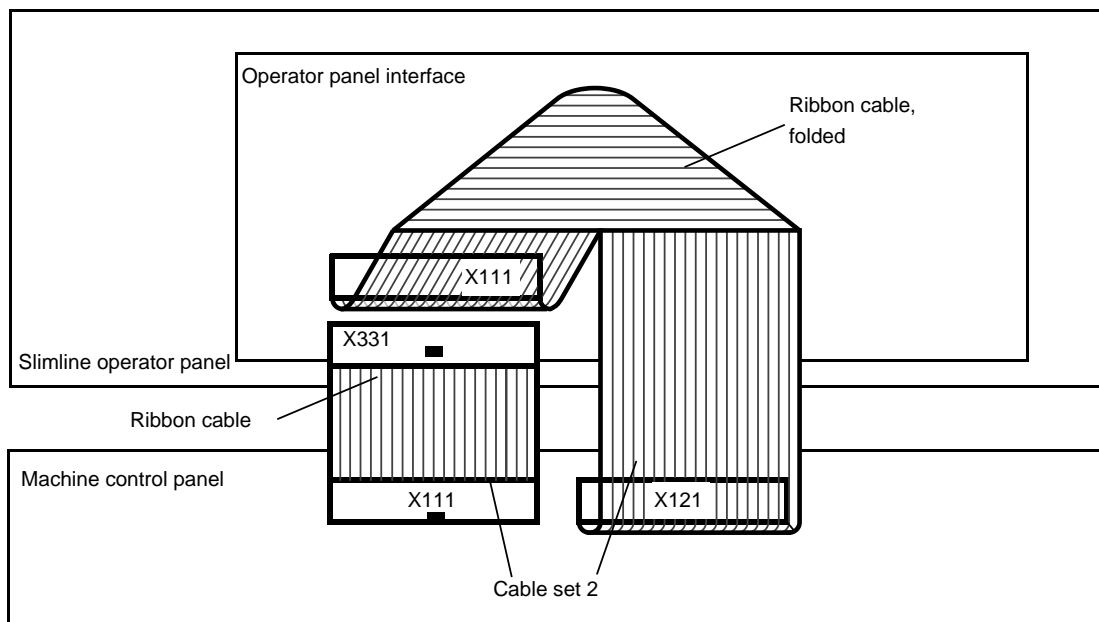

Connector designation: Operator panel interface **X111, X331**

Connector type: Flat connector DIN 41651, 64-pin

Pin assignment of X111 and X331:



The signal assignment of the pins is the same as for the keyboard interface:

Operator panel interface X111	keyboard interface X221 (observe locating lug)
Operator panel interface X331	keyboard interface X211

Note:

If you have a customized machine control panel please refer to Section 2, "Keyboard interface", for the required interface description.

Interface X111 of the operator panel interface corresponds to interface X211 of the keyboard interface. Interface X331 of the operator panel interface corresponds to X221 of the keyboard interface.

Serial interface RS232

Connector designation: Keyboard interface **X121**
Connector type: Sub-D socket connector, 25-pin

The operator panel interface handles transmission of the keyboard signals to the MMC and is designed as a serial interface in accordance with the RS232C (V.24) standard.

The pin assignment is described in Section 6, Cables.

RS 485/MPC interfaces 1 and 2

Connector designation: Operator panel interface **X131, X141**
Connector type: Sub-D plug connector, 15-pin

The interfaces are electrically isolated and designed in accordance with the RS 485 standard.

The pin assignment is described in Section 6, Cables.

RGB analog video interface

Connector designation: Operator panel interface **X211, X221, X231**
X211 Red
X221 Green/BAS
X231 Blue
Connector type: BNC sockets

The monitor connection is designed as RGB analog video interface.

Interface for PC standard keyboard

Connector designation: Operator panel interface **X241**
Connector type: DUP connector 76384-304, connected via cable with 5-pin DIN socket

It is possible to connect an additional MF-2 keyboard (AT keyboard) to the slimline operator panel via the X241 interface. The maximum possible baud rate of the MF-2 keyboard is 6400 baud.

The pin assignment is described in Section 6, Cables.

Note:

A PC standard keyboard can only be connected to interface X141 if the serial interface RS 232C (X121) is connected to the MMC CPU.

Display elements

The LEDs have the following meaning:

- H2 LED yellow
LED darkens if: Power supply drops below 4.75 V or RESET.
- H3 LED red
LED darkens if: Correct transmission to MPC
- H1 LED green
LED darkens if: No proper program execution (watchdog responds).

Control elements

- S1 Rotary coding switch
The following configurations are determined by setting the coding switch:

- Selection of the system to which the operator panel is connected
- Adaptation of video converter timing

S1 rotary switch position	System	Flat screen
4	SIN 840C	Monochrome
5	SIN 880 GA2	Monochrome
6	SIN 805/805SM	Monochrome
C	SIN 840C	Color
D	SIN 880 GA2	Color
E	SIN 805/805SM	Color

- S4 Rotary coding switch
For setting DMP station numbers 1 to 15.

Rotary switch position S4	DMP station number
E	1
D	2
C	3
⋮	⋮
2	13
1	14
0	15

Position "E" is preset for the first machine control panel in the standard machine data (see Interface Description, Part 1).

- S5 RESET pushbutton
Operation of the S5 pushbutton causes a reset of the operator panel electronics.
- R43 Potentiometer for the analog level of the RGB signal
Losses resulting from different cable lengths are compensated for with the aid of the potentiometer.

2.2.4.1.3 Replacing the backlight

The service life of the "backlight" of the 10" color slimline operator panel is approx. 5000 h. It should therefore be replaced after this period. This work should only be done by trained personnel. The handling regulations for electrostatically sensitive devices (ESD) must be observed.

If you want to exchange the fluorescent tubes for the backlight, you must disconnect the 10" color slimline operator panel from the machine.

Proceed as follows:

- Switch off the complete system, verify isolation from supply and protect against unauthorized power-up.
- Disconnect external connectors:
X111, X331, X121, X131, X141, X241, X211, X221, X231, two ground terminals and shielding
- Loosen 14 M4 screws at the operator panel front, remove operator panel and place it on a soft surface to prevent it from slipping or being tipped over.
- Pull out power cable and rubber piece sideways from sheet metal bracket
- Remove five M3 cross-recessed-head screws (see drawing below)

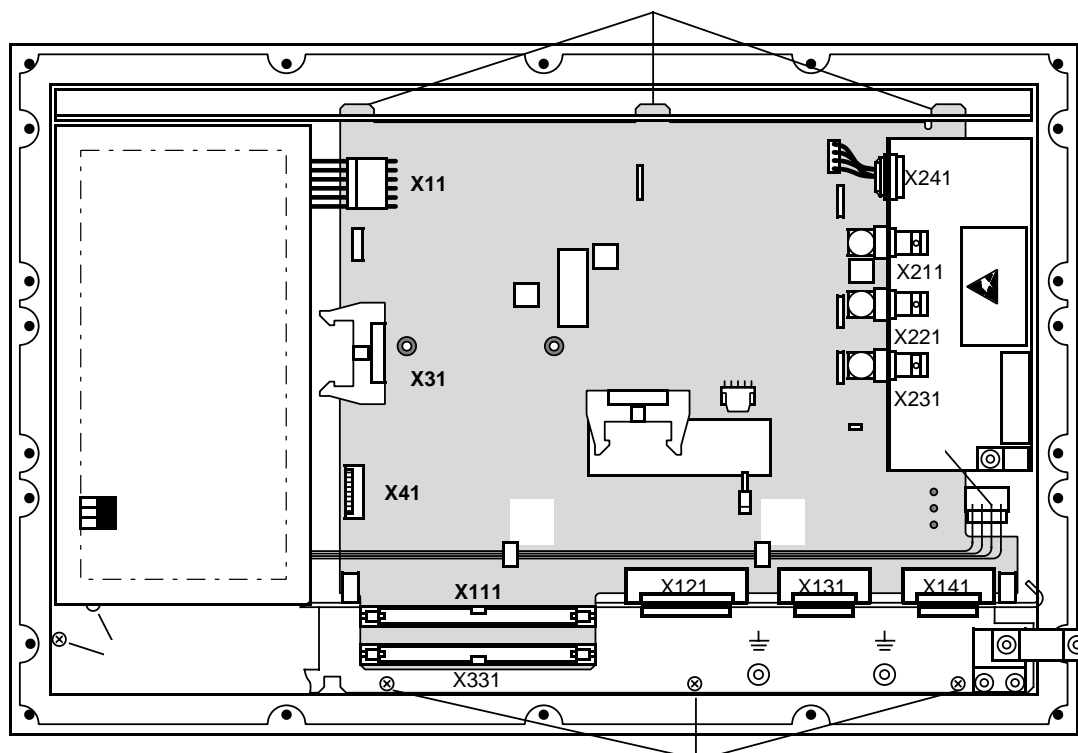

- Loosen internal connectors X21, X31 and X41.
- Pull module flat out of the slots towards the front and place it in a safe position.
- Loosen 2 ribbon cable connectors and put them on the left together with cable. Carefully remove cable from the guides .

- Push metal strips sideways out of the frame (see drawing below).
Use a screwdriver to lift up the metal strips over the locking hooks on the side.

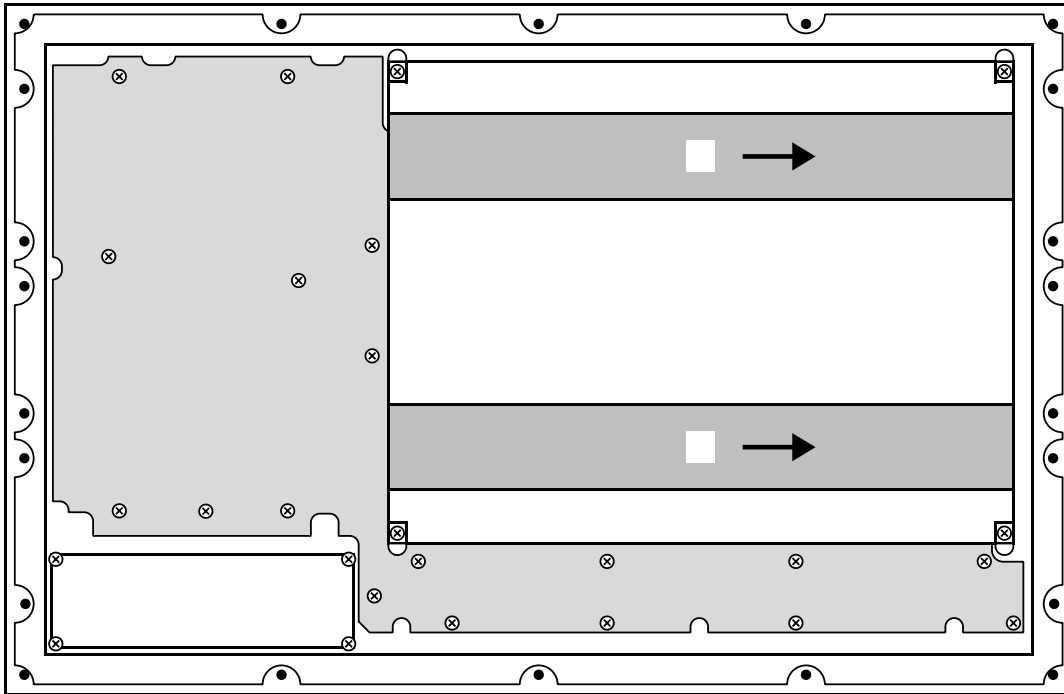

- Remove 4 black protective rubbers from the fluorescent tubes and pull off adhesive tape
- Pull out connector for the fluorescent tubes
Two locking hooks must be bent carefully together to the side.
- Remove cable carefully from the detent and take out fluorescent tubes

Note:

Fluorescent tubes require special waste disposal.

- Take replacement fluorescent tubes out of the package

Note:

The fluorescent tubes have prefabricated connecting cables with different lengths. The enclosed replacement cables are not required.

- First install the fluorescent tube with the short cable as follows:
 - Press ribbon cable connector into the guide (make sure that it snaps into place)
 - Press cable into the guide (white cable first)
 - Insert fluorescent tube
- Install fluorescent tube with long cable
- Insert 2 ribbon cable connectors into the plug-in contacts of the fluorescent tubes (yellow cable pointing outwards)
- 4 black protective rubbers, fix two onto each tube and attach new adhesive tape
- Slide metal strips sideways into the frame (white side facing downwards) until locking hooks latch on both sides

- Attach internal connectors X21, X31 and X41
- Insert power cable and rubber piece sideways into the sheet metal bracket

Note:

Ribbon cable connectors must snap into place completely.

- Fix cable in the guides
- Insert module into the holes so that it is in its proper position and fix it by means of five M3 cross-recessed-head screws M3 .
- Mount external connectors:
X111, X331, X121, X131, X141, X241, X211, X221, X231, two ground terminals and shielding
- Put operator panel back into its place and fix it by means of 14 M4 screws at the operator panel front.
- Switch on system and check operability.

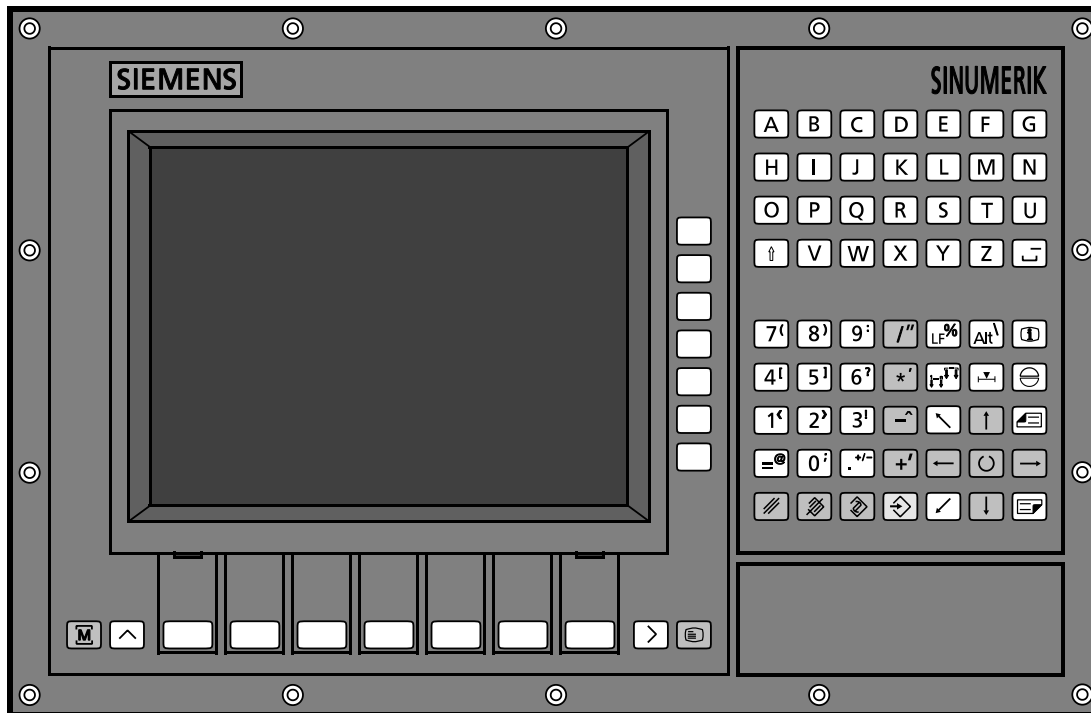
2.2.4.2 9.5" color/monochrome display 6FC5 103-0AB - AA**2.2.4.2.1 Configuration**

The slimline operator panel incorporates the following:

- 9.5" flat screen (visible display: 192 x 144 mm)
- NC keyboard
- Softkey bars
- Operator panel electronics with power supply
- Optional connection of a machine control panel without interface (see "Machine control panel" Section)
- Optional connection of an MF keyboard

The operator panel interface is connected to the slimline operator panel as an active component. The design of the operator panel interface is identical for the color and monochrome versions and features the following:

- Keyboard interface (as 24 V DC or 230 V AC version)
- Video converter

The operator panel electronics enable the data entered via the

- NC keyboard
- softkeys
- full keyboard and
- machine control panel



to be assigned to the RS 232 C interface and the RS 485/MPC interface.

Setting color intensity (white balance on the color slimline operator panel)

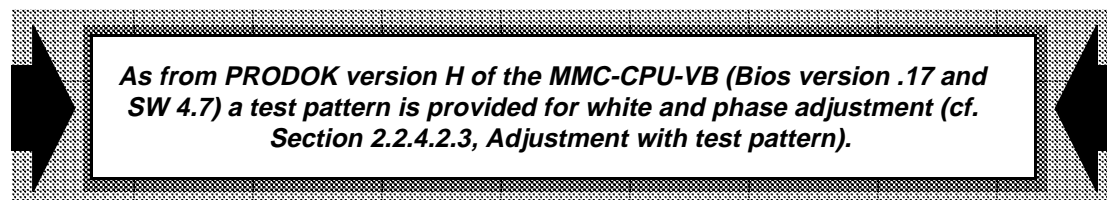
Potentiometers R306-R308 (see following hardware interface) located at the rear of the slimline operator panel are used for setting the color intensity.



Setting the contrast (slimline operator panel only)

The contrast of the LCD display can be adapted to the surrounding conditions by simultaneously pressing the keys SELECT  and CURSOR UP  or CURSOR DOWN .

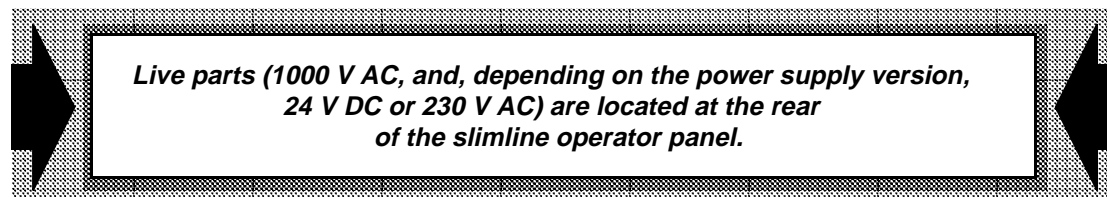

2.2.4.2.2 Position of the interfaces, operator control and display elements

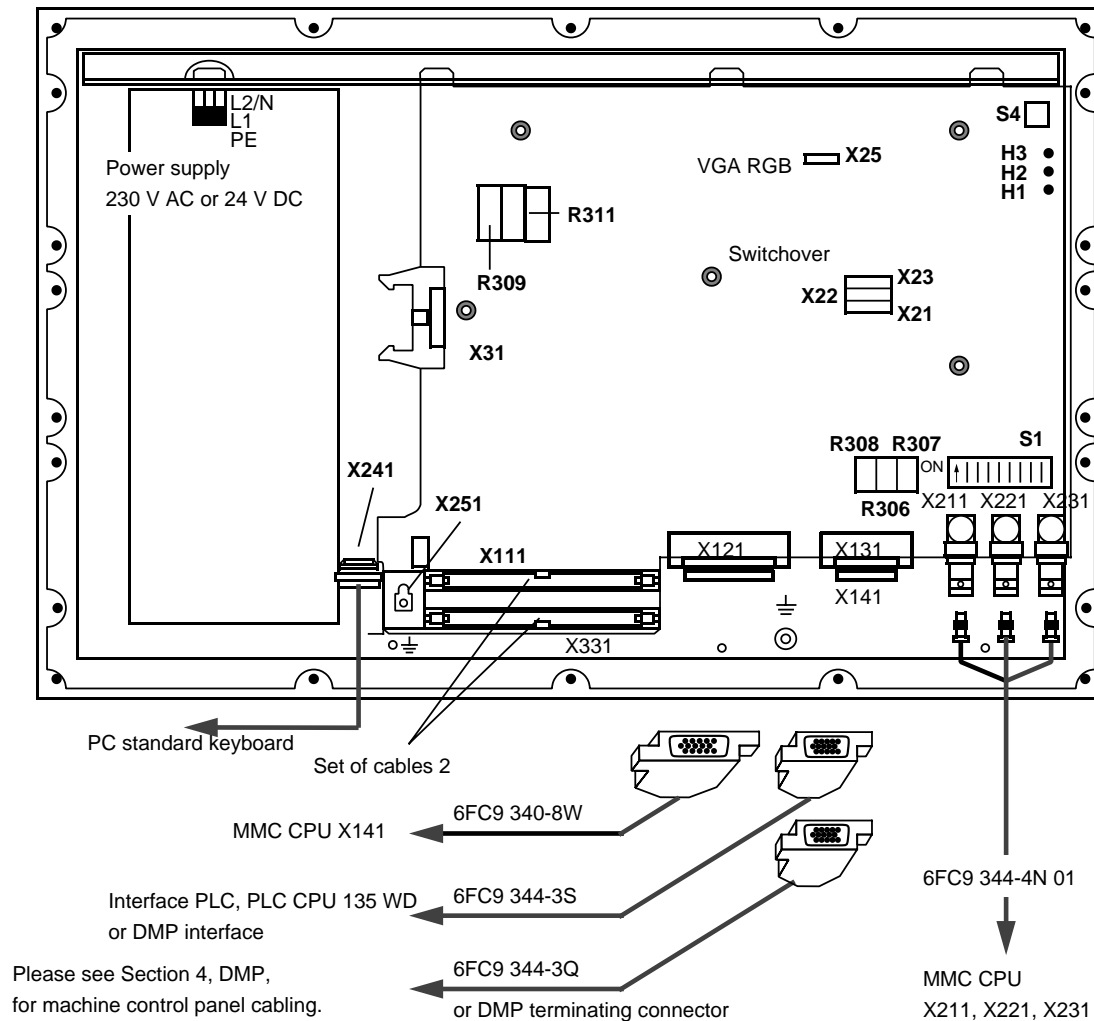

The following interfaces are located on the back of the operator panel interface:

- X111 Interface to machine control panel
 - X121 Serial interface RS 232
 - X131 RS 485/MPC interface 1
 - X141 RS 485/MPC interface 2
 - X211 RGB analog video interface, red
 - X221 RGB analog video interface, green/BAS
 - X231 RGB analog video interface, blue
 - X241 Interface to PC standard keyboard
 - X251 Interface to PC standard keyboard (mini DIN socket)
 - X261 VGA interface (only on color slimline operator panel)
 - X331 Interface to machine control panel
 - 230V AC / 24V DC power supply
 - ⏏ Equipotential bonding connection
- } double connector

Display elements:

- H1, H2, H3

and the control elements:

- X25, X23, X22, X21 VGA RGB switchover
- S1 DIP switch
- S4 Rotary switch
- R306-R308 Potentiometer for setting the color intensity
- R311, R309 Potentiometer for adjusting the focus

Interface to machine control panel

Connect the interfaces using the ribbon cables 6FC5.... (see Section 2, Keyboard interface). (see Figure below):

Slimline operator panel	X111 X121	machine control panel
Slimline operator panel	X331 X111	machine control panel

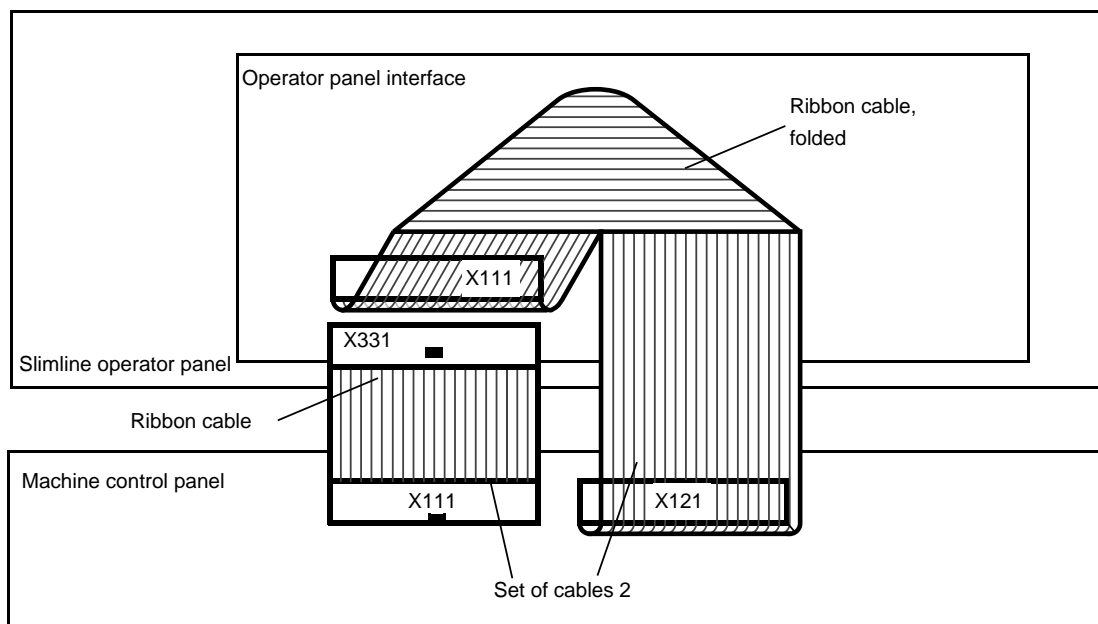

Connector designation: Operator panel interface **X111, X331**
 Connector type: Flat connector DIN 41651, 64-pin

Pin assignment X111 and X331:



The signal assignment of the pins is the same as for the keyboard interface:

Operator panel interface X111	Keyboard interface X221 (observe locating lug)
Operator panel interface X331	Keyboard interface X211

Note:

If you have a customized machine control panel please refer to Section 2, "Keyboard interface", for the required interface description.

Interface X111 of the operator panel interface corresponds to interface X211 of the keyboard interface. Interface X331 of the operator panel interface corresponds to X221 of the keyboard interface.

Serial interface RS232

Connector designation: Keyboard interface **X121**
Connector type: Sub-D socket connector, 25-pin

The operator panel interface handles transmission of the keyboard signals to the MMC and is designed as a serial interface in accordance with the RS232C (V.24) standard.

The pin assignment is described in Section 6, Cables.

RS 485/MPC interfaces 1 and 2

Connector designation: Operator panel interface **X131, X141**
Connector type: Sub-D plug connector, 15-pin

The interfaces are electrically isolated and designed in accordance with the RS 485 standard.

The pin assignment is described in Section 6, Cables.

RGB analog video interface

Connector designation: Operator panel interface **X211, X221, X231**
X211 Red
X221 Green/BAS
X231 Blue

Connector type: BNC sockets

The monitor connection is designed as RGB analog video interface.

VGA interface

The VGA interface is used for connection to a standard VGA interface on an external PC.

Note:

This interface is only used for service purposes.

The EMC limit values as stated in Section 3.1.3, Electromagnetic compatibility have not been checked.

This interface cannot be operated at the same time as the BNC inputs of the RGB analog video interface.

Connector designation: Operator panel interface X261
Connector type: Sub-D socket connector, 15-pin

Assignment of X261:

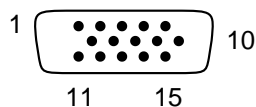

Signal assignment:

1:	red		analog red
2:	green		analog green
3:	blue		analog blue
13:	H_SYNC		horizontal sync
14:	V_SYNC		vertical sync
5-8:	MANA		analog ground
10:	MANA		analog ground

Signal type:

I Input

Interface to PC standard keyboard

Connector designation: Operator panel interface **X241**
Connector type: DUP connector 76384-304, connected via cable with 5-pin DIN socket

or

Connector designation: Operator panel interface X251
Connector type: 6-pin mini DIN socket

It is possible to connect an additional PC standard keyboard (MF 2) with special NC keys to the slimline operator panel via the interface X241 or X251. The maximum possible baud rate of the MF 2 keyboard is 6400 baud.

Note:

PC standard keyboard 6FC5 103-0AC03-0AA0 can only be connected to interface X241 or X251 if the serial interface RS 232C (X121) is connected to the MMC CPU.

Display elements

The LEDs have the following meaning:

H2	LED yellow	
	LED darkens if:	Power supply drops below 4.75 V or RESET.
H3	LED red	
	LED darkens if:	Correct transmission to MPC
H1	LED green	
	LED darkens if:	No proper program execution (watchdog responds).

Operator elements

S1 DIP switch

The DIP switch is used to select the system to which the monitor panel is to be connected.

The following settings can be made:

1	2	3	4	5	6	7	8	System	Flat screen
1)	OFF	OFF	OFF	OFF	2)			Reserved	Monochrome
	ON	OFF	OFF	OFF				Reserved	Monochrome
	OFF	ON	OFF	OFF				Reserved	Monochrome
	ON	ON	OFF	OFF				Reserved	Monochrome
	OFF	OFF	ON	OFF				SINUMERIK 840C	Monochrome
	ON	OFF	ON	OFF				SINUMERIK 840	Monochrome
	OFF	ON	ON	OFF				SINUMERIK 805	Monochrome
	ON	ON	ON	OFF				SINUMERIK 880	Monochrome
	OFF	OFF	OFF	ON				Reserved	Color
	ON	OFF	OFF	ON				Reserved	Color
	OFF	ON	OFF	ON				Reserved	Color
	ON	ON	OFF	ON				Reserved	Color
	OFF	OFF	ON	ON				SINUMERIK 840C	Color
	ON	OFF	ON	ON				SINUMERIK 840	Color
	OFF	ON	ON	ON				SINUMERIK 805	Color
	ON	ON	ON	ON				SINUMERIK 880	Color

- 1) Position ON: Operation with RS422 adapter
Position OFF: No RS422 adapter operation possible
- 2) If several operator panels are connected in series, switch numbers 6, 7 and 8 of the last operator panel (as seen from the MMC-CPU) must always be in the ON position.
For the operator panels connected in front of it, switch numbers 6, 7, and 8 must be in the OFF position.
ON position: Terminating resistor for 6 - RED, 7 - GREEN, 8 - BLUE exists
OFF position: No terminating resistor for 6 - RED, 7 - GREEN, 8 - BLUE exists

S4 Rotary switch

Used to setting DMP station numbers 1 - 15.

Rotary switch position S4:	E	D	C	2	1	0
DMP station number:	1	2	3	13	14	15

Position "E" is assigned to the 1st machine control panel in the standard machine data (see Interface Description, Part 1, Signals).

R306, R307, R308 Potentiometer

The color intensity can be set with the potentiometers.

R306: GREEN R307: BLUE R308: RED

(see Section 2.2.4.2.3, Adjustment with test pattern)

R309, R311 Potentiometer

The focus at a vertical edge can be set using this potentiometer in graphic or text mode (see Section 2.2.4.2.3, Adjustment with test pattern)

X25, X23, X22, X21 VGA RGB switchover

The VGA RGB switchover only exists on the 9.5" color slimline operator panel. Before setting the mode, the cover must be removed from the slimline operator panel interface.

VGA mode:

RGB mode:

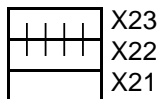
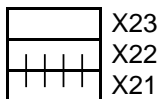
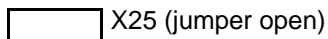
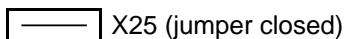

2.2.4.2.3 Adjustment with test pattern

Note:

Available from PRODOK version H of MMC-CPU VB (from Bios version .17 and SW 4.7)

The test pattern is used for

- white adjustment and
 - phase adjustment
- on slimline operator panels.

The test pattern is called on the SINUMERIK 840C under DIAGNOSIS, BACKUP in menu item 2:

Setup/Configure Options Adjust display.

The test pattern is displayed until the next key is pressed.

Display pattern structure

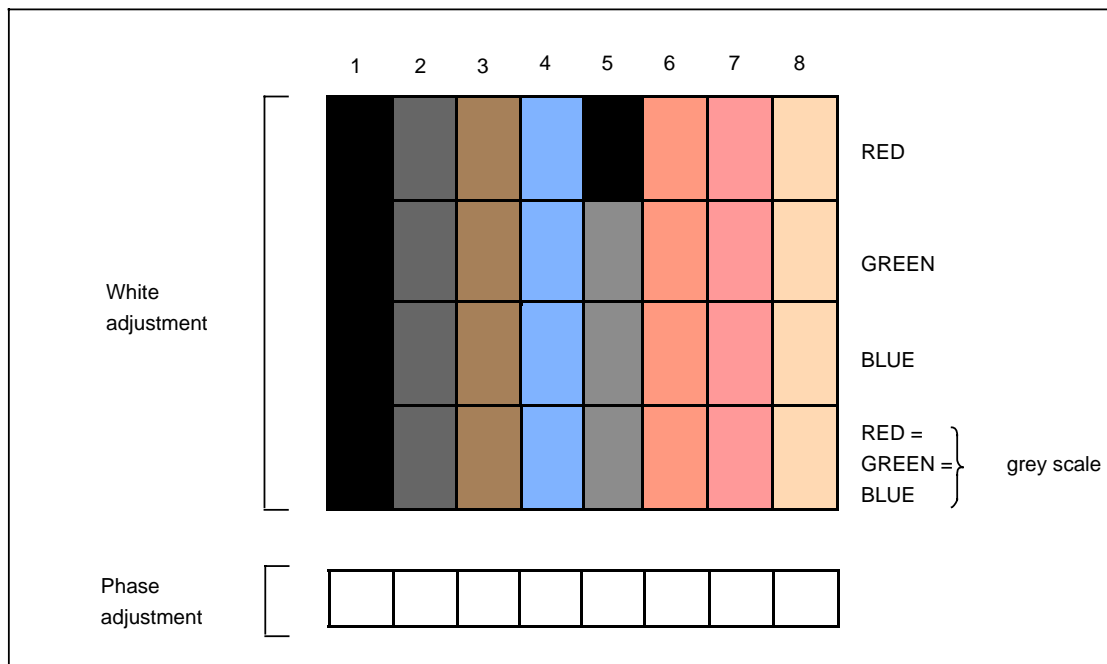

The test pattern shows five horizontal bars

The three horizontal color bars display the colors red, green and blue in 8 shades. The shades are numbered 1 (black) to 8 (full intensity).

The fourth horizontal column is a grey-scale, again in 8 shades.

The color bars together with the background color are used for white adjustment.

The lower white horizontal strip with the black vertical lines is used for phase adjustment.

White adjustment

- White adjustment for color slimline operator panel:

The intensity of the three colors are set one after the other with the potentiometers R 308 (red), R 306 (green) and R 307 (blue) in such a way that all 8 shades can be distinguished in the three upper color bars. The background color is used for fine adjustment. The intensity of the background color lies exactly on the quantization border between two shades. This intensity is not used on the user interface (for setting the CLUT values) and is only used for adjustment purposes! For fine adjustment, the potentiometers of the three colors are adjusted minimally - it must still be possible to distinguish between the 8 shades - until the "quantization noise" (slight flickering) is visible in the background in all three colors.

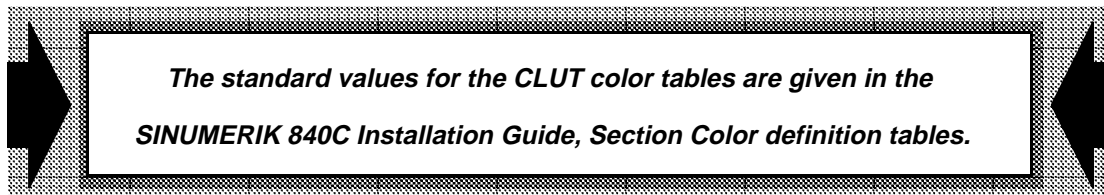

- Adjustment of the monochrome slimline operator panel with 8 grey scales:

Adjustment is performed as for the color slimline operator panel, but only potentiometer R 306 and the 2nd color bar (green) is used.

- Special cases:

- Adjustment of monochrome slimline operator panel with 4 grey scales (6FC5103-0AB 2- AA1) (POMOCLUT 4 grey scales or NEOCLUT 4 grey scales required):

The adjustment is made in the same way as on the monochrome slimline operator panel with 8 grey scales but with the difference that only four grey scales are visible in the 2nd color bar (green) and fields 1 and 2, 3 and 4, as well as 6 and 7 have the same intensity.

Again, the fine adjustment is made until the "quantization noise" is visible in the background.

- Adjustment of monochrome slimline operator panel with 8 grey scales for operation on a control that only uses 4 grey scales (POMOCLUT 4 grey scales or NEMOCLUT 4 grey scales required):

For the monochrome slimline operator panel version with 8 grey scales the color tables for the monochrome slimline operator panels with 4 grey scales cause problems because the test pattern is only partially suitable as an aid to adjustment of slimline operator panels on MMCs with 4 grey scales.

In such a case, the control should be switched over to 8 grey scales. If this is not possible (e.g. for some spare part supplies), the adjustment is initially performed as for the monochrome slimline operator panel with 8 grey scales. Then potentiometer R 306 is turned in the clockwise direction (display becomes brighter) until the "quantization noise" becomes visible in the 2nd color bar in field 7. The "quantization noise" may also be visible in fields 2 to 6 but not in the background.

Phase adjustment

The focus of the black vertical lines in the lower white bar can be set optimally using potentiometers R 309 and R 311.

If the RGB interface is used, R 311 is active, if the VGA interface is used (color version only), R 309 is used.

Special case

Operation of an old MMC-CPU (not version VB: order no.: 6FC5110-0DA0 -0AA0 and 6FC5110-0DB0 -0AA0):

Phase adjustment must also be performed for text mode. The focus must be adjusted on a display with text output, e.g. the backup menu. If the RGB interface is used, R 309 is active for the color version, for the monochrome version R 311 is active, if the VGA interface is used (color version only, 6FC5103-0AB 3- AA2), R 311 is active.

Overview of potentiometers used for phase adjustment:

Slimline operator panel version	Text mode	Graphic mode
Monochrome, 4 grey scales	Text mode not possible	R 311
Monochrome, 8 grey scales	R 311	R 311
Color, at RGB interface	R 309	R 311
Color, at VGA interface	R 311	R 309

The MMC-CPU, version VB always operates in the graphics mode regardless of whether the output display is text or graphics.

2.2.4.2.4 Replacing the display

The service life of the 9.5" slimline operator panel display is approx. 30 000 h in the case of the monochrome version and the color version. Replacing the display must be performed by trained personnel only. The handling regulations prescribed for electrostatic sensitive devices (ESD) must be followed.

Note:

Always remove the slimline operator panel from its installed location before replacing the display.

Depending on your slimline operator panel version, you will require one of the following displays for replacement:

- 9.5" monochrome display (order no.: 6FC5 247-0AA15-0AA0)
- 9.5" color display (order no.: 6FC5 247-0AA16-0AA0)
 - 1 backlight (order no.: 6FC5147-0AA00-0AA0)
 - 10 backlights (order no.: 6FC5147-0AA02-0AA0)

See Section 2.2.4.2.5 for replacing the backlight

Proceed as follows when replacing the display:

1. Before the slimline operator panel is disassembled, please ensure that a clean and soft surface is available on which to place the display (danger of being scratched).
2. Switch off the entire system, verify isolation from supply and protect against unauthorized power up.
3. Disconnect external connectors:
X111, X331, X121, X131, X141, X241 (or X251), X211, X221, X231 (instead of RGB interface possibly X261), ground terminals and shielding
4. Release all cable strain relief elements.
5. Loosen 14 M4 screws at the operator panel front, remove the operator panel and place it on a soft surface where it cannot slip or tip over.
6. Loosen 3 M3 torx screws () on the cover (see Fig. below), then tilt the cover upwards and remove it.

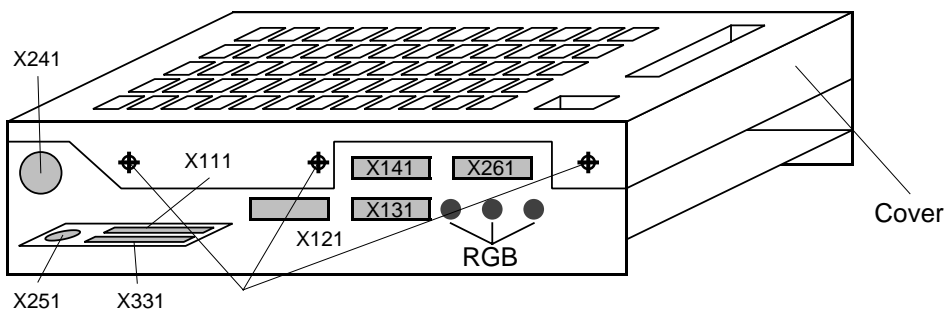

7. Remove 10 M3 torx screws () (see Fig. below)

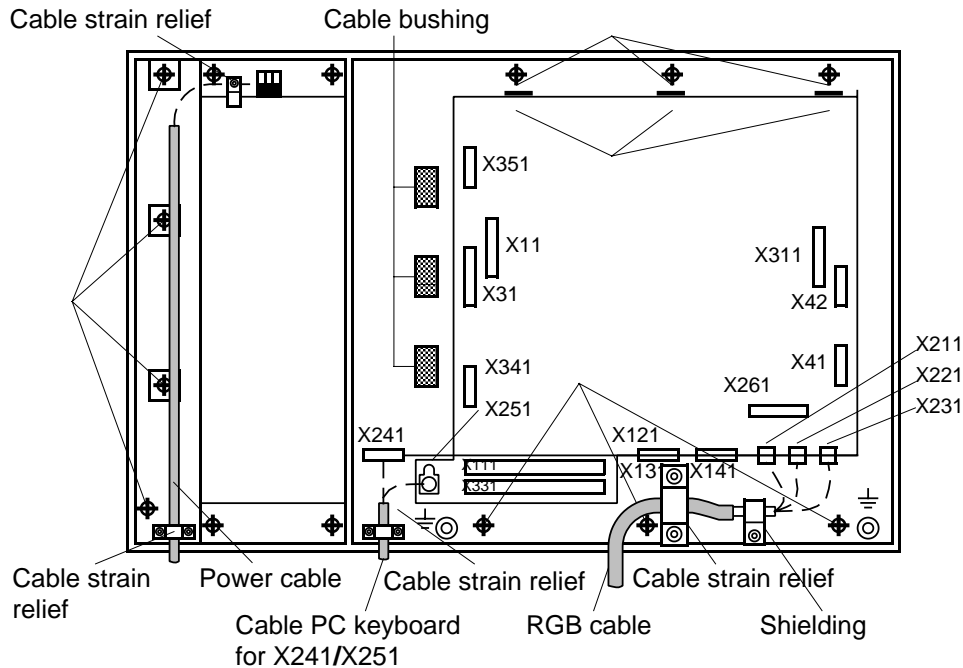

8. Loosen internal connectors X11 and X31 as well as
- X311 and X321 for monochrome slimline operator panel
 - X41, X42, X341, X351 for color slimline operator panel
9. Carefully pull cable X31 through the central cable bushing.
10. Remove the printed circuit board, power supply and mounting plate unit, turn it (display pointing upwards!) and put it down in a safe place.
11. Remove 1 cable X311 (monochrome) or 2 cables X41/X42 (color) from the display.
12. Loosen 4 M3 torx screws on the display spacers.

Note:

Display spacers are not permanently fixed to the mounting plate.

13. Remove the display and replace with new display.

Note:

On the 9.5" color slimline operator panel the backlight of the display can also be replaced (see Section 2.2.4.2.5, Replacing the backlight).

Installing the new display

14. Place the new display between the 4 spacers and screw firmly to spacer cover. Pull cable X341/X351 (color slimline operator panel) and X321 (monochrome slimline operator panel) through the cable bushing.

Note:

To prevent the display screen from breaking, the screws must be tightened with a max. torque of 0.8 Nm!

15. Connect 1 cable X311 (monochrome) or 2 cables X41/X42 (color) to the display.

16. Insert the printed circuit board, power supply and mounting plate unit pointing downwards at the same time pushing cable X31 carefully through the central cable bushing.
17. Secure unit with 10 M3 torx screws ().
- 18 Plug in internal connectors X11 and X31 as well as
 - X311 und X321 for monochrome slimline operator panel
 - X41, X42, X341, X351 for color slimline operator panel

Please note:

Ribbon cable connectors must latch tight.

19. Slot cover into the slot , release and secure to the unit with 3 M3 torx screws .
20. Insert operator panel and secure at the front of the operator panel with 14 M4 screws.
21. Fasten all cable strain relief elements.
22. Fasten all cable strain relief elements.
X111, X331, X121, X131, X141, X241 or X251, X211, X221, X231 (instead of RGB interface possibly X261), ground terminals and shielding.
23. Switch on unit and ensure that it is functioning correctly.

2.2.4.2.5 Replacing the backlight

The service life of the backlight of the 9.5" color slimline operator panel is approx. 10 000 h. The criterion for replacement is when the brightness has been reduced by half. This work must only be carried out by trained personnel. The handling regulations for electrostatically sensitive devices (ESD) must be observed.

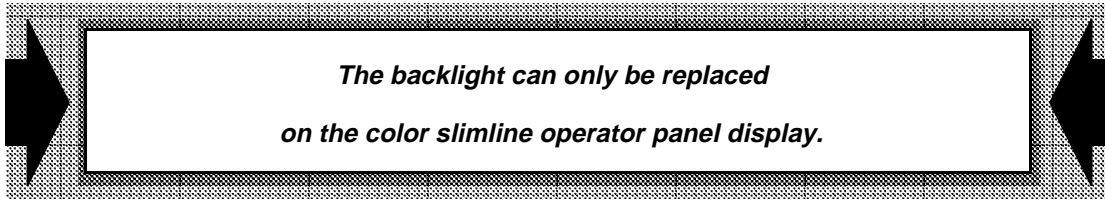

Order no. for backlight

- 1 backlight (order no.: 6FC5147-0AA00-0AA0)
- 10 backlights (order no.: 6FC5147-0AA02-0AA0)

Conditions

- Before replacing the backlight ensure that a clean and soft surface is available on which to place the display!
- To remove the display follow the instructions given in Section 2.2.4.2.4, Replacing the display.

Replacing the backlight

- The display (the top edge of the display facing downwards) has been removed. Now undo the 4 recessed head screws () on the backlight (see Fig. below).
- Carefully remove the backlight from the display and replace with a new backlight.

Note:

When inserting the new backlight ensure that the folded transparent membrane is inserted facing downwards in the display.

- Fasten the display with 4 recessed head screws ().
- The display must be replaced as described in Section 2.2.3.2.4, Replacing the display (steps 14 to 23).

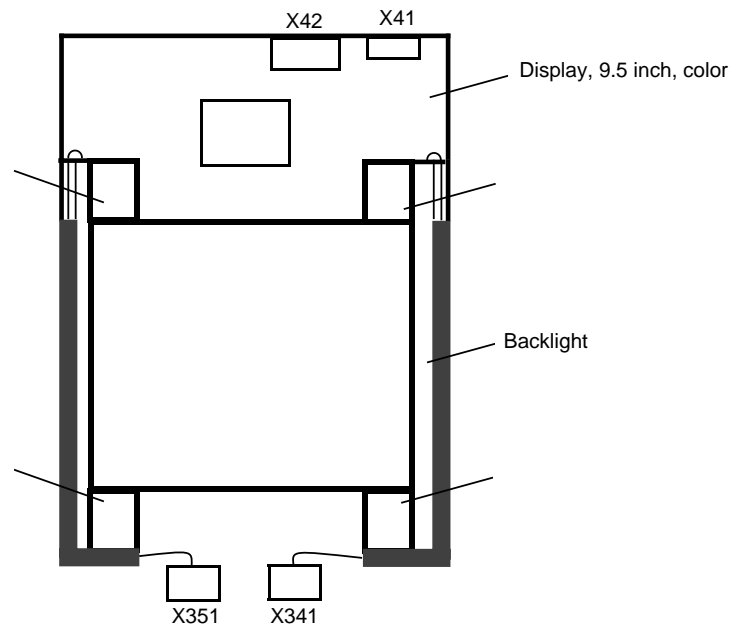

Note:

Dismounted backlight tubes are to be disposed of according to national regulations which also apply to fluorescent tubes.

2.2.4.3 10.4" color display (as from SW 6) 6FC5 103-0AB 3- AA3

2.2.4.3.1 Configuration

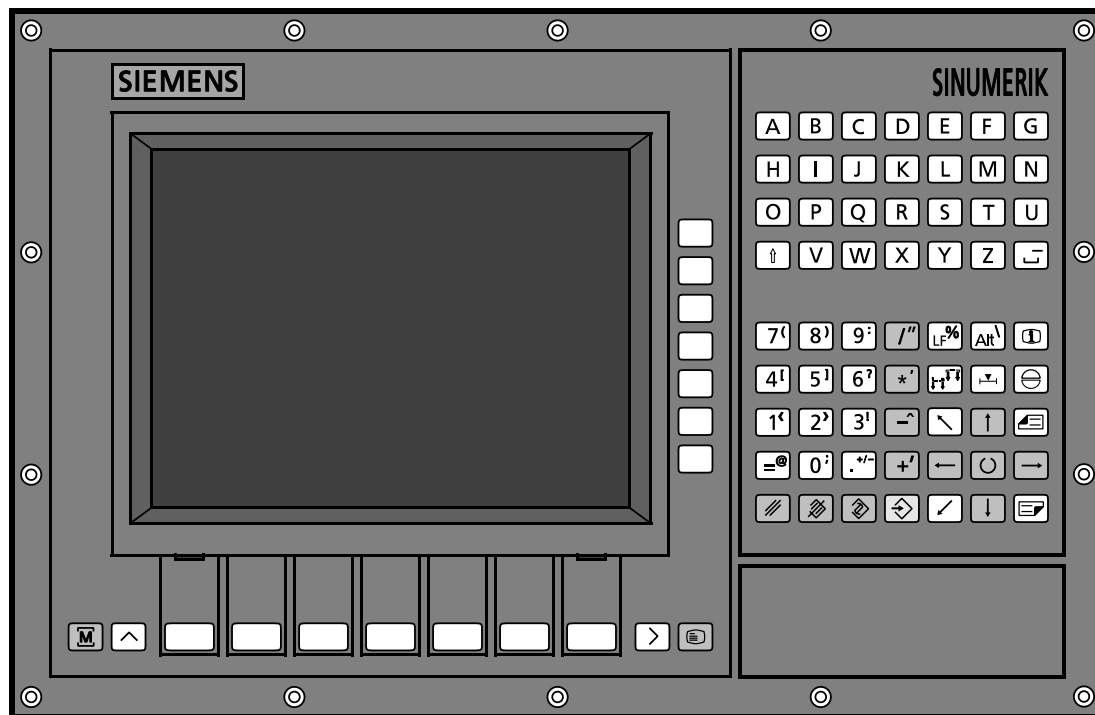

The slimline operator panel incorporates the following:

- 10.4" flat screen (visible display: 211 x 158 mm)
- NC keyboard
- Softkey bars
- Operator panel electronics with power supply
- Blanking plate for optional diskette drive FD-E2
- Optional connection of a machine control panel without interface (see "Machine control panel" Section)
- Optional connection of a MF keyboard

The operator panel interface is an active component connected to the slimline operator panel. The operator panel interface consists of:

- Keyboard connection
- Video converter

The operator panel electronics enables information entered via

- NC keyboard
- Softkeys
- Full keyboard
- Machine control panel

to be assigned to the V.24 (RS232C) and RS 485/MPC interfaces.

Selections are made by short keys.

Note:

Caused by the manufacturing process, the displays might occasionally show defective pixels. It can be a maximum of 10 light and 10 dark pixels, but within a circle of 10 mm diameter it can be a maximum of 5 defects only. Less defects do not give reason for complaint.

2.2.4.3.2 Location of interfaces, operator controls and display elements

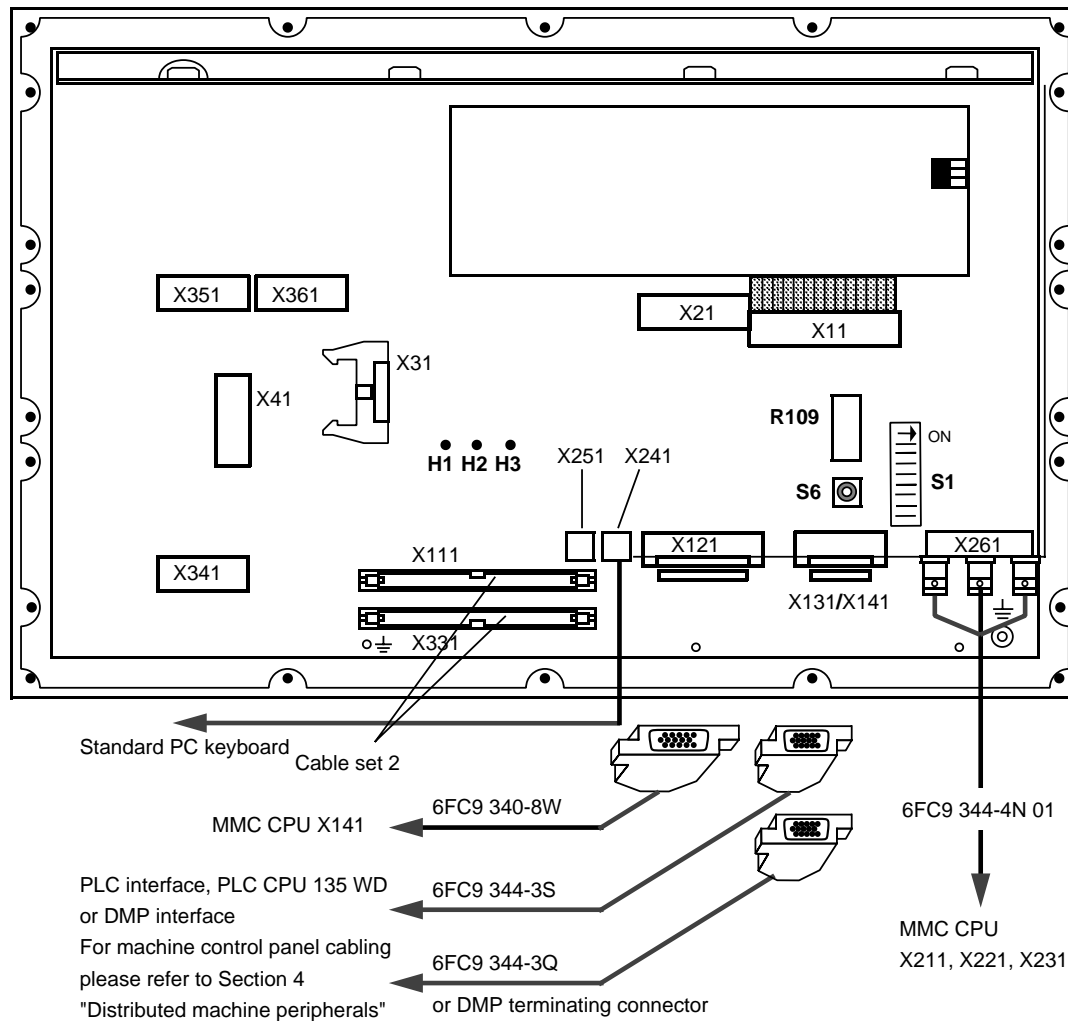

The following interfaces are located at the rear of the operating panel interface:

- X11 Interface to power supply unit
- X31 Interface to NC keyboard
- X41 Interface to display
- X111 Interface to machine control panel
- X121 RS-232 serial interface
- X131 RS-485/MPC interface 1 } double plug
- X141 RS-485/MPC interface 2 }
- X211 Red RGB analog video interface
- X221 Green RGB analog video interface/composite video signal
- X231 Blue RGB analog video interface
- X241 Interface to standard PC keyboard
- X251 Interface to standard PC keyboard (mini DIN socket)
- X261 VGA interface
- X331 Interface to machine control panel
- X341 Interface to backlight
- X351 Interface to backlight
- X361 Power supply interface for backlight
- \perp Power supply 230 VAC/24 VDC
- \perp Equipotential bonding connection

Display elements:

- H1, H2, H3

Operating controls:

- S1 DIP switch
- S6 Rotary switch
- R109 Potentiometer for phase adjustment
- Short key for setting the image position
- Short key for setting the brightness

Interface to machine control panel

Connect the interfaces by means of ribbon cables 6FC5 147-0AA04-0AA0 (see Section 2, "Keyboard interface") (see figure below):

Slimline operator panel	X111 X121	machine control panel
Slimline operator panel	X331 X111	machine control panel

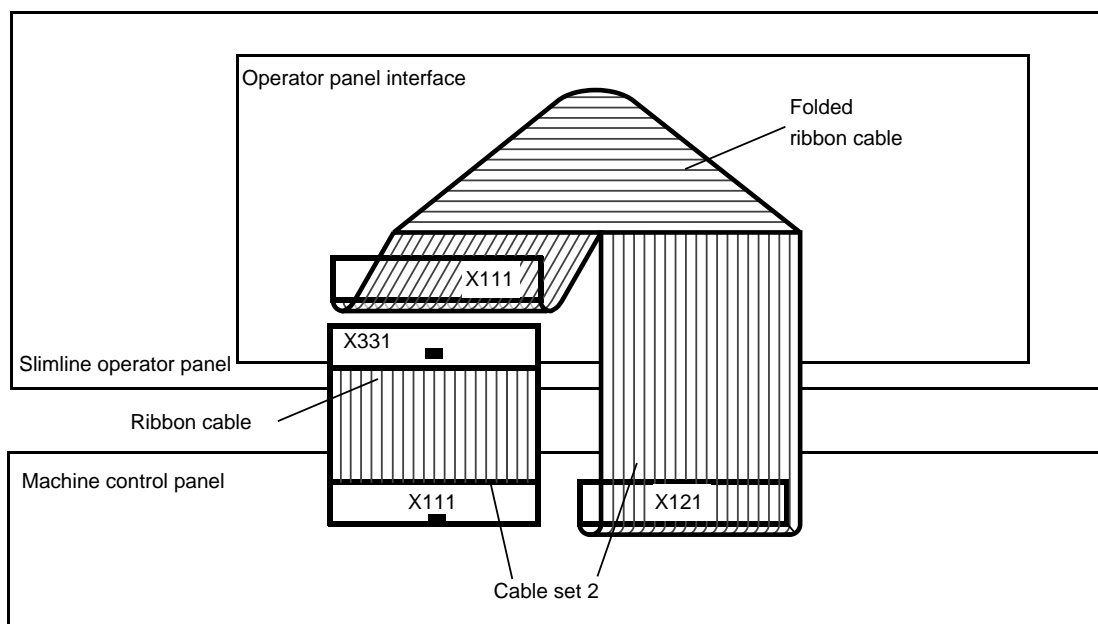

Connector designation: Operator control interface **X111, X331**
 Connector type: Flat connector DIN 41651, 64-pin

Pin assignment of X111 and X331:



The pin layout and signal assignment are the same as for the keyboard interface:

Operator panel interface X111	keyboard interface X221 (watch for locking device orientation)
Operator panel interface X331	keyboard interface X211

Note:

When using a customized machine control panel please refer to Section 2, "Keyboard interface" for the required interface description.

Interface X111 of the operator panel interface corresponds to interface X211 of the keyboard interface. Interface X331 of the operator panel interface corresponds to X221 of the keyboard interface.

RS-232 serial interface

Connector designation: Keyboard interface **X121**
Connector type: Sub-D socket connector, 25-pin

The operator panel interface handles the transmission of keyboard signals to the MMC and is designed as a serial interface in accordance with the RS 232 standard.

The pin assignment is described in Section 6 "Cables".

RS-485/MPC interfaces 1 and 2

Connector designation: Operator panel interface **X131, X141**
Connector type: Sub-D plug connector, 15-pin

The interfaces are electrically isolated and designed in accordance with the RS 485 standard.

The pin assignment is described in Section 6 "Cables".

RGB analog video interface

Connector designation: Operator panel interface **X211, X221, X231**
X211 red
X221 green/composite video signal
X231 blue
Connector type: BNC sockets

VGA interface

The VGA interface is intended for connecting a standard VGA interface of an external PC.

Note:

This interface is to be used for service purposes only.

No tests have been performed to check for compliance with the minimum permissible EMC data according to Section 3.1.3 "Electromagnetic compatibility (EMC)".

This interface cannot be operated simultaneously with the BNC inputs of the RGB analog video interface.

Connector designation: Operator panel interface X261
Connector type: Sub-D socket connector, 15-pin

Pin assignment of X261:

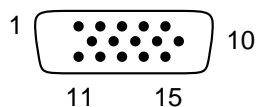

Signal assignment:

1:	Red		Analog red
2:	Green		Analog green
3:	Blue		Analog blue
13:	H_SYNC		Horizontal sync
14:	V_SYNC		Vertical sync
6-8:	M_RGB		Analog ground, RGB
5, 10:	M_SYNC		Analog ground, SYNC

Signal type:

I Input

Interface to PC standard keyboard

Connector designation: Operator panel interface **X241**
Connector type: DUP connector 76384-304, connected via cable to 5-pin DIN socket

or

Connector designation: Operator panel interface X251
Connector type: 6-pin mini DIN socket

It is possible to connect an additional standard PC keyboard (MF 2) provided with special NC keys to the slimline operator panel via interface X241 or X251 alternatively. The maximum baud rate achievable with the MF 2 keyboard is 6400 baud.

Note:

The standard PC keyboard 6FC5 103-0AC03-0AA0 can only be connected to interface X241 or X251 if the serial interface RS-232C (X121) is connected to the MMC CPU.

Display elements

The LEDs provide the following indications:

H2	LED yellow	
	LED turns off if:	Power supply drops below 4.75 V or with RESET.
H3	LED red	
	LED turns off if:	Transmission to MPC is correct.
H1	LED green	
	LED turns off if:	Program runs incorrectly (watchdog activated).

2.2.4.3.3 Settings/adjustments

Coding switch S1

By setting the coding switch S1, the following configurations are determined:

1. Selection of the SINUMERIK, to which the operator panel is connected
2. Adaptation of the video timing
3. Distinction between internal and external CNC keyboard

Coding switch S1 - switch no. 1

ON position: operation with RS422 adapter (not used)
OFF position: operation with RS422 adapter not possible (standard setting)

Coding switch S1 - switch no. 2 and 3

Selection of the SINUMERIK, to which the operator panel is connected:

1	2	3	4	5	6	7	8	SINUMERIK	Flat display	Mode
	OFF	OFF	OFF					840C	10.4" Color	VGA*
	ON	OFF	OFF					840	10.4" Color	VGA*
	OFF	ON	OFF					805	10.4" Color	VGA*
	ON	ON	OFF					880	10.4" Color	VGA*
	OFF	OFF	ON					840C	10.4" Color	RGB
	ON	OFF	ON					840	10.4" Color	RGB
	OFF	ON	ON					805	10.4" Color	RGB
	ON	ON	ON					880	10.4" Color	RGB

Standard setting

* For service purposes only

Coding switch S1 - switch no. 4

RGB/VGA switchover:

For VGA mode "OFF" must be set.

For the RGB mode, the "ON" position must be selected (standard setting)

Coding switch S1 - switch no. 5

The switch must principally be in "OFF" position (standard setting)

Coding switch S1 - switches no. 6, 7 and 8

If several operator panels are connected in series, the terminating resistors of the last operator panel (as seen from the MMC CPU) must be active and the corresponding switches must be in the ON position. The operator panels connected in front of it, must have inactive terminating resistors.

The terminating resistors (75 Ω) are inserted with the switches no. 6, 7 and 8.

ON position: terminating resistor for RED (6), GREEN (7) and BLUE (8) available
(standard setting)

OFF position: terminating resistor for RED (6), GREEN (7) and BLUE (8) not available

Coding switch S6

Serves for setting the DMP node nos. 1 through 15.

Switch position S6	Node no.
E	No. 1
D	No. 2
C	No. 3
...	...
2	No. 13
1	No. 14
0	No. 15

For the first MCP, position "E" is already preset in the standard machine data.

Summary of the standard settings made by the manufacturer:

- 19" slimline operator panel with 10.4" display:









	1	2	3	4	5	6	7	8
Coding switch S1	OFF	OFF	OFF	ON	OFF	ON	ON	ON
Coding switch S6	E							

R109 potentiometer









The potentiometer is used to adjust the image definition of vertical edges.

Setting the image position and brightness

The image position can be adjusted via 4 key combinations on the CNC keyboard

Image up			<Toggle> + <Cursor home>
Image down			<Toggle> + <Cursor end>
Image to the right			<Toggle> + <Cursor right>
Image to the left			<Toggle> + <Cursor left>

The brightness of the screen can be turned up or down via two key combinations on the CNC keyboard or the softkey bar.





Increase whiteness			<Toggle> + <Cursor up> or
			<Operating area> + <Recall>
Reduce whiteness			<Toggle> + <Cursor down> or
			<Operating area> + <Menu continuation>

Caution:

The key combinations are transferred to the MMC and evaluated according to their function. Therefore, the adjustment of the image position and brightness should be made in the basic image of the machine.

The new image position and brightness are saved after each modification. The setting made by the manufacturer can be reactivated via the following key combinations on the CNC keyboard or the softkey bar:



Activating the settings made by the manufacturer

		<Toggle> + <R> or
		<Recall> + <Menu continuation>

Backlight switch-off

In order to achieve a maximum service life of the backlight, it should be left switched off for at least 1 hour. Turning it darker for less than 1 hour will not increase the service life.

a) Switch off backlight

		<shift> + <Actual value display>
---	---	----------------------------------

The information "backlight switched off" will be transferred to the MMC

b) Switch off backlight

		<Operating area> + <Machine>
---	---	------------------------------

The information "backlight switched off" will not be transferred to the MMC

Backlight switch-on

Pressing any key of the alphanumeric keyboard will switch on the backlight again. The first pressing of a key to reactivate the screen will not be evaluated according to its function in the case of **a)**, but only used to turn up brightness.

Caution:

In case of **b)**, the corresponding key pressed will be evaluated.

2.2.4.3.4 Replacing the display

The service life of the 10.4" slimline operating panel displays is approximately 30,000 h, the service life of the backlight is 20,000 h. Either the display as a whole or the backlight alone may be replaced. This work must be performed by trained personnel only. The handling regulations prescribed for devices sensitive to electrostatic discharge (ESD) must be followed.

Note:

Before replacing the display always remove the slimline operator panel from its mounting location.

For the replacement the following display is required:

- 10.4" color display (order no.: 6FC5 247-0AA16-0AA1)

For replacing the backlight see Section 2.2.4.3.5

Removing the display

1. Before disassembling the slimline operator panel please make sure you have a clean and soft working surface available for the display (prone to scratches).
2. Turn off the power supply for the entire system. Verify that all supply lines are dead. Protect the system from unauthorized or unintended power-up.
3. Disconnect external connectors: X111, X331, X121, X131, X141, X241 (or X251), X211, X221, X231 (or X261 as an alternative to the RGB interface), ground terminals and shielding.
4. Release the strain relief on all cables.
5. Loosen the 14 M4 screws at the operator panel front, remove the operator panel and place it on a soft surface where it cannot slip or tip over.
6. Remove the assembly cover.
 - Loosen the 6 torx screws M3 x 8 mm by turning them back approx. 3 turns.
 - Slide the cover to the right and lift it straight up.
 - Disengage the power cable from the cable clip.
7. Pull the connector of the ribbon cable leading to the NC keyboard (X31).
8. Pull the connector of the backlight cable (pink/white lead) (X341/X351).
- 8a. Loosen the support bracket fixation screws (9 pieces).
9. Carefully lift off the support bracket while feeding the ribbon cable through the bracket recess and turn the support bracket upside down before placing it on the power supply unit and the module front panel.
10. Pull the backlight cable (pink/white) through the support bracket recess and disengage it from the cable guides.
11. At the bottom of the display at its left edge carefully pull off the connector of the signal cable (orange flex cable).

Caution:

The flex cable is very delicate - use extreme care when connecting or disconnecting it.

12. Unscrew the 4 torx screws M3 x 18 and remove the display.

Installing the display

1. Place the new display vertically in front of the two left hand spacers.
2. Bend the connector of the flex cable by 180° to face the display interface and make the connection by applying only light pressure on the flex cable.

Caution:

The connector and the flex cable are very delicate - use extreme care when connecting or disconnecting them.

3. Place the display flat on the spacers and secure it with torx screws M3 x 18.

Caution:

Maximum torque is 0.8 Nm - a higher force may break the display screen.

4. Engage the backlight cable in the cable clips and feed it through the support bracket recess.
5. Pull off the protective screen from the display.
6. Turn the support bracket around and insert it in the operating panel while at the same time feeding the ribbon cable of the NC keyboard through the provided recess.
7. Use 9 torx screws M3 x 8 to fix the support bracket to the operator panel (1.8 Nm maximum torque).
8. Connect the backlight cable (white/pink) to X341 and X351 to the module (check for correct orientation).
9. Connect the ribbon cable to X31 to the assembly (connector must be fully inserted to engage!).
10. Place the cover on top, slide it fully to the left stop and secure it with screws (1.8 Nm). Snap the power cable into the cable clip.
11. Insert the operator panel into the mounting location and check its functions.

2.2.4.3.5 Backlight für 10.4" color display 6FC5147-0AA00-0AA1

Replacing the backlight of SINUMERIK 840C/840CE

The service life of the backlight is approximately 20,000 h. Replacement becomes necessary when the brightness has dropped to half of its original value. The backlight consists of two tubes, which are always to be replaced in pairs.

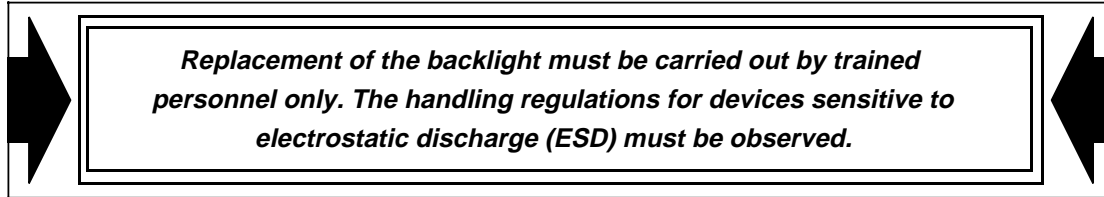

Prerequisites:

Before disassembling the slimline operator panel please make sure you have a clean and soft working surface available for the display (display front is prone to scratches!).

Removing the display (see Section 2.2.4.3.4)

Replacing the backlight:

1. Place the removed display frontside downwards on a clean and soft surface. Now unscrew the 4 Phillips screws of the backlight at the rear (see drawing).
2. Carefully remove the backlight from the display and replace it with a new backlight.
3. Fasten the backlight to the display with the Phillips screws.

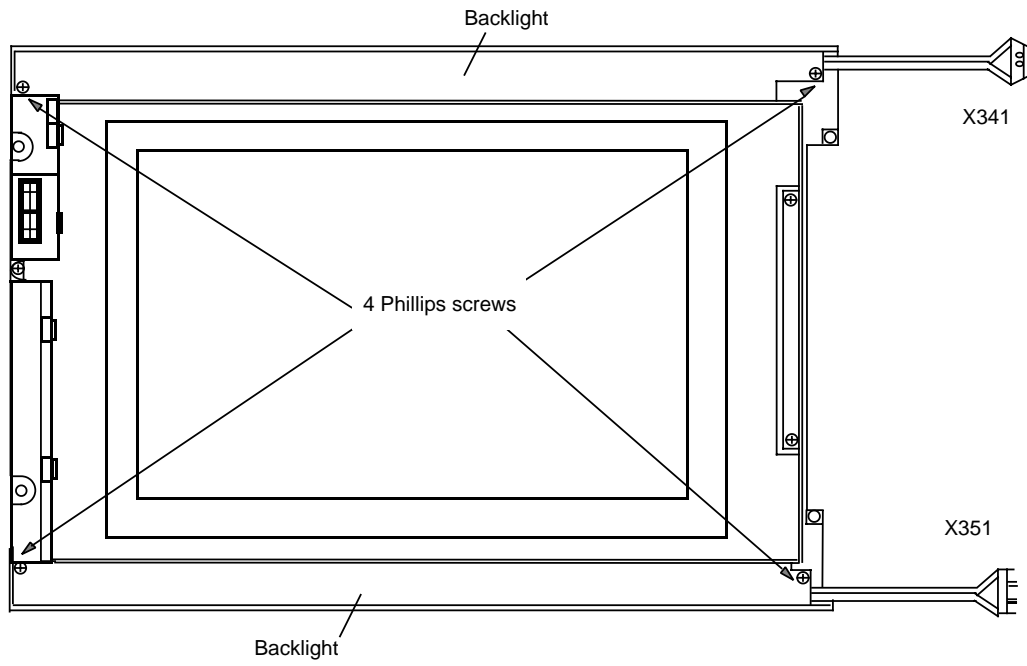

Installing the display (see Section 2.2.4.3.4)

2.2.5 Machine control panel

6FC5 103-0AD -0AA

2.2.5.1 Configuration

Machine control panel for a milling machine (M version)

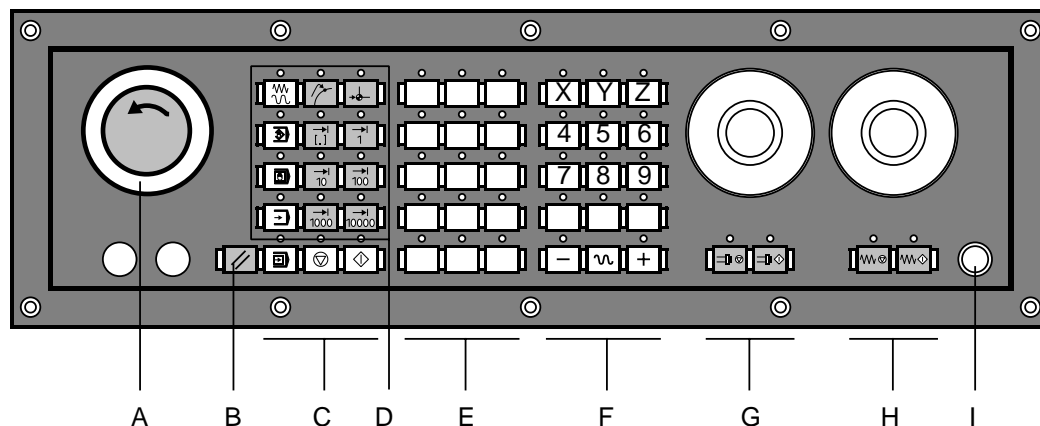

Machine control panel for a turning machine (T version)

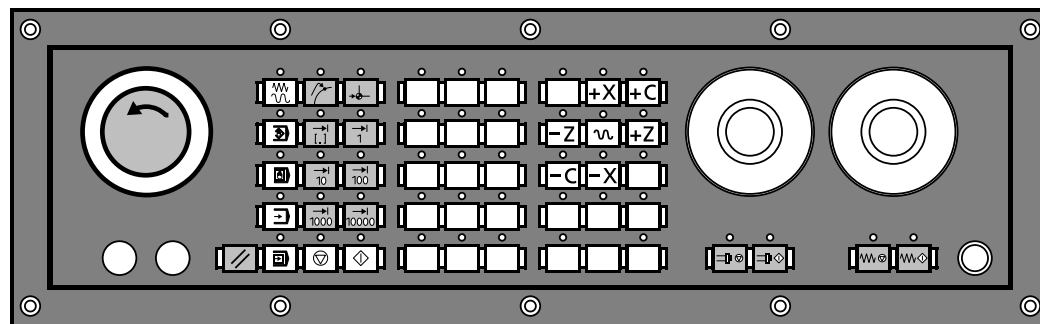

- A: EMERGENCY STOP pushbutton
- B: Reset key
- C: Program control
- D: Modes
- E: Customer keys
- F: Direction keys with rapid traverse overlay
- G: Spindle control
- H: Feed control
- I: Keyswitch (4 positions)

The machine control panel requires 5 V DC. For each of the controls (T or M version), there is a corresponding machine control panel with or without keyboard interface.

Note:

The machine control panel is part of the distributed machine peripherals (see Section 4, DMP).

Machine control panel without keyboard interface

- 64 inputs (30 keys, 2 rotary selector switches, keyswitch with 4 positions)
- 48 outputs (LEDs, allocated to keys)
- Interface for operator panel or keyboard interface

All keys are scanned individually so that, theoretically, all of them can be pressed at the same time.

Machine control panel with keyboard interface

- Machine control panel
- Keyboard interface (see "Keyboard interface" Section)

For operating a machine control panel, a 9.5" (10") slimline operator panel with integral operator panel electronics or a keyboard interface is necessary.

2.2.5.2 Operator control elements of the machine control panel**(A) EMERGENCY STOP**

EMERGENCY STOP button (with turn-to-reset feature) (Switching voltage 230 V max.)

The connection is made directly at the EMERGENCY STOP button.

The red button must be pressed in emergencies:

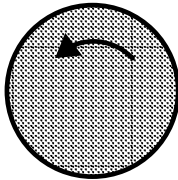

- when life is in danger;
- when the machine or workpiece is in danger of being damaged.

Suggested wiring for the EMERGENCY STOP system:

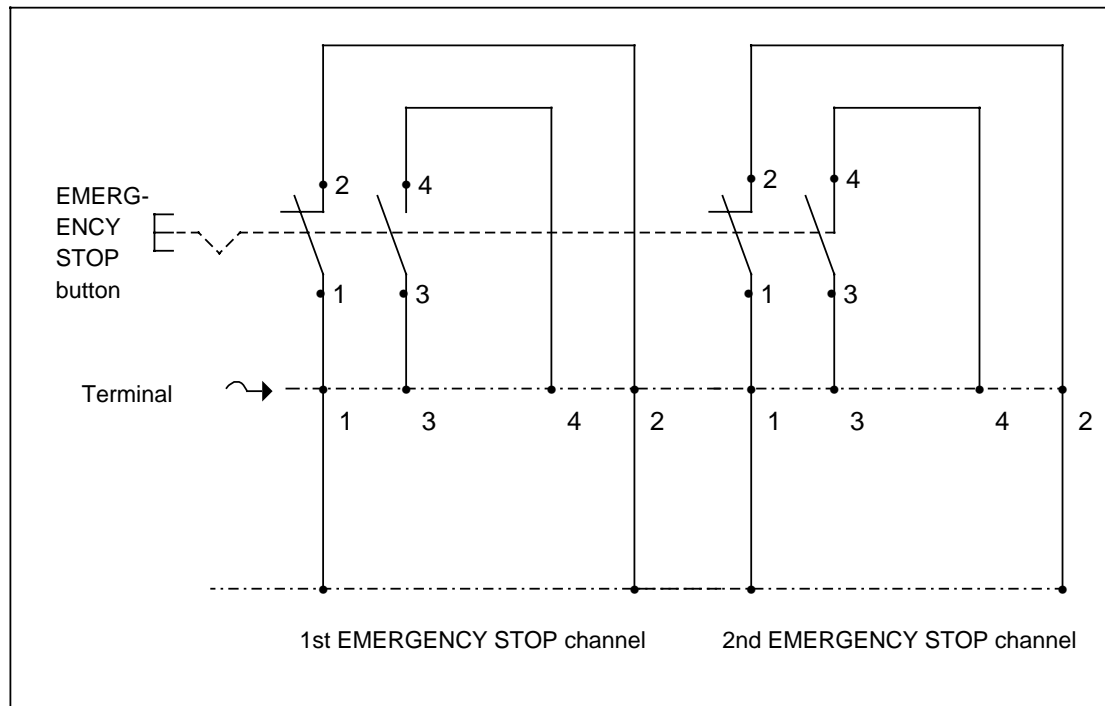

Note:

From version F on, the EMERGENCY STOP pushbutton has two channels.

(B) RESET



Contact: Normally open
 1 signal: RESET key pressed

(C) Program control



SINGLE BLOCK key
 Contact: Normally open
 1 signal: SINGLE BLOCK key pressed

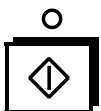

NC START key
 Contact: Normally open
 1 signal: NC START key pressed

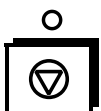

NC STOP key
 Contact: Normally closed
 1 signal: NC STOP key pressed

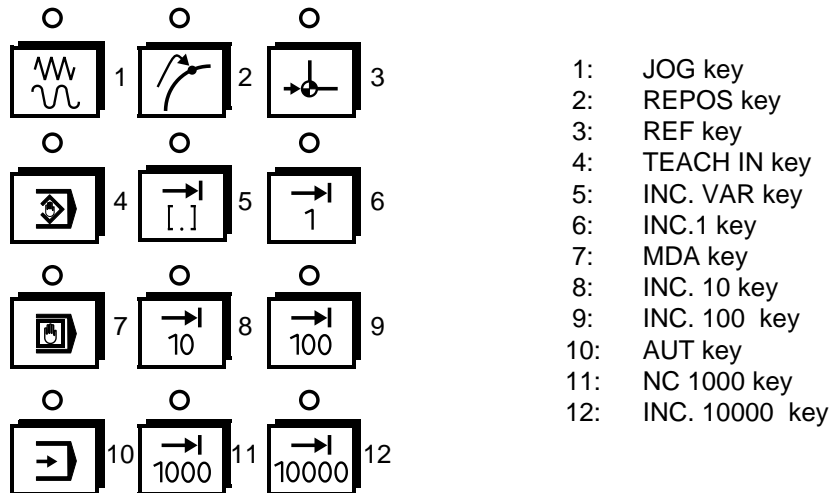
(D) Operating modes

When operating the SINUMERIK 840 machine control panel, a distinction is made between operating modes and functions. The operating modes or functions required are selected by pressing the individual keys.

The operating modes and functions are coded as bits. They are entered as whole words into the input image and from there transferred by the user into the DB channel and transferred by means of the PLC basic program to the internal interface. The operating modes or function transferred to the DB channel is displayed by LEDs.

Note:

The operating mode keys do not fulfil any safety functions according to Machine Directive 89/392/EEC.

(E) Customer keys with LEDs

The unassigned keys and LEDs of the standard machine control panel can be configured according to user requirements.

(F) Direction keys with rapid traverse overlay

- **Select axes**

The standard processing for the axis selection is written in the PLC basic program. It is possible to switch between travel key displays by means of the basic program or user program, via the PLC machine data bit PLC MD 6065.0.

1 signal: The travel key LEDs are set by the PLC operating system.

0 signal: The user sets the travel key LEDs.

- **Direction key assignments (T version)**

The direction keys (6 travel keys and 1 rapid traverse key) are grouped together. The travel keys are permanently assigned to the axes and are always transferred to the basic key block input image by means of the basic program. They must then be evaluated accordingly by the PLC user program. The LEDs assigned to the travel keys and the rapid traverse key are operated either by the PLC basic program or by the user program. They are set by means of MD 6065.0.

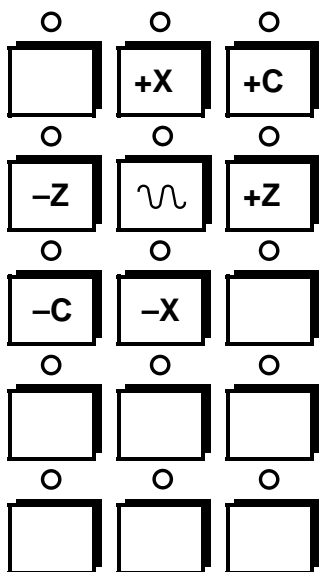

Each key: Normally open contact
 "1" signal: DIRECTION KEY pressed

• **Direction key assignments (M control)**

A maximum of 12 axes can be selected with these keys. The keys X, Y, Z and 4 to 9 are permanently assigned to the axes. The axis selected is indicated by the appropriate LED. The coding of the selected axis is entered by the basic program in the basic key block input image.

Each key: Normally-open contact
 "1" signal: KEY pressed

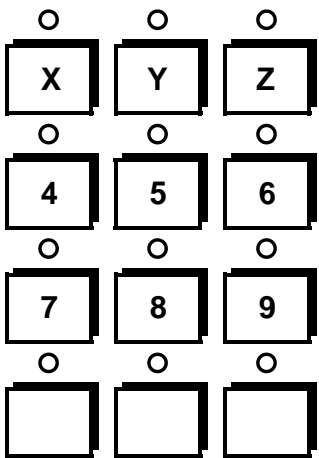

} Customer-specific, selectable

Note:

If more than 9 axes are needed, up to 27 axes can be selected via **conditional** calls of FB 79, transfer signals from machine control panel (direction keys) DB axes (valid for SINUMERIK 840C, machine control panel M version) and, for example, via customer-specific keys. The axes are configured in FB 79 via parameter NRAZ.

E.g. NRAZ 1, 9 from the 1st axis to the 9th axis (9 axes) and
 NRAZ 10, 9 from the 10th axis to the 18th axis (9 axes) and
 NRAZ 19, 9 from the 19th axis to the 27th axis (9 axes)

Plus/minus direction keys

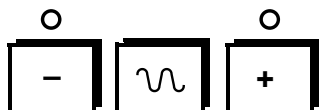

Each key: Normally-closed contact
 "1" signal: DIRECTION KEY + or - pressed

(G) Spindle control

The spindle control consists of the spindle speed override switch and two keys.

The spindle speed override switch is a selector switch with 16 positions, Gray-coded, and with overlapping contact arrangement. Using this switch, the spindle speed can be varied in steps between 50 and 120 %. Each switch position is assigned a fixed override value via machine data.

In the case of rotary feed and constant cutting speed, spindle speed override causes the feed drives to adapt automatically. In thread cutting, the switch does not have any effect.

Position	Override value in %
1	50
2	55
3	60
4	65
5	70
6	75
7	80
8	85
9	90
10	95
11	100
12	105
13	110
14	115
15	120
16	120

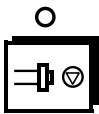
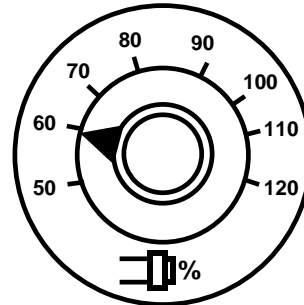

SPINDLE HOLD key

Contact: Normally closed

0 signal: SPINDLE HOLD key is pressed

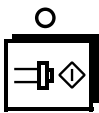

SPINDLE START key

Contact: Normally open

1 signal: SPINDLE START key is pressed

(H) Feedrate control

The feedrate control consists of the feedrate override switch and two keys.

The feedrate override switch is a selector switch with 23 positions, Gray-coded, and with overlapping contact arrangement. Using the feedrate override switch, it is possible to vary the feedrate in steps between 0% and 120%. Each switch position is assigned a fixed override value via machine data.

The 0% position always has effect, even for rapid traverse. The switch has no effect for thread cutting.

Position	Override value in %
1	0
2	1
3	2
4	4
5	6
6	8
7	10
8	20
9	30
10	40
11	50
12	60
13	70
14	75
15	80
16	85
17	90
18	95
19	100
20	105
21	110
22	115
23	120

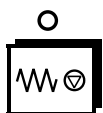
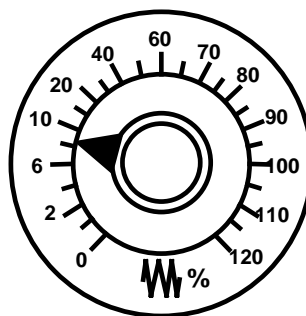

FEED HOLD key
 Contact: Normally closed
 "0" signal: FEED HOLD key pressed

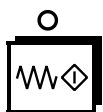

FEED START key
 Contact: Normally open
 "1" signal: FEED START key pressed

(I) Keyswitch

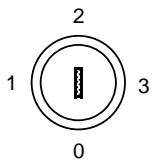

Contact: Normally open
 "0" signal: Key removed

This is an authorization keyswitch which, depending on the key used, can be put into different positions.

Assignment key numbers/positions

	POSSIBLE POSITIONS
KEY 1 (black)	0+1
KEY 2 (green)	0+1+2
KEY 3 (red)	0+1+2+3

Keys 1, 2 and 3 can be withdrawn in the positions shown above.

The access rights stored in the system data correspond to the following keyswitch positions:

- Switch position 0: Data can only be displayed (read only of hard disk)
- Switch position 1: Workpiece data/part programs can be written, edited and deleted; data can be read
- Switch position 2: Generate, edit and delete interface data (RS 232 device parameters), archive lists and setting data
- Switch position 3: The control powers up with the default settings from the file operation/default settings/BEDCONF in the Siemens branch. Access to the user branch is only possible with a password. However, the following data that may exist in the user branch are evaluated and loaded: CONFIG file, customer UMS, NCK memory configuration

2.2.5.3 Location of the interfaces and the operator control and display elements

Machine control panel without keyboard interface

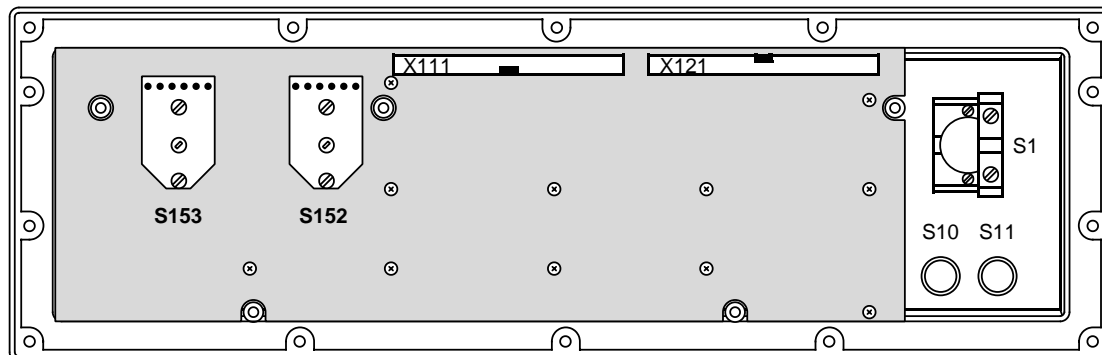

The interfaces are located at the rear of the machine control panel:

- X111 Interface to machine control panel
- X121 Interface to machine control panel

Control elements:

- S1 EMERGENCY STOP switch
- S10 Unassigned
- S11 Unassigned } e.g. for customer-specific keys
- S152 Rotary selector switch for spindle control
- S153 Rotary selector switch for feed control

Interface to the keyboard interface/operator panel interface

Connector designation: MTT X111, X121
 Connector type: Flat connector DIN 41651, 64-pin

Link the following interfaces by means of the 6FC5 147-0AA03-0AA0 ribbon cables (see Section Cable sets 1 and 2):

MSTT X111 X211 Keyboard interface
 MSTT X121 X221 Keyboard interface

and the following interfaces via the 6FC5 147-0AA04-0AA0 ribbon cables:

MSTT X111 X331 Operator panel interface
 MSTT X121 X111 Operator panel interface

Pin assignment of X111 and X121 of the machine control panel:

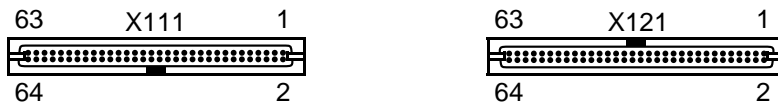

The signal assignment of the individual pins is the same as for the keyboard interface:

Machine control panel X111 keyboard interface X211
 Machine control panel X121 keyboard interface X221

2.2.6 Keyboard interface

2.2.6.1 Configuration 230 V AC (old)

6FC5 103-0AE01-0AA0

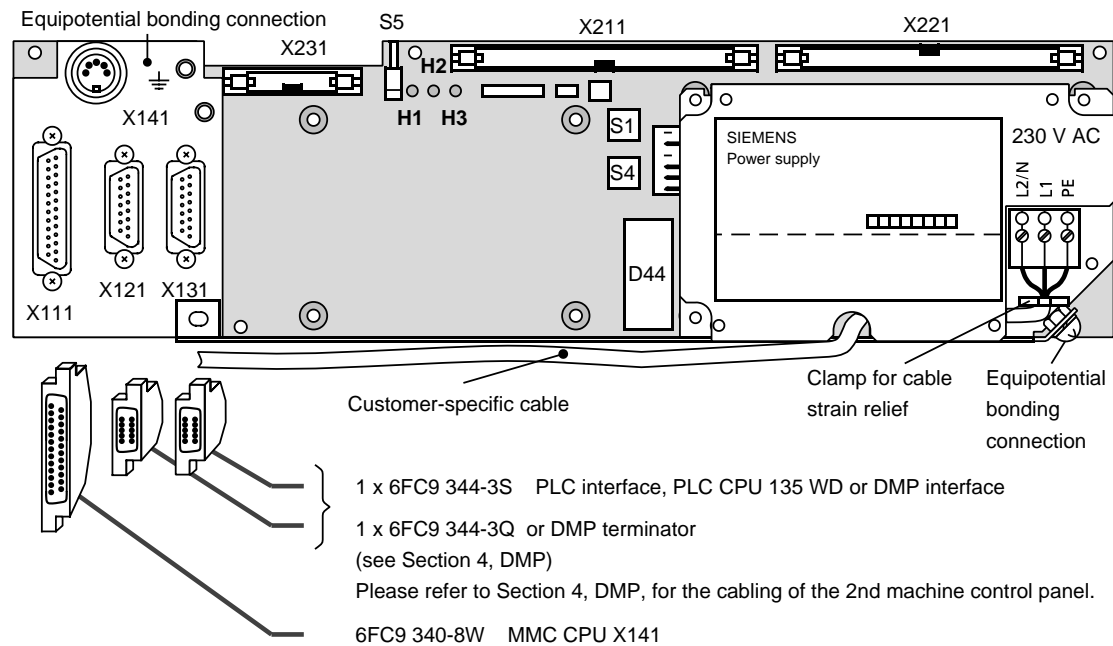

The keyboard interface is mounted behind the machine control panel. Optionally, it can also be installed behind the NC keys.

Note:

The keyboard interface is designed for controlling both an NC keyboard **and** a machine control panel. This interface is not necessary when using a slimline operator panel.

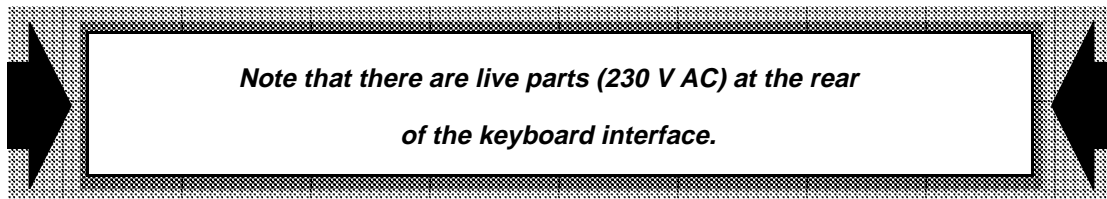

Note:

The machine control panel is part of the distributed machine peripherals. Please refer to Section 4, DMP, to find out how to link the keyboard interface to the MPC line.

The following interfaces are at the rear of the keyboard interface:

- X111 Serial interface RS 232 C
- X121 RS 485/MPC interface 1
- X131 RS 485/MPC interface 2
- X141 Interface to the full keyboard
- X211 Interface to the machine control panel
- X221 Interface to the machine control panel
- X231 Interface to the NC keyboard
- D44 EPROM location
- 230 V AC power supply
- \perp Equipotential bonding connection

Display elements:

- H1, H2, H3 LEDs

Control elements:

- S1 Rotary switch
- S4 Rotary switch
- S5 RESET pushbutton

Serial interface RS 232 C

Connector designation: **X111** keyboard interface

Connector type: Sub-D socket connector, 25-pin

The operator panel interface is designed as a serial interface in accordance with the RS232C standard and for transmission of the keyboard signals to the MMC.

Please refer Section 6, Cables, for pin assignments.

RS-485/MPC interfaces 1 and 2

Connector designation: Operator panel interface **X121, X131**

Connector type: Sub-D pin connector, 15-pin

The internal DMP station is looped into the MPC line via interfaces X131 and X141.

Please refer Section 6, Cables, for pin assignments.

The interfaces are designed to the RS 485 standard and electrically isolated.

Interface to PC standard keyboard

Connector designation: **X141** keyboard interface
 Connector type: 5-pin DIN socket, soldered in

An additional PC standard keyboard (MF II) with NC special keys can be connected to the slimline operator panel via the X141 interface. The maximum permissible transmission rate for the MF II keyboard is 6400 baud.

Please refer Section 6, Cables, for pin assignments.

Note:

A PC standard keyboard can only be connected at interface X141 if the serial interface RS 232 C of the keyboard interface is connected to the MMC CPU.

Interface to machine control panel

Connector designation: Keyboard interface **X211, X221**
 Connector type: Ribbon cable connector DIN 41651, 64-pin

Link the interfaces by means of the 6FC5 147-0AA03-0AA0 ribbon cable (see "Cable sets 1 and 2" Section):

Keyboard interface	X221	X121	Machine control panel
Keyboard interface	X211	X111	Machine control panel

Interface keyboard matrix/softkeys

Connector designation: **X231** keyboard interface
 Connector type: Ribbon cable connector DIN 41651, 20-pin

Display elements

The LEDs have the following meaning:

H2	LED, yellow	
	LED darkens if:	Power supply drops below 4.75 V or RESET
H3	LED, red	
	LED darkens if:	Correct transmission to MPC (only if RS 485 is selected via coding switch)
H1	LED, green	
	LED darkens if:	No proper program execution (watchdog responds).

S1 Rotary switch

The position of the rotary switch defines the system to which the keyboard interface is connected.

S1 rotary switch position	System
4	SIN 840C
5	SIN 880 GA2
6	SIN 805/805SM
C	SIN 840C
D	SIN 880 GA2
E	SIN 805/805SM

S4 Rotary switch

Used for setting DMP station numbers 1 to 15.

Rotary selector switch S4 position	DMP station number
E	1
D	2
C	3
⋮	⋮
2	13
1	14
0	15

Position "E" is preset for the first machine control panel in the standard machine data (see Interface Description, Part 1).

S5 RESET pushbutton

Operation of the S5 pushbutton causes a reset of the operator panel electronics.

Note:

See Section Description of interfaces X221 and X211, for a description of the interface on keyboard interface X221 and X211.

2.2.6.2 Configuration 230 V AC (new) 24 V DC (new)

6FC5 103-0AE01-0AA1
6FC5 103-0AE01-1AA1

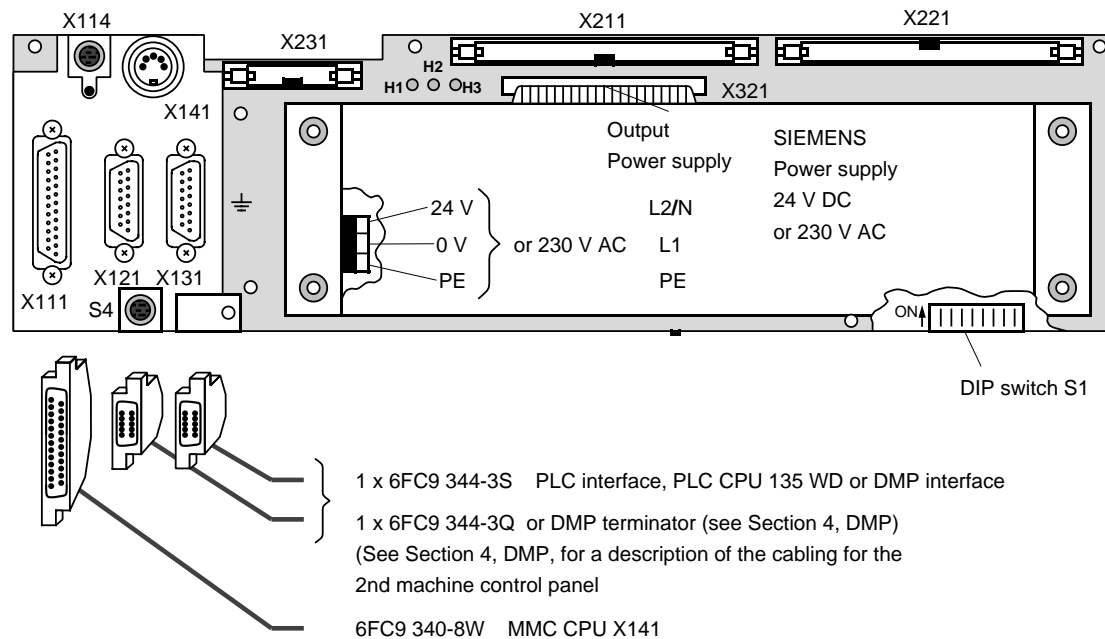

The keyboard interface is mounted behind the machine control interface. Alternatively, it can be mounted behind the NC keyboard.

Notes:

- The keyboard interface is designed to control and NC keyboard and a machine control panel.
- If a slimline operator panel is used, the 24 V DC or 230 V AC keyboard interface is not required.
- The 24 V DC keyboard interface is not supplied with the NC keyboard/machine control panel. They keyboards must be ordered separately.

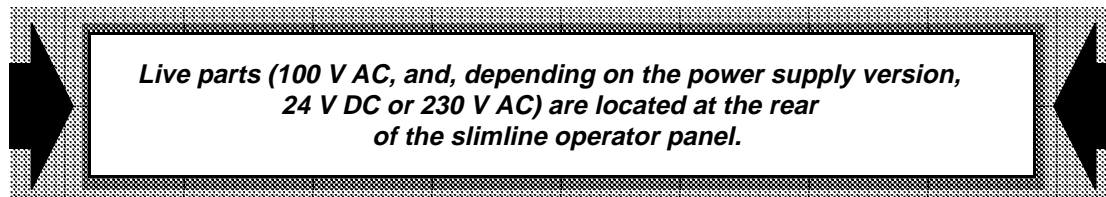

Note:

The machine control panel is part of the distributed machine peripherals. Please refer to Section 4, DMP, for a description of how to integrate the keyboard interface into the MPC line.

The following interfaces are located on the keyboard interface:

- X111 RS 232 C serial interface
- X114 Interface to PC standard keyboard mini DIN (as an alternative to X141)
- X121 RS 485/MPC interface 1
- X131 RS 485/MPC interface 2
- X141 Interface to PC standard keyboard MF2
- X211 Interface to machine control panel
- X221 Interface to machine control panel
- X231 Interface to NC keyboard
- 230V AC / 24V DC power supply
- \perp Equipotential bonding connection

Display elements:

- H1, H2, H3 LEDs

and the control elements:

- S1 DIP switch
- S4 Rotary switch

Serial interface RS 232 C

Connector designation: Keyboard interface **X111**
Connector type: Sub-D socket connector, 25-pin

The operator panel connection is designed as a serial interface in accordance with the RS 232 C standard for the transmission of keyboard signals to the MMC.

The pin assignment is described in Section 6, Cables.

RS 485/MPC interfaces 1 and 2

Connector designation: Operator interface **X121, X131**
Connector type: Sub-D plug connector, 15-pin

The internal DMP station is looped into the MPC line via interfaces X121 and X131.

The pin assignment is described in Section 6, Cables.

The interfaces are electrically isolated and designed in accordance with the RS 485 standard.

Interface to PC standard keyboard

Connector designation: Keyboard interface **X141**
 Connector type: 5-pin DIN socket, soldered

or

Connector designation: Keyboard interface **X114**
 Connector type: 6-pin mini DIN socket

It is possible to connect an additional PC standard keyboard (MF II) with special NC keys to the slimline operator panel via the interface X141 or X114. The maximum possible baud rate of the MF II keyboard is 6400 baud.

Note:

PC standard keyboard 6FC5 103-0AC03-0AA0 can only be connected to interface X141 or X114 if the serial interface RS 232C of the keyboard interface is connected to the MMC CPU.

Interface to machine control panel

Connector designation: Keyboard interface **X211, X221**
 Connector type: Tab connector DIN 41651, 64-pin

Connect the following interfaces with ribbon cables 6FC5 147-0AA03-0AA0 (see Section Set of cables 1 and 2):

Keyboard interface	X221	X121	machine control panel
Keyboard interface	X211	X111	machine control panel

Interface keyboard matrix/softkeys

Connector designation: Keyboard interface **X231**
 Connector type: Ribbon cable connector DIN 41651, 20-pin

Display elements

The LEDs have the following meaning:

H2	LED yellow	
	LED darkens if:	Power supply drops below 4.75 V or RESET
H3	LED red	
	LED darkens if:	Correct transmission to MPC (only if RS 485 has been selected with the coding switch)
H1	LED green	
	LED darkens if:	No proper program execution (watchdog responds).

S1 DIP switch

The DIP switch is used to select the system to which the keyboard interface is to be connected.

The following settings can be made:

1	2	3	4	5	6	7	8	System
1)	OFF	OFF	OFF	OFF	ON	OFF	OFF	Reserved
	ON	OFF	OFF	OFF	ON	OFF	OFF	Reserved
	OFF	ON	OFF	OFF	ON	OFF	OFF	Reserved
	ON	ON	OFF	OFF	ON	OFF	OFF	Reserved
	OFF	OFF	ON	OFF	ON	OFF	OFF	SINUMERIK 840C
	ON	OFF	ON	OFF	ON	OFF	OFF	SINUMERIK 840
	OFF	ON	ON	OFF	ON	OFF	OFF	SINUMERIK 805
	ON	ON	ON	OFF	ON	OFF	OFF	SINUMERIK 880

- 1) ON Position ON: Operation with RS422 adapter
 Position OFF: No RS422 adapter operation possible

S4 Rotary switch

Used to setting DMP station numbers 1 to 15.

Rotary switch position S4	DMP station number
E	1
D	2
C	3
⋮	⋮
2	13
1	14
0	15

Position "E" is assigned to the 1st machine control panel in the standard machine data (see Interface Description, Part 1).

Note:

See section Description of interfaces X221 and X211, for a description of the interface on the keyboard interface X221 and X211.

2.2.6.3 Description of interfaces X211 and X221

Keyboard interface

Connector designation: **X221** keyboard interface
 Connector type: Ribbon cable connector DIN 41651, 64-pin

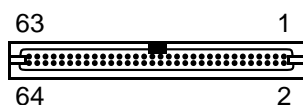

Pin assignment/function

Pin	Function	Signal type	Pin	Function	Signal type
1	LED AUTOMATIC	OUTPUT	33	REF key	INPUT
2	LED MDA	OUTPUT	34	+5 V	–
3	LED TEACH IN	OUTPUT	35	REPOS key	INPUT
4	LED JOG	OUTPUT	36	NC HOLD key	INPUT
5	LED INC 1	OUTPUT	37	Feedrate override switch 1	INPUT
6	LED INC 10	OUTPUT	38	NC START key	INPUT
7	LED INC 100	OUTPUT	39	Feedrate override switch 2	INPUT
8	LED INC 1000	OUTPUT	40	FEED HOLD key	INPUT
9	LED INC 10000	OUTPUT	41	Feedrate override switch 4	INPUT
10	LED INC VAR	OUTPUT	42	FEED START key	INPUT
11	LED REF	OUTPUT	43	Feedrate override switch 8	INPUT
12	LED REPOS	OUTPUT	44	SPINDLE STOP key	INPUT
13	LED NC STOP	OUTPUT	45	0 V	–
14	LED NC START	OUTPUT	46	SPINDLE START key	INPUT
15	LED FEED HOLD	OUTPUT	47	Feedrate override switch 16	INPUT
16	LED FEED START	OUTPUT	48	Keyswitch position 2	INPUT
17	0 V	–	49	SINGLE BLOCK key	INPUT
18	AUTOMATIC key	INPUT	50	Keyswitch position 0	INPUT
19	INC 1 key	INPUT	51	Keyswitch position 1	INPUT
20	MDA key	INPUT	52	+5 V	–
21	INC 10 key	INPUT	53	RESET key	INPUT
22	TEACH IN key	INPUT	54	reserved	–
23	INC 100 key	INPUT	55	0 V	–
24	JOG key	INPUT	56	LED SPINDLE STOP	OUTPUT
25	INC 1000 key	INPUT	57	LED SPINDLE START	OUTPUT
26	Spindle speed override switch 1	INPUT	58	LED SINGLE BLOCK	OUTPUT
27	0 V	–	59	LED R10	OUTPUT
28	Spindle speed override switch 2	INPUT	60	LED R7	OUTPUT
29	INC 10000 key	INPUT	61	LED R4	OUTPUT
30	Spindle speed override switch 4	INPUT	62	LED R1	OUTPUT
31	INC VAR key	INPUT	63	LED R13	OUTPUT
32	Spindle speed override switch 8	INPUT	64	reserved	–

Keyboard interface

Connector designation: **X211** keyboard interface
 Connector type: Ribbon cable connector DIN 41651, 64-pin

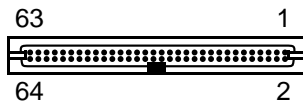

Pin assignment/function

Pin	Function	Signal type	Pin	Function	Signal type
1	LED R15	OUTPUT	33	Key R3	INPUT
2	LED R6	OUTPUT	34	+5 V	–
3	LED R8	OUTPUT	35	Key R2	INPUT
4	LED R9	OUTPUT	36	Key not assigned	INPUT
5	LED R11	OUTPUT	37	Key F8	INPUT
6	LED R12	OUTPUT	38	Key F15	INPUT
7	LED R5	OUTPUT	39	Key F7	INPUT
8	LED R3	OUTPUT	40	Key F14	INPUT
9	LED R2	OUTPUT	41	Key F6	INPUT
10	LED F15	OUTPUT	42	Key F13	INPUT
11	LED F14	OUTPUT	43	Key F5	INPUT
12	LED F13	OUTPUT	44	Key F12	INPUT
13	LED F12	OUTPUT	45	0 V	–
14	LED F11	OUTPUT	46	Key F11	INPUT
15	LED F10	OUTPUT	47	Key F4	INPUT
16	LED F9	OUTPUT	48	Key F10	INPUT
17	0 V	–	49	Key F3	INPUT
18	Key R10	INPUT	50	Key F9	INPUT
19	Key R6	INPUT	51	Key F2	INPUT
20	Key R7	INPUT	52	+5 V	–
21	Key R8	INPUT	53	Key F1	INPUT
22	Key R4	INPUT	54	reserved	–
23	Key R9	INPUT	55	0 V	–
24	Key R1	INPUT	56	LED F8	OUTPUT
25	Key R11	INPUT	57	LED F7	OUTPUT
26	Keyswitch position 3	INPUT	58	LED F6	OUTPUT
27	0 V	–	59	LED F5	OUTPUT
28	Key R14	INPUT	60	LED F4	OUTPUT
29	Key R12	INPUT	61	LED F3	OUTPUT
30	Key R13	INPUT	62	LED F2	OUTPUT
31	Key R5	INPUT	63	LED F1	OUTPUT
32	Key R15	INPUT	64	reserved	–

Note:

The pin assignment of the ribbon cable connectors X211 and X221 differs with respect to the locating lugs (see drawings).

Signal description:

- Outputs for LED.

The outputs have a 330 Ω series resistor and are low active.

- Inputs for push-button, switch and keyswitch

Low level < 0.8 V; high level > 2 V

Each of the inputs has a 1 k Ω pullup resistor. The inputs pin 36, pin 40 and pin 44 on X221 are high active. The remaining inputs are low active.

The machine control panel is only recognized if the keys of the three high active inputs are not pressed when the control is switched on (low level). The keys are normally-closed contacts.

- The power consumption of 1 LED is 10 mA.

2.2.7 Cable sets 1, 2 and 3**6FC5 147-0AA0 -0AA0**

You are supplied with 2 cable sets to connect the operator panel components:

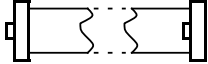
- Cable set 1 6FC5 147-0AA03-0AA0 

The cable set consists of two 64-pin ribbon cables and is used to connect the machine control panel to the keyboard interface.

Total length: 2 x 500 mm
- Cable set 2 6FC5 147-0AA04-0AA0 (max. 0.5 m permissible)

The cable set consists of two 64-pin ribbon cables and is used to connect the first machine control panel to the operator panel interface of the slimline operator panel.

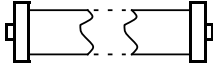
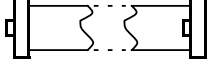
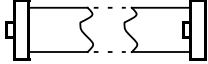
Total length: 1 x 500 mm 
 1 x 270 mm 
- Cable set 3 6FC5 147-0AA23-0AA0 

The cable set consists of two 64-pin ribbon cables and is used to connect the second machine control panel to the keyboard interface.

Total length: 2 x 100 mm

The total length includes the width of the ribbon cable connector.

2.2.8 Configuring the machine control panel

The 1st and 2nd machine control panels are each connected via a DMP station (64 I/48Q). This DMP station is either integrated in the operator panel interface (slimline panel) or in the keyboard interface.

This DMP station is incorporated in a MPC line in the same way as the other DMP stations (see "Distributed Machine Peripherals" Section).

The following illustration gives you the names of the keys and LEDs on the machine control panel. These names are important for the assignment to the input/output areas (see Section Input/output assignment on the machine control panel) as well as their assignment to the pins on the ribbon cable connectors X211 and X221 (see "Keyboard interface" Section).

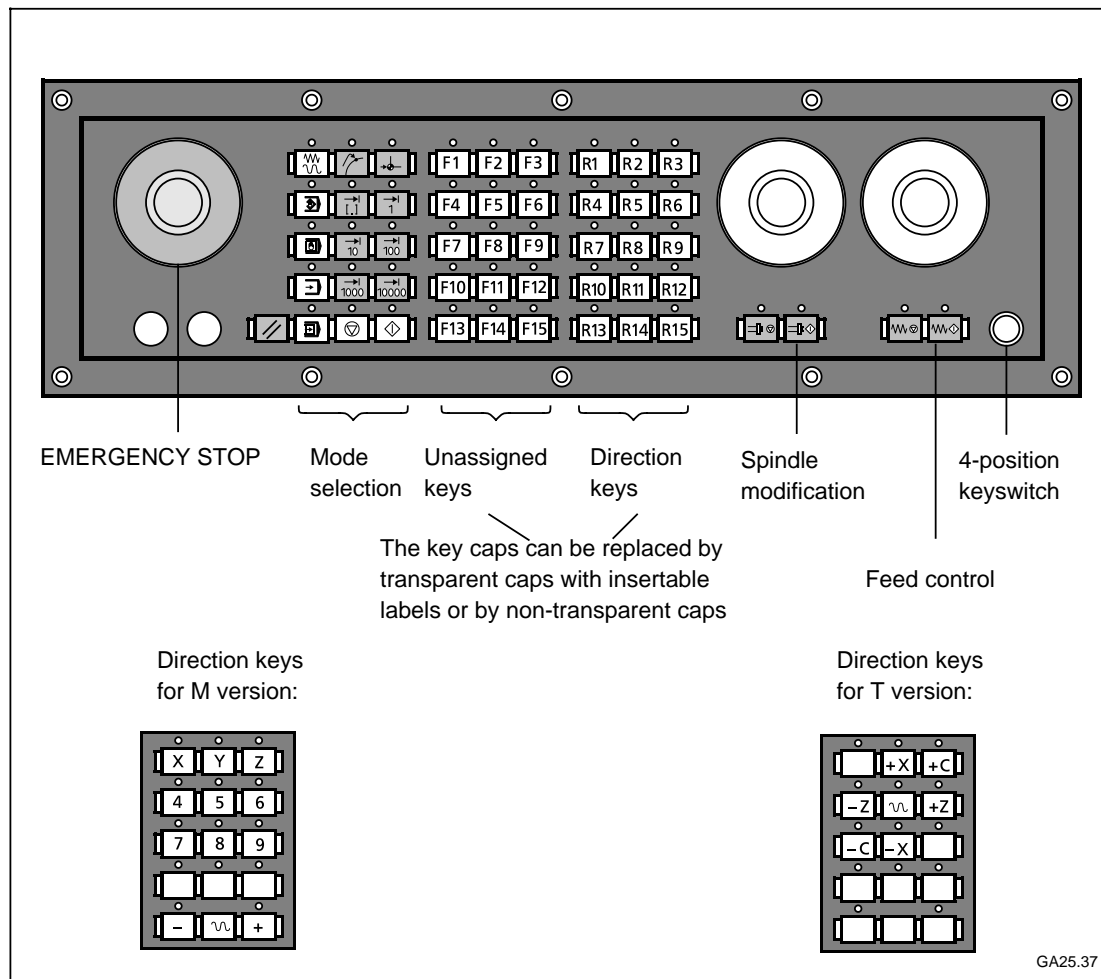

2.2.8.1 Processing of machine control panel signals

The DMP station of the machine control panel is connected to the PLC interface, the PLC 135 WD or the DMP interface via the MPC line. The address area of the machine control panel signals is defined in the case of the DMP interface via PLC MD 34 - 93 and in the case of the PLC interface via PLC MD 94 - 108 or with "free configuring" (see Interface Description Part 1) via a data block.

The address area of the 1st and 2nd machine control panel must be indicated to the operating system via PLC MD 128 and 129. The signal evaluation of the 1st and 2nd machine control panel (mode selection keys, decoding of direction keys/LEDs, transfer of the unassigned customer keys/LEDs to DB40, transfer of the key/LED single block) is then activated via PLC MD 6066.0 and 6067.0.

The decoding of the axis direction keys/LEDs by the operating system can be disabled via PLC MD 6066.5 and/or 6067.5. The user must then implement the decoding himself in his PLC program.

The resulting signal images are then written back into the input/output area (standard: 1st machine control panel IB64 to IB71/QB64 to QB69; 2nd machine control panel IB72 to IB79/QB72 to QB79).

These signal bytes can then be transferred to the axis/spindle/channel DBs via function macros FB78, FB67 and/or FB79.

The user must process the following signals himself even if function macros are used.

- Non-decoded, unassigned direction keys/LEDs
- Feed start/hold, spindle start/stop, NC start/stop LEDs
- Unassigned customer keys/LEDs

Additional DMP stations (keyboard interface/slimline operator panel) can be connected and used as additional machine control panels or input/output modules. Further machine control panels (6) can be connected to the assigned DMP stations. The signals of additional machine control panels, however, are not processed by the operating system but are treated as normal DMP inputs/outputs.

The result is a different assignment of the input/output bytes in question, so that transfer of these signal bytes to the axis/spindle/channel DBs can no longer be implemented using the function macros.

The user must therefore program the transfer of these signals himself in his PLC program.

With SW 3 and higher, the PLC MD applicable to the machine control panel are combined in an input display within the PLC machine data. The input display given below shows which PLC MD numbers are assigned to which input fields.

PLC configuration

1st machine control panel

Available:	PLC MD 6066.0
Address:	PLC MD 128
TT machine	PLC MD 6066.4
Direction key processing for user	PLC MD 6066.5

2nd machine control panel

Available:	PLC MD 6067.0
Address:	PLC MD 129
TT machine	PLC MD 6067.4
Direction key processing for user	PLC MD 6067.5

Travel key display for both machine control panels	PLC MD 6065.0
Free configuration	Block type PLC MD 136
	Block number PLC MD 136

Overview

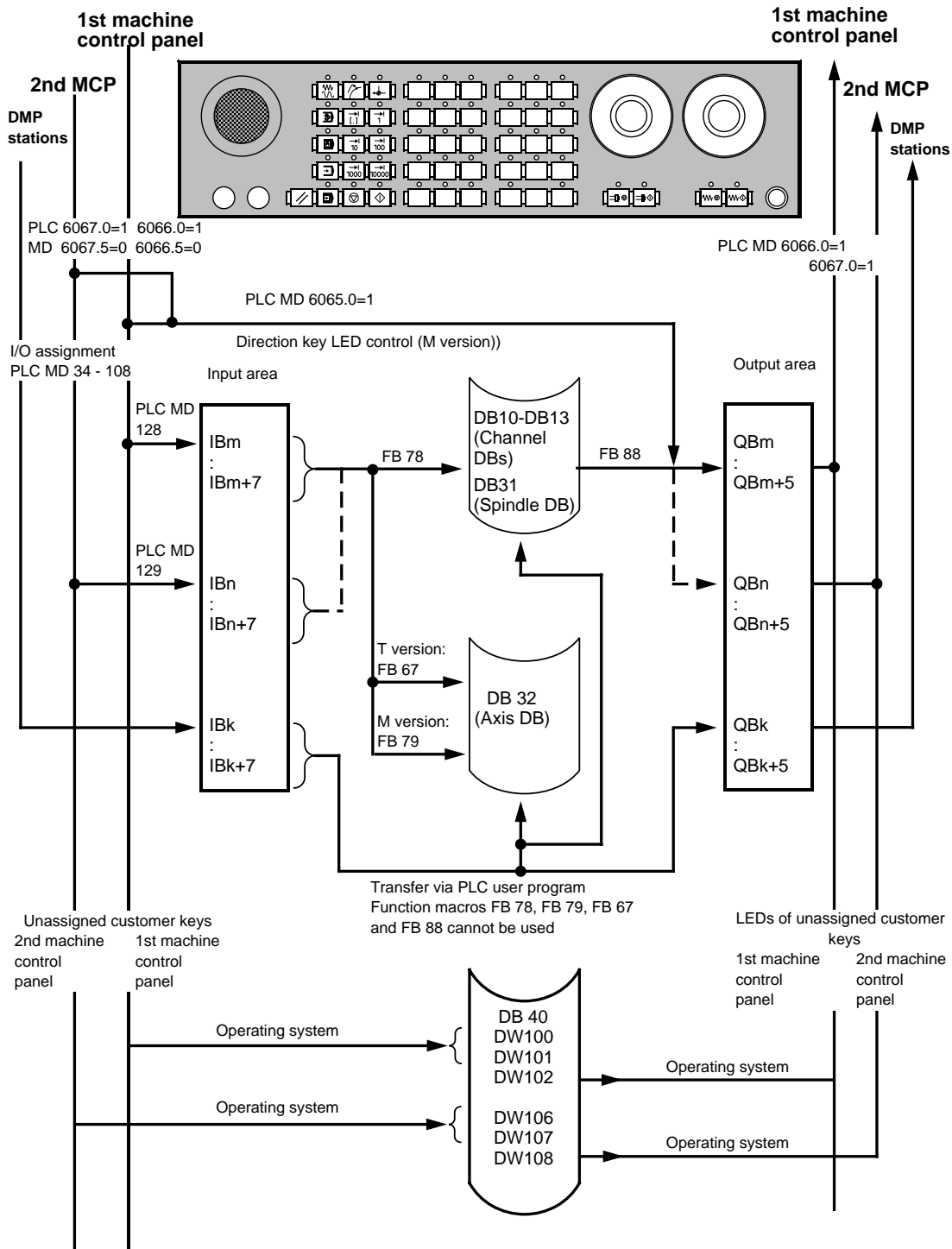

2.2.8.2 Input/output assignment of machine control panel

A machine control panel can be implemented in the following ways on the SINUMERIK 840C:

Case 1 (For T and M versions)

Decoding of mode keys, unassigned customer keys, direction keys via the PLC operating system

PLC MD 6066/6067 bit 0=1
6066/6067 bit 5=0
(M version) 6065 bit 0=1

Case 2 (For T and M versions)

As for case 1, the direction keys/LEDs must, however, be processed by the user

PLC MD 6066/6067 bit 0=1
6066/6067 bit 5=1

Case 3

The machine control panel is treated like a normal DMP module, no decoding by the operating system

PLC MD 6066/6067 bit 0=0

**Case 1: Processing of direction key group via PLC operating system;
 PLC MD 6066/67 bit 0=1, 6066/67 bit 5=0**

Inputs machine control panel T version

Byte No.	Machine control panel basic key group							
	Bit No.							
	7	6	5	4	3	2	1	0
IB m	Spindle override				Keyswitch position			
	D	C	B	A		0	2	3
IB m +1	Direction key 	Direction key 	Rapid traverse 	Direction key 	Direction key 	Slide 1 Slide 2 2)		
IB m +2	Direction key 	Direction key 	Spindle Start 	*Stop 	Feed Start 	*Hold 	NC Start 	*NC Stop
IB m +3	Reset 	Keyswitch position 1	Single block 	E	D	C	B	A
IB m +4					JOG key 	TEACH IN key 	MDA key 	AUT key
IB m +5	REPOS key 	REF key 	VAR 	10 000 	1 000 	100 	10 	1

Byte No.	Unassigned direction keys							
	Bit No.							
	7	6	5	4	3	2	1	0
IB m +6	Key R15 ¹⁾ 	Key R13 ¹⁾ 	Key R14 		Key R1 			Key R10
IB m +7				Key R12 	Key R11 	Key R9 		

You define address m with PLC MD 128 (standard setting: 64) for the 1st machine control panel and with PLC MD 129 (standard setting:72) for the 2nd machine control panel.

Note:

The address m is the same for the input and output area.

* An "inverse signal" which has an effect when 0 and not 1.



















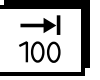













1) Not applicable to 840C (double slide)

2) Applies to double slide only (PLC MD 6066/67 bit 4=1);

0 signal: slide 1 selected with key R13

1 signal: slide 2 selected with key R15























Machine control panel outputs, T version



Control of LEDs								
Byte No.	Bit No.							
	7	6	5	4	3	2	1	0
QB m					LED JOG 	LED TEACH IN 	LED MDA 	LED AUT 
QB m +1	REPOS key 	REF key 	VAR key 	LED 10 000 	LED 1 000 	LED 100 	LED 10 	LED 1 
QB m +2			LED spindle start 	LED spindle stop 	LED feed start 	LED feed hold 	LED NC Start 	LED NC Stop 
QB m +3			LED single block 					
QB m +4	LED slide 2 or R15 	LED slide 1 or R13 			LED R1 	LED R4 	LED R7 	LED R10 
QB m +5	LED R2 	LED R3 	LED R5 	LED R12 	LED R11 	LED R9 	LED R8 	LED R6 

Note:

The address m is the same for the input and output area.

Machine control panel inputs M version

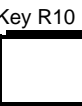
Machine control panel basic key block									
Byte No.	Bit No.								
	7	6	5	4	3	2	1	0	
IB m	Spindle override				Keyswitch position				
	D	C	B	A		0	2	3	
IB m +1	Direction key 	Direction key 	Rapid traverse 	Axis selection, Gray coded, keys X, Y, Z, 4 to 9					
			E	D	C	B	A		
IB m +2			Spindle		Feed		NC Start	*NC Stop	
			Start 	*Stop 	Start 	*Hold 			
IB m +3	Reset 	Keyswitch position 1	Single block 	E	Feed override switch				
				D	C	B	A		
IB m +4					JOG key 	TEACH IN key 	MDA key 	AUT key 	
IB m +5	REPOS key 	REF key 	VAR 	INC					
			10 000 	1 000 	100 	10 	1 		

Unassigned direction keys								
Byte No.	Bit No.							
	7	6	5	4	3	2	1	0
IB m +6								Key R10 
IB m +7				Key R12 	Key R11 			

You define address m with PLC MD 128 (standard setting: 64) for the 1st machine control panel and with PLC MD 129 (standard setting: 72) for the 2nd machine control panel.

Note:

Address m is the same for the input and output area.

* An "inverse signal" which has an effect when 0 and not 1.

Machine control panel outputs M version

Control of LEDs								
Byte No.	Bit No.							
	7	6	5	4	3	2	1	0
QB m					LED JOG 	LED TEACH IN 	LED MDA 	LED AUT
QB m +1	REPOS key 	REF key 	VAR key 	LED 10 000 	LED 1 000 	LED 100 	LED 10 	LED 1
QB m +2			LED spindle start 	LED spindle stop 	LED feed start 	LED feed hold 	LED NC Start 	LED NC Stop
QB m +3			LED single block 					
QB m +4	LED R15 	LED R13 			LED R1 	LED R4 	LED R7 	LED R10
QB m +5	LED R2 	LED R3 	LED R5 	LED R12 	LED R11 	LED R9 	LED R8 	LED R6

You define address m with PLC MD 128 (standard setting: 64) for the 1st machine control panel and with PLC MD 129 (standard setting: 72) for the 2nd machine control panel.

Note:

Address m is the same for the input and output area.

































**Case 2: Processing of direction key group by user: PLC MD 6066/67
 bit 0=1; 6066/67 bit 5=1**

Machine control panel inputs T version

Machine control panel basic key group								
Byte No.	Bit No.							
	7	6	5	4	3	2	1	0
IB m	Spindle override D C B A				Keyswitch position 0 2 3			
IB m +1								
IB m +2			Spindle Start 	*Stop 	Feed Start 	*Hold 	NC Start 	*NC Stop
IB m +3	Reset 	Keyswitch position 1	Single block 	E	Feed override switch D C B A			
IB m +4					JOG key 	TEACH IN key 	MDA key 	AUT key
IB m +5	REPOS key 	REF key 	VAR 	10 000 	1 000 	100 	10 	1

Direction keys								
Byte No.	Bit No.							
	7	6	5	4	3	2	1	0
IB m +6	Key R15 	Key R13 	Key R14 		Key R1 	Key R4 	Key R7 	Key R10
IB m +7	Key R2 	Key R3 	Key R5 	Key R12 	Key R11 	Key R9 	Key R8 	Key R6

Machine control panel outputs T version

Control of LEDs								
Byte No.	Bit No.							
	7	6	5	4	3	2	1	0
QB m					LED JOG 	LED TEACH IN 	LED MDA 	LED AUT 
QB m +1	REPOS key 	REF key 	VAR key 	LED 10 000 	LED 1 000 	LED 100 	LED 10 	LED 1 
QB m +2			LED spindle start 	LED spindle stop 	LED feed start 	LED feed hold 	LED NC Start 	LED NC Stop 
QB m +3			LED single block 					
QB m +4	LED R15 	LED R13 			LED R1 	LED R4 	LED R7 	LED R10 
QB m +5	LED R2 	LED R3 	LED R5 	LED R12 	LED R11 	LED R9 	LED R8 	LED R6 

Note:

Address m is the same for the input and output area.

Machine control panel inputs M version

Machine control panel basic key group								
Byte No.	Bit No.							
	7	6	5	4	3	2	1	0
IB m	Spindle override D C B A				Keyswitch position 0 2 3			
IB m +1								
IB m +2			Start Spindle ~ Stop	Start Feed ~ Hold	NC Start	* NC Stop		
IB m +3	Reset	Keyswitch position 1	Single block	E	Feed override switch D C B A			
IB m +4					JOG key	TEACH IN key	MDA key	AUT key
IB m +5	REPOS key	REF key	VAR	INC 10.000 1.000 100 10 1				

Direction keys								
Byte No.	Bit No.							
	7	6	5	4	3	2	1	0
IB m +6	Key R15	Key R13	Key R14		Key R1	Key R4	Key R7	Key R10
IB m +7	Key R2	Key R3	Key R5	Key R12	Key R11	Key R9	Key R8	Key R6

Machine control panel outputs M version

Control of LEDs								
Byte No.	Bit No.							
	7	6	5	4	3	2	1	0
QB m					LED JOG 	LED TEACH IN 	LED MDA 	LED AUT
QB m +1	REPOS key 	REF key 	VAR key 	LED 10 000 	LED 1 000 	LED 100 	LED 10 	LED 1
QB m +2			LED spindle start 	LED spindle stop 	LED feed start 	LED feed hold 	LED NC Start 	LED NC Stop
QB m +3			LED single block 					
QB m +4	LED R15 	LED R13 			LED R1 	LED R4 	LED R7 	LED R10
QB m +5	LED R2 	LED R3 	LED R5 	LED R12 	LED R11 	LED R9 	LED R8 	LED R6

Note:

Address m is the same for the input and output area.























































DB 40: Customer assignable keys/LEDs

Assignment for 1st machine control panel (PLC MD 6066.0=1)								
Byte No.	Bit No.							
	7	6	5	4	3	2	1	0
DL 100	Free keys dynamic							
	F1	F2	F3	F4	F5	F6	F7	F8
DR 100	Free keys static							
	F1	F2	F3	F4	F5	F6	F7	F8
DL 101	Free keys dynamic							
	F9	F10	F11	F12	F13	F14	F15	-
DR 101	Free keys static							
	F9	F10	F11	F12	F13	F14	F15	-
DL 102	Free LEDs							
	F1	F2	F3	F4	F5	F6	F7	F8
DR 102	Free LEDs							
	F9	F10	F11	F12	F13	F14	F15	-

















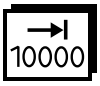





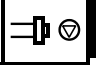









Assignment for 2nd machine control panel (PLC MD 6067.0=1)								
Byte No.	Bit No.							
	7	6	5	4	3	2	1	0
DL 106	Free keys dynamic							
	F1	F2	F3	F4	F5	F6	F7	F8
DR 106	Free keys static							
	F1	F2	F3	F4	F5	F6	F7	F8
DL 107	Free keys dynamic							
	F9	F10	F11	F12	F13	F14	F15	-
DR 107	Free keys static							
	F9	F10	F11	F12	F13	F14	F15	-
DL 108	Free LEDs							
	F1	F2	F3	F4	F5	F6	F7	F8
DR 108	Free LEDs							
	F9	F10	F11	F12	F13	F14	F15	-

Case 3: Machine control panel as DMP module (PLC MD 6066/67 bit 0=0)

Machine control panel inputs

Machine control panel									
Byte No.	Bit No.								
	7	6	5	4	3	2	1	0	
IB m	Spindle override switch D C B A				JOG key 	TEACH IN key 	MDA key 	AUT key 	
IB m +1	REPOS key 	REF key 	VAR 	10 000 	1 000 	100 	10 	1 	
IB m +2	Keyswitch position 0 	Keyswitch position 2 	Spindle Start  *Stop 		Feed Start  *Hold 		NC Start 	NC Stop 	
IB m +3	Reset 	Keyswitch position 1 	Single block 	E	D	C	B	A	
IB m +4	Key R15 	Key R13 	Key R14 	Keyswitch position 3 	Key R1 	Key R4 	Key R7 	Key R10 	
IB m +5	Key R2 	Key R3 	Key R5 	Key R12 	Key R11 	Key R9 	Key R8 	Key R6 	
IB m +6	Key F9 	Key F10 	Key F11 	Key F12 	Key F13 	Key F14 	Key F15 		
IB m +7	Key F1 	Key F2 	Key F3 	Key F4 	Key F5 	Key F6 	Key F7 	Key F8 	

Machine control panel outputs

Control of LEDs								
Byte No.	Bit No.							
	7	6	5	4	3	2	1	0
QB m					LED JOG 	LED TEACH IN 	LED MDA 	LED AUT 
QB m +1	LED REPOS 	LED REF 	LED VAR 	LED 10 000 	LED 1 000 	LED 100 	LED 10 	LED 1 
QB m +2			LED spindle start 	LED spindle stop 	LED feed start 	LED feed hold 	LED NC Start 	LED NC Stop 
QB m +3			LED single block 					
QB m +4	LED R15 	LED R13 			LED R1 	LED R4 	LED R7 	LED R10 
QB m +5	LED R2 	LED R3 	LED R5 	LED R12 	LED R11 	LED R9 	LED R8 	LED R6 
QB m +6	F9	F10	F11	F12	F13	F14	F15	
QB m +7	F1	F2	F3	F4	F5	F6	F7	F8

Note:

Address m is the same for the input and output area.

2.2.9 The pushbutton module

6FX2 006-0AB00

2.2.9.1 Configuration and functionality

The pushbutton module provides a simple and cost-saving way of implementing customized operator panels. The pushbutton module consists of a logic unit with 33 plug-in locations, with pushbuttons and interfaces for connection via a voltage converter module to a keyboard interface.

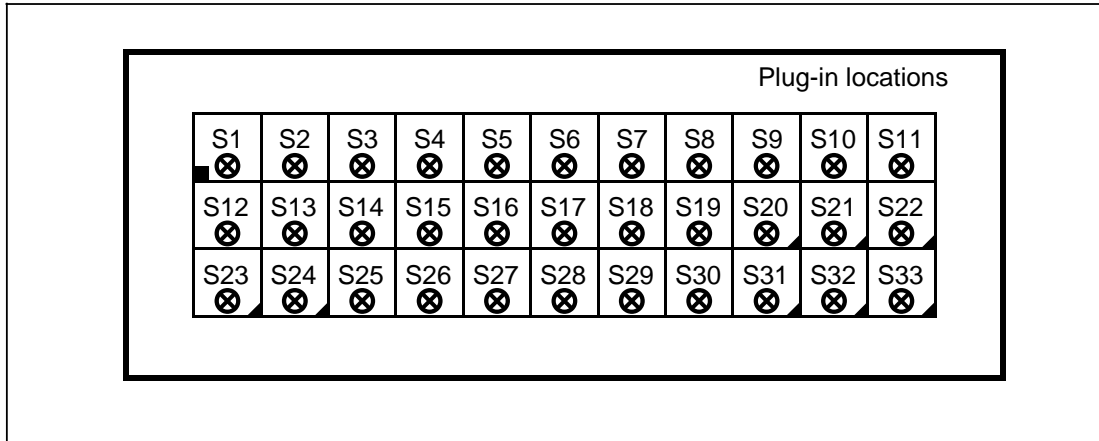

Front view of pushbutton module

- ⊗ Illuminated pushbuttons, signal lamps
- ▲ PLC output, can be switched to illuminated pushbutton or terminal
- Hardware pushbutton/switch

- The pushbutton module can be fitted with max. 33 pushbuttons by the customer. The pushbuttons can be implemented as illuminated pushbuttons, pushbuttons or signal lamps and assigned machine-specific functions.
- Any plug-in locations not required must be fitted with an A0 jumper. Outside, on the mounting plate, these locations are equipped with black blank covers QX24DG. They have degree of protection IP65.
- Insertable legends with the relevant symbols are used to display the functions. Transparent pushbutton caps and spherical caps (when signal lamps are used) are available in clear, red, yellow, green and blue.
- The illuminated pushbuttons and signal lamps are equipped with lamp sockets T5, 5K and 24 V or 30 V, 1.2 W incandescent lamps.
- The pushbutton module occupies a total of 32 inputs and 32 outputs at the PLC user interface.
- Further information regarding the connection of additional display and operator elements to the pushbutton module for configuring a customized machine control panel is given in the Planning Guide: Standard Operator Panels for Machine Tools with SINUMERIK 820/880 (6ZB5 440-0RC01-0BA1).

2.2.9.2 Position of the interfaces

The interfaces of the pushbutton module are implemented with four connectors and four terminal strips. They are located at the back of the pushbutton module.

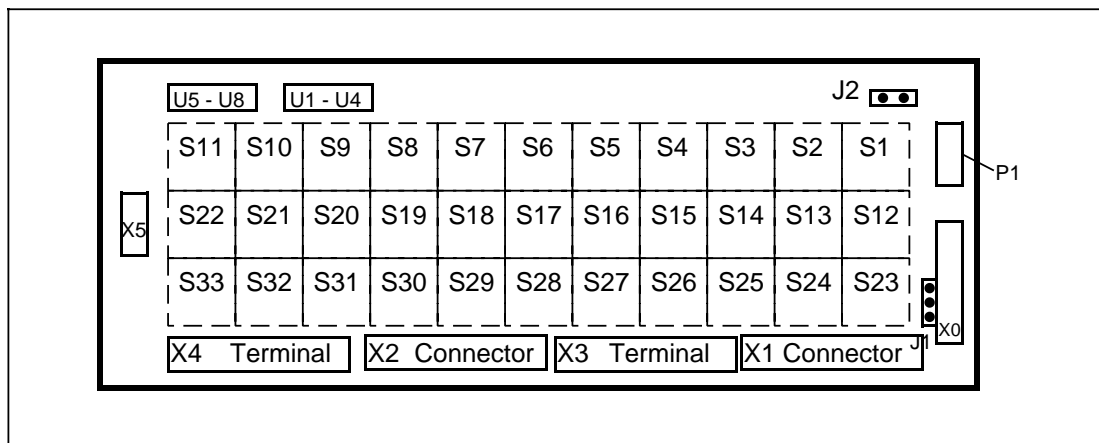

Rear view of pushbutton module

- The connectors X1 and X2 of the pushbutton module are connected to connectors X1 and X2 on the converter module UTS 840C (cf. 2.2.10) with two ribbon cables.
- Inputs and outputs of other control devices can be connected via three terminal strips (X0, X3, X4) and a mini plug connector (X5).
- Pushbutton S1 has a special function (hardware function). It is a double normally open contact and is used to activate the emergency stop circuit while at the same time activating an additional circuit. By making the right connection on the pushbutton module, pushbutton S1 can be used for switching off functions while at the same time setting a PLC input (cf. 2.2.9.3).
- The 32 pushbutton signals (S2 ... S33) of the pushbutton module are evaluated with 8 PLC inputs. 24 additional PLC input signals are available at terminals X3 and X5 for connecting additional control devices (keyswitches, toggle switches, etc.).
- 32 PLC outputs can be assigned to the 32 pushbuttons (S2, ..., S33) when used as illuminated pushbuttons or signal lamps. 8 of these 32 outputs can be switched from the illuminated pushbutton display (S20-S24, S31-S33) to terminal X4 via the DIP switch/U1-U4, U5-U8).

2.2.9.3 Hardware interface

Interfaces on the pushbutton interface

- Connector designation: Pushbutton X0
Connector type: Terminal strip with 6 connections

Terminal strip X0 is used for connecting devices that use the special connection of pushbuttons S1 and S12.

Pin	Signal	Signal	Pin
1	P 24, when S12 is not pressed	Pushbutton S1, contact 43	2
3	Pushbutton S1, contact 44, jumper J1: A-C closed	Pushbutton S1, contact 13	4
5	Pushbutton S1, contact 14	Signal lamp S1, contact X1 X2 connected to ground	6

Circuit connections X0:

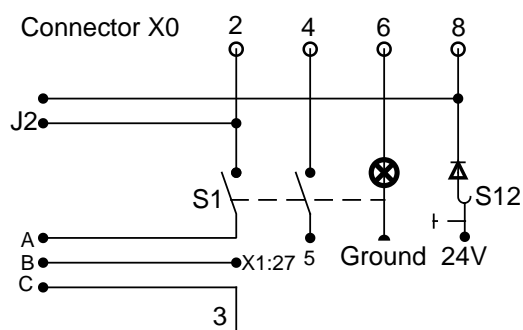

- Connector designation: Pushbutton module X1
 Connector type: Ribbon cable connector DIN 41651, 34-pin

Pushbutton module output signals are transferred to the converter module via connector X1.

Pin	Signal	Type	Signal	Type	Pin
1	free		free		2
3	X3:1	O	X3:2	O	4
5	X3:3	O	X3:4	O	6
7	X3:5	O	X3:6	O	8
9	X3:7	O	X3:8	O	10
11	X3:9	O	X3:10	O	12
13	X3:11	O	X3:12	O	14
15	X3:13	O	X3:14	O	16
17	X3:15	O	X3:16	O	18
19	R1	O	R2	O	20
21	R3	O	W1	O	22
23	W2	O	W4	O	24
25	W8	O	PB	O	26
27	S1	O	X5:1	O	28
29	X5:2	O	X5:3	O	30
31	X5:4	O	X5:5	O	32
33	X5:6	O	X5:7	O	34

Signal name:

- R1 ... 3: Row coding matrix of pushbuttons (cf. 2.2.9.3)
- W1 ... 8: Word coding matrix of pushbuttons
- PB Parity bit
- X3:1 ... 16 Signals from the free inputs of the pushbutton module
- X5:1 ... 7 Signals from the free inputs of the pushbutton module

Signal type:

- O Output

- Connector designation: Pushbutton X2
Connector type: Ribbon cable connector DIN 41651, 34-pin

The signals from the converter module are transferred to the pushbutton module via connector X2.

Pin	Signal	Type	Signal	Type	Pin
1	free	O	free	O	2
3	S2	O	S3	O	4
5	S4	O	S5	O	6
7	S6	O	S7	O	8
9	S8	O	S9	O	10
11	S10	O	S11	O	12
13	S12	O	S13	O	14
15	S14	O	S15	O	16
17	S16	O	S17	O	18
19	S18	O	S19	O	20
21	S20/X4:7 (U1)	O	S21/X4:8 (U2)	O	22
23	S22/X4:9 (U3)	O	S23/X4:10 (U4)	O	24
25	S24/X4:11 (U5)	O	S25	O	26
27	S26	O	S27	O	28
29	S28	O	S29	O	30
31	S30	O	S31/X4:12 (U6)	O	32
33	S32/X4:13 (U7)	O	S33/X4:14 (U8)	O	34

Signal name:

X4:7 ... 14 Signals to free outputs of the pushbutton module

S2 ... 33 Control signals of the LEDs of the pushbuttons (signal lamps) S2... S33

U1 ... 8 Switchover

Signal type:

O Output

Alternatively, the signals of the signal lamps of pushbuttons S20, ..., S24, S31 ... S33 can be redirected to the output pins of connector X4 with the DIP switch (U1, ..., U5, U6, ... , U8).

- Connector designation: Pushbutton module X3
 Connector type: Terminal strip with 16 connections

Inputs from control devices can be connected via this connector.

Pin	Signal	Type	Signal	Type	Pin
1	Free input	I	Free input	I	2
3	Free input	I	Free input	I	4
5	Free input	I	Free input	I	6
7	Free input	I	Free input	I	8
9	Free input	I	Free input	I	10
11	Free input	I	Free input	I	12
13	Free input	I	Free input	I	14
15	Free input	I	Free input	I	16

Signal type:

I Input

- Connector designation: Pushbutton module X4
 Connector type: Terminal strip with 14 connections

Connector X4 comprises the free outputs (U1, ..., U8) with which additional control devices or displays can be controlled, the power supply, as well as the supply of the current actual value voltage for the LED display of the current actual value.

Pin	Signal	Type	Signal	Type	Pin
1	P24	IV	P24	IV	2
3	GND	IV	GND power supply	IV	4
5	GND for LED display	I	Actual value for LED display	I	6
7	Free output (U1)	O	Free output (U2)	O	8
9	Free output (U3)	O	Free output (U4)	O	10
11	Free output (U5)	O	Free output (U6)	O	12
13	Free output (U7)	O	Free output (U8)	O	14

Signal names:

P24 Power supply +24V
 GND Ground
 U1 ... 8 Switchover

Signal type:

O Output
 IV Power supply

- Connector designation: Pushbutton module X5
Connector type: Mini connector, 8-pin, male

Inputs from additional control devices can be connected via this connector.

Pin	Signal	Type	Signal	Type	Pin
1	Free input	I	Free input	I	2
3	Free input	I	Free input	I	4
5	Free input	I	Free input	I	6
7	Free input	I	+24 V	VO	8

Signal type:

I Input

VO Power supply for the control device in question

- Connector designation: Pushbutton module P1
Connector type: Mini connector, 6-pin, male

An LED display module can be connected to the pushbutton module via this connector.
The required measuring voltage for the current actual value is supplied via pins X4: 5, 6.

Pin	Signal	Type	Signal	Type	Pin
1	+24 V, Power supply	VO		O	2
3	GND for LED				4
5		O	Actual value for LED	O	6
7	• jumper		• jumper		8
9	GND, power supply	VO			10

Signal name:

M Ground

Signal type:

O Output

VO Voltage supply output for LED display

2.2.10 Voltage converter module UTS 840C

2.2.10.1 Connection overview

The voltage converter module is used for connecting the pushbutton module to a SINUMERIK 840C keyboard interface module.

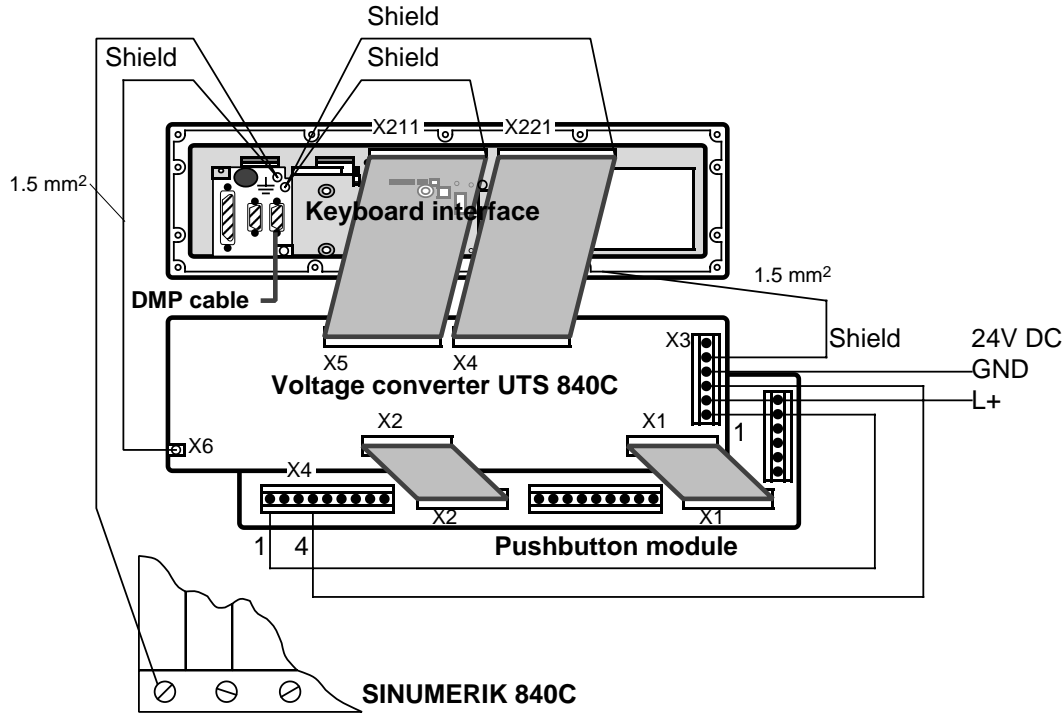

- The voltage converter module is responsible for adapting the input/output signals (0 or 24V) of the pushbutton module to the signal level (0 or 5 V) of the SINUMERIK 840C keyboard interface module.
- The converter module also implements signal and electrical isolation using optocouplers.
- The voltage converter module is connected to the keyboard interface via two shielded ribbon cables which are included in the scope of supply of the module. The two cables are approx. 40 cm long and pin 1 and pin 64 are disconnected.

Standard set of cables 1 or 2 must not be used to connect the converter module to the keyboard interface of SINUMERIK 840C.

2.2.10.2 Hardware interface

- Connector designation: Converter module X1
Connector type: Ribbon cable connector DIN 41651, 34-pin
Pin assignment: (identical to X1 on pushbutton module)
- Connector designation: Converter module X2
Connector type: Ribbon cable connector DIN 41651, 34-pin
Pin assignment: (identical to X2 on pushbutton module)
- Connector designation: Converter module X3
Connector type: Terminal strip with 6 pins

Pin	Signal	Type
6	Shield	
5	Shield	
4	GND	VI
3	GND	VI
2	P24	VI
1	P24	VI

Signal name:

GND	Ground 0V
Shield	Shield, 1.5 mm ²
P24	+24V

Signal type:

VI	Voltage input
----	---------------

- Connector designation: Converter X4
 Connector type: Ribbon cable connector DIN 41651, 64-pin

Pin	Signal	Type	Signal	Type	Pin
1	Shield		reserved		2
3	reserved		reserved		4
5	S2	I	S3	I	6
7	S4	I	S5	I	8
9	S6	I	S7	I	10
11	S8	I	S9	I	12
13	S18		reserved		14
15	reserved		reserved		16
17	GND	VI	reserved		18
19	reserved		reserved		20
21	reserved		reserved		22
23	reserved		reserved		24
25	reserved		reserved		26
27	GND	VI	reserved		28
29	reserved		reserved		30
31	reserved		reserved		32
33	reserved		P5	VI	34
35	reserved		GND	O	36
37	reserved		reserved		38
39	reserved		GND	O	40
41	reserved		reserved		42
43	reserved		GND	O	44
45	GND	VI	reserved		49
47	reserved		reserved		48
49	reserved		reserved		50
51	reserved		P5	VI	52
53	reserved				54
55	GND	VI	reserved		56
57	reserved		reserved		58
59	reserved		reserved		60
61	reserved		reserved		62
63	reserved		Shield		64

Signal names:

S2 ... S18 Control signals of signal lamps of pushbuttons S2 ...
 P5 +5V
 Shield Flat ribbon cable shield
 GND Ground = 0 V. Pins 36, ... (NC STOP, FEED STOP, SPINDLE STOP on a machine control panel) are permanently connected to ground on the converter module for safety reasons (cf. 2.2.9.3).

Signal type:

O Output
 VI Voltage output
 I Input

- Connector designation: Converter X5
Connector type: Ribbon cable connector DIN 41651, 64-pin

Pin	Signal	Type	Signal	Type	Pin
1	Shield	I	S10	I	2
3	S11	I	S12	I	4
5	S13	I	S14	I	6
7	S15	I	S16	I	8
9	S17	I	S19	I	10
11	S20/X4:7	I	S21/X4:8	I	12
13	S22/X4:9	I	S23/X4:10	I	14
15	S24/X4:11	I	S25	I	16
17	GND	VI	X3:1	O	18
19	X3:9	O	X3:2	O	20
21	X3:10	O	X3:3	O	22
23	X3:11	O	X3:4	O	24
25	X3:12	O	X3:5	O	26
27	GND	VI	X3:6	O	28
29	X3:13	O	X3:7	O	30
31	X3:14	O	X3:8	O	32
33	X3:15	O	+5V	VI	34
35	X3:16	O	R1	O	36
37	S1	O	R2	O	38
39	X5:1	O	R3	O	40
41	X5:2	O	W1	O	42
43	X5:3	O	W2	O	44
45	GND	VI	W4	O	49
47	X5:4	O	W8	O	48
49	X5:5	O	PB	O	50
51	X5:6	O	P5	VI	52
53	X5:7	O			54
55	GND	VI	S26	I	56
57	S27	I	S28	I	58
59	S29	I	S30	I	60
61	S31/X4:12	I	S32/X4:13	I	62
63	S33/X4:14	I	Shield		64

Signal names:

S1 ... S33 Control signals of pushbutton LEDs (signal lamps) S10 ... S33

X3:1 ... 16,

X4:12 ... 14

X5:1 ... 7 Signals from the free inputs of the pushbutton module

R1, R2, R3 Row code matrix

W1 ... W8 Word code matrix

PB Parity bit

GND Ground

Signal type:

I Input

O Output

VI Voltage input

2.2.10.3 Software interface

The transferred signals are stored in the PLC user interface as shown in the table below.

The base address m results from the keyboard interface module configuration (cf. 2.2.8.1).

The keyboard interface module must be configured as a standard DMP station (not as a machine control panel).

- PLC process input image of pushbutton module

Byte No.	Bit No.								
	7	6	5	4	3	2	1	0	
IB m									
IB m+1									
IB m+2				*		*		*	
IB m+3									
IB m+4	10 X3:8	9 X3:7	8 X3:6	Connector X1 pin no. 7 X3:5		6 X3:4	5 X3:3	4 X3:2	3 X3:1
IB m+5	18 X3:16	17 X3:15	16 X3:14	Connector X1 pin no. 15 X3:13		14 X3:12	13 X3:11	12 X3:10	11 X3:9
IB m+6	26 PB	25 W8	24 W4	Connector X1 pin no. 23 W2		22 W1	21 R3	20 R2	19 R1
IB m+7	34 X5:7	33 X5:6	32 X5:5	Connector X1 pin no. 31 X5:4		30 X5:3	29 X5:2	28 X5:1	27 S1

*) The signals NC STOP, FEED STOP and SPINDLE STOP are safety functions and have a LOW signal in the inactive state (cf. connector X4). They are permanently connected to earth on the voltage converter module so that their functions cannot be implemented on the pushbutton module.

- PLC output image

Byte No.	Bit No.								
	7	6	5	4	3	2	1	0	
QB m									
QB m+1	10 S9	9 S8	8 S7	Connector X2 pin no. 7 S6		6 S5	5 S4	4 S3	3 S2
QB m+2				Connector X2 pin no.				19 S18	
QB m+3									
QB m+4									
QB m+5	18 S17	17 S16	16 S15	Connector X2 pin no. 15 S14		14 S13	13 S12	12 S11	11 S10
QB m+6	26 S25	25 S24/X4:11	24 S23/X4:10	Connector X2 pin no. 23 S22/X4:9		22 S21/X4:8	21 S20/X4:7	20 S19	
QB m+7	34 S33/X4:14	33 S32/X4:13	32 S31/X4:12	Connector X2 pin no. 31 S30		30 S29	29 S28	28 S27	27 S26

- Coding table for pushbuttons

Coding Push-signals button	PB	W8	W4	W2	W1	R3	R2	R1
S1	1	0	0	0	1	1	1	0
S2	1	0	0	1	0	1	1	0
S3	0	0	0	1	1	1	1	0
S4	1	0	1	0	0	1	1	0
S5	0	0	1	0	1	1	1	0
S6	0	0	1	1	0	1	1	0
S7	1	0	1	1	1	1	1	0
S8	1	1	0	0	0	1	1	0
S9	0	1	0	0	1	1	1	0
S10	0	1	0	1	0	1	1	0
S11	1	1	0	1	1	1	1	0
S12	1	0	0	0	1	1	0	1
S13	1	0	0	1	0	1	0	1
S14	0	0	0	1	1	1	0	1
S15	1	0	1	0	0	1	0	1
S16	0	0	1	0	1	1	0	1
S17	0	0	1	1	0	1	0	1
S18	1	0	1	1	1	1	0	1
S19	1	1	0	0	0	1	0	1
S20	0	1	0	0	1	1	0	1
S21	0	1	0	1	0	1	0	1
S22	1	1	0	1	1	1	0	1
S23	1	0	0	0	1	0	1	1
S24	1	0	0	1	0	0	1	1
S25	0	0	0	1	1	0	1	1
S26	1	0	1	0	0	0	1	1
S27	1	0	1	0	1	0	1	1
S28	0	0	1	1	0	0	1	1
S29	1	0	1	1	1	0	1	1
S30	1	1	0	0	0	0	1	1
S31	0	1	0	0	1	0	1	1
S32	0	1	0	1	0	0	1	1
S33	1	1	0	1	1	0	1	1

Evaluation of the individual pushbuttons must be implemented in the user's PLC program.

2.2.11 Interface changeover switch

2.2.11.1 Interface changeover switch, old version

Note:

During changeover, the PLC signals KEYBOARD DISABLE and SCREEN DARK should be active in the respective PLCs.

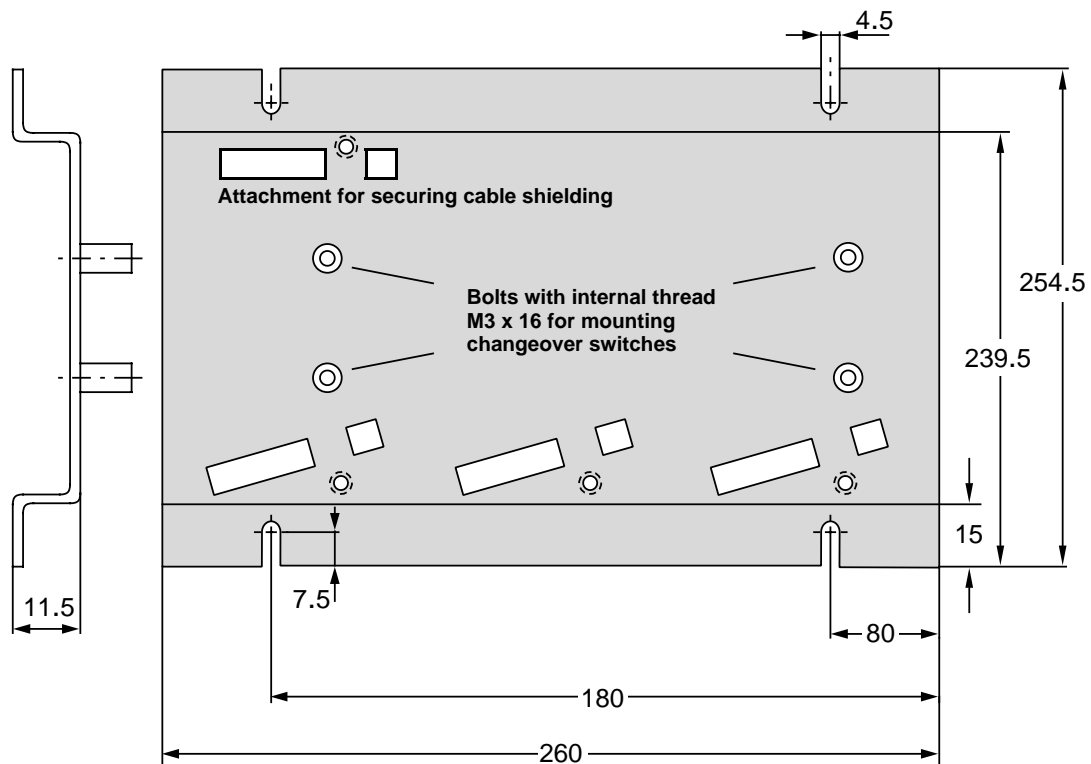
Baseplate**6FC9 310-1MA00**

Mounting heights:	Baseplate	27.5 mm
	Monitor changeover switch	32 mm
	Keyboard changeover switch	22 mm

Monitor changeover switch, 3-way

6FC9 310-1MD00

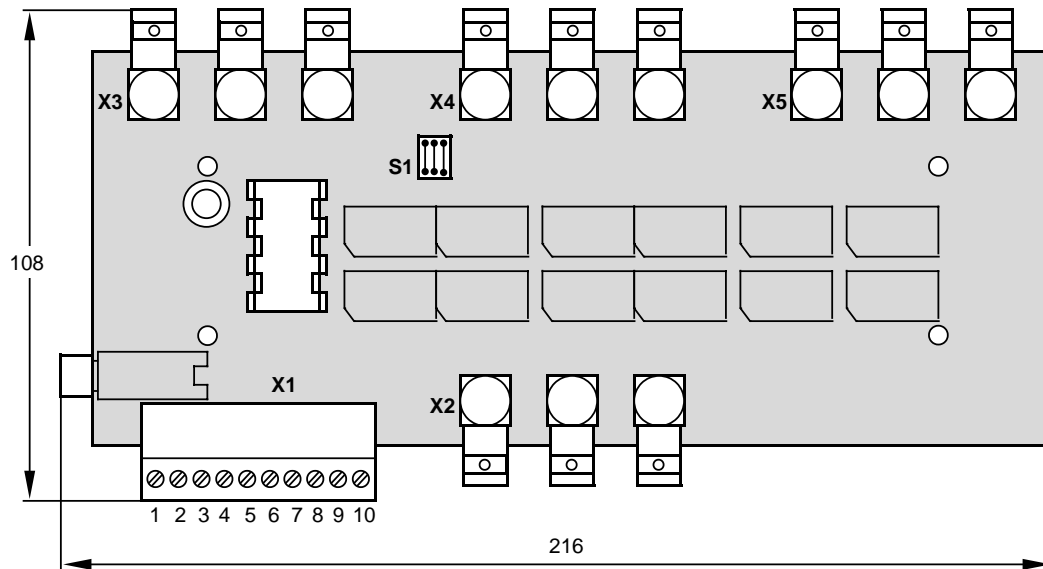

Location of interfaces, operator control and display elements

- X2, X3, X4, X5 Connector: BNC socket 75
- X1 Screw terminals, plug-in terminal strip

Assignment of X1:

- 1 ≙ External 24 V supply for voltage regulators
- 2 ≙ Controlled voltage of 24 V for triggering X3, X4 and X5
- 3, 4 ≙ M_{ext} for terminals 1, 2
- 5 ≙ Switching signal for X3
- 6 ≙ Switching checkback signal for X3
- 7 ≙ Switching signal for X4
- 8 ≙ Switching checkback signal for X4
- 9 ≙ Switching signal for X5
- 10 ≙ Switching checkback signal for X5

- S1 must be closed

Additionally supplied: 4 spacing bolts, 30 mm

Notes:

- No channel is switched without a switching signal. An additional external circuit is required when switching via the PLC so that a channel is enabled on PLC stop.
- Only one channel can be switched at a time.

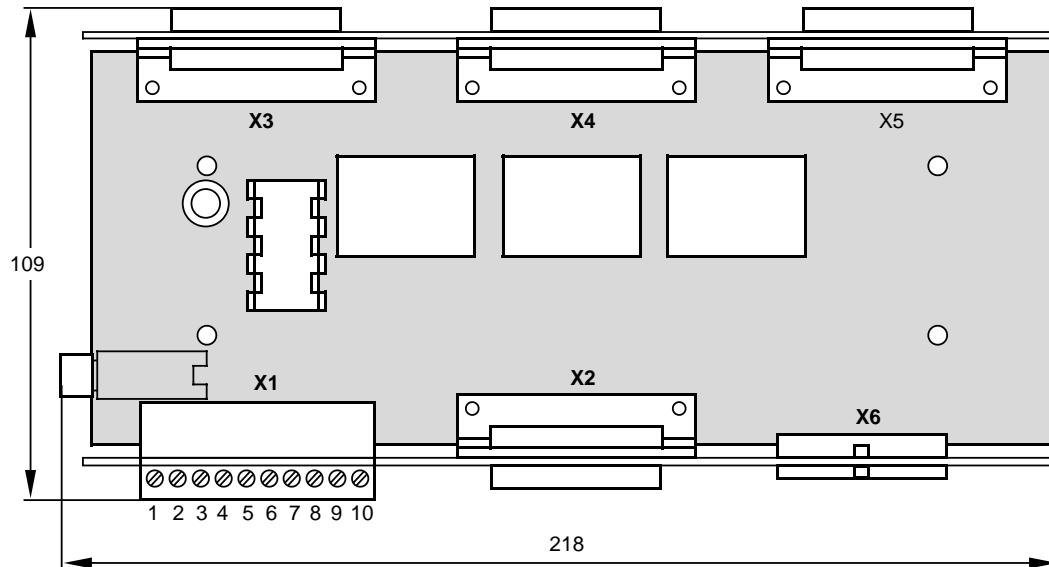
Keyboard changeover switch**6FC9 310-1MB00****Location of interfaces, operator control and display elements**

- X2, X3, X4, X5 Connector: 25-pin Sub-D connector, socket

The following signals are changed over:

- Pin 2; signal TxD
- Pin 3; signal RxD
- Pin 4; signal RTS
- Pin 5; signal CTS
- Pin 6; signal DSR
- Pin 20; signal DTR

- X6: Ribbon cable connector, 20-pin, 2 rows of pins
- X1: Screw terminals, plug-in terminal strip

Assignment of X1:

- 1 $\hat{=}$ External 24 V power supply for voltage regulator
- 2 $\hat{=}$ 24 V controlled voltage for triggering X3, X4 and X5
- 3, 4 $\hat{=}$ M_{ext} for terminals 1, 2
- 5 $\hat{=}$ Switching signal for X3
- 6 $\hat{=}$ Switching checkback signal for X3
- 7 $\hat{=}$ Switching signal for X4
- 8 $\hat{=}$ Switching checkback signal for X4
- 9 $\hat{=}$ Switching signal for X5
- 10 $\hat{=}$ Switching checkback signal for X5

Note:

With the provided ribbon cable with two connectors, additional changeover switches can be connected via X6 without the X1 changeover inputs of these having separate power supplies.

Additionally supplied: – 4 spacing bolts, 30 mm
 – ribbon cable

Notes:

- No channel is switched without a switching signal. An additional external circuit is required when switching via the PLC so that a channel is enabled on PLC stop.
- Only one channel can be switched at a time.

2.2.11.2 Interface changeover switch, new version

The interface changeover switch consists of the following parts:

- Baseplate with cover for the whole unit
- Monitor changeover switch
- Keyboard changeover switch

The maximum installation height of the complete interface changeover switch is 75 mm.

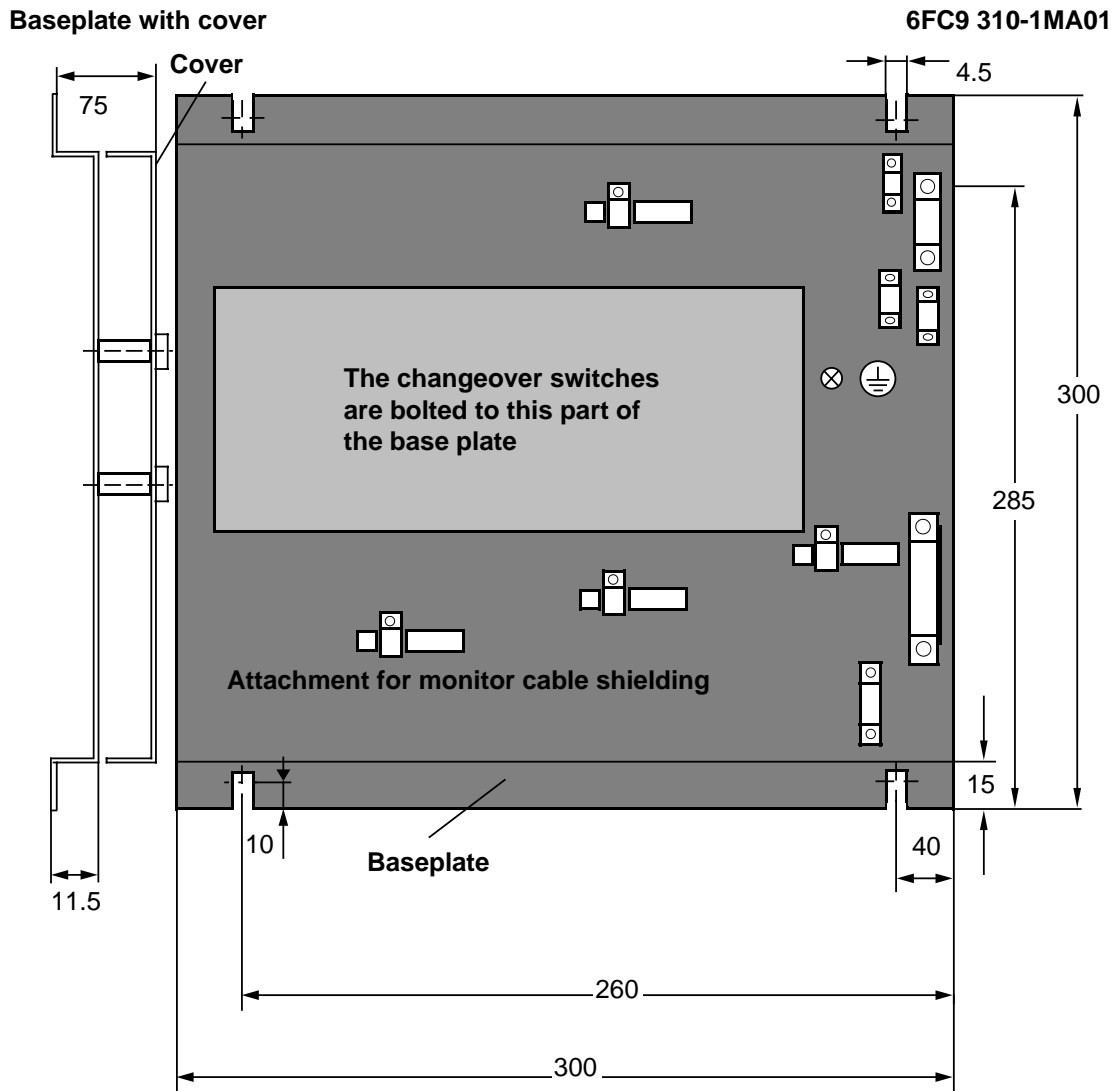

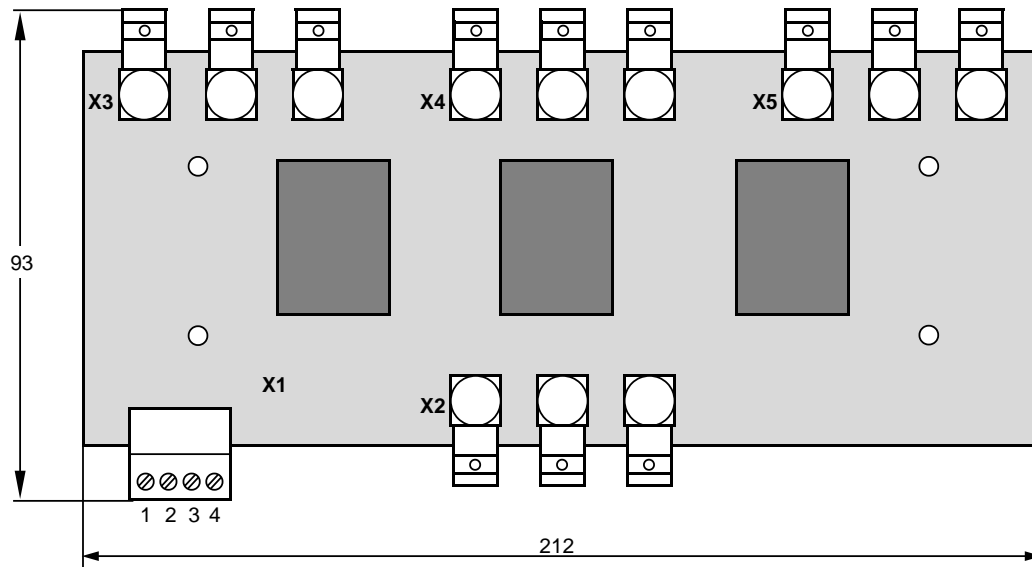
Monitor changeover switch, 3-way**6FC9 310-1MD01****Location of interfaces, operator control and display elements**

- X2, X3, X4, X5 Connector: BNC socket 75
- X1 Screw terminals, plug-in terminal strip

Assignment of X1:

- 1 $\hat{=}$ 24V_{EXT}, breaks the connection between X2 and X3
- 2 $\hat{=}$ 24V_{EXT}, makes the connection between X2 and X4
- 3 $\hat{=}$ 24V_{EXT}, makes the connection between X2 and X5
- 4 $\hat{=}$ 0V_{EXT}, connection to ground to control terminals 1,2 and 3

Additionally supplied: 4 spacing bolts, 30 mm

Notes:

- When not controlled (loss of power, e.g. on PLC STOP), X2 is switched to X3.
- Only one channel can be switched at a time.

Keyboard changeover switch

6FC9 310-1MB01

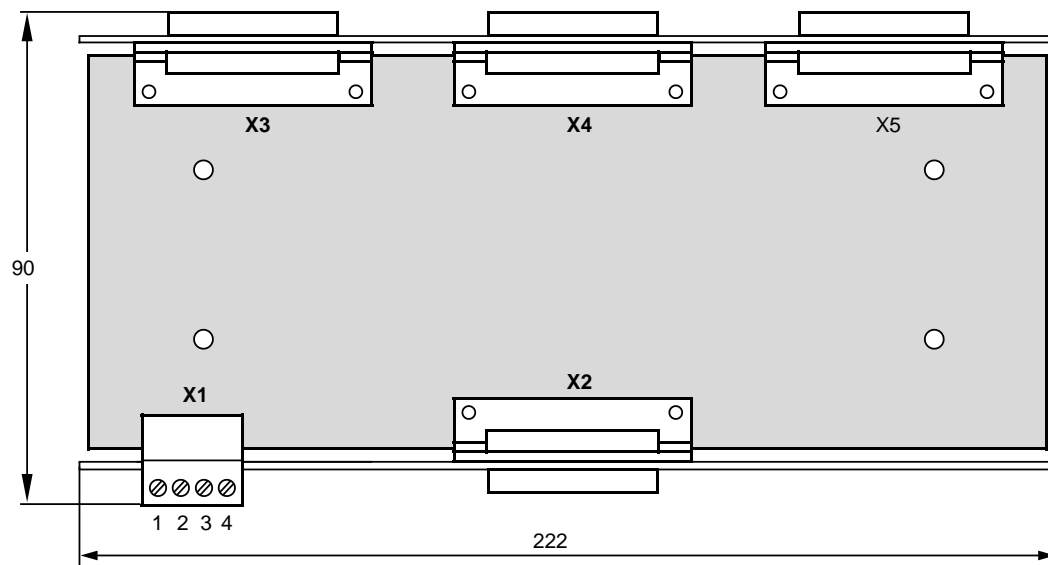

Location of interfaces, operator control and display elements

- X2, X3, X4, X5 Connector: 25-pin Sub-D connector, socket
- X1: Screw terminals, plug-in terminal strip

Assignment of X1:

- 1 $\hat{=}$ 24V_{EXT}, breaks the connection between X2 and X3
- 2 $\hat{=}$ 24V_{EXT}, makes the connection between X2 and X4
- 3 $\hat{=}$ 24V_{EXT}, makes the connection between X2 and X5
- 4 $\hat{=}$ 0V_{EXT}, connection to ground to control terminals 1,2 and 3

Additionally supplied: – 4 spacing bolts, 30 mm

Notes:

- When not controlled (loss of power, e.g. on PLC STOP), X2 is switched to X3.
- Only one channel can be switched at a time.

2.2.11.3 Connection of one operator panel of one color monitor to several NC controls

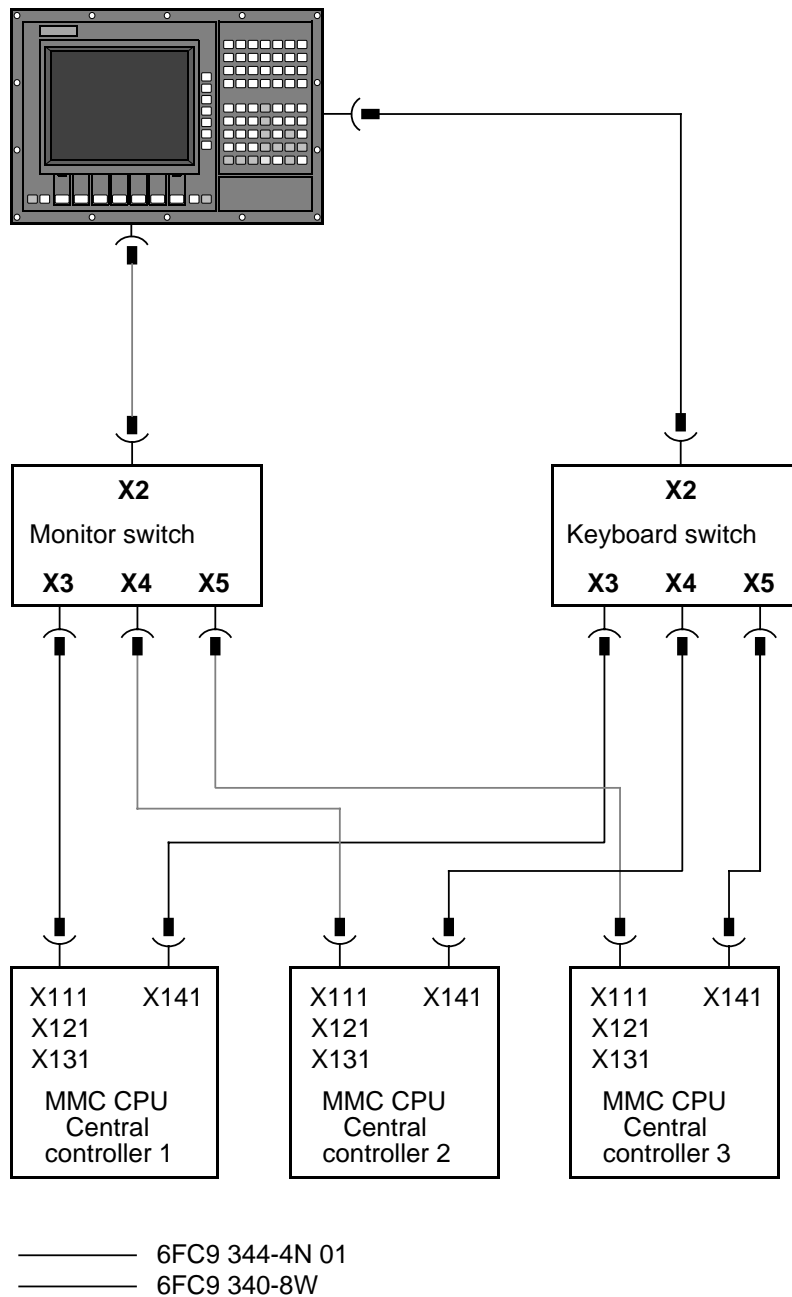

Note:

A 14" color screen monitor together with a NC keyboard can be used instead of a slimline panel.

2.2.11.4 Connection of several operator panels/color monitors to an NC control

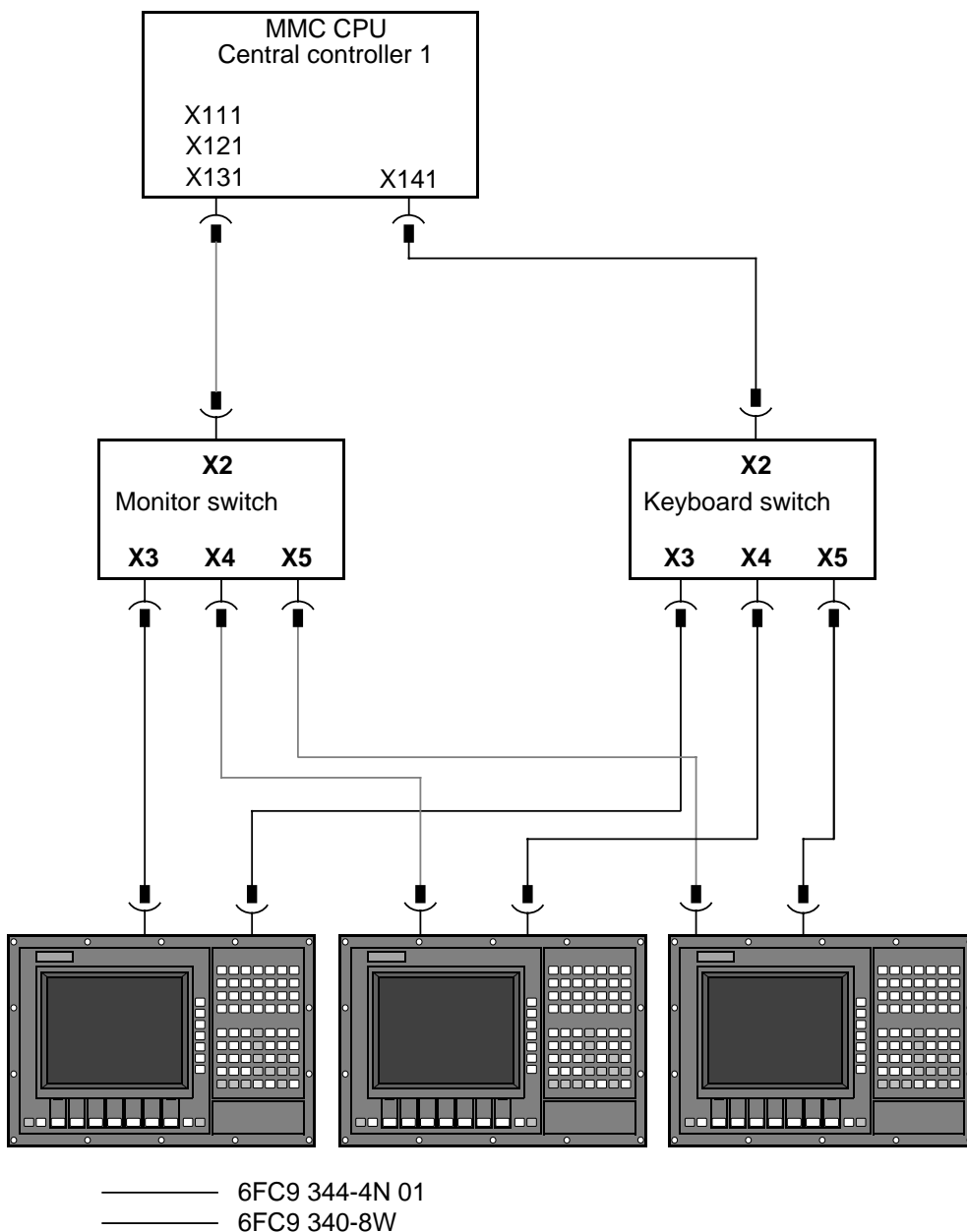

Note:

- If you are using a 14" color screen instead of the slimline operator panel with 9.5" display, you can loop the RGB cable in series connection to the screen for which you will find two RGB sockets on the back of the screen monitor.

The total length of cable 6FC9 344-4N 01 must not exceed 50 m for a maximum of three screen monitors.

Switch the 3 switches of the last 14" color screen monitor or slimline operator panel with 9.5" display to 75 . The slide resistors on all other screen monitors must be positioned to H (high impedance).

- A time interval of 20 ms must lapse between switching off one operator panel and switching on the next operator panel.

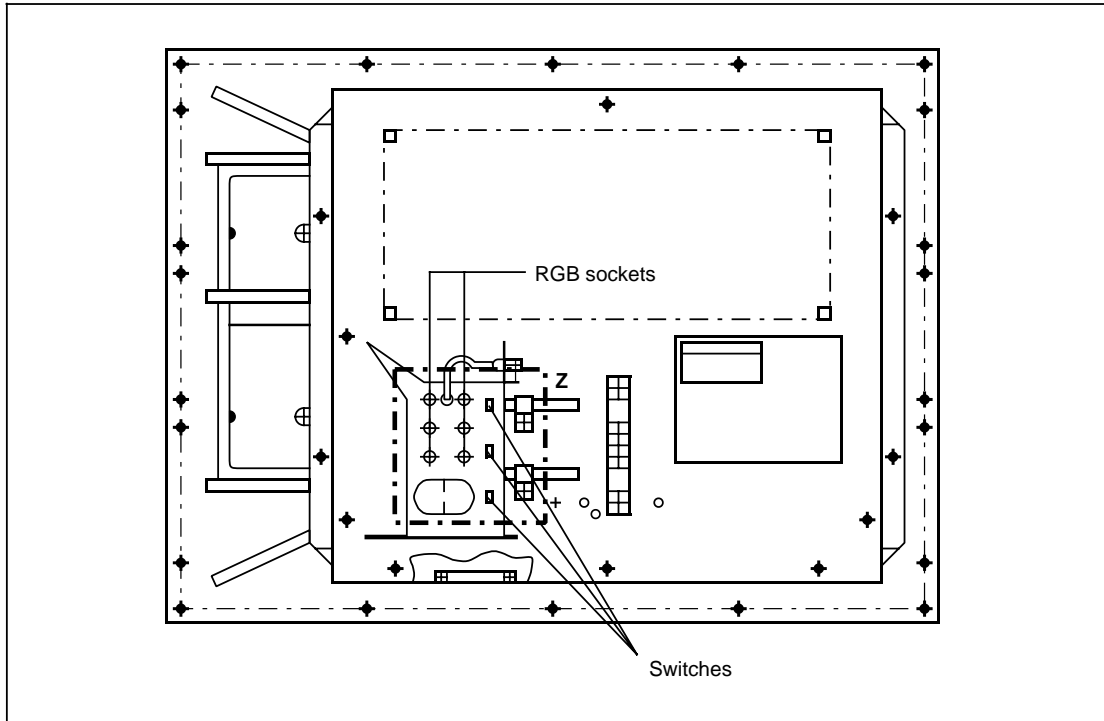

14" monitor unit, rear view

Z detail

Arrangement of the 3 switches on the input PCB:

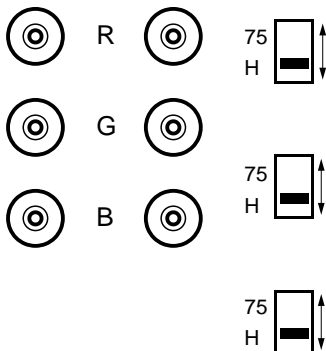

2.2.12 Floppy drive FD-E2

6FC5 135-0AA01-0AA0

This AT compatible diskette drive can be installed in the front panel of the color monitor and 10.4" slimline operator panel (by removing the blanking plate). Alternatively, it can be installed into a customer panel with the required panel cutout. The maximum cable length between control (MMC interface) and operator panel (floppy) must not exceed 50 m.

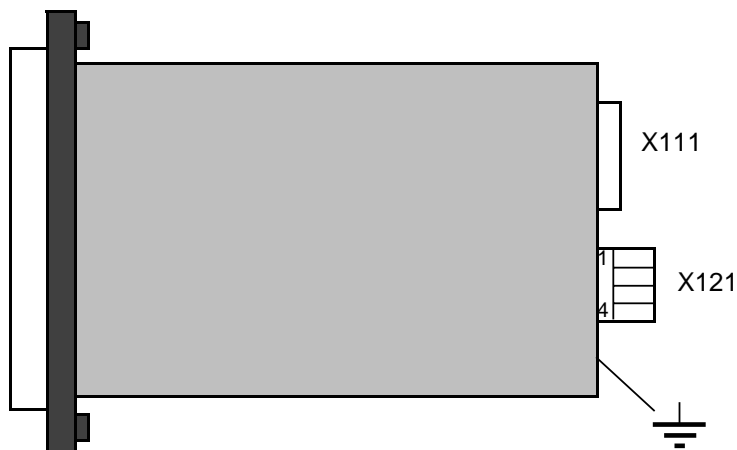

Technical data

- Capacity 1.44 Mbytes
- Type 3.5"
- Power supply: 24 V DC, max. 0.25A
- Vibration immunity of the FD-E2 diskette drive
The manufacturer of this diskette drive guarantees the following values:
 - 1.5 G 10 to 100 Hz
 - 1.0 G 100 to 200 Hz
 - 0.5 G 200 to 600 Hz

Depending on the structure of the whole unit, these values may vary greatly if the diskette drive is installed in the operator panel or in a panel cutout directly at the machine.

Note:

Please refer to Section 3, Connection Conditions, for further technical data and installation instructions!

If the above values are not complied with, read/write errors can occur when accessing data from the diskette drive. Correct functioning of the components can then no longer be guaranteed.

Interfaces

X111: Interface for connection to MMC interface (X131),
cable required 6FC9 344-5G

X121: 4-pin terminal strip, diskette drive power supply

1	Shield
2	+24V _{ext}
3	GND _{ext}
4	Shield

 : Earth terminal

2.3 Central controller

As from SW 3, the PLC CPU 135 WD replaces the PLC CPU 135 WB2 / Interface PLC in the central controllers 1, 2 and 3.

2.3.1 Configuration

Subrack central controller 1, 12 slots

6FC5 101-0AA01-0AA0

When ordered with the above order number the subrack is **not** supplied **with components**.

Possible configuration

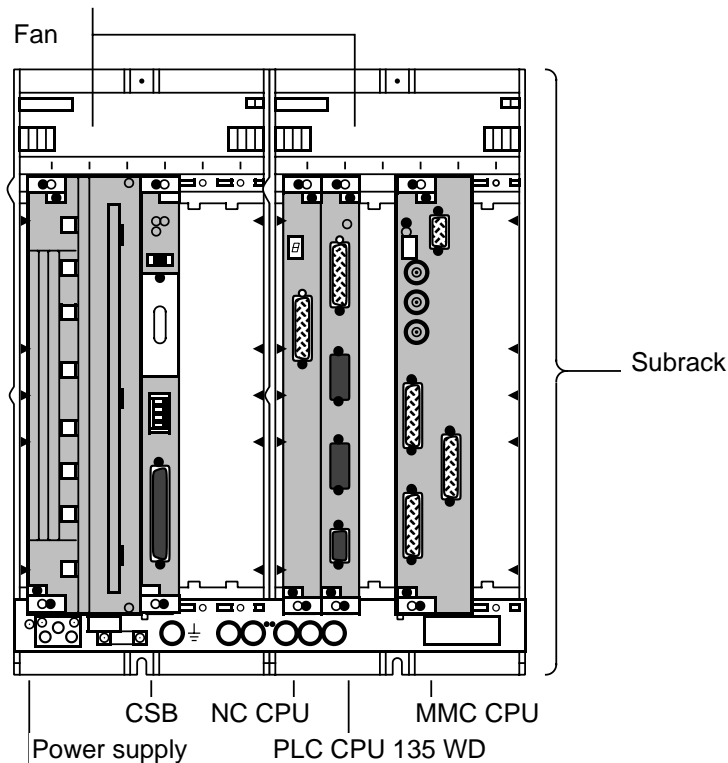

Note:

Please refer to Section "Subrack assignment" for other possible configurations.

The subrack comprises the following:

- Plastic casing with integrated guiderails (12 slots for double-height Eurocard modules)
- Earthing bracket at the front for module earthing and as a common potential distributor
- BUS
- Rear panels
- Fan

On the 230V version, line voltage (230 V AC) is applied to the terminal block at the front of the central controller.

Subrack central controller 2, 18 slots**6FC5 101-0AB01-0AA0**

When ordered with the above order number the subrack is **not** supplied **with components**.

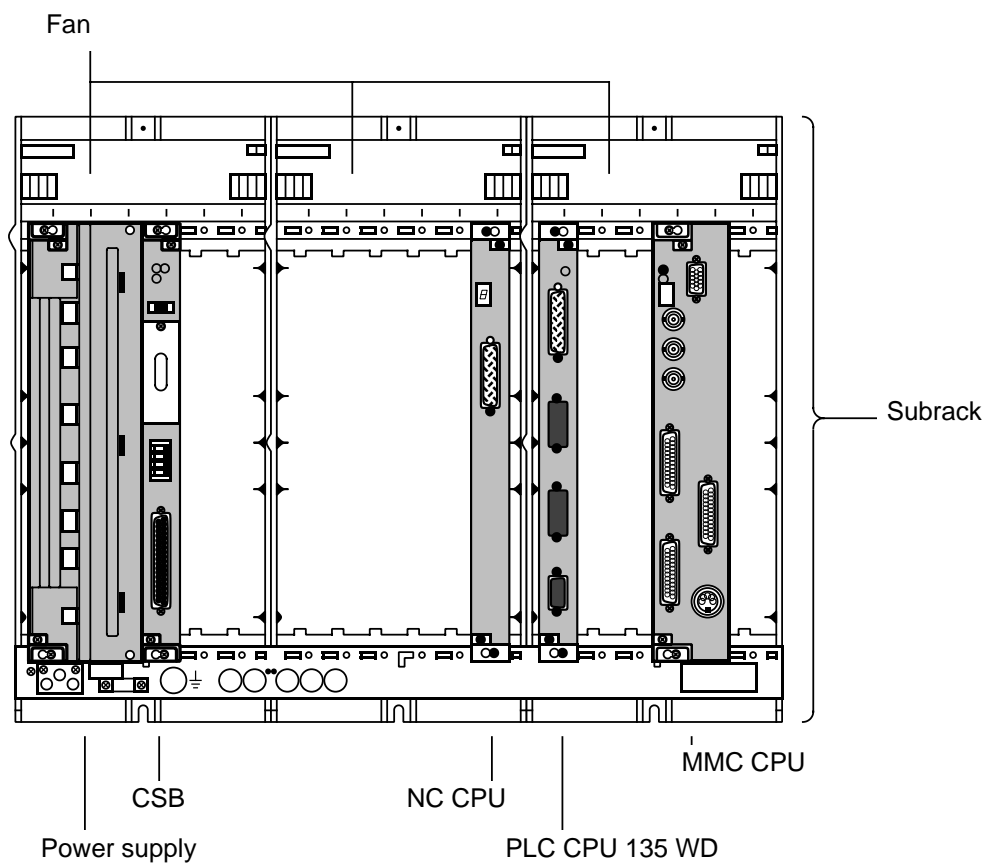
Possible configuration**Note:**

Please refer to Section "Subrack assignment" for other possible configurations.

The subrack comprises the following:

- Plastic casing with integrated guiderails (18 slots for double-height Eurocard modules)
- Earthing bracket at the front for module earthing and as a common potential distributor
- BUS
- Rear panels
- Fan

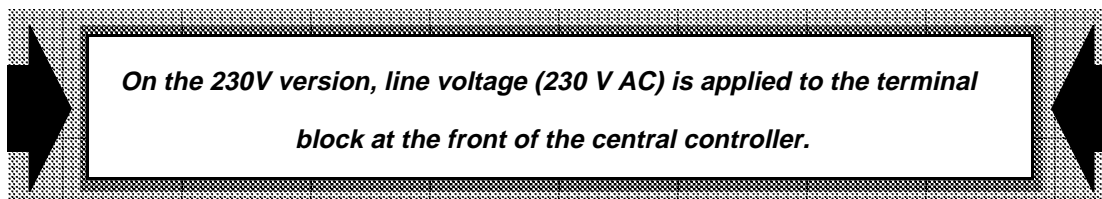

Subrack central controller 3, 18 slots + 3 AT slots

6FC5 101-0AB02-0AA0

When ordered with the above order number the subrack is **not** supplied **with components**.

Possible configuration

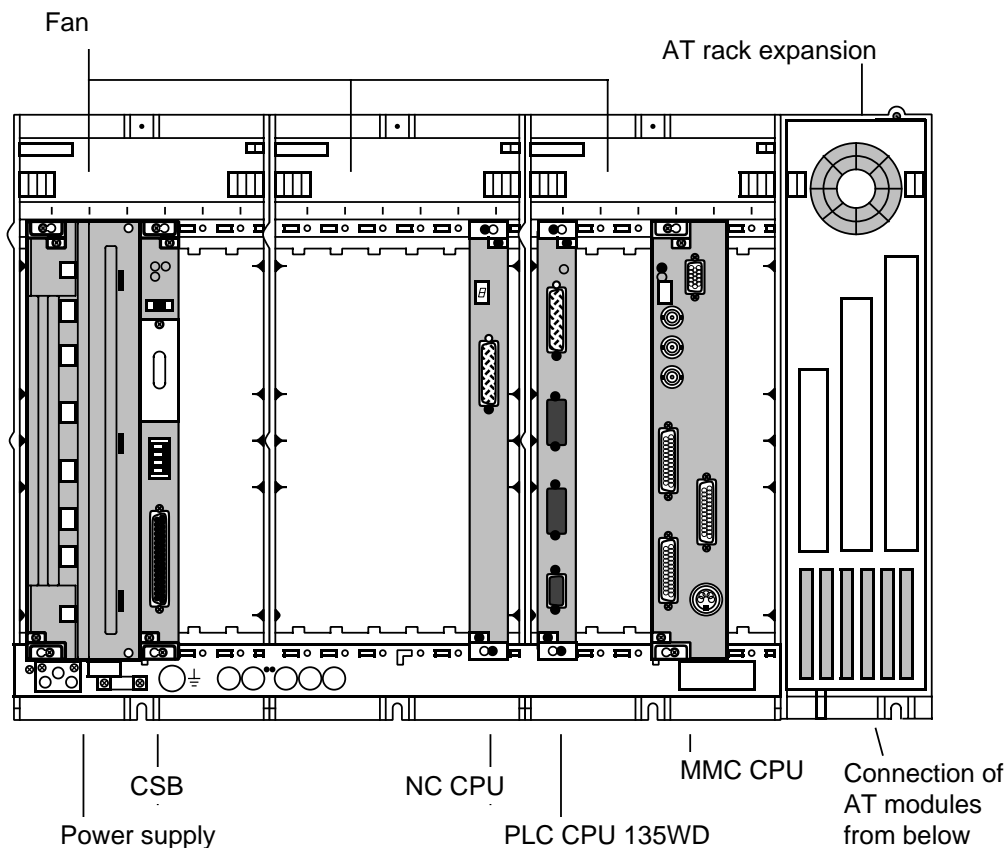

Note:

Please refer to Section "Subrack assignment" for other possible configurations.

The subrack comprises the following:

- Plastic casing with integrated guiderails (18 slots for double-height Eurocard modules + 3 slots for AT modules)
- Earthing bracket at the front for module earthing and as a common potential distributor
- BUS
- Rear panels
- Fan

On the 230V version, line voltage (230 V AC) is applied to the terminal block at the front of the central controller.

2.3.1.1 Fan unit Amplified fan unit

6FC5 147-0AA07-0AA0
6FC5 147-0AA07-0AA1

The fan units spare part order no.: 6FC5 147-0AA07-0AA0 and 147-0AA07-0AA1 are located at the top of the subrack and can be accessed from the front.

The fan units can be replaced at any time. Press the clamps together and pull the fan unit out.

Notes:

- Air filters must not be used (reduces efficiency).
- The fans suck the air out of the subrack and expel it at the top.
- When the power consumption of the CSB is +15 V it is increased by 0.14 A per fan (up to version B) and by 0.18 A as from version C.

Total current	+5 V	+15 V	-15 V	V _{CC}
Typical up to version B	—	0.14 A	—	—
Typical starting from version C	—	0.18 A	—	—

Fan version C is required for the hard disk spare part package
Order No. 6FC5 147-0AA13-0AA0.

Further information about the fan unit is given in Section 3.3.6, Central controller.

2.3.2 Subrack assignment

2.3.2.1 Subrack assignment central controller 1, 12 slots

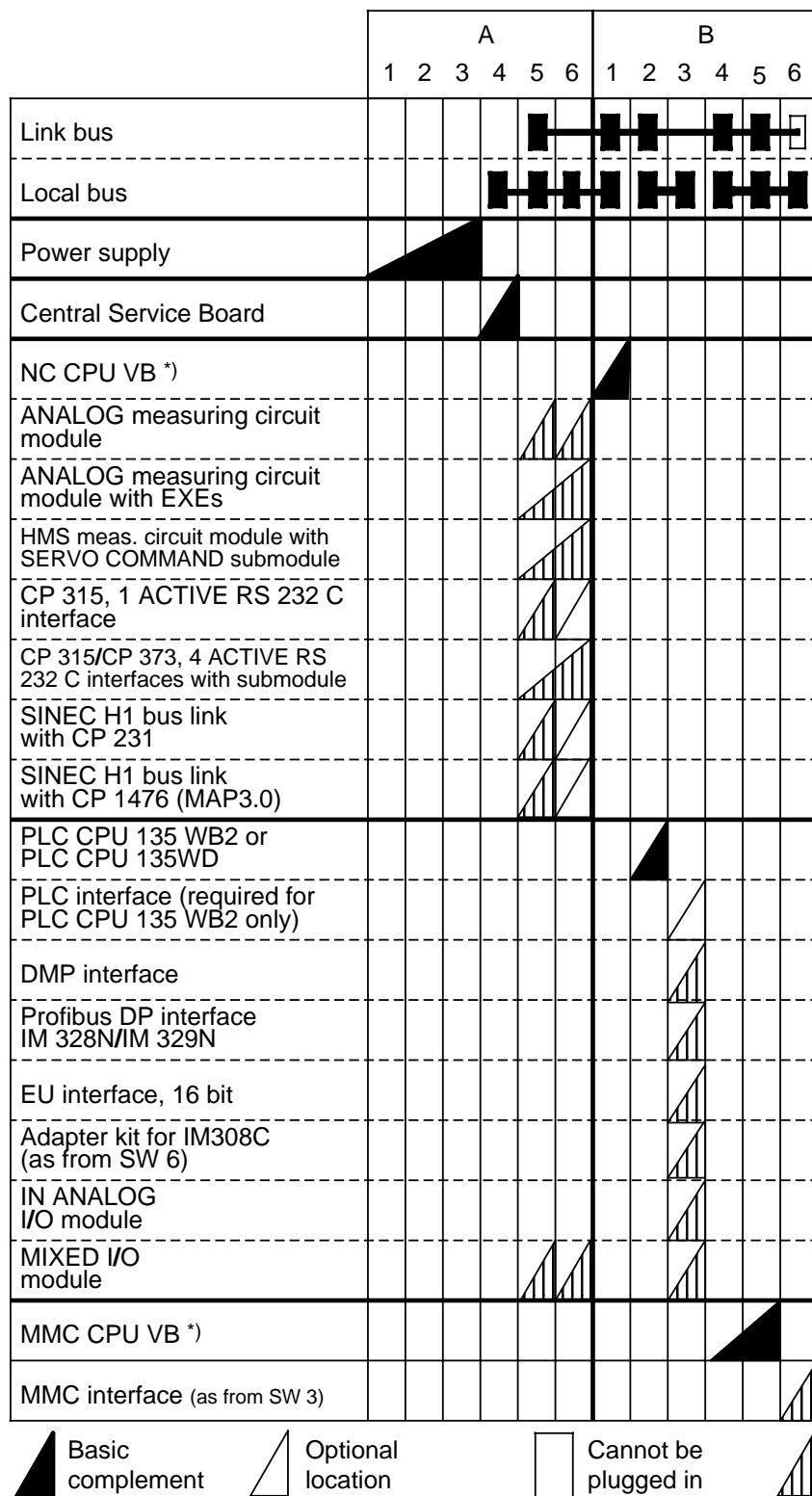

*) VB = Version B

2.3.2.2 Subrack assignment central controller 2, 18 slots

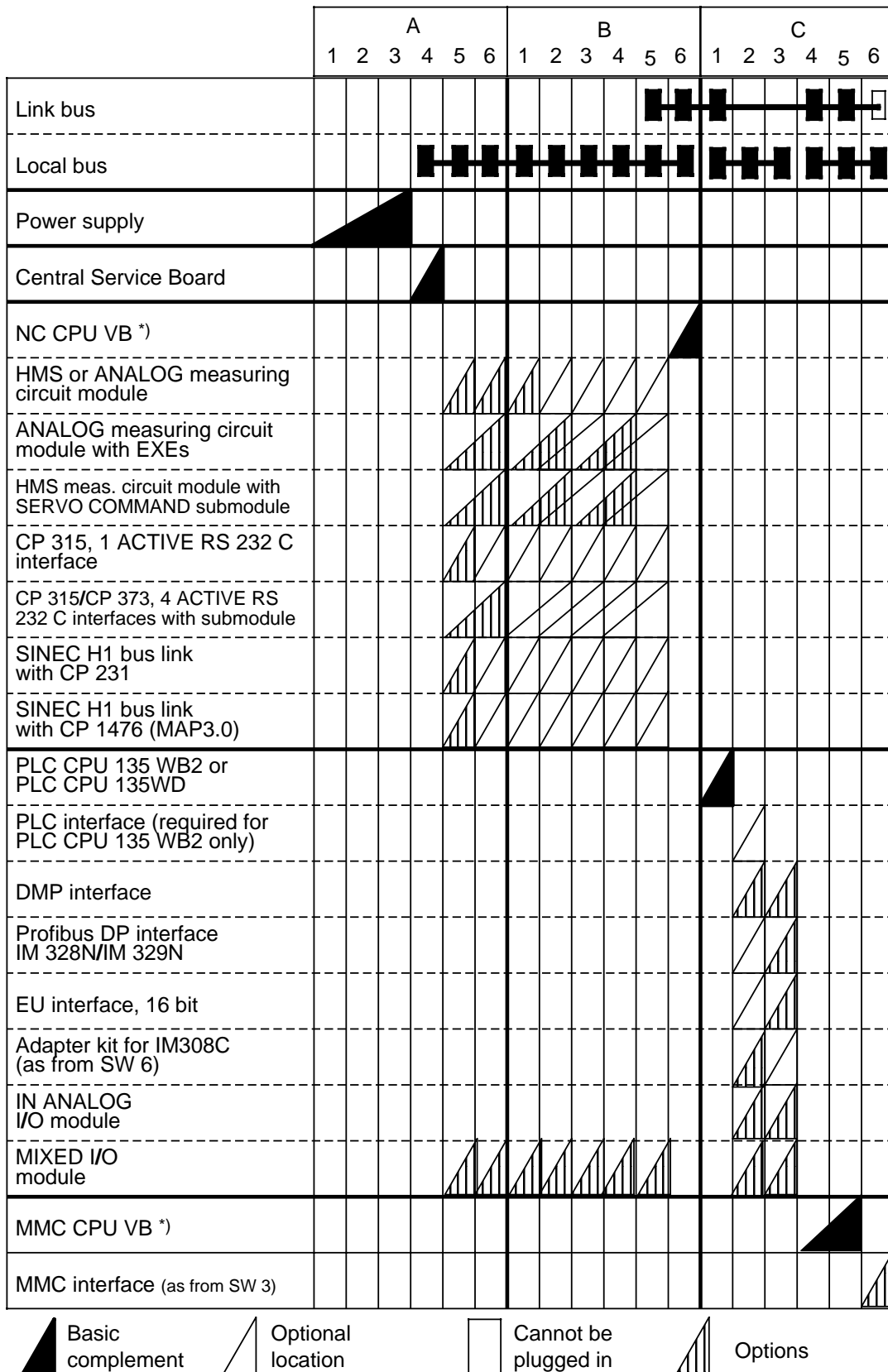

*) VB = Version B

2.3.2.3 Subrack assignment central controller 3, 18 + 3 AT slots

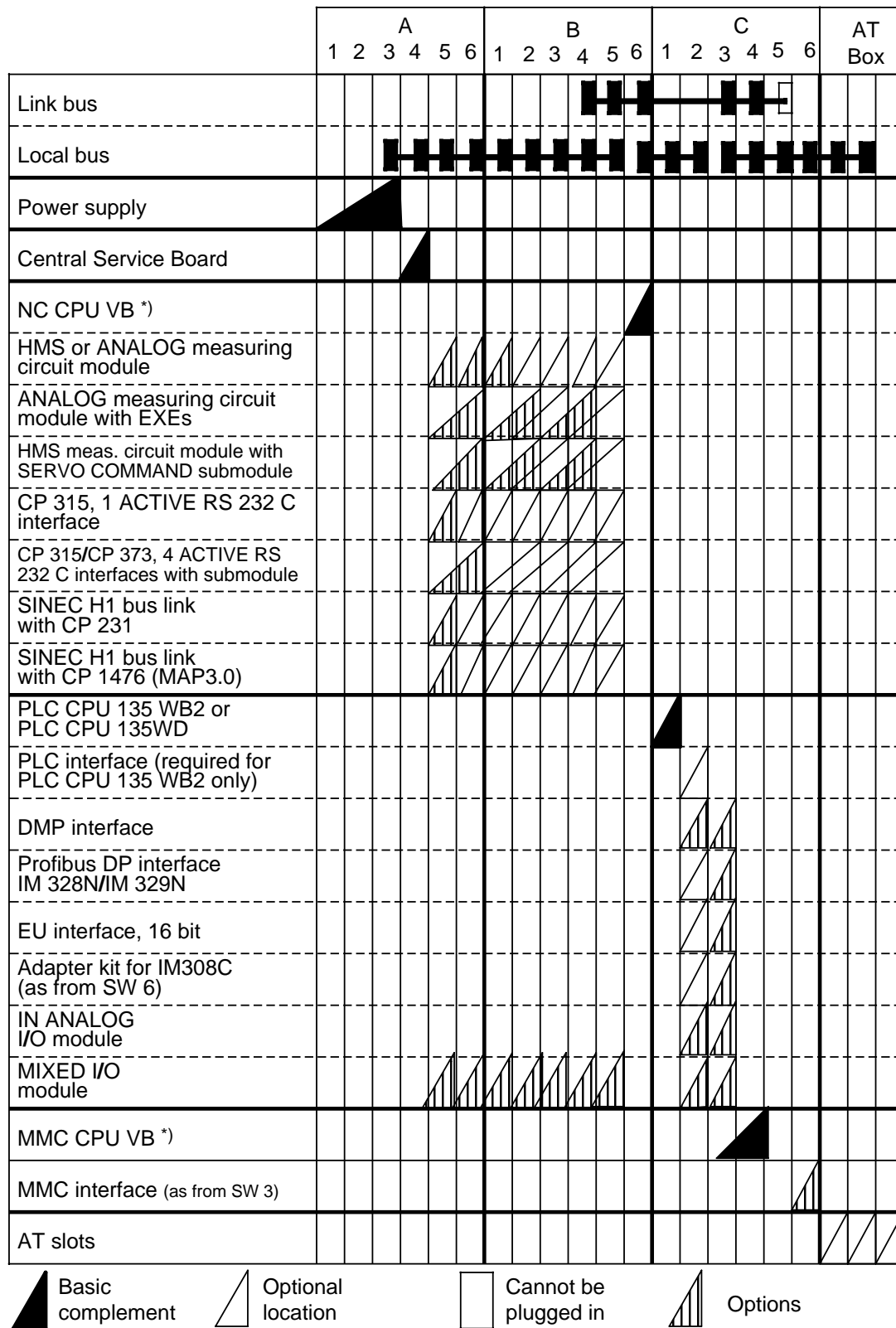

*) VB = Version B

2.3.3 CPU modules

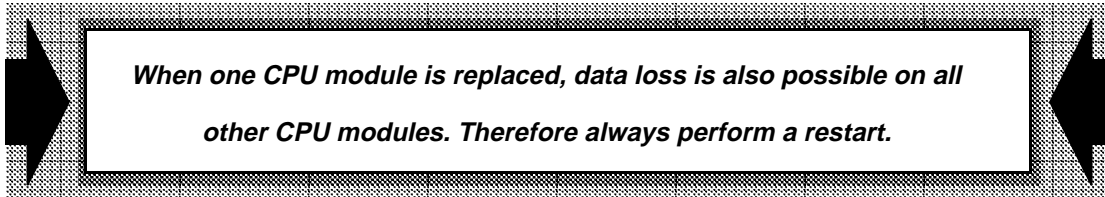

2.3.3.1 NC CPU 386DX

6FC5 110-0BA01-1AA0

Note:

The NC CPU 386 DX module is replaced entirely by the NC CPU 486 DX VB *) module, 33 MHz, 4 MB (order no. 6FC5 110-0BB01-0AA1) with new orders.

Both on the local bus and the link bus, the NCK CPU 386 DX operates as the master and may be used only once in the system.

Applies to software version 1 only:

- The CPU can be used as an EPROM machine if an EPROM submodule is slotted in.
- Two 96-pin socket connectors into which the EPROM submodule can be plugged are provided at the front panel of the module.

Function blocks:

- CPU 80386DX/20 MHz with 80387 coprocessor
- 1 Mbyte SRAM, battery-backed
- DRAM submodule, 4 Mbytes, reset-proof (the memory contents are lost only in the event of a power failure)
- Restart EPROM (available with SW version 2 and higher but can also be used with SW 1)

Location of interfaces and the operator control and display elements

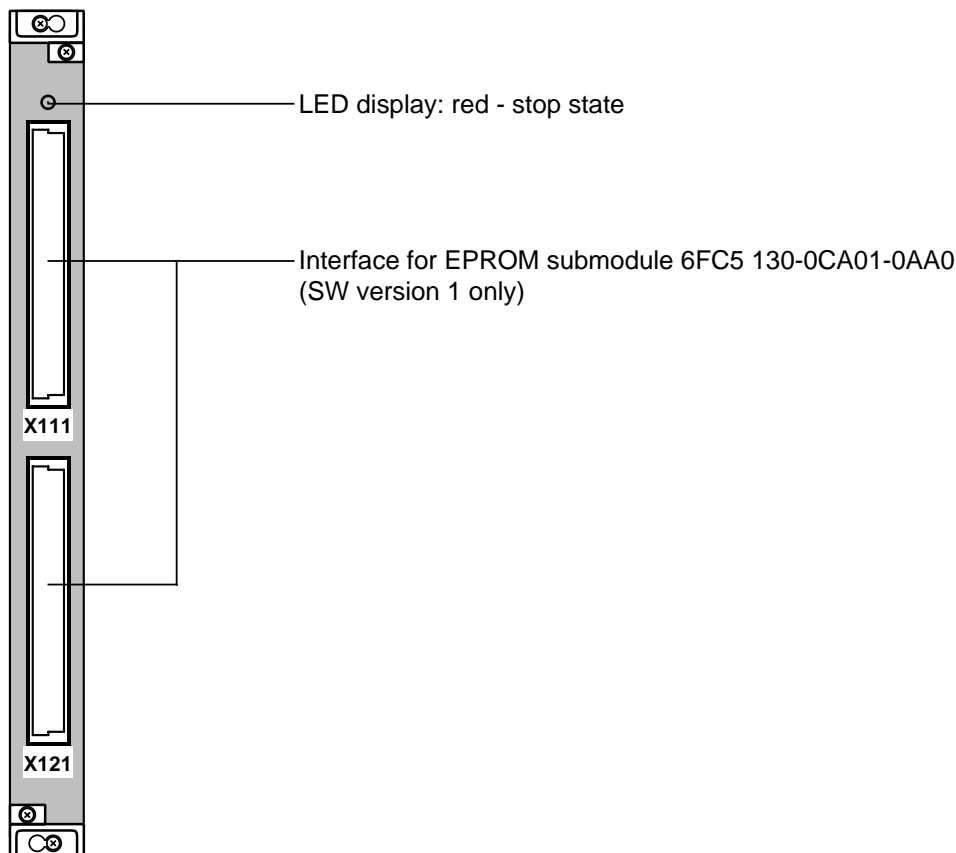

*) VB = Version B

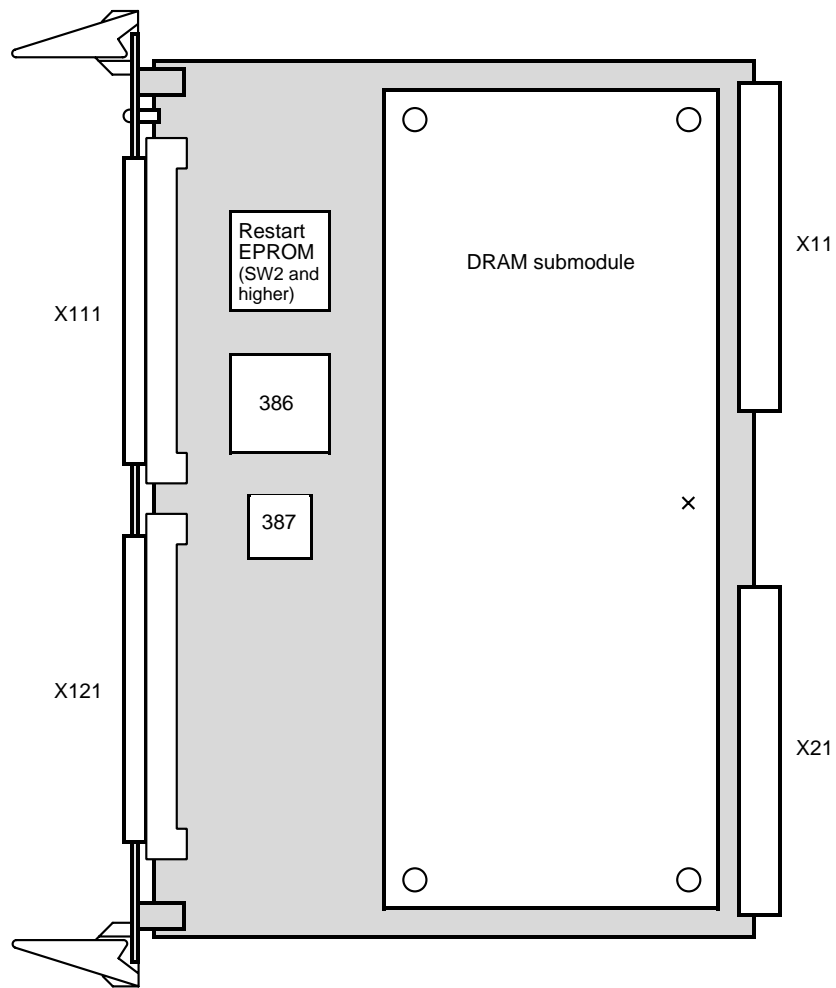

X11, X21 – Bus interface

Total current	+5 V	+15 V	-15 V	V _{CC}
Typical	3.5 A	—	—	9.0 μA

After inserting a CPU, start-up must be performed again.

2.3.3.1.1 EPROM submodule (SW version 1 only) 6FC5 130-1CA01-0AA0

The EPROM submodule is used as program memory for the NC CPU 386DX module. It has a special format. The module is plugged into the front panel of the NC CPU 386DX module and projects from the subrack.

Function blocks:

- 2 Mbyte EPROM

Location of interfaces and the operator control and display elements

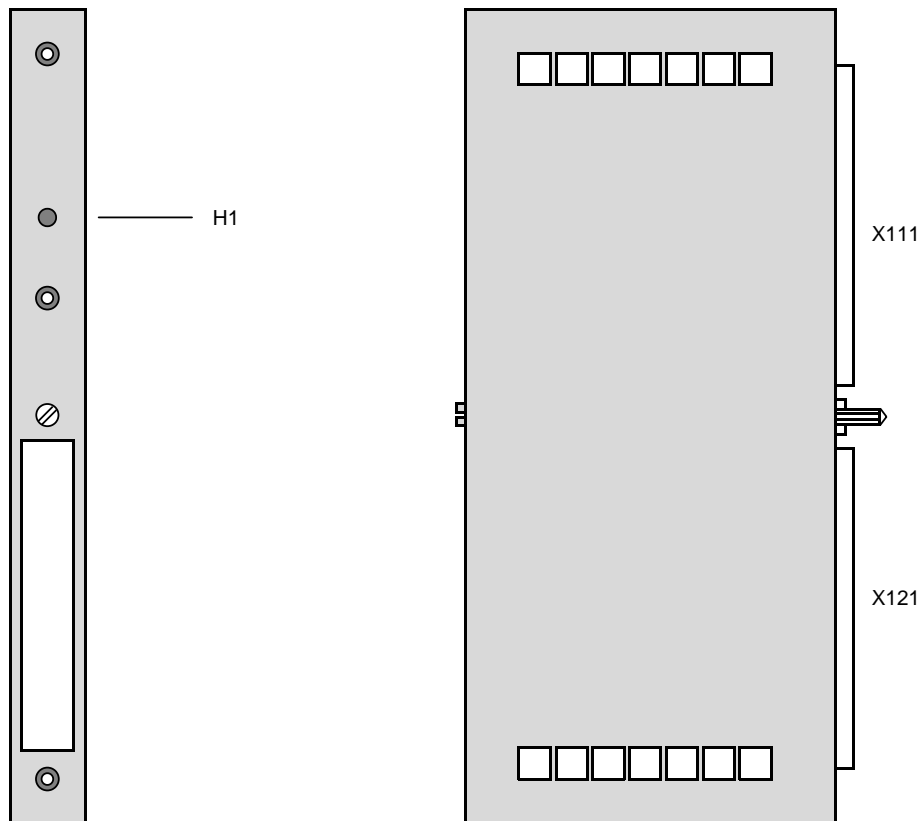

H1 – Status LED: red - stop state

X111 – EPROM interface

X121 – EPROM interface

Total current	+5 V	+15 V	-15 V	V _{CC}
Typical	0.2 A	—	—	—

Note:

With SW version 2 and higher the NCK software is on the hard disk of the MMC CPU and is booted from there. The EPROM submodule is therefore no longer required.

2.3.3.2 NC CPU 486DX

6FC5 110-0BB0 -0AA0

The NC CPU 486DX module functions in the local bus and link bus as the master and can only be placed in the system once.

Function blocks:

Order number	Processor	RAM	Interface to SIMO 611D	Comments
6FC5 110-0BB02-0AA0	486 DX 33 MHz	8 MB	See next column	<ul style="list-style-type: none"> From 12.93 with SIMO-DRIVE 611D interface From 08.94 replaced by 6FC5 110-0BB02-0AA1 (486 DX 33, 8 MB, 60 ns VB *)
6FC5 110-0BB03-0AA0	486 DX/ 2 66 MHz		Yes	From 08.94 replaced by 6FC5 110-0BB03-0AA1 (486 DX/ 2 66, 8 MB, 60 ns VB *)

- 512 Kbyte static RAM (buffered)
- Flash EPROM (Initial program loader)

Location of interfaces, operator control and display elements

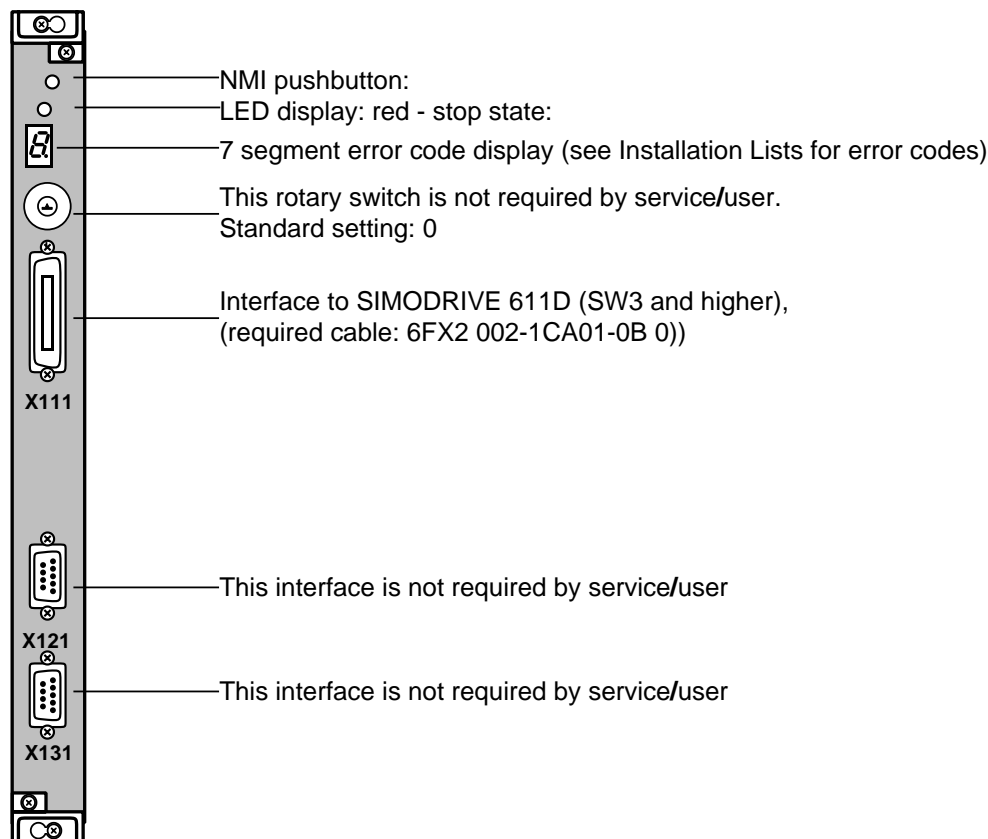

*) VB = Version B

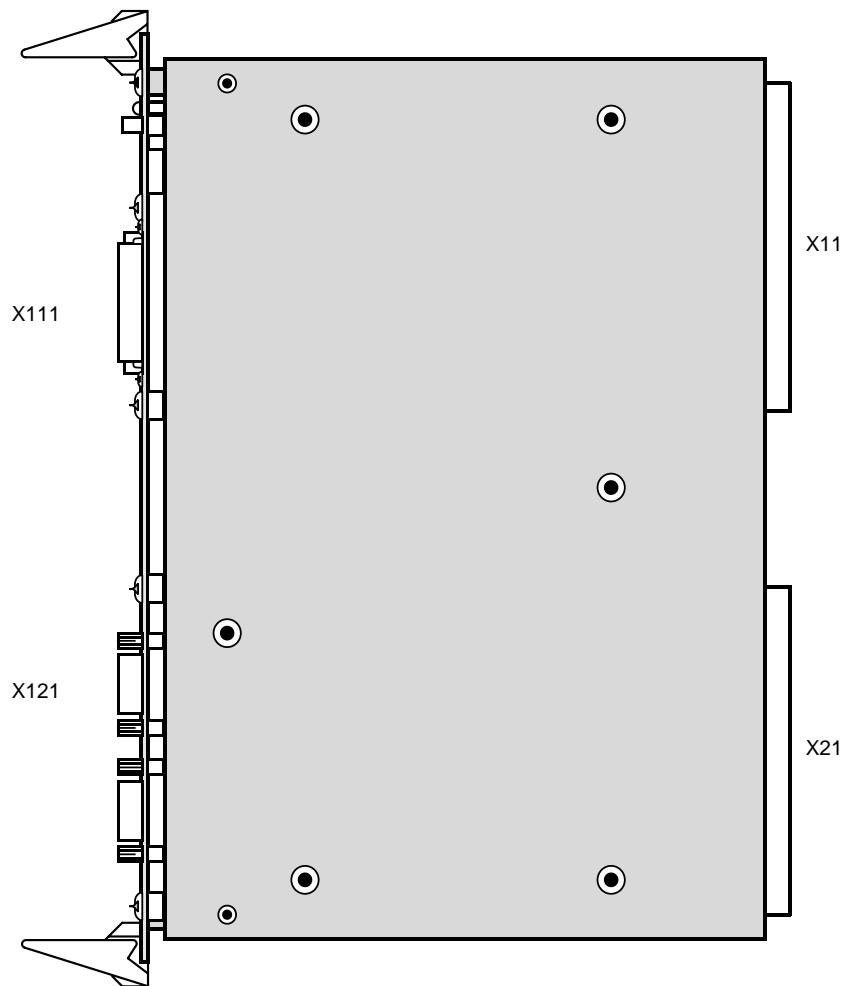

X11, X21 – Bus interface

Total current	+5 V	+15 V	-15 V	V _{CC}
typical	4 A	0.05 A	0.05 A	5 μA

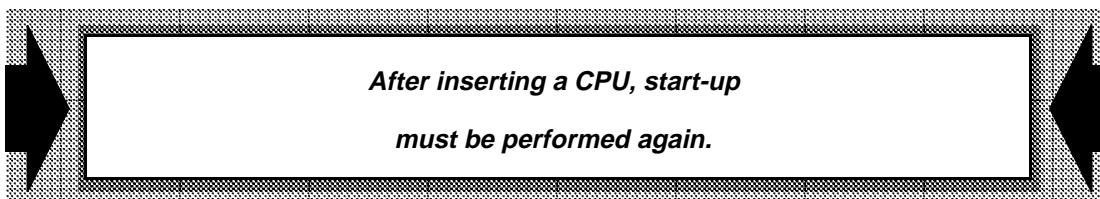

2.3.3.3 NC CPU 486 DX VB*) (from 08.94)

6FC5 110-0BB0 -0AA

The NC CPU 486DX and 486 SX modules function in the local bus and link bus as the master and can only be placed in the system once.

Function blocks

Order number	Processor	Vers.	RAM	Interface to SIMO 611D	Comments
6FC5 110-0BB02-0AA1	486 DX 33 MHz	VB	8 MB, 60 ns	Yes	From 08.94 replaces the NC CPU 486 DX, 33 MHz, 8 MB (6FC5 110-0BB02-0AA0)
6FC5 110-0BB03-0AA1	486 DX/2 66 MHz	VB		Yes	can be used from SW 3.9 to 3.x and with SW 4.5 and higher
6FC5 110-0BB01-0AA1	486 DX 33 MHz	VB	4 MB, 70 ns 4 MB, 60 ns	Yes	
6FC5 110-0BB04-0AA1	486 DX/4 100 MHz	VB	8 MB, 60 ns	Yes	can be used from SW 3.9 to 3.x and with SW 4.5 and higher
6FC5 110-0BB04-0AA2	486 DX/2 66 MHz	VB	4 MB, 60 ns	Yes	can be used from SW 3.9 to 3.x and with SW 4.5 and higher

- 512 Kbyte static RAM (buffered)
- Flash EPROM (Initial program loader)

Location of interfaces, operator control and display elements

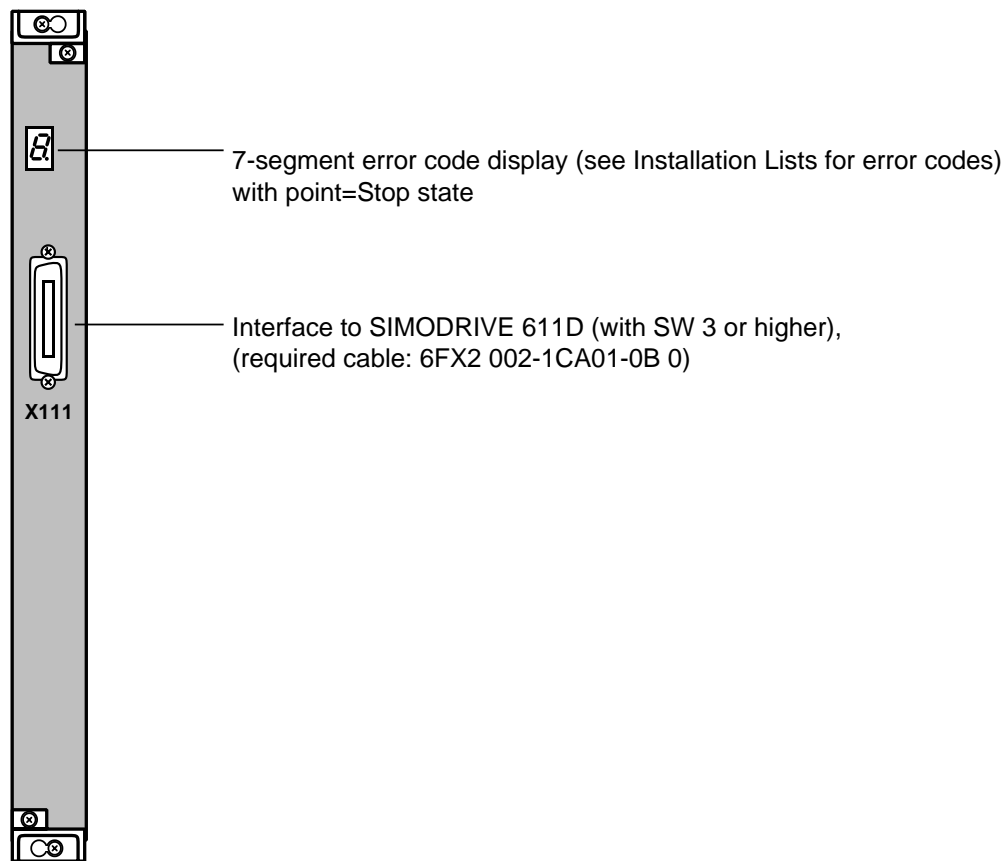

*) Version B

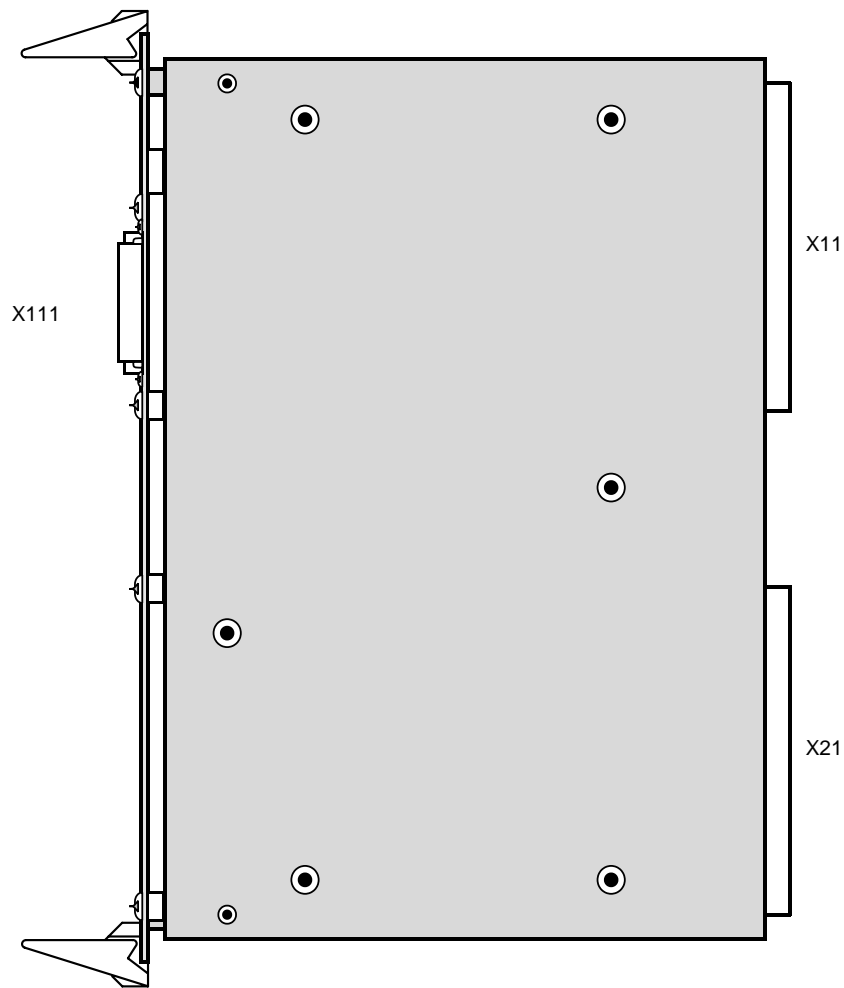

X11, X21 – Bus interface

Total current	+5 V	+15 V	-15 V	V _{CC}
Typical	3 A	0.05 A	0.05 A	5 μA

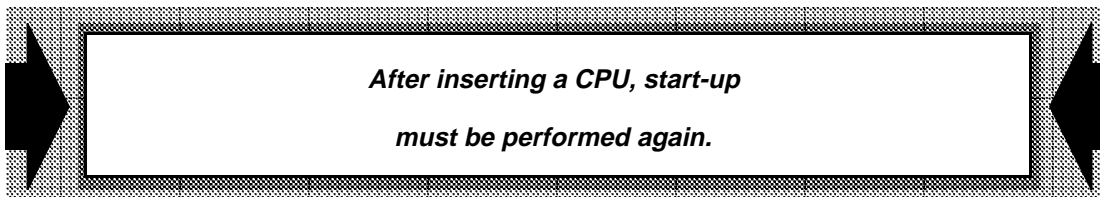

2.3.3.4 PLC CPU 135 WB2

6FC5 110-0CA01-0AA0

The PLC CPU 135 WB2 module works at a processor frequency of 16 MHz. The user data memory and user program memory are integrated on the module.

The ACOP 2 coprocessor is used for supporting STEP 5 program execution.

Applies up to SW 2:

1 user memory submodule 6FC5 130-0CA01-0AA0 can be plugged into location X321. Location X331 is permanently assigned to a 6FC5 152-0AX01-0AA0 system memory submodule.

Applies to SW 3 and higher:

The Restart-EPROM is plugged into X331 (6FC5 152-1BX01-3AE0) only. S5 configuring/diagnostics is also possible via the optional STEP5/ -SW of the MMC CPU (via X111 of the PLC interface and COM2 of the MMC CPU).

Function blocks:

- 80C186/16 processor
- Coprocessor ACOP 2

Location of interfaces and the operator control and display elements

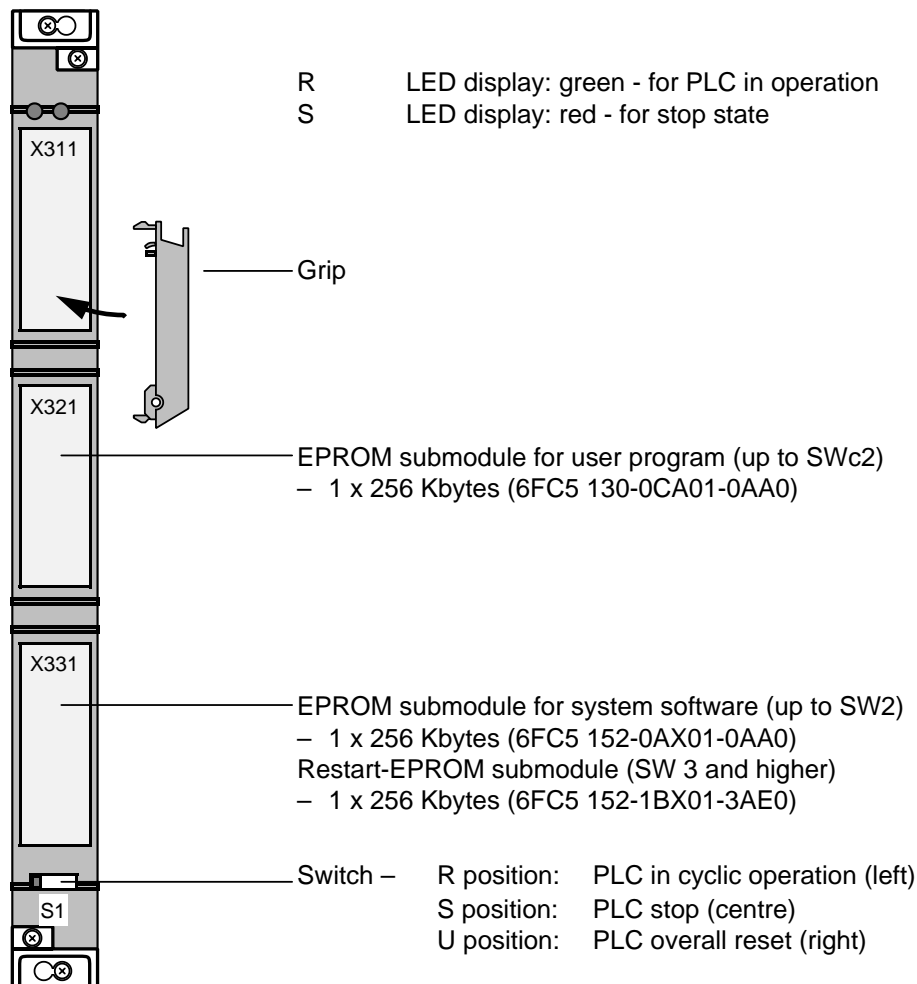

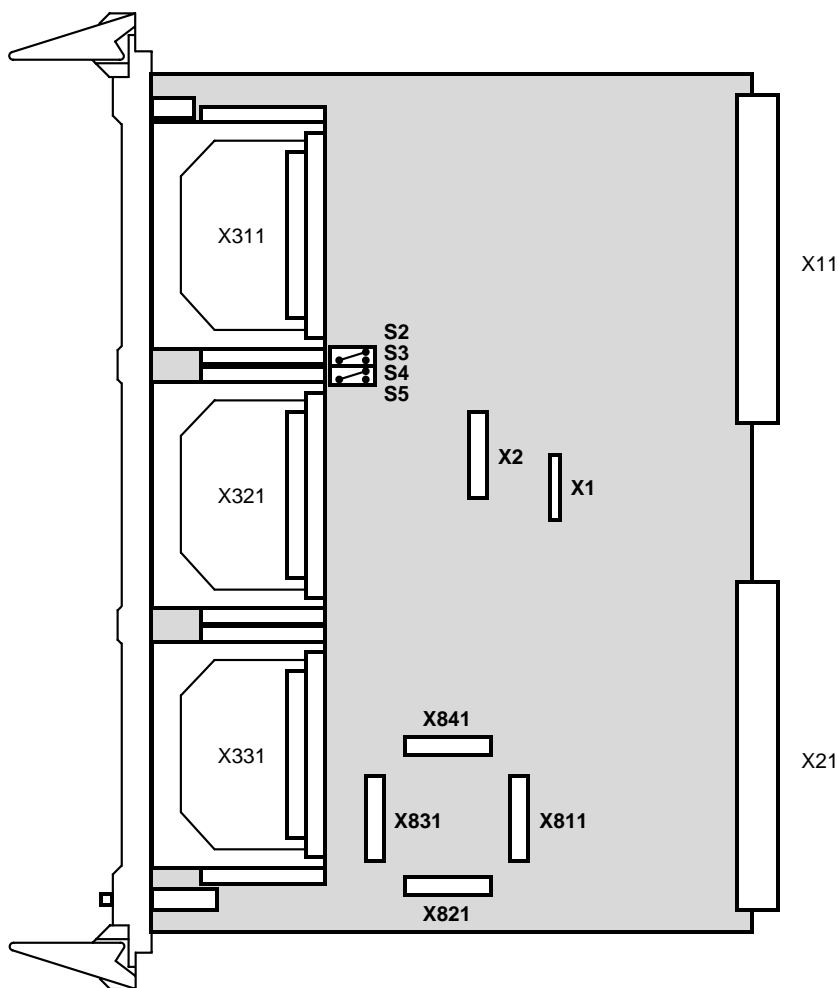

- X1, X2 - For testing purposes only
- X811, X821, X831, X841 - For testing purposes only
- S4, S2 - Closed
- S5, S3 - Open
- X11, X21 - Bus interface

Total current	+5 V	+15 V	-15 V	V _{CC}
Typical	1.6 A	—	—	12 μA

**The PLC interface is described
in section 2.3.5, Interfaces.**

2.3.3.4.1 EPROM submodule 256 Kbytes

6FC5 152-0AX01-0AA0
6FC5 130-0CA01-0AA0
6FC5 152-1BX01-3AE0

Up to SW 2:

The 256 Kbyte EPROM submodule is a memory submodule for 2 EPROMs 27C1001 with a memory capacity of 2 x 128 Kbytes. It can be programmed by means of a programmer and can then be used as a user program submodule.

The PLC system software is supplied on the 6FC5 152-0AX01-0AA0 EPROM submodule. EPROM submodule 6FC5 130-0CA01-0AA0, however, is not programmed and is suitable for storing the user program.

SW 3 and higher:

The Restart-EPROM (6FC5 152-1BX01-3AE0) is now installed in the X331 slot of PLC CPU 135 WB2 because as from this software version, the PLC system program and user program are loaded from the hard disk into the RAM for processing.

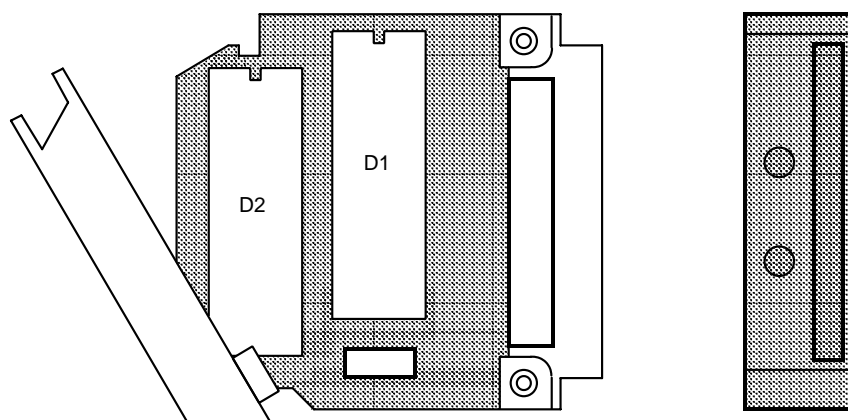

Total current	+5 V	+15 V	-15 V	V _{CC}
Typical	0.05 A	—	—	—

2.3.3.5 PLC CPU 135 WD**6FC5 110-0CB01-0AA0**

The functions of PLC CPU 135 WB2 and the PLC interface are combined on this module. The system program and the user program must be loaded from the hard disk of the MMC CPU into the buffered RAM of PLC CPU 135WD during start-up (see Installation Instructions, PLC Start-up).

With SW 4 and higher, S5 configuring/diagnostics is also possible via the optional STEP5/-SW on the MMC CPU (via X111 of the PLC CPU and X151 of the MMC CPU).

Function blocks for the PLC part:

- CPU 80C186/16 MHz with PLC coprocessor ACOP2
- Restart-EPROM
- RAM, buffered

Function blocks for I/Os:

- I/O processor 80C186/16 MHz
- MPC with 2 RS 485 interfaces for connecting DMP stations
- 8 inputs, floating, interrupt generating (group interrupt)
- Serial interface for connecting a programmer

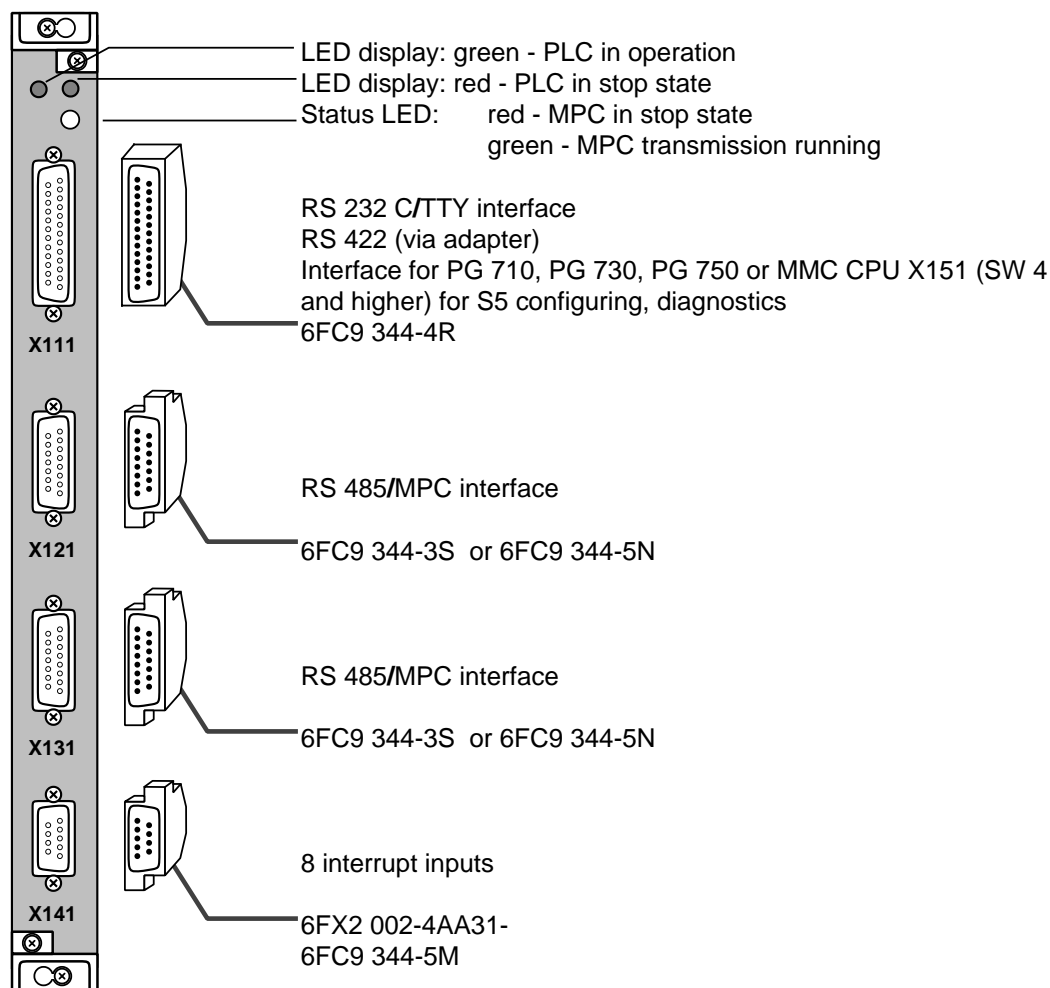
Location of interfaces, the operator control and display elements

Note:

See Section 4, Distributed Machine Peripherals, for a complete connecting overview of all possible DMP stations.

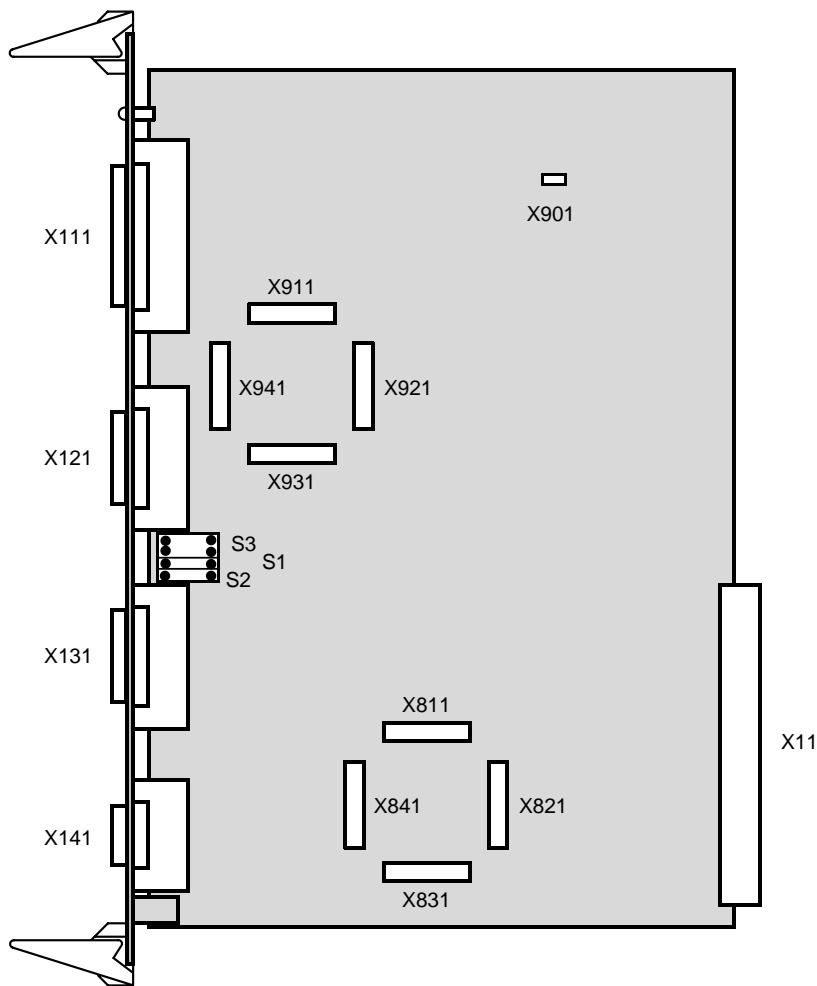

- S1, S2, – Jumpering when using a RS 422 adapter
 (see table below)
- S3 – Terminating resistor jumpering
 (see tables below)
- X811 to X941 – For testing purposes only
- X901 – Open
- X11 – Bus interface

Total current	+5 V	+15 V	-15 V	V _{CC}
Typical	1.0 A	0.05 A	0.05 A	0.003 mA

Jumpering of the terminating resistors for MPC interfaces

The terminating resistors for the MPC interfaces are connected via the S3 jumpers (serial RS 485 bus).

The jumpers may only be closed according to the following scheme and in pairs.

Bus connection	Jumpers	Application
X121 or X131 (one connector assigned)	S3 closed	A
X121 and X131 (two connectors assigned)	S3 open	B

Application A (1 MPC line)

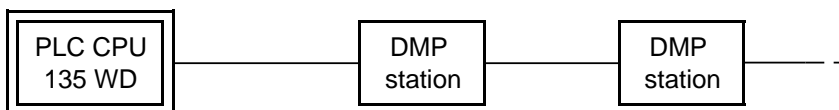

Application B (2 MPC lines)

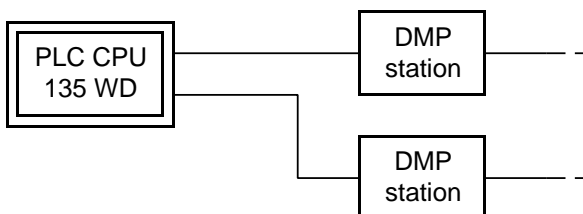

Jumpering when using a RS 422 adapter

Bus connection	Jumper
RS 232 C	S1/S2 open
RS 422 adapter, plugged in	S1/S2 closed

2.3.3.6 MMC CPU 386SX

6FC5 110-0DA0 -0AA0

The MMC CPU 386SX is an IBM-compatible PC of the 386SX class.

Function blocks:

Order number	Processor	RAM	Comments
6FC5 110-0DA04-0AA0	386 SX	16 MB	Can be used with SW1 or higher; from 08.94 replaced by MMC CPU 486 SX, 16 MB VB*) (6FC5 110-0DB04-0AA1)
6FC5 110-0DA02-0AA0	386 SX/387 SX	8 MB	from 08.94 to 12.94 replaced by 486 DX VB*); 8 MB (6FC5 110-0DA02-0AA1)
6FC5 110-0DA01-0AA0	386 SX	4 MB (for use up to SW 2)	8 MB memory configuration from 12.93
		8 MB (for SW3 or higher)	

- 64 Kbyte SRAM, buffered, as link RAM on link bus
- Hard disk drive
- VGA controller with 0.5 Mbyte video RAM
- BIOS with shadow RAM capability

Location of interfaces, the operator control and display elements

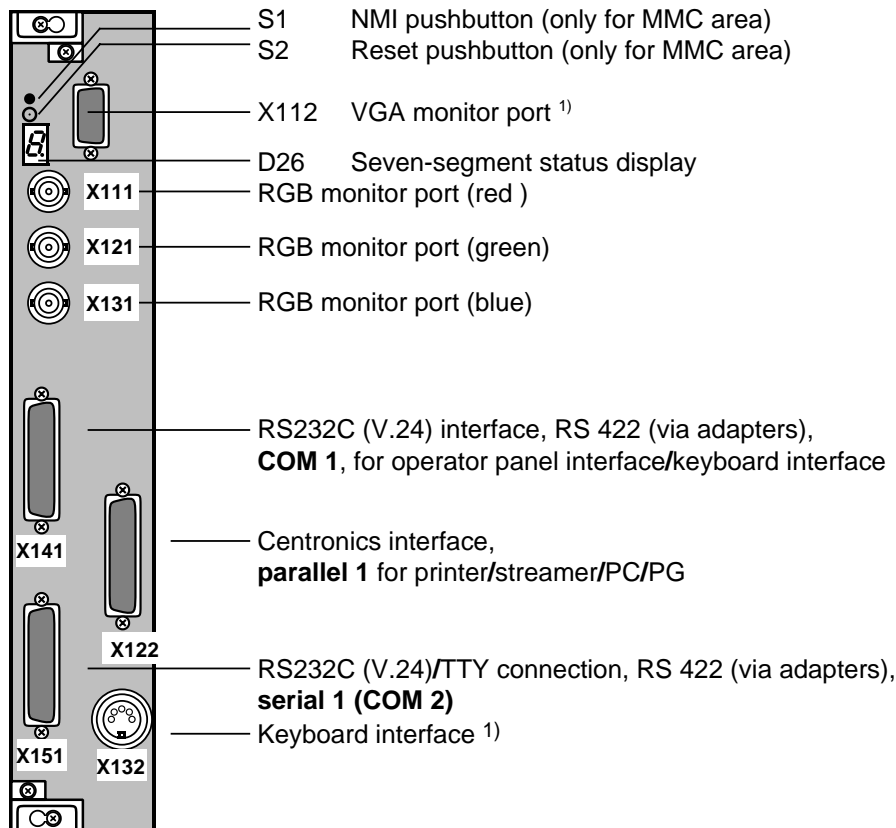

*) VB = Version B
 1) for servicing only

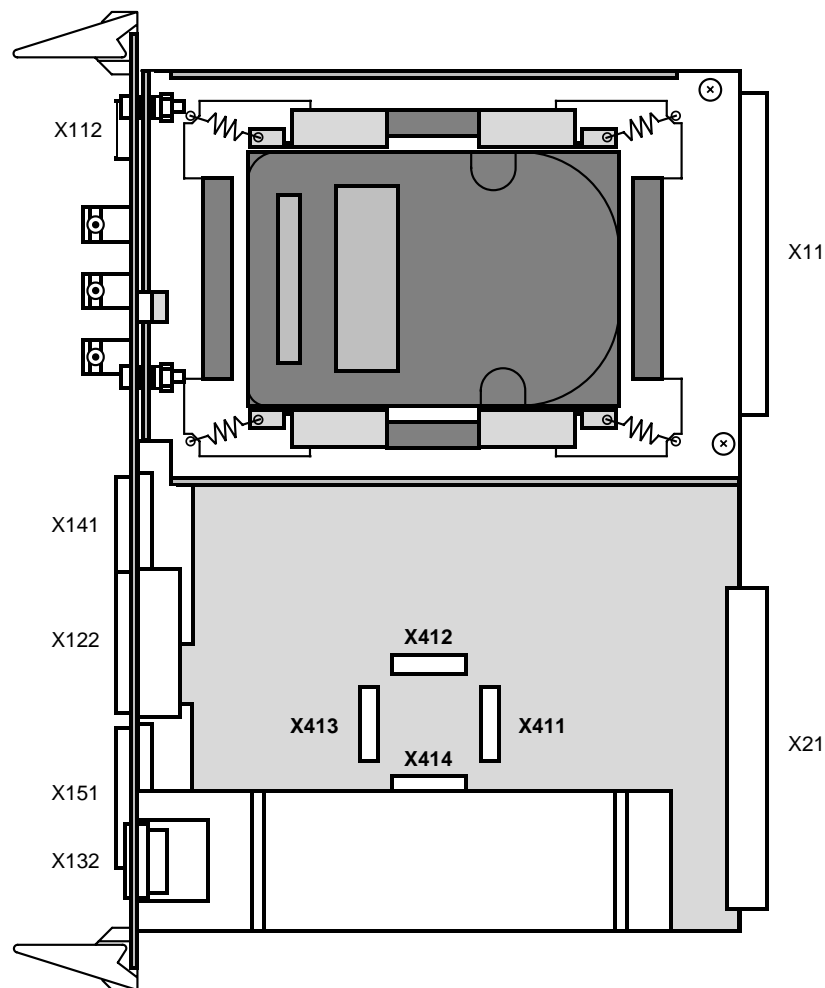

- X411, X412, X413, X414 – For testing purposes only
 X11, X21 – Bus interface

Total current	+5 V	+15 V	-15 V	V _{CC}
Typical	3 A	0.05 A	0.03 A	15 μA

Note:

The control does not immediately recognize that the MMC CPU has been withdrawn from the subrack and inserted again. The control powers up and continues to operate normally.

An error state does not occur until a PLC restart is executed. In this case, the PLC machine data destroyed due to the withdrawal of the MMC CPU are copied from the link RAM into the internal interface in the PLC. A restart is prevented by the erroneous PLC machine data (PLC STOP). The PLC machine data must be reloaded.

Typical application

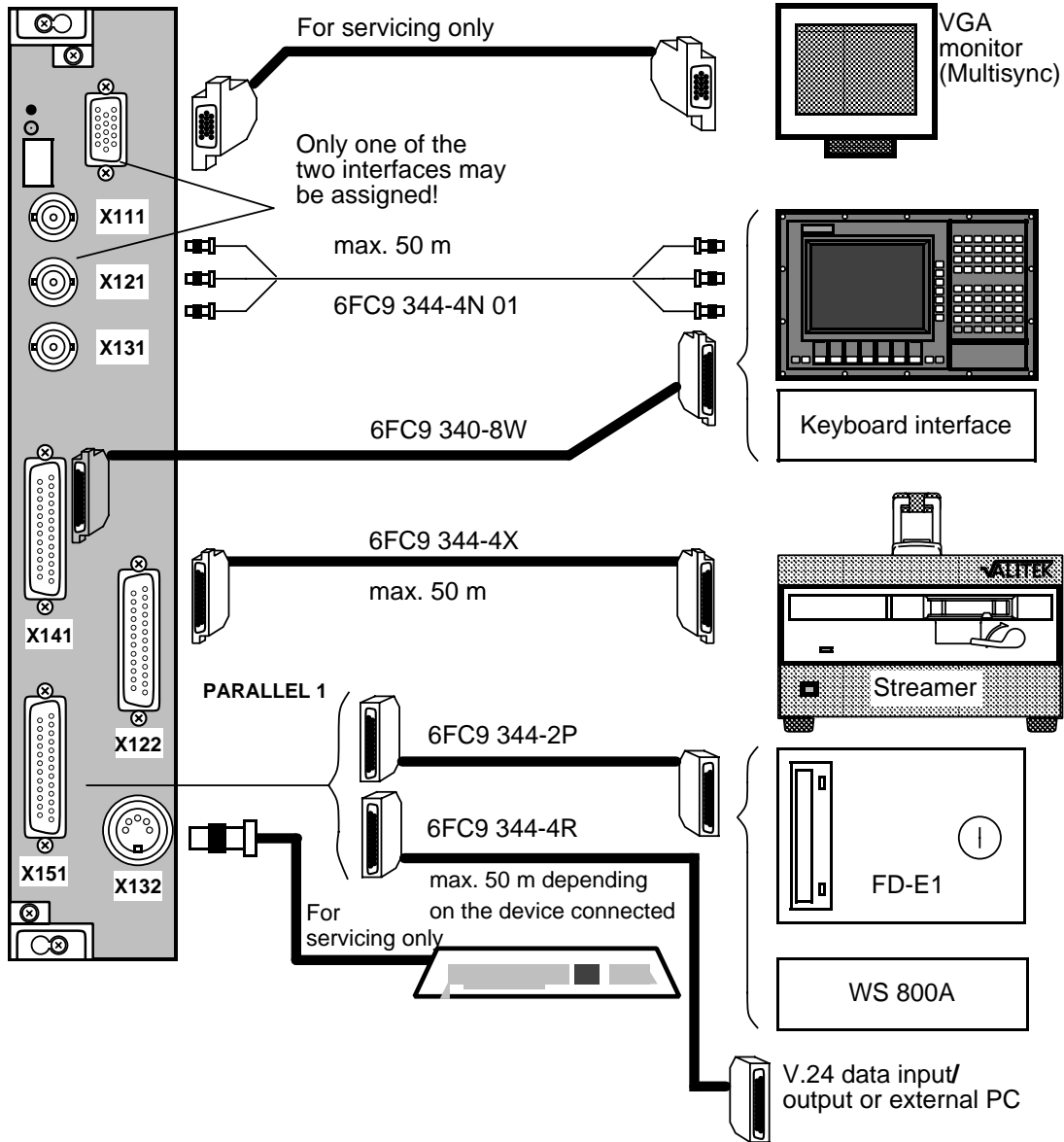

**If the
 SERIAL and PARALLEL interfaces are interchanged
 when plugging in the connecting cables,
 the MMC CPU will be destroyed!**

Note:

Only MULTISYNC monitors can be connected to the VGA interface.

2.3.3.7 MMC CPU 486 SX/DX (SW 2 and higher) 6FC5 110-0D -0AA

The MMC CPU 486 SX/DX is an IBM-compatible PC of the 486 SX/DX class.

Function blocks:

Order number	Processor	RAM	Comments
6FC5 110-0DA02-0AA1	486 DX, 33 MHz	8 MB	during 08.94-12.94 replaces MMC CPU 386/387 SX, 8 MB (6FC5 110-0DA02-0AA0)
6FC5 110-0DB01-0AA1	486 SX, 33 MHz	8 MB	from 08.94 replaces MMC CPU 386 SX, 8 MB (6FC5 110-0DA01-0AA0) and MMC CPU 386 SX, 16 MB (6FC5 110-0DA04-0AA0)
6FC5 110-0DB02-0AA0	486 DX, 33 MHz	8 MB	available since 06.93
6FC5 110-0DB02-0AA1	486 DX, 33 MHz	8 MB	from 08.94 replaces 6FC5 110-0DB02-0AA0 and from 01.95 6FC5 110-0DA02-0AA1
6FC5 110-0DB02-0AA2	486 DX2, 66 MHz	8 MB	available from 02.96; replaces 6FC5110-0DB02-0AA1
6FC5 110-0DB03-0AA0	486 DX, 33 MHz	16 MB	available since 06.93
6FC5 110-0DB03-0AA1	486 DX, 33 MHz	16 MB	from 08.94 replaces 6FC5 110-0DB03-0AA0
6FC5 110-0DB03-0AA2	486 DX2, 66 MHz	16 MB	available as from 02.96; replaces 6FC5 110-0DB03-0AA1
6FC5 110-0DB03-0AA3	486 DX4, 100 MHz	32 MB	avail. as from 08.98; replaces 6FC5110-0DB03-0AA2
6FC5 110-0DB04-0AA1	486 SX, 33 MHz	16 MB	from 08.94 replaces MMC CPU 386 SX, 8 MB (6FC5 110-0DA01-0AA0) and the MMC CPU 386 SX, 16 MB (6FC5 110-0DA04-0AA0)

- 64 Kbyte SRAM, buffered, as link memory on the link bus
- Hard disk drive
- VGA controller with 0.5 video RAM
- BIOS with shadow RAM capability

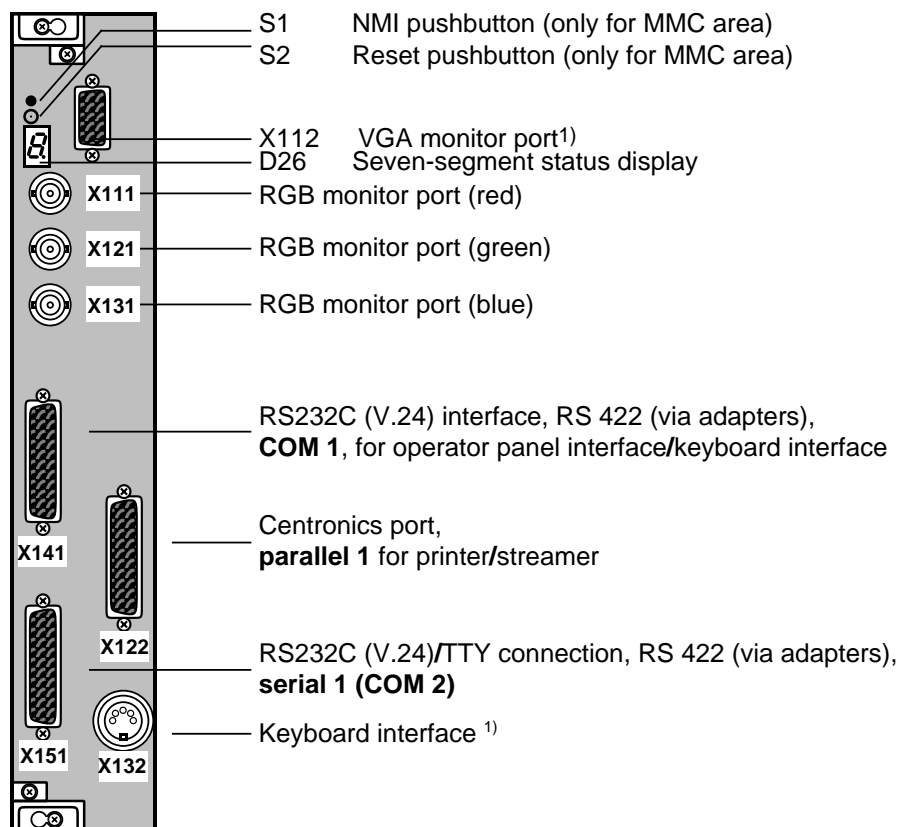
Position of interfaces, operator control and display elements

1) for servicing only

*) VB = Version B

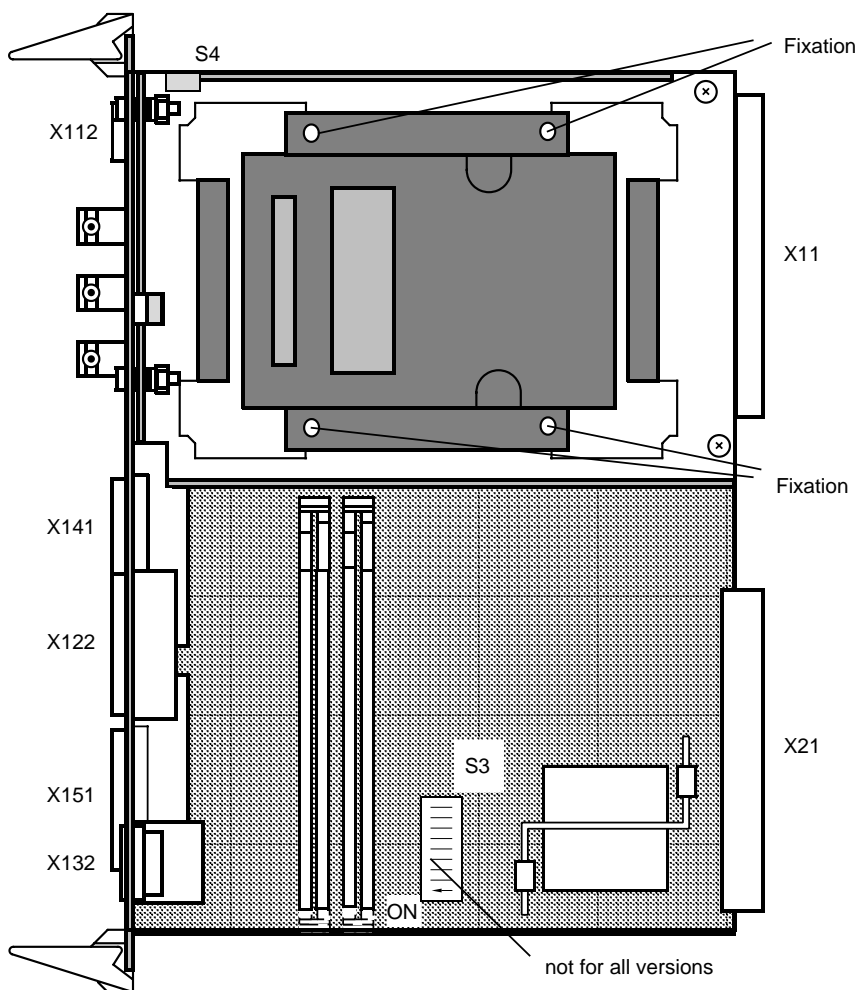

Note:

Switch S3 is not available for all versions.

X11, X21 – Bus interface

Total current	+5 V	+15 V	-15 V	V _{CC}
Typical	3/4 A *)	0.06 A	0.03 A	20 µA

Note:

Please see the notes for installing hard disks in chapter 3.5.5

For MMC CPUs with fixed hard disk, the installation of clamping elements on the central controller will be required.

Please observe both the installation instructions and the accompanying sheet supplied with the damping elements.

Damping elements

- The damping elements are available for the central controllers to absorb vibration in the range 10-1000 Hz to protect the hard disk from damage.
- You can order a set of 4 damping elements and installation instructions with order No. 6FC5148-0AA20-0AA0. You only require one set of 4 damping elements for central controllers 1, 2 and 3.

*) 3A applies to the new MMC CPU from 08.94

Mounting rails

- You can order a set of mounting rails for central controller 2 with order No. 6FC5 148-0AA17-0AA0.
- You can order a set of mounting rails for central controller 3 with order No. 6FC5 148-0AA17-0AA0.

Operator elements:**Versions with DIP switch S3:****Setting S3, DIP switch**

1	2	3	4	5	6	7	8	Description
ON	OFF	ON	ON	ON	ON	OFF	OFF	DX/DX2 processor (standard setting!)
OFF	ON	OFF	OFF	ON	ON	OFF	OFF	SX processor (standard setting!)

S4

If the RGB interface is used S4 is closed (standard setting!).

If the VGA interface is used S4 must be opened (OEM application).

Versions without DIP switch S3:

In MMC CPUs without DIP switch S3, the ONBOARD VGA interface can be switched off with switch S4 (3.5).

S4.1	
OPEN	VGA MODE WITHOUT C-SYNC
CLOSED (STANDARD)	RGB MODE WITH C-SYNC
S4.2=S3.5	
OPEN	ONBOARD VGA DISABLED
CLOSED (STANDARD)	ONBOARD VGA ENABLED

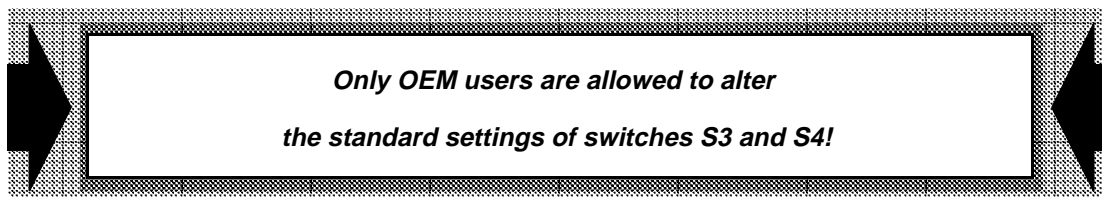
**Note:**

The control does not immediately recognize that the MMC CPU has been withdrawn from the subrack and inserted again. The control powers up and continues to operate normally.

An error state does not occur until a PLC restart is executed. In this case, the PLC machine data destroyed due to the withdrawal of the MMC CPU are copied from the link RAM into the internal interface in the PLC. A restart is prevented by the erroneous PLC machine data (PLC STOP). The PLC machine data must be reloaded.

Applications:

As for previous Section MMC CPU 386SX.

2.3.4 I/O modules

2.3.4.1 ANALOG measuring circuit module without/with EXEs

6FC5 111-0BA0 -0AA0

The ANALOG measuring circuit module without/with EXEs is used for analog setpoint output (setpoint speed) and actual value acquisition (incremental actual position values) for 3 axes. Sinusoidal signals can also be processed as actual values of linear scales. They are amplified and multiplied by pulse shaper electronics (EXE).

Function blocks:

- Servo enable
- Wire break monitoring
- Contamination monitoring
- EXEs 5/10-fold
- Address routing by software
- 3 measuring circuit/actual value inputs for 3 axes with incremental position encoders
- 1 measuring circuit setpoint output for 3 axes with analog setpoint speeds

Location of interfaces, the operator control and display elements (with EXEs)

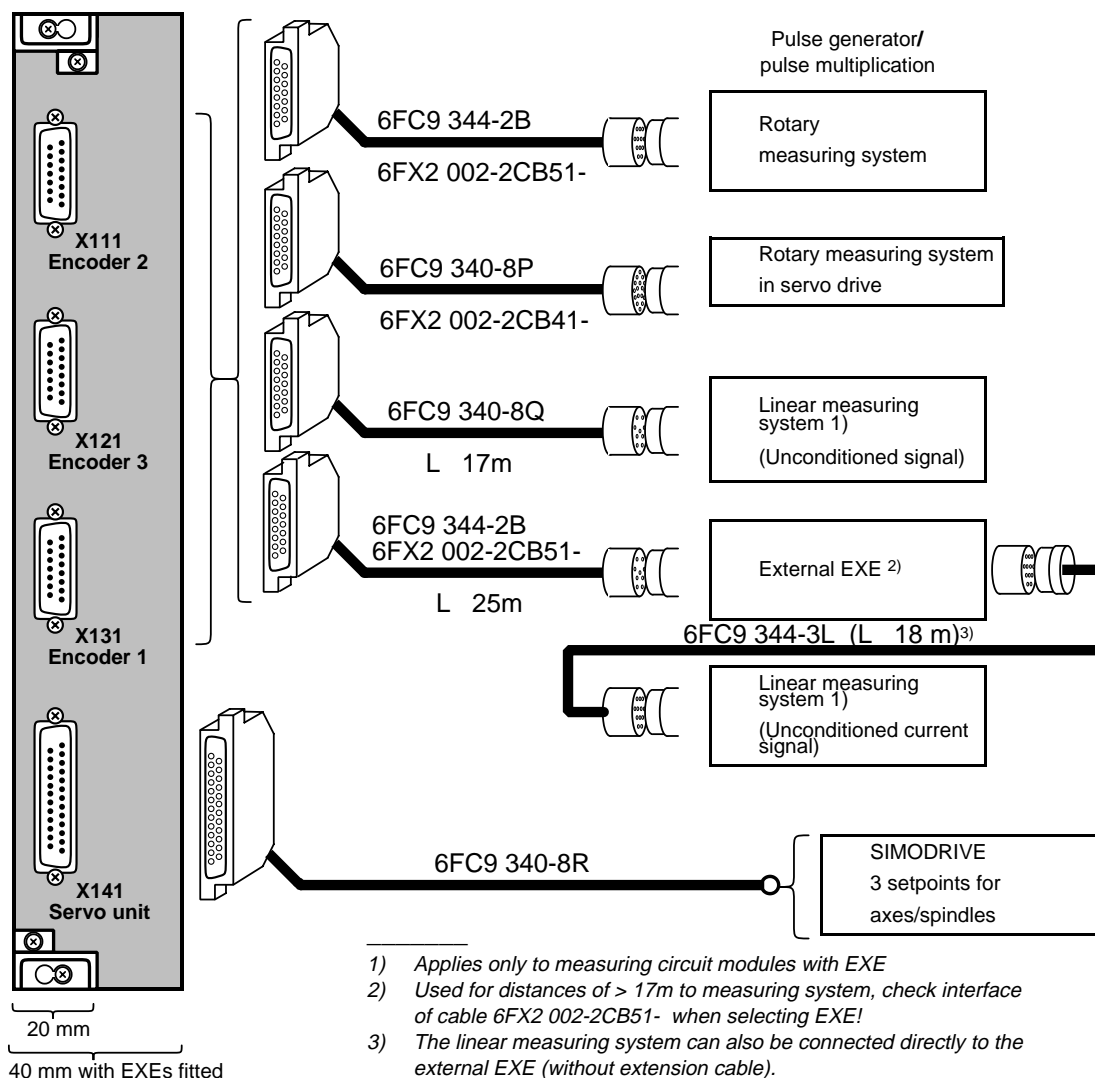

Location of interfaces, operator control and display elements (with EXEs) (continued)

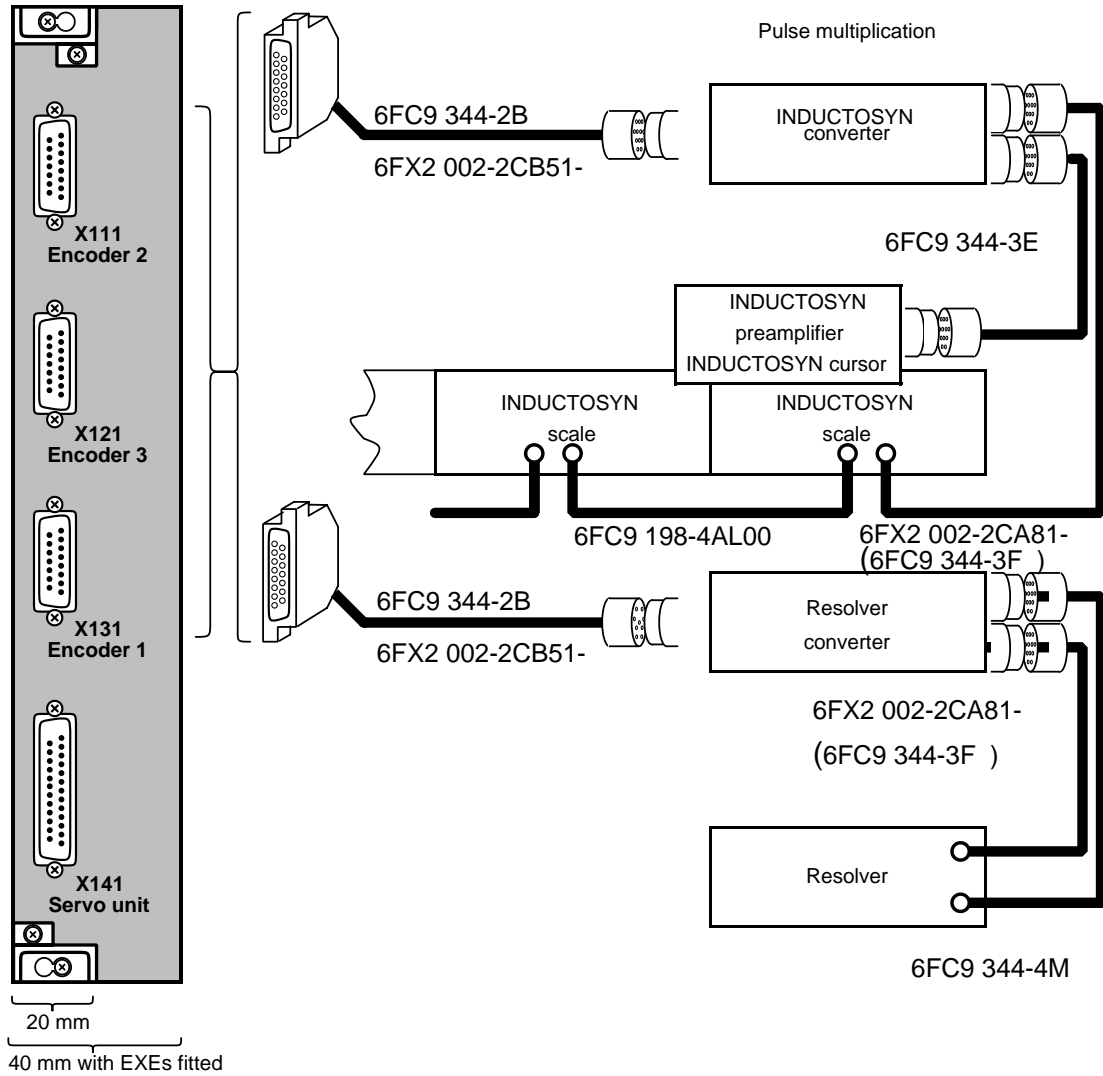

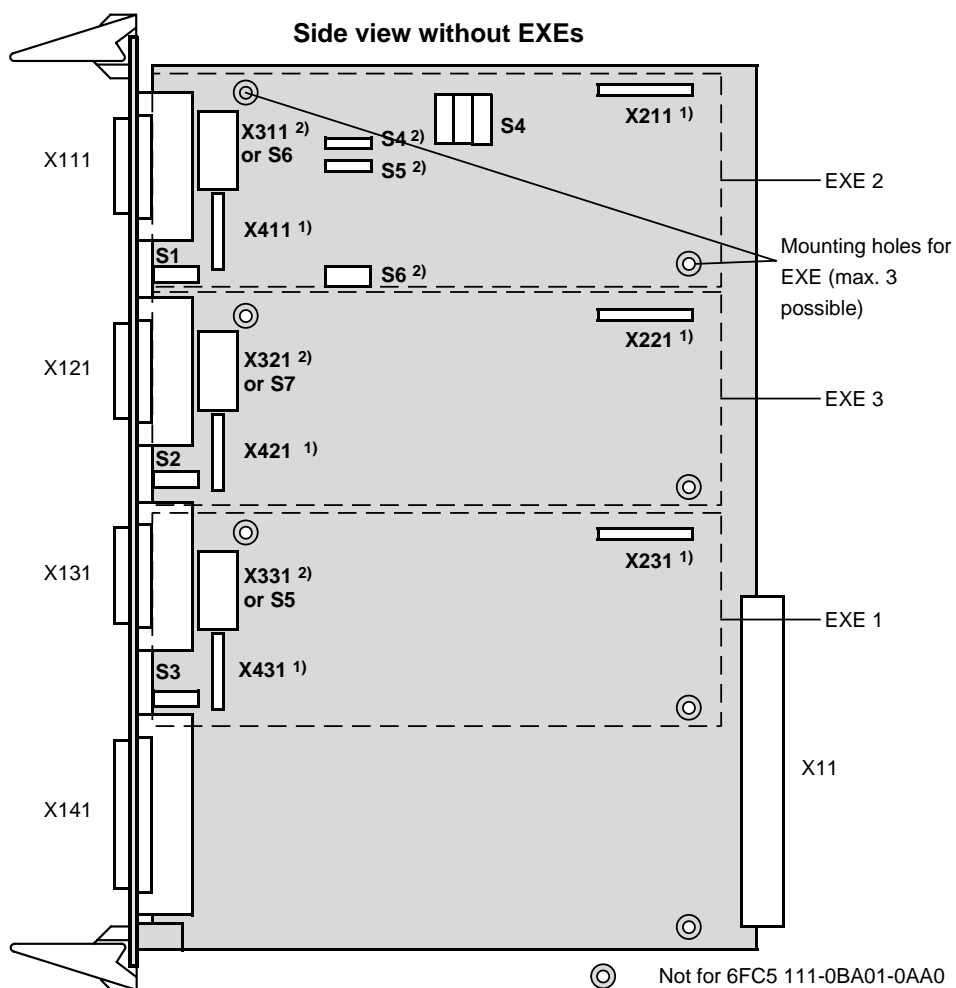

- | | | |
|---|---|---|
| X111 | – | Actual value axis 2 |
| X121 | – | Actual value axis 3 |
| X131 | – | Actual value axis 1 |
| X141 | – | Setpoint/servo enable axes 1 to 3 |
| X311 ²⁾ , X321 ²⁾ , X331 ²⁾
or S6, S7, S5 | – | Customer jumpering |
| | – | For encoder and EXE connection, if an integrated EXE is used, the jumper plug must be removed and all DIP block switches must be in the OFF position; without integrated EXE all the jumpers and switches must be closed. |
| X211, X221, X231 | – | Integrated EXE output, only when EXE plugged in |
| X411, X421, X431 | – | Integrated EXE input, only when EXE plugged in |
| S1 to S3 | – | At position 1 |
| S4 ²⁾ to S6 ²⁾ or
S4 (3 DIP FIX) | – | Any |
| X11 | – | Bus interface |

Note: Depending on the hardware version, some of the jumpers may not be fitted.

1) Not for 6FC5 111-0BA01-0AA0

2) Designation applies until 6FC5111-0BA02-0AA0

Total current	+5 V	+15 V	-15 V	V _{CC}
Typical	0.65 A	49 mA	49 mA	—
Current carrying capacity of connectors (X111 to X131)	1.5 A	—	—	—
Per encoder supply (X111 to X113)	0.5 A	—	—	—

For calculating the total current, the encoders and the external EXEs must be taken into account.

Technical data for X141

Setpoint outputs

- Voltage range ± 10 V
- Resolution 1.2 mV
- Max. current 2 mA

Servo enables

- Supply voltage 5 V to 30 V
- Current load 3 mA to 250 mA

Output for servo enable

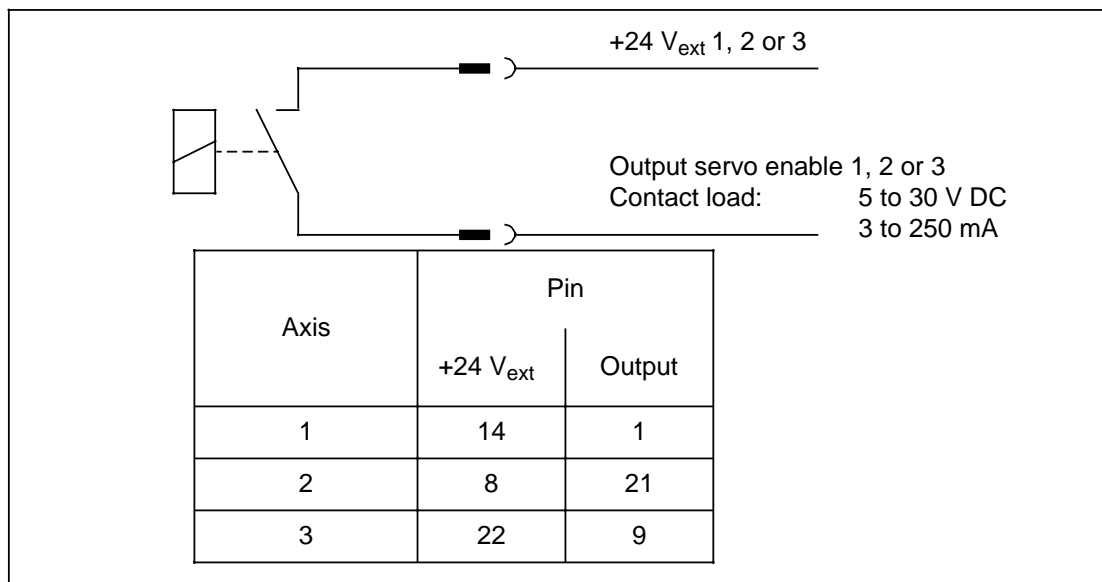

HMS measuring circuit module in combination with ANALOG measuring circuit module is permissible.

X111, X121, X131 technical data

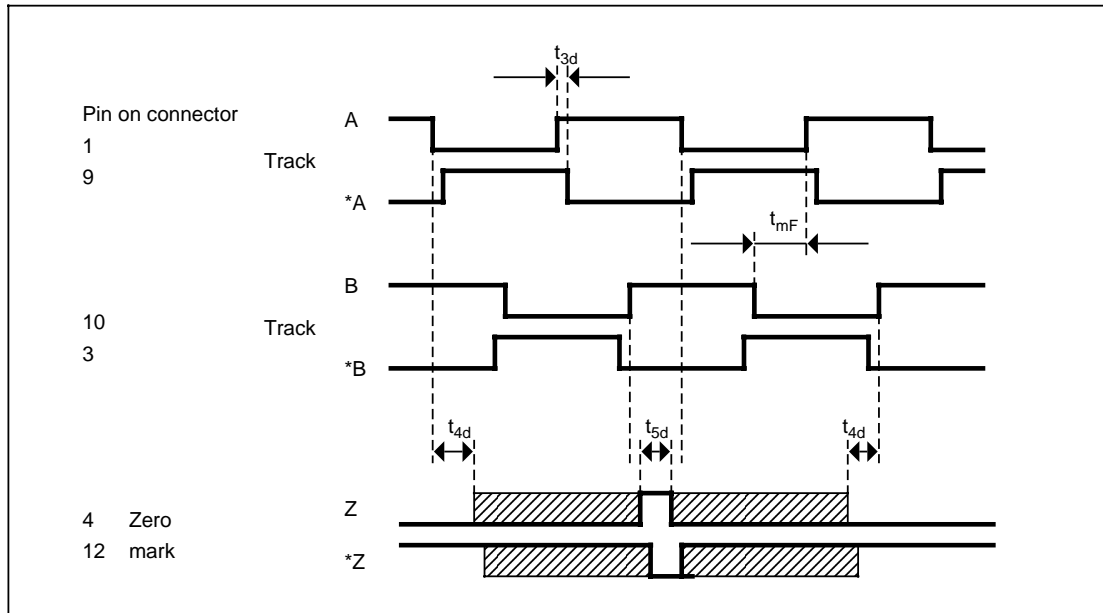

Technical data:

- Position encoder supply voltage: 5 V±5 %
- Ripple of supply voltage: 100 mV_{PP}
- Current per position encoder system: 500 mA
- Ohmic input resistance: 470 ohm
- Dynamic input resistance: 110 ohm
- Differential input voltage: 1 V
- (e.g. between A and *A)
- Differential input voltage max.: 10 V
- Permissible common mode range: -2 ... +5 V
- Max. input frequency at 90° electrical phase displacement between A and B track pulses: 1 MHz (without EXE)
50 kHz (with EXE)
- Noise immunity (DIN 57847) – spurious signal width: 3 kV
- Max. cable length to encoder when using SINUMERIK cables: 35 m
- Minimum distance between two successive edges t_{mF} : 200 ns
- Max. time delay of two successive edges of one track t_{3d} : 50 ns
- Condition for zero mark: Z=high, when A and B = high
- Min. length of zero mark t_{5d} when A and B = high: 200 ns
- Distance between zero mark and edge of A and B t_{4d} : 50 ns
- Edge steepness (all signals): 1 V/μs

Technical data for X111, X121, X131 with integrated EXEs

Connector No. Signal type Encoder supply – Short-circuit proof: No	Sinusoidal current			
	min.	typical	max.	unit
Encoder supply – Voltage – Wave – Current per encoder	+4.75	+5.0	+5.25 100 500	V mV _{pp} mA
Input current – Track A and B – Reference mark – Zero frequency quantity – Amplitude difference	0.007 0.002		16 8.5 6.5 20	μA μA % %
Inputs – Frequency when 90° el A-B – Phase displacement A to B – Phase displacement reference mark to A Crossing of zero positive to negative Crossing of zero negative to positive		80 90	50 100 45 405	kHz °el °el °el
Noise immunity (DIN 57847)			3	kV
Cable length to encoder when using SINUMERIK cables			20	m

Shorting plug for actual value input

The shorting plugs used for SINUMERIK Systems 3 and 8 digital measuring systems must **not** be used for System 800 because they have a different pin assignment.

The shorting plug is used to test the system and measuring circuit when the measuring systems are not connected and axes are not available. The plug is not part of the scope of supply and cannot be ordered.

Connector designation: **Shorting plug**
Connector type: Subminiature D female connector, 15-pin

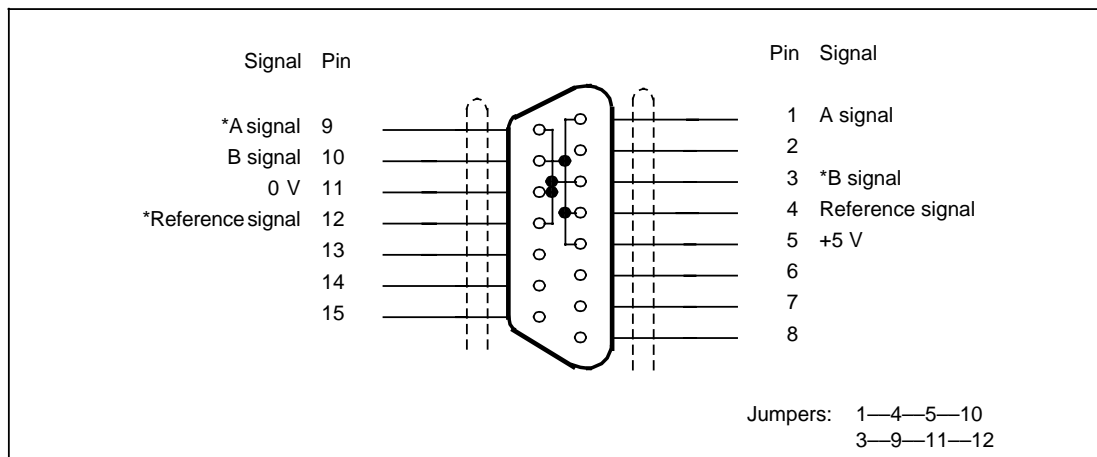

2.3.4.1.1 EXE 5/10-fold

6FC5 111-0BA06-0AA0

The 5/10-fold EXE module converts analog input signals into digital output signals with concurrent pulse multiplication (5/10-fold).

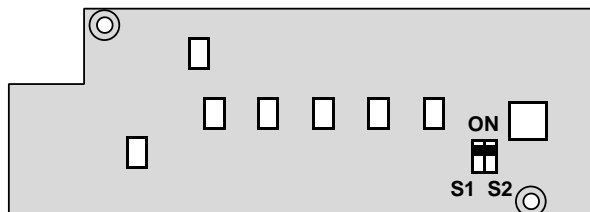

- S1 – Input frequency switch
- S2 – Subdivision factor

Function selection

- Max. input frequency $f_{max}=50$ kHz: S1 – ON position
- Max. input frequency $f_{max}=25$ kHz: S1 – OFF position
- 10-fold multiplication factor: S2 – OFF position
- 5-fold multiplication factor: S2 – ON position

The 25 kHz and 50 kHz frequencies are closely defined limits and must not be violated under any circumstances.

Pulses could be lost positioning errors.

The EXE is supplied with the setting 50 kHz/5-fold (S1, S2 ON position).

Total current	+5 V	+15 V	-15 V	V _{CC}
Typical	60 mA	-	-	-

2.3.4.2 HMS measuring circuit module**6FC5 111-0BA -0AA0**

The HMS measuring circuit module is used for high resolution actual value acquisition of three axes. Incremental SIPOS voltage signal generators, SIPOS absolute encoders together with the SIPOS absolute encoder module and linear scales with incremental current signals can be connected. In connection with the SERVO COMMAND submodule, the output of analog setpoints is also possible. For each submodule, setpoints can be output for three axes.

Function blocks:

- Wire break monitoring
- Contamination monitoring
- 3 measuring circuit/actual value inputs for 3 axes with incremental position encoders
- 3 analog measuring-circuit setpoint submodule locations (not for 6FC5 111-0BA40-0AA0)
- Address routing by software

The two upper setpoint submodule locations are also used for the SIPOS absolute encoder submodule. In this case, another SERVO COMMAND submodule can be plugged into the lower free location.

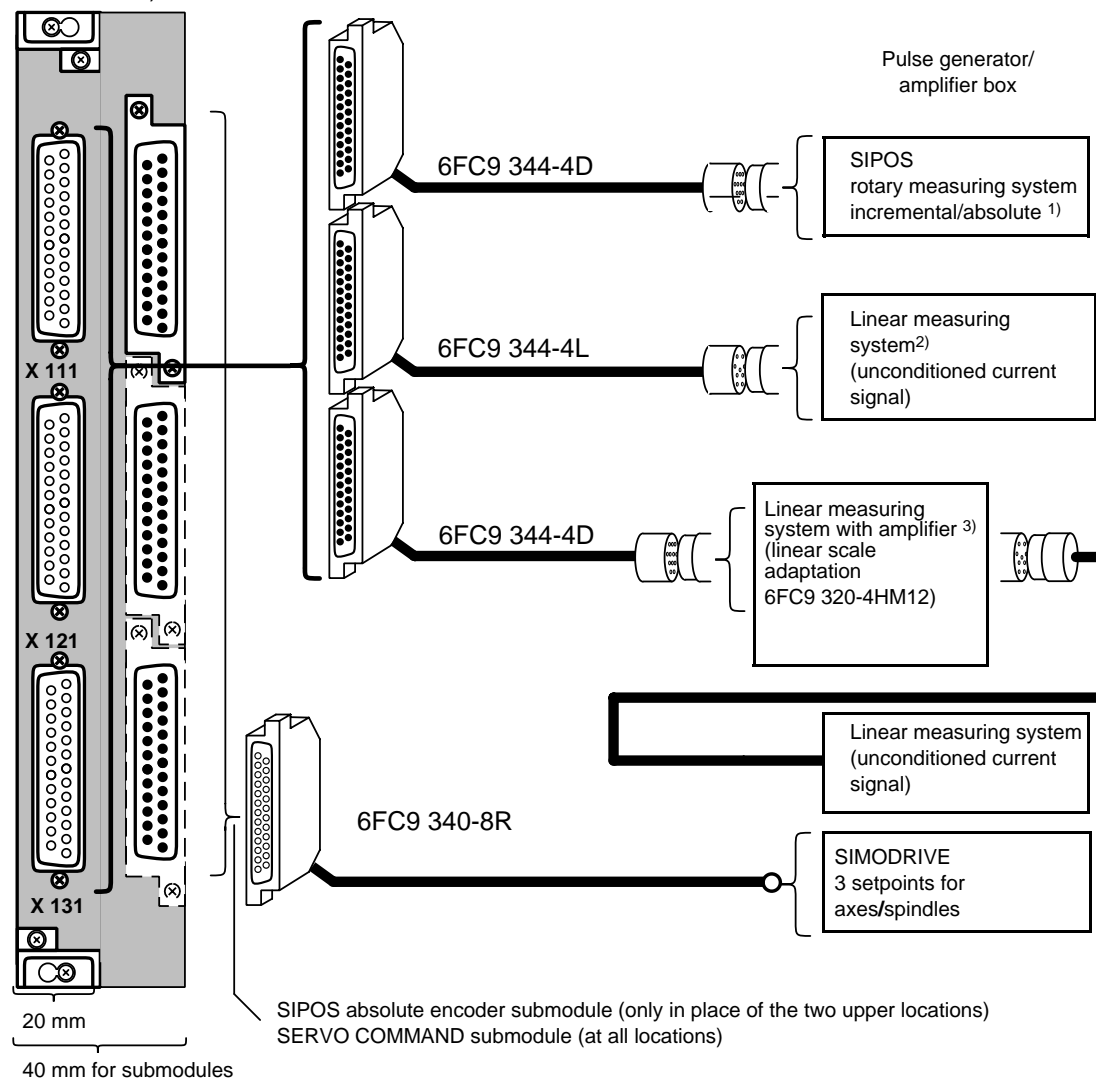
Location of interfaces, jumpering sockets and jumpers (here with 3 SERVO COMMAND submodules)

1) Only in connection with the absolute encoder submodule

2) only in connection with I/V hybrid

3) Used for distances of > 18 m to measuring system

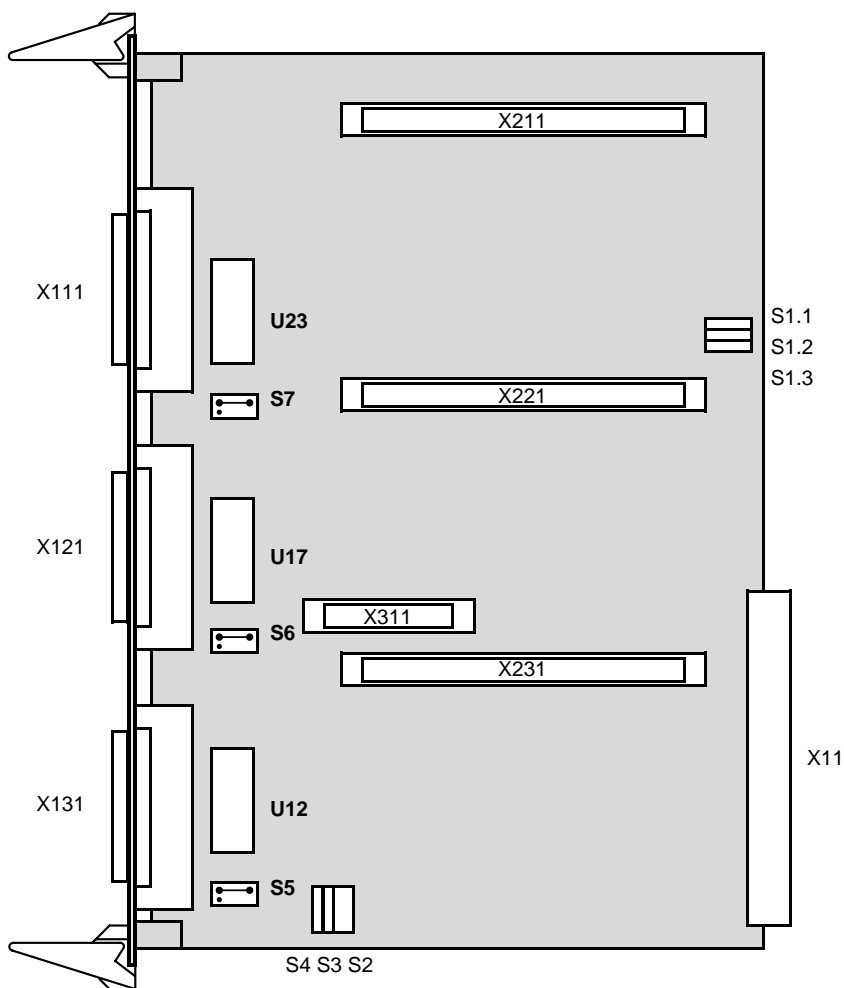

- | | | |
|------------------|---|--|
| X111 | - | Actual value axis 1 |
| X121 | - | Actual value axis 2 |
| X131 | - | Actual value axis 3 |
| X211/X221/X231 | - | Submodule interfaces for SERVO COMMAND submodule |
| X211, X311 | - | Interface to the SIPOS absolute encoder submodule |
| U23, U17, U12 | - | Shorting plug for unconditioned voltage signal (U23 for X23, U17 for X17, U12 for X12) |
| | - | I/V hybrid for unconditioned current signal |
| S1.1, S1.2, S1.3 | - | Position: open |
| S2, S3, S4 | - | Customer jumpering, matching to probe (level, edge)
(see following table) |
| S5, S6, S7 | - | Position 1 |
| X11 | - | Bus interface |

Connection of actual values

Connector designation X111, X121, X131

Connector type: Sub miniature D socket connector, 25-pin

The actual value interface can either be used for encoders with current signals or with additional I/V hybrids for encoders with unconditioned current signals. Please consult your Siemens local branch office regarding the components required when using unconditioned current signals. The amplitude of the sinusoidal signals of tracks A and B are specified as follows.

- Voltage signals (measured between A and *A or B and *B)
 - typ. ± 800 mV with a 180 ohm terminating resistor
 - min. ± 500 mV
 - max. ± 1.0 V
- Current signals (measured in current loop A, *A or B, *B)
 - typ. ± 5.5 μ A with an input resistance of <1 k
 - min. ± 3.0 μ A
 - max. ± 8.0 μ A

The amplitudes of the zero mark signal have the following values:

- Voltage signals (measured between R and *R)
 - active typ. $+800$ mV with a 180 ohm terminating resistor
 - min. $+200$ mV
 - max. $+2.5$ V
 - inactive typ. -800 mV with a 180 ohm terminating resistor
 - min. -200 mV
 - max. -2.5 V
- Current signals (measured in current loop R and *R)
 - active typ. $+2$ μ A with terminating resistor <1 k
 - min. $+0.2$ μ A
 - max. $+7.7$ μ A
 - inactive typ. -4.0 μ A with terminating resistor <1 k
 - min. -15 μ A
 - max. -0.2 μ A

Encoder frequencies of up to 500 kHz can be processed with the SIPOS unconditioned signal and/or absolute encoder.

Measuring pulse jumpering

The following jumperings are possible depending on the type of measuring encoder used:

		Dip-Fix		
		S3	S4	S2
Open Collector		Closed	Closed	2
+24 V, 24 V relay logic	NO contact	Open	Open	1
	NC contact	Open	Open	2
0 V relay	NO contact	Closed	Closed	2
	NC contact	Closed	Closed	1

Total current	+5 V	+15 V	-15 V	V _{CC}
Typical	1.1 A	0.12 A	0.1 A	—
Current carrying capacity of connectors (X111 to X131)	1.9 A	1 A	1 A	—
Per encoder supply (X111 to X131)	0.5 A	0.5 A	0.5 A	—

For the total current, the encoders, modules, hybrids and amplifier box are to be considered.

3 measuring circuit/actual value inputs for interfacing 3 axes with incremental position encoders or SIPOS absolute encoder submodules are on each of the 20 mm and 40 mm wide HMS measuring circuit modules. 3 submodule locations for accommodating one SERVO COMMAND submodule each or 1 SIPOS absolute encoder submodule plus one SERVO COMMAND submodule are additionally provided on the double-height module. The double-height HMS measuring circuit module can have a complement which contains SERVO COMMAND submodules for all 9 axes/spindles (this does not then include a SIPOS absolute encoder submodule).

Note:

- The SIPOS absolute encoder submodule can only be plugged into the upper submodule interfaces X211 and X311 of the HMS measuring circuit module.
- Via an I/V hybrid, which can be plugged onto the module or the rotary encoder, it is possible to connect linear scales with unconditioned current signals to the HMS module (max. length < 17 m). Each of the 3 measuring system inputs on the HMS module can be equipped with an I/V hybrid. For longer cable length please use the linear scale adaptor box 6FC9 320-4HM12.

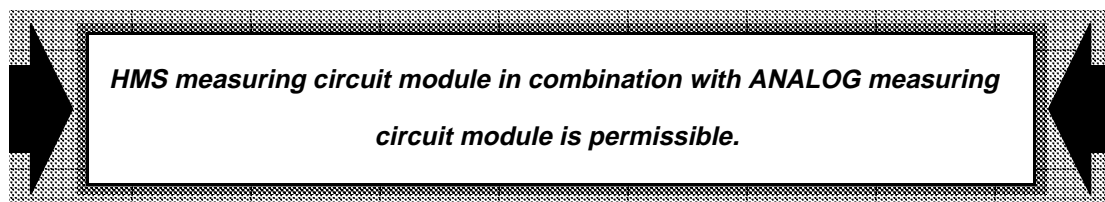

Encoder signal jumpering interface

Connector designations: X12, X17, X23

20-pin IC base (DIP 20) for installation of a current/voltage converter hybrid when encoders with unconditioned current signals (option) are used.

Pin assignment of IC base X12, X17, X23

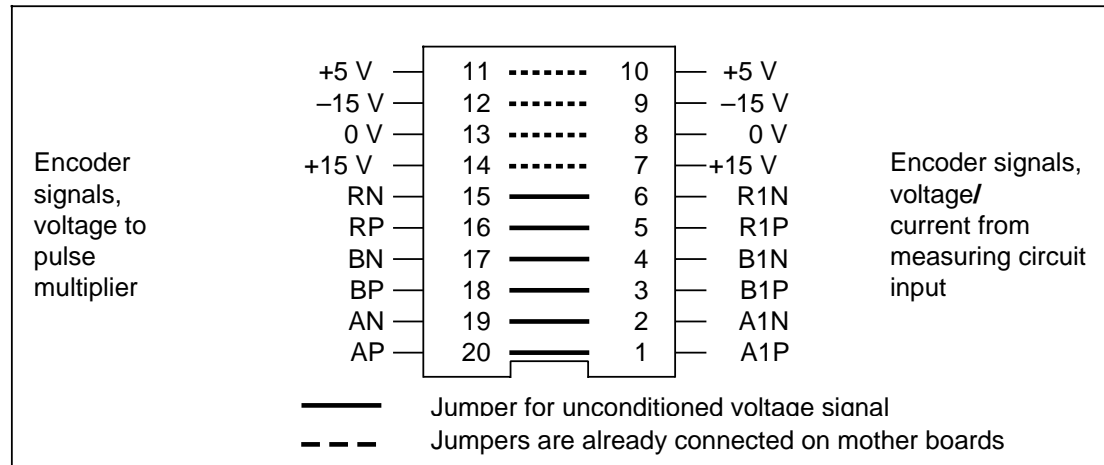

AP	Encoder signal	A	(Unconditioned voltage or current signal)
AN	Encoder signal	*A	(Unconditioned voltage or current signal)
BP	Encoder signal	B	(Unconditioned voltage or current signal)
BN	Encoder signal	*B	(Unconditioned voltage or current signal)
RP	Encoder signal	R	(Unconditioned voltage or current signal)
RN	Encoder signal	*R	(Unconditioned voltage or current signal)
A1P	Encoder signal	A	(Unconditioned voltage signal)
A1N	Encoder signal	*A	(Unconditioned voltage signal)
B1P	Encoder signal	B	(Unconditioned voltage signal)
B1N	Encoder signal	*B	(Unconditioned voltage signal)
R1P	Encoder signal	R	(Unconditioned voltage signal)
R1N	Encoder signal	*R	(Unconditioned voltage signal)

When encoders which provide an unconditioned voltage signal (standard) are used, the interfaces are equipped with short-circuit plugs (U12 for X12, U17 for X17, U23 for X23) which link opposing pins (1--20, 2--19, 3--18, ...). The pins of the supply voltages are already linked together on the module, e.g. pins 7—14, ... 10—11.

2.3.4.2.1 SERVO COMMAND submodule

6FC5 111-0BA60-0AA0

The SERVO COMMAND submodule is used for the output of setpoints of 3 axes/spindles each and is plugged into the submodule interface on the HMS measuring circuit module (double-width with submodule interface). Up to 3 submodules can be slotted into this module. The interface is located at the front and is compatible with those on the ANALOG measuring circuit module. The SERVO COMMAND submodule additionally enables the following functions in the HMS measuring circuit module:

- 3 analog setpoint outputs (one output per axis)
- 3 servo enables (one enable per axis)

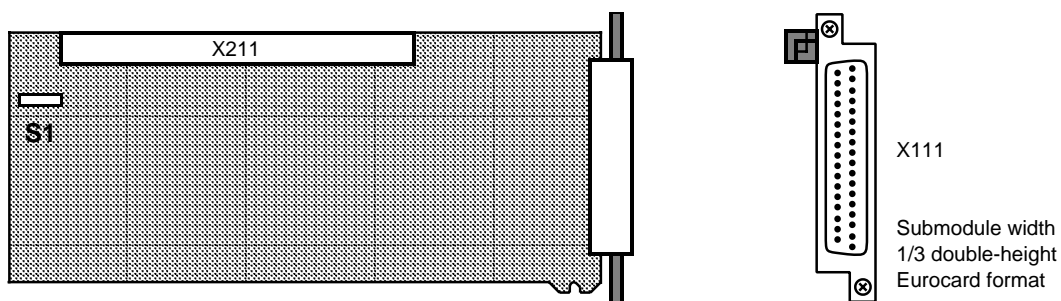

- X111 – Setpoint/servo enable for 3 axes
- X211 – Submodule interface
- S1 – Submodule ready (closed)

Output for the servo enable

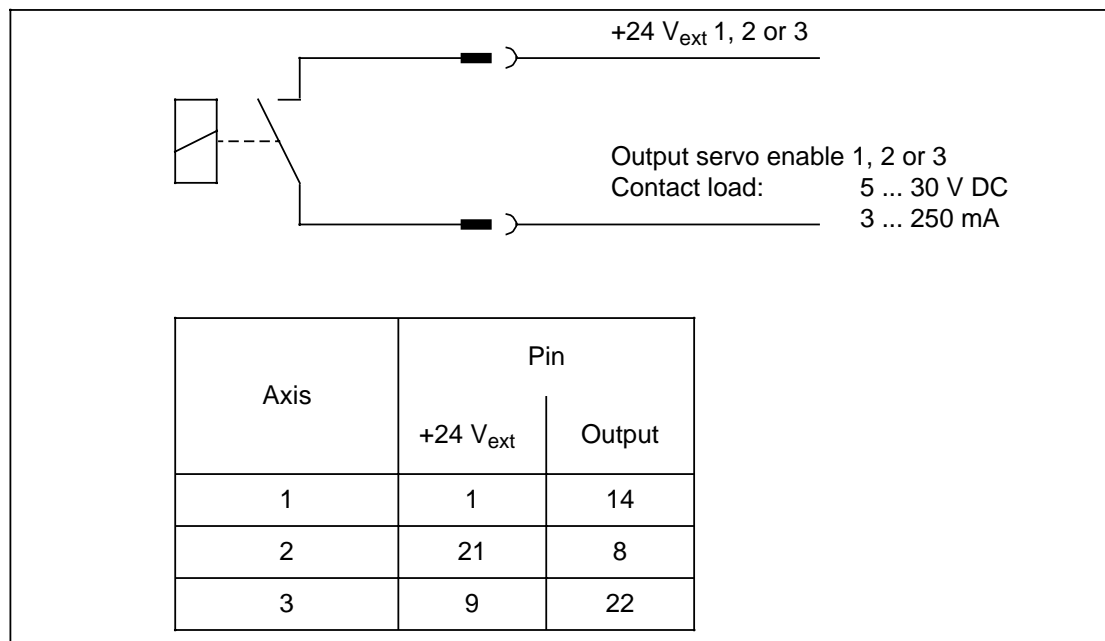

Total current	+5 V	+15 V	-15 V	V _{CC}
Typical	0.10 A	0.05 A	0.05 A	—

2.3.4.2.2 SIPOS absolute encoder submodule 6FC5 111-0BA61-0AA0

On the double-width HMS measuring circuit module, a SIPOS absolute encoder submodule can be plugged onto the upper submodule interface (X211). Together with the SIPOS absolute encoder submodule, SIPOS absolute encoders can be evaluated at all 3 inputs. A SERVO COMMAND submodule can be plugged into the remaining submodule location.

A battery submodule must be plugged into the SIPOS absolute encoder submodule for saving the absolute values in case of a power failure.

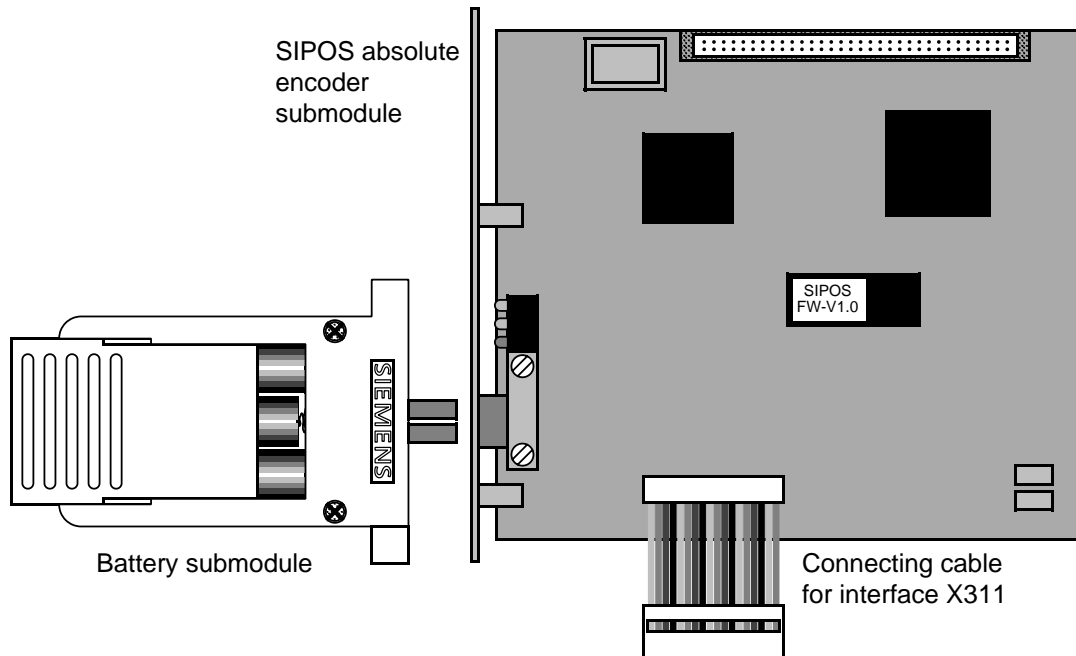

You can operate SIPOS unconditional signal encoders and SIPOS absolute encoders simultaneously on the HMS measuring circuit module.

Total current	+5V	+15V	-15V	V _{CC}
Typical	0.35 A	0.05 A	0.05 A	-

2.3.4.2.3 I/V hybrid

6FC5 147-0AA08-0AA0

I/V hybrids can be plugged onto the HMS measuring circuit module to use unconditioned current signal encoders for actual value acquisition.

The I/V hybrid must be plugged onto base X12, X17 or X23 to replace the short-circuit connector.

One ordering unit contains 3 I/V hybrids.

Install as follows:

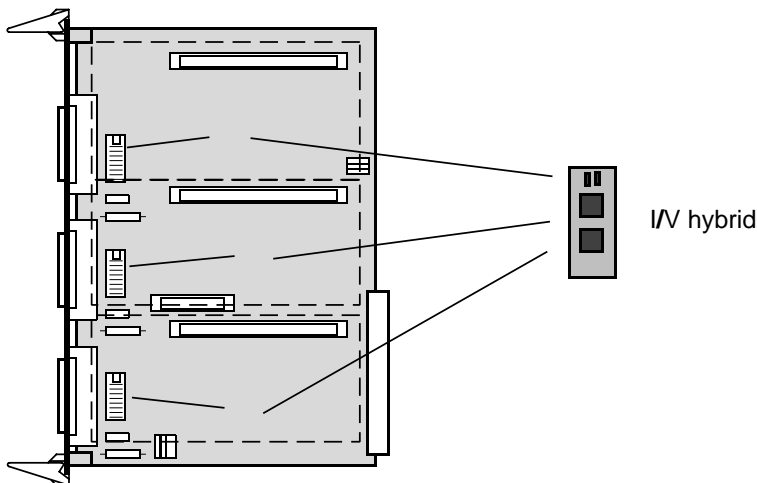

- X23 (for measuring circuit 1)
- X17 (for measuring circuit 2)
- X12 (for measuring circuit 3)

Total current	+5V	+15V	-15V	V _{CC}
Typical	-	0.03 A	0.03 A	-

2.3.4.3 IN ANALOG I/O module**6FC5 111-0CB01-0AA0**

The module is used for the acquisition of analog measured values.

Function blocks:

- 8 analog inputs, non-floating, with programmable input filters (voltage range -10 V to +10 V, smallest resolution: 4.88 mV)
- Overvoltage protection ± 35 V
- RC low-pass filters which can be connected by software (three different time constants: 0.01 ms; 0.1 ms; 1 ms)
- Automatic hardware-controlled offset compensation
- Addressing optionally by software (PAD) or address comparator

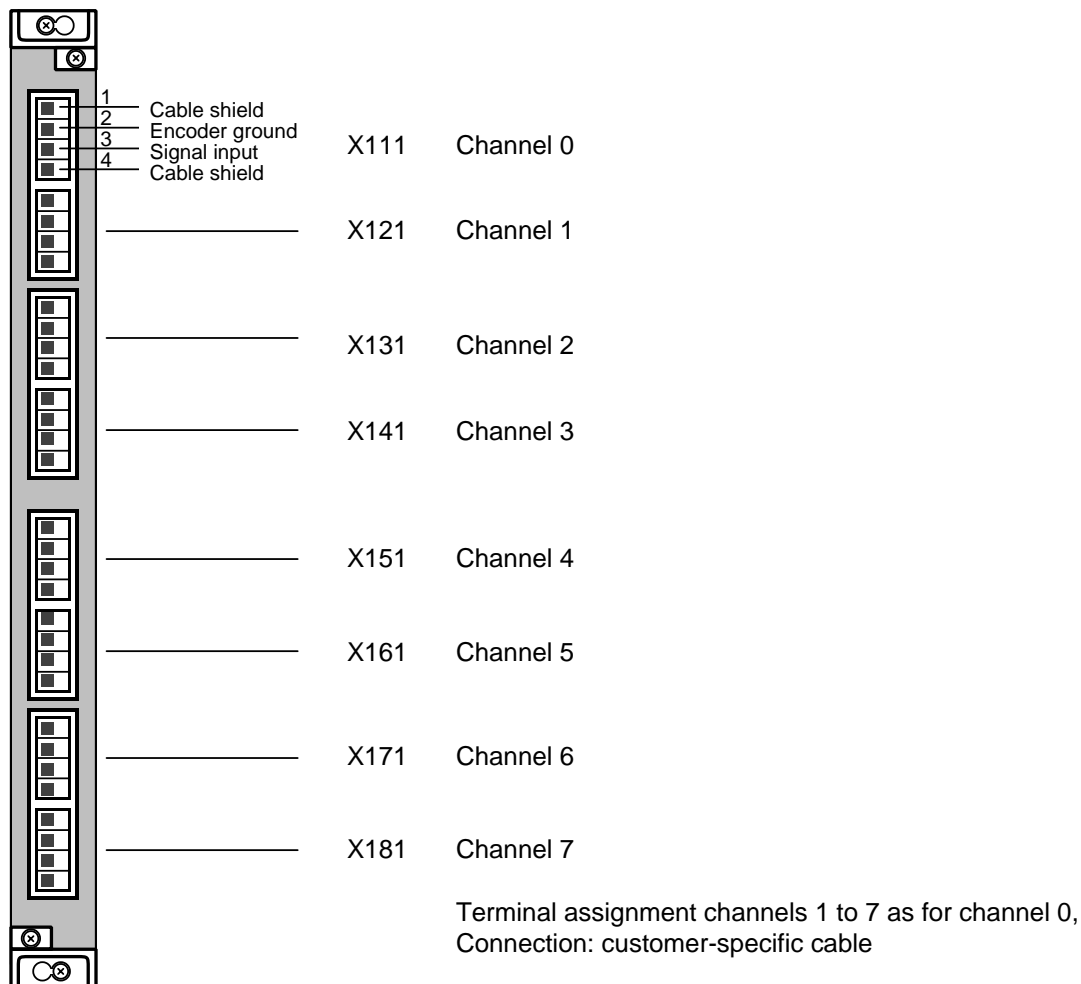
Location of interfaces, the operator control and display elements**Note:**

The module occupies 16 consecutive input and output bytes on the PLC interface.

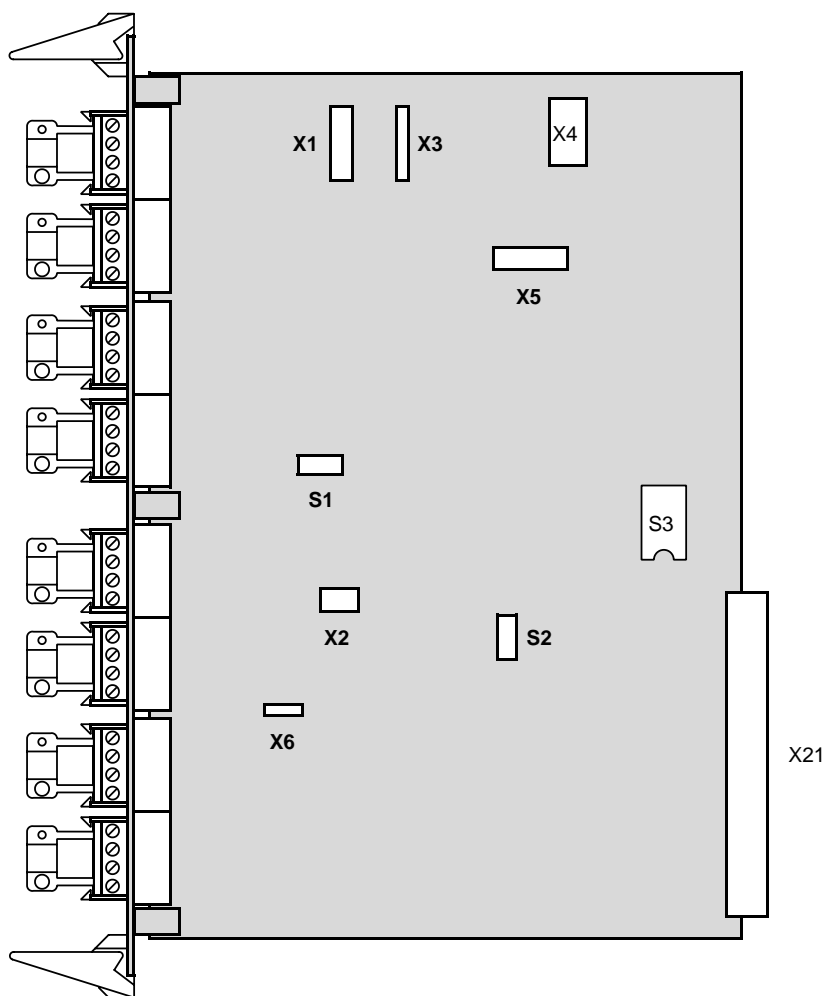

- X111 to X181 – 8 analog inputs ± 10 V (at the front)
- X1, X2, X3 – For test purposes only
- X4, X5, X6 – For test purposes only
- S1 – Permanently set by the manufacturer
- S2 – Permanently set by the manufacturer
- S3 – Customer jumpering (see following table: Setting of initial addresses)
- X21 – Bus interface

Inputs not used are to be short-circuited (link encoder ground potential with signal input) or connected to the shield (encoder ground and signal input).

Total current	+5 V	+15 V	-15 V	V _{CC}
Typical	0.55 A	0.09 A	0.1 A	—

Analog input circuit

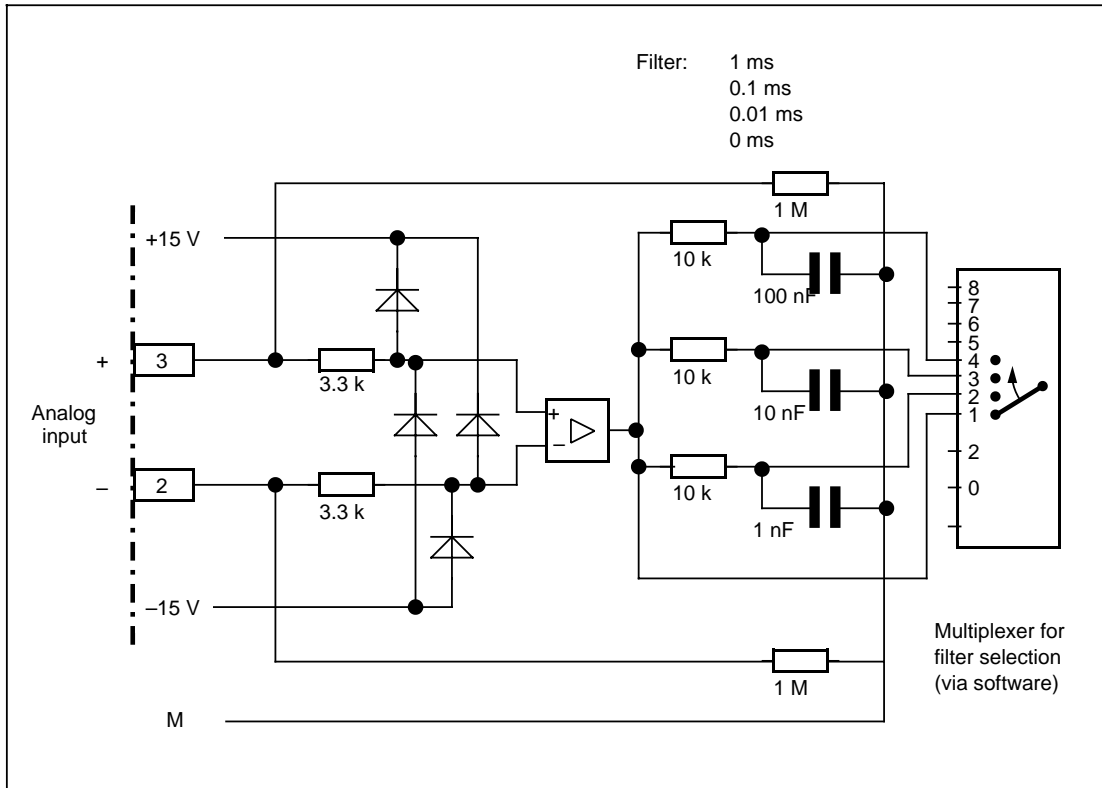

Setting of initial address m

Initial address (hex.)	Input byte (dec.)	Socket S3 (DIP FIX)
00	0 - 15	
10	16 - 31	
20	32 - 47	
30	48 - 63	
40	64 - 79	
58	80 - 95	
⋮	⋮	
E0	224 - 239	
F0	240 - 255	

Note:

Jumpers 1, 6, 7 and 8 must always be open.

Assignment of inputs on the PLC interface

The input word *m* always describes how the digitized analog value is stored.

Analog input module								
Byte No.	Bit No.							
	7	6	5	4	3	2	1	0
IB <i>m</i>	2 ¹¹ Sign	2 ¹⁰	2 ⁹	2 ⁸	2 ⁷	2 ⁶	2 ⁵	2 ⁴
	Connector X111, Channel 0 - Input 1							
IB <i>m</i> +1	2 ³	2 ²	2 ¹	2 ⁰	1 ¹⁾	1 ¹⁾	1 ¹⁾	1 ¹⁾
	Connector X121, Channel 1 - Input 2							
IB <i>m</i> +2								
	Connector X131, Channel 2 - Input 3							
IB <i>m</i> +3								
	Connector X141, Channel 3 - Input 4							
IB <i>m</i> +4								
	Connector X151, Channel 4 - Input 5							
IB <i>m</i> +5								
	Connector X161, Channel 5 - Input 6							
IB <i>m</i> +6								
	Connector X171, Channel 6 - Input 7							
IB <i>m</i> +7								
	Connector X181, Channel 7 - Input 8							
IB <i>m</i> +8								
	Connector X191, Channel 8 - Input 9							
IB <i>m</i> +9								
	Connector X201, Channel 9 - Input 10							
IB <i>m</i> +10								
	Connector X211, Channel 10 - Input 11							
IB <i>m</i> +11								
	Connector X221, Channel 11 - Input 12							
IB <i>m</i> +12								
	Connector X231, Channel 12 - Input 13							
IB <i>m</i> +13								
	Connector X241, Channel 13 - Input 14							
IB <i>m</i> +14								
	Connector X251, Channel 14 - Input 15							
IB <i>m</i> +15								

Set address *m* by jumpering on the module.

¹⁾ These bits are always active when the signal is 1. They must be masked if necessary.

Digital representation of analog values

The voltage range of the eight analog inputs is $\pm 10V$. With a resolution of 12 bits, increments of 4.88 mV each are attained. The analog values are digitized in two's complement.

Input word	IBm								IBm+1				Analog input voltage					
	7	6	5	4	3	2	1	0	7	6	5	4		3	2	1	0	
Significance	2 ¹¹	2 ¹⁰	2 ⁹	2 ⁸	2 ⁷	2 ⁶	2 ⁵	2 ⁴	2 ³	2 ²	2 ¹	2 ⁰	always 1					
Digital value	0	1	1	1	1	1	1	1	1	1	1	1	1	1	1	1	9.99512 V	
	⋮															:		
	0	0	0	0	0	0	0	0	0	0	0	0	1	1	1	1	4.88 mV	
	0	0	0	0	0	0	0	0	0	0	0	0	0	1	1	1	1	0V
	1	1	1	1	1	1	1	1	1	1	1	1	1	1	1	1	- 4.88 mV	
	⋮															:		
	1	0	0	0	0	0	0	0	0	0	0	0	0	1	1	1	1	- 10V

Programmable input filters

Filters for interference suppression can be cut in by the user program in the individual analog channels. The filters are selected by describing the output word corresponding to the addressed input word. No other output module must be addressed on this output word.

Byte No.	Bit No.							
	7	6	5	4	3	2	1	0
QB m	Channel 7 F1 F0		Channel 6 F1 F0		Channel 5 F1 F0		Channel 4 F1 F0	
QB m +1	Channel 3 F1 F0		Channel 2 F1 F0		Channel 1 F1 F0		Channel 0 F1 F0	
⋮	Reserved by the system, cannot be used							
QB m +15	Reserved by the system, cannot be used							

The initial address m corresponds to the initial address of the input bytes.
The two bits for filter selection (F0, F1) permit four different input configurations in each channel:

Bit		Input configuration
F1	F0	
0	0	Direct connection, standard after reset
0	1	Filter T1 = 0.01 ms
1	0	Filter T2 = 0.1 ms
1	1	Filter T3 = 1 ms

Example:

Filter channel 2: 1 ms, initial address of IW 16 module

LKH 0003

T QW16 (cyclic operation)

Technical data

Number of inputs Isolation	8 voltage inputs, analog No
Input range (rated values)	±10V
Input resistance in the individual ranges	1 MOhm
Connection of the signal generators	Two-wire connection
Digital representation of the input signal	12 bits, two's complement
Measuring principle	Successive approximation
Conversion principle	Successive approximation
Time constant (adjustable for optimal interference voltage suppression)	See last table on previous page
Coding time Single coding possible	max. 396 µs for 8 channels, including 1 adjustment cycle; No
Scan time for 8 inputs	396 µs
Permissible voltage between inputs or between inputs and central earthing point (destructive limit)	±35 V DC
Permissible voltage between reference potential of a non-floating encoder and central earthing point	±1 V
Error message in case of - Limit violation - Wire break of the signal generator line	No No
Basic error limits	1 LSB
Operating error limits (0 °C to 70 °C)	7 LSB at ±10 V
Power supply (as for analog outputs)	5 V, ±15 V
Current consumption internal (for 5 V) internal (for 24 V)	typ. 5 V: 0.55 A typ. ±15 V: 0.1 A
Format	Double-height Eurocard
Module width	20 mm
Weight	approx. 400 g
Degree of protection to DIN 40050	IP0
Humidity class to DIN 40040	F

2.3.4.4 MIXED I/O module

6FC5 111-0CB02-0AA0

This module is used to record digital measured values and to output digital or analog signals.

Function blocks:

- 16 digital inputs, floating, groups of eight
- 16 digital outputs, floating, 24 V/400 mA, groups of eight, current-limited
- 4 analog outputs, non-floating, ± 10 V/3 mA, current-limited, resolution 16 bits with sign
- 2 LEDs for indicating digital output faults (one LED per output block)
- 4 potentiometers for analog output offset compensation
- 1 terminal block for 24 V DC power supply of digital outputs
- Address routing via comparator or software

Location of interfaces and the operator control and display elements

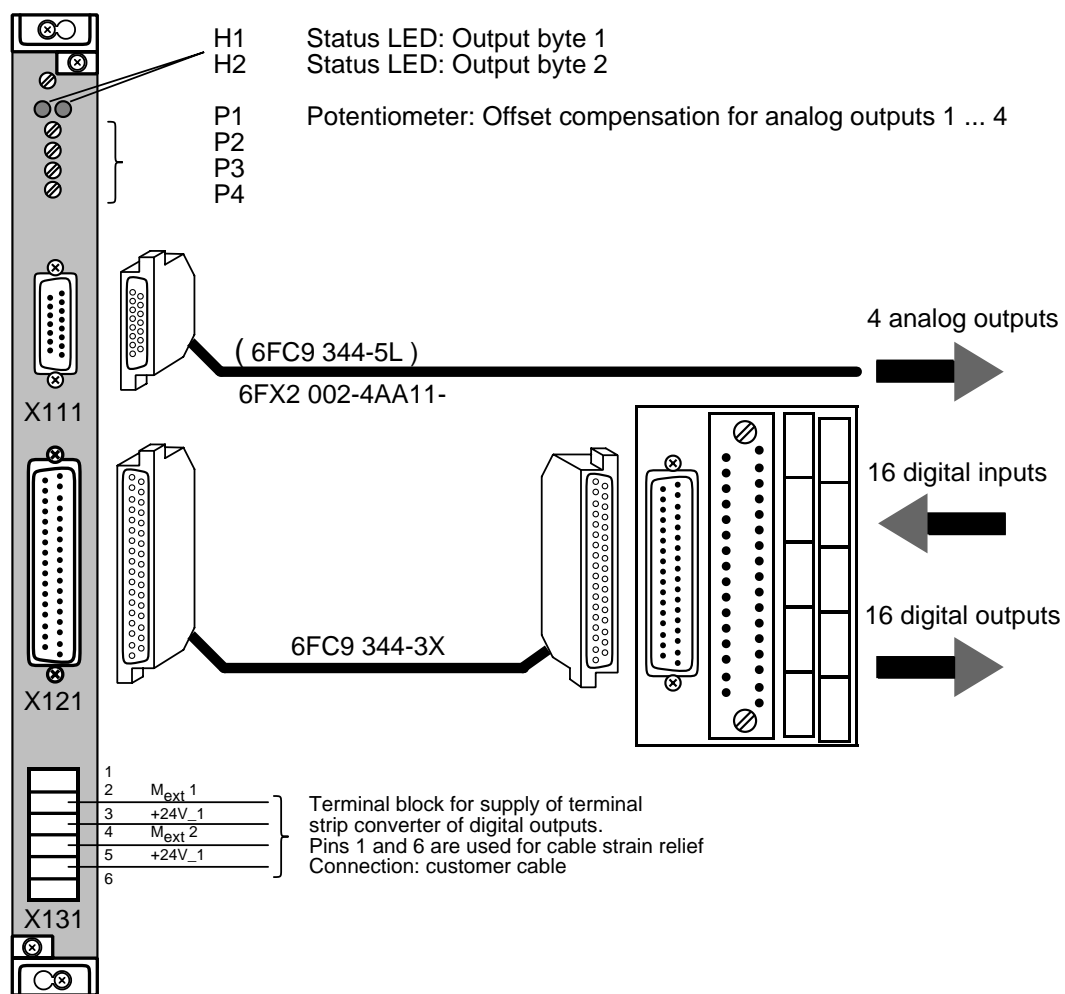

Note:



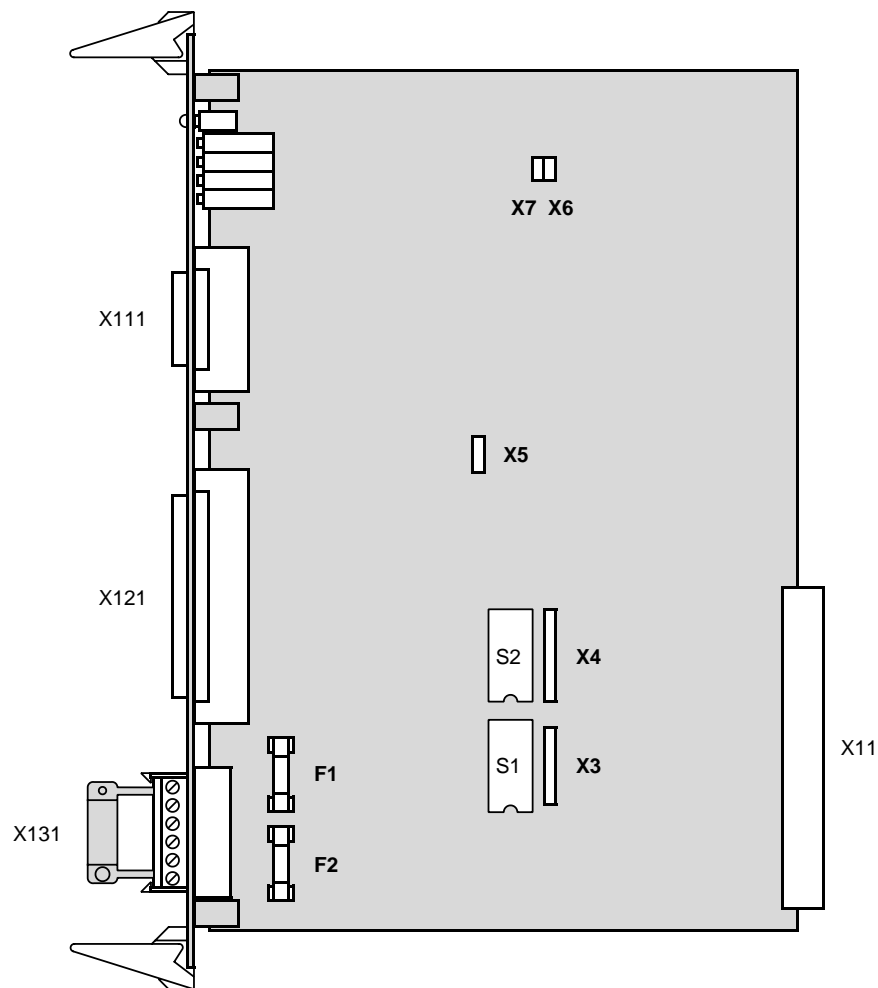





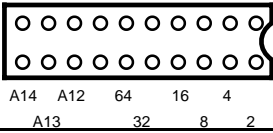

2 input and 2 output bytes for digital inputs and outputs and 8 output bytes for analog outputs are assigned to this module on the PLC interface.

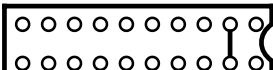

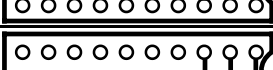
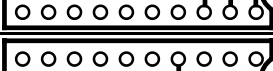

- X3, X4, X5 – For test purposes only
- X6, X7 – For test purposes only
- S1 – Customer jumpering for digital inputs/outputs (see "Setting of initial addresses")
- S2 – Customer jumpering for analog outputs (see "Setting of initial addresses")
- F1, F2 – 250 V/4 A fuse, fast fuse
- X11 – Bus interface
- X111 – Analog outputs
- X121 – Digital inputs/outputs
- X131 – Power supply

Total current	+5 V	+15 V	-15 V	V _{CC}
Typical	0.52 A	0.07 A	0.08 A	—

Setting the initial address m for digital inputs/outputs

Initial address (hex.)	Input byte Output byte (dec.)	S1
		
0	0 ... 1	
2	2 ... 3	
4	4 ... 5	
6	6 ... 7	
8	8 ... 9	
A	10 ... 11	
C	12 ... 13	
E	14 ... 15	
10	16 ... 17	
⋮	⋮	⋮
F8	248 ... 249	
FA	250 ... 251	
FC	252 ... 253	
FE	254 ... 255	

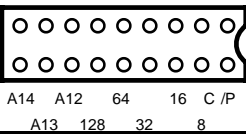
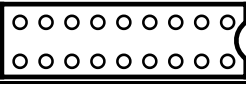
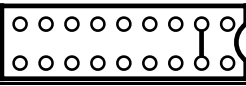
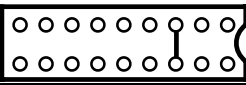
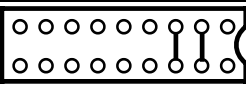
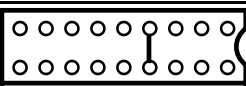
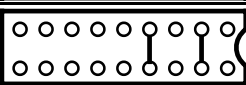
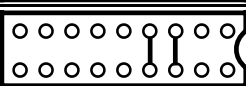
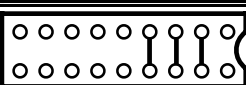
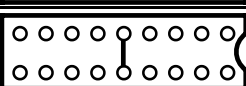
Setting the initial address n for analog outputs

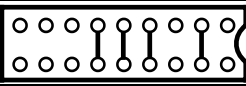
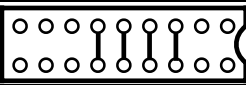
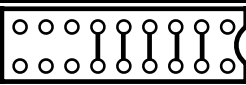
Initial address (hex.)	Output byte (dec.)	S2	
			
00	0 ... 7		
08	8 ... 15		
10	16 ... 23		
18	24 ... 31		
20	32 ... 39		
28	40 ... 47		
30	48 ... 55		
38	56 ... 63		
40	64 ... 71		
⋮	⋮	⋮	⋮
E0	224 ... 231		
E8	232 ... 239		
F0	240 ... 247		
F8	248 ... 255		

Note:

- When using this module in the PLC, the C /P jumper must be open.
- When using this module in the NC, the C /P jumper must be closed, all others open.
- Address inputs must not be used.

Setting the analog outputs

The output word corresponding to the analog output must be described in order to output the voltage values (hexadecimal number).

The address n is set by jumpering on the module.

QW n	Hexadecimal number for analog output 1
QW n+1	Hexadecimal number for analog output 2
QW n+2	Hexadecimal number for analog output 3
QW n+3	Hexadecimal number for analog output 4

A word is made up as follows:

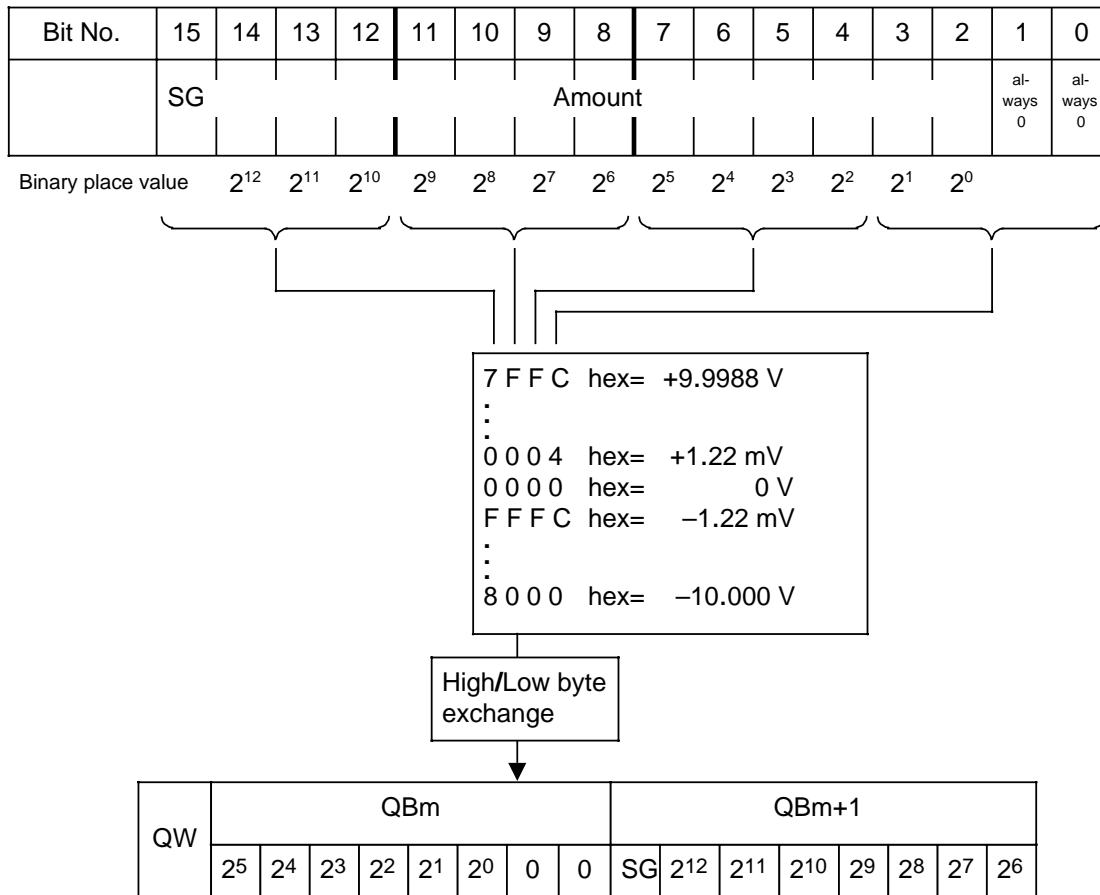

Notes:

- The amount (decimal number)=|V analog| : 10 V x 8192
- Negative values are always expressed in two's complement.
- If the hexadecimal number is output on the output word the high and low bytes must be exchanged.

Examples:

The following voltages should be output at analog output 1 if the address $n = 16$ is set:

Example 1: 9.5 V PLC program

Amount (decimal number):	7782	.
Amount (binary number):	0111 1001 1001 10	L KH 9879
Word (binary number):	0111 1001 1001 1000	T QW 16
Word (hexadecimal number):	7998	.

Example 2: -4.12 V PLC program

Amount (decimal number):	3375	.
Amount (binary number):	0011 0100 1011 11	L KH 44CB
2s complement:	1100 1011 0100 01	T QW 16
Word (binary number):	1100 1011 0100 0100	.
Word (hexadecimal number):	CB44	.

Technical data

Digital IN		
Number of inputs Electrical isolation		16 digital yes
Input voltage (nominal value)		24 V DC
Input voltage	for signal "0" for signal "1"	-3 V to +5 V +13.5 V to +33 V
Input current	with signal "1"	3.6 to 7.7 mA
Delay time Delay time	for tpLH for tpHL	binary inputs: t _{pLH} =max. 3 ms t _{pHL} =max. 3 ms binary outputs: t _{pLH} =max. 0.5 ms t _{pHL} =max. 0.5 ms
Cable length	max.	50m
Digital OUT		
Number of outputs Electrical isolation		16 digital yes
Supply voltage U _P	- Nominal value - Ripple U _{PP} - Permissible range (including ripple)	24 V DC - 20 V to 30 V
Output current	with signal "1" (nominal value)	400 mA
Short-circuit protection		Electronic with LED indication
Limitation of inductive cutout voltage to the switching capacity for lamps		yes
Switching frequency with	- ohmic load - lamps - inductive load (at nominal load. At lower loads, higher values are permissible.)	100 Hz 11 Hz 2 Hz
Overall loading capacity at 55°C (referred to the sum of nominal currents of all outputs)		50%
Signal level output	- for signal"0" - for signal"1"	Output open U _P -1V
Cable length	max.	50m
Analog OUT		
Number of outputs Electrical isolation		4 voltage outputs, analog no
Output ranges (nominal values)		±10 V/3 mA
Load impedance with voltage outputs	min.	3.3 k
Load connection type		Load against 0 V connection
Digital representation of output signal		13 bits +sign
Short-circuit protection		yes
Cable length (shielded)	max.	Analog outputs: 50 m
Current input	internal (at 5V) internal (at 24V)	typ. 0.52 A typ. +15 V: 0.075 A/-15 V: 0.08 A
Format		Double-height Eurocard
Module width		20 mm
Weight	approx.	410 g
Degree of protection to DIN 40050		IP00
Humidity class to DIN 40040		F

2.3.5 Interfaces

2.3.5.1 PLC interface

6FC5 112-0CA01-0AA0

The module is used for connection of distributed I/O devices to the PLC. An MPC interface consisting of two RS 485 interfaces is available for this purpose. The module is used as a RAM module, i.e. the required software is called up by the PLC CPU when powering up. The PLC interface is only required in combination with the PLC CPU 135 WB2. It is integrated in the PLC CPU 135 WD (SW 3 and higher).

Function blocks:

- CPU 80186/16 MHz
- MPC with two RS 485 interfaces for connection of DMP stations
- 8 inputs, floating, generating an interrupt (group interrupt)
- Serial interface for connection of a programmer
- Address routing by software

Location of interfaces, the operator control and display elements

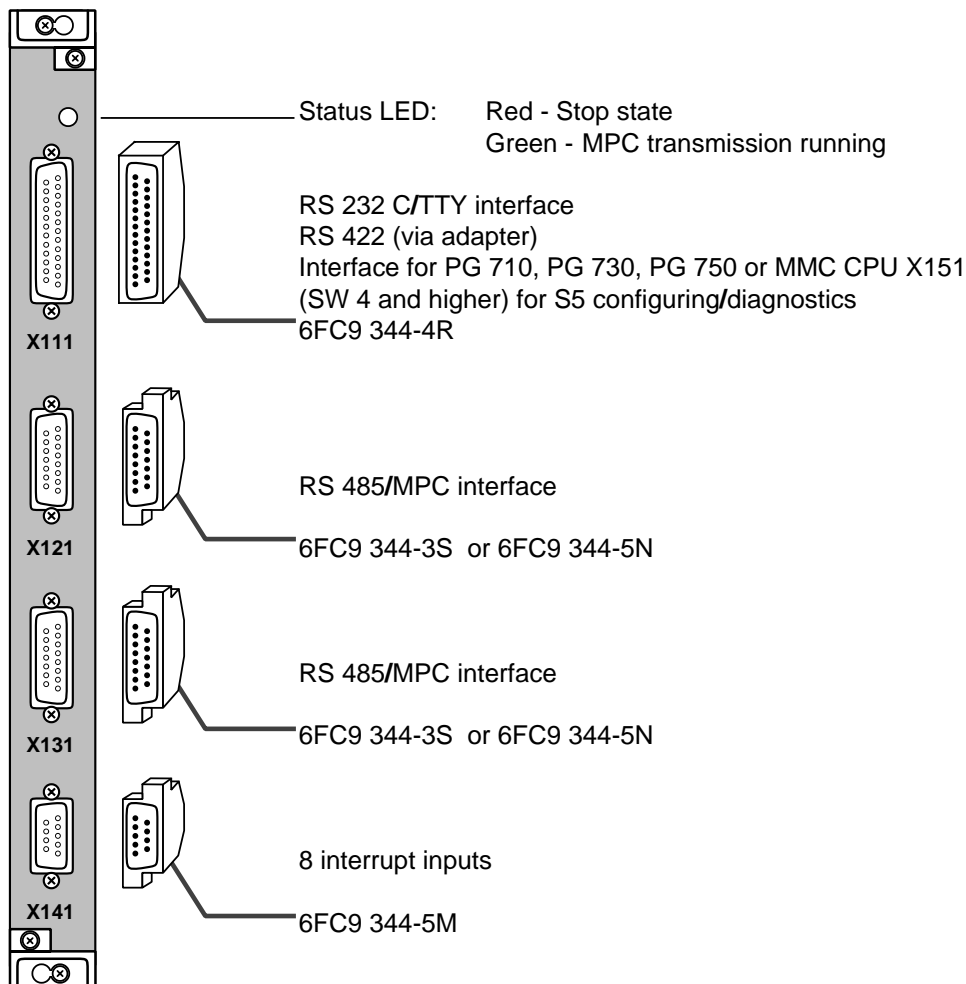

Note:

See Section 4, DMP, for a full overview of the cabling of all possible DMP stations.

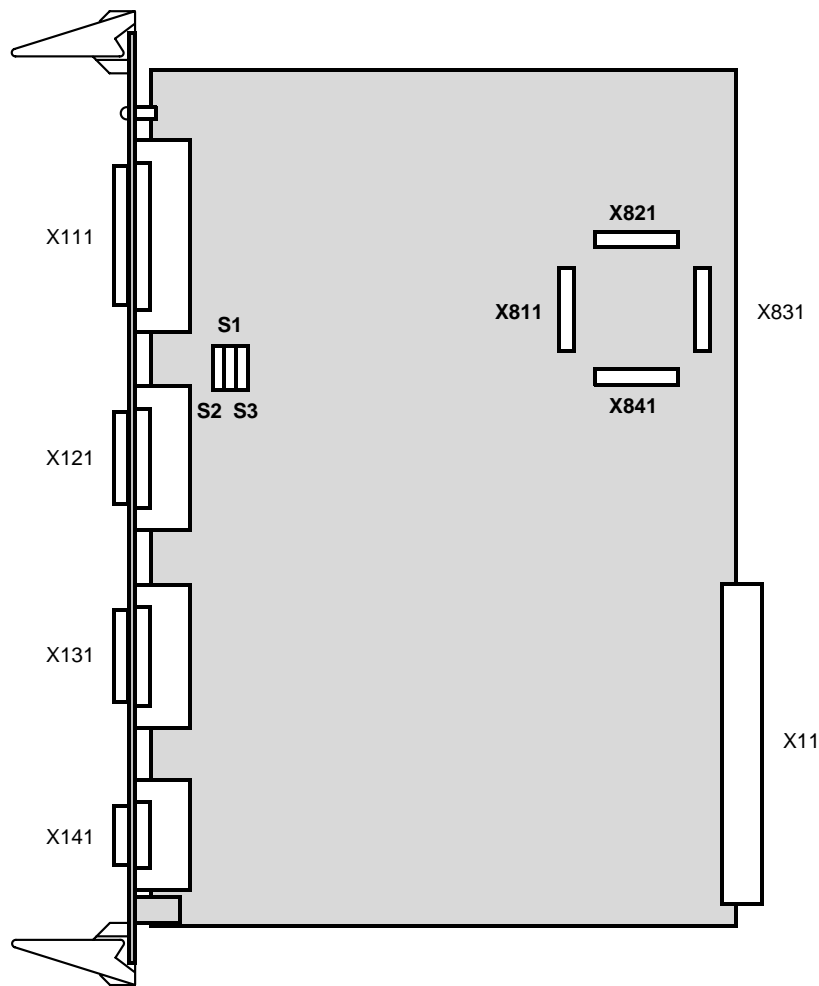

- S1, S2 – Jumpering when using an RS 422 adapter (see following tables)
- S3 – Jumpering of the terminating resistors (see following tables)
- X811, X821, X831, X841 – For testing purposes only
- X11 – Bus interface

Total current	+5 V	+15 V	-15 V	V _{CC}
Typical	1.3 A	0.05 A	0.05 A	—

Jumpering of the terminating resistors for MPC interfaces

The terminating resistors for the MPC interfaces are connected via the S3 jumpers (serial RS 485 bus).

The jumpers may only be closed according to the following scheme and in pairs.

Bus interface	Jumper	Application
X121 or X131 (one connector assigned)	S3 Closed	A
X121 and X131 (two connectors assigned)	S3 Open	B

Application A (1 MPC line)

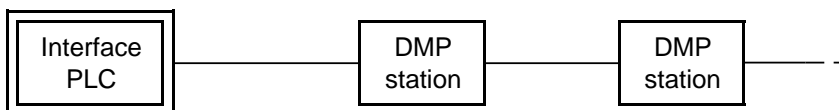

Application B (2 MPC lines)

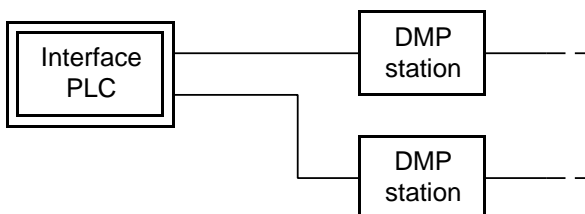

Jumpering when using an RS 422 adapter.

Bus interface	Jumper
RS 232 C	S1/S2 open
RS 422 adapter, plugged in	S1/S2 closed

2.3.5.2 DMP interface

6FC5 112-0CA02-0AA0

This module is used for interfacing distributed machine peripherals to the PLC. For this purpose, two independent MPC interfaces with two RS-485 interfaces each are provided. The module is used as EPROM module.

Function blocks:

- LED display for indicating DMP interface failure
- 80186 processor
- Two MPCs
- 4-Kbyte dual port RAMs
- Address routing by software

Location of interfaces, the operator control and display elements

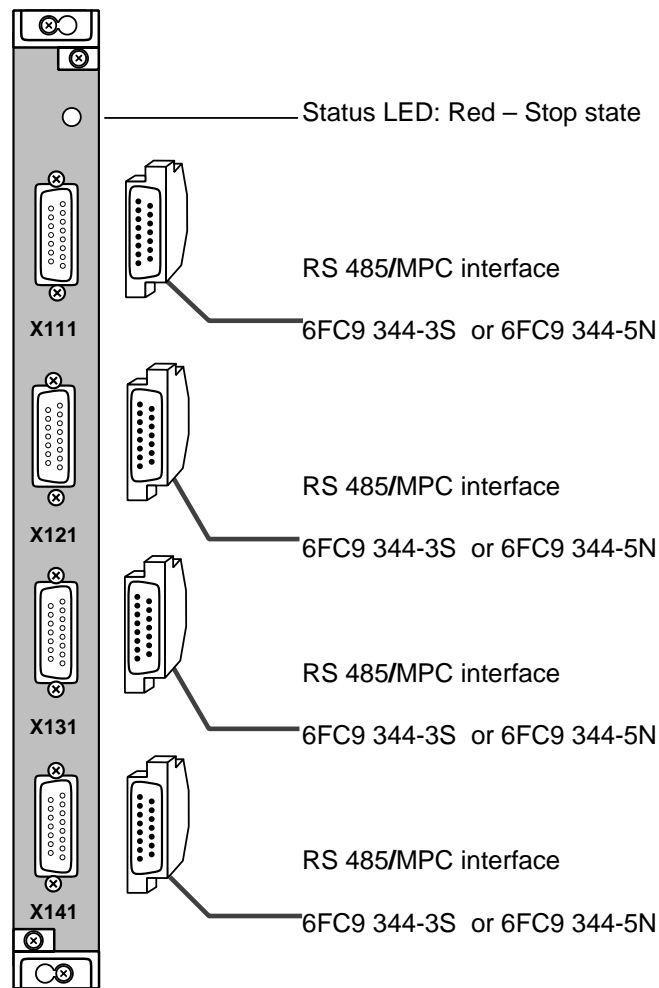

Note:

See Section 4, DMP, for a full overview of the cabling of all possible DMP stations.

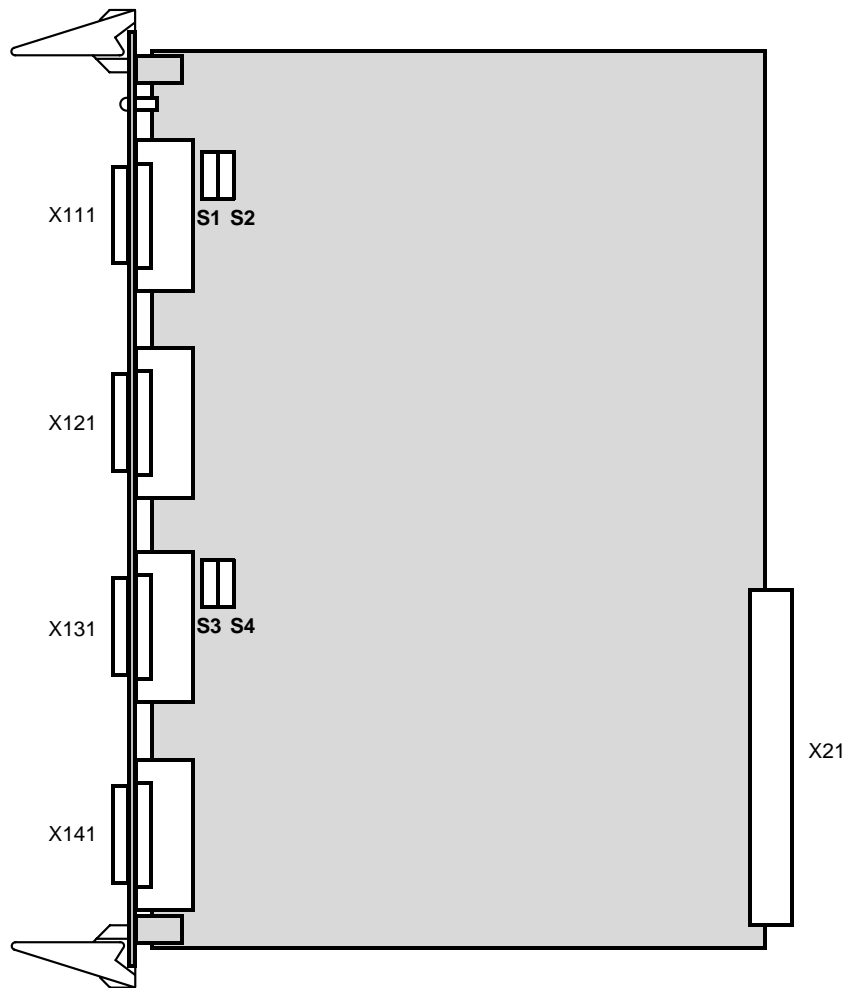

S1, S2, S3, S4 – Jumping of terminating resistances (see following table)

X21 – Bus interface

Total current	+5 V	+15 V	-15 V	V _{CC}
Typical	1.2 A	—	—	—

Jumpering of terminating resistances for MPC interfaces

The terminating resistances for the MPC interfaces (serial RS 485/MPC bus) are connected to the system via jumpers S1/S2 or S3/S4.

The jumpers have to be closed pair by pair and according to the following scheme:

Bus interface	Jumper	Application
X111 or X121 (one connector assigned)	S1/S2 closed	A
X111 and X121 (two connectors assigned)	S1/S2 open	B
X131 or X141 (one connector assigned)	S3/S4 closed	A
X131 and X141 (two connectors assigned)	S3/S4 open	B

Application A (1st MPC line)

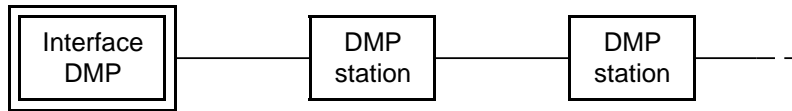

Application B (2 MPC lines)

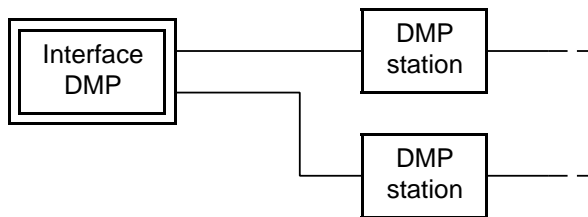

2.3.5.3 EU interface, 16 bit

6FC5 112-0CA03-0AA0

The 16-bit interface EU is used to connect the SIMATIC EUs 183U, 185U, 186U and the ER 701-2 or ER 701-3 expansion racks in parallel.

Function blocks:

- Parallel interface, 16-bit addresses/data, multiplexed
- LED (error indication)
- Address routing by software

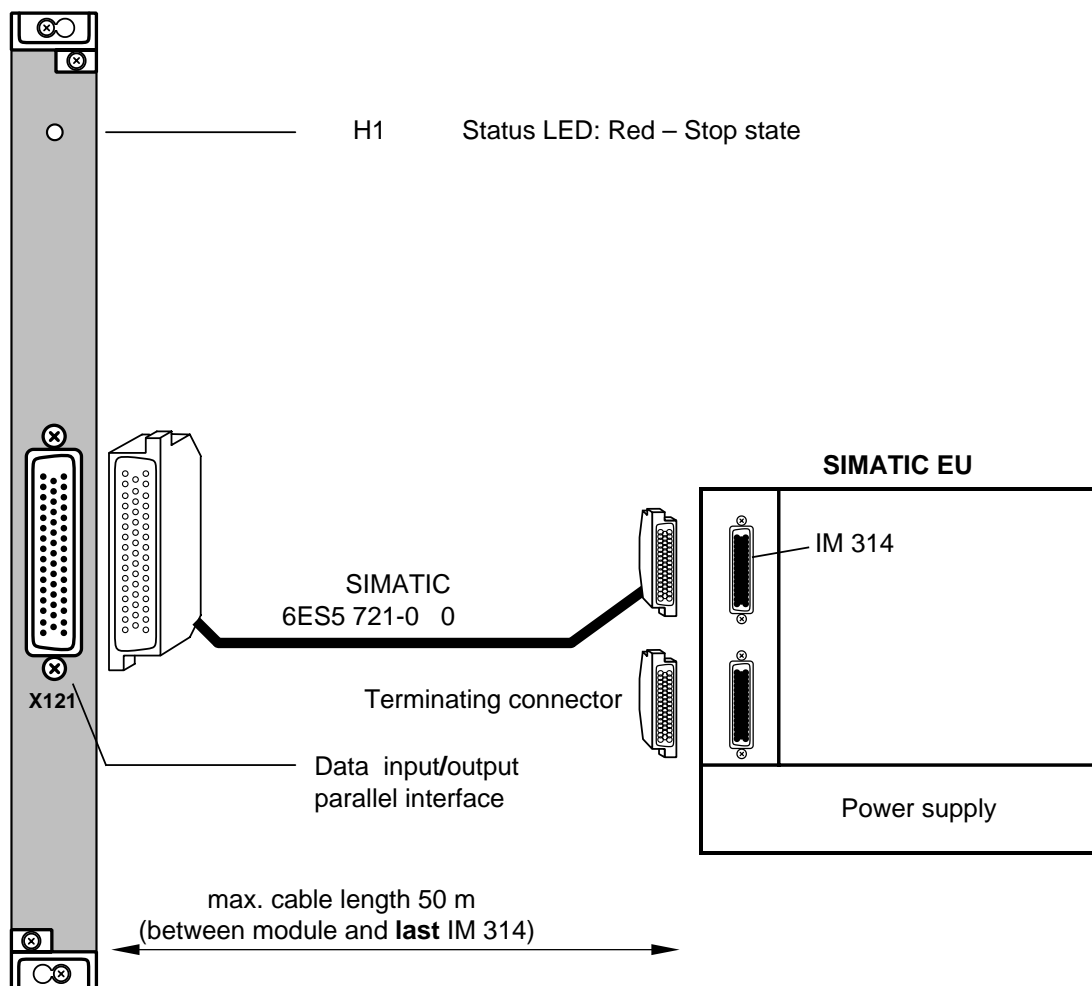
Location of interfaces, the operator control and display elements

The interface is compatible with the SIMATIC IM 314 interface module. The IM 314 is used in the external unit.

For more detailed information refer to the SIMATIC catalog ST 54.1 (Order No. E86060-K4654-A101-A2).

Note:

- SIMATIC EUs can only be interfaced via the 16 bit EU interface module.
- Maximum 2 SIMATIC EUs can be connected in series!

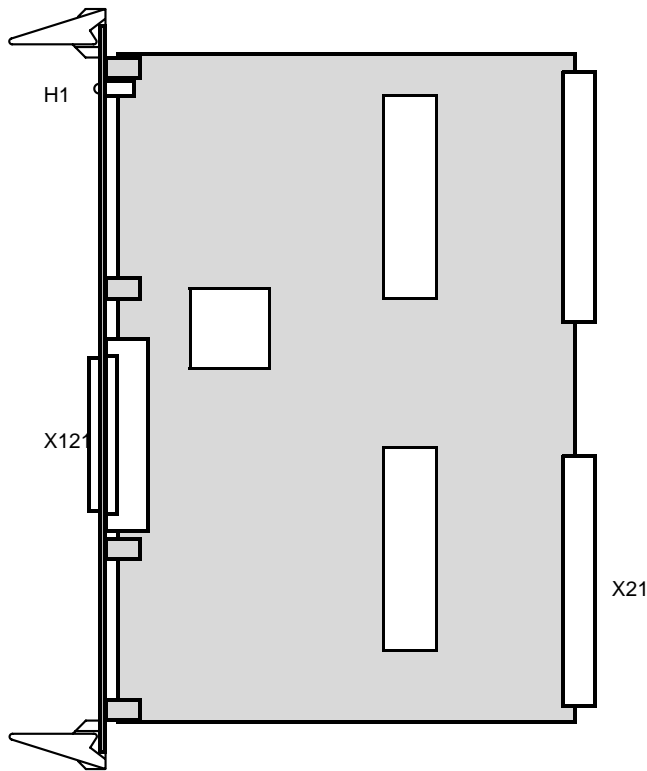

X21 – Bus interface

Total current	+5 V	+15 V	-15 V	V _{CC}
Typical	1,3	—	—	—

2.3.5.4 PROFIBUS DP interface

The SINUMERIK 840C can be linked to the field bus system Profibus DP with the following modules.

Module	Function	Order No. (Module)	Documentation	Order No. (Documentation)
IM 328-N	Slave	6FC5 012-0CA01-0AA0	SIROTEC ACR 20, SINUMERIK 805SM / 840C Link to SINEC L2 DP with Module IM 328-N	6ZB5 430-0BH02-0AA0
IM 329-N	Master and slave	6FC5 012-0CA02-0AA0	SIROTEC ACR 20, SINUMERIK 805SM / 840C Link to SINEC L2 DP with Module IM 329-N	6ZB5 430-0BH02-0AA1

References: SINUMERIK 840C, Catalog NC 36

2.3.5.5 Adapter kit for IM308C (as from SW 6) 6FC5147-0AA25-0AA0

Using the IM308C adapter kit enables the SIMATIC module IM308C - a Profibus-DP interface module - to be used in the SINUMERIK 840C system. One IM308C interface allows the connection of up to 122 passive nodes like e.g. ET200 distributed I/Os or field units with PROFIBUS-DP connection. The IM308C interface can be used in a master or slave mode at the PROFIBUS-DP. Also possible is the combined master and slave mode.

Access to the field units at PROFIBUS-DP (e.g. ET200) is achieved by means of the PLC process image. Alternatively, access to field units is also possible through the FB EM308C functional module. Furthermore, FB IM308C allows reading the diagnostic data, transmitting the control commands SYNC and FREEZE and changing the PROFIBUS DP addresses of field units (e.g. ET200). With SINUMERIK 840C the FB IM308C is assigned to FB number 27 and is delivered together with the FB package 0. The IM308C is configured with the configuration package COM PROFIBUS.

Assembling the kit components

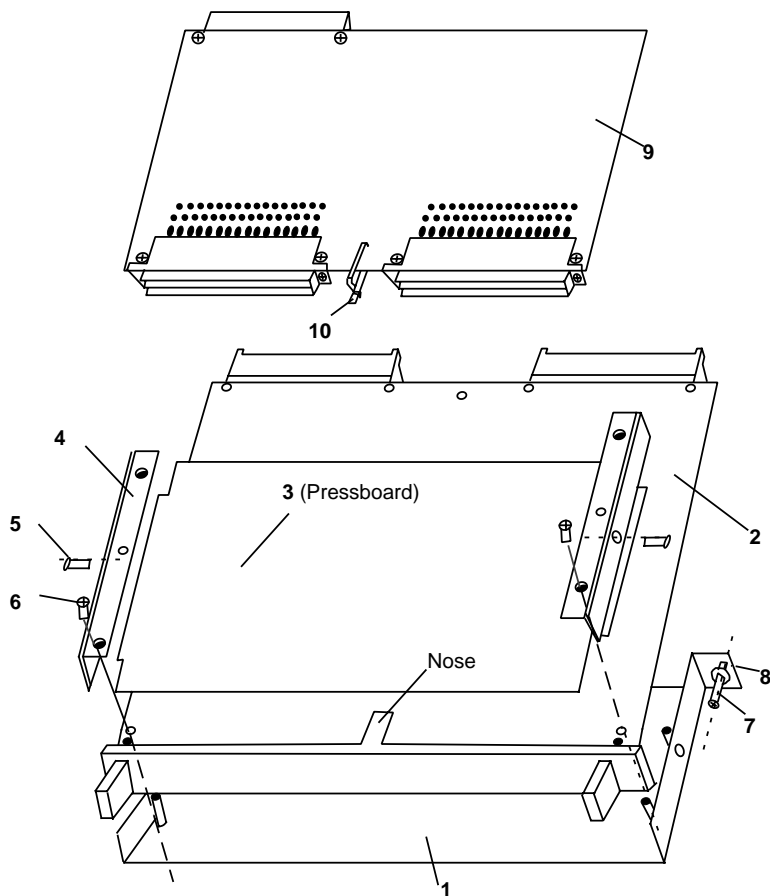

Step

Assembling procedure

- 1 Place housing (item 1) on a flat surface.
- 2 Place module IM308C (item 2) with the component side downwards on the housing.
- 3 Position the pressboard (item 3 - **!! ATTENTION !! Aluminum sheet facing upward and the recess towards the front**) on the soldering side of the module (item 2) and slip it under the nose.
- 4 Attach bracket (item 4) with screws (items 5 and 6) as shown in the drawing.
- 5 Item 7 and 8 are used for fixation to the module rack.
- 6 Connect the adapter (item 9) to module IM308C (item 2).
- 7 Use the cable tie (item 10) to attach the module (item 2) to the adapter (item 9) and shorten its surplus length accordingly.

**Only one IM308C module is allowed in the 840C system.
Module IM308C cannot be operated
in parallel with the Interface EU 16 bit module.**

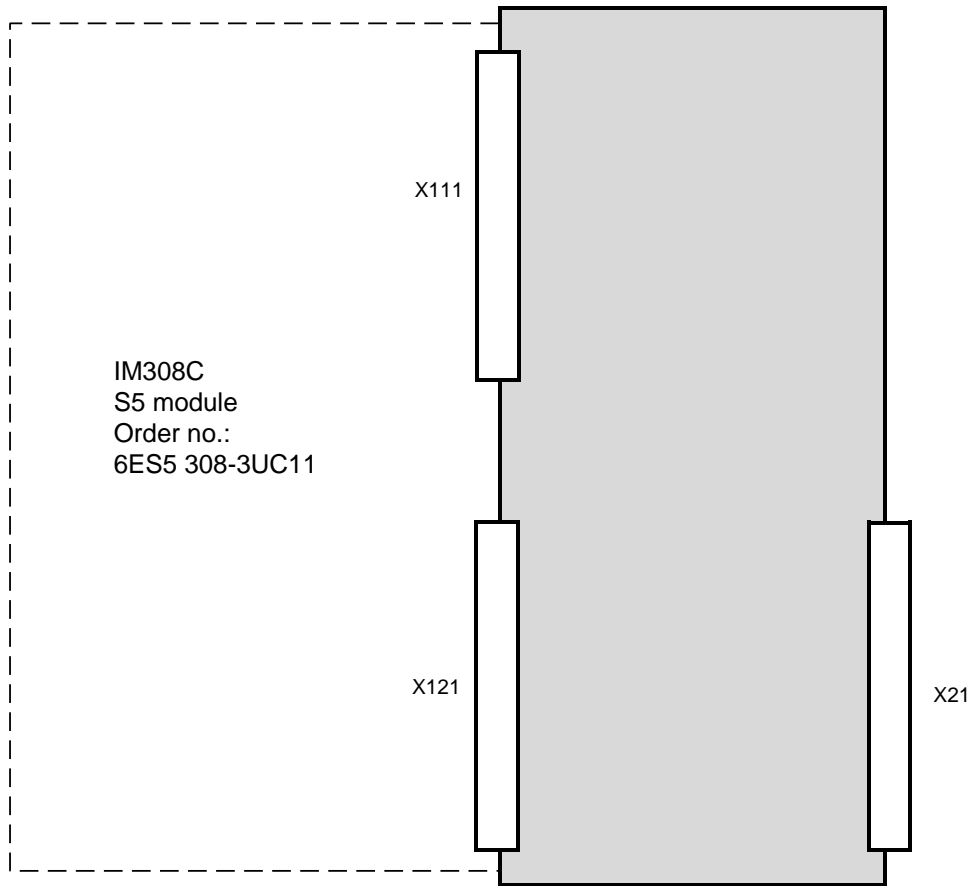

X21 Bus interface
X111/X121 S5 interface

Total current	+5 V	+15 V	-15 V	V _{CC}
Typical				—
X111/X121		—	—	—

2.3.5.6 Bus interface SINEC CP 231A**6FC5 112-0EA01-0AA0**

The SINEC H1 module is used for establishing a computer link and links the NC to a local area network via a coaxial cable (50 in accordance with IEEE 802.3). For installation and for testing purposes, the module has a serial RS232C interface.

Function blocks:

- Plug-in system software submodule
- 1 rotary switch for selecting individual tests from a hardware test program
- 1 LED (error indication)
- 1 serial interface RS232C (TTY/V.24 interface)
- 1 interface to the industrial Ethernet (SINEC H1) bus system (50 in accordance with IEEE 802.3)
- Dual Port memory, 64 Kbytes (buffered)
- Address routing by software

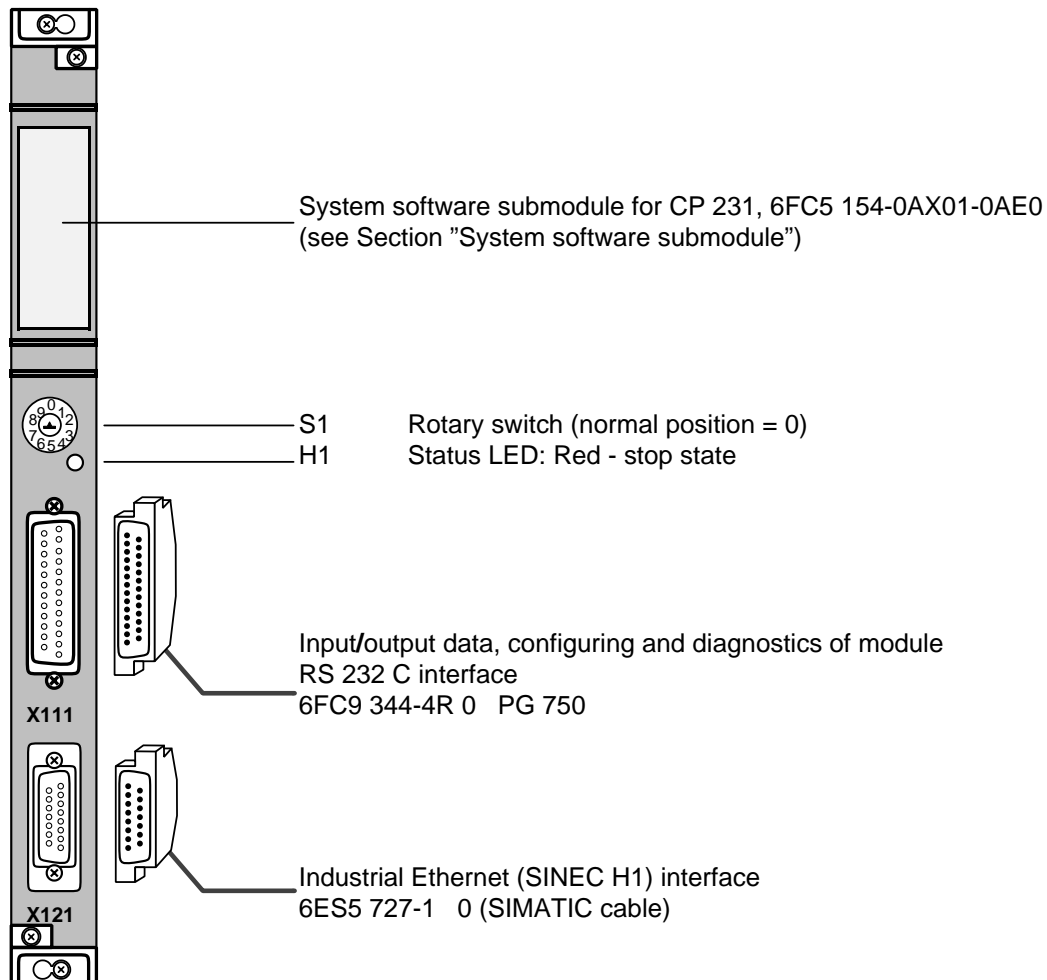
Location of interfaces, the operator control and display elements

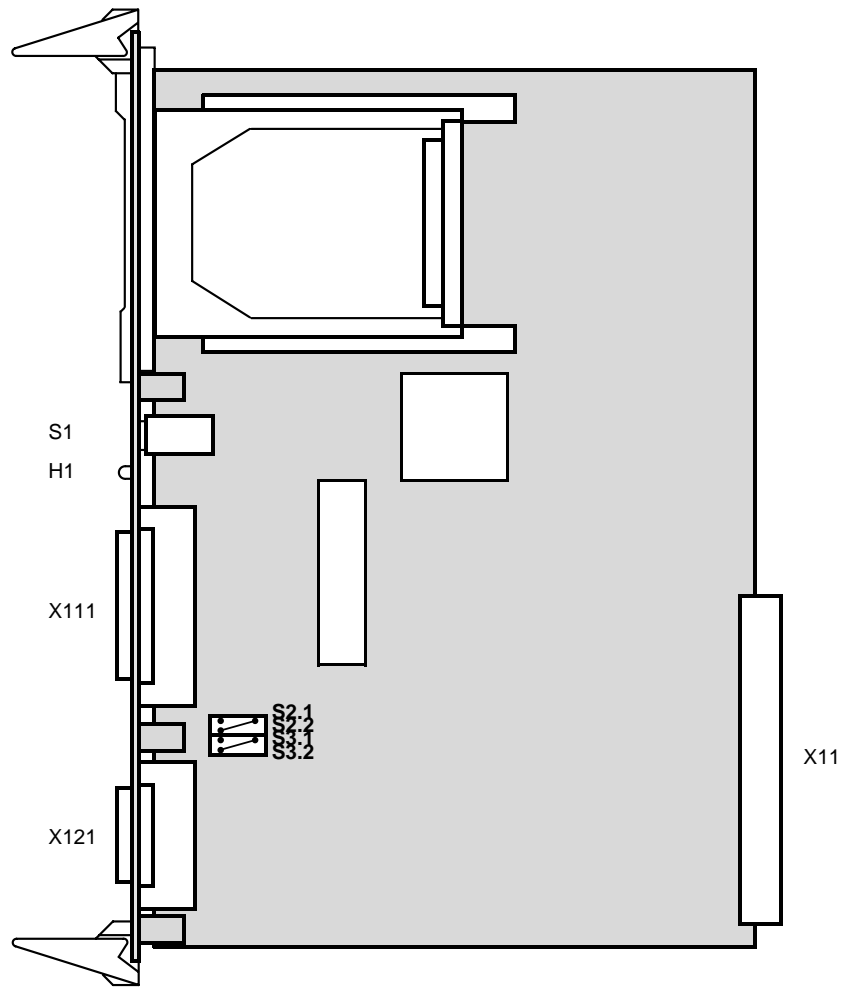

- S2 – Position 2.2
- S3 – Position 3.2
- X11 – Bus interface

Total current	+5 V	+15 V	-15 V	V _{CC}
Typical	2.1 A	0.3 A	0.05 A	—
X111/X121	0.9 A	—	—	—

2.3.5.6.1 System software submodule for CP 231 6FC5 154-0AX01-1AE0 System software submodule for CP 315 6FC5 154-0AX02-1AE0

The system software submodule is an EPROM memory submodule with a memory capacity of 256 Kbytes for the ACTIVE V.24 module CP 315 and/or 512 Kbytes for the bus interface SINEC CP 231A module.

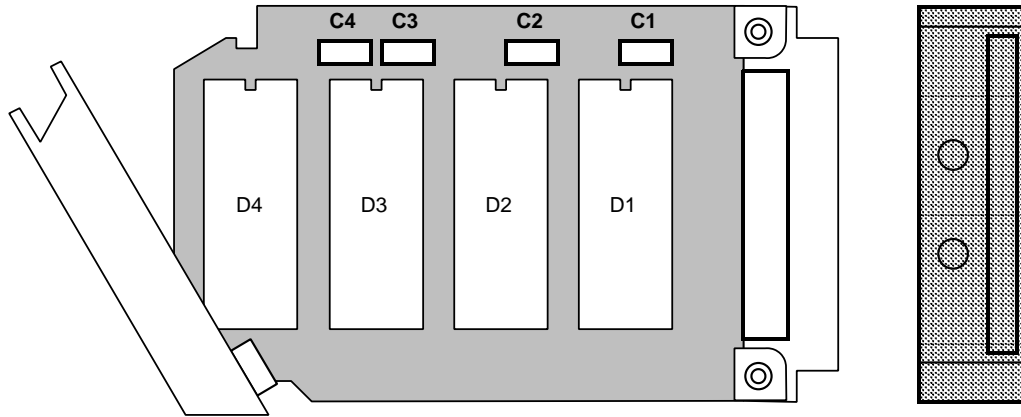

Total current	+5 V	+15 V	-15 V	V _{CC}
6FC5 154-0AX01-0AE0	0.04 A	—	—	—
6FC5 154-0AX02-0AE0	0.08 A	—	—	—

2.3.5.7 CP 315 – ACTIVE V.24 module

6FC5 112-0EA02-0AA0

The ACTIVE V.24 module is used to establish a point-to-point link between the NC control and computers, terminals, reading stations for tool and pallet data and also printers. Function block packages 4, 5, 7 and 8 are available for the links.

Function blocks:

- Plug-in system software submodule
- 1 LED (error indication)
- 2 serial interfaces RS 232 C (TTY/V.24 interface)
- DUAL PORT RAM, 64 Kbytes (buffered)
- Address routing by software
- Can be expanded by 3 serial RS 232 C (TTY/V.24) interfaces with submodule CP 373

Location of interfaces, the operator control and display elements

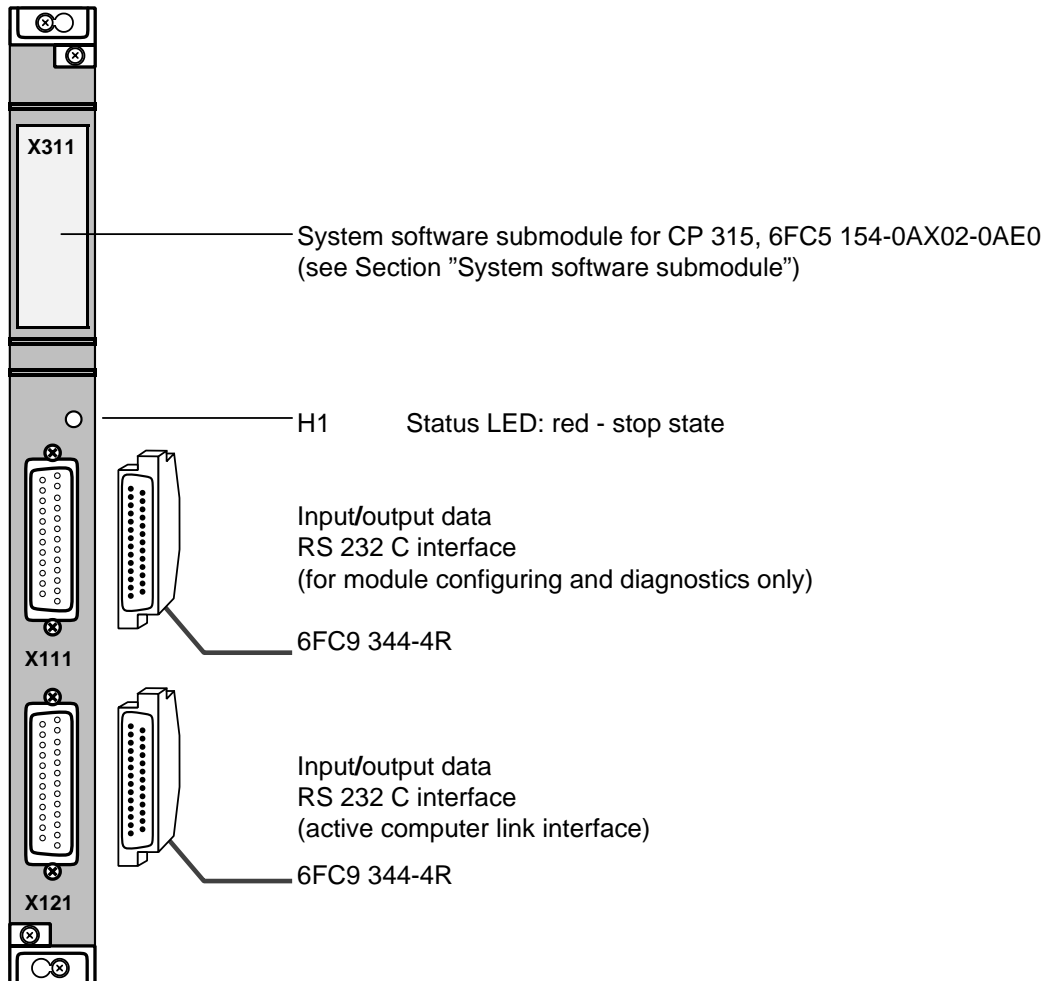

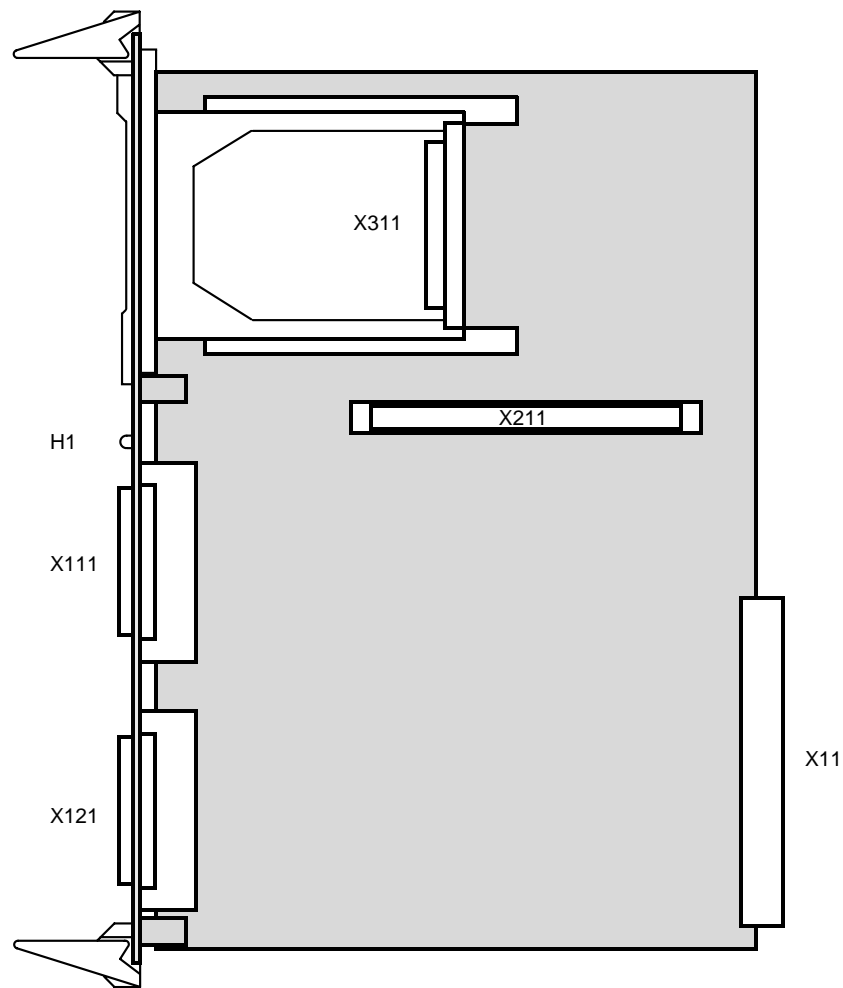

X211 – Plug-in submodule interface for submodule CP 373

X11 – Bus interface

Total current	+5 V	+15 V	-15 V	V _{CC}
Typical	1.8 A	0.08 A	0.02 A	30 μA
X111/X121	1.1 A	—	—	—

2.3.5.8 CP 315/CP 373 – ACTIVE V.24 module with submodule 6FC5 112-0EA03-0AA0

As for CP 315 – ACTIVE V.24 module, in this case, however, additionally with submodule CP 373.

Function blocks:

- 3 additional serial interfaces RS232C as a TTY/V.24 interface

Location of interfaces and the operator control and display elements

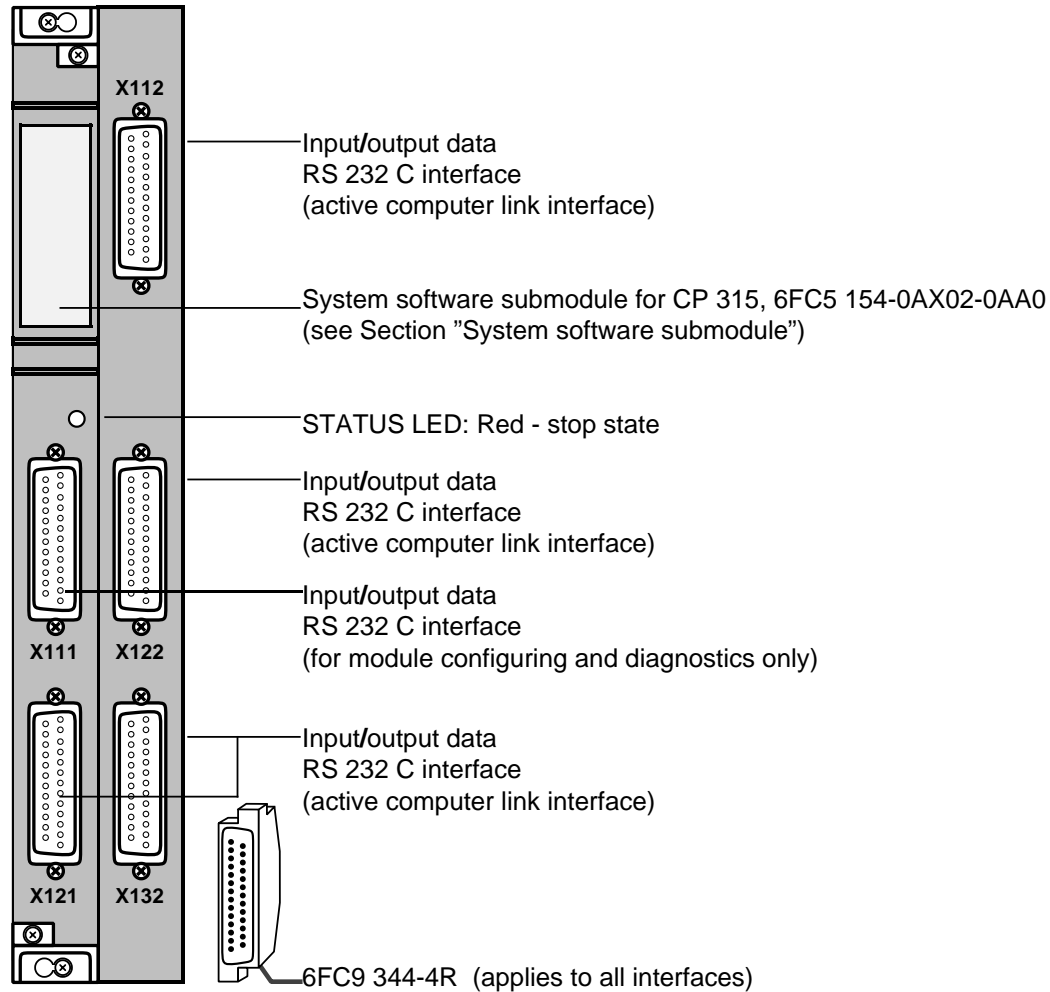

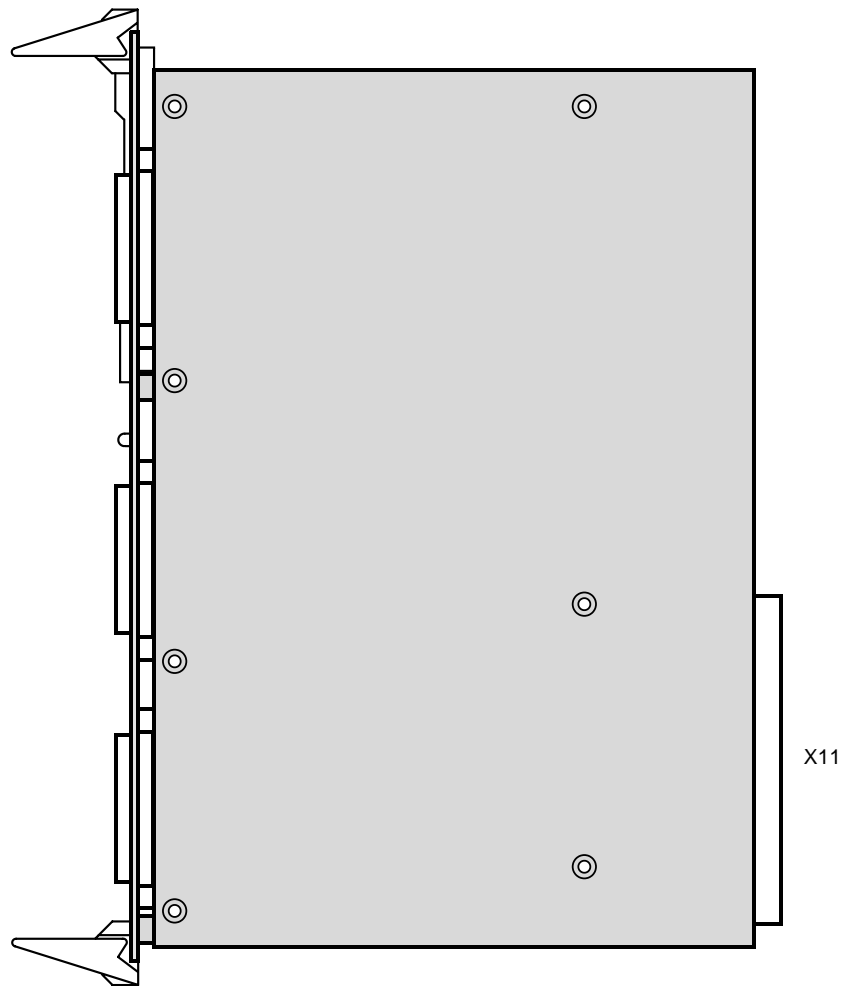

X11 – Bus interface

Total current	+5 V	+15 V	-15 V	V _{CC}
Typical	2.2 A	0.2 A	0.06 A	—
X111, X121, X112, X122, X132	1.6 A	—	—	—

2.3.5.9 SINEC CP 1476 (MAP 3.0)

6GK1 147-6MA01

A detailed description of this module is given in documentation

SINUMERIK 840C/880
Computer Link with SINEC CP 1476 MAP

2.3.5.10 MMC interface

6FC5 112-0DA01-0AA

The MMC interface module serves as an expansion for the MMC CPU. It offers additional interfaces for data backup, archiving and computer link.

Function blocks:

- 2 x 9-pin RS 232 interfaces
- Interface for connecting diskette drive FD-E2 only

Location of interfaces

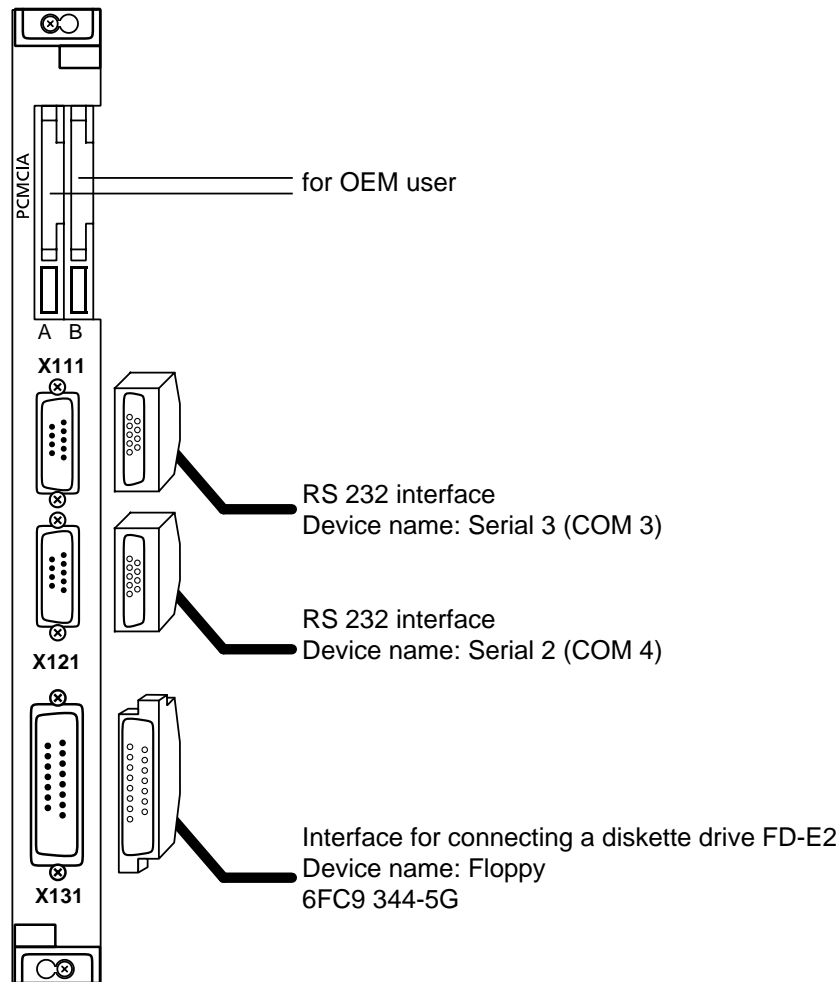

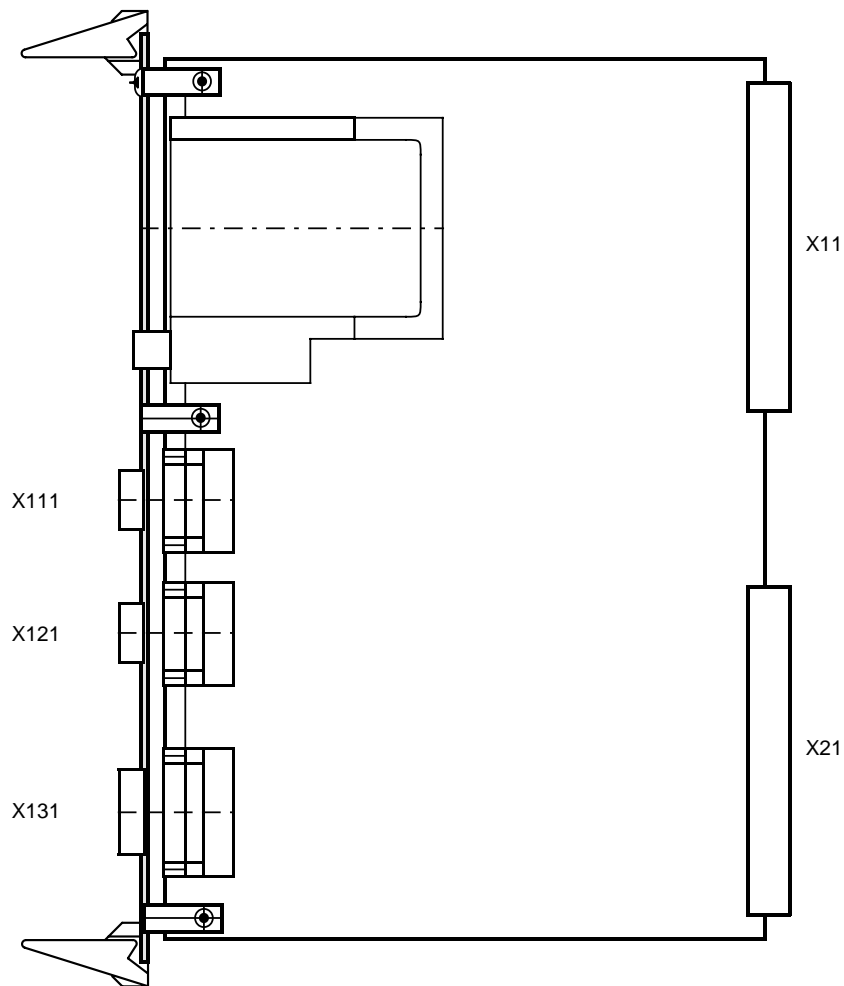

X11 - Bus interface

X 21 - AT96 bus interface

Note:

If the MMC interface is retrofitted, serial interfaces 2 and 3 are automatically recognized by the MMC-CPU after the interface MMC has been slotted in. There are two possible ways of retrofitting the interface MMC with a FD-E2 floppy drive:

- Pull out the MMC-CPU when the control is switched off. Then slot in the interface MMC and the MMC CPU. Floppy is automatically entered in the setup when booting. The PLC MDs must then be reloaded from the hard disk.
- After the interface MMC has been slotted in, call up the BIOS setup menu with key combination CTRL-ALT-ESC (on PC keyboard on the MMC) when you next boot and select 1.44 MB 3.5" for drive A with the "+" key. Store the BIOS setup menu and exit. The boot procedure is continued.

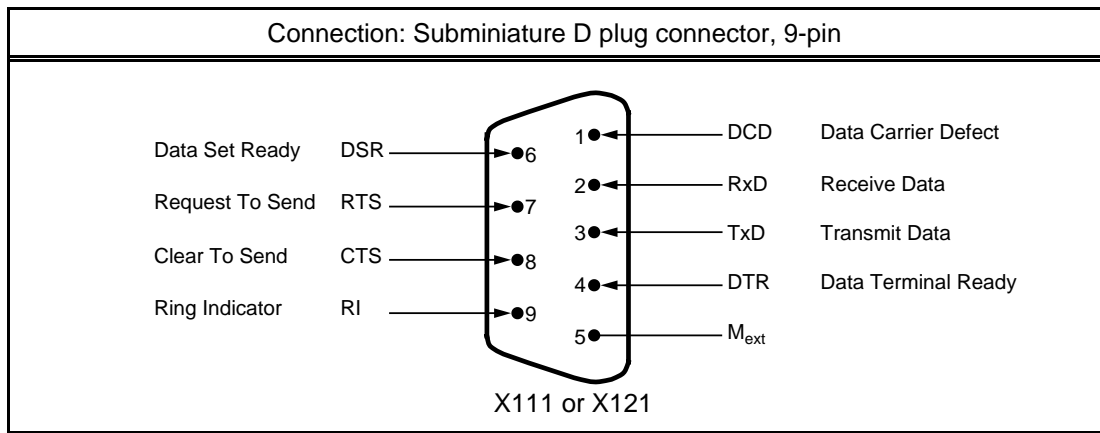

Total current	+5 V	+15 V	-15 V	V _{CC}
Typical	1.0 A	0.15 A	—	—

Setting S1, DIP switch

(from order no.: 6FC5112-0DA01-0AA1)

The following settings (Flexos version) are provided as standard ex works:

1	2	3	4	5	6	7	8
OFF	OFF	OFF	OFF	ON	OFF	OFF	OFF

The following settings must be made by the user with the DIP switch for Windows:

1	2	3	4	5	6	7	8
OFF	OFF	OFF	ON	OFF	OFF	ON	OFF

The settings of the interrupt no. and the I/O address are made under the Windows for Workgroups operating system using the "Control panel" in the menus "Ports" and "Advanced".

	I/O address (Hex)	Interrupt no. (IRQ)
COM 3 (serial 3)	03E8	5
COM 4 (serial 2)	02E8	9

After the settings have been made the Windows control must be started up again.

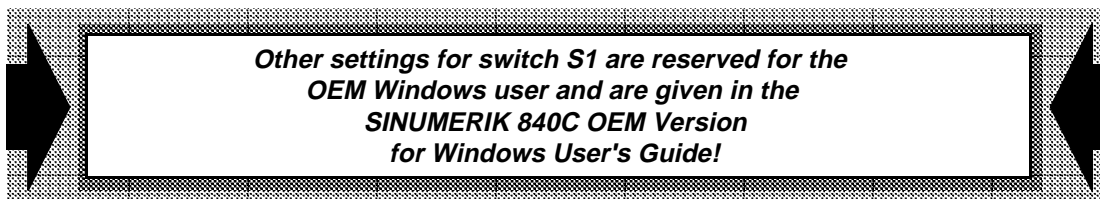

2.3.6 Monitoring module and power supply

2.3.6.1 CENTRAL SERVICE BOARD (old CSB)

6FC5 114-0AA02-0AA0

The mains voltage, battery and fan monitoring circuits, the handwheel and measuring pulse inputs and the NC Ready output are located on the module. The CSB must be installed in location A4 of the 12/18 SPS subrack.

Functional blocks:

- Mains voltage monitoring
- Battery monitoring
- Temperature/fan monitoring
- NC READY generation
- Power supply for fan
- Transfer circuit for buffered SRAMs in case of power failure
- Reset generation
- 2 handwheel inputs
- 2 measuring pulse inputs (floating, generating an interrupt), optionally available as interrupt-generating NC inputs
- 6 NC inputs, floating, not generating any interrupts

Location of interfaces, the operator control and display elements

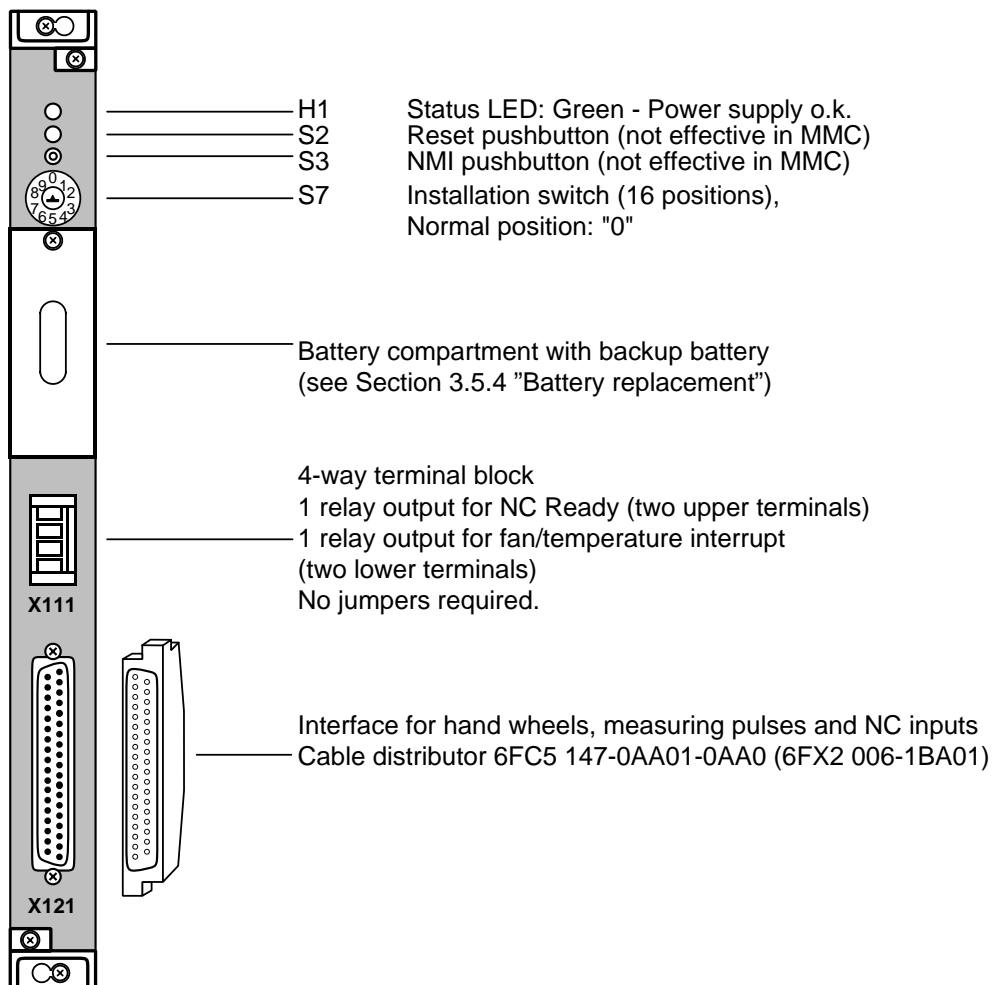

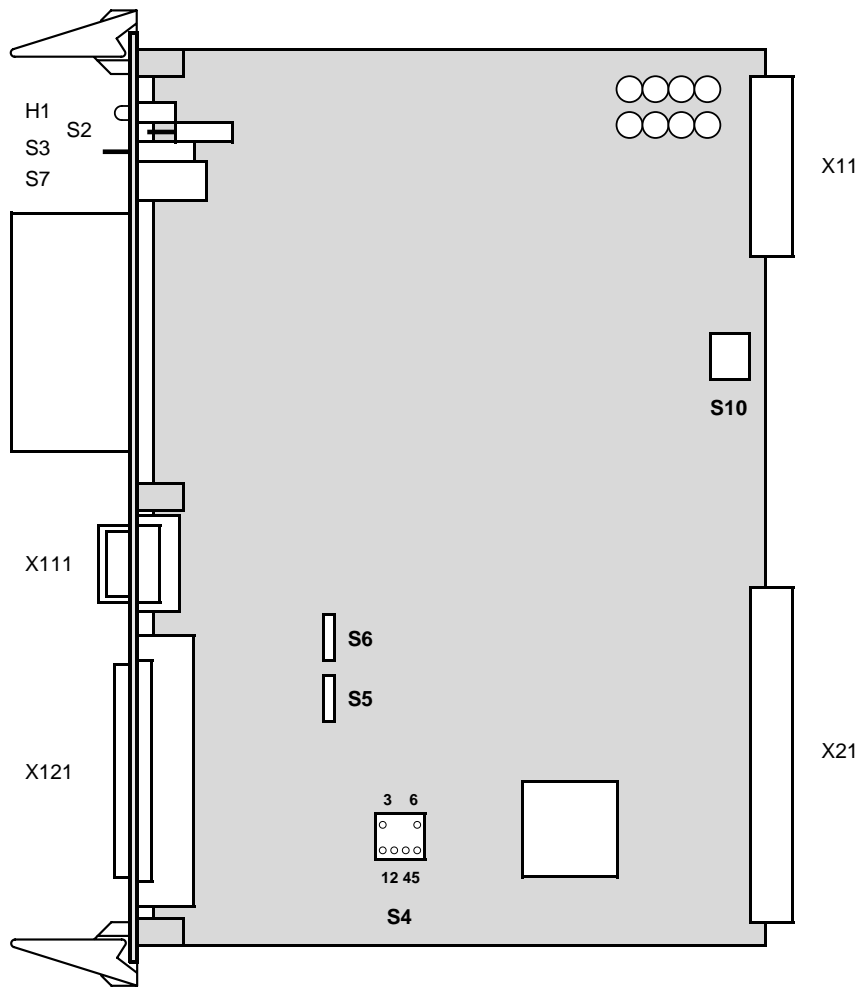

- S4 – Measuring pulse logic (Jumperings see Table Hardware jumperings)
- S5, S6 – Handwheel interface (Jumperings see Table Hardware jumperings)
- S10 – Fan monitoring (Jumperings see Table Hardware jumperings)
- X11 – CSB interface
- X21 – Bus interface

Total current	+5 V	+15 V	-15 V	V _{CC}
Typical	0.4 A	0.05 A	—	10 μA
Fan unit	—	see Section "Fan unit"	—	—

Interface for NC READY and temperature/fan relay output

Connector designation: **X111**
 Connector type: Terminal block

1	NC-READY Common	Output
2	NC-READY Signal	Output
3	Temperature/Fan Common	Output
4	Temperature/Fan Signal	Output

Technical data:

$U_{\max} = 48 \text{ V DC}$ $I_{\max} = 1 \text{ A DC}$ $N_{\max} = 30 \text{ VA}$	$U_{\min} = 5 \text{ V DC}$ $I_{\min} = 50 \text{ mA DC}$	NC READY
$U_{\max} = 48 \text{ V DC}$ $I_{\max} = 0.5 \text{ A DC}$ $N_{\max} = 12 \text{ V A}$	$U_{\min} = 5 \text{ V DC}$ $I_{\min} = 3 \text{ mA}$	Temperature monitoring

Contact states:

- NC Ready:

On:	
Off:	

Picking up of the relay:

After NCK power up, if the following conditions have been fulfilled:

- PLC synchronized
- NCK power up completed (VIL start-up completed)
- All drives ready
- Moreover, the OUTDS bus signal must be active.

NC ready is released (contact state "off") when a PLC or NC failure occurs or one of the following alarms is issued:

4, 5, 6, 7, 8, 11, 43, 48, 57, 60, 70, 71, 72, 73, 74, 75, 77, 78, 79, 80,
 103, 104, 105, 128*, 1064*, 1068*, 2007*, 2032*, 2033*

Note:

NC ready does not closed when alarms 1052*, 2029* "drive fault" are issued.

- Temperature / fan:

Alarm:	
No alarm:	

Interface for handwheels, measuring pulses and NC inputs

You need a cable distributor (see next Section) for connecting handwheels, measuring pulses and NC inputs to the CSB.

Note:

The input delay time for measuring pulses and NC inputs is max. 10 μs for the rising edge and max. 100 μs for the falling edge.

Hardware jumperings

Designation	Switching position	Meaning																				
S6		Handwheel 1 with output signals referred to 0 V; open circuit monitoring passive																				
S6		Handwheel 1 with error signals; open circuit monitoring active																				
S5		Handwheel 2 with output signals referred to 0 V; open circuit monitoring passive																				
S5		Handwheel 2 with error signals; open circuit monitoring active																				
S4		Sensor 1 active for 24 V input signal or high-active open-collector-transistor																				
S4		Sensor 1 active for 0 input signal or low-active open-collector-transistor																				
S4		Sensor 2 active for 24 V input signal or high-active open-collector-transistor																				
S4		Sensor 2 active for 0 V input signal or low-active open-collector transistor																				
S10		<table border="0"> <tr> <td>Monitoring</td> <td>OFF</td> </tr> <tr> <td>Fan 1</td> <td>ON</td> </tr> <tr> <td>Monitoring</td> <td>OFF</td> </tr> <tr> <td>Fan 2</td> <td>ON</td> </tr> <tr> <td>Monitoring</td> <td>OFF</td> </tr> <tr> <td>Fan 3</td> <td>ON</td> </tr> <tr> <td colspan="2">only on subracks with 18 SPS</td> </tr> <tr> <td>Monitoring</td> <td>OFF</td> </tr> <tr> <td>Fan 4</td> <td>ON</td> </tr> <tr> <td colspan="2">(only on subracks 18 + 3 SPS)</td> </tr> </table>	Monitoring	OFF	Fan 1	ON	Monitoring	OFF	Fan 2	ON	Monitoring	OFF	Fan 3	ON	only on subracks with 18 SPS		Monitoring	OFF	Fan 4	ON	(only on subracks 18 + 3 SPS)	
Monitoring	OFF																					
Fan 1	ON																					
Monitoring	OFF																					
Fan 2	ON																					
Monitoring	OFF																					
Fan 3	ON																					
only on subracks with 18 SPS																						
Monitoring	OFF																					
Fan 4	ON																					
(only on subracks 18 + 3 SPS)																						

Operator control and display elements

Designation	TYPE	Meaning
S2	Pushbutton	Manual tripping of a HW reset and Switch ON/OFF routine
S3	Pushbutton	Manual tripping of an NMI request
H1	LED	Lights up if +5 V and ± 15 V are within the tolerance range.
S7	Rotary selector switch	Scanning of hexadecimal code through software during installation

Battery monitoring

Battery monitoring is used to ensure continuous data backup.

The battery monitoring circuit consists of

- a transfer circuit that switches over to battery mode (9 V block) in case of line voltage failure and
- two limit monitors which monitor the battery voltage level.

There are two monitoring stages:

1st stage = Preliminary warning
 2nd stage = Alarm: DATA LOSS AT POWER OFF

When the preliminary warning responds, a monitoring signal is triggered and an alarm message issued. The work process is not interrupted since data security is still ensured.

On initiation of the DATA LOSS AT POWER OFF alarm, a monitoring signal is triggered. Here too, the work process is not interrupted. The period between the responses of the 1st and 2nd stages of battery monitoring is 4 weeks.

Data loss in the buffered RAM submodules can be avoided by means of two-stage monitoring. After elimination of the error cause, the error indication at the operator panel can be cancelled by means of the acknowledgement key.

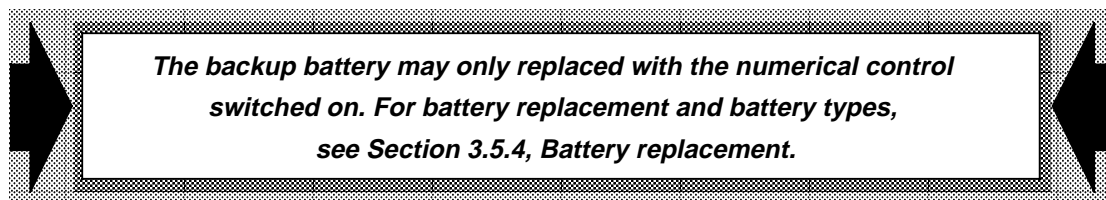

Mains voltage monitoring

Mains voltage monitoring is intended for preventing malfunctions of the control due to primary or secondary overvoltages or undervoltages.

Fan/temperature monitoring

To avoid malfunctions of the controls caused by inadmissible ambient temperatures, the air intake temperature and the fan functions of the CSB are monitored.

The air intake temperature is monitored in two stages:

1. If an air intake temperature of 55 °C is reached, a monitoring signal is triggered and an alarm message issued. The monitoring signal has no effect on the module functions.
2. If the ambient temperature exceeds 60 °C, another monitoring signal is triggered and an error message is output to warn of overheating. The monitoring message has no effect on the module functions. However, a relay contact which enables the customer to take suitable measures is supplied with the module.

The integrated fans are speed-controlled. In the event of a failure, a monitoring signal is triggered and an error message is output. Monitoring has no effect on the module functions.

The FAN/TEMPERATURE ALARM relay opens in case of a 2nd stage fan or temperature alarm.

Note:

The control must not be operated for more than 5 minutes if the fan fails!

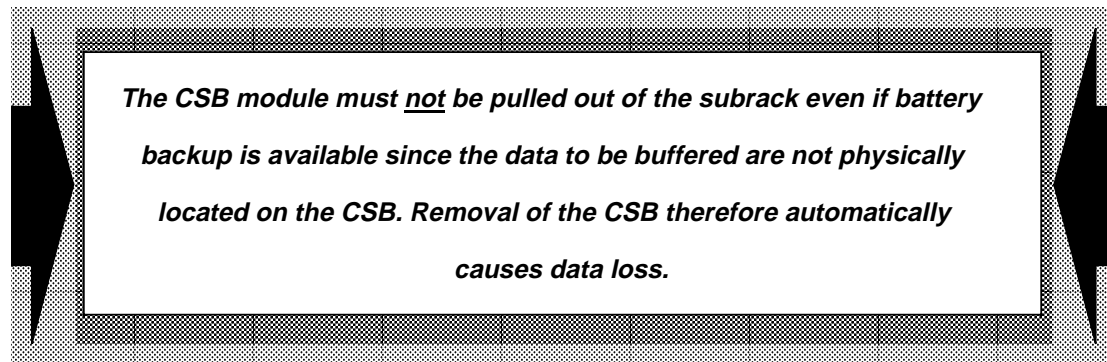

2.3.6.2 CENTRAL SERVICE BOARD (new CSB)

6FC5 114-0AA02-0AA (as from Version C)
6FC5 114-0AA02-0AA (UPS)

The mains voltage, battery and fan monitoring, handwheel and measuring pulse inputs and the NC READY input are located on the module. The CSB must be installed in location A4 of the 12/18 SPS subrack.

Function blocks:

- Mains voltage monitoring
- Battery monitoring
- Temperature/fan monitoring
- NC READY generation
- Power supply for fan
- Transfer circuit for buffered SRAMS in case of power failure
- Reset generation
- 2 handwheel inputs
- 2 measuring pulse inputs (floating, generate an interrupt), can also be used as interrupt generating NC inputs
- 6 NC inputs, floating, not generating any interrupts
- Input and output for uninterruptible power supply (as from version **6FC5114-0AA02-0AA2** with cable distribution cabinet 6FX2006-1BA01 only) (as from SW 6.3)

Location of interfaces, operator control and display elements

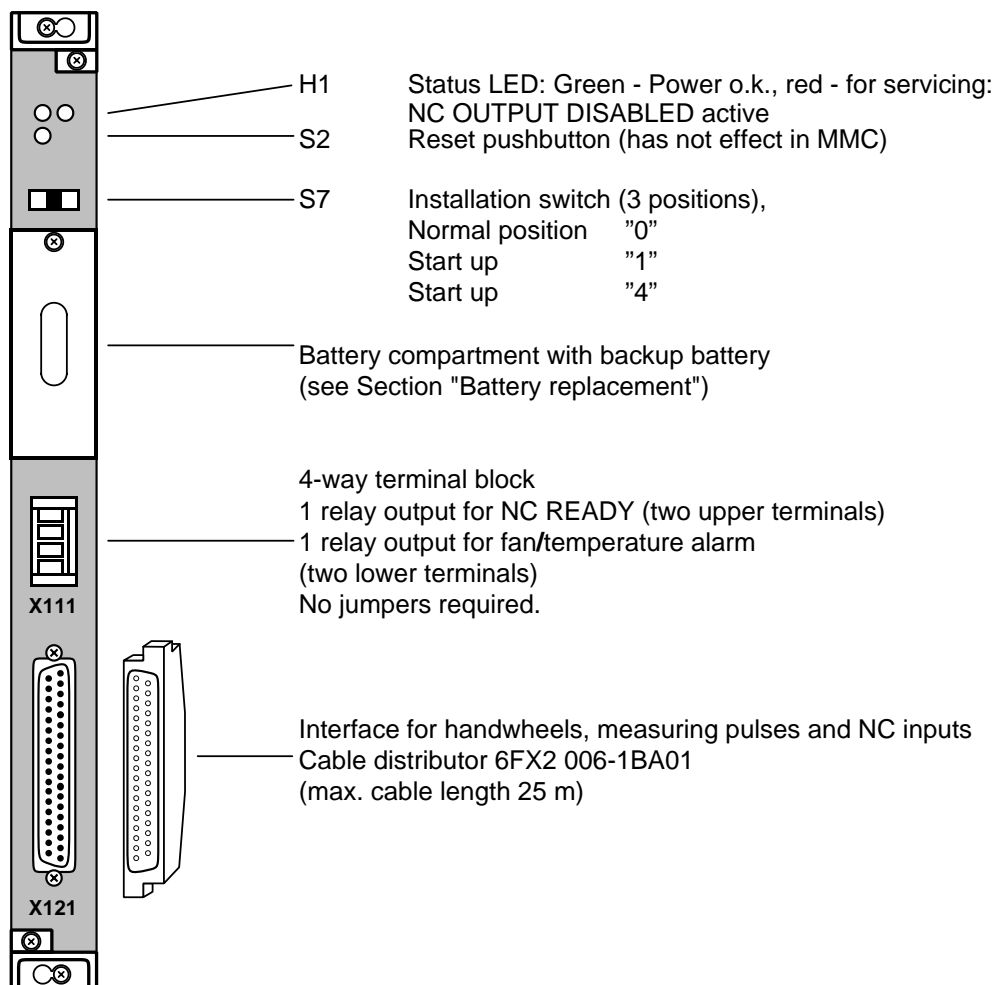

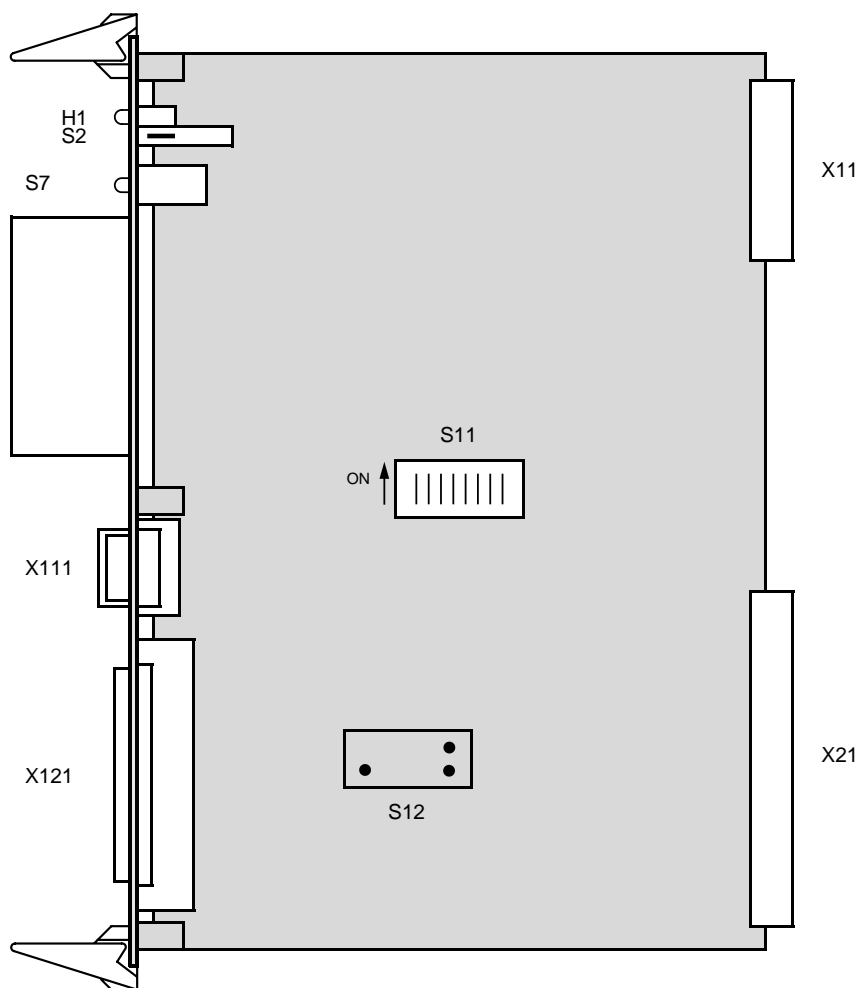

- 1, 2 – Measuring pulse logic (Jumperings see Table Hardware jumperings)
- 3, 4, 5, 6 – Fan monitoring (Jumperings see Table Hardware jumperings)
- 7, 8 – Handwheel interface (Jumperings see Table Hardware jumperings)
- X11 – CSB interface
- X21 – Bus interface

Total current	+5 V	+15 V	-15 V	V _{CC}
Typical	0.4 A	0.02 A	1 mA	10 μA
Fan unit	—	see Section "Fan unit"	—	—

Interface for NC READY and temperature/fan relay output

Connector designation: **X111**
 Connector type: Terminal block

1	NC-READY Common	Output
2	NC-READY Signal	Output
3	Temperature/Fan Common	Output
4	Temperature/Fan Signal	Output

Technical data

$U_{\max} = 48 \text{ V DC}$ $I_{\max} = 1 \text{ A DC}$ $N_{\max} = 30 \text{ VA}$	$U_{\min} = 5 \text{ V DC}$ $I_{\min} = 50 \text{ mA DC}$	NC READY
$U_{\max} = 48 \text{ V DC}$ $I_{\max} = 0.5 \text{ A DC}$ $N_{\max} = 12 \text{ VA}$	$U_{\min} = 5 \text{ V DC}$ $I_{\min} = 3 \text{ mA}$	Temperature monitoring

Contact states:

- NC Ready: On: 
- Off: 

Picking up of the relay:

After NCK power up, if the following conditions have been fulfilled:

- PLC synchronized
- NCK power up completed (VIL start-up completed)
- All drives ready
- Moreover, the OUTDS bus signal must be active.

NC ready is released (contact state "off") when a PLC or NC failure occurs or one of the following alarms is issued:

4, 5, 6, 7, 8, 11, 43, 48, 57, 60, 70, 71, 72, 73, 74, 75, 77, 78, 79, 80,
 103, 104, 105, 128*, 1064*, 1068*, 2007*, 2032*, 2033*

Note:

NC ready does not close when alarms 1052*, 2029* "drive fault" are issued.

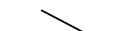
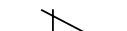
- Temperature / fan: Alarm: 
- No alarm: 

Interface for handwheels, measuring pulses and NC inputs X121

You need a cable distributor (see next Section) for connecting handwheels, measuring pulses and NC inputs to the CSB.

Note:

The input delay time for measuring pulses and NC inputs is max. 10 μs for the rising edge and max. 100 μs for the falling edge.

Hardware jumpering for switch S11

	1	2	3	4	5	6	7	8
OFF	Sensor 1 active on 24 V input signal or high active open collector transistor	Sensor 2 active on 24 V input signal or high active open collector transistor	Monitoring Fan 1 ON	Monitoring Fan 2 ON	Monitoring Fan 3 ON (only on subrack with 18 SPS)	Monitoring Fan 4 ON (only on subrack with 18 + 3 SPS)F	Handwheel 1 with output signals with reference to 0 V; open-circuit monitoring passive	Handwheel 2 with output signals with reference to 0 V; open-circuit monitoring passive
ON	Sensor 1 active on 0 V input signal or low active open collector transistor	Sensor 2 active on 0 V input signal or low active open collector transistor	Monitoring Fan 1 OFF	Monitoring Fan 2 OFF	Monitoring Fan 3 OFF (only on subrack with 18 SPS)	Monitoring Fan 4 OFF (only on subrack with 18 + 3 SPS)	Handwheel 1 with differential signals; open-circuit monitoring active	Handwheel 2 with differential signals; open-circuit monitoring active

Changeover switch S12

Position Function of the UPS output

- Open Floating contact assembly (make contact) between X121, PIN 6 and X121, PIN 5
- Position 1 High active, relay switches +5 V to X121, PIN 6 (cable distributor X7, 4) X121, PIN 5 (cable distributor X7, 2) is at +5 V
- Position 2 Low active, relay switches 0 V to X121, PIN 6 (cable distributor X7, 4) X121, PIN 5 (cable distributor X7, 2) is at 0 V.

Operator control and display elements

Designation	Type	Bedeutung	
S2	Pushbutton	Manual tripping of a hardware reset and switch on/off routine	
H1	LED	green	Lights up when +5 V and ± 15 V are within the tolerance range
		red	Lights up when NC OUPUT DISABLED is active
S7	Step switch	Scanning of hexadecimal code by software during start-up; possible setting are 0, 1, 4	

The information given for the CSB (old) for the monitoring of the

- ***battery***
- ***mains voltage***
- ***fan/temperature***

also apply to the CSB (new).

The following also applies:

The CSB module must not be pulled out of the subrack even if battery backup is available since the data to be buffered are not physically located on the CSB. Removal of the CSB therefore automatically causes data loss.

2.3.6.3 Cable distributor

6FC5 147-0AA01-0AA0
6FX2 006-1BA01

Note:

From 08.94, the cable distributor order No. 6FC5 147-0AA01-0AA0 is replaced by the cable distributor order No. 6FX2 006-1BA01.

The cable distributor splits the X121 interface of the CSB into

- 2 x handwheel interfaces
- 2 x measuring pulse inputs or 2 fast NC input interfaces (uninterruptible power supply as well)
- 6 x fast NC input interfaces (uninterruptible power supply as well)
- 1 x 24 V/M_{ext} interface
- 1 x interface with 6FX2006-1BA01

i.e. into a maximum of 7 single cables. An external 24 V supply and a M_{ext} terminal can be provided at the cable distributor.

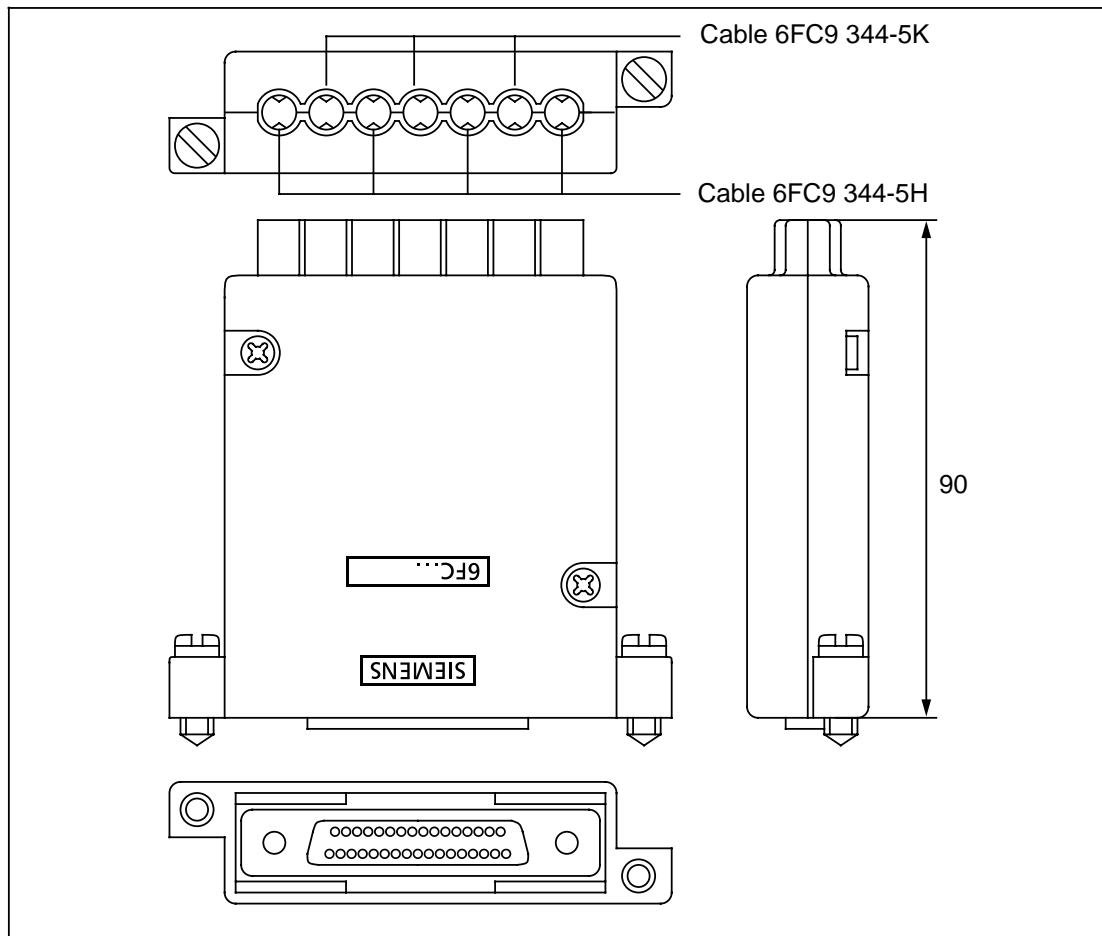

The 37-pin cable distributor consists of a connector casing (SINUMERIK type) for a 37-pin Sub-D connector with enlarged interior. 7 cable inputs are at the rear of the casing. The diameters of the cable entries are matched to the specified cables (see also table "Connection assignment").

Connect the cables to the open cable distributors at connectors X1 to X10 and insert the cable into the cable entries. You must position the isolated cable sheaths on the bent contact surfaces of the contact spring. Place the upper clamp into the lower housing turned towards the lower clamp and then secure the upper housing part. The cable shields are thus pressed between the contact surfaces of the contact springs and contacted. The shield potential is connected via the contact springs of the cable distributor by fixing to the CSB.

Via the S1 to S5 switches (Dip Fix) inside the cable distributor, the P24 and M_{ext} potentials are connected to the measuring pulse common input (0 V) inputs and the measuring pulse signal as long as P24 V/M_{ext} is supplied via X10.

Position of interface, operating and display elements

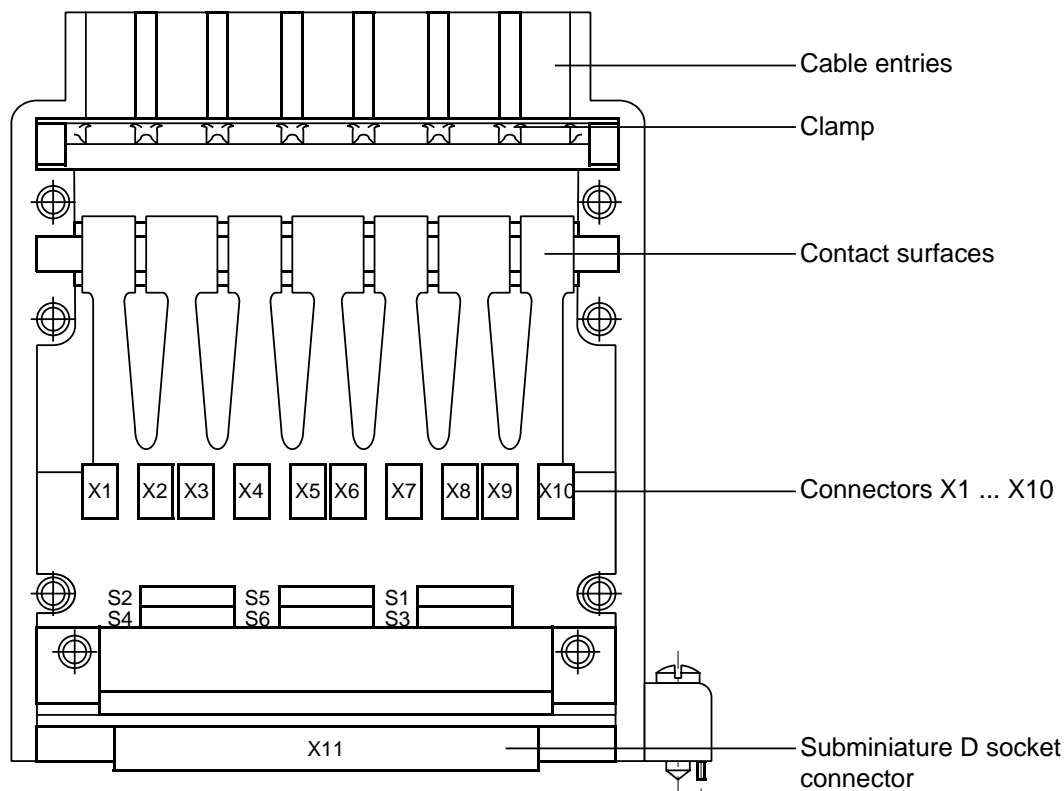

Notes:

- The S6 switch is provided only on the cable distributor order No. 6FX2 006-1BA01 from 08.94.
- The S5 and S6 switches must not be closed when used with the SINUMERIK 840C.

Connector coding



Connector assignment

Connector No.	Cable No.	I/O devices
X1	1 (bottom)	2nd sensor, rapid input 1, uninterruptible power supply input
X2	2	6 rapid inputs or uninterruptible power supply inputs
X3		
X4	3	1st sensor, rapid input 0, uninterruptible power supply input
X5	4	2nd handwheel
X6		
X7		uninterruptible power supply inputs/outputs
X8	5	1st handwheel
X9		
X10	6 (top)	24V DC power supply

Note:

When assembling the cable distributor, make sure that the insulator shed supplied with the cable distributor is mounted properly and the coding pins are installed.

Table of states of switches S1 to S6

Switch	Position	Signal	Switched potential	Contact pin
S1	1	MEPUS 0	P 24 V	X 4.1
	0	MEPUS 0	open	X 4.1
S2	1	MEPUS 1	P 24 V	X 1.1
	0	MEPUS 1	open	X 1.1
S3	1	MEPUC 0	GND _{ext}	X 4.3
	0	MEPUC 0	open	X 4.3
S4	1	MEPUC 1	GND _{ext}	X 1.3
	0	MEPUC 1	open	X 1.3
S5	0		must be open	X 10.3
S6 *)	0		must be open	X 10.1

*) The S6 switch is provided only on the cable distributor order No. 6FX2 006-1BA01 from 08.94.

The following definitions of the CSB inputs are possible:

Function	determined by	Is an input (I) available for the function?							
		I7	I6	I5	I4	I3	I2	I1	I0
Axis-specific deletion of distance-to-go	@736	yes	yes	no	no	no	no	no	no
Extended stopping and retraction	MD 922*	yes	yes	yes	yes	yes	yes	yes	yes
Safety Integrated	MD 45800	yes	yes	yes	yes	yes	yes	yes	yes
Measuring	@720/G720	no	no	no	no	no	no	yes	yes
UPS "power failure"	MD 5030	yes	yes	yes	yes	yes	yes	yes	yes

Inputs shown schematically, input current 3 ... 10 mA

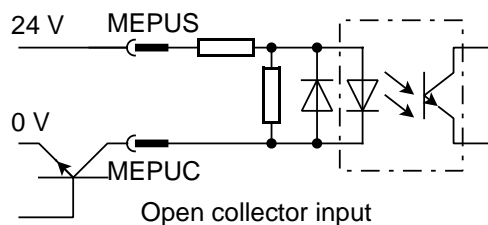
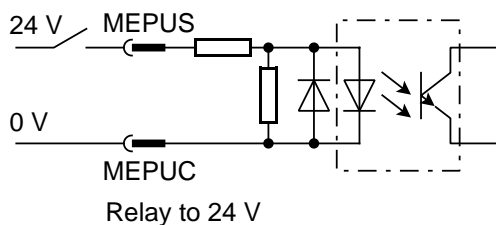

MEPUS ... Measuring pulse signal
 MEPUC ... Measuring pulse common

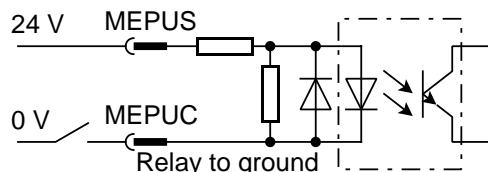

Circuit diagram of S1 ... S4 for connecting sensors and rapid NC inputs

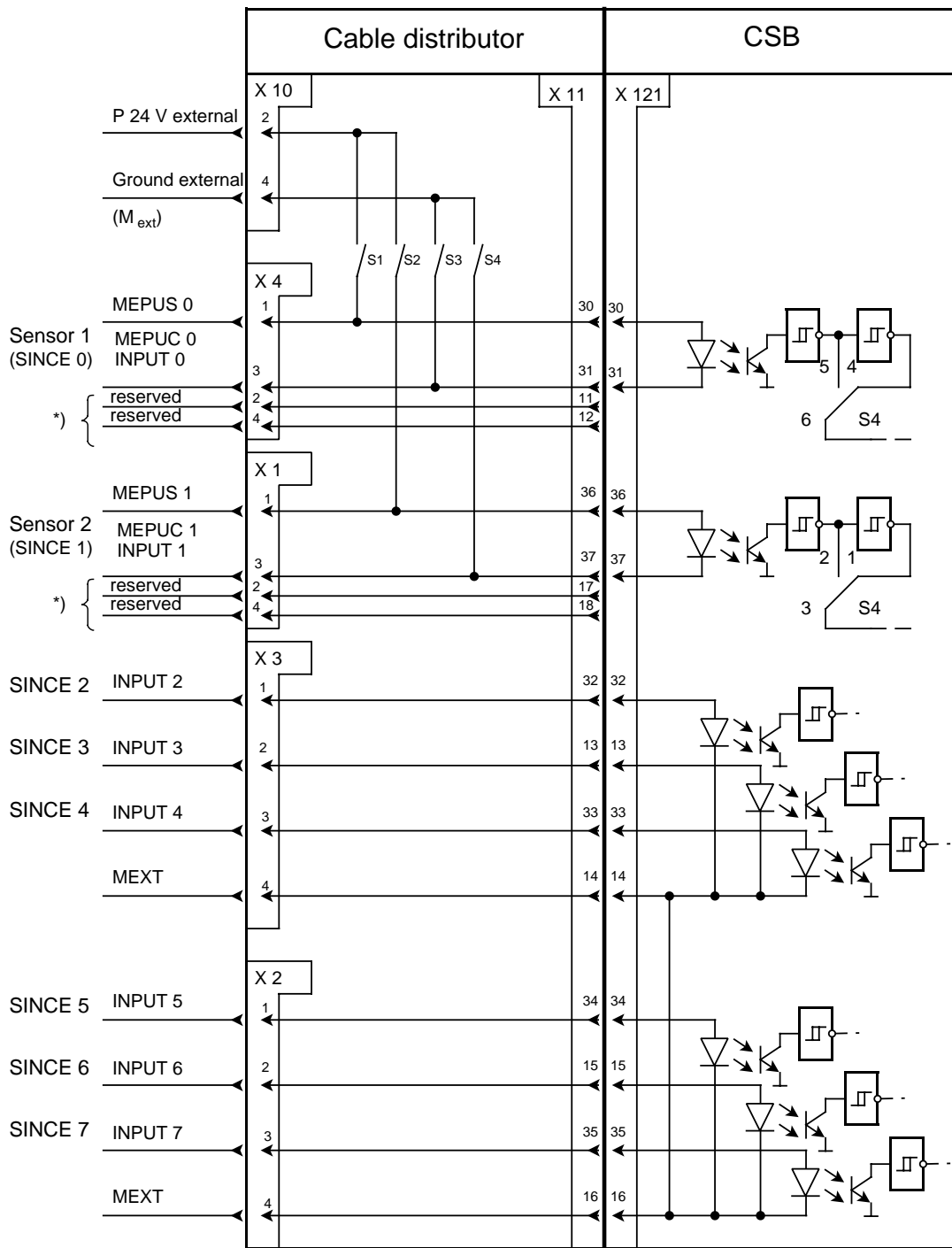

SINCE Rapid NC input

see next page

Connector assignment

Connector designation: **X1 ... X10**
Connector type: DU BOX plug connectors

*) Applies from 08.94 for cable distributor order No. 6FX2 006-1BA01

Input/output UPS (only Order no. 6FC5114-0AA02-0AA2) (as from SW 6.3)

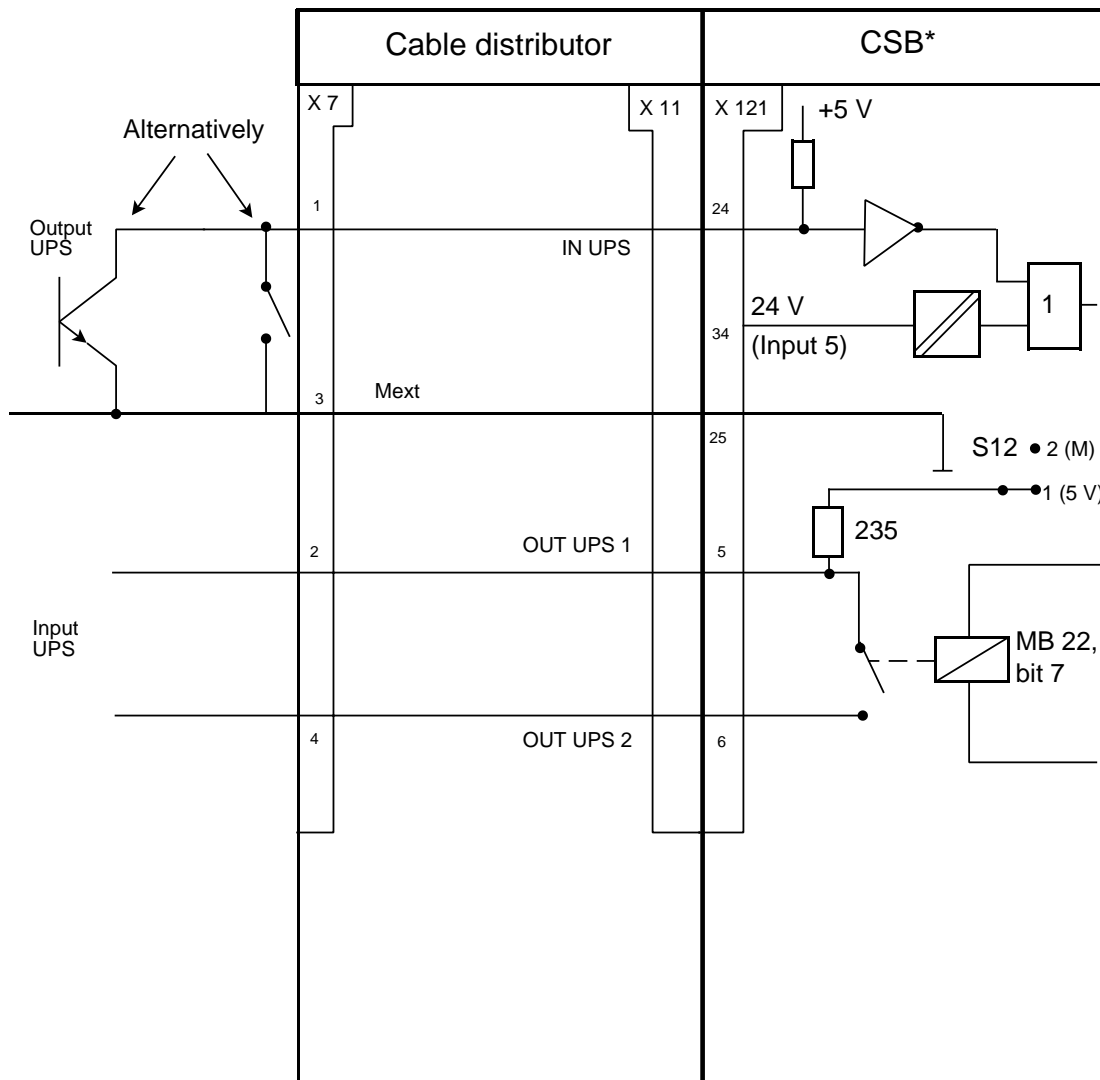

With the changeover switch S12 the function of the UPS output can be set: floating make contact (S12 open), high (S12 in position 1 as in the example) or low active (S12 in position 2).

The output is activated by setting bit 7 in MB 22.

- Selection by contact assembly or open collector output (low active) or with 24 V level at input 5 (high active). UPS and INPUT 5 can be used alternatively.
- Activating the UPS input will cause a message in the PLC in MB 22, bit 6.
- Electrical data X121, 24:
 Operating points $L_s < 2.0 \text{ V}$ $H > 3.0 \text{ V}$
 Max. input voltage: 30 V
 Input current at 0 V: -4 mA
 Input delay time 160 ms

*) Possible as from CSB 6FC5114-0AA02

Pin of X121	Signal name	DU BOX con-connector No./pin	Cable No.	Cable Order No.	Core color	I/O device	Clamp
1	MPG0 5V	X 9/2	5	6FX2 002-4AA21-(6FC9 344-5K)	rd	1st handwheel 6FC9 320-5DB	5 V
20	MPG0 0V	X 9/1	5		og		0 V
2	MPG0 *B	X 9/4	5		bn		*B
21	MPG0 B	X 9/3	5		bk		B
3	MPG0 *A	X 8/2	5		gn		*A
22	MPG0 A	X 8/1	5		ye		A
4	MPG0 5V	X 8/4	5		vt		5 V
23	MPG0 0V	X 8/3	5	bu Shield	0 V		
7	MPG1 5V	X 6/2	4	6FX2 002-4AA21-(6FC9 344-5K	rd	2nd handwheel 6FC9 320-5DB	5 V
26	MPG1 0V	X 6/1	4		og		0 V
8	MPG1 *B	X 6/4	4		bn		*B
27	MPG1 B	X 6/3	4		bk		B
9	MPG1 *A	X 5/2	4		gn		*A
28	MPG1 A	X 5/1	4		ye		A
10	MPG1 5V	X 5/4	4		vt		5 V
29	MPG1 0V	X 5/3	4	bu Shield	0 V		
11	Reserved	X 4/2	3	6FC9 344-5H	rd	1st sensor	-
30	MEPUS 0	X 4/1	3		og		Signal
12	Reserved	X 4/4	3		bn		-
31	MEPUC 0	X 4/3	3		bk Shield		Ref. signal
13	INPUT 3	X 3/2	2	6FX2 002-4AA21-(6FC9 344-5K	rd	6 rapid NC inputs	3rd input 2nd input Ground 4th input 6th input 5th input Ground 7th input
32	INPUT 2	X 3/1	2		og		
14	MEXT	X 3/4	2		bn		
33	INPUT 4	X 3/3	2		bk		
15	INPUT 6	X 2/2	2		gn		
34	INPUT 5	X 2/1	2		ye		
16	MEXT	X 2/4	2		vt		
35	INPUT 7	X 2/3	2	bu Shield			
17	Reserved	X 1/2	1	6FC9 344-5H	rd	2nd sensor	-
36	MEPUS 1	X 1/1	1		og		Signal
18	Reserved	X 1/4	1		bn		-
37	MEPUC 1	X 1/3	1		bk Shield		Ref. signal
-	P 24 V	X 10/2	6	6FC9 344-5H	rd	24 V _{external} - M _{external} -	-
-	-	X 10/1	6		og		-
-	M _{ext}	X 10/4	6		bn		-
-	-	X 10/3	6		bk Shield		-
5	OUT USV1	X 7/2	7	6FC9 344-5H	rd	UPS	Output Input Output 0 V
24	XIN USV	X 7/1	7		og		
6	OUT USV2	X 7/4	7		bn		
25	M _{ext}	X 7/3	7		bk Shield		

Signal names

MPG 5 V ...	Supply voltage handwheel 5 V
MPG 0 V ...	Supply voltage handwheel 0 V
MPG A,*A ...	Differential handwheel input A
MPG B,*B ...	Differential handwheel input B
MEPUS ...	Sensor signal input
MEPUC ...	Sensor Common input (0 V)
INPUT 2 ... 7	Rapid NC inputs 2 ... 7
P24 ...	External 24 V supply (+)
M _{ext} ...	External 24 V supply (–)
MEXT	External ground for rapid NC inputs
OUT USV1	} Output for UPS
OUT USV2	
IN USV	Input for UPS

2.3.6.4 Power supply of central controller

230V AC/DC: 6FC5 114-0A 01-0AA
24V DC: 6FC5 114-0AA01-1AA0

The power supply must be installed in locations A1 to A3 of the 12/18 SPS subrack.

The power supply has the following characteristics:

Input voltage	230V AC 90 ... 260V 45 ... 65Hz	230V DC 127 ... 367V	24V DC 20 ... 30V
Connected load	300 VA		
Jumpering in case of power failures	200 ms		20 ms

Front view of power supply for

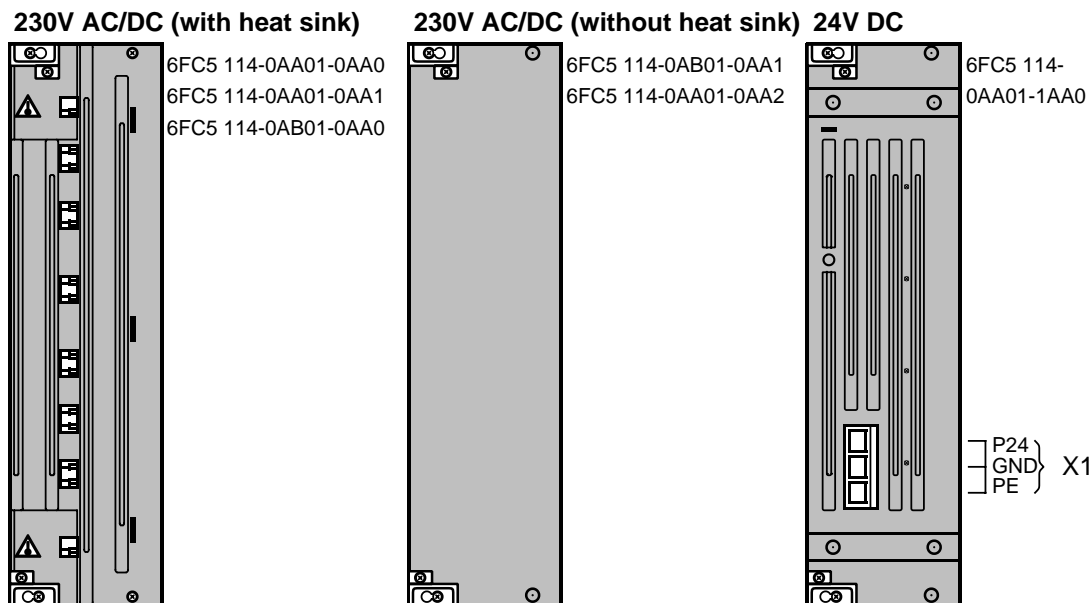

Notes:

- On the 24 V DC version, the protective conductor and the voltage supply on terminal block X1 (interface to power supply unit) must be connected. The power supply modules in the subrack have no effect.

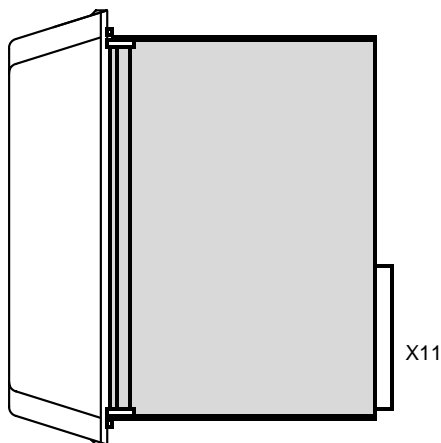

Side view of power supply unit for 230V AC (with heat sink)

X11 – Interface to the power supply

Note:

For installation/removal of the module, loosen/tighten the four M4 cross-recessed-head screws. When inserting the module, note that the casing and not the printed circuit board itself serves as a guide in the subrack.

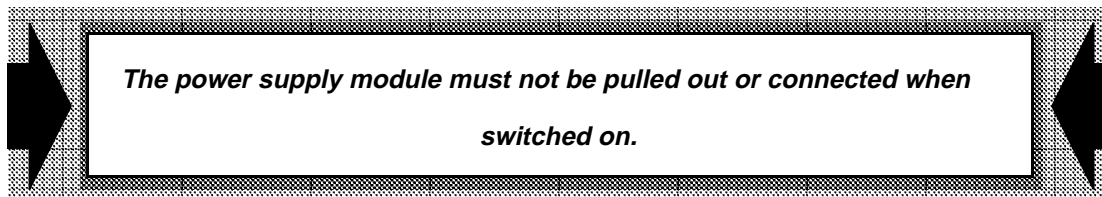
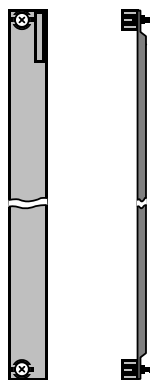
**2.3.7 Blanking plates****6FC5 148-0AA01-0AA0**

Please cover all free slots on the subrack with these blanking plates.

2.3.8 AT rack expansion on central controller 3

The AT rack expansion is only installed on central controller 3. It cannot be ordered as a retrofit set or spare part. It contains 3 slots, each for one standard AT/XT module.

The AT bus used is compatible with the standard ISA bus but with the following limitations:

- The following voltages are available: + 5 V, \pm 12 V.
The voltage of - 5 V is not available.
- Address signals LA17.. 19 are not available but the corresponding pins are assigned with SA17.. 19. This means that AT modules which require address signals LA17.. 19 can still function. This, however, should be checked from case to case.
- The maximum current consumption from \pm 12 V must not exceed a total of 500 mA for all AT slots. The power consumption of all the modules plugged into the subrack (AT and SINUMERIK) must not exceed the maximum load. This is shown in the calculation table (Section 3).

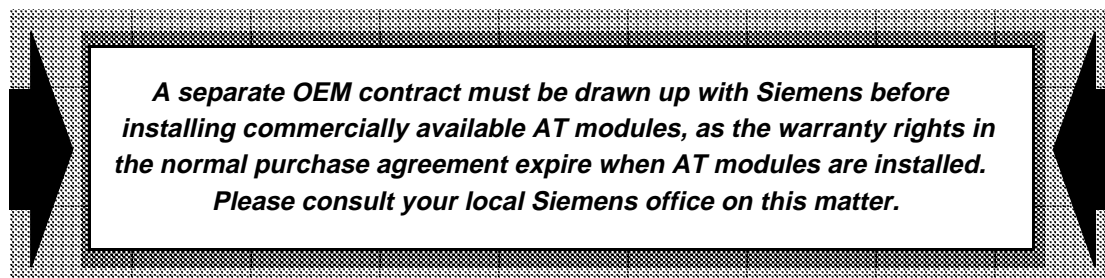

AT module installation:

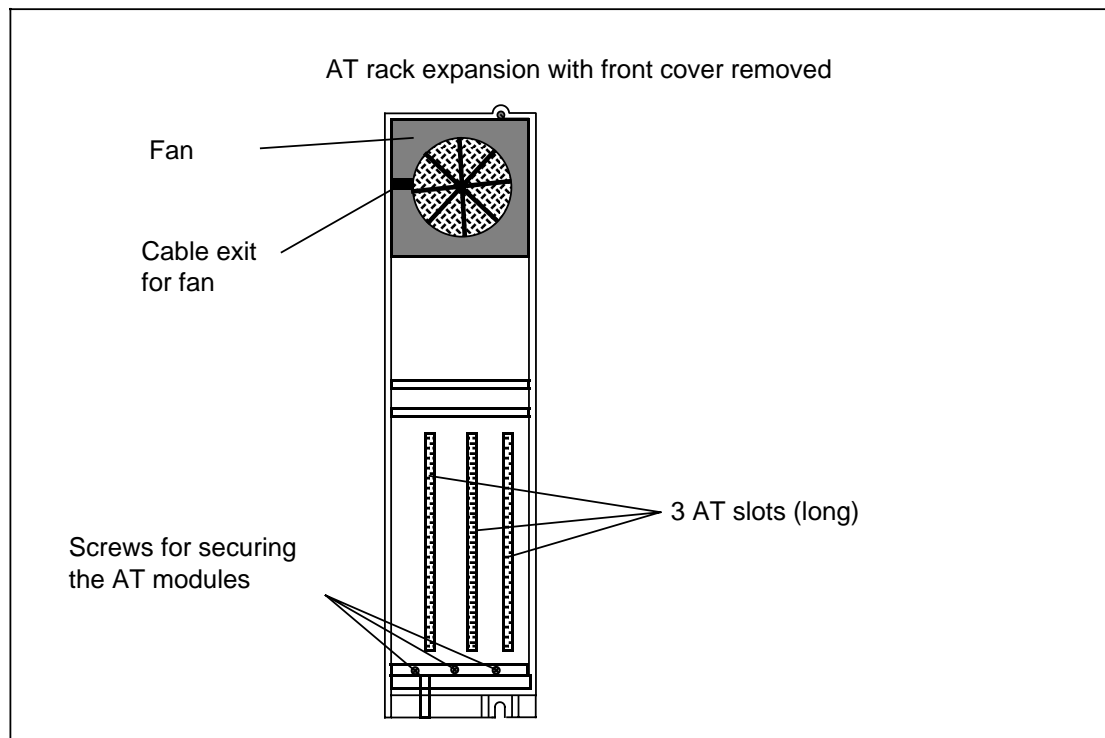

Please note the following points when installing AT modules in the AT rack expansion of subrack 6FC5 101-0AB02-0AA0:

- First remove the front cover of the AT rack expansion. Remove fan only when installing long AT modules.
- Insert modules from the right (for better heat dissipation).
- Short modules should be plugged in from the left and long modules plugged in from the right.
- Remove the plastic protective strip of the slot in question from the bottom of the AT rack expansion (nip out with a diagonal cutting nipper).
- The bracket of the AT module must be screwed tight.
- Installing long AT modules
 - The fan must be removed when installing long AT modules so that the long AT module can be inserted.
 - When returning the fan, please ensure that the fan connector is inserted in the two guide grooves with the coding lugs on the left. The connector must be plugged into the bus board at the back.
 - The fan cable must be placed in the channel and the resulting loop must be pressed away from the fan wheel so that the two do not make contact.
 - The fan must be installed such that the cable leaves the fan towards the left when viewed from the outside.
- Additional securing of AT modules
 - A piece of black, flexible foam is inserted in the AT rack expansion cover. It serves as additional support for the installed AT modules when the cover is snapped back into place.
 - The dimension of this piece of foam has to be adapted to the size of the AT modules (by turning or cutting the piece of foam to size). The recommended overhang of the piece of foam over the front AT module printed circuit board edge is approx. 3 to 6 mm. Please ensure that the foam does not press onto any sensitive components on the AT module.

END OF SECTION

3 Connection Conditions

To ensure that the control functions without interference in the vicinity of the machine tool, the following connection conditions must be complied with.

Please also refer to the descriptions given in the publications listed below:

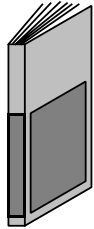

EMC Installation Guidelines for SINUMERIK AND SIROTEC

Order No.: 6FC5 297-0AD30-0BP0

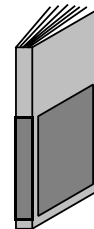

Quality of returned individual components:

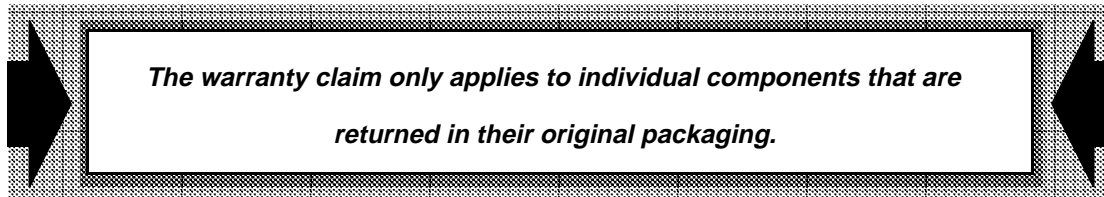

3.1 Technical data

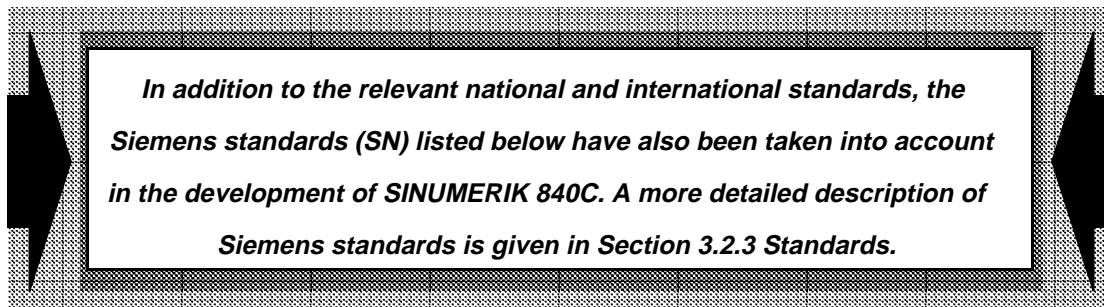

3.1.1 Climatic environmental conditions

General requirements

- The packaging must be selected to suit the climatic conditions likely to be encountered on the shipping route and at the destination.
 - Register of destinations according to SN 69154
 - Climatic overview map with sea routes according to SN 29080
 - Climatic conditions before start-up according to SN 29081
- If the specified limiting values cannot be maintained, a heat exchanger or an air conditioning unit must be provided.

3.1.1.1 Installation and operation

- **Temperature range**
 - Lower limit temperature see table in Section 3.2
 - Upper limit temperature see table in Section 3.2
- **Dew point temperature t_d and relative air humidity U**
 - Annual average U=75 %, $t_d=17$ °C
 - On 30 days (24 hours) per year U=95 %, $t_d=24$ °C
 These days should be distributed naturally over the year.
 - On the remaining days (< 24 hours) U=85 %, $t_d=20$ °C
 observing the annual average

Applies to 9.5"/10" color slimline operator panel only:

 - On 30 days (24 hours) per year U<80 %, $t_d=24$ °C
 These days should be distributed naturally over the year.
 - On the remaining days (< 24 hours) U<80 %, $t_d=20$ °C
 observing the annual average
- **Condensation** Not permissible
- **Temperature variation**
 - Within 1 hour 10 K
 - Within 3 minutes 1 K
- **Atmospheric pressure** 860 mbar to 1080 mbar
 (86 kPa to 108 kPa)

The values specified apply to a transportation altitude of up to 1500 m above mean sea level. For greater altitudes, the upper limit must be reduced by 3.5°C per 500 m.

- **Resistance to vibration**
Vibratory load to IEC 60068-2-6
 - In operation

Frequency	Excursion	Acceleration
10-58 Hz	0.075 mm	--
58-200 Hz	--	9.8 m/s ²

Shock load

Test group E, test Ea to IEC 60068-2-6

- Acceleration without disk drives 15 g (1 g=9.81 m/s²), duration 11 ms
- Acceleration for modules with disk drives 5 g, duration 30 ms

3.1.1.2 Transportation and storage

- **Temperature range**
 - Lower limit temperature See table in Section 3.2
 - Upper limit temperature See table in Section 3.2

- **Dew point temperature t_d and relative air humidity U**

- Annual average U=75 %, $t_d=17$ °C
- On 30 days (24 hours) per year U=95 %, $t_d=24$ °C
These days should be distributed naturally over the year.
- On the remaining days (<24 hours) U=85 %, $t_d=20$ °C
observing the annual average

Applies to 9.5"/10" color slimline operator panel only:

- On 30 days (24 hours) per year U<80 %, $t_d=24$ °C
These days should be distributed naturally over the year.
- On the remaining days (<24 hours) U<80 %, $t_d=20$ °C
observing the annual average

- **Condensation** Rare, briefly, light

Rare, brief and light condensation covers situations where the following conditions also apply:

- Max. duration of a single condensation event 3 hours
- Frequency of occurrence Annual average: 3
Maximum: 10
- Shortest sequence of condensation cycles 1 day

- **Temperature variation**

- Within 1 hour 20 K

- **Atmospheric pressure**

660 mbar to 1080 mbar
(66 kPa to 108 kPa)

The values specified apply to a transportation altitude of up to 3500 m above mean sea level.

- **Resistance to vibration**

- **Vibratory load to IEC 60068-2-6**

- When transported in transport packing

Frequency	Excursion	Acceleration
10-58 Hz	3,5 mm	--
58-200 Hz	--	9.81 m/s ²

- **Resistance to shock**

Required standard

DIN EN 60721-3-2

	Transport, external
Peak acceleration	300m/s ²
Shock duration	6 ms

• **Free fall**

Required standard EN 60721-3-2, Cl. 2M3 IEC 60721-3-2, Cl. 2M3

Devices and components with transport packaging:

Weight	Height of floor
< 20 kg	1.5 m
20 to 100 kg	1.2 m
> 100 kg	0.5 m

Devices and components, without packaging

Weight	Height of fall
< 10 kg	0.75 m
10 to 100 kg	0.25 m
> 100 kg	0.1 m

Hand-held units, without packaging

Weight	Height of fall
< 2 kg	1.0 m

Minor damages are taken into account in case of products without packaging as long as neither function nor safety are impaired.

• **Drop and topple, without packaging**

Required standard EN 60721-3-2 IEC 60721-3-2

Height of drop 100 mm < 100 kg

Drop around all edges of normal position in use

3.1.2 Exposure to contaminants

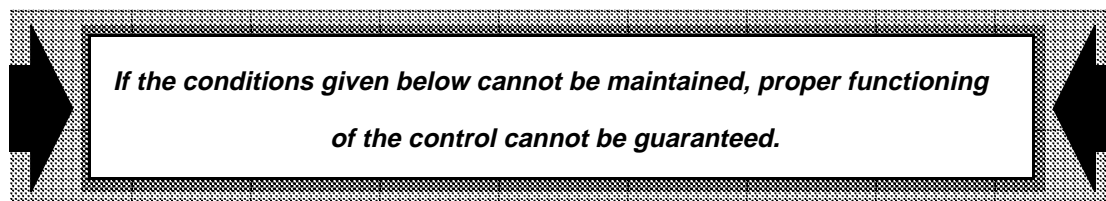

Relevant standards: EN 60721-3-3
 Classification 3S2

3.1.2.1 Hazardous gases

• **Sulphur dioxide (SO₂)**

Test conditions:

– Severity 10 cm³/m³ ± 0.3 cm³/m³

• **Hydrogen sulfide (H₂S)**

Test conditions:

– Severity 1 cm³/m³ ± 0.3 cm³/m³

3.1.2.2 Hazardous dust

Relevant standards: DIN EN 60721-3-3
Classification 3S2

When working in areas where there is an unacceptably high dust burden, the control must be operated in a cabinet with heat exchanger or in a cabinet with suitable air intake.

3.1.3 Electromagnetic compatibility (EMC)

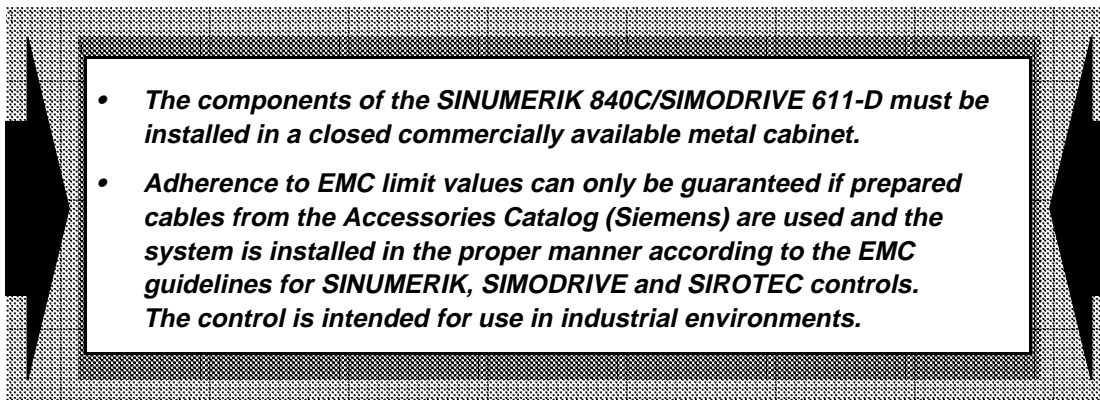

3.1.3.1 Interference suppression

Relevant standards: DIN EN 55011 DIN EN 50081, Part 2
DIN VDE 0160

- Mains-borne interference suppression
Interference suppression to limit value class A
- Interference radiation
Interference suppression to limit value class A

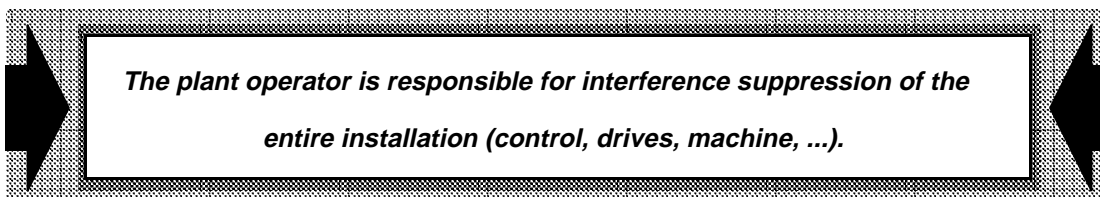

3.1.3.2 Immunity to noise

Relevant standards: DIN EN 50082, Part 2
DIN EN 60204, Part 1

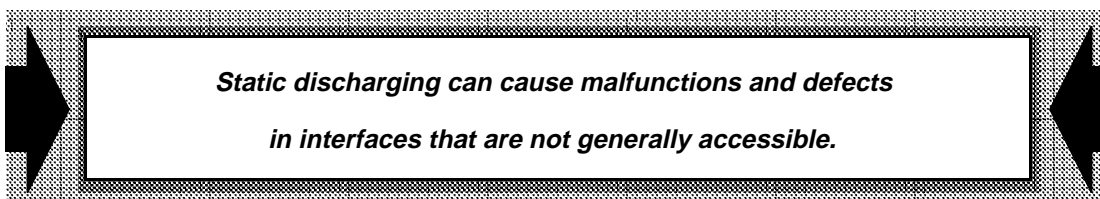

Note:

Noise interference can adversely affect operation in the following ways:

- Drops for < 500 μ s at binary outputs permitted
- Reversible changes to display
- Repeated transmission of corrupted data frames.

3.1.4 Miscellaneous

3.1.4.1 Colors

Application	Basic color anthracite	
	Color	Color No. 1)
Housing, front panels for operator panels	Anthracite	-614
Background color of keys	Ergo grey	-611
Key contrast color / key groups	Mid-grey	6115
STOP function keys	Red	RAL 3018
START functions keys	Green	-506
Symbols, lettering, outlines	Black	RAL 9005
Surface beneath EMERGENCY STOP button	Yellow	RAL 1021
EMERGENCY STOP button	Red	RAL 3000
Siemens logo and strip labels	Petrol	-615

3.1.4.2 Data protection, stored energy times

For storage media requiring a backup power supply (volatile semiconductor memories), a stored energy time of ≥ 1 year is guaranteed.

The above time commences on the day of delivery from the factory (date on factory delivery note). The battery is delivered with the control as a separate item. Battery replacement is described in the Section Replacing batteries.

1) Full color designation:
 for plastics SN 30901 ... - xxx
 for coatings SN 30901 ... - xxx

|
 Color number

3.2 Technical data of the individual components

SINUMERIK 840C controls are manufactured in accordance with the requirements for equipment specified in EN 60204, Part 1 and DIN VDE 0160.

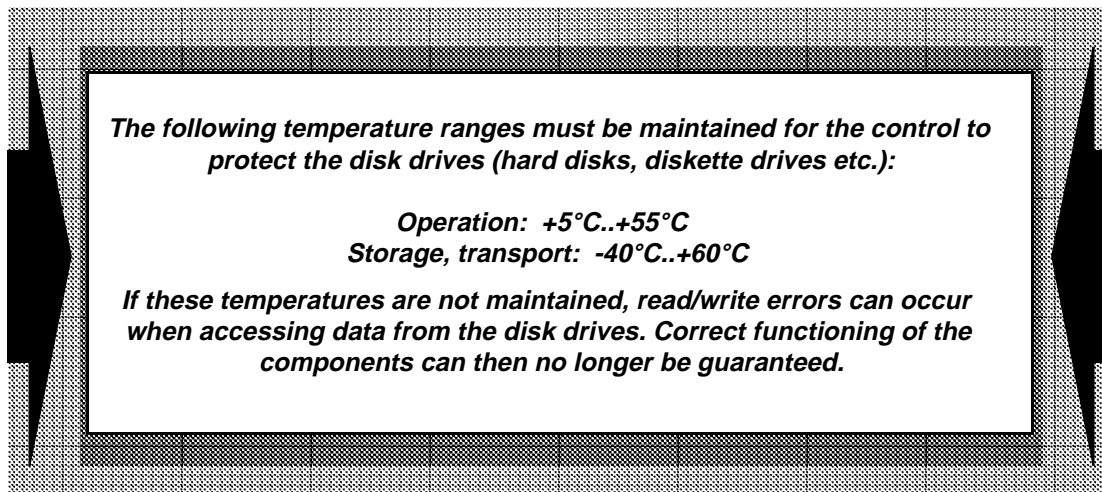

3.2.1 Mechanical data and temperature ranges of the individual components

Unit	Conditions	Dimensions		Weight	Temperature ranges	
		Width	Height Depth		Operation	Storage/transport
14" color monitor		483 mm		14.9 kg	5 to 55 °C	
Spare part with 10.4" display		355 mm		7 kg	-25 to 65 °C	
10" color slimline operator panel		392 mm			0 to 50 °C	
9.5" monochrome slimline operator panel				4.25 kg	-20 to 60 °C	
10" monochrome slimline operator panel		483 mm		4.15 kg	0 to 45 °C	
9.5" color slimline operator panel		310 mm			-25 to 60 °C	
		78 mm (85 mm) ¹⁾				
10.4" color slimline operator panel		483 mm		5 kg	0 to 55 °C	
		310 mm			-40 to 70 °C	
		78 mm				
NC keyboard		483 mm		0.64 kg	0 to 50 °C	
		132 mm			-40 to 70 °C	
		32 mm				
NC keyboard with keyboard interface		483 mm		1.51 kg	0 to 55 °C	
		132 mm			-40 to 70 °C	
		61 mm				

Mechanical data and temperature ranges, overview

1) The values in brackets apply to the 9.5" slimline operator panel with a 24V DC power supply unit.

3.2.1 Mechanical data and temperature ranges of the individual components

Conditions	Dimensions	Weight	Temperature ranges Operation Storage/transport
Unit	Width Height Depth		
Machine control panel	483 mm 155 mm 53 mm	0.95 kg	0 to 55 °C –40 to 70 °C
Machine control panel with keyboard interface	483 mm 155 mm 60 mm	1.82 kg	0 to 55 °C –40 to 70 °C
Keyboard interface	360 mm 96 mm 62 mm	0.87 kg	0 to 55 °C –40 to 70 °C
PC standard keyboard (MF II) (6FC5 103-0AC03-0AA0)	471 mm 38 mm 194 mm	1.22 kg	0 to 50 °C –40 to 70 °C
PC standard keyboard (MF II) (6FC5 103-0AC03-0AA0)	460 mm 160 mm 35 mm	0.5 kg	0 to 50 °C –40 to 70 °C
Handheld unit 6FC5 103-0AD20-0AA0	255 mm 188 mm 82 mm	1.5 kg	0 to 55°C –20 to 60 °C
Handheld unit A-MPC 6FX2 007-1AB	245 mm 108 mm 125 mm	1.5 kg	0 to 55°C –20 to 60 °C
Distribution box (VTK1) 6FC5 147-0AA05-0AA0	105 mm 175 mm 32 mm	0.25 kg	0 to 55°C –40 to 70 °C
Distribution box (VTK2) 6FX2 006-1BB0	100 mm 120 mm 72 mm	0.25 kg	0 to 55°C –40 to 70 °C
3.5" diskette drive FD-E2	145 mm 50 mm 195mm	0.76 kg	5 to 55 °C –40 to 60 °C
Voltage converter module	315 mm 85 mm 50 mm	–	0 to 55 °C –40 to 70 °C
Pushbutton module	279 mm 81 mm 100 mm	–	0 to 55 °C –40 to 70 °C
Central controller 12 slots – Max. configuration	273 mm 370 mm 212 mm	5 kg 15 kg	depends on modules used
Central controller 18 slots – Max. configuration	410 mm 370 mm 212 mm	7.5 kg 21 kg	depends on modules used
Central controller 18 + 3 AT slots – Max. configuration	500 mm 370 mm 212 mm	9.0 kg 26.0 kg	depends on modules used
NC CPU 386 DX NC CPU 486 DX	Eurocard module	0.43 kg	0 to 55 °C –40 to 70 °C
ANALOG measuring circuit module without EXE	Eurocard module	0.34 kg	0 to 55 °C –40 to 70 °C
ANALOG measuring circuit module with EXEs	Eurocard module (double-width)	0.54 kg	0 to 55 °C –40 to 70 °C
HMS measuring circuit module without SERVO COMMAND submodule	Eurocard module	–	0 to 55 °C –40 to 70 °C

Mechanical data and temperature ranges, overview (continued)

3.2.1 Mechanical data and temperature ranges of the individual components

Unit	Conditions	Dimensions		Weight	Temperature ranges	
		Width	Height Depth		Operation	Storage/transport
HMS measuring circuit module with SERVO COMMAND submodule		Eurocard module (double-width)		–	0 to 55 °C	–40 to 70 °C
CP 315 ACTIVE RS 232		Eurocard module		0.49 kg	0 to 55 °C	–40 to 70 °C
CP 373/CP 315 ACTIVE RS 232 C with submodule		Eurocard module (double-width)		0.79 kg	0 to 55 °C	–40 to 70 °C
CP 231 SINEC H1		Eurocard module		0.48 kg	0 to 55 °C	–40 to 70 °C
PLC CPU 135 WB2 PLC CPU 135 WD		Eurocard module		0.38 kg	0 to 55 °C	–40 to 70 °C
Interface PLC		Eurocard module		0.37 kg	0 to 55 °C	–40 to 70 °C
Interface DMP		Eurocard module		0.38 kg	0 to 55 °C	–40 to 70 °C
Interface EU 16 Bit		Eurocard module		0.31 kg	0 to 55 °C	–40 to 70 °C
IN ANALOG I/O module		Eurocard module		0.44 kg	0 to 55 °C	–40 to 70 °C
Mixed I/O module		Eurocard module		0.46 kg	0 to 55 °C	–40 to 70 °C
MMC CPU 386 SX MMC CPU 486 DX/SX		Eurocard module (double-width)		1.0 kg	5 to 55 °C	–40 to 60 °C
MMC Interface		Eurocard module		0.37 kg	0 to 55 °C	–40 to 70 °C
Interface Profibus DP Interface module IM328-N/IM329-N		Eurocard module		0.40 kg	0 to 55 °C	–40 to 70 °C
SINEC CP 1476 (MAP 3.0)		Eurocard module		0.61 kg	0 to 55 °C	–40 to 70 °C
DMP modules		Eurocard module		See Sect. 4	0 to 55 °C	–40 to 70 °C

Mechanical data and temperature ranges, overview (continued)

3.2.2 Electrical data of the individual components

Unit	Conditions	Nominal voltage and tolerance	Nominal frequency	Max. connected load at nominal voltage	Max. power loss at nominal voltage	Max. inrush current	Degree of protection to DIN 40050	Protection against touching contact to DIN VDE 0160
14" color screen		230 V AC +10 % -20 %	50/60 Hz ±5 Hz	120 W	110 W	20 x I _N for 10 ms	Front: IP 54 Rear: IP 20	
14" color screen from 07.94		230 V AC 90 ... 260 V	50/60 Hz ±5 Hz	70 W	50 W	20 x I _N for 10 ms	Front: IP 54 Rear: IP 00	
Spare part with 10.4" display		230 V AC 90 ... 260 V	50/60 Hz ±5 Hz	30 W	30 W	20 x I _N for 10 ms	Front: IP 54 Rear: IP 00	
9.5" color/monochrome slimline operator panel with machine control panel		24 V DC	—	30 W	30 W	20 x I _N for 10 ms	Front: IP 54 Rear: IP 00	
10" color/monochrome slimline operator panel with machine control panel		230 V AC +10 % -20 %	50/60 Hz ±5 Hz	30 W		20 x I _N for 10 ms	Front: IP 54 Rear: IP 00	
9.5" color slimline operator panel with machine control panel		230 V AC 90 ... 260 V	50/60 Hz ±5 Hz	62 W	50 W ¹⁾	20 x I _N for 10 ms	Front: IP 54 Rear: IP 00	
10" monochrome slimline operator panel with machine control panel		230 V AC +10 % -20 %	50/60 Hz ±5 Hz	65 W	50 W ²⁾	20 x I _N for 10 ms	Front: IP 54 Rear: IP 00	
10.4" color slimline operator panel		230 V AC +10 % -20 %	50/60 Hz ±5 Hz	40 W	40 W	20 x I _N for 10 ms	Front: IP 54 Rear: IP 00	
NC keyboard with keyboard interface		230 V AC +10 % -20 %	50/60 Hz ±5 Hz	25 W	17 W	20 x I _N for 10 ms	Front: IP 54 Rear: IP 00	
NC keyboard and machine control panel with keyboard interface		230 V AC +10 % -20 %	50/60 Hz ±5 Hz	25 W	20 W	20 x I _N for 10 ms	Front: IP 54 Rear: IP 00	
NC keyboard and machine control panel with keyboard interface (6FC5 103-0AE01-0AA1)		230 V AC 90 ... 260 V	50/60 Hz ±5 Hz	25 W	20 W	20 x I _N for 10 ms	Front: IP 54 Rear: IP 00	
Keyboard interface		24 V DC	—	12 W	12 W	20 x I _N for 10 ms	Front: IP 54 Rear: IP 00	
Handheld unit 6FC5 103-0AD20-0AA0		24 V DC	—	via VTK1	5 W	20 x I _N for 10 ms	IP 54	I
Handheld unit A-MPC 6FX2 007-1AB		24 V DC	—	via VTK2	5 W	20 x I _N for 10 ms	IP 65	I
Distribution box (VTK1) 6FC5 147-0AA05-0AA0		24 V DC	—	5VA	0 W	20 x I _N for 10 ms	IP 20	I
Distribution box (VTK2) 6FX2 006-1BC0		24 V DC	—	5VA	0 W	20 x I _N for 10 ms	IP 20	I
All central controllers with max. current consumption		230 V AC 90 ... 260 V	45 ... 65 Hz	300 W	100 W	20 x I _N for 10 ms	IP 20	
All central controllers with max. current consumption		230 V DC 130 ... 260 V	—	300 W	100 W	20 x I _N for 10 ms	IP 20	
3.5" diskette drive FD-E2		24 V DC	—			20 x I _N for 10 ms	Front: IP 54 Rear: IP 00	
Voltage converter module		24 V DC 20 ... 30 V	—		15 W	20 x I _N for 10 ms	IP 00	
Pushbutton module		24 V DC	—	40 W		20 x I _N for 10 ms	IP 00	

Electrical data, overview

1) For 20 W backlight power consumption

2) For 70 % use of screen

Conditions	Nominal voltage and tolerance	Nominal frequency	Max. power loss at nominal voltage	Max. inrush current	Degree of protection to DIN EN 60529	Contact protection class to DIN VDE 0160
DMP terminal block (fully equipped)	24 V DC	230 mA	5.5 W	20 x I _N for 10 ms	IP 20	I
DMP submodule, 16 I/16 O	24 V DC	250 mA	33 W	20 x I _N for 10 ms		
DMP submodule, 32 I	24 V DC	250 mA	8.3 W	20 x I _N for 10 ms		
DMP compact submodule, 8 O	24 V DC	—	2.5 W	—		
DMP compact submodule, 16 O	24 V DC	—	2.3 W	—		
DMP compact submodule, 16 I	24 V DC	—	165 mW per input 2.5 W per module	—		
DMP compact submodule ANALOG OUT	24 V DC	60 mA	1.6 W	—		
DMP compact submodule ANALOG IN	24 V DC	45 mA	1.3 W	—		
Terminal block with DMP submodule in IP 65 design	24 V DC	230 mA	3 W	20 x I _N for 10 ms	IP 65	

Electrical data, overview (continued)

3.2.2.1 Requirements for power supply

The power back-up times for DC, single-phase and three-phase power supplies differ. Transient power failures, for example, can cause binary outputs to drop out but not the control to switch off.

- AC power supply**

Nominal voltage

- Tolerance 230 V AC
– 20 %, +10 % (184 V to 253 V)
- Frequency 50/60 Hz ±5 Hz
- Ramp-up time at power up 100 ms

Harmonic content

In accordance with DIN VDE 0160 10 %

Short voltage dips

In accordance with EN 60204, Part 1

- Voltage interrupts at nominal voltage and current
- Central controller 200 ms
- Color/monochrome slimline operator panels 20 ms
- Restoration time 10 s
- Events per hour 10

One of the two power cables (preferably cable N) must be earthed on all components with a 230 V AC power supply.

• **Requirements for DC supply**

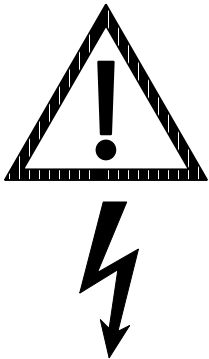
	WARNING
	<p>The DC supply is always referred to earth and must not be generated by an autotransformer. The DC supply must be provided as a PELV electric circuit so that it is safely isolated.</p>

- **Nominal voltage in accordance with EN 61131**

	24 V DC
– Voltage range including ripple	20.4 V DC to 28.8 V DC
– Voltage ripple at nominal voltage and current peak to peak	3.6 V
– Ramp-up time at power up	100 ms

- **Harmonic content**

In accordance with DIN VDE 0160	10 %
---------------------------------	------

- **Non-periodic overvoltages**

	35 V
– Duration of overvoltage	500 ms
– Restoration time	50 s
– Events per hour	10

- **Short voltage dips**

To EN 60204 Part 1, with the following variations:

– Duration of voltage dips	5 ms
– Restoration time	10 s
– Events per hour	10

3.2.2.2 Connected load and power loss calculation

The maximum values for the connected load (central controller, machine control panel) specified in Table "Electrical data of the individual components" in Section 3.2.2 are based on a power supply unit capacity utilization of $A = 100\%$.

The values stated for maximum power loss (central controller, machine control panel) are based on the following conditions:

- Power supply unit capacity utilization $A = 100\%$
- No power output from the power supply unit to external components (e.g. encoders)
- Switching power losses from output modules in the central controller are taken into account for a maximum I/O device configuration.

The following tables can be used to determine the actual connected load and power loss. This is primarily necessary when the maximum power loss according to Table "Electrical data of the individual components" demands an unrealistic convection surface area for heat removal (see Sections "Heat removal").

If the electrical connection and heat removal are designed for the maximum values given in Table "Electrical data of the individual components", the connected load and power loss do not have to be calculated.

The power supply unit capacity utilization must be calculated if it is to be expected that the maximum permissible power supply unit capacity utilization will be exceeded by the planned inclusion of a large number of hardware options (mainly in the case of large controls) and external components.

Notes on calculation table:

- Power supply unit capacity utilization A_n
Enter all required modules, additional and external components along with the required currents. Check power supply unit capacity utilizations A_n for individual power supply output voltages.
- Power supply unit capacity utilization P_S
The degree of efficiency is used to calculate the connected load:
 $=0.7$ with 100% power supply unit capacity utilization
- The power consumption of the installed AT modules for $\pm 12\text{ V}$ must be entered in columns $\pm 15\text{ V}$ and added together, as the $\pm 12\text{ V}$ are taken from the $\pm 15\text{ V}$ supply.
- The fuse protection required is derived from the calculated connected load.

Note:

Because of the low leakage currents, all SINUMERIK 840C components can be operated with a residual current operated circuit-breaker.

3.2.2 Electrical data of the individual components

• Power loss P

When calculating power loss P, note that:

- the power loss of the external components P_{ext} is not included in the power loss of the compact control or central controller:
- the switching power losses of the output modules $P_{I/O}$ in the compact control or central controller increase the power loss in the latter.

Modules	$U_{A1} = +5\text{ V}$			$U_{A2} = +15\text{ V}$			$U_{A3} = -15\text{ V}$			Notes
	Current per module	No. of mod.	Current	Current per module	No. of mod.	Current	Current per module	No. of mod.	Current	
Mod. currents (central contr.)	—	—		—	—		—	—		

Encoder				
External EXEs				
currents (ext. components)				I_{extn}
currents to				I_{An}
Max. PS unit output currents	$I_{Am1} = 30\text{ A}$	$I_{Am2} = 2\text{ A}$	$I_{Am3} = 1\text{ A}$	I_{Amn}
Power supply unit capacity utilization A_n				max. permiss.: 100 %

Calculation table for power supply unit capacity utilization

Power supply unit connected load $P_S = 1 / \times 1 / \times P_A$				
Voltages U_{An}	+5 V	+15 V	- 15 V	
Currents I_{An}				transferred from
Power supply unit outputs P_{An}	VA	VA	VA	$P_{An} = I_{An} \times U_{An} $
Actual power supply unit output P_A				$P_A = P_{An}$
Max. power supply unit outputs P_{Am} with power supply unit	195 W			
Power supply unit capacity utilization A				$A = P_A / P_{Am}$
Power factor	0.55			
Efficiency	0.7 at 100% power supply unit capacity utilization			
Power supply unit connected load P_S				

Calculation table for power supply unit connected load

Power loss $P = 1 / \times P_A - P_{ext} + P_{out}$				
Current I_{extn} (ext. components)				transferred from
Power losses P_{extn} (ext. comp.)				$P_{extn} = U_{An} \times I_{extn}$
Power loss P_{ext} (ext. comp.)				$P_{ext} = P_{extn}$
Switching power losses P_{out} (outputs)				$P_{out} = \text{Number of outputs} \times \text{switched current} \times \text{voltage drop at switch}$
Power loss P				

Calculation table for power losses

3.2.3 Standards

International and national standards have been observed in the design of the SINUMERIK 840C control.

Intern. Standard		European standard		National standard		
		EN 292-1	1991	DIN EN 292-1		11.91
		EN 292-2	1995	DIN EN 292-2		06.95
		EN 50081-2	08.93	DIN EN 50081-2	Cl. VDE 0839-81-2	03.94
		EN 50082-2	03.95	DIN EN 50082-2	Cl. VDE 0839-82-2	02.96
		prEN 50178	08.94			
IEC 204-1	m.1992	EN 60204-1	1992	DIN EN 60204-1	Cl. VDE 00113-1	06.93
IEC 439-1	m.1993	EN 60439-1	01.94	DIN EN 60439-1	Cl. VDE 0660-500	04.94
IEC 529	1989	EN 60529	1991	DIN VDE 0470-1		
IEC 947-1	m.1988	EN 60947-1	1991	DIN EN 60947-1	VDE 0660-100	07.92
IEC 1131-2	1992	EN 61131-2	08.94	DIN EN 61131-2	VDE 0411-500	05.95
				DIN	VDE 0160	05.88

The following Siemens standards (SN) have also been observed:

Standard	Text	Part																				
DIN EN 60721-3-3 Class 3K5	<p>Application classes for constructional units in electrical engineering</p> <p>Air temperature, humidity, pressure</p> <p>This standard contains application classes for constructional units in electrical engineering, e.g. in metrology and control technology. Considering the conditions to be expected in operation, during transportation and storage, constructional units can therefore be selected in accordance with uniform considerations. An application class within the framework of this standard is formed by the values of the upper and lower limit temperature of the medium directly surrounding the constructional unit and the humidity and air pressure which is created in this area.</p>																					
DIN EN 60721-3	<p>Mechanical testing loads for operation and transport</p> <p>This standard covers severities of test loading for installations, equipment and constructional units in electrical engineering. With these severities, the resistance of the installations, equipment and constructional units against mechanical vibration can be determined.</p> <table border="1" style="width: 100%; border-collapse: collapse;"> <thead> <tr> <th rowspan="2">Class</th> <th rowspan="2">Frequency range (Hz)</th> <th colspan="2">Constant amplitude of</th> </tr> <tr> <th>Deflection (mm)</th> <th>Acceleration (m/s²)</th> </tr> </thead> <tbody> <tr> <td rowspan="2">-3, 3M4</td> <td>10 to 58</td> <td>0.075</td> <td>—</td> </tr> <tr> <td>58 to 200</td> <td>—</td> <td>9.8</td> </tr> <tr> <td rowspan="2">-2, 2M3</td> <td>5 to 9</td> <td>3.5</td> <td>—</td> </tr> <tr> <td>9 to 200</td> <td>—</td> <td>20</td> </tr> </tbody> </table>	Class	Frequency range (Hz)	Constant amplitude of		Deflection (mm)	Acceleration (m/s ²)	-3, 3M4	10 to 58	0.075	—	58 to 200	—	9.8	-2, 2M3	5 to 9	3.5	—	9 to 200	—	20	1, 2
Class	Frequency range (Hz)			Constant amplitude of																		
		Deflection (mm)	Acceleration (m/s ²)																			
-3, 3M4	10 to 58	0.075	—																			
	58 to 200	—	9.8																			
-2, 2M3	5 to 9	3.5	—																			
	9 to 200	—	20																			
SN 29080	<p>Climatic resistance of electrical equipment</p> <p>This standard includes a climatic overview map with sea routes.</p>																					
SN 29081	<p>Packaging recommendations for electrical equipment</p> <p>Permissible climatic exposure before start-up</p> <p>In this standard, the limits of climatic exposure are given that are permissible for electrical equipment during transportation and storage before start-up.</p>																					

Siemens standard	Text	Part
SN 29500	<p>Failure rates of construction elements</p> <p>Part1: General The most frequently used quantity required for reliability calculations of modules and units is the failure rate. This standard contains explanations and should be used in conjunction with one of the following parts:</p> <p>Part 2: Empirical values for integrated circuits (IS). Part 3: Empirical values for discrete semiconductors (DH). Part 4: Empirical values of passive components (PB). Part 5: Empirical values for electrical connection points. Part 6: Empirical values for printed circuit connectors. Part 7: Empirical values for relays. Part 8: Empirical values for integrated circuit holders. Part 9: Empirical values for switches. Part 10: Empirical values for pilot and signal lamps. Part 11: Empirical values for contactors.</p>	1 to 11
SN 30901	<p>Choice of colors for products</p> <p>Siemens colors and surfaces This standard is intended to ensure the uniform coloring of Siemens AG products and applies to surfaces that affect the external appearance. It is valid for plastics, paint finishes and similar coatings.</p>	

***Please contact your local Siemens office or Siemens National Company
for more detailed information about Siemens standards (SN).***

3.3 Mechanical installation

Precise installation instructions must be observed for the components of the SINUMERIK 840C. Please note the different instructions for enclosed mounting and forced-draught ventilation.

The maximum permissible temperatures must never be exceeded.

3.3.1 Operator panel with 14" color screen

3.3.1.1 Dimension drawings

Front

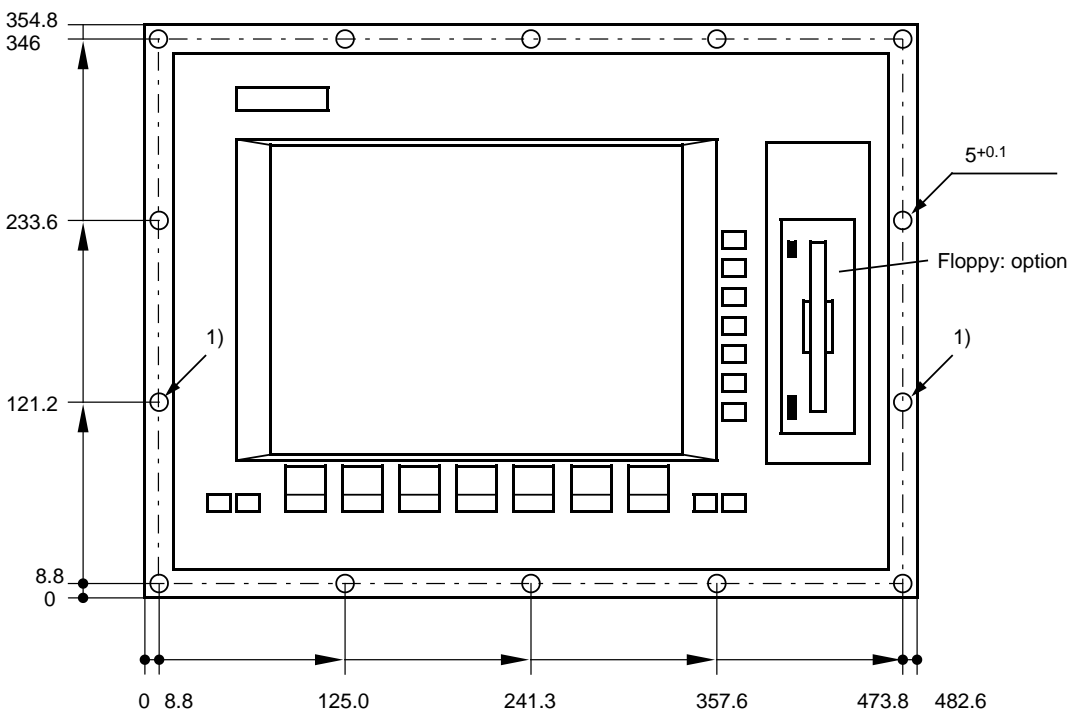

1) Note: Fit these screws first!

Rear

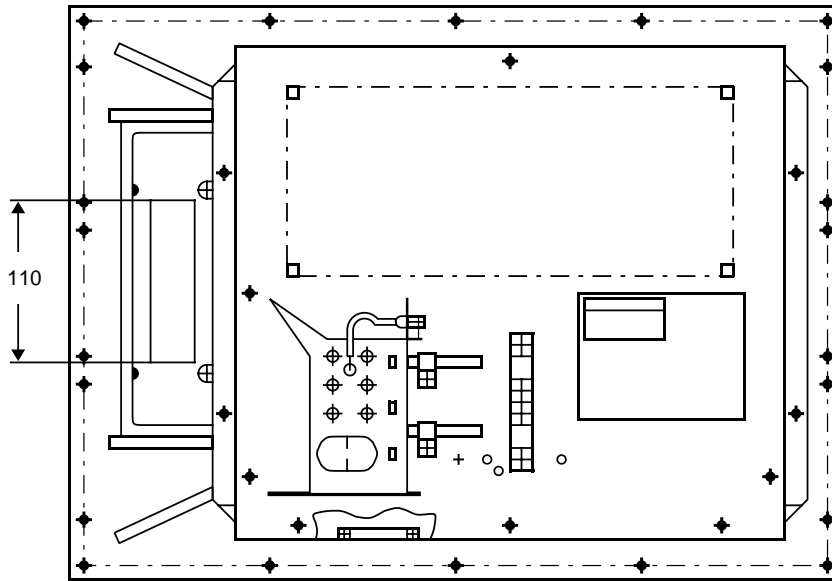

Side view

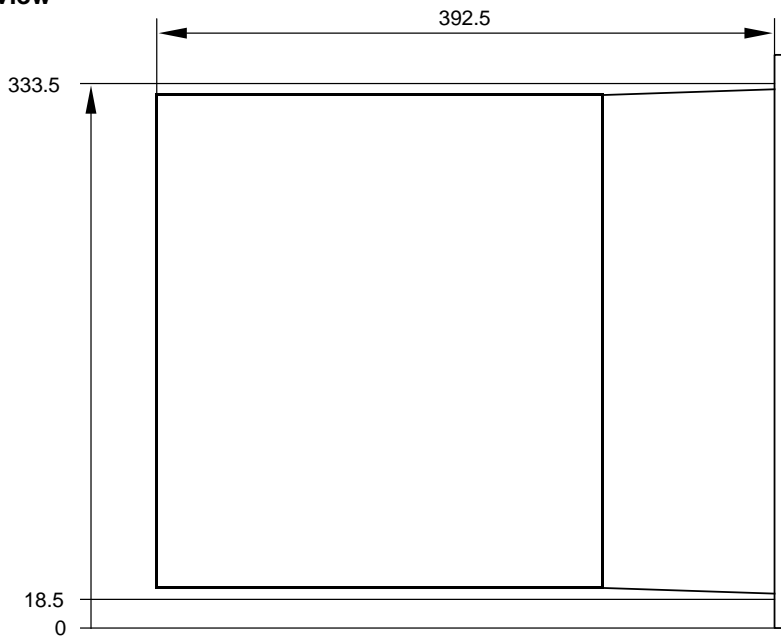

Top view

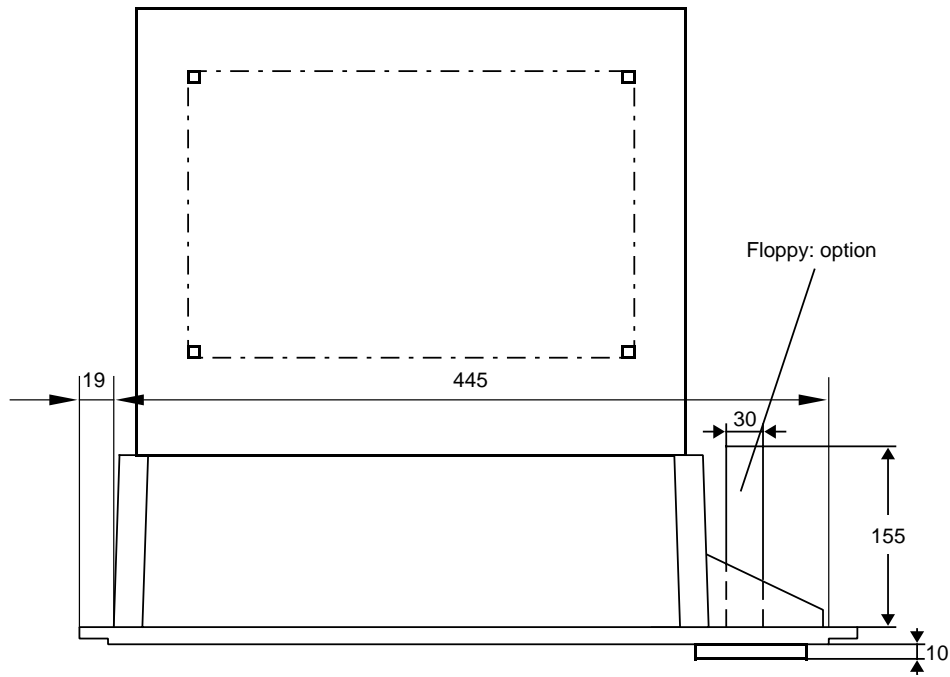

3.3.1.2 Panel cutout

- Color screen

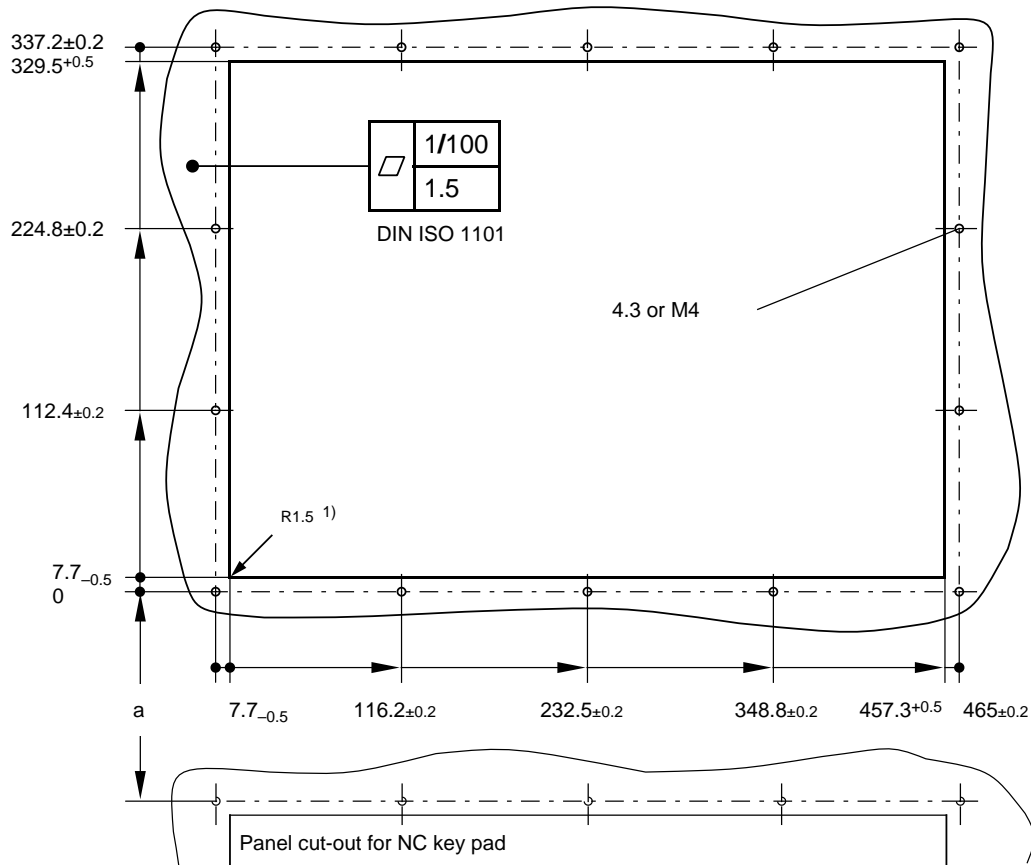

- a= Mounting distance between screen monitor unit and NC key pad, 19 a 177
 1) Recommended only for rear mounting

- Blanking plate for floppy drive FD-E2

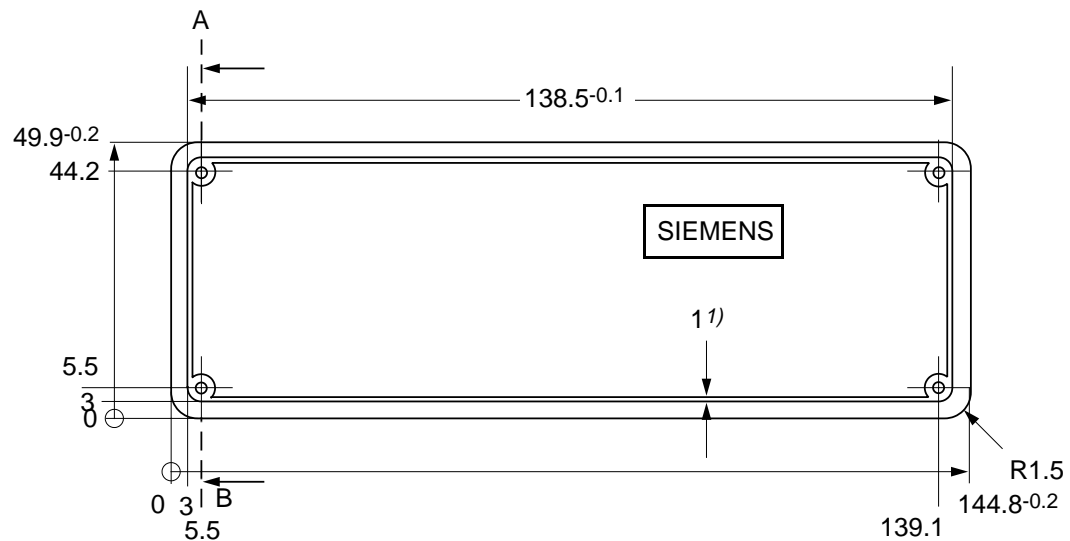

Section A - B

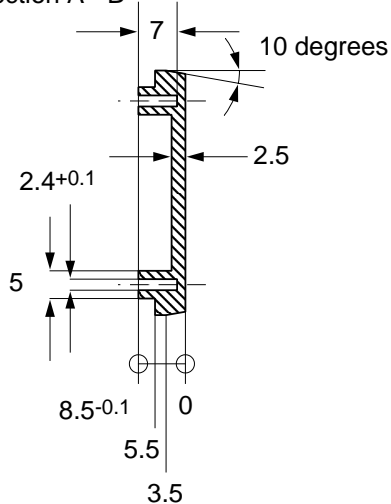

1) all around

3.3.1.3 Installation notes

Side view

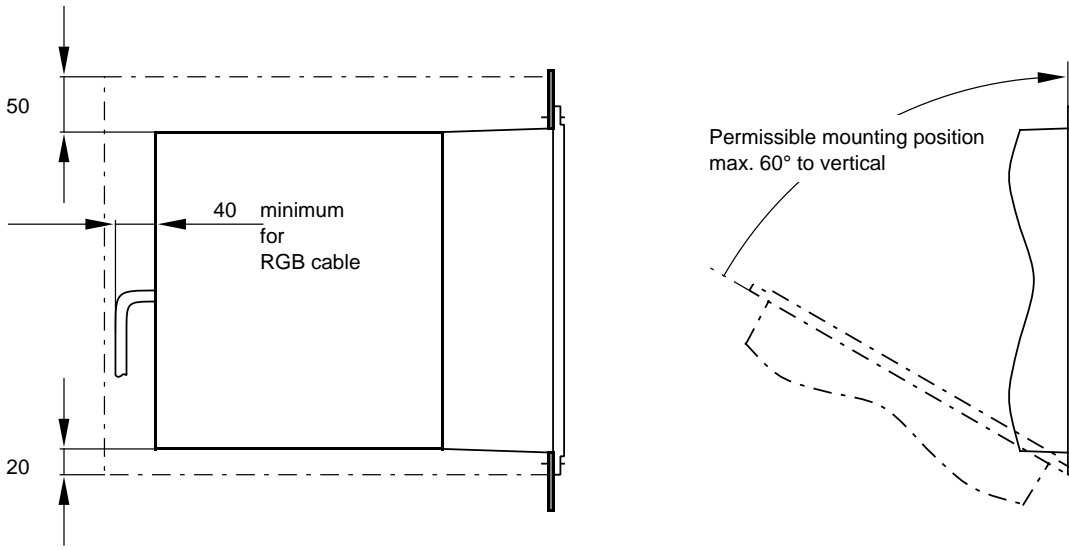

Top view

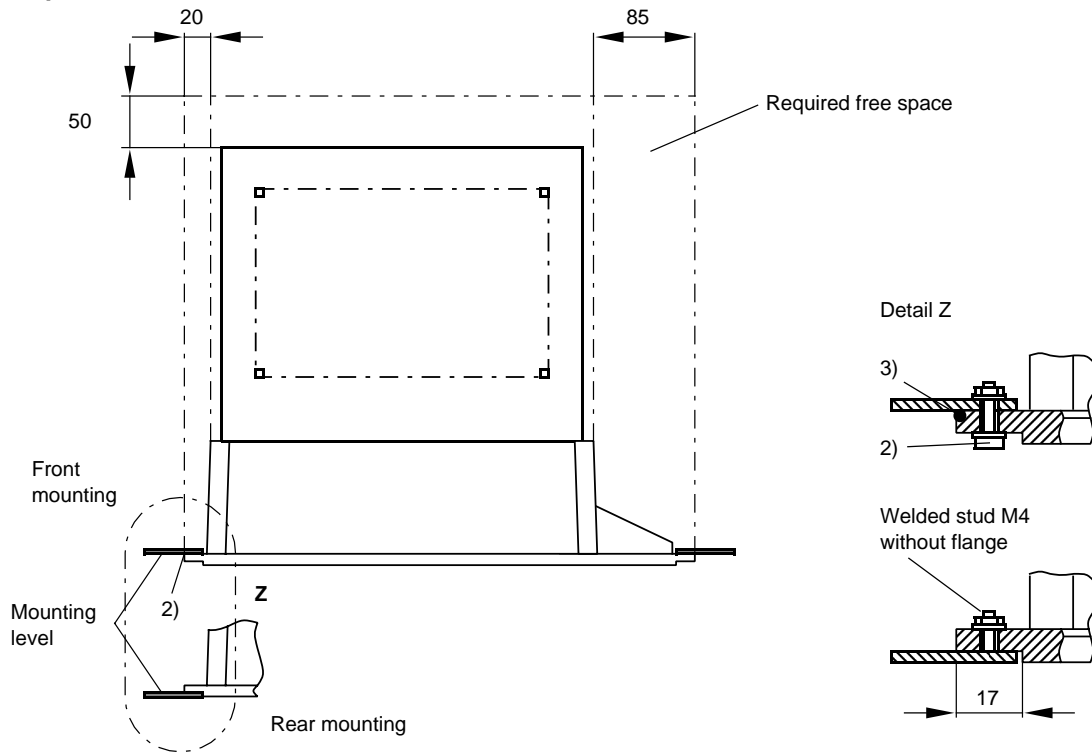

- 2) Take recommended M4 screws out of additional package; max. fastening torque 1.0 + 0.5 Nm; use DIN 125 washer for customer-specific screws.
- 3) For use under tough environmental conditions, e.g. oil mist, use of a sealing cord with a dia. of 2 mm (GWE Order No. 298 364) is recommended.

Note:

The metallic coating on the plastic frontplate must make the largest area contact with the mounting surface of the control cabinet, that is, it must be screwed onto unpainted metal. If mounted on the inside of the control cabinet, the fixing screws must make good contact with the metallic coating.

3.3.1.4 Heat removal

The climatic data, degree of protection and power loss for the SINUMERIK 840C control are given in the technical data (see Sections 3.2.1 and 3.2.2) .

The surfaces of the front and underside have not been included in the calculation of the convection surface.

- **Heat removal by natural convection**

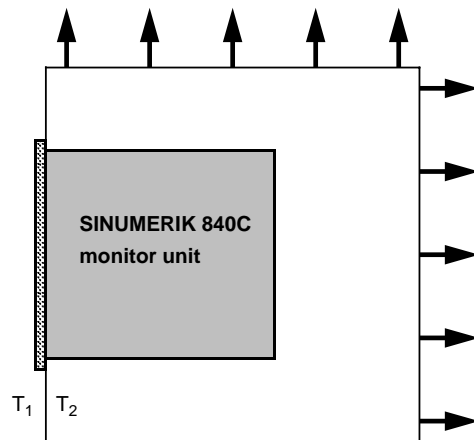

The necessary free convection surface of the surrounding space (steel or aluminium sheet, 1.5 mm thick) is determined referred to a temperature difference $T_2 - T_1 = T \approx 10$ K, approximately from:

$$A \text{ [m}^2\text{]} = \frac{P_v \text{ [W]}}{5 \cdot T \text{ [K]}}$$

Example: $T_1 = 45^\circ\text{C}$, $T_2 = 55^\circ\text{C}$
 $P_v = 85 \text{ W}$

$$A = 1.7 \text{ m}^2$$

T Temperature difference
 T_1 Ambient temperature
 T_2 Internal temperature

- **Heat removal by natural convection and internal air turbulence**

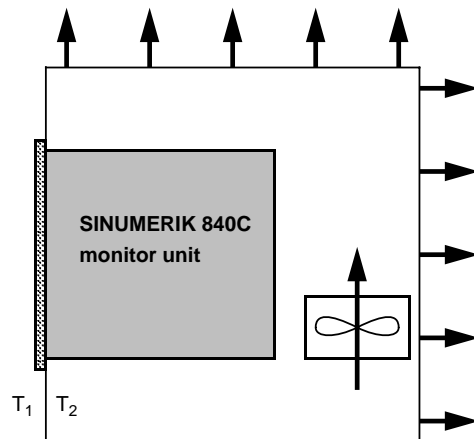

The necessary free convection surface of the surrounding space (steel or aluminium sheet, 1.5 mm thick) is determined, referred to a temperature difference $T_2 - T_1 = T \approx 10$ K, approximately from:

$$A \text{ [m}^2\text{]} = \frac{P_v \text{ [W]}}{10 \cdot T \text{ [K]}}$$

Air flow through fan: 100 to 165 m³/h

Example: $T_1 = 45^\circ\text{C}$, $T_2 = 55^\circ\text{C}$
 $P_v = 85 \text{ W}$

$$A = 0.85 \text{ m}^2$$

- Heat removal by open-circuit ventilation

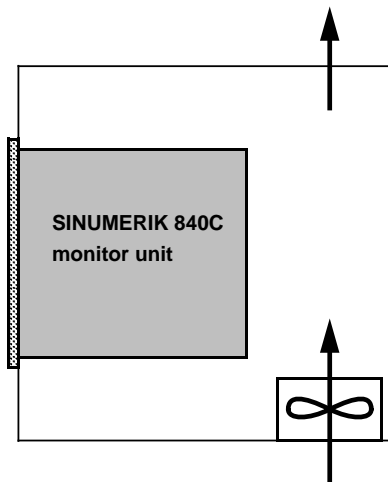

The air flow for removing lost heat is calculated from:

$$V \text{ [m}^3\text{/h]} = \frac{3.5 P_v \text{ [W]}}{T \text{ [K]}}$$

Example: Inlet air temperature 45 °C,
T=10 K, P_v=85 W

V=29.75 m³/h

Note: Air filters must be provided to maintain the permissible environmental conditions given in the section entitled "Climatic environmental conditions".

3.3.2 19" operator panel with 10.4" display (spare part for operator panel with 14" screen)

3.3.2.1 Dimension drawings

Front

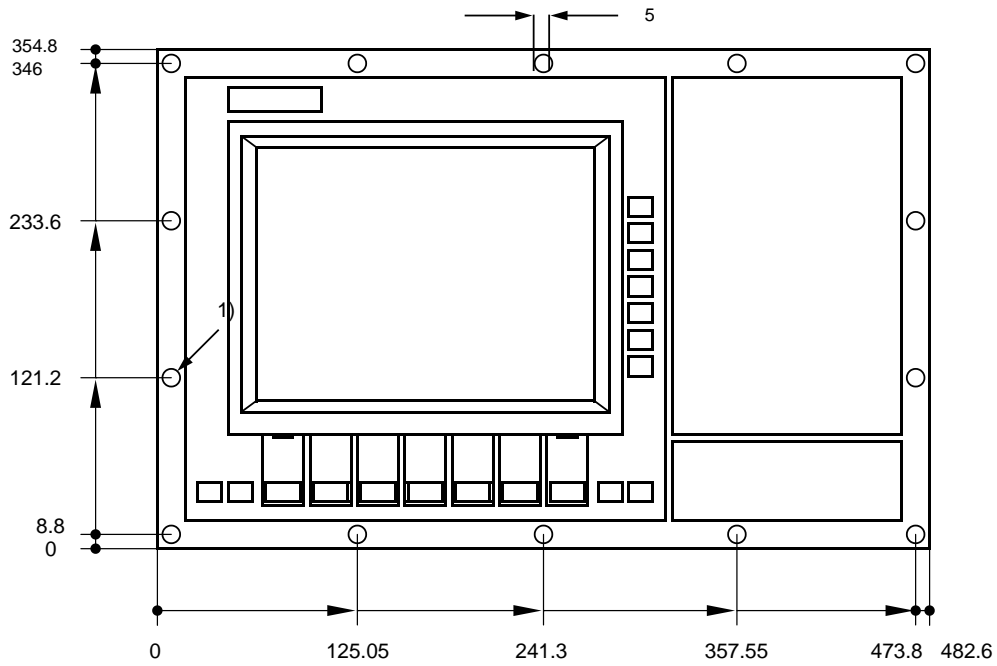

Rear

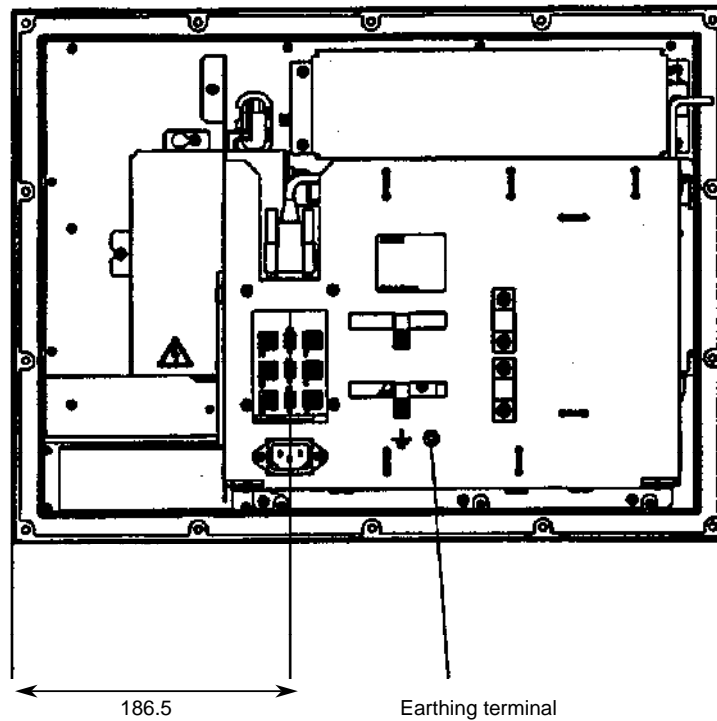

Side view

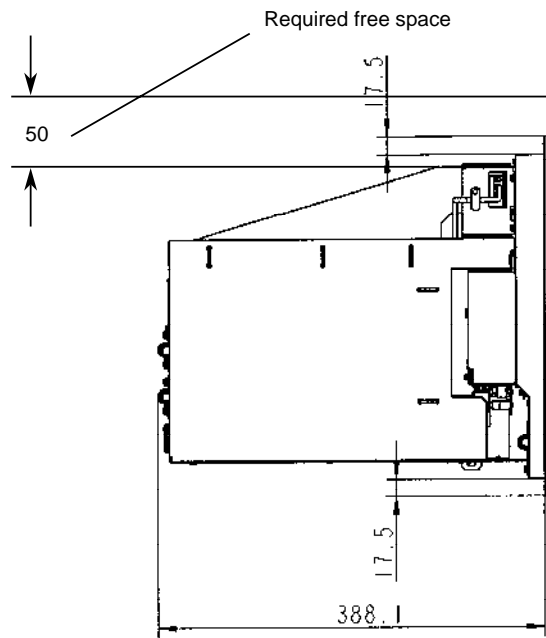

Top view

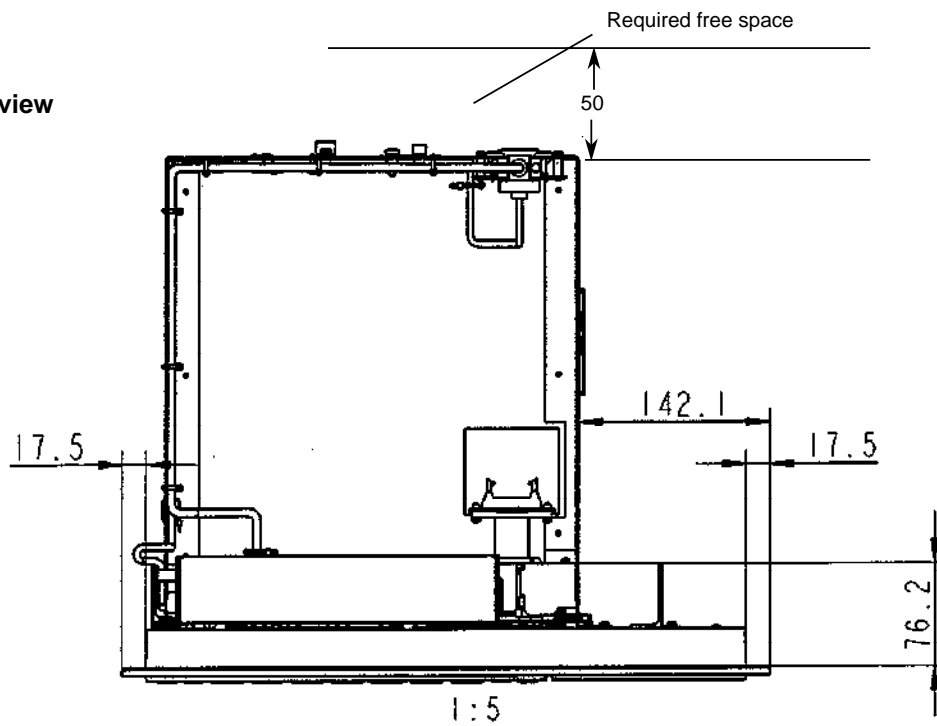

Panel cutout

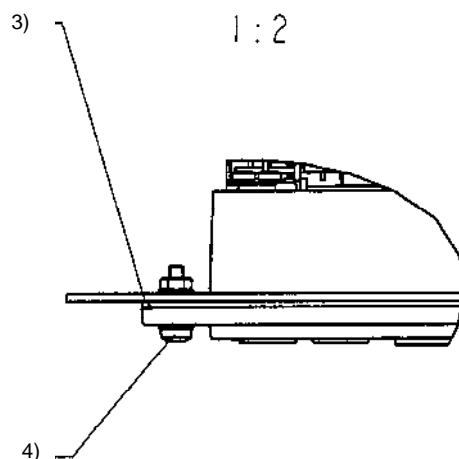
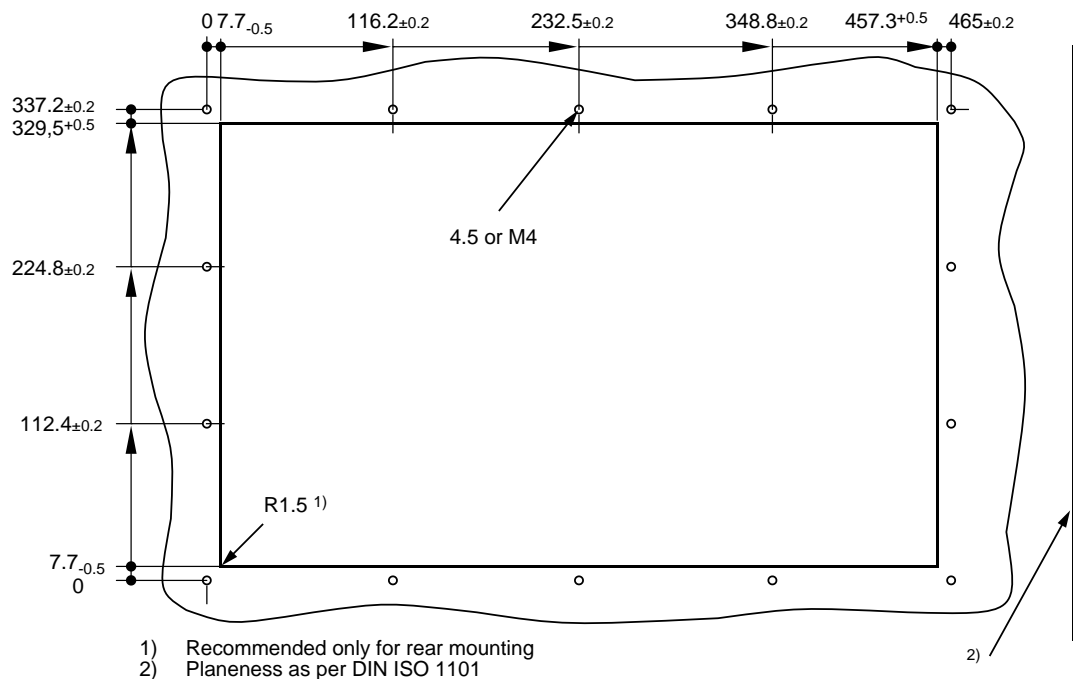

- 3) Recommended fixation screw
M4 x 16 as per SN60730
Max. torque: 1,0^{+0.5} Nm
Washer DIN 125 attached
- 4) For use under tough environmental conditions, e.g. oil mist,
use of a sealing cord with a diameter of 2mm (GWE order no. 298364) is recommended.
Max. temperature at the front: 0° ... <45°C
Max. temperature in the surrounding space: 0° ... <55°C
Temperature change 10 K/h; max. 1 K/3 min
Allowed air humidity: humidity rating F as per DIN 40040
Air inlet without aggressive gases
Degree of protection as per DIN 40050
Front: IP 54; Rear: IP 00
Max. allowed mounting position: 60° to the vertical

3.3.3 9.5", 10" and 10.4" color/monochrome slimline operator panel

3.3.3.1 Dimension drawings

Front (dimension drawing for 9.5", 10" and 10.4")

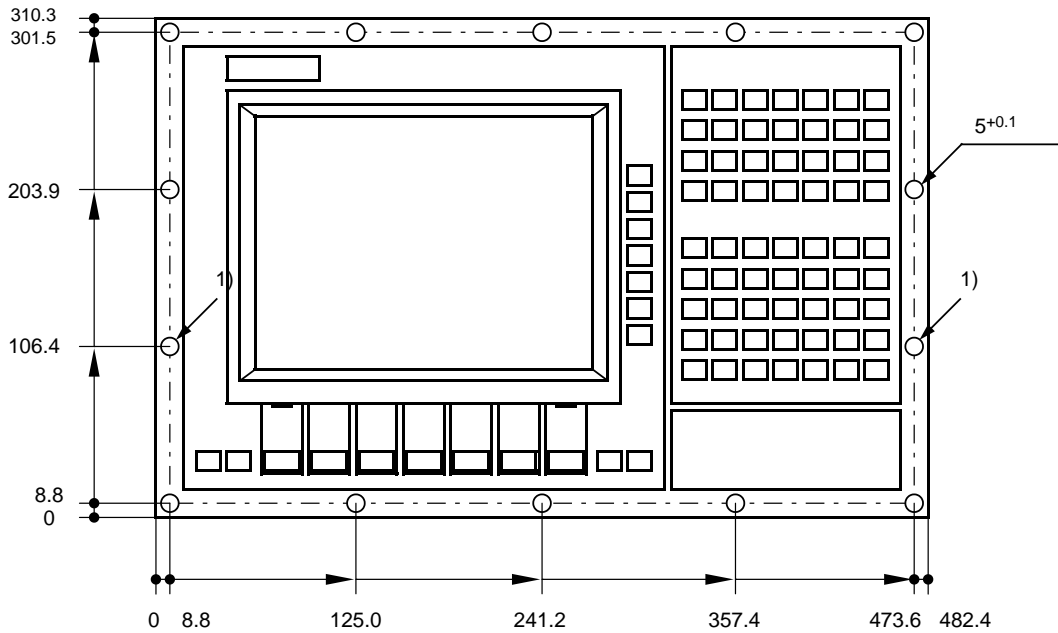

1) Note: Fit these screws first!

Rear 9.5" slimline operator panel

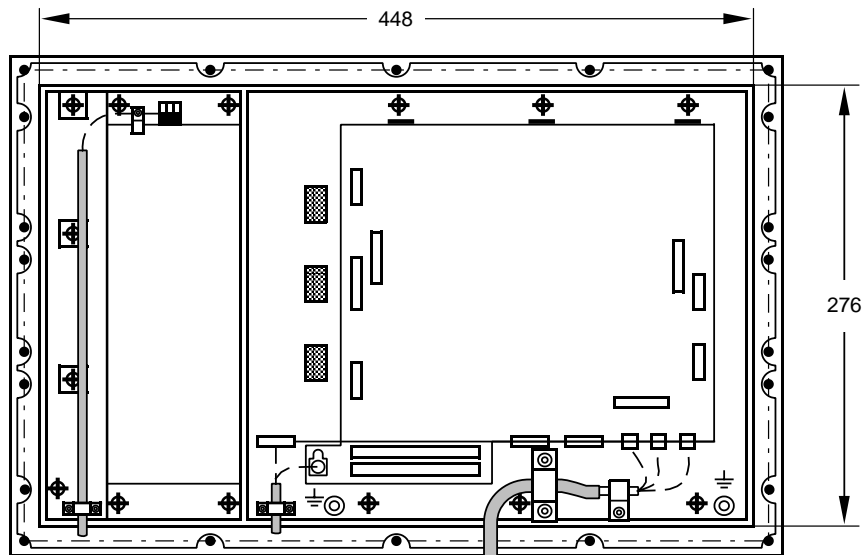

Rear 10" slimline operator panel

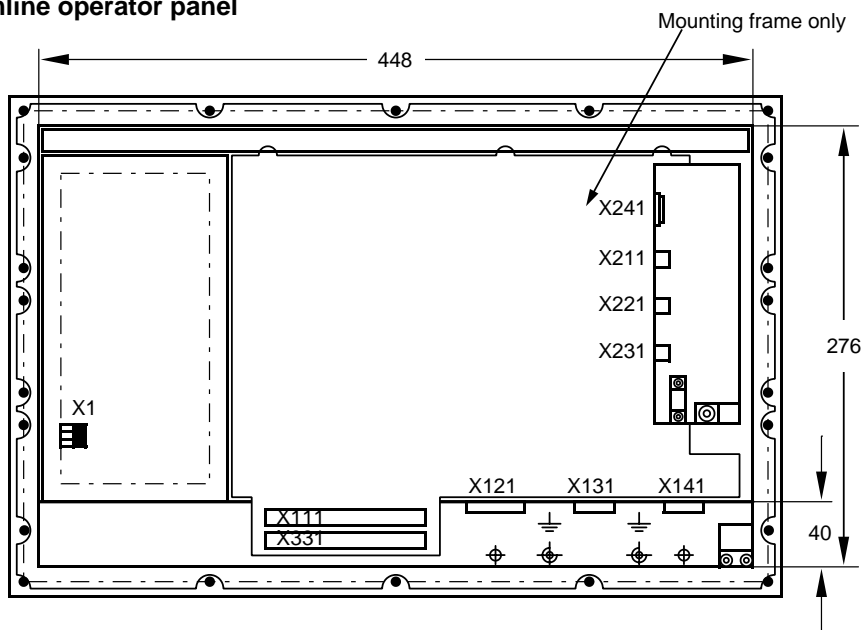

Rear 10.4" slimline operator panel

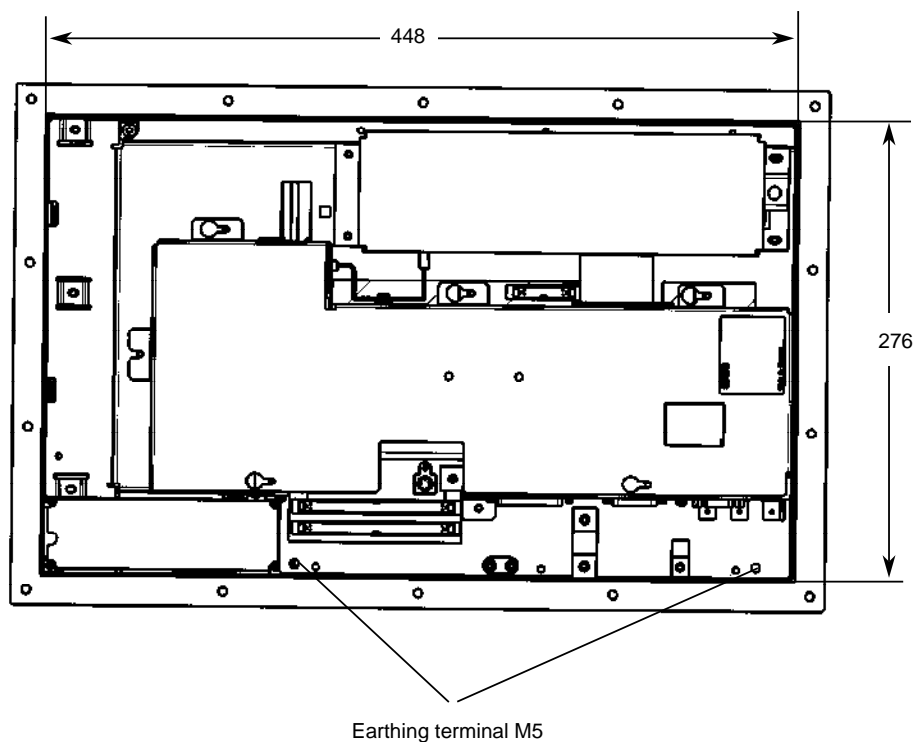

Side view

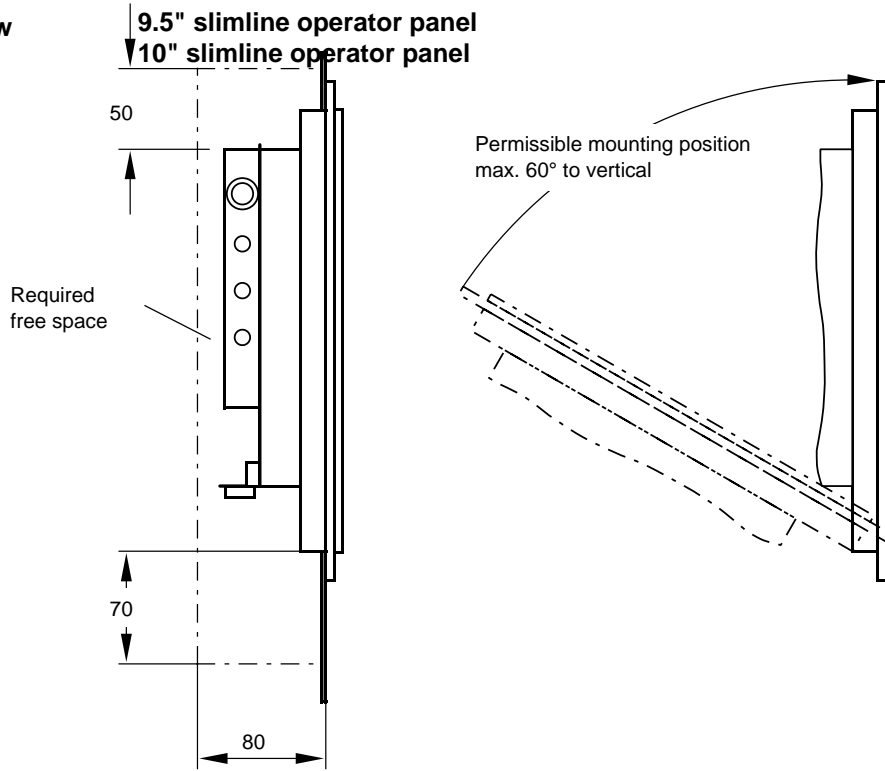

Side view 10.4" slimline operator panel

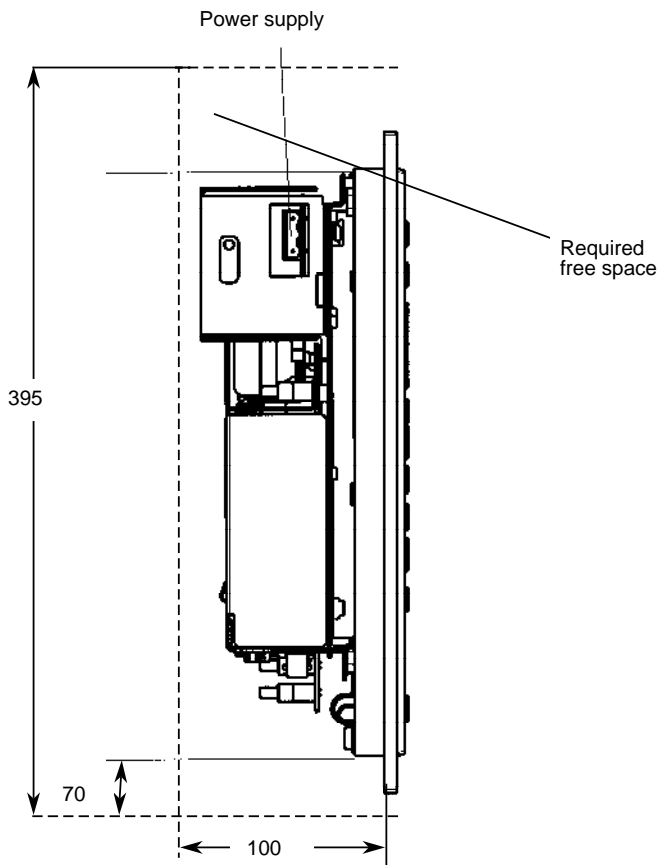

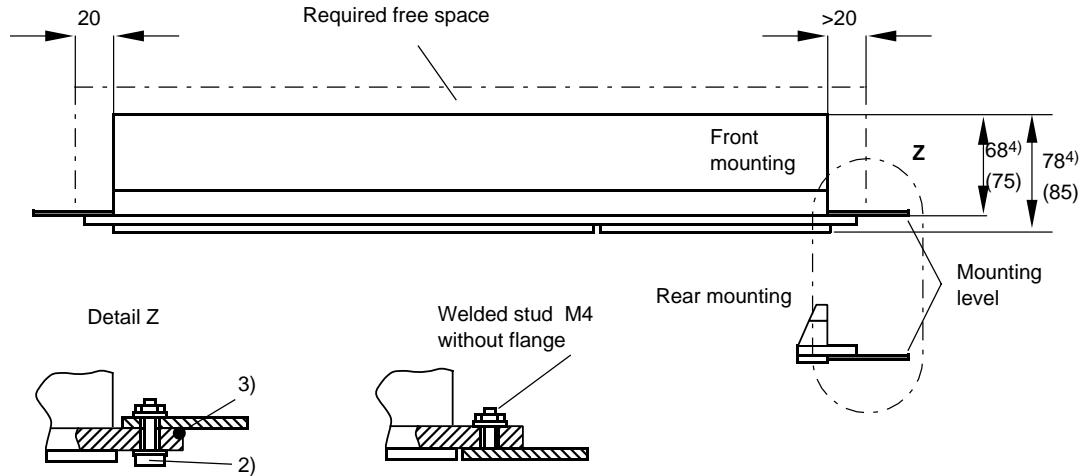
Top view 9.5"/10" slimline operator panel

- 2) Take recommended M4 screws for front mounting out of enclosed package; max. tightening torque 1.0+0.5 Nm; use DIN 125 washer for screws (customer supply)
- 3) For use under tough environmental conditions, e.g. oil mist, use of a sealing cord with a dia. of 2 mm (GWE Order No. 298 364) is recommended
- 4) Values in brackets apply to the 9.5" slimline operator panel with 24 V DC power supply unit.

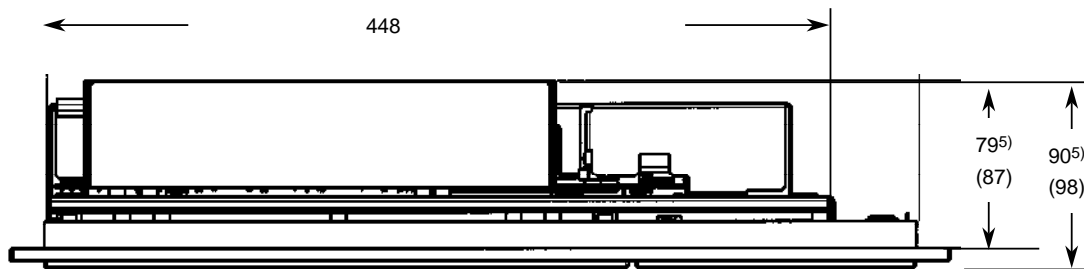
Top view 10.4" slimline operator panel

- 5) Values in brackets apply to the 10.4" slimline operator panel with 24 V DC power supply unit.

3.3.3.2 Panel cutout (9.5", 10", 10.4")

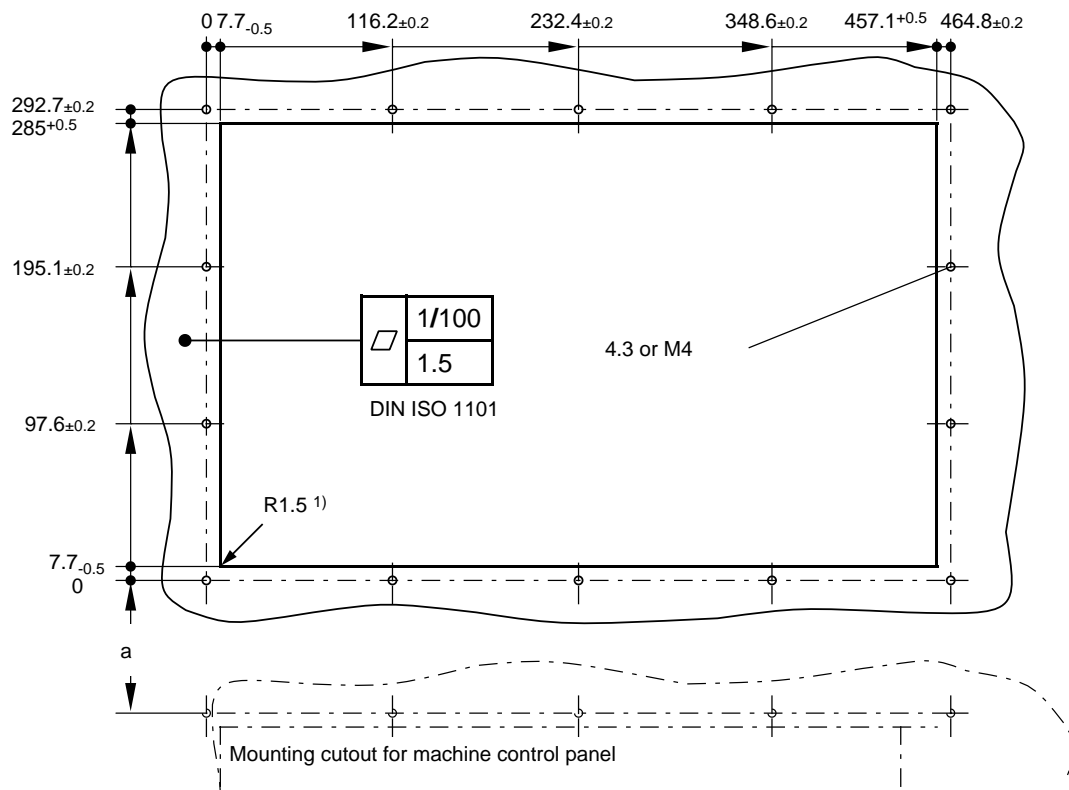

a= Spacing when mounting operator panel and machine control panel together: 18 a 32

1) Recommended only for rear mounting

3.3.3.3 Installation notes

Rear 9.5" slimline operator panel

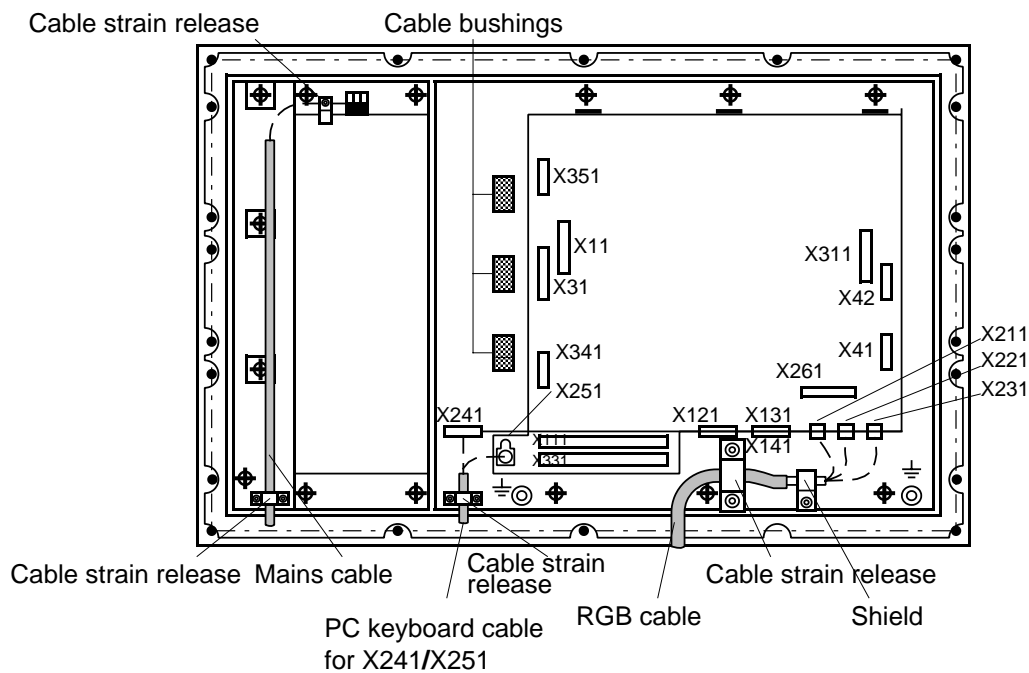

Rear 10" slimline operator panel

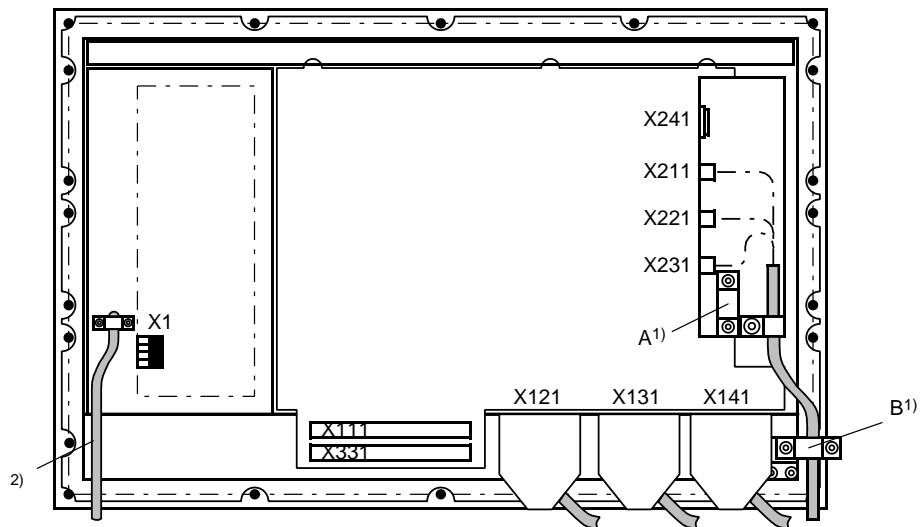

- 1) Cable grip displaced from A to B before connecting the RGB cable
- 2) Cable inserted in rubber grommet and fastened using cable grip prior to connection to power supply

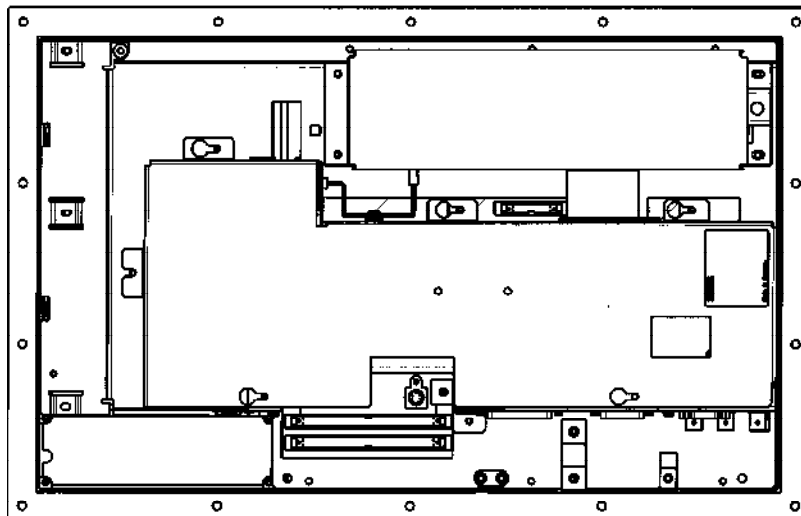
Rear 10.4" slimline operator panel**Note:**

The metallic coating on the plastic frontplate must make the largest area contact with the mounting surface of the control cabinet, that is, it must be screwed onto unpainted metal. If mounted on the inside of the control cabinet, the fixing screws must make good contact with the metallic coating.

3.3.3.4 Heat removal

The climatic data, degree of protection and power loss for the SINUMERIK 840C control are given in the technical data (see the sections entitled "Mechanical data and temperature ranges of the individual components" and "Electrical data of the individual components").

The surfaces of the front and underside have not been included in the calculation of the convection surface.

- **Heat removal by natural convection**

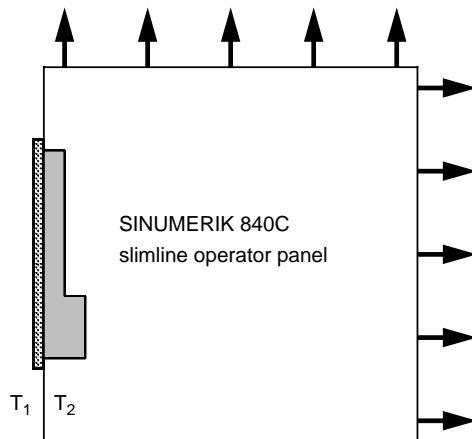

The necessary free convection surface of the surrounding space (steel or aluminium sheet 1.5 mm thick) is determined, referred to a temperature difference $T_2 - T_1 = T \approx 10$ K, approximately from:

$$A \text{ [m}^2\text{]} = \frac{P_v \text{ [W]}}{5 T \text{ [K]}}$$

Example: $T_1 = 45^\circ\text{C}$, $T_2 = 55^\circ\text{C}$
 $P_v = 50$ W

$$A = 1.0 \text{ m}^2$$

- **Heat removal by natural convection and internal air turbulence**

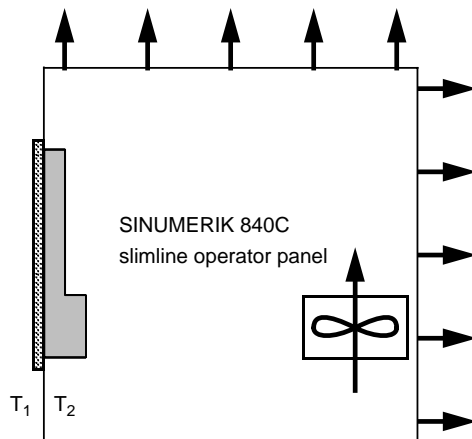

The necessary free convection surface of the surrounding space (steel or aluminium sheet 1.5 mm thick) is determined, referred to a temperature difference $T_2 - T_1 = T \approx 10$ K, approximately from:

$$A \text{ [m}^2\text{]} = \frac{P_v \text{ [W]}}{10 T \text{ [K]}}$$

Air flow through fan: 100 to 165 m³/h

Example: $T_1 = 45^\circ\text{C}$, $T_2 = 55^\circ\text{C}$
 $P_v = 50$ W

$$A = 0.5 \text{ m}^2$$

- Heat removal by open-circuit ventilation

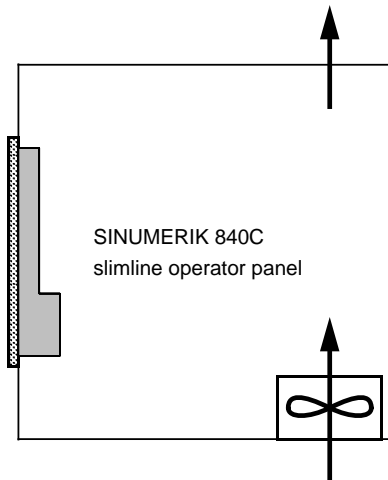

The air flow for removing lost heat is calculated from:

$$V \text{ [m}^3\text{/h]} = \frac{3.5 P_v \text{ [W]}}{T \text{ [K]}}$$

Example: Inlet air temp. 45 °C, T=10 K,
P_v=50 W

$$V = 17.5 \text{ m}^3\text{/h}$$

Note: Air filters must be provided to maintain the permissible environmental conditions given in the section entitled "Climatic environmental conditions".

3.3.4 NC keyboard

3.3.4.1 Dimension drawings

Front

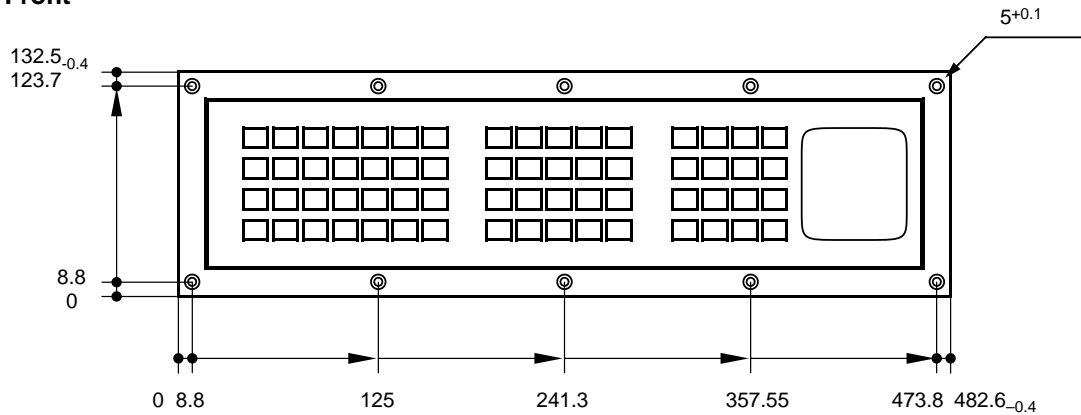

Top view (NC keyboard with keyboard interface)

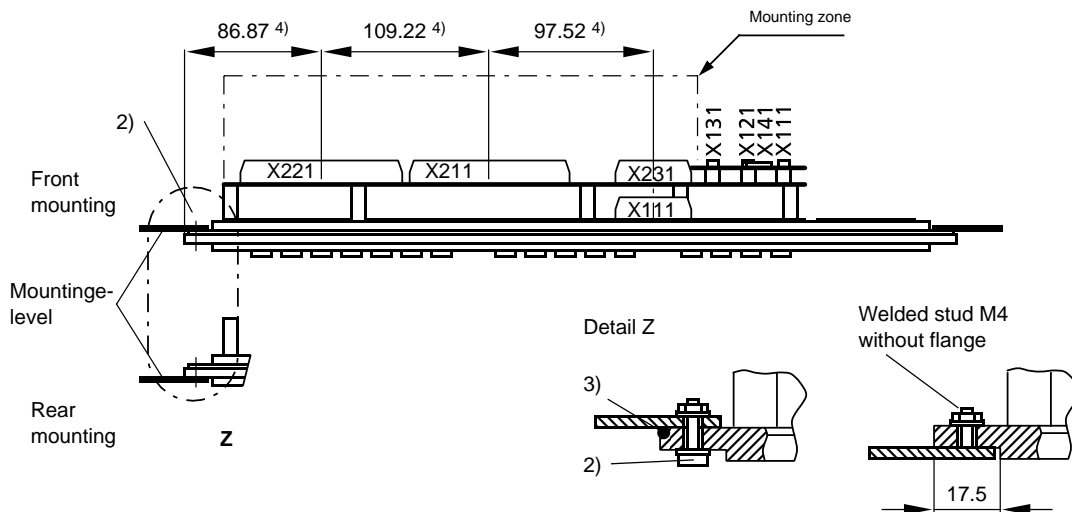

Side view

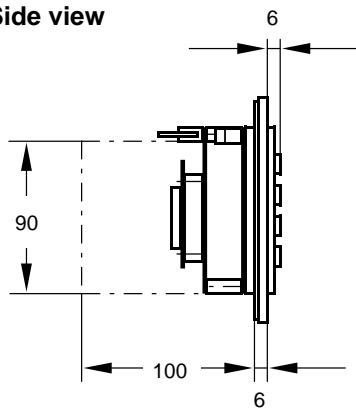

- 2) Take recommended M4 screws for front mounting out of enclosed package; max. tightening torque 1.0+0.5 Nm; use DIN 125 washer for screws (customer supply).
- 3) For use in harsh environmental conditions, e.g. oil vapour, use of a sealing cord with a dia. of 2 mm (GWE Order No. 298 364) is recommended.
- 4) Distance between connector centres

3.3.4.2 Panel cutout

NC keyboard

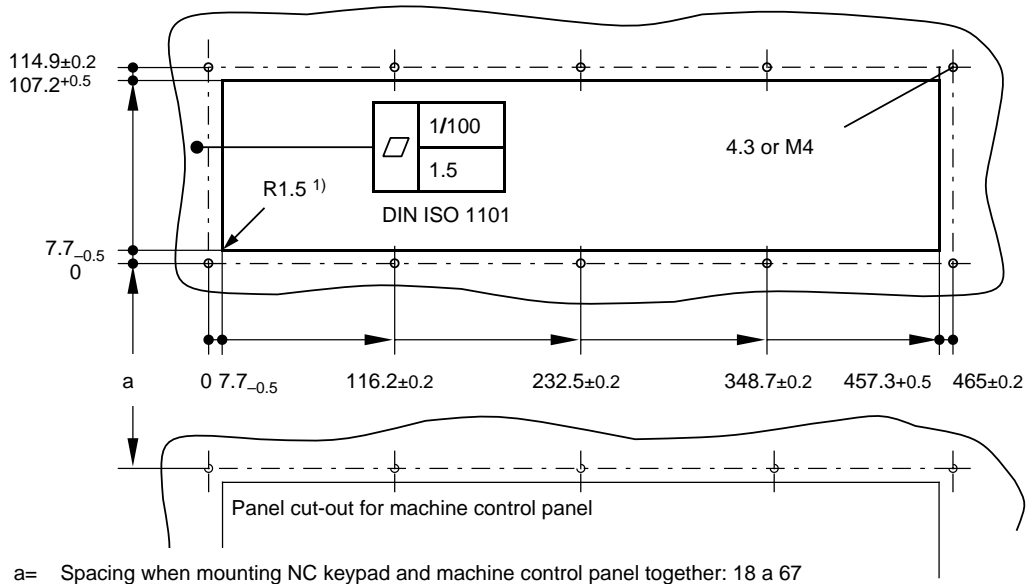

a= Spacing when mounting NC keypad and machine control panel together: 18 a 67
 1) Recommended only for rear mounting

Note:

The metallic coating on the plastic frontplate must make the largest area contact with the mounting surface of the control cabinet, that is, it must be screwed onto unpainted metal. If mounted on the inside of the control cabinet, the fixing screws must make good contact with the metallic coating.

For components without keyboard interface:

If insulated mounting cannot be avoided (mounting on painted metal), the rear of the plastic parts must be connected to the protective conductor. One of the columns intended for mounting the keyboard interface must be used for this connection.

Customer module cutout

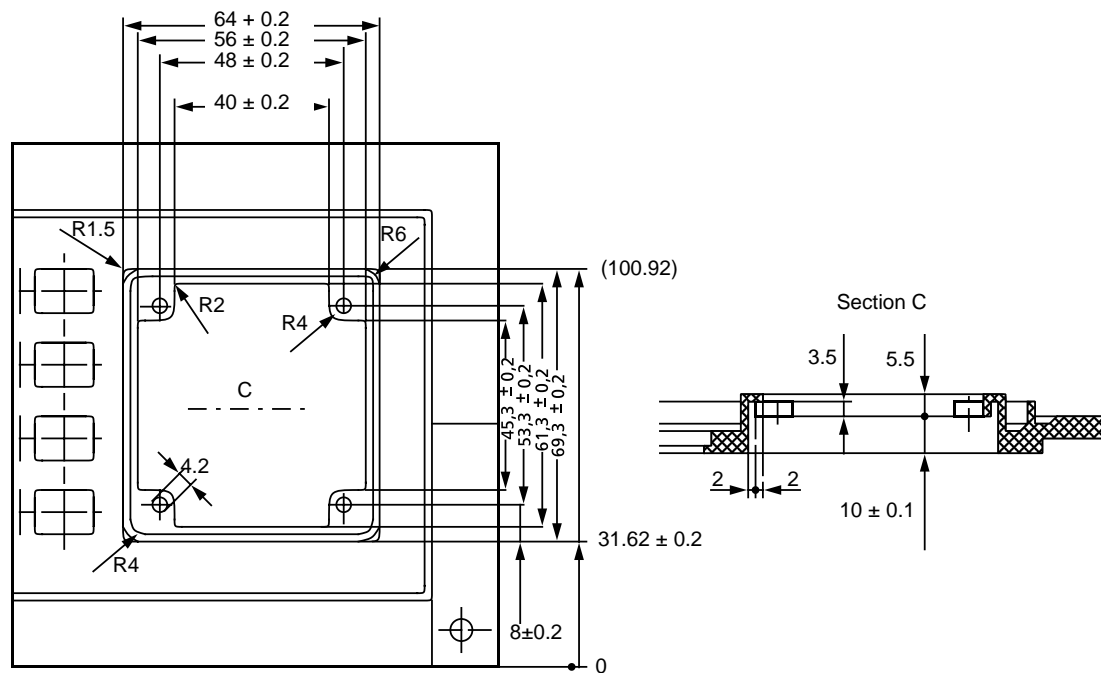

3.3.5 Machine control panel

3.3.5.1 Dimension drawings

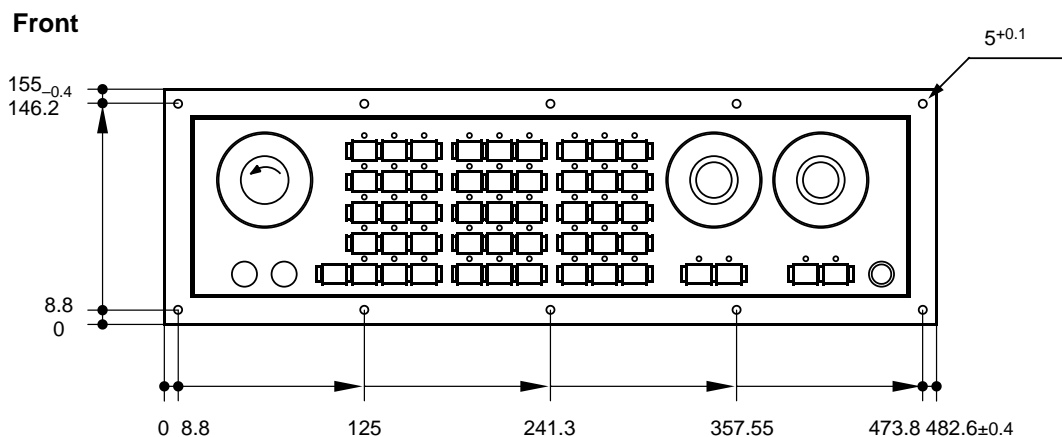

Top view (machine control panel with keyboard interface)

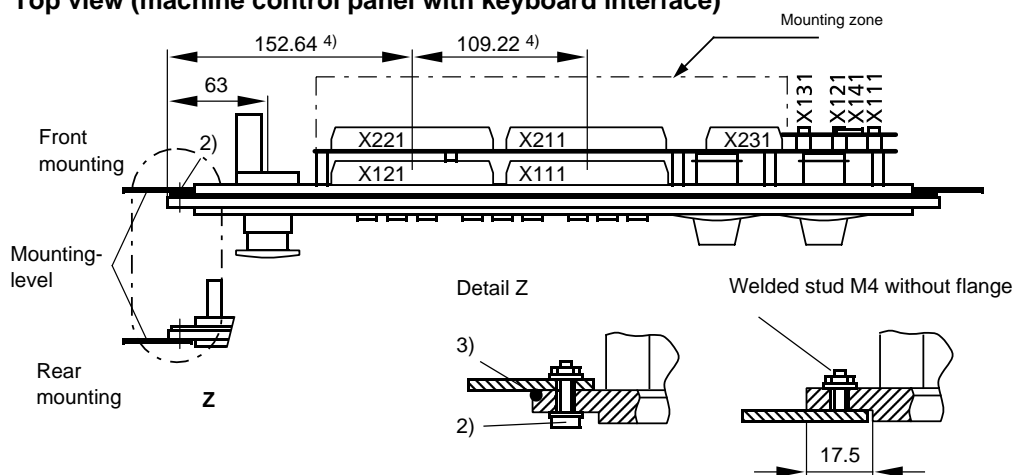

Side view

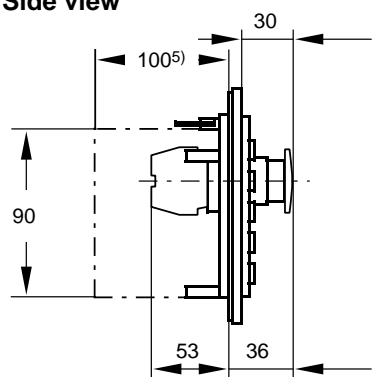

- 2) Take recommended M4 screws for front mounting out of enclosed package; max. tightening torque 1.0+0.5 Nm; use DIN 125 washer for screws (customer supply).
- 3) For use in tough environmental conditions, e.g. oil mist, use of a sealing cord with a dia. of 2 mm (GWE Order No. 298 364) is recommended.
- 4) Distance between connector centres
- 5) Mounting depth of 100 mm required only with keyboard interface

3.3.5.2 Panel cutout

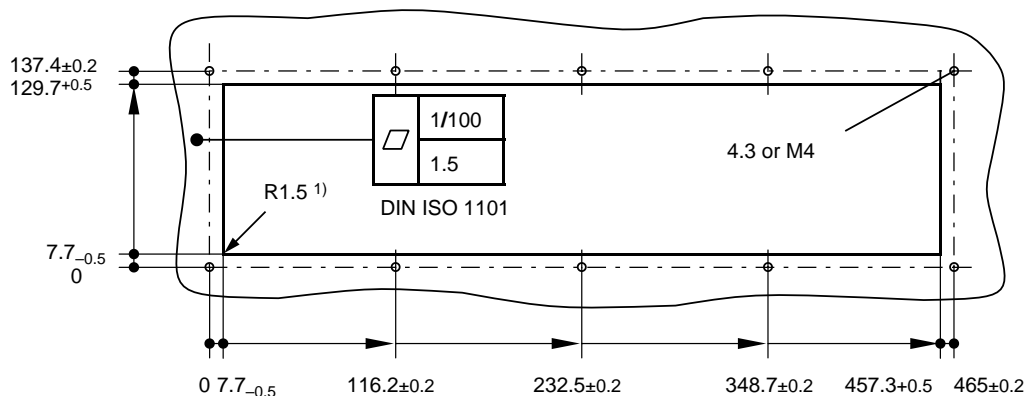

1) Recommended only for rear mounting

Note:

The metallic coating on the plastic frontplate must make the largest area contact with the mounting surface of the control cabinet, that is, it must be screwed onto unpainted metal. If mounted on the inside of the control cabinet, the fixing screws must make good contact with the metallic coating.

For components without keyboard interface:

If insulated mounting cannot be avoided (mounting on painted metal), the rear of the plastic parts must be connected to the protective conductor. One of the columns intended for mounting the keyboard interface must be used for this connection.

3.3.6 Voltage converter module UTS 840C

Recommended mounting method to pushbutton module

Voltage converter module UTS 840C is mounted on the pushbutton module with 6 spacer bolts. This lifts the pushbutton module by approx. 50 mm.

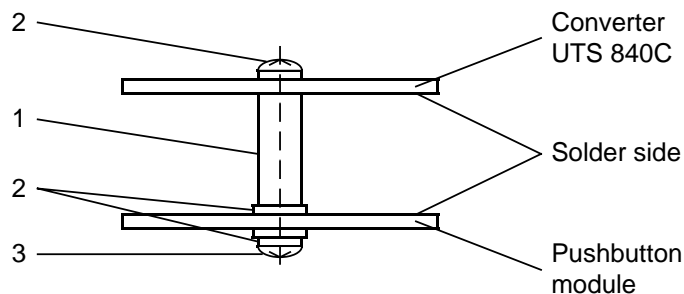

- 1 6x metal M2.5x15 spacer bolts
- 2 6x M2.5x6 cross-slotted cheese-head screws
- 3 12x M2.5 plastic washers

3.3.7 Central controller

3.3.7.1 Dimension drawings

Front view (12 slots)

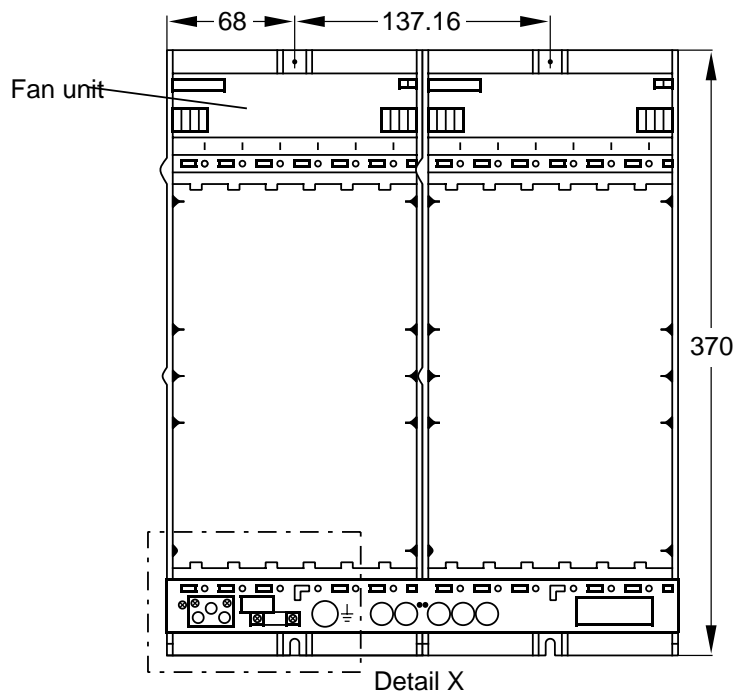

Side view

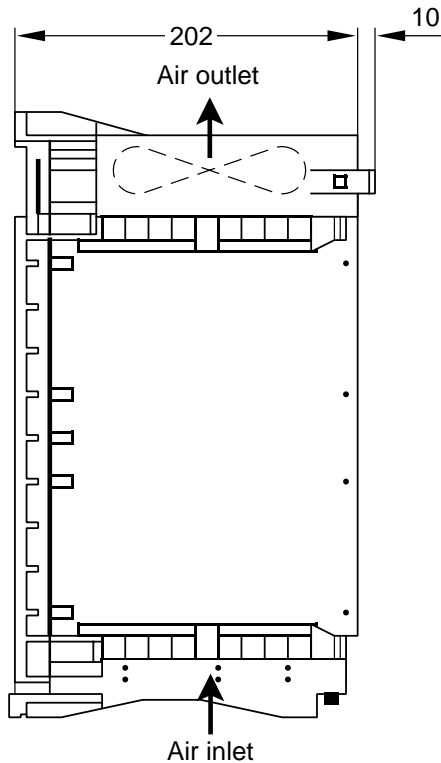

Front view (18 slots)

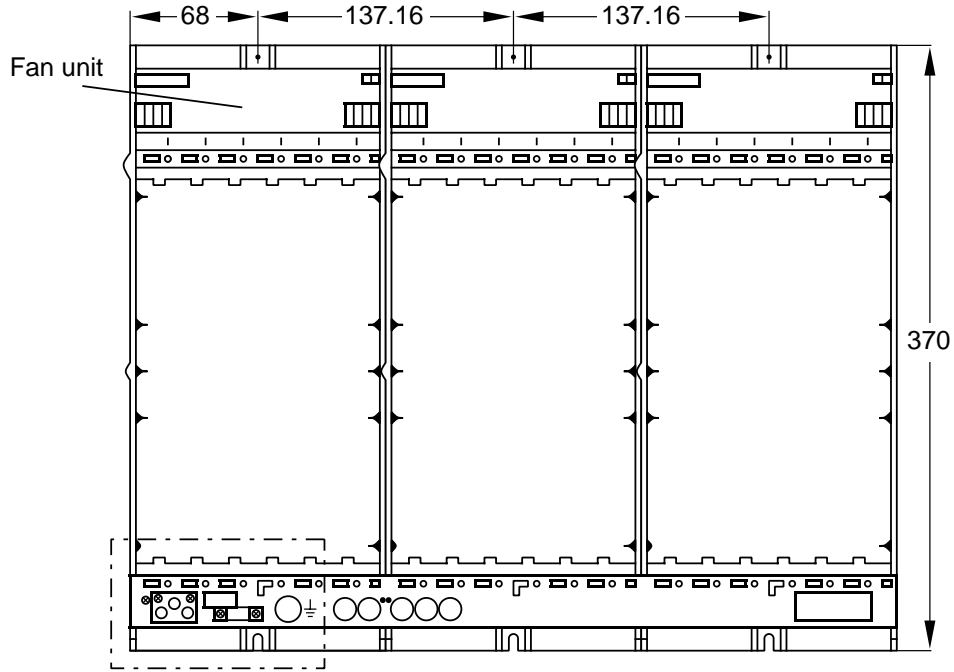

Detail X (see following page)

Rear view

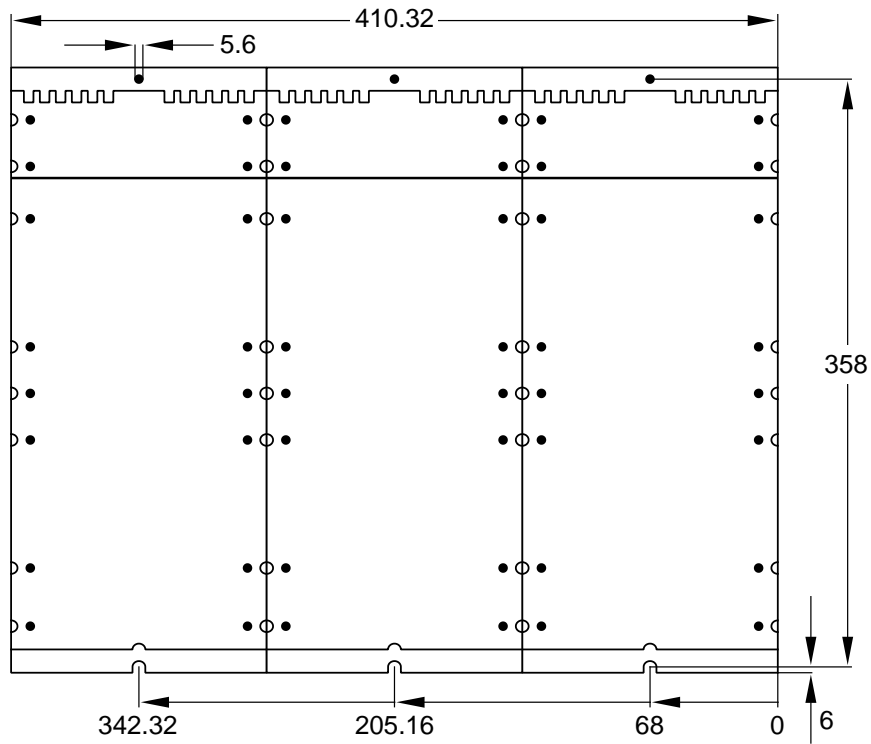

Front view (18 slots + 3 AT slots)

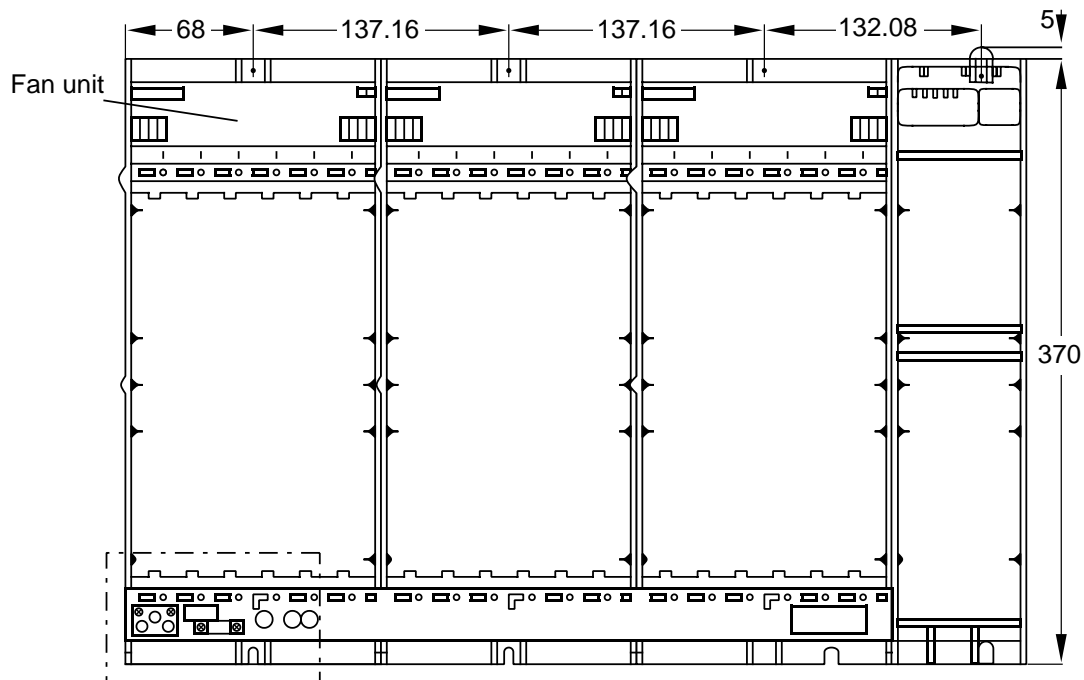

Detail X (see following page)

Rear view

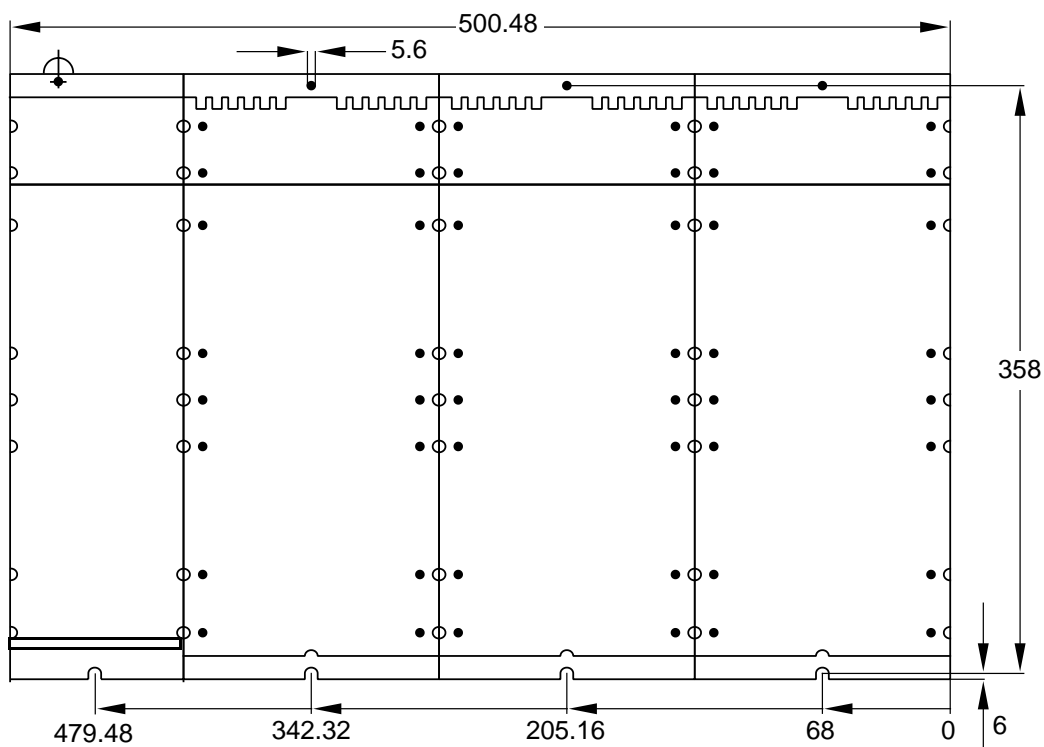

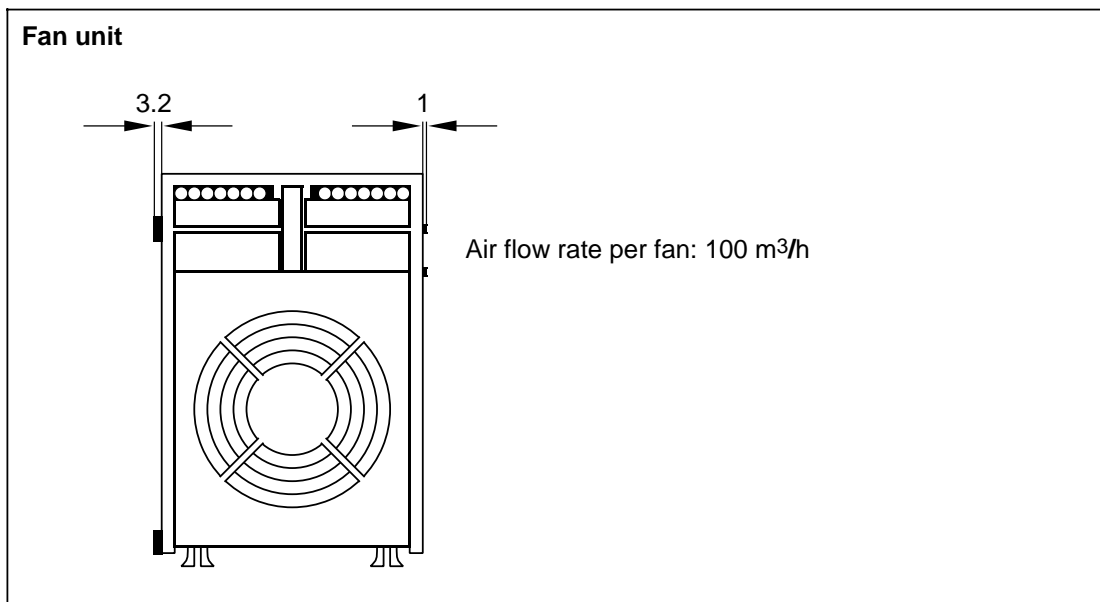
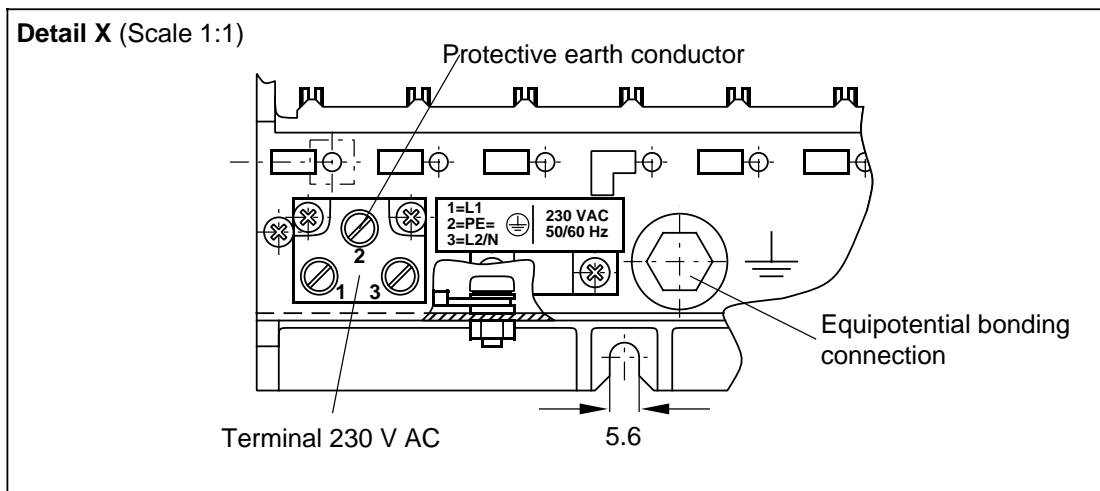

In the SINUMERIK 840C, SW 1, the EPROM submodule is plugged into the NC CPU 386 DX. The mounting depth thus increases to 312 mm.

When configuring the switchgear cabinet, note that a space of 100 mm must be kept between modules and cabinet to ensure sufficient ventilation.

Installation notes

- Specifications for bolting surface for subrack

Permissible deviation from plane

- Referred to overall bolting surface: 1.5 mm
- Referred to 100 mm of bolting surface: 1.0 mm

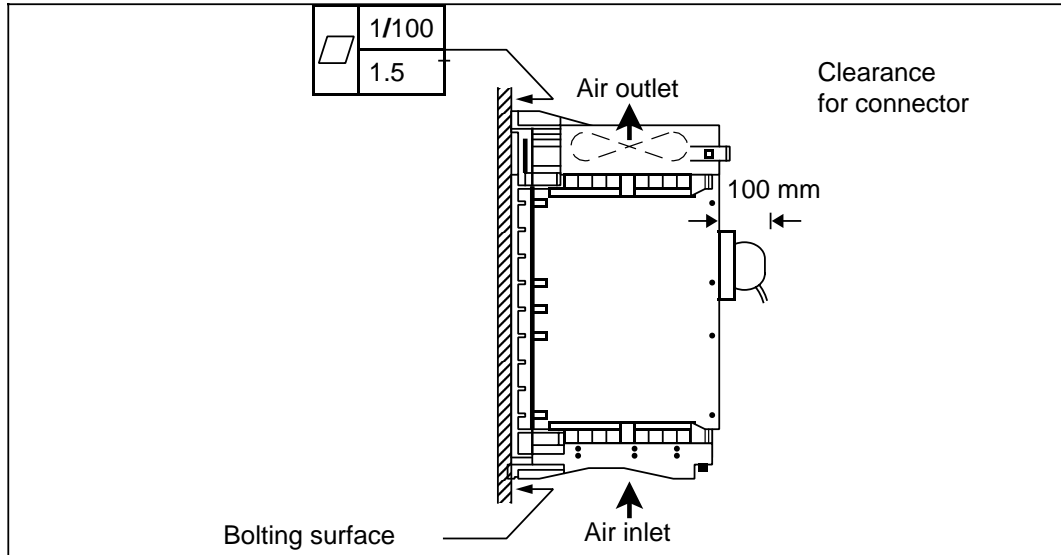

- Note the necessary minimum spacings both above and below the fans: 50 mm

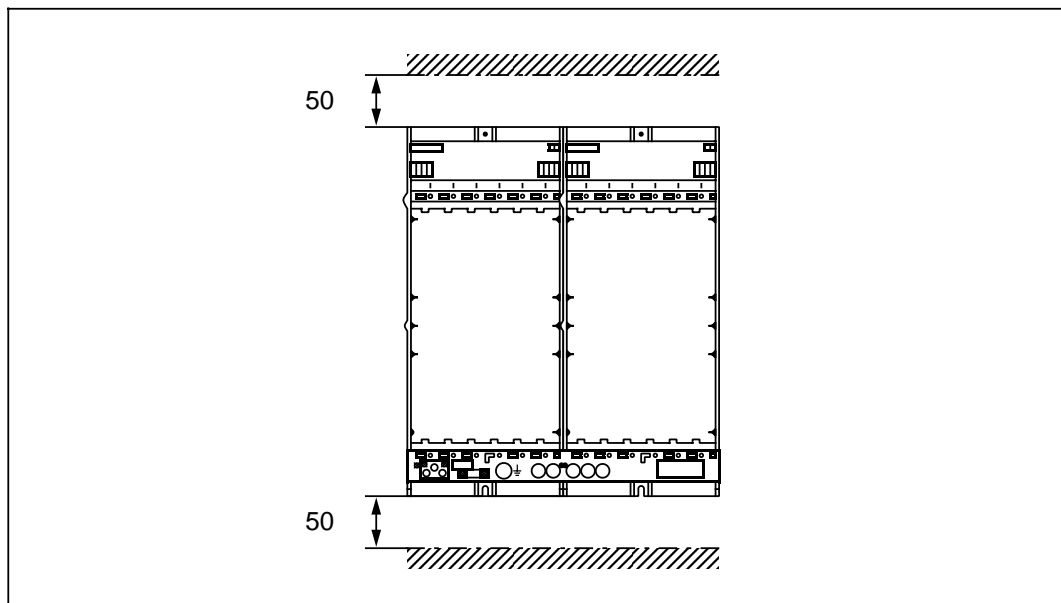

- Mounting regulations

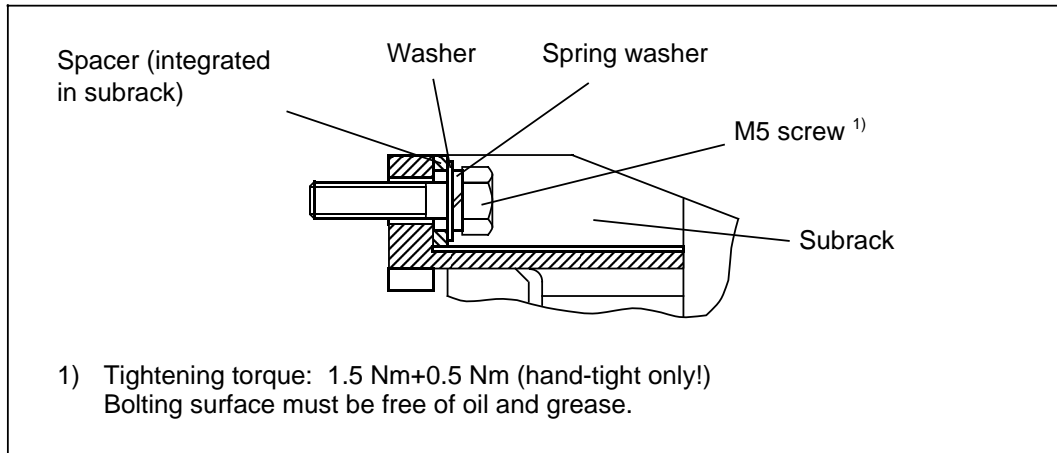

The mounting components are not part of the scope of supply of the subrack.

3.3.7.2 Heat removal

The climatic data, degree of protection and power loss for the SINUMERIK 840C control system are given in the technical data (see the sections entitled "Mechanical data and temperature ranges of the individual components" and "Electrical data of the individual components").

Module heat removal

- The individual modules are cooled with axial flow fans in withdrawable units which are easy to replace.
- The axial flow fans suck in the warm air and blow it out through the top.
- The fan voltage 12 V DC, the panel approx. 1.7 W.

The surfaces of the front and underside have not been included in the calculation of the convection surface.

- **Removal by natural convection and internal air turbulence**

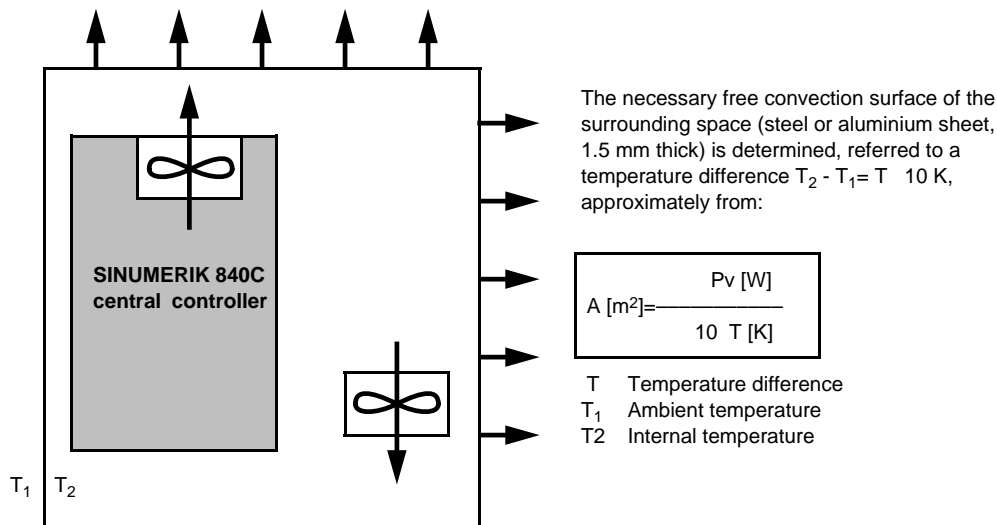

- **Heat removal by heat exchanger**

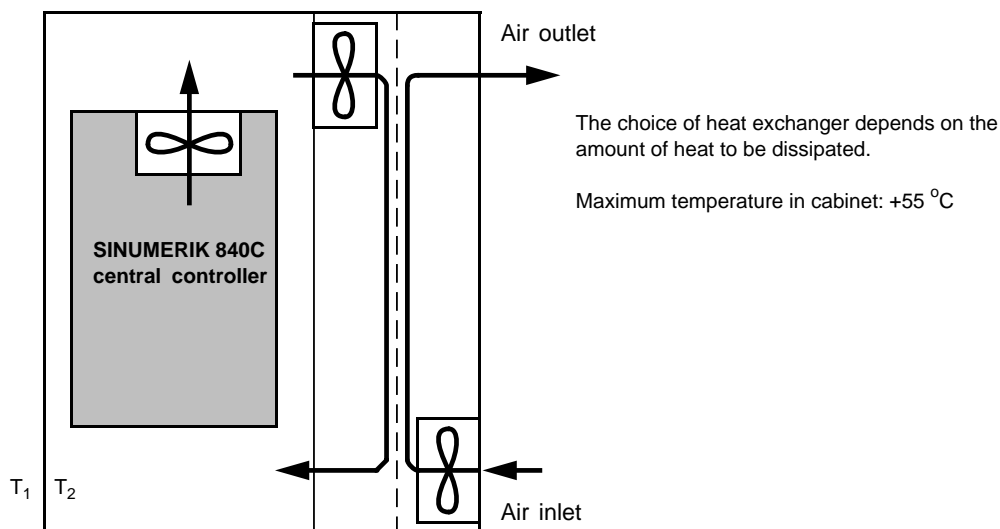

3.3.8 Floppy drive FD-E2

3.3.8.1 Dimension drawings

Front view

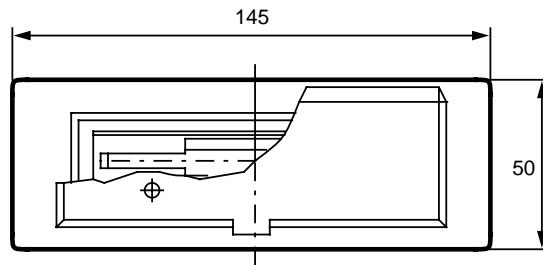

Top view

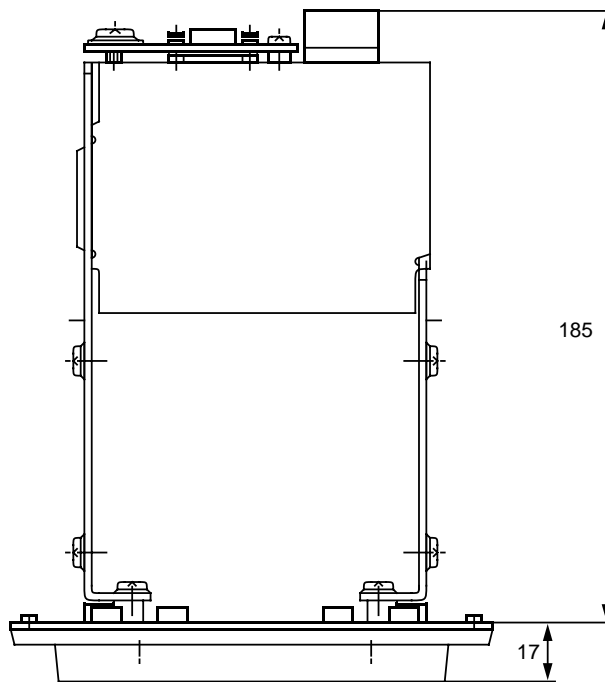

Side view

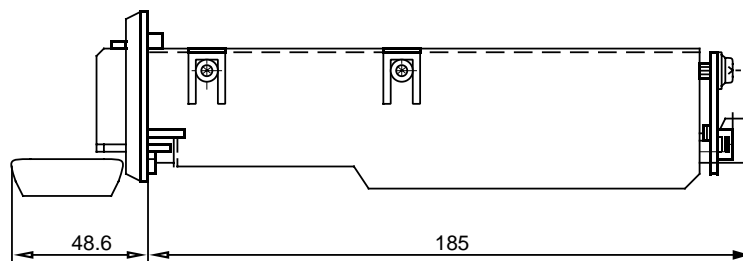

Rear view

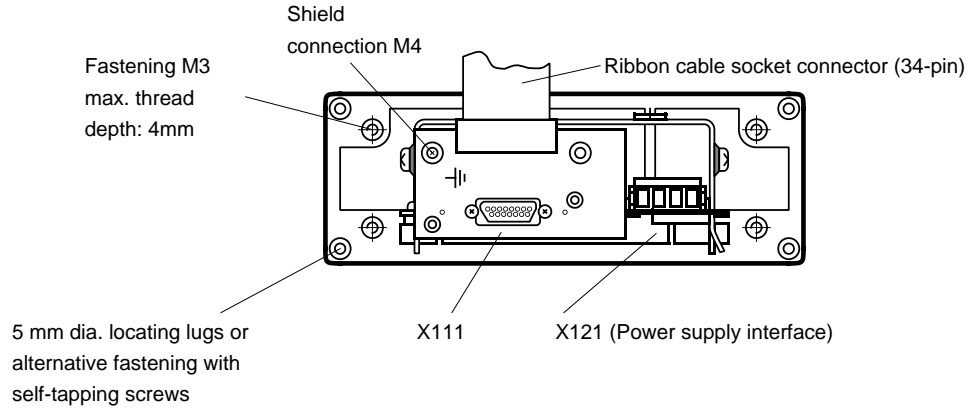

Installation notes:

- The installation location (operator panel, panel cutout) is sealed by a sealing ring that is supplied with the diskette drive (degree of protection to DIN 40050, front IP54/rear IP00).
- The diskette drive can be installed horizontally (not upside down!) or vertically.
- For dimensions of blanking plate, diskette drive, see Section 3.3.1.2.

3.3.8.2 Panel cutout

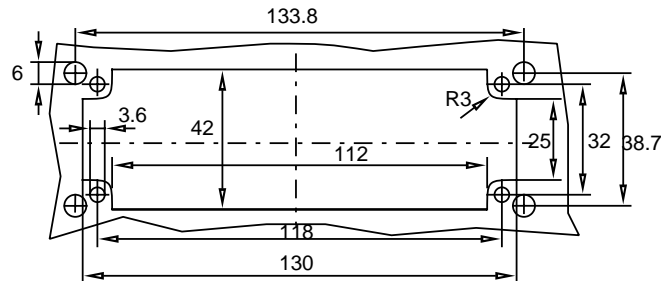

3.3.9 Cable strain relief and shielding on CPU modules

Installation of cable strain relief and shield

- for RGB cable on the MMC CPU module
- for drive bus cable on NCK CPU module

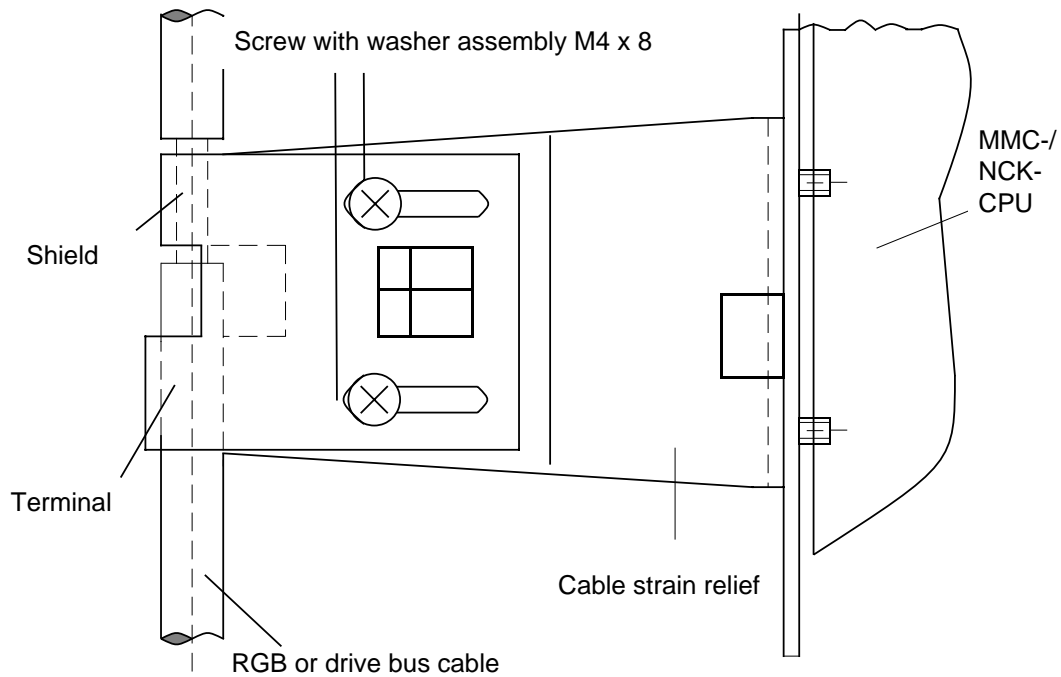

3.4 Electrical installation

3.4.1 Installation codes of practice

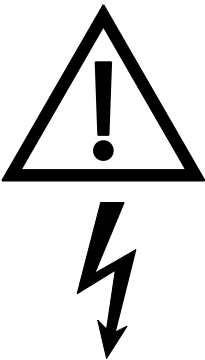
	WARNING
	<ul style="list-style-type: none"> • If the enclosure or touch guard is removed or if the system cabinet is opened, access is provided to certain, possibly live and dangerous, parts of these devices/systems. • Only qualified personnel are allowed to manipulate on this device/system. • This personnel must be thoroughly familiar with all sources of danger and maintenance measures according to the information in the documentation. • Proper transportation, storage, installation and assembly of the product, as well as careful operation and maintenance, are prerequisites of trouble free and reliable working. • The safety and accident prevention regulations applicable to each specific case must be observed. • Panel-mounting devices for enclosures or cabinets must be operated and controlled only when built in. Table top devices and portables must be operated and controlled only with their housings closed. • Where permanently connected equipment is not provided with all-pole mains disconnecting switches and/or fuses, the building installation must include a mains disconnecting switch or fuses; the equipment must be connected to a protective earth conductor. • Connection/disconnection conditions Every machine must be equipped with an easily recognizable device (e.g. to EN 60947) with which the equipment can be disconnected from the power source. It must be possible to lock this device. It must be possible to discharge any residual or stored energy without any danger. The following deviations from the above requirements are permitted: it is permissible that certain circuits are not disconnected from their power source, for example, to ensure that parts remain in their position or back up data and for lighting and power point circuits. In this case, special precautions must be taken to ensure the safety of the operating personnel, for example, warning notices on the equipment and notes in the technical documentation. • Where equipment has a permanently connected cable at the equipment end and a plug at the other end and all pole mains disconnecting switches, the earthed socket outlet for the device must be located in its vicinity and be easily accessible. • In the case of equipment operated from the mains supply, it is important to check that the set nominal voltage range corresponds to the local mains voltage before starting up. • With 24 V power supplies, safe electrical separation of the extra-low voltage must be ensured. Use only power supply units manufactured to EN 60204 T1 and VDE 0160. • Emergency stop devices to EN 60204 Part 1 must remain effective in all operating modes of the automation equipment. Resetting of the emergency stop devices must not cause any uncontrolled or undefined movements. • The system is designed for a high-voltage test of 1.1 kV AC.

***In the operational state, protection against direct contact
is provided by the device's suitability for installation
in closed electrical operating areas
(DIN VDE 0160, Sections 5.5 - 5.7).***

	CAUTION
	The modules contain electrostatically sensitive components. You must discharge your body before touching any electronic modules. The simplest way to do so is to touch a conductive earthed object (e.g. bright metal part of a switch cabinet, water pipe) immediately before touching the module

3.4.1.1 Installation of equipotential bonding conductors

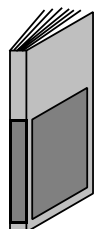

In any plant configuration, the "EMC Installation Guidelines for SINUMERIK and SIROTEC" must be observed when installing equipotential bonding conductors.

Order number: 6FC5 297-0AD30-0BP0

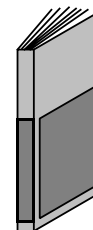

The whole installation is earthed through the earthing bar.

***CAUTION: For safety reasons you must connect all protective
conductors.***

Example of the arrangement of the equipotential bonding conductors

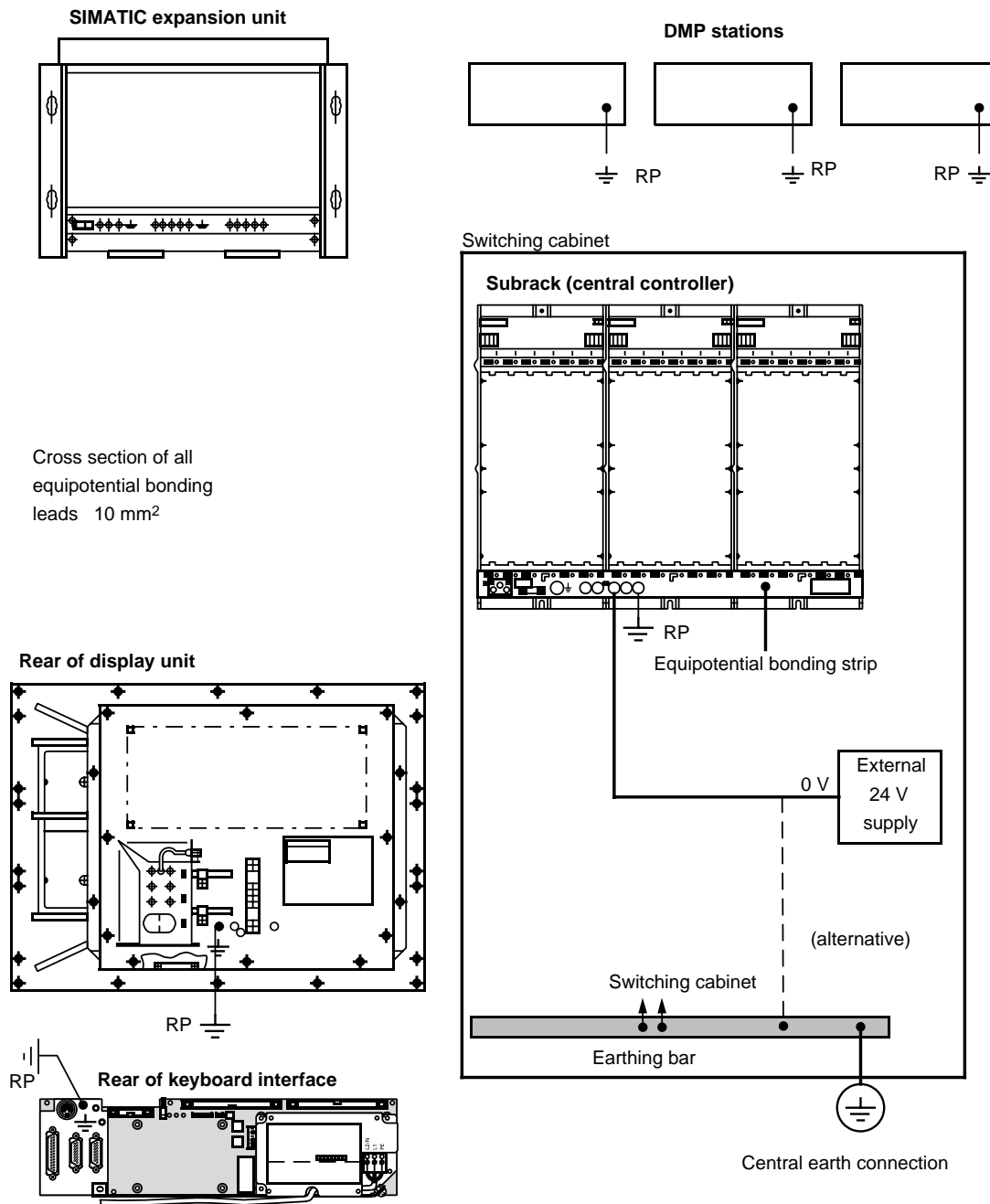

Note:

Connect the DMP stations, monitors and subracks individually and wire the shortest path to the nearest grounded surface (e.g. switching cabinet, machine housing) to divert interference. For these reference potential (RP) lines please use fine-core cables of at least 10 mm². Use a union with a large and bright surface.

Grounding concept for SINUMERIK 840C with SIMODRIVE 611D

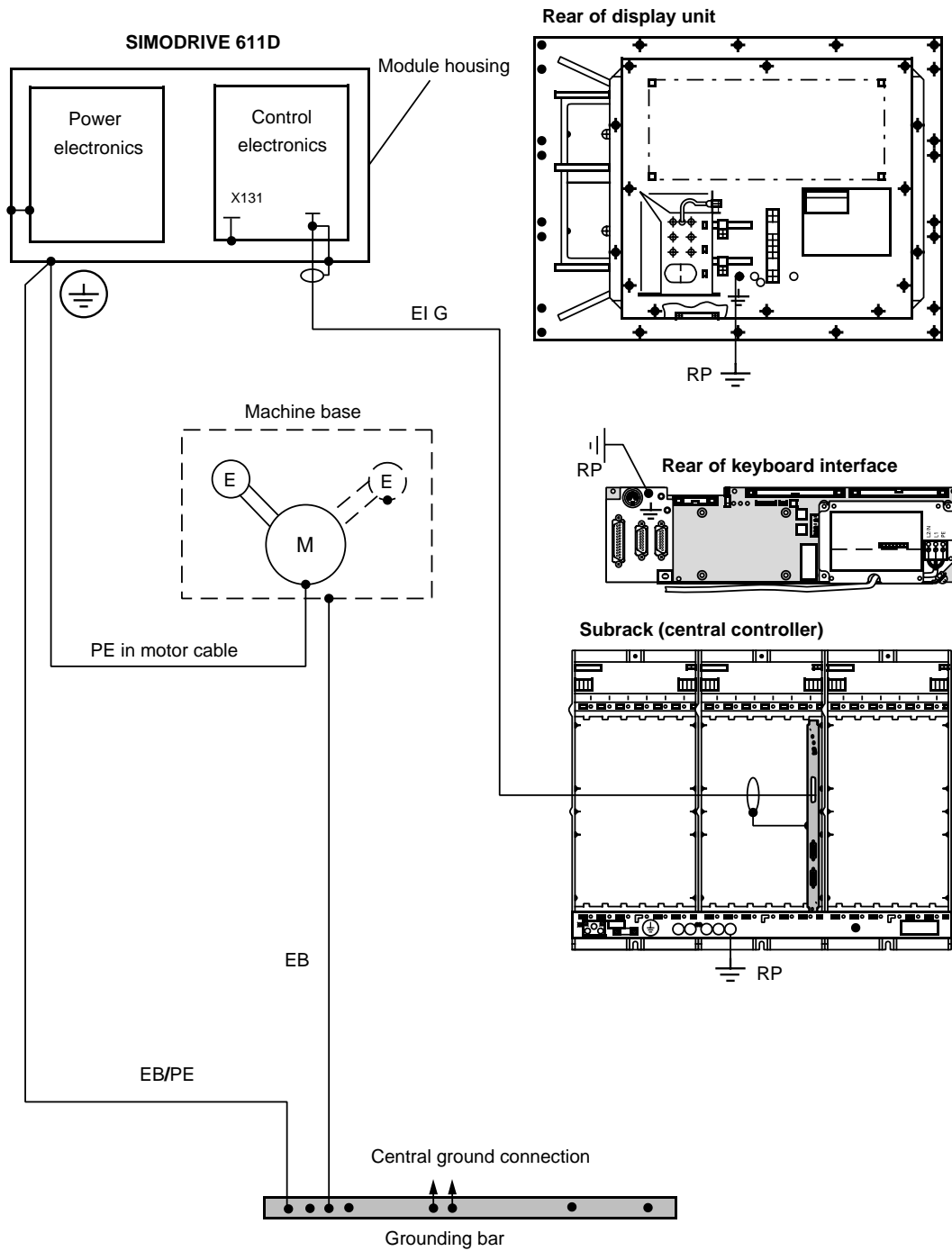

- | | | | |
|------|---|----|---|
| EI G | Electronic ground in shielded signal cable (Drive bus) | M | Motor |
| ⊕ | Grounded surface near the component | G | Encoder |
| EB | Equipotential bonding conductor 10 mm ² | -- | Option, (only with NC with own encoder) |
| RP | Reference potential conductor to the nearest grounded surface 10 mm ² , fine core Union with large and bright surface required | PE | Protective earth/protective earth conductor |

3.4.1.2 Laying signal and power lines

- **Signal lines**, e.g.:
 - Setpoint and actual value cables
 - Data lines (RS232C (V.24), RS 422, links, . . .)
 - All NC power supply signalling and control lines
 - Binary inputs and outputs
 - EMERGENCY STOP lines

- **Power lines**, e.g.:
 - Voltage power supply lines (+24 V DC,...)
 - Power supply lines (100 V AC, 230 V AC,...) from expansion units, drives, ...
 - Lines from contactors (primary circuit and secondary circuit)

To achieve the greatest possible noise immunity for the the whole system (control and machine), you must observe the following EMC guidelines:

- The signal lines must be as far as possible away from the load lines.
- Signal and load lines can cross if necessary, but never run parallel and close to each other.
- Use only the cables supplied by the NC or PLC manufacturer for the signal lines to and from the NC or PLC.
- Signal lines must not run close to strong magnetic fields (e.g. motors and transformers).
- Pulse-loaded high-current or high-voltage lines must always be laid separate from all other cables.
- If sufficient spacing cannot be achieved, lay signal lines in shielded (metal) cable ducts.
- The distance (noise radiation surface) of the following cables must be kept as small as possible:
 - signal lines and signal lines
 - signal lines and their equipotential bonding conductors
 - equipotential bonding conductors and their protective conductors.

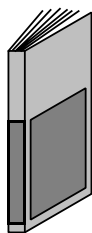

**For further notes on noise immunity measures and
connecting *shielded cables* see
"EMC Installation Guidelines for SINUMERIK and SIROTEC".
Order number: 6FC5 297-0AD30-0BP0**

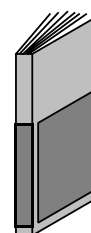

3.4.1.3 Potential connection with external 24 V power supply

When an external 24 V power supply is used (e.g. for I/O modules), the 0 V connection of the 24 V power supply must be connected to the equipotential bonding strip of the central controller. Alternatively, the 0 V connection can be connected to the earthing bar in the switching cabinet (see Section Installation of equipotential bonding conductors).

3.4.1.4 Potential connection with 230 V AC power supply

The N cable must be earthed on all components with 230 V AC power supply.

3.4.2 Shock hazard protection

All interfaces of the SINUMERIK 840C are safely isolated under the following conditions in conjunction with SIMODRIVE 611 A/D:

- Safely isolated 24 V PELV supply for all SINUMERIK 840C components
- Safe isolation of all connected non-Siemens devices.

3.5 Maintenance and servicing

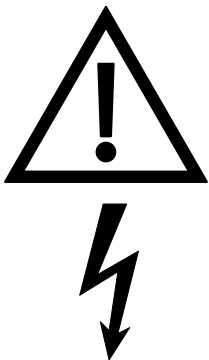
	WARNING
	<p>Hazardous voltages are present in this electrical equipment during operation.</p> <p>Failure to properly maintain the equipment can result in death, serious bodily injury or substantial material damage.</p> <p>The instructions contained in this Section and on product labels have to be followed when carrying out maintenance work.</p> <ul style="list-style-type: none"> • Maintenance must be performed by qualified personnel only. • Always de-energize and ground the equipment before carrying out any work (exception: when changing batteries). • Use only authorized spare parts. • The inspection intervals as well as the instructions for repair and replacement must be adhered to.

3.5.1 Electrostatically sensitive devices (ESD)

	CAUTION
	<p>All modules contain electrostatically sensitive devices (ESD). Damage can occur if the following precautions are not taken.</p>

Generally, electronic modules must not be touched unless work has to be carried out on them.

Before touching an electronic module, the person carrying out the work must himself be electrostatically discharged. The simplest way of doing this is to touch an electrically conducting earthed object (e. g. a bare metal part on a switchboard, water pipe).

Modules must not be allowed to come in contact with electrically insulating materials such as plastic film, insulating table tops or clothing made of synthetic fibres.

Modules may be set down only on electrically conducting surfaces.

When carrying out soldering work on modules the soldering tip must be earthed.

Modules and electronic components must always be packed in electrically conducting containers (such as metallized plastic boxes or metal cans) before being stored or shipped.

If the packaging is not conductive, modules must first be wrapped in a conducting material. Conducting foam rubber can be used for this purpose.

The necessary protective measures when dealing with sensitive electronic components are illustrated in the Fig. below.

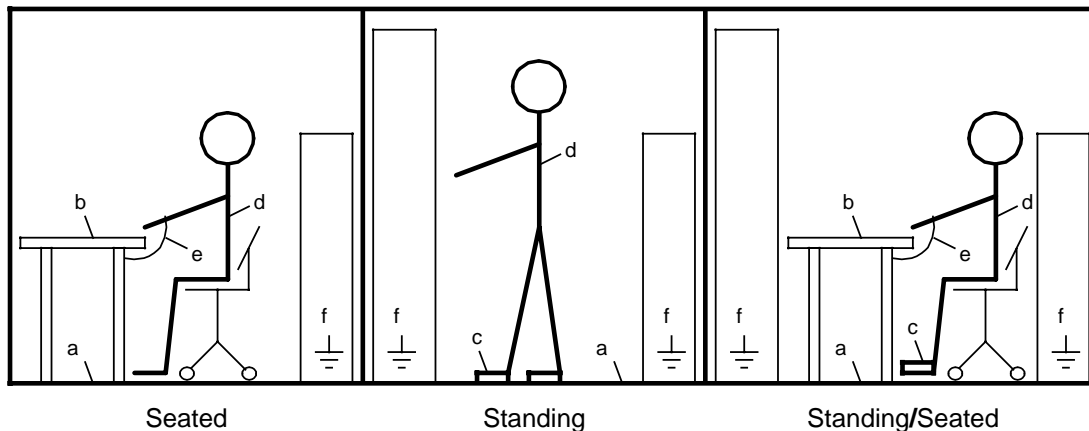

- | | |
|-------------------------|--------------------------------------|
| a = Conductive flooring | d = Antistatic overall |
| b = Antistatic table | e = Antistatic chain |
| c = Antistatic footwear | f = Earthing connections on cabinets |

3.5.2 Handling the modules

In addition to observing the ESD protective measures, the following must be observed:

	CAUTION
	<ul style="list-style-type: none"> • Modules may be inserted or removed only when no voltage is applied to them (i. e. the control must be switched off). • Signal voltages (at interfaces) may be applied only when modules are inserted. <p>The modules can be destroyed or fail prematurely if this is not observed.</p>

3.5.3 Cleaning

The front of the monitor and the surfaces of the control can be cleaned. Light dirt can be cleaned with household washing-up liquid.

Other cleansers containing one or several of the following components may also be used for a short time:

- diluted mineral acids
- bases
- alcohol
- organic hydrocarbons
- dissolved detergents
- greases and oils

3.5.4 Replacing batteries

The front of the monitor and the surfaces of the control can be cleaned. Light dirt can be cleaned with household washing-up liquid or with an industrial cleanser such as "Special Swipe". These cleansers also remove dirt containing graphite.

	CAUTION
	<p>Batteries must never be thrown into a fire.</p> <p>Batteries must not be dismantled.</p> <p>Disused batteries must be disposed of separately (special waste!). Please adhere to national regulations.</p> <p>Danger of explosion if batteries are replaced incorrectly! Do not attempt to reactivate discharged batteries by heating or other methods. Batteries must not be recharged, as this can lead to leakage and/or explosion.</p> <p>Failure to comply with these regulations can lead to bodily injury or material damage.</p>

- Store and transport the battery in its packaging.
- Check the battery for damage before installing it. Damaged batteries must not be used.

Procedure:

- Loosen screw of battery compartment lid
- Carefully remove battery compartment lid and battery
- Push battery out of battery compartment lid using a screw driver
- Remove contact strip from battery
- Connect new battery to contact strip

The back-up time of 1 year and prewarning time of 4 weeks are met if the following batteries are used.

- CSB from product version D: lithium batteries (Varta type 6127 503 074)
- CSB from product version C: alkali batteries (type 6LR61, 550 mAh)

Other back-up times:

In the case of CSB, product version D, the switching thresholds of the battery monitoring have been adapted to the lithium battery.

With the combination CSB, product version C, with lithium battery or CSB, product version D, with alkali battery, the prewarning time of 4 weeks or the backup time of 1 year may not be achieved under unsuitable ambient conditions (temperatures).

- Press battery into battery compartment lid
- Fasten lid on CSB by means of screw

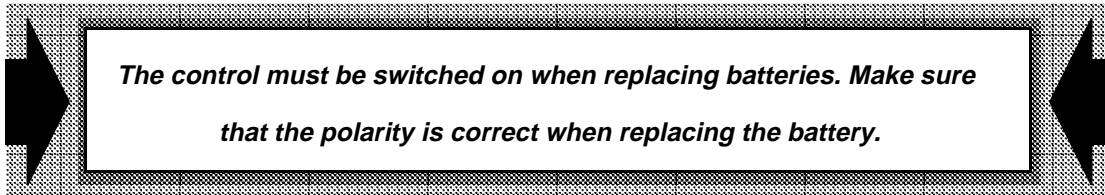

Lower-capacity batteries (R6) can also be used. However, this reduces the stored energy time and increases the risk of leaks.

3.5.5 Recommendations for hard disks

Comments on the operation of SINUMERIK components with hard disks

In machines and plants, hard disks are much more exposed to strain than those in office environment.

Essential strain factors are hereby:

- Vibrations and shock during operation of the machine (especially at writing access)
- Vibrations and shock during transport
- Wrong storage conditions and high storage time of the hard disk (component with hard disk)
- High temperatures on the hard disk
- Frequent access and ON duration
- Uncontrolled power OFF of the machine (hard disk)
- Temperature gradient hard disk

In the following, the individual measures to reduce the strain will be discussed further.

Reduce vibration and shock during transport

The MMC CPU and the spare part "hard disk without damping" (6FC5147-0AA13-0AA1) require an additional damping transport packaging.

The original packaging of the spare parts (MMC CPU or hard disk) should also be used for returns in order to avoid damage during transport.

Transport of components:

During transport typical tough conditions such as vibration, falling down and tilting over can occur. The packaging used by SIEMENS are created to withstand the following max. strain:

In transport packaging (original packaging):

1.2 m free falling or tilting around all the edges

In storage packaging (Siemens component packaging):

0.25 m free falling or tilting around all the edges

DIN EN 60721 part 3-0 and 3-2 continue to be valid:

Vibration strain: 2-9 Hz max. deflection 3.5 mm, 9-200 Hz max. 1g,
shock strain 10g/11 ms

Transport of plants:

For the transport of the components with hard disk assembled (control cubicle/machine), basically the same limit values are valid as for the transport of components. The hard disks themselves are specified for "non-operating" shocks 120 g (sinus zero to peak, 11 ms duration) and "non-operating" vibrations up to 3 g (10...500Hz).

The damping elements for the central controller do not require any further transport protection due to their robustness.

Reduce vibration and shock during operation

The hard disks are protected against vibration or shock during operation by means of special damping elements, which are standard to the central controller of the SINUMERIK 840C or integrated in the spare part component. The damping elements are optimized for a machine relevant frequency range in the following way:

- Vibrations 10 - 58 Hz, max. deflection 0.15 mm (peak to peak), from 58 to 100 Hz max. acceleration 1g
- Vibration strain max. 5 g, 15 ms.

Since May 1998, 2 GB hard disks are assembled and fixed in the MMC CPU. Due to this fact, the use of damping elements is definitely required.

The damping elements for the central controller show better features especially in acting against overloading and protect all the modules in the central controller (set of 4 damping elements with order no. 6FC5148-0AA20-0AA0). They are therefore stipulated as standard for the initial use as from May 1998.

In case of spare parts needed, the retrofit of the damping elements is highly recommended for the central controller. In cases where this is not possible (narrow mounting space), the spare part "hard disk with damping" (6FC5147-0AA13-0AA0) must be used. This component is not part of the standard range any more. It can be exceptionally delivered upon special request.

For the use of the damping elements for the central controllers 2 and 3, additional mounting rails will be required (central controller 2: 6FC5148-0AA17-0A0); central controller 3: 6FC5148-0AA18-0AA0). The mounting instructions are attached.

Limit the storage time

For components with hard disk, storage at room temperature is recommended. In case it is not possible, a waiting time in order to protect the hard disk will be required which is calculated in hours according to the temperature difference in degree K between the storage and operation place.

The allowed relative air humidity is 75 per cent on annual average. A maximum of 95 per cent on 30 days per year is allowed. Exposure to condensation is not allowed.

Hard disk manufacturers will not take over any warranty, if hard disks are stored for more than one year. Therefore we recommend to start the MMCs with hard disk one year after delivery the latest.

Reduce the temperature

The influence of high temperatures on the life time of the hard disk differs among the hard disks used so far.

Just as for most of the components of SINUMERIK, an ambient temperature of max. 55° C is allowed for the components with hard disk as well.

The measuring point for the ambient temperature is located under the air infeed in the central controller.

According to previous experience, however, we recommend to reduce the ambient temperature of the MMC and the hard disk as much as possible.

When using the spare part "hard disk with damping" (6FC5147-0AA13-0AA0) as an exception, it is recommended to use the amplified fan (6FC5147-0AA07-0AA1) for the central controller, in case the ambient temperature of the central controller can rise above 45° C.

Watch the mounting position

The mounting position of the hard disks used so far, does not have any influence on their life time according to the manufacturer's specifications. For new hard disks, any information regarding changed conditions will be available in time.

Limit the access to the hard disk and the ON duration

An essential factor for strain upon the hard disks are writing and reading access, especially in connection with vibration and shock during part processing on the machine.

In order to avoid this, the frequency of accessing the hard disk during part processing should be reduced as much as possible by measures taken in hardware and software.

The hard disks currently used automatically switch to a standby mode if they are not addressed for 109 minutes.

Very often, writing access to the MMC CPU is automatically done by recording alarms and messages. This can be or is reduced by the following settings:

Software measures < SW 6.1:

According to the basic setting in the software versions < 6.1, most of the alarms and messages are written on the hard disk. Writing access can only be limited by changing entries in the configuring file of the MMC.

For doing so, entries in the code words PROTMASK1 and PROTMASK2 in the configuring file KONFIG shall be changed in a way that either none or only the most important alarms and messages are written in the alarm log 1 and 2 of the hard disk during part processing.

The procedure is described in detail in the start-up instructions (6FC5197- AA50-0AP0) in chapter 4.4.2 "Configuring file KONFIG" and in chapter 4.4.2.2 "Format for log masks".

Software measure as from SW 6.1 and 5.8:

The alarm logs are stored in the basic setting of Regie\KONFIG in the RAM only and written on the hard disk of the MMC CPU by means of the following operational actions:

- Softkey "save on disk" in the basic menu of the diagnosis area
- Show a log
- New display of a log

Direct writing on the hard disk of the MMC CPU can be reactivated by entering (PROTMODE DISK) in the configuring file of Regie\KONFIG. Thereby, a compatible behavior as valid for the system software < SW 6 can be generated.

Software measures as from software 6.2:

As from SW 6.2. there is a cache for alarm and message texts.

By presetting the Regie\KONFIG, this cache holds the texts of the last 50 alarms in the RAM. By entering (MELDCACHE<n>) in the configuring file (Regie\KONFIG) the number of texts can be changed. It is to be considered that each alarm text in the cache requires 100 byte RAM of the MMC CPU. A value should be entered which corresponds to the maximum number of alarms during normal operation. The cache can be switched off by entering (MELDCACHE 0) in the configuring file (Regie\KONFIG). Thereby, a compatible behavior as valid for the system software < SW 6 can be generated.

Measures to be taken by Windows users:

Due to the SWAP mechanism in Windows, access to the hard disk can be executed at certain constellations such as OEM applications, even during part processing.

The MMC basic software is completely loaded into the user memory of the MMC CPU during control run-up. Depending on the configuration of the memory of the MMC CPU, the following free user memory is available (SW 6.1):

Memory configuration of the MMC CPU	8 MB	16 MB	32 MB	
Free user memory, approx.		3 MB	11 MB	not yet measured

Therefore, the MMC basic software does not require a SWAP file on the hard disk. For OEM applications we recommend to use MMC CPUs with 16/32 MB in order to avoid SWAP access to the hard disk.

Hardware measures for users of graphic programming (WOP):

Graphic programming (WOP) uses a swap-out file on the hard disk at a user memory of 8 MB. We therefore recommend to generally use the MMC CPU with 16 MB RAM.

Error-free file structure and optimizing of the hard disk

Repairing and optimizing the file structure (consistency check)

Software measures as from SW 6.2 and 5.8:

As from SW 6.2 and 5.8 FlexOS and Windows, at each system run-up a checkdisk run (for SINUMERIK system software FlexOS) or a scandisk run (for SINUMERIK system software WINDOWS) is executed. Checkdisk and scandisk are executed with the parameters "automatic error correction, defective file is cancelled - memory space is released and no result log". Errors like allocation error and lost clusters are repaired.

For the SINUMERIK system software FlexOS < 6.2 and 5.8 it is recommended to possibly reduce the set period of time for checkdisk (presetting 24 hours), as checkdisk is executed at every run-up. The presetting (chkhours=24) can be changed in the menu "backup" under "setup/configure options" - "setup disk check".

For SINUMERIK system software WINDOWS as from 6.2 and 5.8, a DEFRAG is automatically executed after the software is loaded. After BACKUP a DEFRAG can be initiated in the service menu.

Defined shutdown of the control by means of software measures

In order to avoid any file inconsistencies powerdown, we recommend a defined shutdown of the control.

The following versions are available for WINDOWS as from SW 4, FlexOS as from SW 5.8 and 6.2:

- Express shutdown via PLC interface signal (see next chapter as well)
- Shutdown via softkey "End" in the diagnosis menu

Defined shutdown of the CNC by means of hardware measures (Emergency STOP and UPS)

If the machine is supplied for "instable power" applications or if their software applications cannot be secured against powerdown (e.g. data bases), we recommend an uninterruptible power system (UPS) with a power of approx. 300 W.

Two solutions are possible:

1. The powerdown message of the UPS is transferred via the PLC I/O to the MMC using the function express shutdown. After the shutdown of the applications, the UPS receives the powerdown signal on the same way back. This solution is possible with both the SINUMERIK system software WINDOWS 4.x and SINUMERIK system software FlexOS 6.2 and 5.8.
2. Communication is done via special I/Os which can be handled from the NC. The powerdown message from the UPS is transferred via the CSB (central service board) and the NC CPU to the communications buffler in the MMC CPU. After shutdown of the applications, the UPS receives the powerdown signal on the same way back. This solution will be supported by the software as from SW 6.3.

Hard disk replacement (spare parts)

Due to the wearing of the hard disks, the MMC CPUs as from the b.m. versions are prepared for the replacement of the hard disks.

As from version E 6FC5110-0DB01-0AA1, 6FC5110-0DB02-0AA1, 6FC5110-0DB03-0AA1,
6FC5110-0DB04-AA1

As from version A 6FC5110-0DB02-0AA2, 6FC5110-0DB03-0AA2, 6FC5110-0DB03-0AA3

As from July 1998 only the spare part "hard disk without damping" (6FC5147-0AA13-0AA1) will be available.

Prerequisite: central controller is mounted on damping elements.

The use of the spare part 6FC5147-0AA13-0AA0 "hard disk with damping" delivered as from May 1997, will only be allowed exceptionally and upon special request.

The spare parts contain the basic software for a restore via the VALITEK tools or via interlink, as well as the current BIOS for the possibly required BIOS upgrade which is executed automatically. The descriptions for a re-equipping are attached to the spare part.

3.6 Disposing of components

The components used in the control are electronic waste and must be disposed of accordingly. Please observe national regulations.

END OF SECTION

4 Distributed Machine Peripherals (DMP)

4.1 General

DMPs are a range of devices that allow I/O devices (e.g. digital input and output modules) to be distributed over the machine. Distributed configuration means that the SINUMERIK 840C control and the input/output points at the process level may be far apart. Those distances can be covered by a serial bus (four-wire cable).

Distributed machine peripherals can be connected either instead of or in addition to the inputs/outputs in the central controller (e.g. MIXED I/O module). Inputs/outputs of the DMP can be accessed in the PLC program just like central I/O devices.

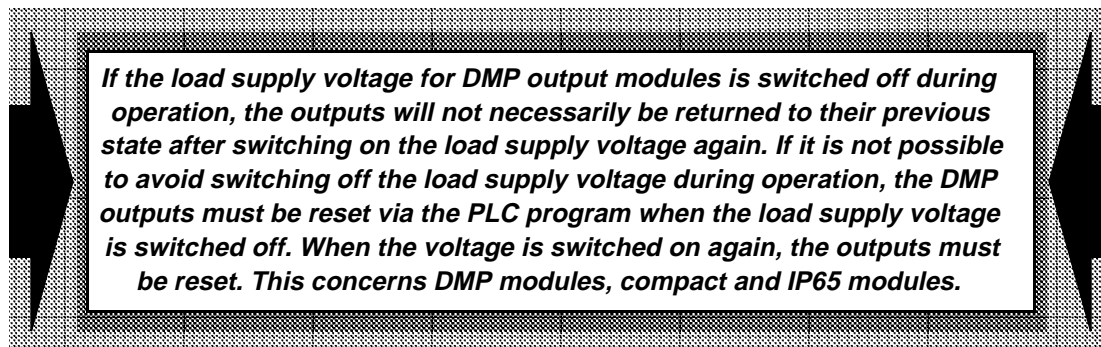

DMPs operate on the MASTER/SLAVE principle with the distributed I/O modules constituting the slaves. The master is in the central controller. The PLC interface (or with SW3 and higher the PLC CPU 135 WD) and the DMP interface are available as link modules in the central controller. Each of these modules has MPC interfaces for linking distributed machine peripherals. The individual DMP stations are connected in series by cable and then to the link module via the MPC interfaces. A series of DMP stations like this is called an MPC line. As two MPC interfaces connected in parallel are provided on the link modules for each MPC controller, cabling can be facilitated by dividing the MPC line into two. Each of these is then connected to one of the two MPC interfaces. One station number must be assigned to each of the DMP stations. The DMP station numbers can be assigned in any order. Each of the DMP station numbers can be assigned once per MPC line.

You set the DMP station numbers at the rotary switch on the DMP station.

Addressing (setting the DMP station number):

Rotary switch position	DMP station number
F	Module deactivated
E	1
D	2
⋮	⋮
0	15

Note:

Configuring is possible either via machine data or data blocks (see Interface Description, Part 1). Mixed configuring is not possible, i.e. once you have decided upon one configuring method, the machine control panel, the handheld operator panel, etc. must be linked in accordance with the configuring type. However, this does not apply to the central interrupt byte which is always configured via the PLC MD 30. In contrast to the machine data configuring method, free configuring via data blocks is less restrictive and does not require any particular order of slot and address assignments (see Interface Description Part).

4.2 Examples of application

Various DMP stations are available (for explanation see the section entitled "Terms and Abbreviations"):

- DMP terminal block, can be equipped with
 - DMP module with 16 inputs and outputs
 - DMP module with 32 inputs
- DMP compact terminal block, can be equipped with
 - DMP compact module with 8 outputs (output load: 2A)
 - DMP compact module with 16 outputs (output load: 0.5A)
 - DMP compact module with 16 inputs
 - DMP compact module ANALOG OUT
 - DMP compact module ANALOG IN
- DMP terminal block with DMP module in IP 65 version
- Machine control panel (MPC)
- Hand-held unit with distribution box, these together count as one DMP station.

Note:

The DMP stations and station numbers can be placed in any sequence in the MPC line.

PLC interface or PLC-CPU 135 WD connection overview

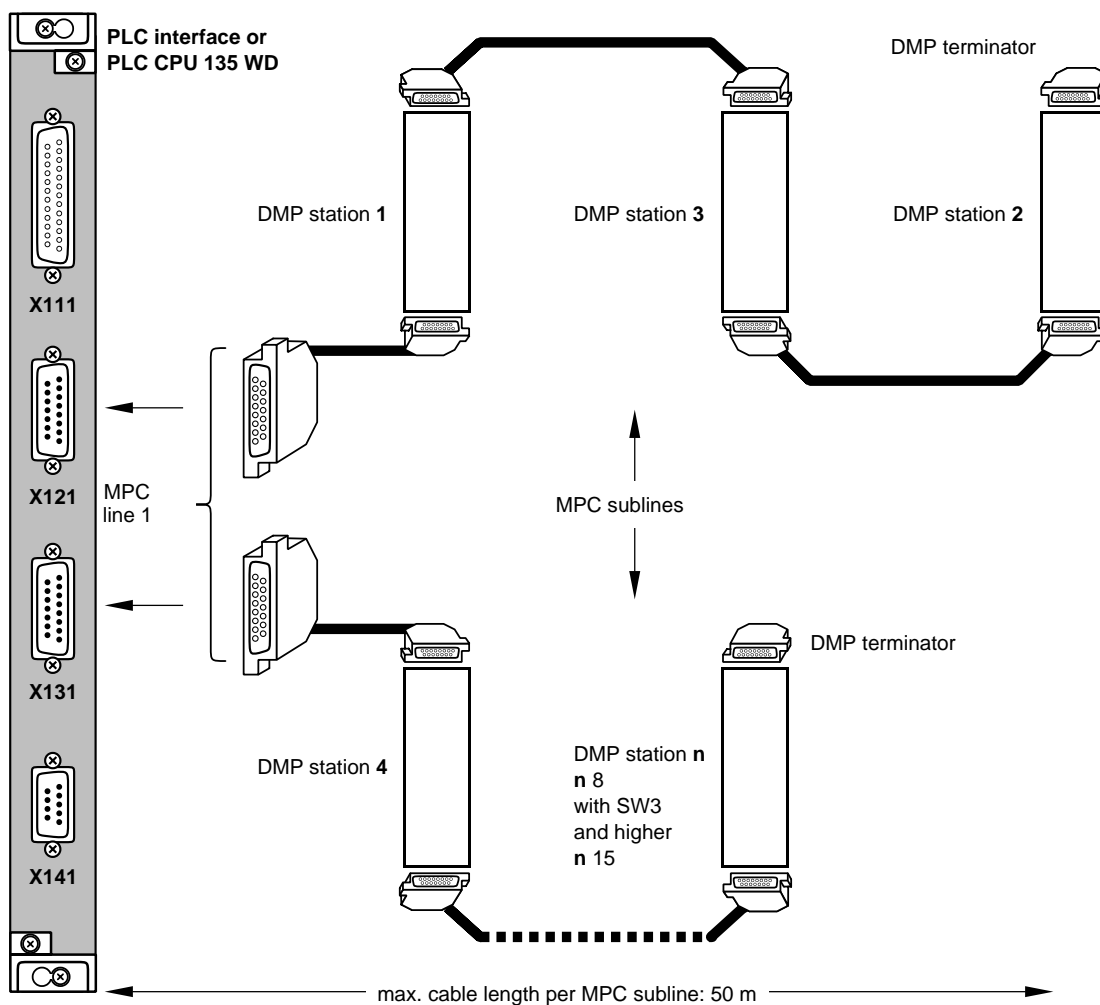

PLC interface and PLC-CPU 135 WD connection diagram

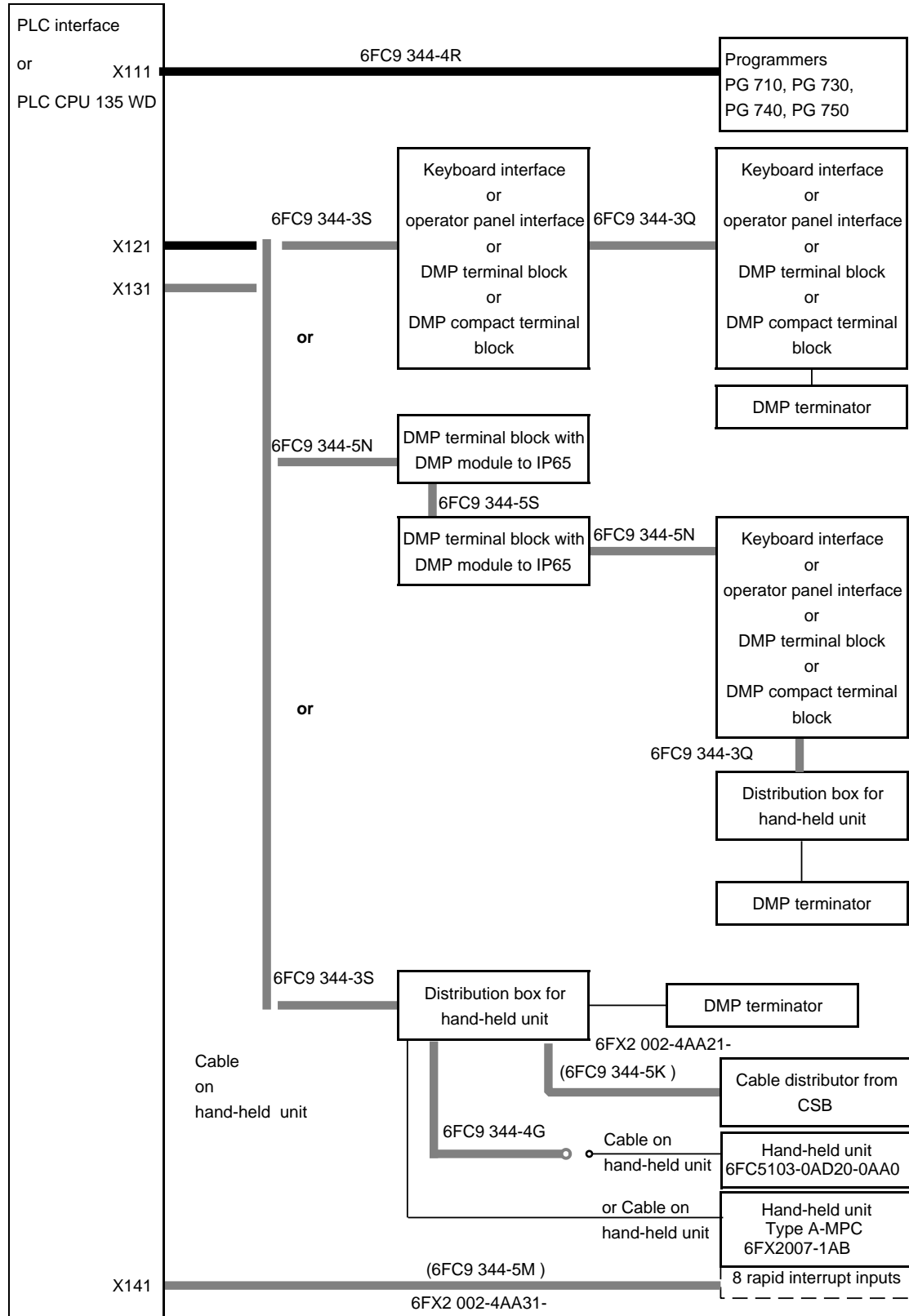

DMP interface connection diagram

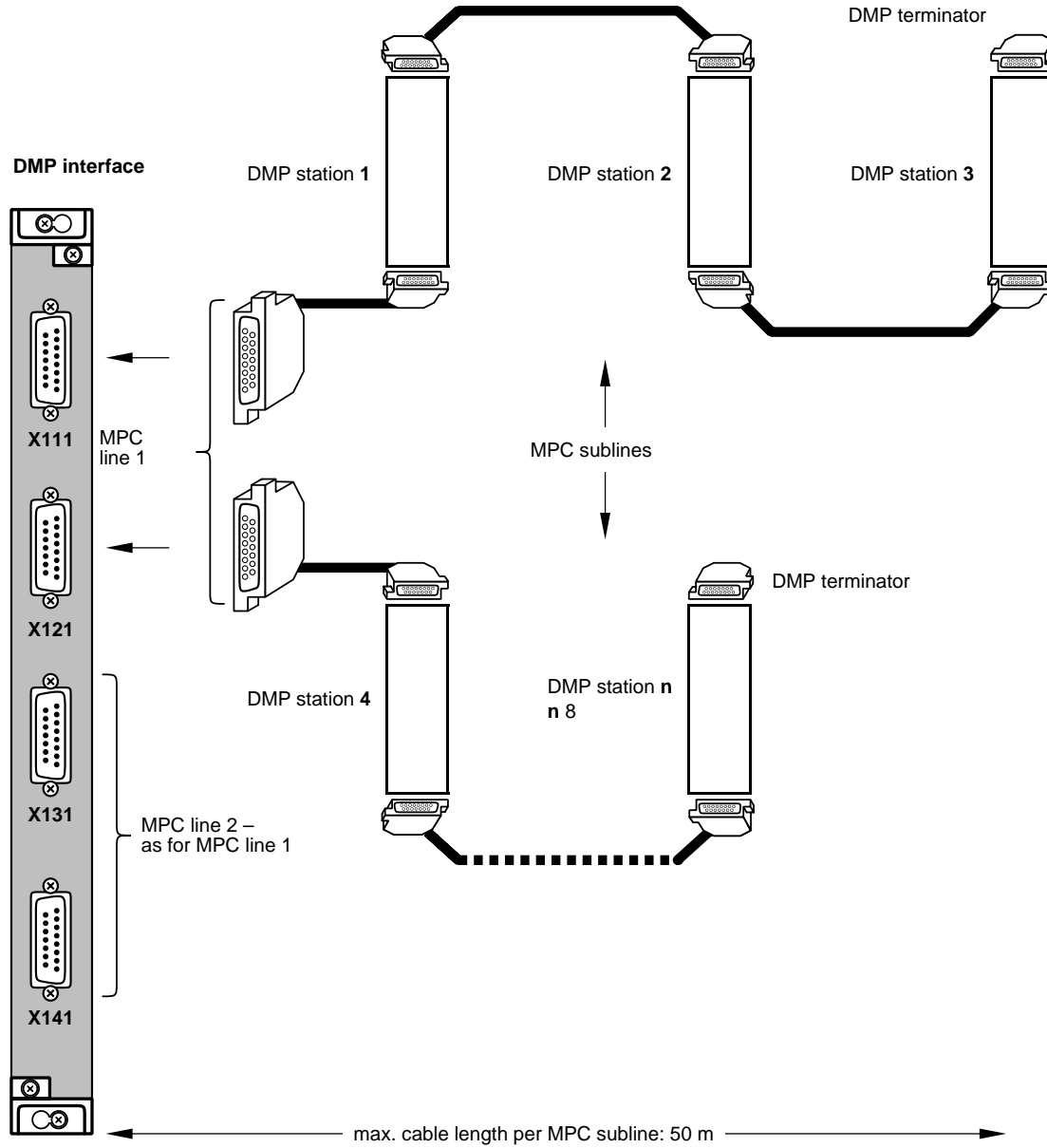

Note:

If you wish to connect a MPC line, you must jumper the terminating resistors on the PLC interface, PLC CPU 135 WD or DMP interface (see Section 2, PLC interface, PLC CPU 135 WD and DMP interface).

DMP interface connection diagram

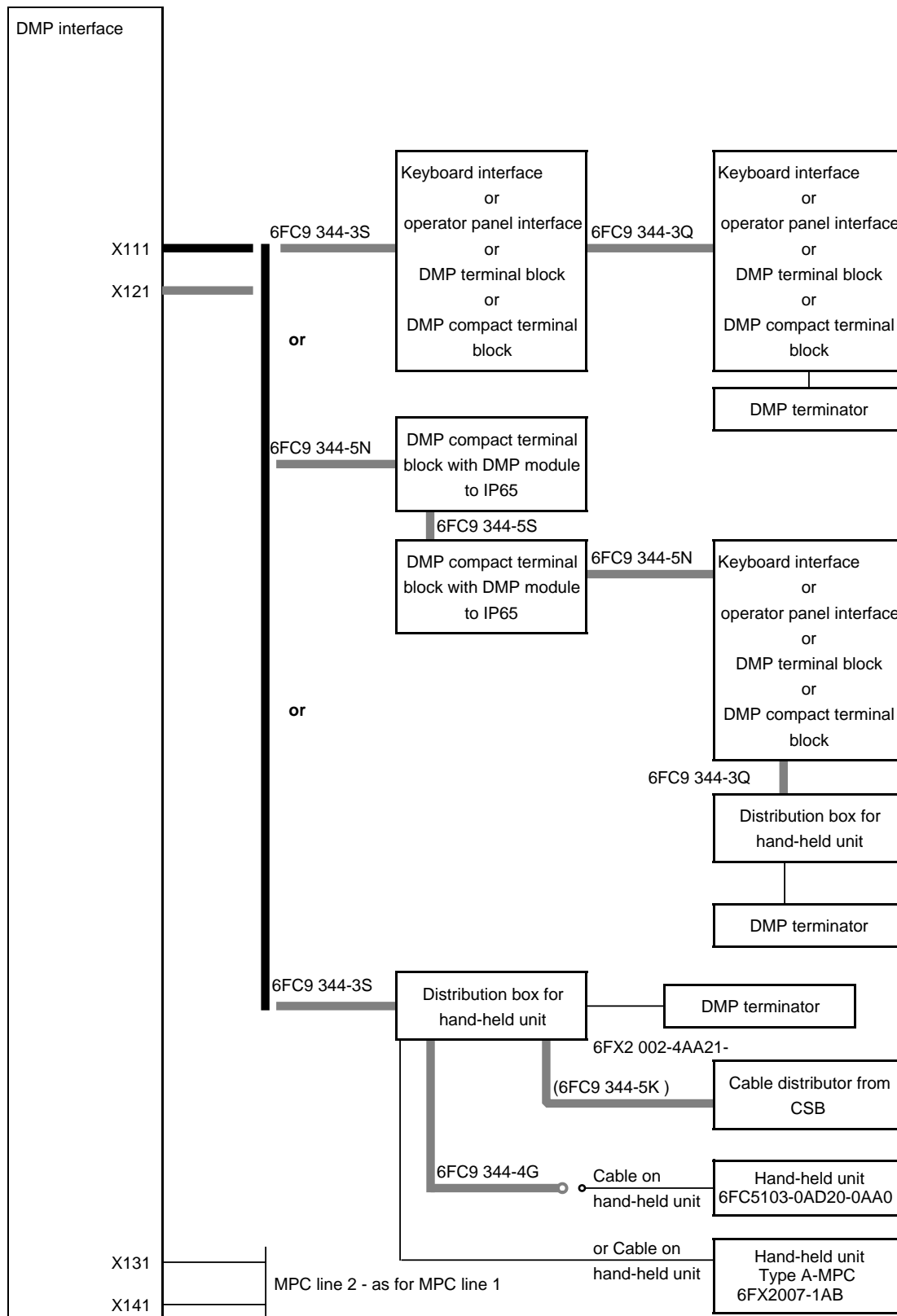

4.3 DMP terminator

6FC5 111-0CA70-0AA0

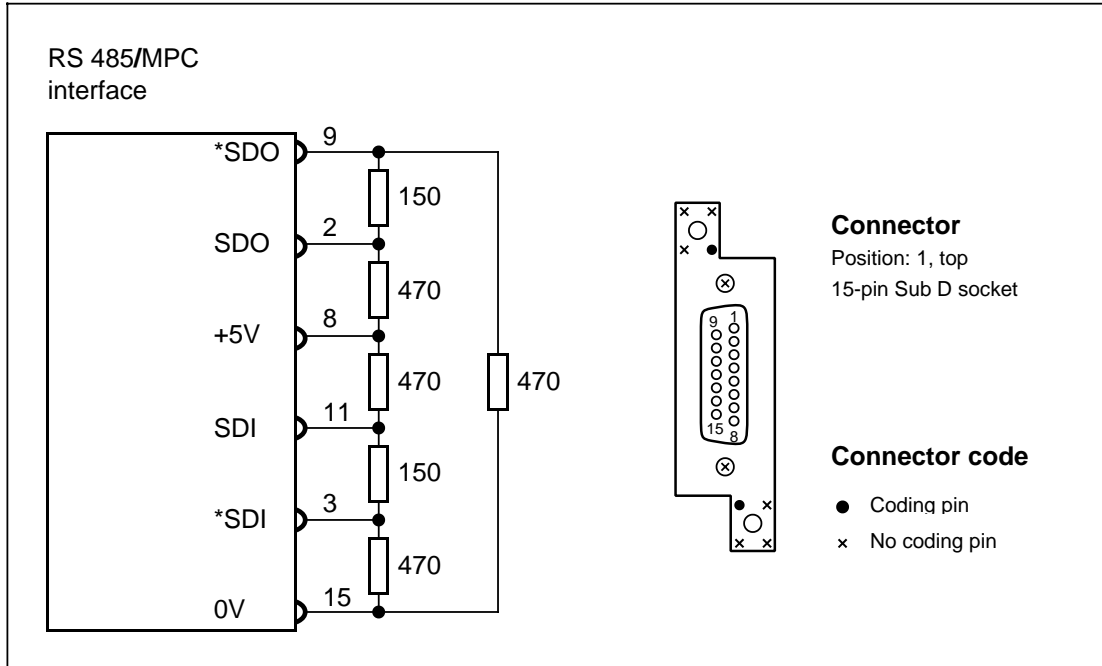

A DMP terminator must be connected to the free interface of the last DMP station except for the handheld unit at the end of each DMP subline!

Note:

- The termination of the DMP terminal block with DMP module to IP 65 is obtained by closing Dip Fix switch S2 in the lower part of the housing.
- The terminating resistors for the MPC interfaces on the PLC interface, PLC CPU 135 WD and DMP interface must be jumpered according to their assignment/non-assignment (see Section 2, PLC interface, PLC CPU 135 WD and DMP interface).

4.4 DMP terminal block and DMP modules

4.4.1 DMP terminal block

6FC5 111-0CA71-0AA0

The DMP terminal block functions as the terminal block for the DMP modules. It is equipped with two RS 485/MPC interfaces. The terminal block is isolated from the power supply.

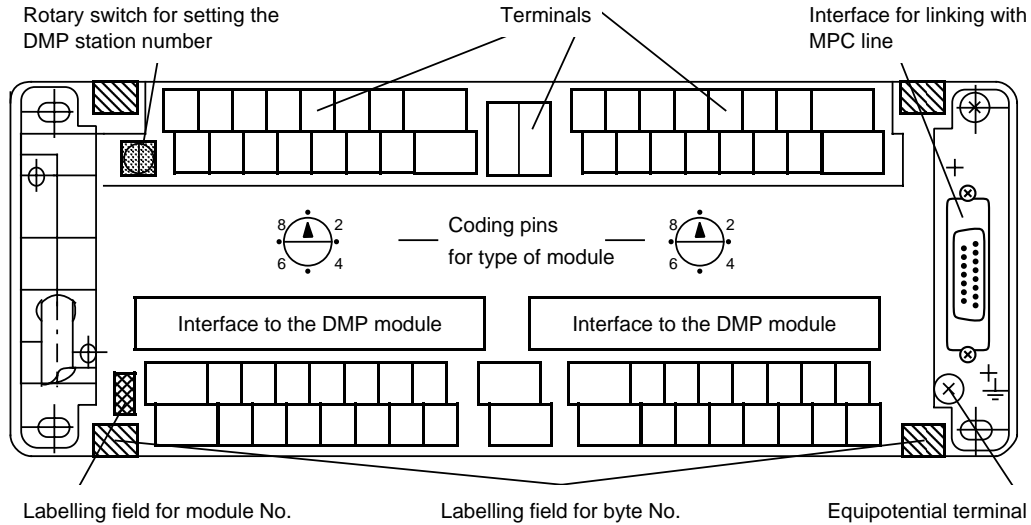

The coding pins for the DMP module type on the DMP terminal block must be matched to the DMP module to be fitted. The rotary switch setting on the DMP modules **must** correspond to the following address.

CODE I	CODE II	DMP module
1	7	DMP module 16 I/16 O only
1	8	DMP module 32 I only

Dimensions and installation measurements of DMP terminal block with DMP modules

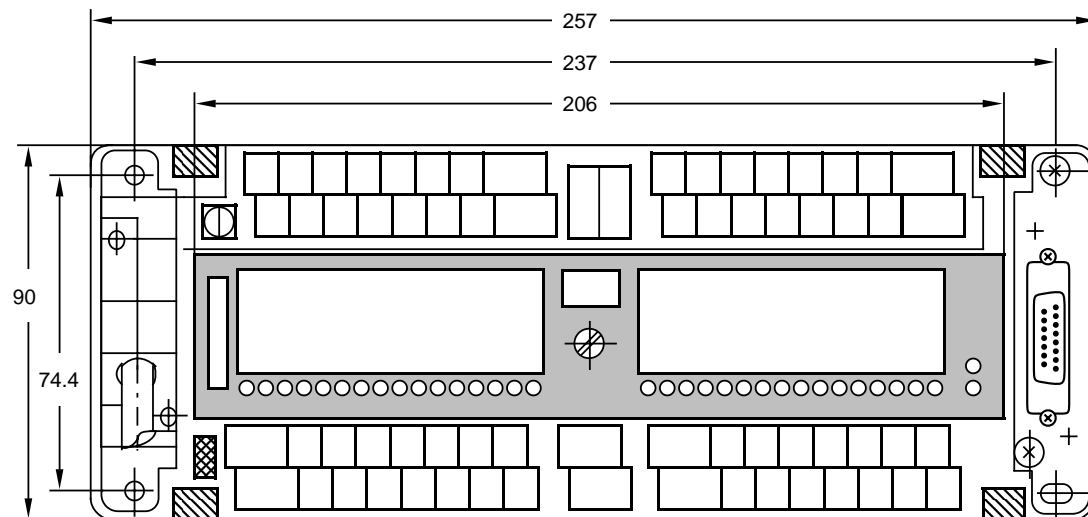

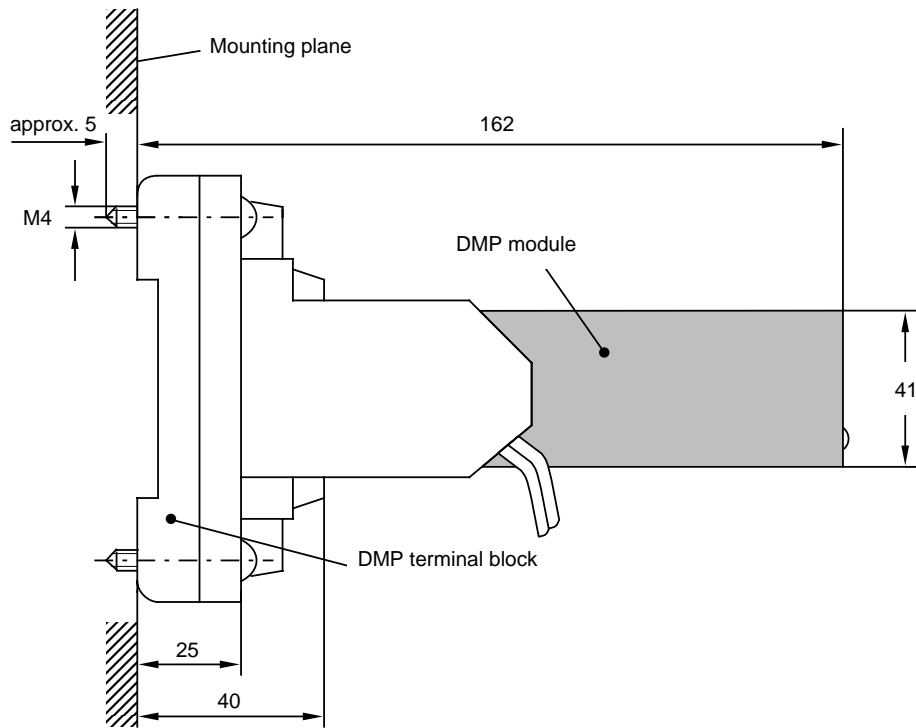

4.4.2 DMP module 16 I/16 O

6FC5 111-0CA20-0AA0

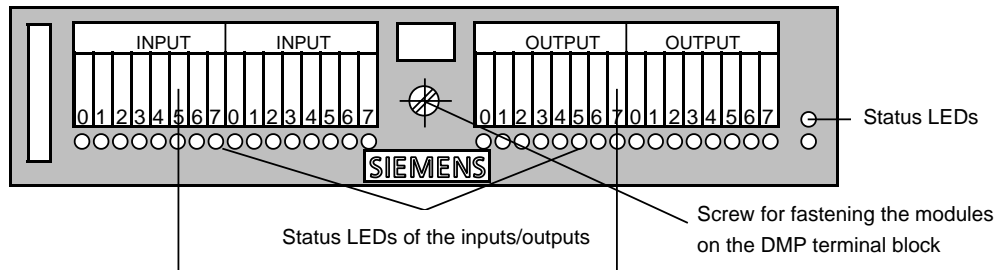

Labelling strips (shown here for DMP module 16I/16O)

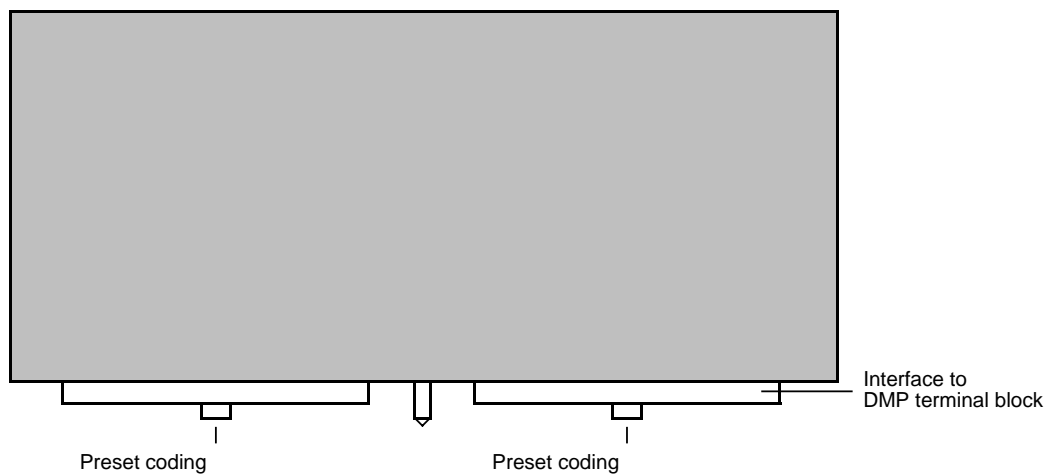

Significance of display elements:

Red LED is lit:

- The 24 V logic supply voltage has dropped below the value of approx. 15 V.
- Transmission error

Yellow LED is lit:

- The 5 V supply voltage generated from the 24 V logic supply voltage is within the tolerance range of 4.75 V to 5.25 V.

Green LED is lit:

- Status display for logical on-state of inputs/outputs

Interfaces:

The following terminals are internally connected by jumpers:

- all PE terminals,
- all M1, M2, M terminals,
- all other jumpers are shown in the diagram

The MPC interface is isolated from the power supply.

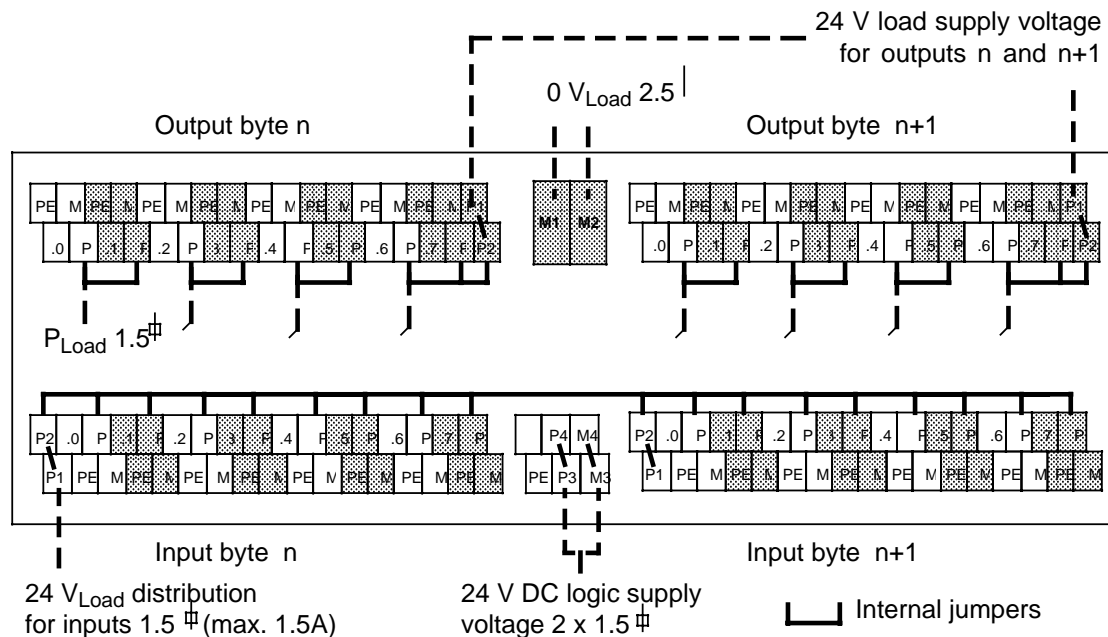

Connection of supply voltages:

- Logic supply voltage, 24 V DC

The 24 V/0 V logic supply voltage is connected to P3 (P4) and M3 (M4).

- Load supply voltage, 24 V DC

The 0 V potential for the load current supply of the inputs and outputs must be connected to M1 (M2) and is thus applied to all M terminals via the internal jumpers of the DMP terminal block. The +24 V load current supply for the two input bytes only needs to be connected to P1 (P2) and is thus supplied to all P terminals of the input bytes via internal jumpers on the DMP module.

The P terminals of the output bytes are arranged in pairs by means of jumpers in the DMP module. The +24 V voltage (load current supply) must thus be connected only to every second terminal.

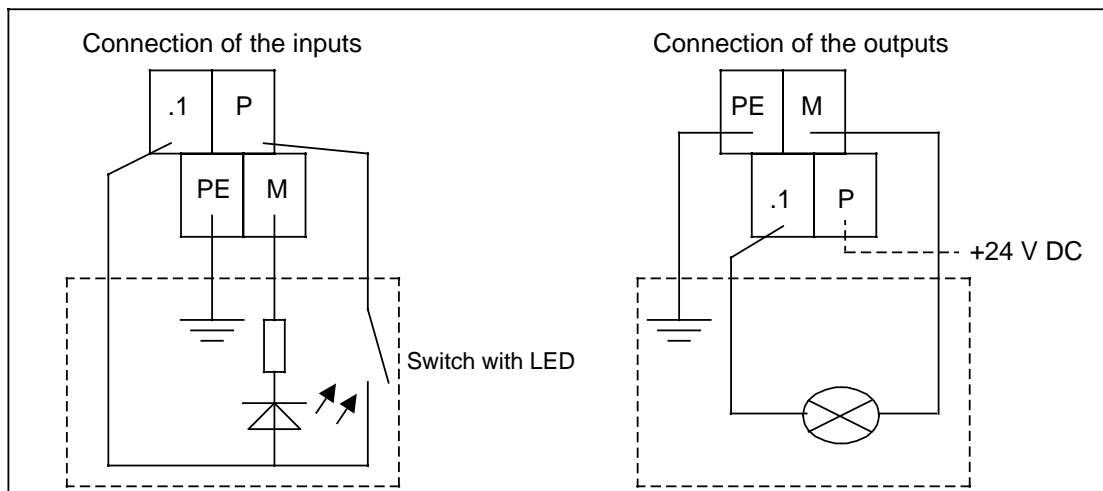

Connection of the inputs and outputs

Technical data:

Digital IN		
Number of inputs		16 digital inputs
Galvanic isolation		no
Input voltage (rated value)		24 V DC
Input voltage	for signal "0" for signal "1"	-3 V to +5 V +13 V to +33 V
Input current	with signal "1"	+3 mA to +10 mA
Delay time	for tpLH	tpLH = typ 1.4 ms
Delay time	for tpHL	tpHL = typ 0.8 ms
Cable lengths	max.	50 m
Digital OUT		
Number of outputs		16 digital outputs
Galvanic isolation		no
Supply voltage V _{est}	- rated value - permissible range (incl. ripple)	24 V DC 20 V to 30 V
Signal level of outputs (typical)	- for signal "0" - for signal "1"	open; a pull-down resistor is required for high-ohmic loads which allows a leakage current of max. 2 mA (approx. 15 kOhm) V _{last} -0.5 V
Output load	for signal "1" (rated) - ohmic load - lamp load - inductive load	2000 mA 25 W 2000 mA
Short-circuit proof		yes
Switching frequency for	- ohmic load - lamps - inductive load (at rated load, higher values are permissible with a lower load)	100 Hz 10 Hz 1 Hz
Total load capacity at 55 °C (referred to the sum of all the rated currents of all outputs)		50 %
Delay time	for tpLH for tpHL	tpLH = max. 0.3 ms tpHL = max. 0.3 ms
Cable length	max.	50 m
Weight	approx.	680 g + 630 g
Degree of protection to EN 60529 and DIN 40050		IP20
Humidity class to DIN 40040		F

4.4.3 DMP module 32 I

6FC5 111-0CA21-0AA0

The view of DMP module 32 I is identical to that in Section 4.4.2.

Significance of display elements:

Red LED is lit:

- The 24 V logic supply voltage has dropped below the value of approx. 15 V.
- Transmission error

Yellow LED is lit:

- The 5 V supply voltage generated from the 24 V logic supply voltage is within the tolerance range of 4.75 V to 5.25 V.

Green LED is lit:

- The status display for the logical in-state of inputs/outputs

Interfaces:

The following terminals are internally connected by jumpers:

- all PE terminals
- all M1, M2, M terminals
- all other jumpers are shown in the diagram

The MPC interface is isolated from the power supply.

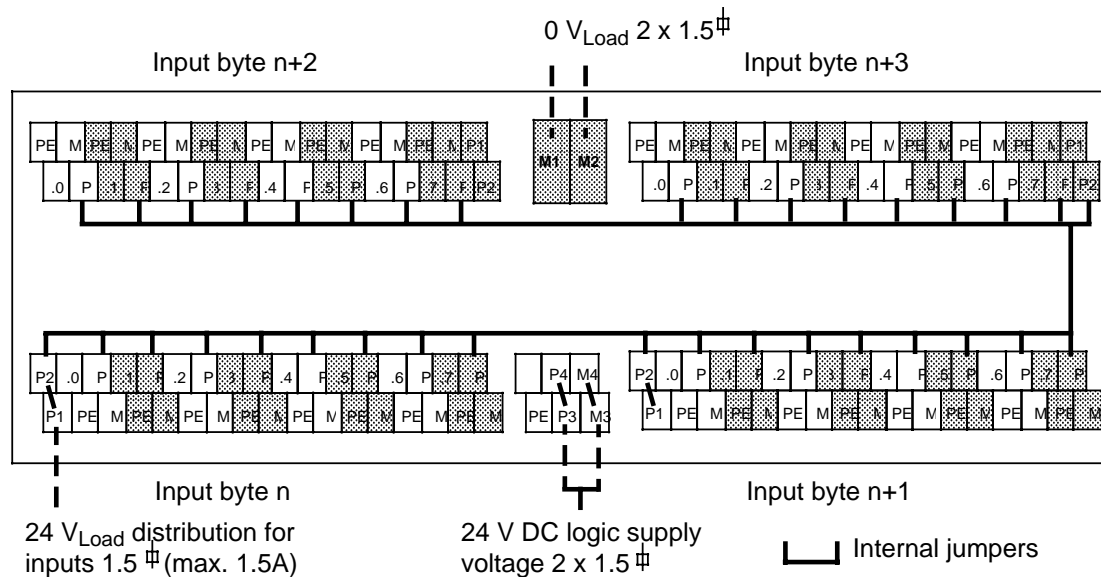

Connection to power supply:

- Logic supply voltage: 24 V DC

The 24 V/0 V logic supply voltage is connected to P3 (P4) and M3 (M4).

- Load supply voltage: 24 V DC

The 0 V potential for the load supply voltage of the inputs and outputs must be connected to M1 (M2) and is thus applied to all M terminals via the internal jumpers of the DMP terminal block. The +24 V load current supply for all input bytes only needs to be connected to P1 (P2) once and is supplied to all P terminals of the input bytes via internal jumpers on the DMP module.

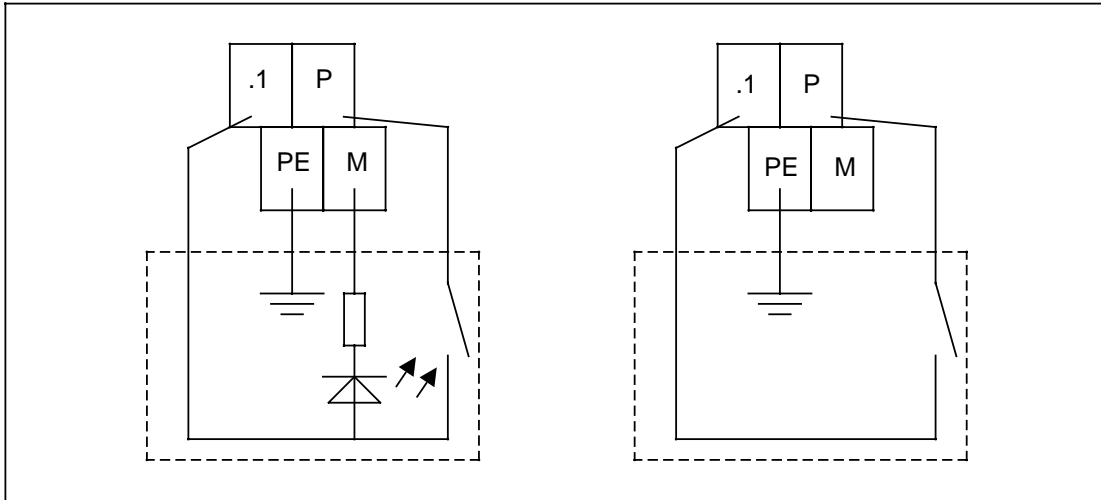

Connection of inputs

Technical data:

Number of inputs	32 digital inputs
Galvanic isolation	no
Supply voltage V_{load}	24 V DC
– rated value	20 V to 30 V
– permissible range (incl. ripple)	
Input voltage (rated value)	24 V DC
Input voltage	for signal "0" -3 V to +5 V
	for signal "1" +13 V to +33 V
Input current	for signal "1" +3 mA to +10 mA
Delay time	for tpLH
Delay time	for tpHL
	tpLH = max. 1.4 ms
	tpHL = max. 0.8 ms
Cable length	max. 50 m
Weight	approx. 430 g + 630 g (TB)
Degree of protection to EN 60529 and DIN 40050	IP20
Humidity class to DIN 40040	F

4.5 DMP compact terminal block and DMP compact modules

You will find information on parameterization and configuring in the manual "Interface Part 1: Signals".

4.5.1 DMP compact terminal block

6FC5 111-0CA73-0AA

The DMP compact terminal block is used as the terminal block for the DMP compact modules. The DMP compact terminal block is equipped with two RS 485/MPC interfaces. Up to 8 DMP compact modules can be slotted into the DMP compact terminal block. Partial complements are possible.

- Old version (Order No.: 6FC5 111-0CA73-0AA0):

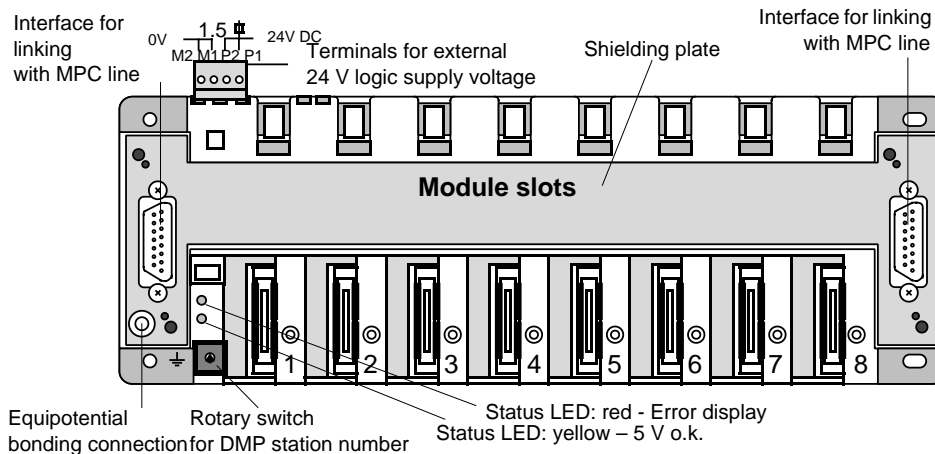

- New version (product release B: Order No.: 6FC5 111-0CA73-0AA1):

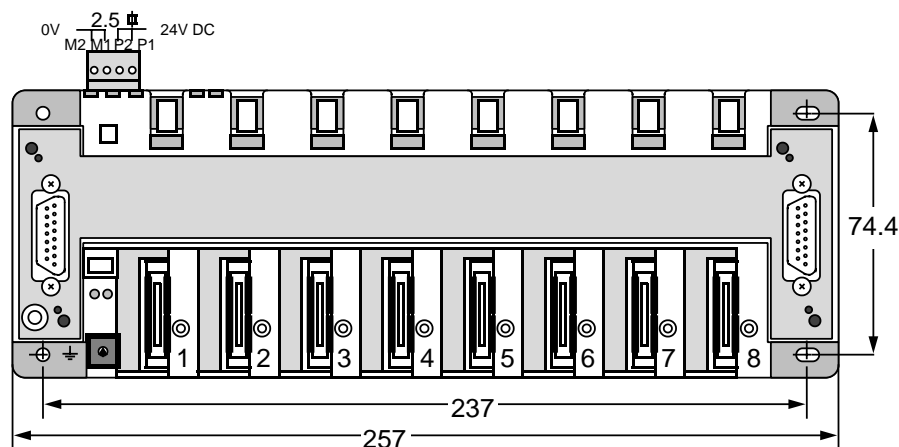

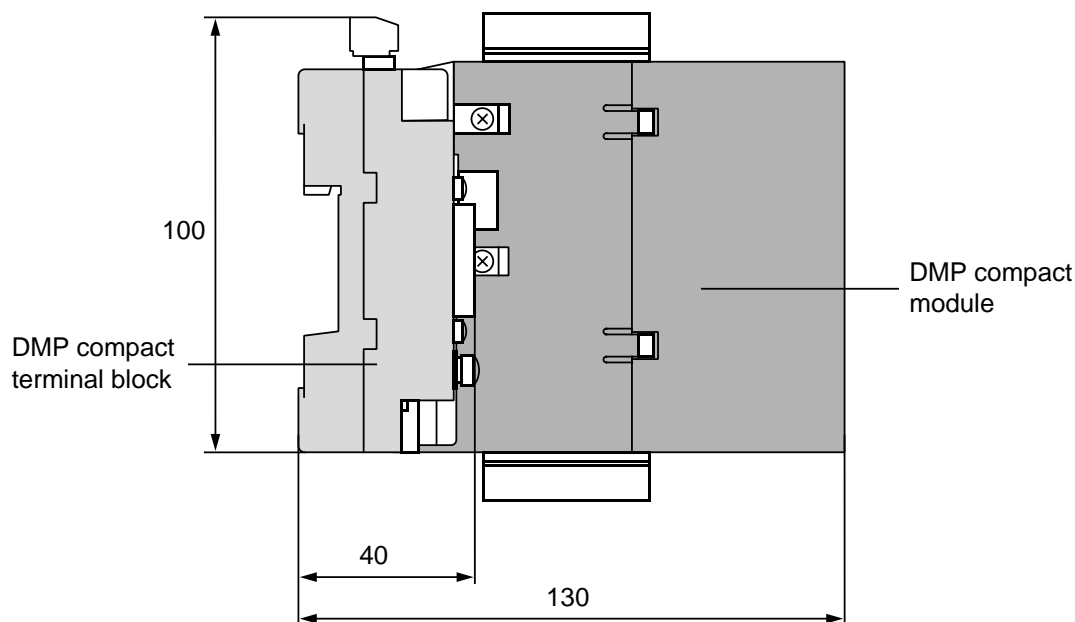

	DANGER
	<p>Typ 6FC5 111-0AC73-0AA0: The DMP compact modules must not be removed or inserted during operation. Please make sure that DMP compact modules are secured directly.</p> <p>Typ 6FC5 111-0AC73-0AA1 (product release B): This type contains degree of expansion monitoring. Any alterations to the module complement during operation are recognized by the PLC.</p>

Interfaces:

- Two 15-way Sub D male connectors for connection to MPC line
- Voltage supply via 24 V DC terminal block
 - (Terminal type: Phoenix, MC1,5/4-ST-3,81, Order No.: 18 28 126)
 - As from product release B:
 Terminal type: Phoenix, MC2,5/4-ST-5,08, Order No.: 18 48 707
 - P1—P2 jumpered
 - M1—M2 jumpered to "loop through" the current supply
- Eight 30-way connectors for plugging on the DMP compact modules. (The DMP compact modules are powered and addressed via these connectors.)

Significance of display elements:

- Red LED is lit:
 General error display
- Yellow LED is lit:
 The 5 V supply voltage generated from the 24 V logic supply voltage is within the tolerance range of 4.75 V to 5.25 V.

4.5.2 DMP compact module 8 O**6FC5 111-0CA03-0AA**

The DMP compact 8 O is an encapsulated module. It can be plugged into a location on the DMP compact terminal block.

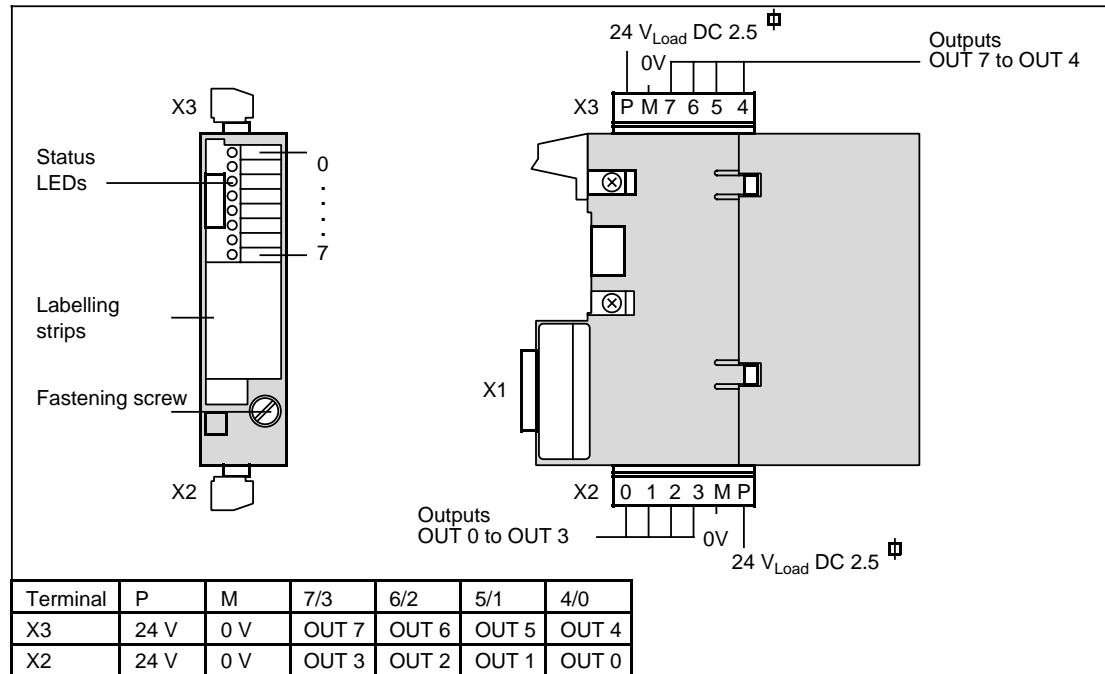
**Interfaces:**

- A 30-way connector X1 for connection to the DMP compact terminal block.
- 6-way terminals X3 and X2 (Phoenix, type MSTB2,5/6-ST-5,08 GREY, order No. for X3: 18 28 647 and for X2: 18 28 168) to connect 8 outputs and the load supply voltage.
- The terminals can be slotted in and mechanically coded by the customer.
- The max. tightening torque for terminals X2 and X3 is 0.8 Nm.

Display elements:

8 LEDs as status display for the logic states of the outputs.

As from Order No. 6FC5 111-0CA03-0AA1 (product version B), the LEDs go out when the load voltage fails.

LEDs lit: Output on

Technical data:

Number of outputs Galvanic isolation	8 digital outputs yes
Supply voltage V_{load} – rated value – permissible range (incl. ripple) – polarity reversal protection	24 V DC 20 V to 30 V yes
Signal level of outputs (typical) – for signal "0" – for signal "1"	High-ohmic output, signal level < 5 V at a load impedance of < 10 k ; leakage current < 0.5 mA $V_{load} - 80 \text{ mV}$
Output load for signal "1" (rated value) – ohmic load – lamp load – inductive load	2000 mA 25 W 2000 mA
Short-circuit proof	yes; short-circuit current < 72 A for max. 400 μs per output
Power loss at 30 V	max. 3.1 W
Switching frequency for – ohmic load – lamps – inductive load (at rated load, higher values are permissible with a lower load)	max. 100 Hz max. 11 Hz max. 2 Hz
Total load capacity at 55 °C (referred to the sum of all the rated currents of all outputs)	50 %
Delay time for tpLH Delay time for tpHL	tpLH = max. 0.5 ms tpHL = max. 0.5 ms
Cable length max.	50 m
Weight approx.	135 g
Degree of protection to EN 60529 and DIN 40050	IP20
Humidity class to DIN 40040	F

4 outputs are supplied from one power supply. For each group of 4 outputs (outputs 0 ... 3 and 4 ... 7) the sum of the output currents must not exceed 4 A (this corresponds to a simultaneity factor of 50% at full load of the individual outputs). For example, all 8 outputs can be loaded simultaneously with 1 A.

Notes:

- When inductive loads are used, switching voltage peaks have to be suppressed by external free-wheeling diodes at the inductance.
- For information on configuring, please refer to the "Interface Part 1: Signals" manual in the section on configuring of distributed machine peripherals (DMP).
- In the case of a fault triggered by an overcurrent, overtemperature or short circuit, the outputs switch off retentively until they are triggered again by the PLC user program.
- As from order No.: 6FC5 111-0CA03-0AA2 external free-wheeling diodes are no longer required under the following conditions:
 - Inductance per output < 100 mH
 - Output current 2 A
 - Operating frequency when supply voltage is switched off < 0.5 Hz
 - Operating frequency on shut-down by PLC user program < 2 Hz

4.5.3 DMP compact module 16 O**6FC5 111-0CA02-0AA**

The DMP compact module 16 O is an encapsulated module. It can be plugged into a slot on the DMP compact terminal block.

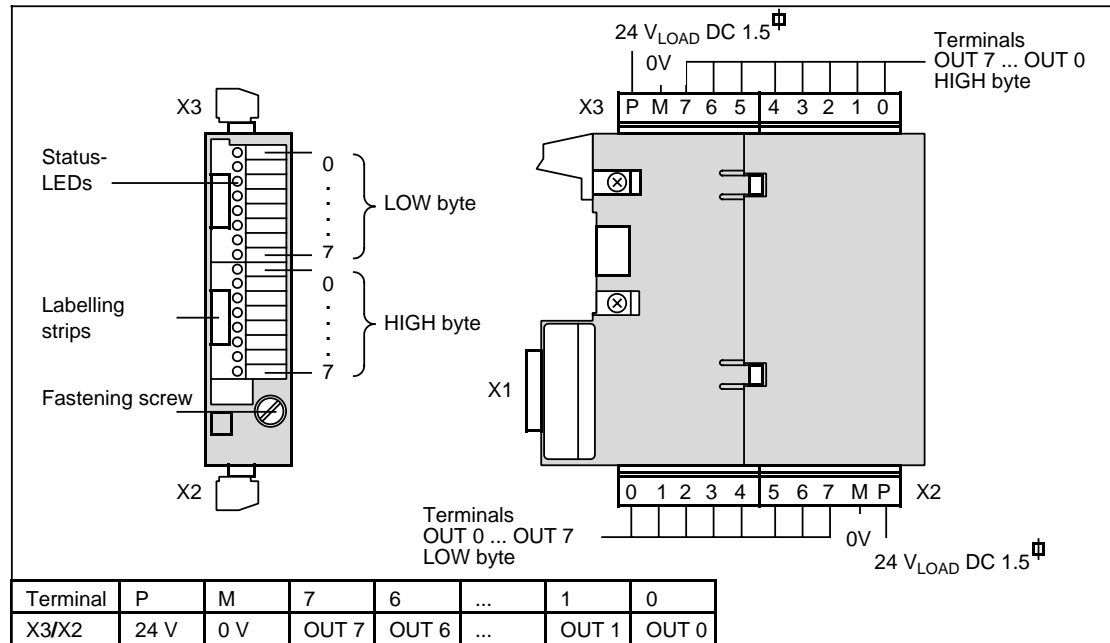
**Interfaces:**

- A 30-way connector X1 for connection to the DMP compact terminal block
- 10-way terminals X3 and X2 (Phoenix, type MC1,5/10-ST-3.81 GREY, order No. for X3 and X2: 18 28 171) to connect 16 outputs on the load supply voltage.
- The terminals can be plugged in and mechanically coded by the customer.
- The max. tightening torque for terminals X2 and X3 is 0.4 Nm.

Display elements:

16 LEDs as status display for the logic states of the outputs.

As from Order No. 111-0CA02-0AA1 (product version B), the LEDs go out when the load voltage fails.

LEDs lit: Output on.

Technical data:

Number of outputs Galvanic isolation	16 digital outputs yes
Supply voltage V_{load} – rated value – permissible range (incl. ripple) – polarity reversal protection	24 V DC 20 V to 30 V yes
Signal level of outputs – for signal "0" – for signal "1"	High-ohmic output, signal level < 5 V at a load impedance of < 10 k ; leakage current < 0.5 mA V_{load} max. 250 mV
Output load for signal "1" (rated value) – ohmic load – lamp load – inductive load	500 mA 5 W 500 mA
Power loss at 30 V	max. 3.8 W
Short-circuit proof	yes; short-circuit current < 2 A per output
Switching frequency for – ohmic load – lamps – inductive load (at rated load, higher values are permissible with a lower load)	max. 100 Hz max. 11 Hz max. 2 Hz
Total load capacity at 55 °C (referred to the sum of all the rated currents of all outputs)	50 %
Delay time for tpLH Delay time for tpHL	tpLH = max. 0.5 ms tpHL = max. 0.5 ms
Cable length max.	50 m
Weight approx.	125 g
Degree of protection to EN 60529 and DIN 40050	IP20
Humidity class to DIN 40040	F

As from Order No. 6FC5 111-0CA02-0AA1, a new driver will be used.

- If a fault occurs as a result of overcurrent or short-circuit, the outputs switch through again on their own when the fault has been put right. (Previously the output remained switched off until reactivated by the PLC user program).
- If an output short-circuits, the three other outputs of the half-byte concerned can also switch off.
- In normal operation with currents < 0.7 A, there is no mutual influencing.

8 outputs are supplied from one power supply. For each group of 8 outputs (2 x outputs 0 ... 7) the sum of the output currents must not exceed 2 A (this corresponds to a simultaneity factor of 50% at full load of the individual outputs). All 16 outputs can, for example, be loaded simultaneously with 0.25 A.

Note:

- When inductive loads are used, switching voltage peaks have to be suppressed by external free-wheeling diodes at the inductance!
- As from order No.: 6FC5 111-0CA02-0AA2 external free-wheeling diodes are no longer required under the following conditions:
 - Inductance per output < 100 mH
 - Output current \leq 500 mA
 - Operating frequency when supply voltage is switched off < 0.5 Hz
 - Operating frequency on shut-down by PLC user program < 2 Hz

4.5.4 DMP compact module 16 I**6FC5 111-0CA01-0AA0**

The DMP compact module 16 I is an encapsulated module. It can be plugged into a slot on the DMP compact terminal block.

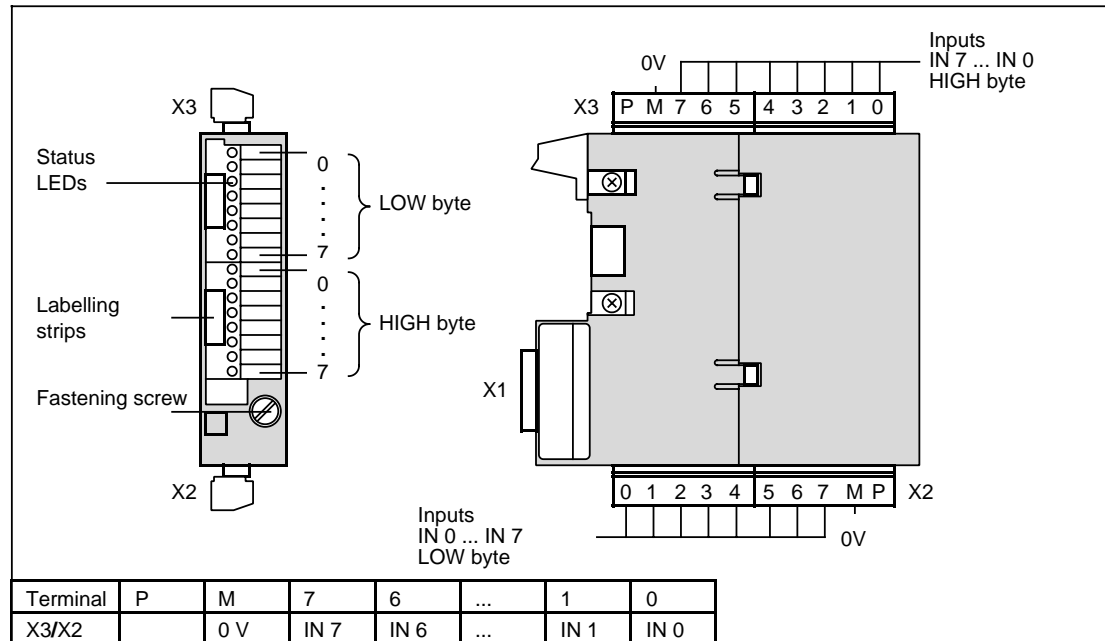
**Interfaces:**

- A 30-way connector X1 for connection to the DMP compact terminal block.
- Two 10-way terminals X3 and X2 (Phoenix, type MC1,5/10-ST-3,81 GREY, order No. for X3 and X2: 18 28 171) for connection to 16 inputs and the load supply voltage.
- The terminals can be plugged-in and mechanically coded by the customer.
Terminal P is not used!
- The max. tightening torque for terminals X2 and X3 is 0.4 Nm.

Display elements:

16 LEDs as status display for the logic states of the inputs.

LEDs lit: Input on.

Technical data:

Number of inputs	16 digital inputs
Galvanic isolation	yes
Polarity reversal protection	yes
Input voltage (rated value)	24 V DC
Input voltage	for signal "0" for signal "1"
	-3 V to +5 V +13 V to +33 V
Input current	for signal "1"
	+2 mA to +5 mA
Delay time	for t_{pLH}
Delay time	for t_{pHL}
	$t_{pLH} = \text{typ } 1 \text{ ms}$ $t_{pHL} = \text{typ } 1 \text{ ms}$
Cable length	max. 30 m
Weight	approx. 115 g
Degree of protection to EN 60529 and DIN 40050	IP20
Humidity class to DIN 40040	F

4.5.5 DMP compact module ANALOG OUT 6FC5 111-0CA05-0AA0

The DMP compact module ANALOG OUT is an encapsulated module. It can be plugged into a slot on the DMP compact terminal block.
 (Max. 4 modules per terminal block)

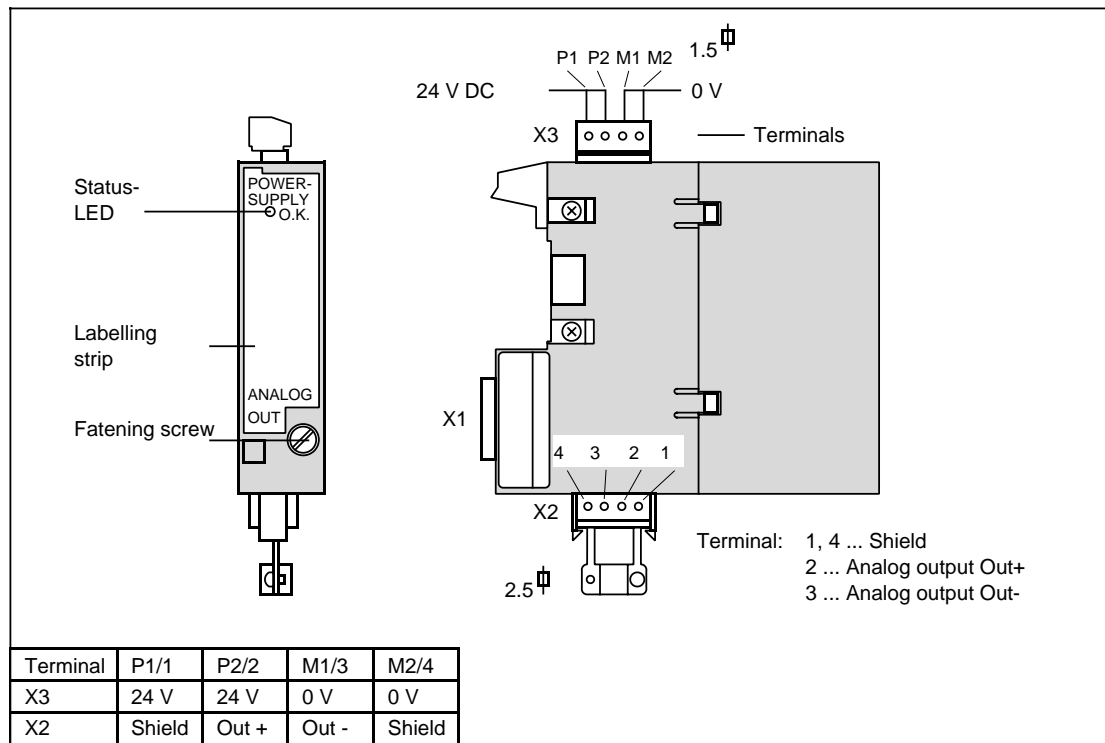

Interfaces:

- A 30-way connector X1 for connection to the DMP compact terminal block.
- 4-way terminal X3 (Phoenix, type MC1,5/4-ST-3,81, order No. for X3: 1828126) to connect the supply voltage for the analog part and X2 (Phoenix, type MSTB2,5/4-ST-5,08 GREY, order No. for X2: 18 40 942) for connection of the analog output.
- The terminals can be plugged in and mechanically coded by the customer.
- The max. tightening torque is 0.8 Nm for terminal X2 and 0.4 Nm for terminal X3.

Display elements:

1 LED as status display for power supply.
 LED lit: Internal power supply o.k.

Technical data:

Number of outputs Galvanic isolation	1 analog output yes
Supply voltage V_{load} – rated value – permissible range (incl. ripple)	24 V DC 20 V to 30 V
Current drawn (24V)	60 mA
Output ranges (rated values)	± 10 V DC
Output current	± 3 mA
Conversion time	RC element in the output with time constant 100 μ s
Load impedance for voltage outputs	min. 3.3 k
Digital representation of output signal	13 bits + sign
Short-circuit proof	yes
Cable length (shielded)	max. 30 m
Weight	approx. 140 g
Degree of protection to DIN 40050	IP20
Humidity class to DIN 40040	F

Digital analog value representation

Output word	QB m								QB m+1							Analog output voltage	
	7	6	5	4	3	2	1	0	7	6	5	4	3	2	1		0
Significance	VZ	2 ¹²	2 ¹¹	2 ¹⁰	2 ⁹	2 ⁸	2 ⁷	2 ⁶	2 ⁵	2 ⁴	2 ³	2 ²	2 ¹	2 ⁰	always 0		
Digital value	0	1	1	1	1	1	1	1	1	1	1	1	1	1	0	0	+ 9.9988 V
	0	0	0	0	0	0	0	0	0	0	0	0	0	1	0	0	+ 1.22 mV
	0	0	0	0	0	0	0	0	0	0	0	0	0	0	0	0	0 V
	1	1	1	1	1	1	1	1	1	1	1	1	1	1	0	0	- 1.22 mV
	1	0	0	0	0	0	0	0	0	0	0	0	0	0	0	0	- 10 V

4.5.6 DMP compact module ANALOG IN

6FC5 111-0CA04-0AA0

The DMP compact module ANALOG IN is an encapsulated module. It can be plugged into a slot on the DMP compact terminal block. (Max. 4 modules per terminal block)

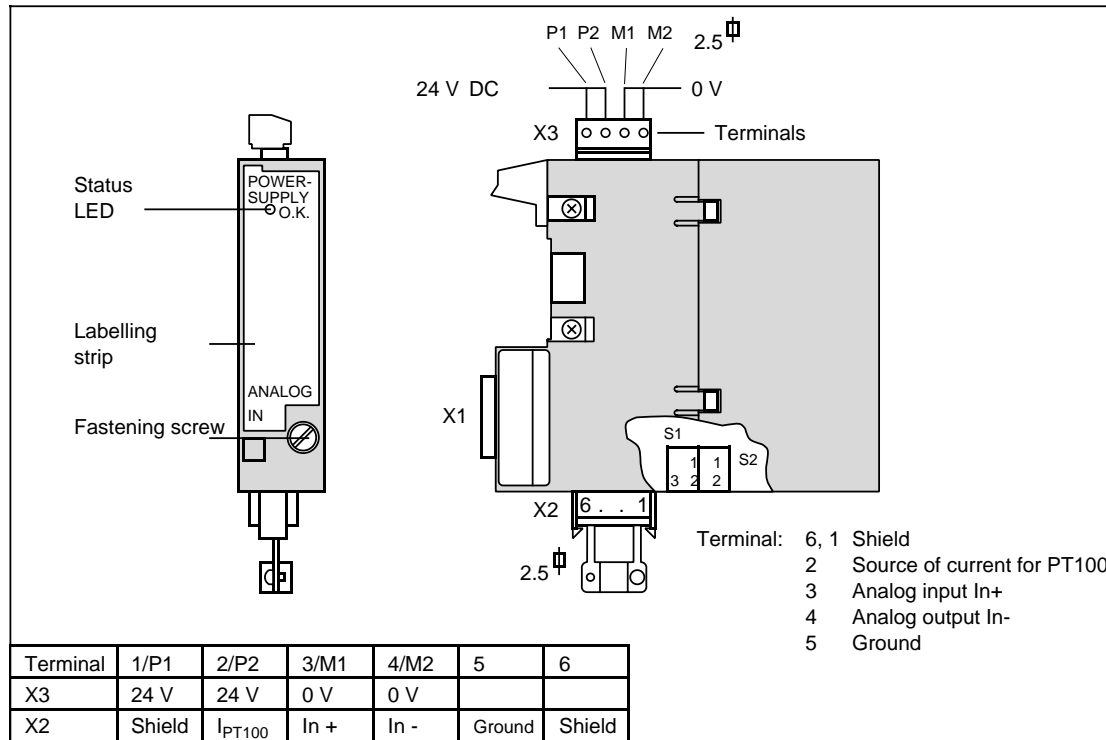

Interfaces:

- A 30-way connector X1 for connection to the DMP compact terminal block.
- 4-way terminal X3 (Phoenix, type MSTB2,5/4-ST-5,08 GREY, order No. for X3: 18 48 407) to connect the supply voltage for the analog parts and a 6-way terminal X2 (Phoenix, type MSTB2,5/6-ST-5,08 GREY, order No. for X2: 17 87 076) for connection of the analog input.
- The terminals can be plugged in and mechanically coded by the customer.

Display elements:

1 LED as status display for power supply
 LED lit: Internal power supply O.K.

Jumpering:

S1: To set the measuring range
 1-2 closed: ± 10 V
 1-3 closed: ± 500 mV

S2: To set the line frequency
 closed: for 50 Hz
 open: for 60 Hz

Example circuits:

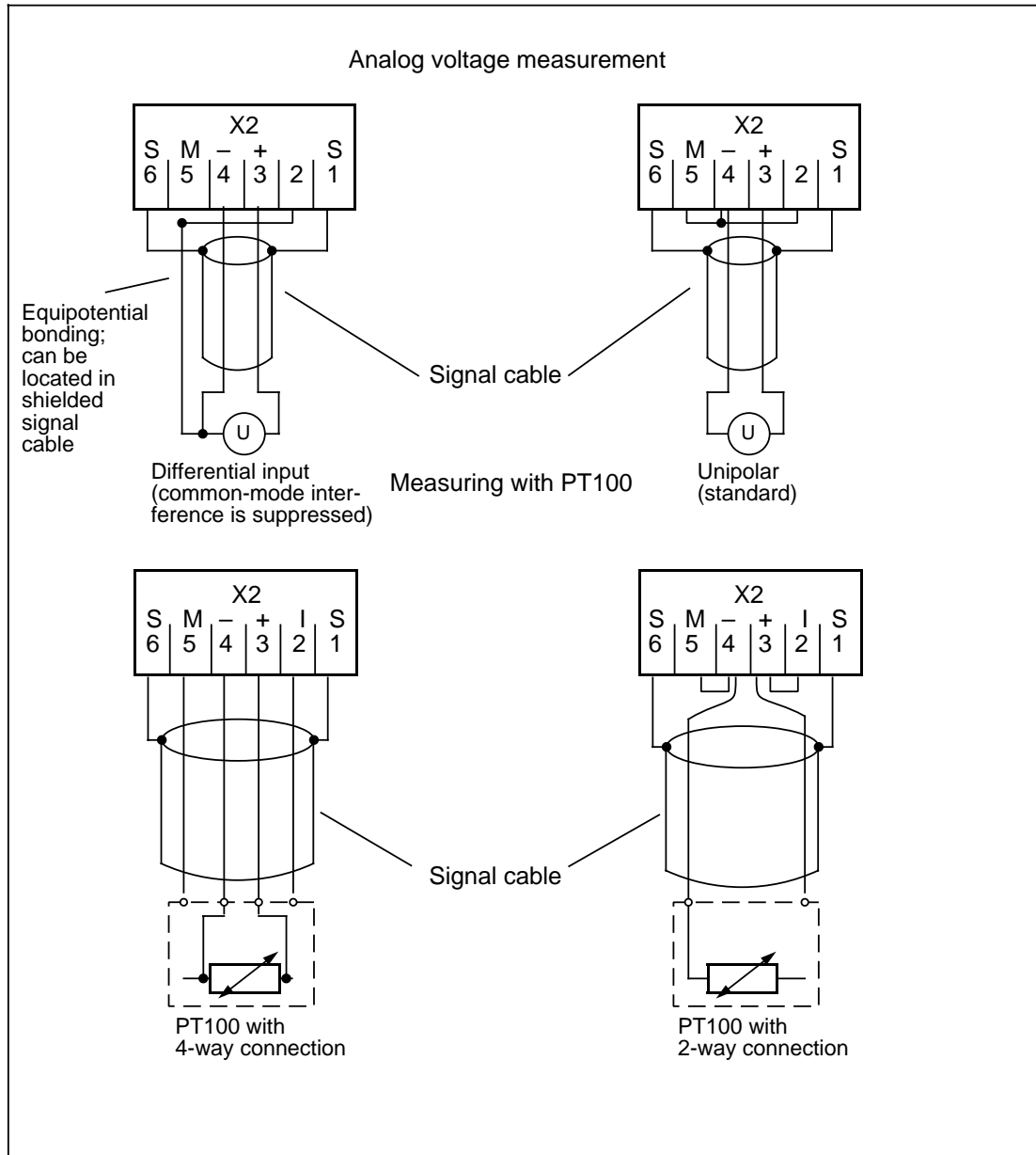

Note:

If the power source is not required, it must be short circuited.

Technical data:

Number of inputs Galvanic isolation		1 analog input yes
Supply voltage V_{load} – rated value – permissible range (incl. ripple)		24 V DC 20 V to 30 V
Input ranges rated range overrange		± 10 V and ± 500 mV ± 20 V and ± 1 V
Conversion time rated range overrange		max. 60 ms max. 80 ms
Power consumption (24V)		45 mA
I_{const} for PT100		2.5 mA
Connection of signal encoders		see below
Digital representation of input signals		12 bits + sign
Error message when range exceeded (± 20 V; ± 1 V)		yes
Basic error limits		$\pm 0.2\%$
Operational limits (0 °C to 60 °C)		$\pm 0.5\%$
Cable length (shielded)	max.	30 m
Weight	approx.	150 g
Degree of protection to EN 60529 and DIN 40050		IP20
Humidity class to DIN 40040		F

The DMP compact module ANALOG IN is used to input and digitize an analog voltage value. This voltage value is measured by an isolated differential input.

PT 100 resistance thermometers can be connected in conjunction with the installed constant current power source (2.5 mA).

Digital analog value representation

Input word	IB m								IB m+1						Analog output voltage			
	7	6	5	4	3	2	1	0	7	6	5	4	3	2	1	0	10 V range	500 mV range
Significance	VZ	2 ¹¹	2 ¹⁰	2 ⁹	2 ⁸	2 ⁷	2 ⁶	2 ⁵	2 ⁴	2 ³	2 ²	2 ¹	2 ⁰	0	OR	PF		
Digital value	0	1	1	1	1	1	1	1	1	1	1	1	1	0	0	0	19.995 V	999.76 mV
							:							:			:	:
	0	1	0	0	0	0	0	0	0	0	0	0	1	0	0	0	10.005 V	500.24 mV
	0	1	0	0	0	0	0	0	0	0	0	0	0	0	0	0	10 V	500 mV
	0	0	1	1	1	1	1	1	1	1	1	1	1	0	0	0	9.995 V	499.76 mV
							:							:			:	:
	0	0	0	0	0	0	0	0	0	0	0	0	1	0	0	0	0.005 V	0.24 mV
	0	0	0	0	0	0	0	0	0	0	0	0	0	0	0	0	0 V	0 V
	1	1	1	1	1	1	1	1	1	1	1	1	1	0	0	0	- 0.005 V	- 0.24 mV
							:							:			:	:
	1	1	0	0	0	0	0	0	0	0	0	0	1	0	0	0	- 9.995 V	- 499.76 mV
	1	1	0	0	0	0	0	0	0	0	0	0	0	0	0	0	- 10 V	- 500 mV
	1	0	1	1	1	1	1	1	1	1	1	1	1	0	0	0	- 10.005 V	- 500.24 mV
							:							:			:	:
1	0	0	0	0	0	0	0	0	0	0	0	1	0	0	0	- 19.995 V	- 999.76 mV	

0 = always 0

OR = overflow bit, input voltage is greater than 20 V or 1 V respectively (double input range)

PF = failure of power supply of analog part

4.6 DMP terminal block with DMP module in IP 65 design

6FC5 111-0CA72-0AA0
6FC5 111-0CA22-0AA0

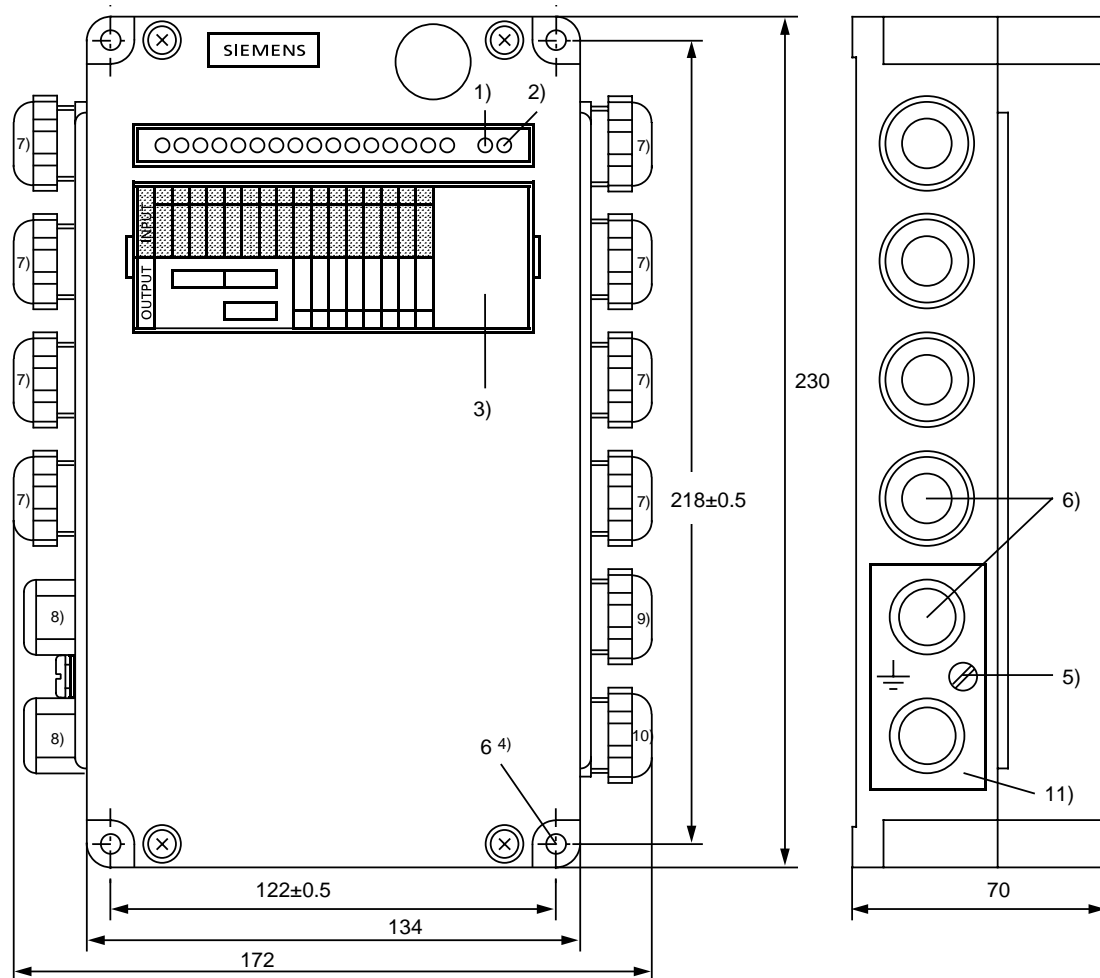

- | | |
|--|---|
| 1) Status LED: Red - Error state | Temperature in enclosed space: 55 °C |
| 2) Status LED: Yellow - 5 V o.k. | Temperature change to SN 26556: 10 K/h; max. 1 K/3 min. |
| 3) Replaceable labelling strip | Degree of protection to DIN 40050: IP 65 |
| 4) Fastening screws for M5 screws | Maximum power loss: 3 W |
| 5) Electrically isolated connection M5 | Total weight: 1.8 kg |
| 6) Use enclosed sealing material if no cable connected; if necessary, remove inner cone before connecting metal cable entry gland (push out of gland from the inside). | |
| 7) PG 11 2x6 mm metal cable entry gland | |
| 8) PG 9 7 mm metal cable entry gland | |
| 9) PG11 9 mm metal cable entry gland | |
| 10) PG 11 6 mm metal cable entry gland | |
| | 11) Shield plate |

The DMP terminal block with DMP module to IP 65 consists of two parts, the DMP terminal block and the DMP module. The DMP terminal block is the bottom part with the connecting terminals (see illustration on next page). Here the switching elements and sensors are directly connected on the permanent wiring principle. The DMP module is located in the top part. When the top part is placed in position the contacts of the terminal strip are closed electrically and the DMP station itself is closed mechanically.

The DMP station number is set by a hexadecimally coded rotary switch (see the section entitled "General"). A four-piece Dip-Fix switch is located on the DMP terminal block to connect the termination circuit (all jumpers must be closed when DMP station is at the end of the MPC subline).

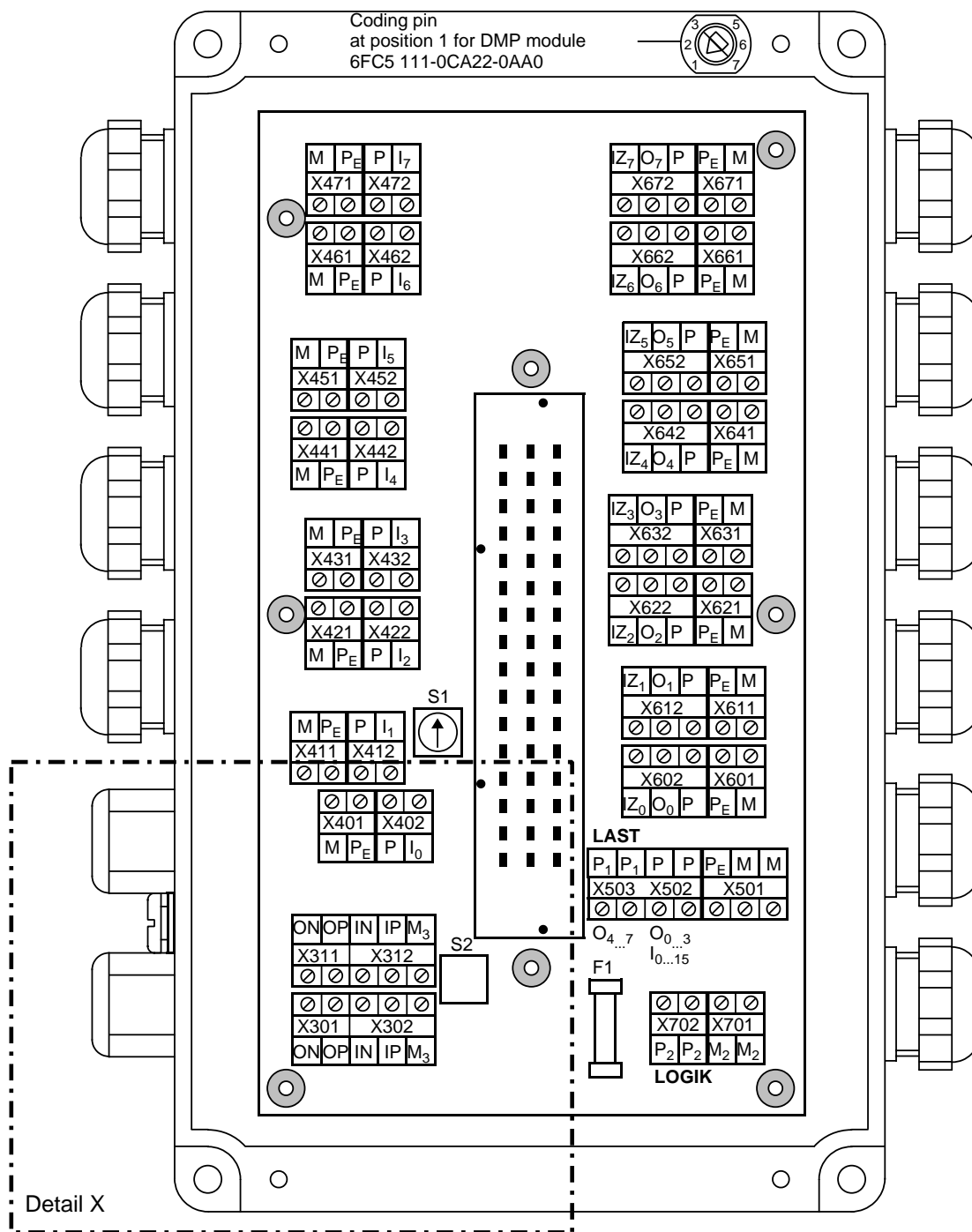

- I_{Z₀} to I_{Z₇} IN, additional IN₀ to IN₇ (additional input 0 to 7), input high byte
- I₀ to I₇ IN₀ to IN₇ (Inputs 0 to 7), input low byte
- O₀ to O₇ OUT₀ to OUT₇ (Outputs 0 to 7)
- ON/IN OUT/INPUT negated – for RS 485/MPC interface
- OP/IP OUT/INPUT normal – for RS 485/MPC interface
- S1 Setting of DMP station number
- S2 Acts in place of termination connector
 - Open: If DMP line continued
 - Closed: If DMP line **not** continued (last DMP station)
- F1 Fuse M 0.63 A

4.6 DMP terminal block with DMP module in IP 65 design

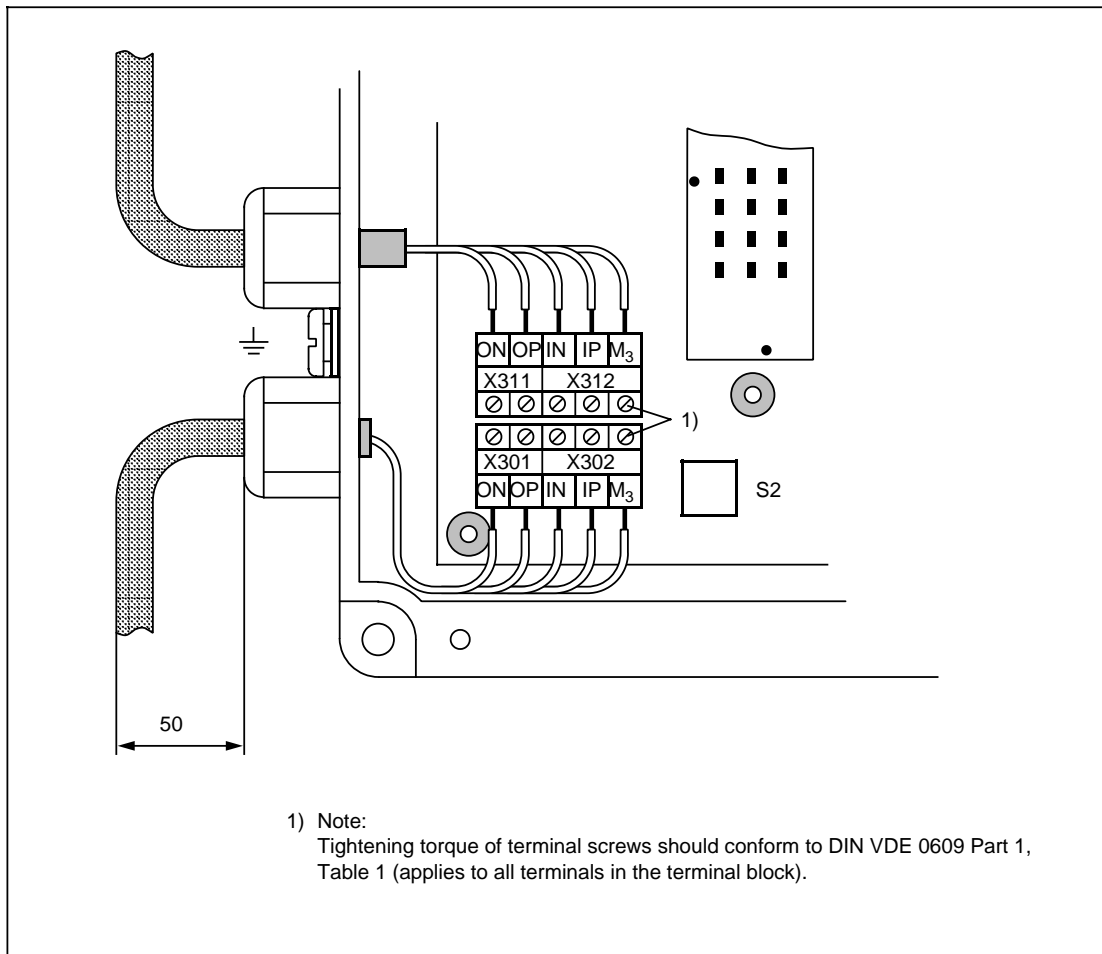

Detail X; connection of MPC line

Interface assignments

MPC connection: The DMP IP 65 station is linked to the MPC line via X301/X302 and X311/X312. The cables must be connected as follows:

Terminals	X301 or X311		X301 or 311		
	ON	OP	IN	IP	M3
Signals (see also Section 6.3, Cable diagrams)	*SDO	SDO	*SDI	SDI	Earth for RS485

Power supply:

- Logic power supply: The 24 V/0V logic power supply is connected to X702 and X701.
- Load power supply: The 0 V potential and P_E of the load power supply must be connected to X501. These potentials are looped through internally to the input/output terminal blocks X402 ... X472, X601 ... X671.

The 24 V potential must be connected to X502 for inputs I_x , I_{Z_x} and the outputs $O_0 ... O_3$.

The 24 V potential must be connected to X503 for outputs $O_4 ... O_7$.

Different 24 V potentials can be connected to X502 and X503.

Inputs/outputs:

X401 ... X471, X401 ... X472 Terminal blocks for inputs $I_0 ... I_7$ (input low byte)

X601 ... X671, X602 ... X672 Terminal blocks for additional inputs $I_{Z_0} ... I_{Z_7}$ (input high byte) and outputs $O_0 ... O_7$.

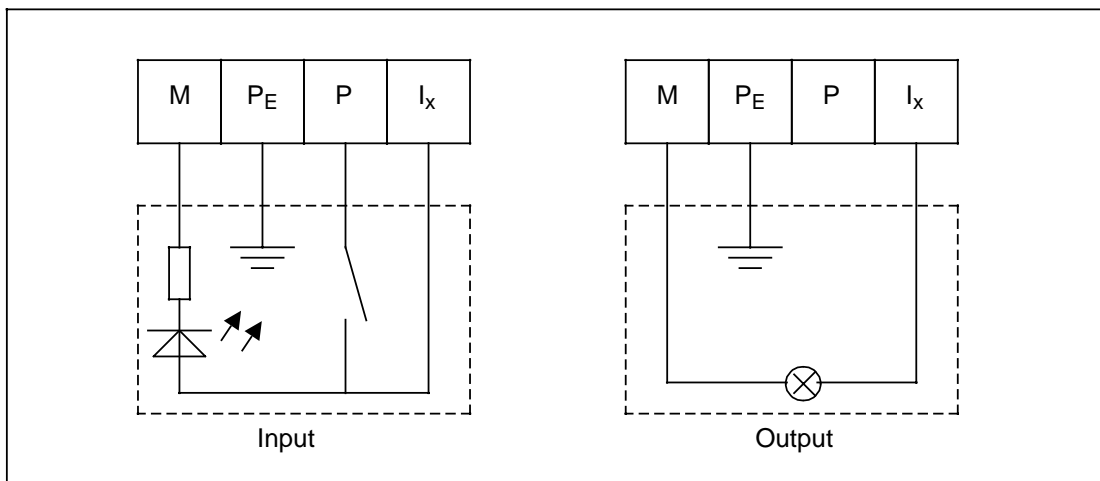

Connection of inputs/outputs

Display elements:

Red LED: Error display

Yellow LED: 5 V o.k.

Green LED: Status display for logic on state of inputs/outputs

4.6 DMP terminal block with DMP module in IP 65 design

Technical data:

Digital IN		
Number of inputs Galvanic isolation		8 and/or 16 digital inputs yes
Supply voltage V_{load} – rated value – permissible range (incl. ripple)		24 V DC 20 V to 30 V
Input voltage (rated value)		24 V DC
Input voltage – for signal "0" – for signal "1"		-3 V to +5 V + 13.5 V to + 33 V
Input current – for signal "1"		+ 3 mA to + 10 mA
Delay time for tpLH for tpHL		tpLH = max. 3 ms tpHL = max. 3 ms
Cable lengths max.		50 m
Digital OUT		
Number of outputs Galvanic isolation		8 and 0 outputs respectively yes
Supply voltage V_{load} – rated value – permissible range (incl. ripple)		24 V DC 20 V to 30 V
Signal level of outputs (typical) – for signal "0" – for signal "1"		open V_{load} -80 mV
Output load for signal "1" (rated) – ohmic load – lamp load – inductive load		2000 mA 25 W 2000 mA
Short-circuit proof		yes
Switching frequency for – ohmic load – lamps – inductive load (at rated load, higher values are permissible with a lower load)		100 Hz 11 Hz 2 Hz
Total load capacity at 55 °C (referred to the sum of all the rated currents of all outputs)		50 %
Delay time for tpLH for tpHL		tpLH = max. 0.5 ms tpHL = max. 0.5 ms
Cable length max.		50 m
Weight approx.		720 g + 530 g
Degree of protection to EN 60529 and DIN 40050		IP65
Humidity class to DIN 40040		F

Note:

8 of the 16 I/O channels are permanently assigned as inputs and another 8 channels may either be inputs or outputs.

When using terminals IZx: Channel x is an input
When using terminals Ox: Channel x is an output

4.7 Machine control panel as DMP station

You can link up to 8 machine control panels (each connected to operator panel electronics or a keyboard interface) in one MPC line. The link is via the RS 485/MPC interfaces X121 and X131.

The machine control panel is then connected to the operator panel electronics (slimline panel) or the keyboard interface using ribbon cable.

As standard it is set as station number value E with the rotary switch.

See the section entitled "Configuring the machine control panel" for assignment of input/output bytes.

If the MPC subline ends at interface X121 or X131, a DMP terminating connector must be plugged into the free interface.

Note:

The 1st and 2nd machine control panels are supported by the operating system, i.e. their functions can easily be implemented via machine data and function macros. The user must program these functions himself via the PLC program on the additional machine control panels (3 to 8 and as from SW3 up to 15).

4.8 Handheld unit and distribution box

The hand-held unit can be used to set the rapid traverse/axis feed movements of machine tools manually.

The hand-held unit is connected to the MPC line via a distribution box and supplied with 24 V. You can connect 1 hand-held unit to each MPC line.

The following handheld units with distribution box are available:

Handheld unit with housing	6FC5 103-0AD20-0AA0
Handheld unit without housing	6FC5 103-0AD21-0AA0
Distribution box	6FC5 147-0AA05-0AA0
Handheld unit A-MPC with 3.5 m coiled cable	6FX2 007-1AB00
Handheld unit A-MPC with 10 m connecting cable	6FX2 007-1AB10
Distribution box	6FX2 006-1BC00
Handheld unit and distribution box with 2nd EMERGENCY STOP channel	
Handheld unit A-MPC with 3.5 coiled cable	6FX2 007-1AB01
Handheld unit A-MPC with 10 m connecting cable	6FX2 007-1AB11
Distribution box	6FX2 006-1BC01

4.8.1 Handheld unit with casing

6FC5 103-0AD20-0AA0

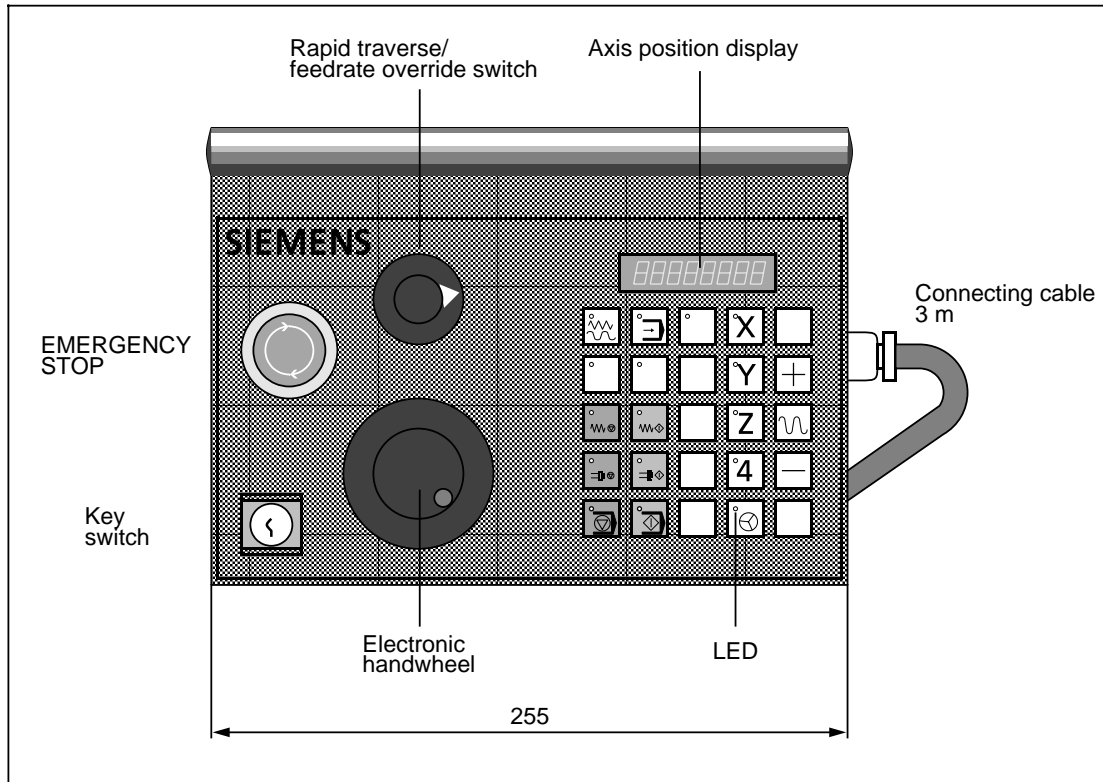

Operator control and display elements

- 25 keys, freely assignable, labels with symbols can be exchanged
- 1 rapid traverse/feedrate override switch
- 1 keyswitch
- 1 EMERGENCY STOP pushbutton
- 1 electronic handwheel (must be connected separately via cable distributor to the CSB, see the section entitled "Central Service Board")
- 16 LEDs, user-configurable
- 1 digital display, user-configurable
 - 7 decades 0 to 9 with decimal point
 - 1 decades 0 to 1 with decimal point and sign

Note:

The handwheel signals can be led via distribution box and cable distributor to the CSB. The signal transmission of handwheel pulses via the MPC line to the NC is not possible.

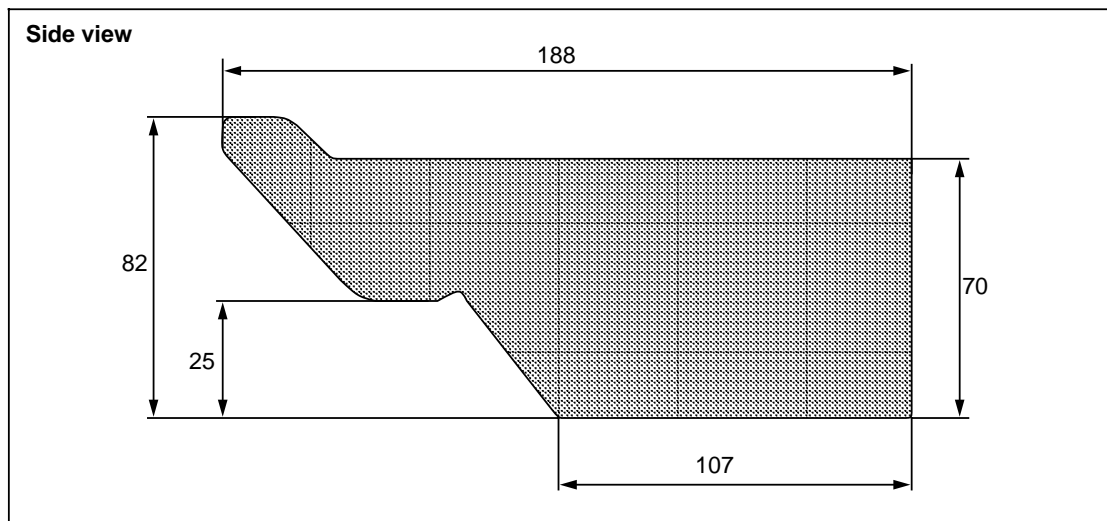

The following diagram shows a fixture for the stationary use of the hand-held unit.

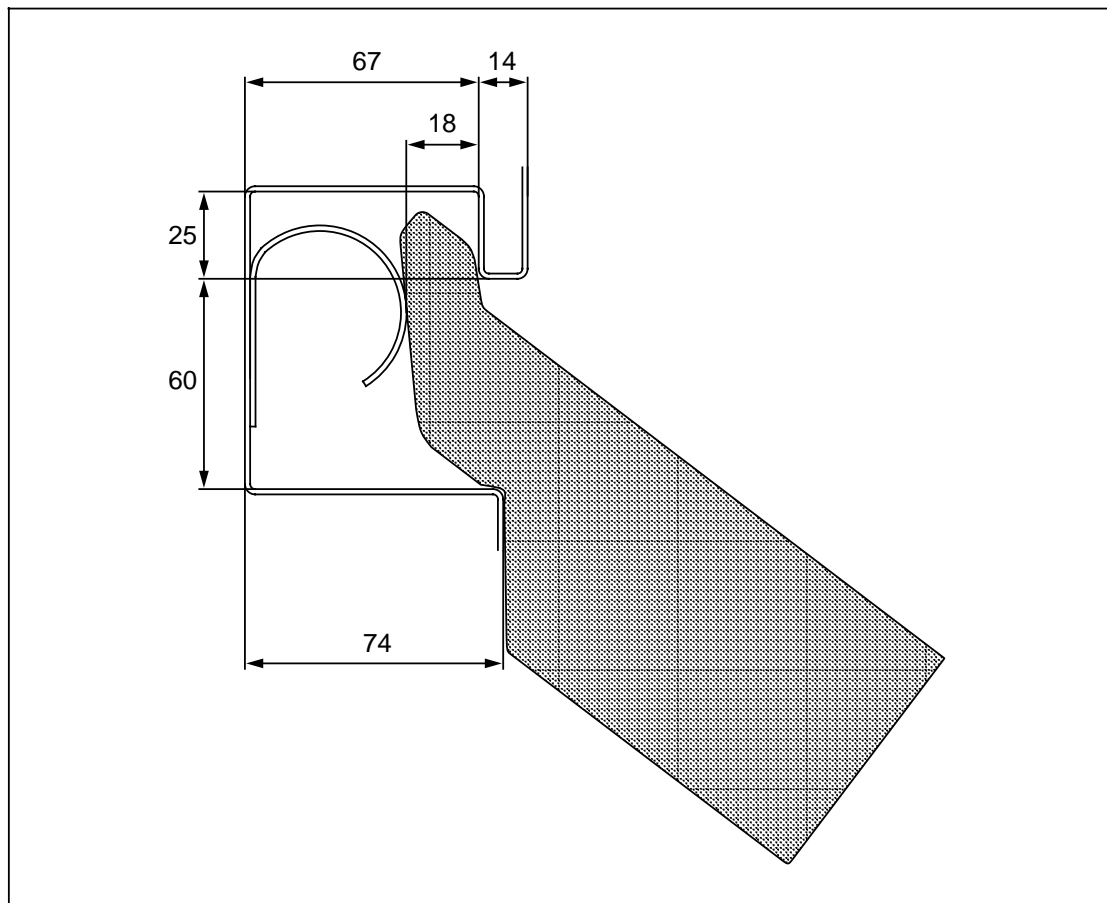

Presettings of printed circuit board in hand-held unit for SINUMERIK 840C

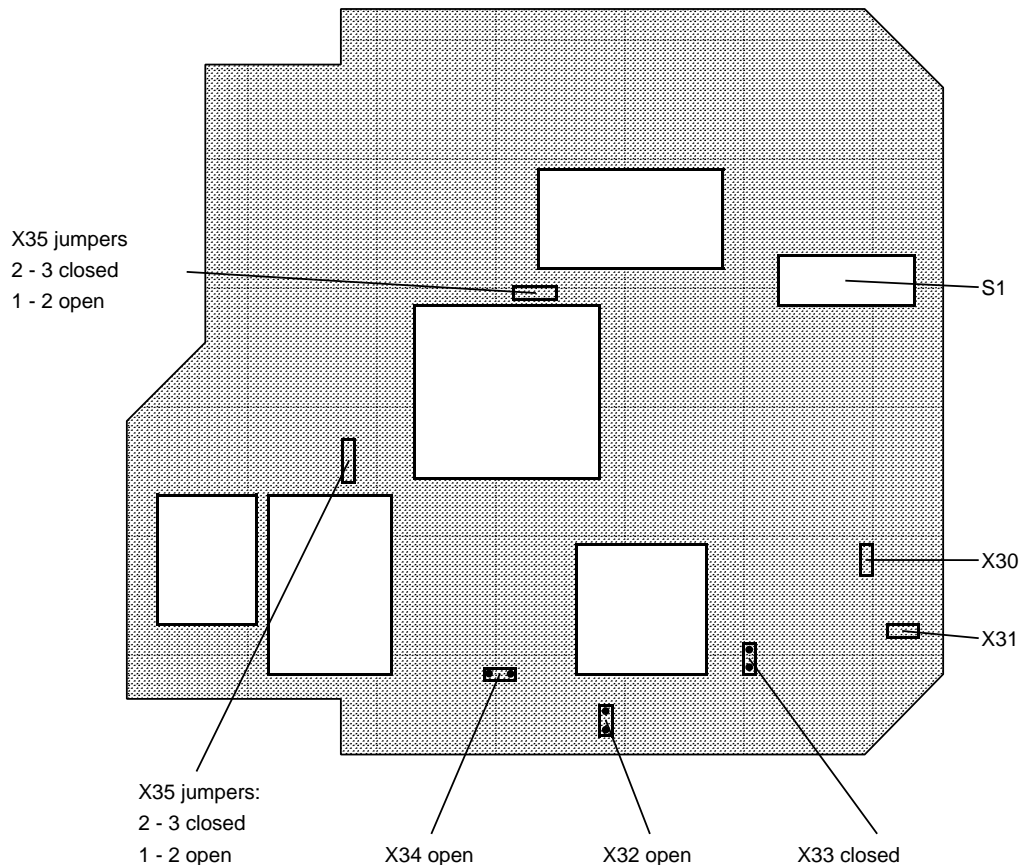

DIP switch S1:

Use for setting the DMP module code. The standard setting is 1CH: preset on delivery.

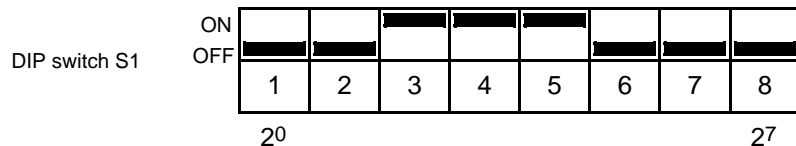

Jumpers X30, X31:

For direct pick-up of both tracks of handwheel via distribution box at terminal strip X23. These jumpers are not inserted on delivery, to prevent interference on these lines (X30: track A, X31: track B).

The DMP rotary switch setting is permanently set to 0H on the printed circuit board; this corresponds to station number 15.

Hardware connections

You must connect the hand-held unit to the distribution box (see following Section). You must use the linking cable for this.

The EMERGENCY STOP key and the handwheel signals are not routed to the PLC but rerouted via distribution box terminal block X23, through which power is also supplied to the handheld unit. All other signals are transferred between the distribution box and PLC via a MPC line.

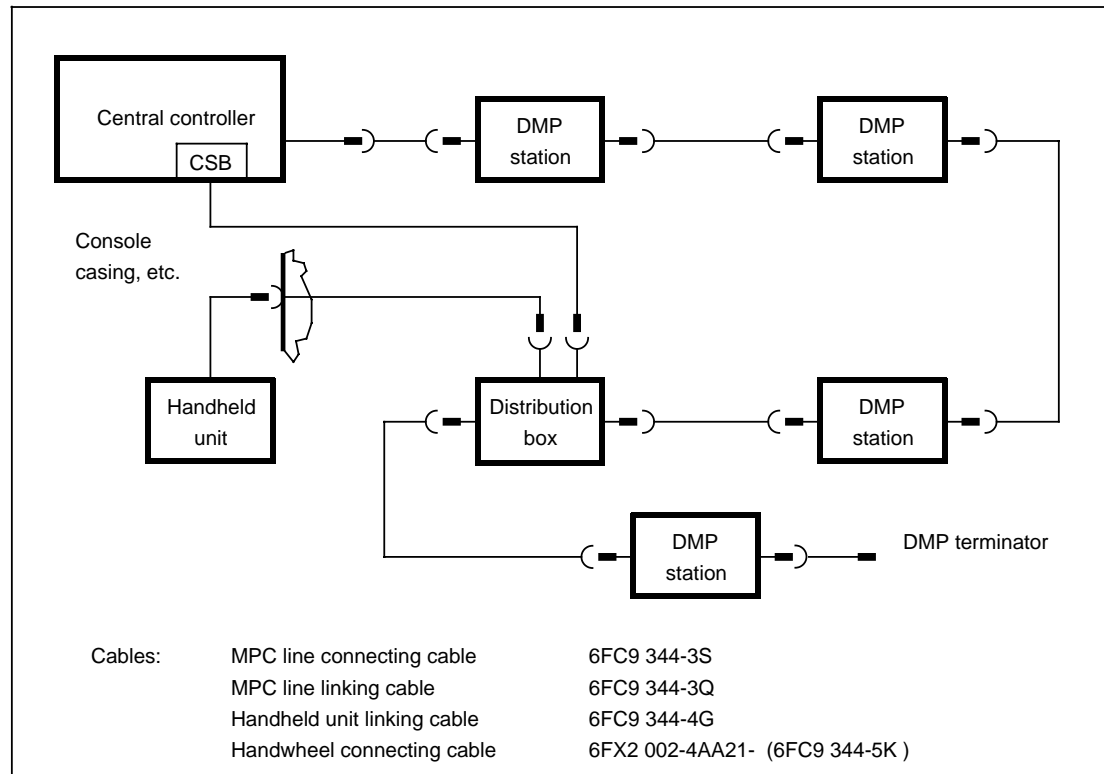

The DMP stations and the distribution box for the handheld unit can be connected in any order.

Notes:

However, it is recommended that the hand-held unit is linked at the end of the MPC line (terminator to distribution box).

The maximum cable length for each MPC subline is 50 m. The length of the linking cable from the distribution box to the handheld unit must not be longer than 13 m. The length of the linking cable must not exceed 10 m because 3 m of cable are already permanently fixed to the handheld unit.

The handheld unit linking cable is included in the maximum length specified for the MPC subline.

Like all other DMP stations, the handheld unit can only be connected to and disconnected from the MPC interface module when the power of the central controller and other DMP stations is switched off.

User interface

Key and LED arrangement

L1 K1	L6 K6	L16 K16	L11 K11	K21
L2 K2	L7 K7	K17	L12 K12	K22
L3 K3	L8 K8	K18	L13 K13	K23
L4 K4	L9 K9	K19	L14 K14	K24
L5 K5	L10 K10	K20	L15 K15	K25

K = Key
 L = LED

Input image handheld unit

Byte No.	Bit No.								
	7	6	5	4	3	2	1	0	
IB m	Handwheel counter 16 bit binary								
IB m+1	Handwheel counter 16 bit binary								
IB m+2	K8	K7	K6	K5	K4	K3	K2	K1	
IB m+3	K16	K15	K14	K13	K12	K11	K10	K9	
IB m+4	K24	K23	K22	K21	K20	K19	K18	K17	
IB m+5		Key switch	Override switch					A	K25
			E	D	C	B			

m = address of input image set with machine data

Output image: LED signals (hand-held unit)

Byte No.	Bit No.							
	7	6	5	4	3	2	1	0
QB m								*Delete handwheel counter
QB m +1								
QB m +2	L8	L7	L6	L5	L4	L3	L2	L1
QB m +3	L16	L15	L14	L13	L12	L11	L10	L9

m = address of output image set with machine data

Output image: digital display (hand-held unit)

Byte No.	Bit No.							
	7	6	5	4	3	2	1	0
QB m +16				DP behind 10 ⁰	D	C	B	A
QB m +17				DP behind 10 ¹	D	C	B	A
QB m +18				DP behind 10 ²	D	C	B	A
QB m +19				DP behind 10 ³	D	C	B	A
QB m +20				DP behind 10 ⁴	D	C	B	A
QB m +21				DP behind 10 ⁵	D	C	B	A
QB m +22				DP behind 10 ⁶	D	C	B	A
QB m +23				DP behind 10 ⁷	"+"	"-"	" +1"	" -1"

Notes to signals:

- Decimal point "DP": "0" active
- Activation of decade 10^7 :

Coding	Display
00H	+1
01H	1
03H	± 1
04H	-1
0AH	-
0DH	+
0FH	(blank)

- Handwheel counter:

The handwheel counter is a 16 bit binary counter. As long as the signal "Delete handwheel counter" has the signal 1, the counter is enabled. When the handwheel is operated, the counter is incremented or decremented according to the direction of rotation of the handwheel. Each time the handwheel is stopped, the counter is changed by 4 units. When incremented the counter jumps from the value 0FFFFh back to 0000h. When decrementing the counter jumps from 0000h to 0FFFFh.

- Override switch

The coding corresponds to the coding of the override switch on the machine control panel.

4.8.1.1 Distribution box for handheld unit

6FC5 147-0AA05-0AA0

The distribution box forms the link between the handheld unit and the MPC line.

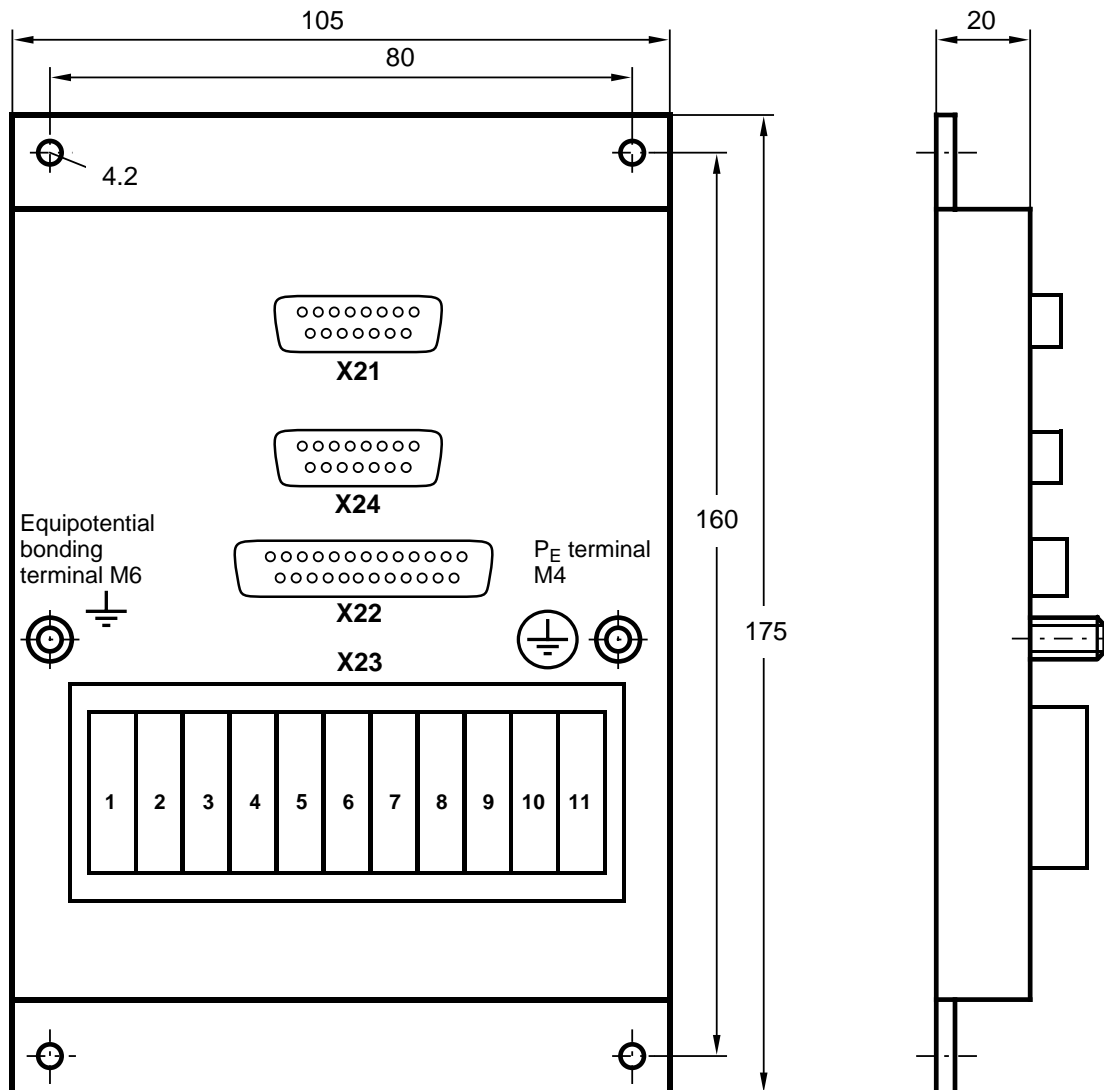

- X21, X24: Interfaces to MPC line
 X22: Interface for handheld unit or machine control panel
 X23: Terminal strip

- Switching capacity of EMERGENCY STOP current loop to handheld unit:
24 V; 2 A
- Assignment of supply terminal X23:
Terminal 1: Unassigned
Terminal 2: Unassigned
Terminal 3: Unassigned
Terminal 4: Handwheel pulses B
Terminal 5: Handwheel pulses A
Terminal 6: Unassigned
Terminal 7: Unassigned
Terminal 8: EMERGENCY STOP
Terminal 9: EMERGENCY STOP
Terminal 10: 0 V
Terminal 11: +24 V

Connecting the handheld unit to the distribution box

The handheld unit is connected to the distribution box via a Harting coupler installed by the manufacturer at the operator console or elsewhere. The Harting coupler is supplied together with the handheld unit and the handheld unit adapter cable.

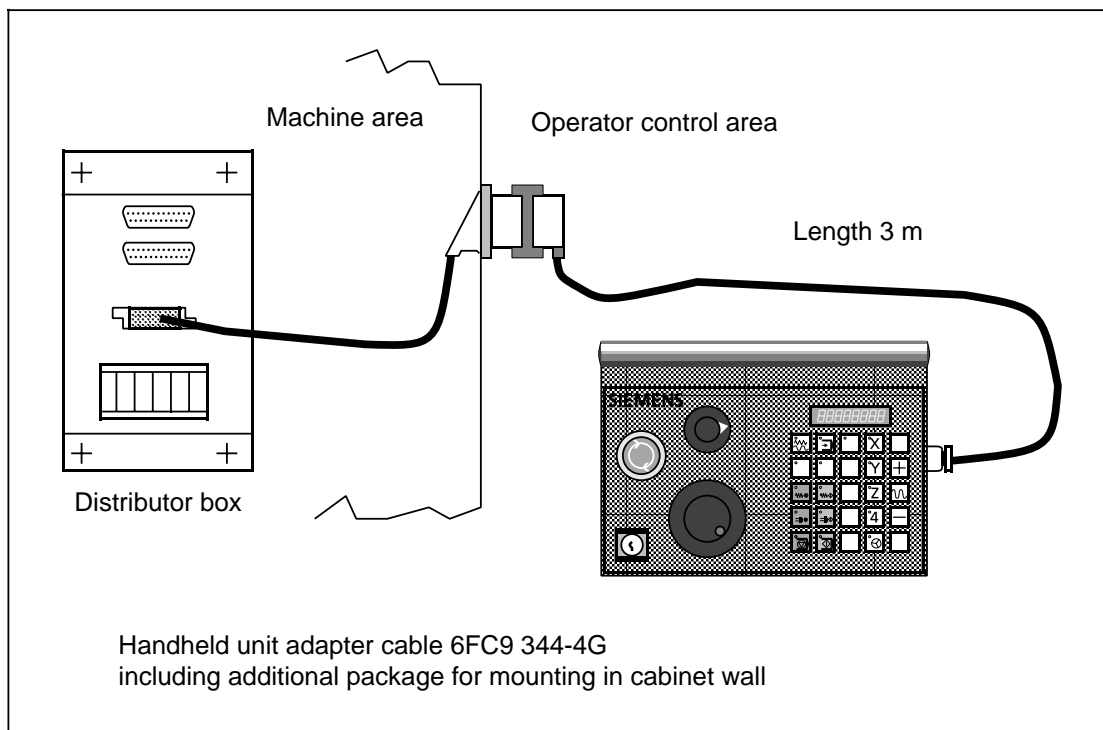

4.8.2 Handheld unit for mounting without housing

Order No.: 6FC5 103-0AD21-0AA0
 Module designation: 6FC4 600-0AT02 or 6FC5 103-0AD21-0AA0

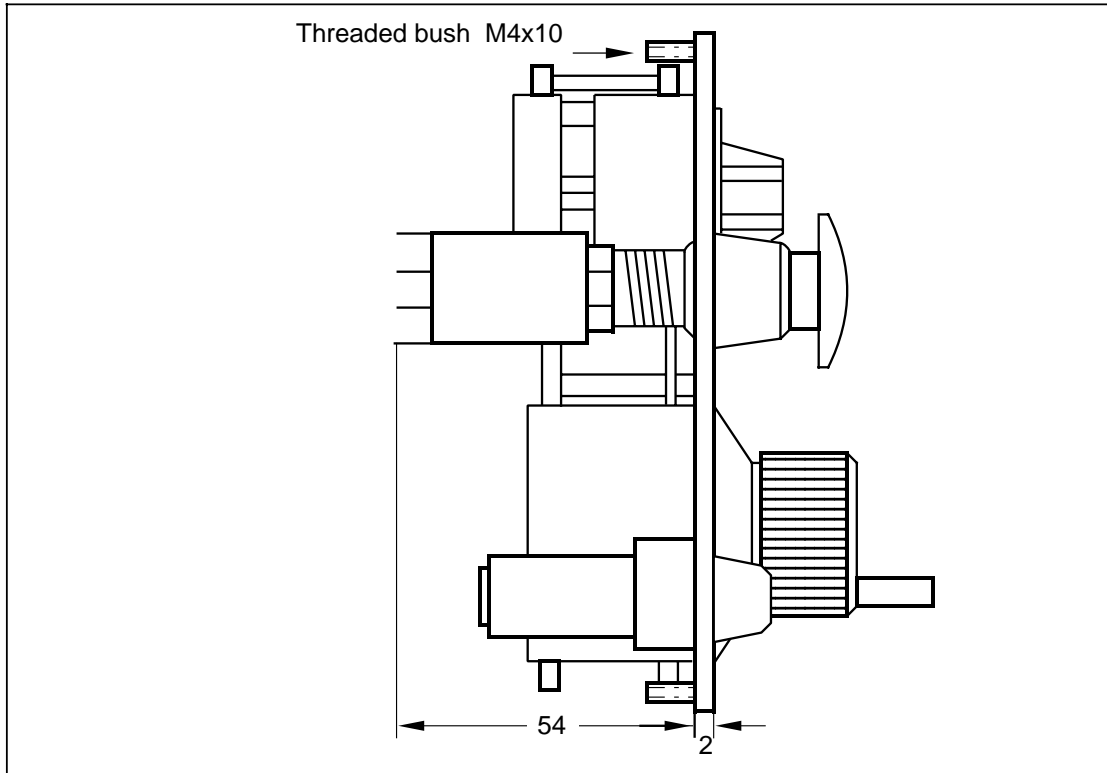
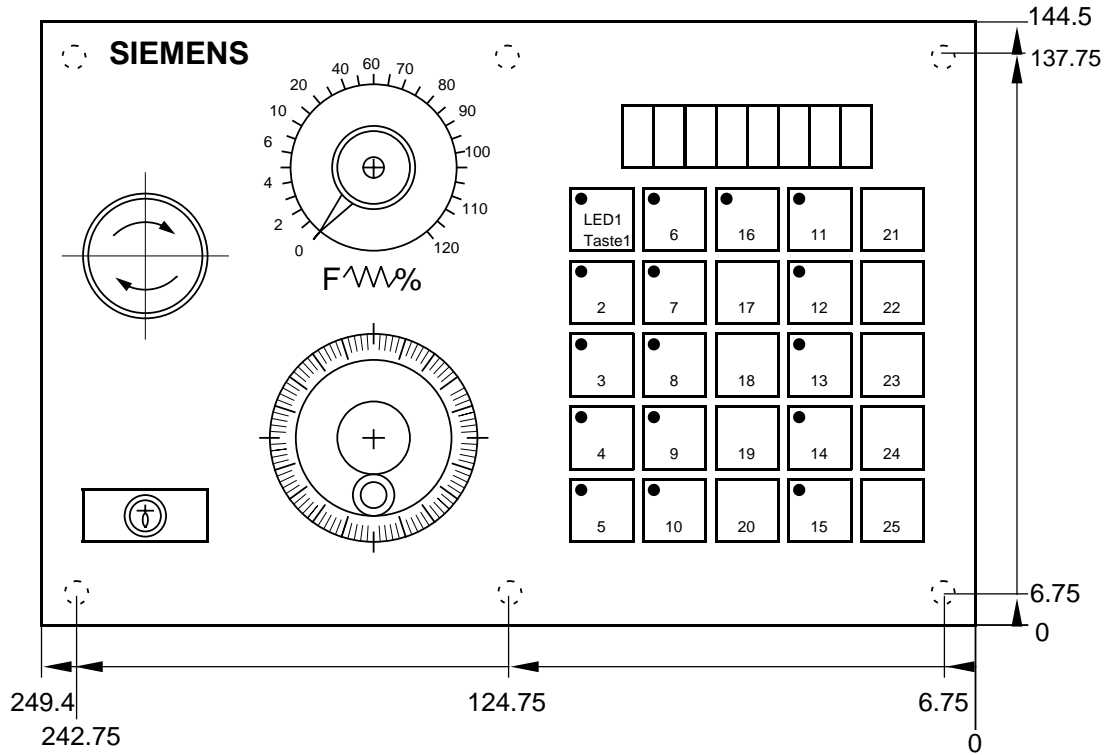

Cutout for machine control panel (handheld-unit without housing)

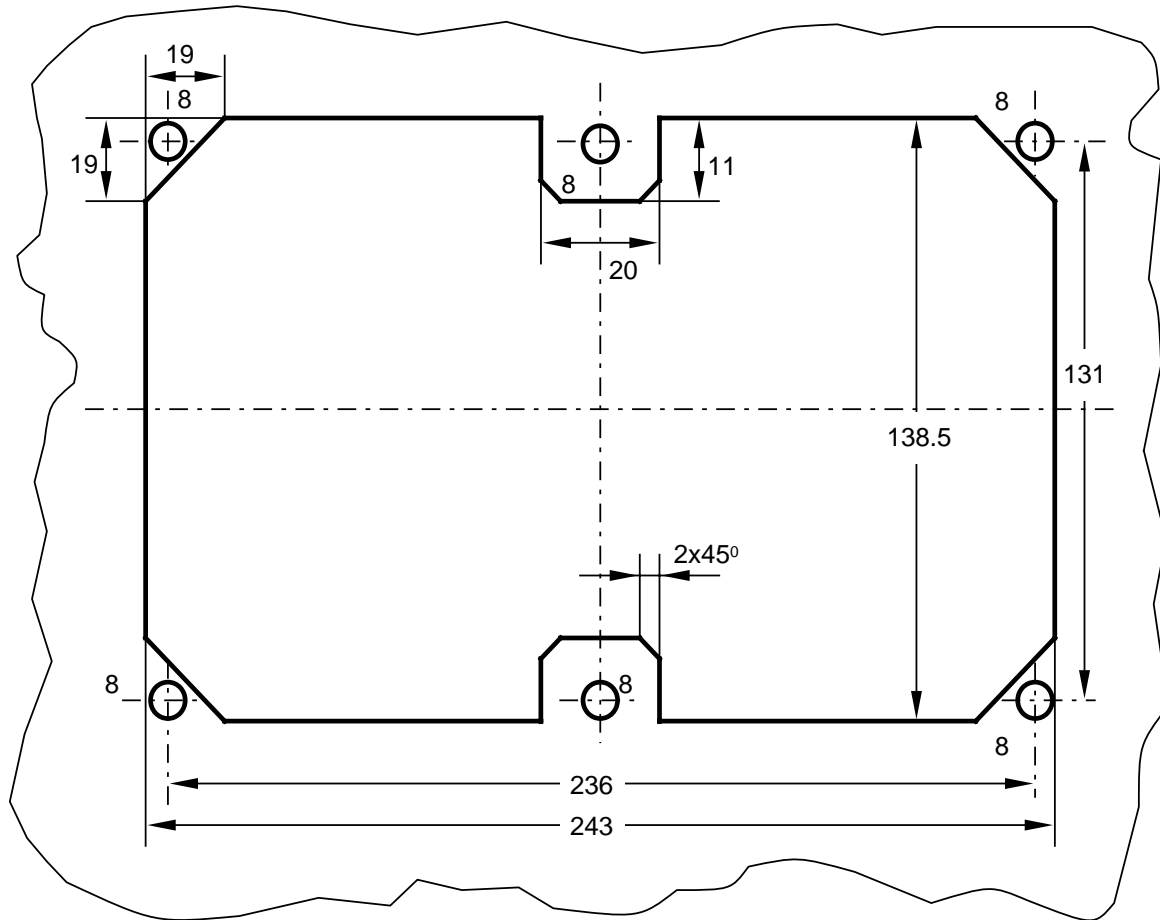

4.8.3 A-MPC handheld unit with casing**6FX2 007-1AB****Overview of A-MPC handheld units**

Order No.	Designation	Version designation in the text
6FX2007-1AB00	SINUMERIK 840C/840CE A-MPC handheld unit with single-channel emergency stop and 3.5 m cable	00
6FX2007-1AB10	SINUMERIK 840C/840CE A-MPC handheld unit with single-channel emergency stop and 10 m cable	00
6FX2007-1AB01	SINUMERIK 840C/840CE A-MPC handheld unit with two-channel emergency stop and 3.5 m cable	01
6FX2007-1AB11	SINUMERIK 840C/840CE A-MPC handheld unit with two-channel emergency stop and 10 m cable	01
6FX2007-1AB02	SINUMERIK 840C/840CE A-MPC handheld unit with two-channel emergency stop, 2nd enabling button and 3.5 m cable	02
6FX2007-1AB12	SINUMERIK 840C/840CE A-MPC handheld unit with two-channel emergency stop, 2nd enabling button and 10 m cable	02
6FX2007-1AB03	SINUMERIK 840C/840CE A-MPC handheld unit with two-channel emergency stop, 2nd enabling button, electr. isolation, handwheel signals and 3.5 m cable	03
6FX2007-1AB13	SINUMERIK 840C/840CE A-MPC handheld unit with two-channel emergency stop, 2nd enabling button, electr. isolation, handwheel signals and 10 m cable	03

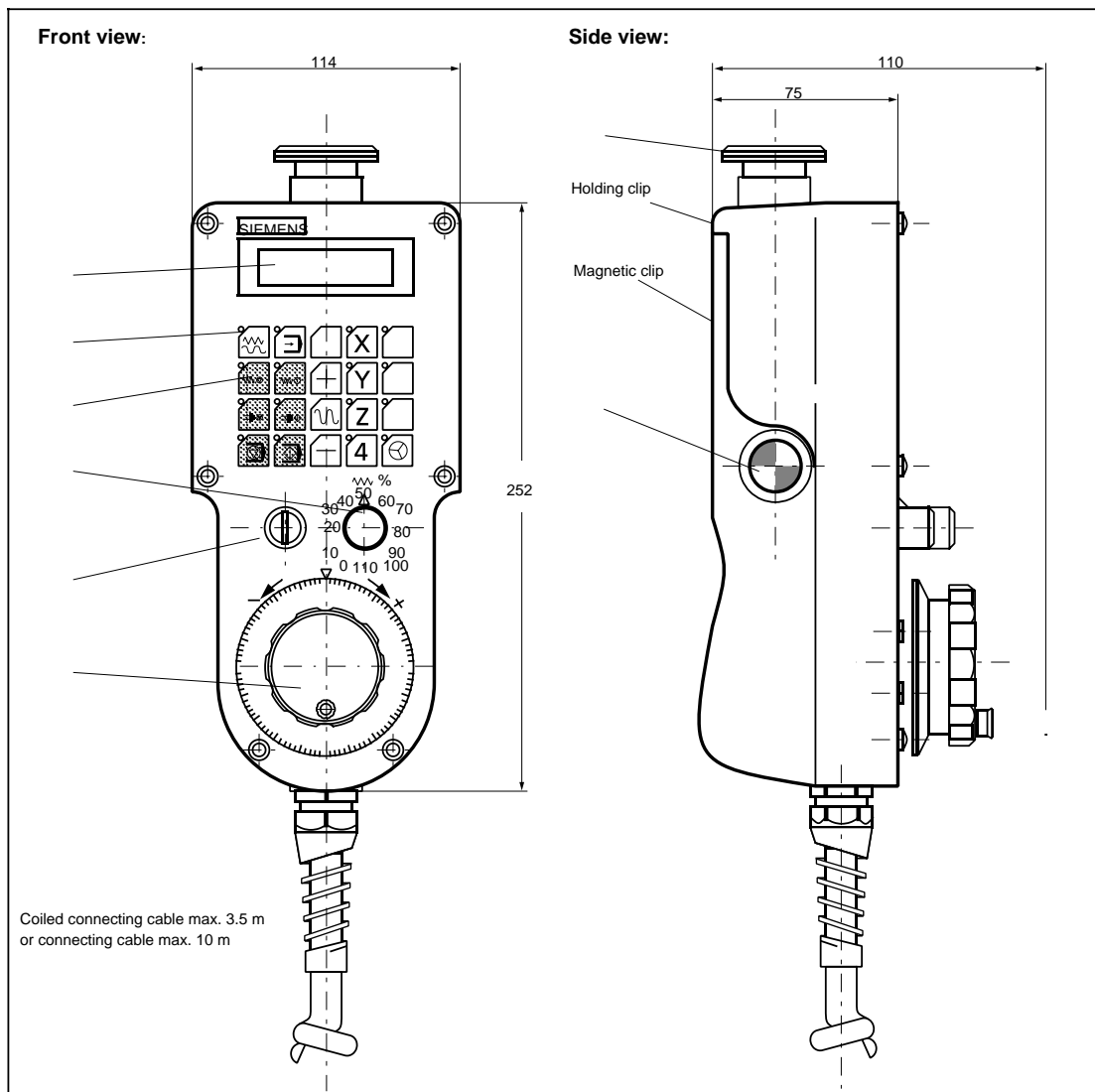

Operating and display elements

- 20 user-assignable keys. The key symbols are supplied on a labelling strip. This labelling strip can be replaced if necessary (see "Replacing the labelling strip").
- 1 rapid traverse/feedrate override switch
- 2 enabling buttons in the form of two-position switches. As from version 01, the buttons are normally-open switches and are connected in parallel (as from version 02 the buttons are accessible via separate terminals).
- 1 keyswitch with 2 positions
- 1 EMERGENCY STOP pushbutton, normally-closed switch (as from version 01 two-channel)
- 1 electronic handwheel (to be connected separately to the CSB via cable distributor, see Central Service Board subsection)
- 16 LEDs, user-settable
- 1 two-line alphanumeric display (2 x 16 characters)

Magnetic clamp:

The magnetic clamp is not designed for permanent fixing of the handheld unit to vertical metal surfaces.

Notes:

- The handwheel signals can be routed to the CSB only via distribution box and cable distributor. It is not possible to transmit the handwheel pulses via the MPC line to the NC. Up to version ...2, the handwheel signal refer to the potential "0V" (terminal 10), as from version ... 3, the handwheel is potential-free.
- Press the EMERGENCY STOP button in emergency situations:
 1. where human life is at risk.
 2. where there is a risk of machine or workpiece getting damaged.

As a rule, EMERGENCY STOP causes all drives to be brought to a controlled stop with maximum possible braking moment.

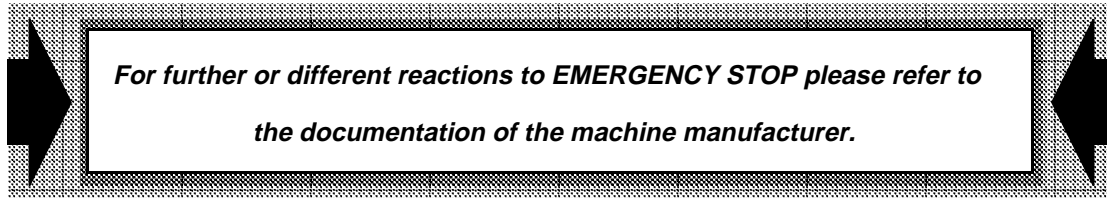
**Replacing the labelling strip**

- Release the screws on the front of the handheld unit.

Note:

- The labelling strip is located between the printed circuit board and the front of the housing and is accessible from the right from the point of view of the printed circuit.
- Carefully pull out the labelling strip half way using flat nose pliers.
- Insert the new labelling strip again half way underneath the old labelling strip.
- Remove the old labelling strip and push the new strip into its final position.

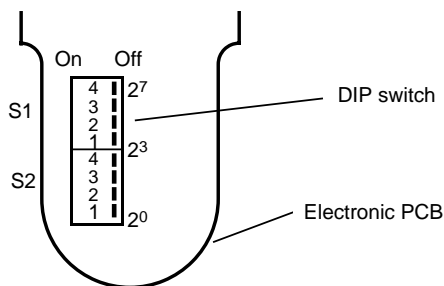
Default settings on the electronic PCB in the handheld unit (SINUMERIK 840C)**Notes:**

- On the SINUMERIK 840C the DMP station number (terminal block no.) must be set to 15 via S2 (all switches in "OFF" position). Other DMP station numbers are not allowed.
- In the case of a fault, e.g. transmission not active, the flashing message FAULT appears at the beginning of the upper line of the display. At the same time, the DMP station number appears at the end of the lower line of the display.

Hardware installation

You must connect the handheld unit to the distribution box (see following Section).

The EMERGENCY STOP key, the acknowledge keys and the signals from the handwheel are not routed to the PLC, but rerouted in the X3 terminal block in the distribution box, which is also used for the power supply of the handheld unit. All other signals are transferred between the distribution box and the PLC via an MPC line.

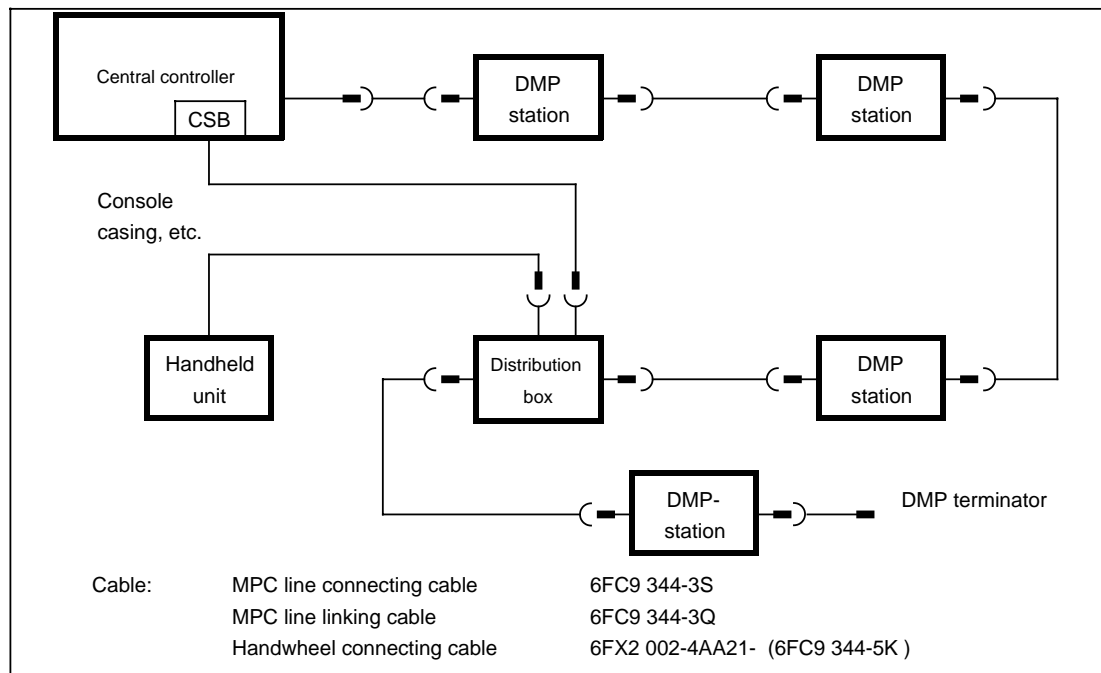

The DMP stations and the distribution box for the handheld unit can be connected in any order.

Notes:

- It is, however, recommended to link the handheld unit at the end of the MPC line. In that case, a DMP terminator **must not be connected**. In the handheld unit version with 10 m of connecting cable, the handheld unit must be connected at the end of the MPC line.
- The maximum cable length for each MPC subline is 50 m. The length of the coiled cable at the handheld unit is max. 3.5 m or 10 m.
- Like all other DMP stations, the handheld unit must not be connected to or disconnected from the MPC interface module unless the power supply of the central controller and all other DMP stations is switched off.

Power-on and fault display (run-up display)

After being switched on, the unit first runs a test of the display elements. All LEDs are bright for about 5 s. A scratch character moves through the whole line in both lines. In the course of these 5 s, each of the 16 characters is displayed once.

Subsequently regular operation of the handheld unit starts.

After power-on (run-up), operation will always be faulty until the PLC has completely run up.

The fault display does not distinguish run-up and faults occurring during operation.

During normal operation, the data from the MPC are displayed depending on the mode set.

User interface

Key and LED arrangement

L1 K1	L6 K6	K21	L11 K11	L2 K2
L3 K3	L8 K8	K22	L12 K12	L7 K7
L4 K4	L9 K9	K23	L13 K13	L16 K16
L5 K5	L10 K10	K24	L14 K14	L15 K15

K=Key
L=LED

Input image, handheld unit

Byte No.	Bit No.								
	7	6	5	4	3	2	1	0	
IB _m	reserved								
IB _{m+1}									
IB _{m+2}	T8	T7	T6	T5	T4	T3	T2	T1	
IB _{m+3}	T16	T15	T14	T13	T12	T11	T10	T9	
IB _{m+4}	T24	T23	T22	T21					
IB _{m+5}	Acknow. number display	Key switch	Rapid traverse/feedrate override switch						
			E	D	C	B	A		

m = address of the input image set via machine data

Output image: LED signals (handheld unit)

Byte No.	Bit No.							
	7	6	5	4	3	2	1	0
QB m	Handheld unit mode							
QB m +1	New data for selected line							Select line
QB m +2	L8	L7	L6	L5	L4	L3	L2	L1
QB m +3	L16	L15	L14	L13	L12	L11	L10	L9

m = address of output image set via machine data

Output image: digital display (handheld unit)

Byte No.	Bit No.							
	7	6	5	4	3	2	1	0
QB m +8								Defines the 1st character (right) of the selected line
QB m +9								Defines the 2nd character of the selected line
QB m +22								Defines the 15th character of the selected line
QB m +23								Defines the 16th character (left) of the selected line

Signal description:

- Handheld unit mode, QBm, bit 7

The handheld unit A-MPC can be switched to one of the following two modes:

QBm, Bit 7=0: mode for one-line display (upper line)

Bit 7=1: mode for two-line display

- Mode for one-line display

In this mode, the digital display is used as a one-line, $7\frac{1}{2}$ -character, numeric display (upper line only); a decimal point can be assigned to each position. The display data are coded as hexadecimal values (bits 0 ... 3) via the QBm+16 ... +22 bytes. Bit 4=0 activates the decimal point with the following restrictions:

The decimal point must be activated only **once** within the $7\frac{1}{2}$ positions. If more than one decimal point is programmed, only the one with the lowest address is valid (that is the one the furthest to the right in the display); all other decimal points programmed are ignored.

The display always starts right-adjusted at the 4th position with byte QBm+16 and, depending on whether a decimal point exists or not, it is generated from right to left with variable length from the 4th to the 10th/11th position.

Depending on whether a decimal point exists or not, the possible one of the highest data position (QBm+23) is at the 11th/12th position of the display. The sign of the highest position (QBm+23) is always at the 13th position of the display.

Display format:

Examples with decimal point

Displ. pos.	16	15	14	13	12	11	10	9	8	7	6	5	4	3	2	1
QBm+ ...				23		22	21	20	19		18	17	16			
Display				+	1	2	3	4	5	.	6	7	8			

Displ. pos.	16	15	14	13	12	11	10	9	8	7	6	5	4	3	2	1
QBm+ ...				23		22	21	20	19	18	17	16				
Display				+	1	.	2	3	4	5	6	7	8			

Example without decimal point

Displ. pos.	16	15	14	13	12	11	10	9	8	7	6	5	4	3	2	1
QBm+ ...				23		22	21	20	19	18	17	16				
Display				+		1	2	3	4	5	6	7	8			

Code conversion:
 Display positions from byte QBm+16 ... QBm+22

2-digit display (with decimal point), bit 4=0		1-digit display (without decimal point), bit 4=1	
Digit	Byte assignment	Display	Byte assignment
0.	xxx 0 0000	0	xxx 1 0000
1.	xxx 0 0001	1	xxx 1 0001
2.	xxx 0 0010	2	xxx 1 0010
3.	xxx 0 0011	3	xxx 1 0011
a.	xxx 0 1010	a	xxx 1 1010
b.	xxx 0 1011	b	xxx 1 1011
c.	xxx 0 1100	c	xxx 1 1100
d.	xxx 0 1101	d	xxx 1 1101
e.	xxx 0 1110	e	xxx 1 1110
f.	xxx 0 1111	f	xxx 1 1111

Highest display position from byte QBm+23, bit 4=0 : with decimal point
 bit 4=1 : without decimal point

Display	Byte assignment
+. .	xxx 0 1101
+1.	xxx 0 0000
1.	xxx 0 0001
	xxx 0 0011
-. .	xxx 0 1010
-1.	xxx 0 0100
(blank).	xxx 0 Rest
+	xxx 1 1101
-	xxx 1 1010
(blank)	xxx 1 Rest
-1	xxx 1 0100
+1	xxx 1 0000

2. Mode for two-line display

In this mode, the digital display can be used as two-line, alphanumeric display with 16 positions per line.

The display data are coded via bytes QBm+8 to QBm+23 according to the character set shown in the table "ASCII code of digital display". The decimal position requires a position of its own. The display always starts line-by-line right-adjusted with byte QBm+8 and is generated from right to left until QBm+23.

- **SELECT LINE, QBm+1, bit 0**
The line to be written is selected by
QBm+1, bit 0=0 : 1st line is selected
bit 0=1 : 2nd line is selected
- **NEW DATA FOR SELECTED LINE, QBm+1, bit 7**
QBm+1, bit 7=0 : Reset request.
bit 7=1 : Set request. This bit requests new data to be written in a line. This bit is set by the user program and can be reset by means of the acknowledgement bit IBm+5, bit 7.
- **ACKNOWLEDGE DIGITAL DISPLAY, IBm+5, bit 7**
IBm+5, bit 7=0/1: Acknowledgement bit is set by the system if the new data are accepted.

Signal flow: Writing data for two lines

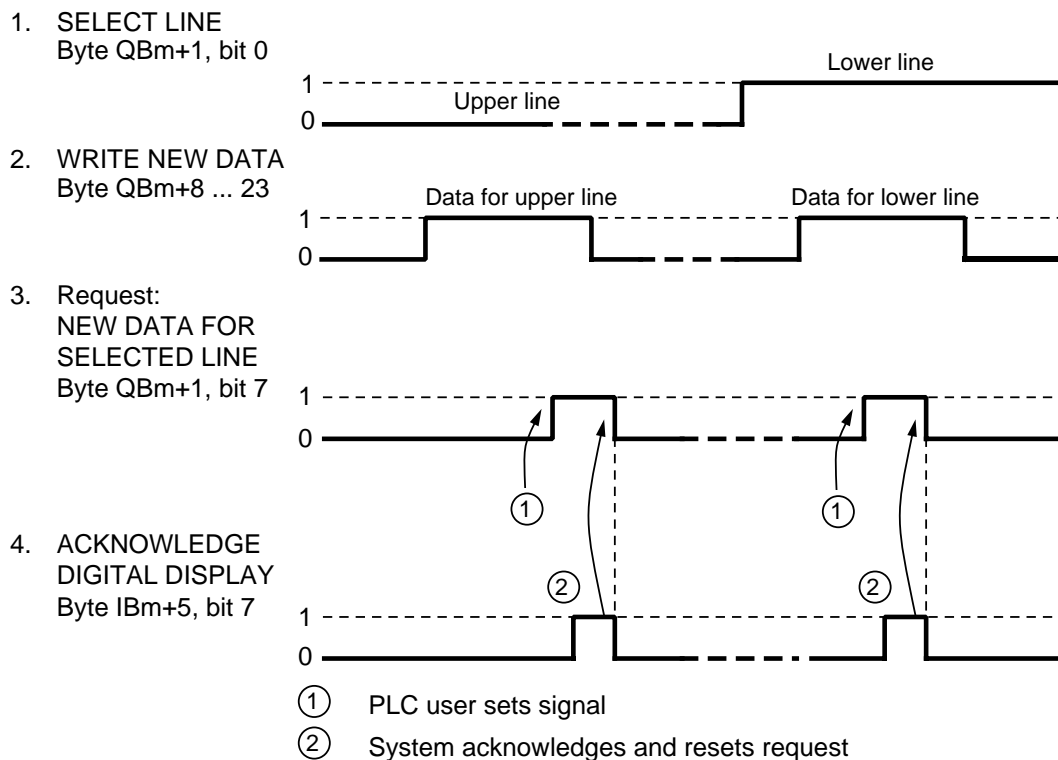

ASCII code of digital display

Bit 7 to 4												Bit 3 to 0
0010	0011	0100	0101	0110	0111	1010	1011	1100	1101	1110	1111	
												0000
												0001
												0010
												0011
												0100
												0101
												0110
												0111
												1000
												1001
												1010
												1011
												1100
												1101
												1110
												1111

Example:
 Representation of **A** : KM 0100 0001

4.8.3.1 Distribution box for handheld unit

6FX2 006-1BC0

The distribution box is the link between the handheld unit and the MPC line.

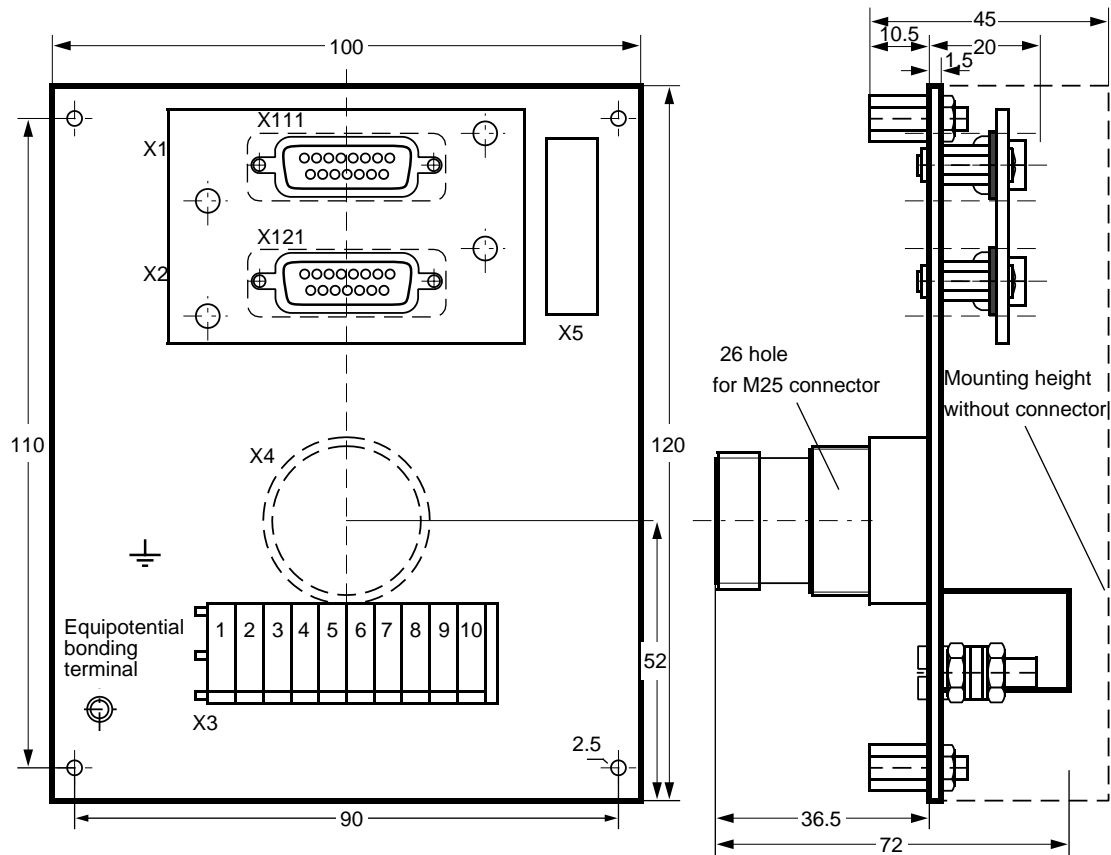
**Note:**

- If a hole is drilled (e.g. in a control cabinet) for the screw-type terminal X4, the IP54 degree of protection must be ensured.
- As from handheld unit 6FX2 007-1AB01, a 2nd EMERGENCY STOP channel with terminals 11 and 12 on distribution box 6FX2 006-1BC01 is provided.
- The 2nd EMERGENCY STOP channel (terminals 11 and 12) must not be connected if handheld unit 6FX2 007-1AB00 is connected to the distribution box (can cause damage to handheld unit).
- The short-circuit switch provided with distribution box 6FX2 006-1BC01 is not required for the SINUMERIK 840C.

Description of the interfaces

X1/X111, X2/X121: Interface for link to the MPC line
 X3: Terminal connector for operator control elements of the handheld unit;
 13 terminals for 1.5 mm²:

Assignment:

- Terminal 1 : EMERGENCY STOP
 - Terminal 2 : EMERGENCY STOP
 - Terminal 3 : Handwheel pulses A
 - Terminal 4 : Handwheel pulses *A
 - Terminal 5 : Handwheel pulses B
 - Terminal 6 : Handwheel pulses *B
 - Terminal 7 : Acknowledge key 1
 - Terminal 8 : Acknowledge key 2
 - Terminal 9 : +24 V
 - Terminal 10 : 0 V
 - Terminal 11 : EMERGENCY STOP 2
 - Terminal 12 : EMERGENCY STOP 2
 - Terminal 13 : Acknowledge key (24 V, 2 A) Common input
- } Switching capacity of loop:
 } 24 V; 2 A
- } Switching capacity of loop:
 } 24 V; 1 A

X4: Interface for connecting the handheld unit (threaded connection)
 X5: MPI interface for SINUMERIK 840D/FM-NC (version as from 06.95)

Connection diagram enable keys

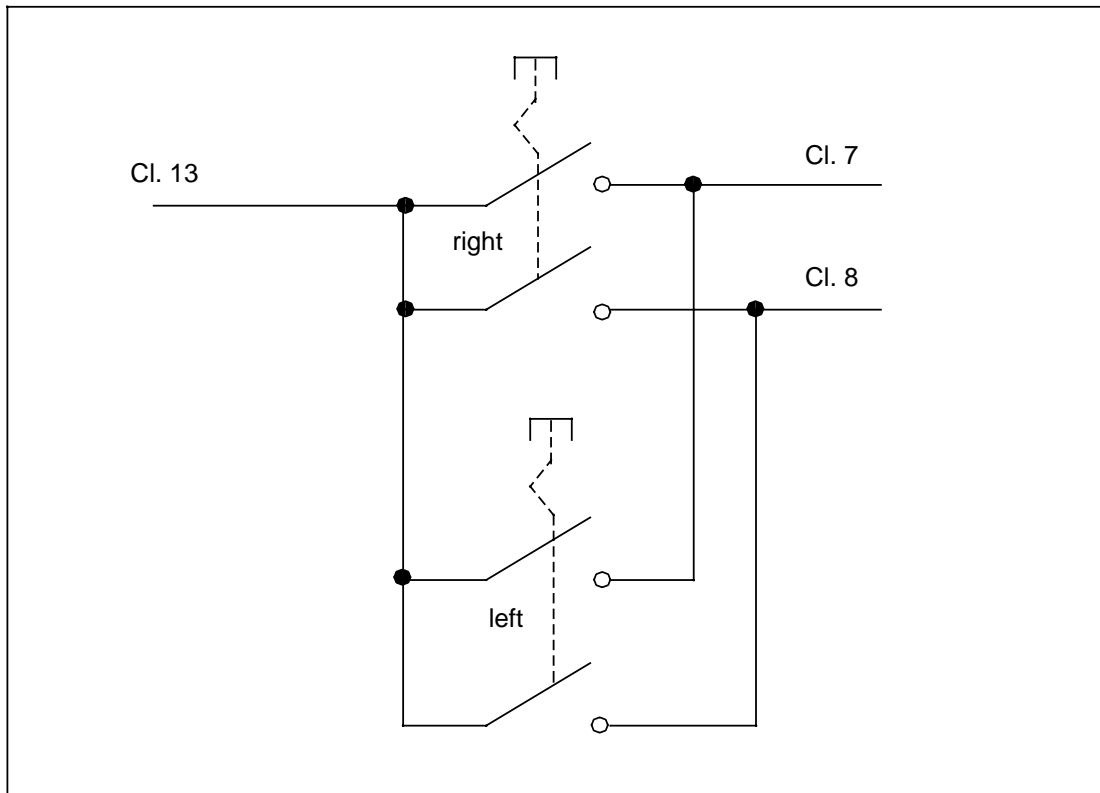

Note:

If inductive loads shall be switched via the enable keys, these loads are to be connected with free-wheeling diodes. A connection with varistors or RC components will not suffice.

4.8.4 Earthing concept for distributed machine peripherals

The interference currents are diverted to earth via the shielding plates. So that these diverted currents do not themselves become a source interference, they should be given a low resistance path to earth.

- Tighten all cable connector, module and reference potential conductor fixing screws.
- Protect reference potential conductor contact areas from corrosion.
- Short reference potential conductors, diameter 10 mm²

All 24 V supply voltage inputs should refer to the same ground. This also applies to electrically isolated modules.

The DMP cable shield must be connected at both ends. Each DMP station is equipped with its own reference potential conductor.

See Section 3.4.1.1, Installation of equipotential bonding conductors, for further information.

END OF SECTION

5 External Devices and Accessories

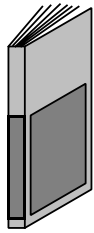

Please also refer to the descriptions in Catalog NC Z, Accessories for SINUMERIK, SIROTEC, SIMODRIVE and Equipment for Special Machines.

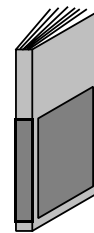

The devices and accessories are listed in alphabetical order.

5.1 Devices and accessories

Device	Order number
Electronic handwheels	
– Electronic handwheel, large	6FC9 320-5DB
– Electronic handwheel, small	6FC9 320-5DC
– Electronic handwheel with casing	6FC9 320-5DE
3.5" FD-E1 built-in floppy drive	6FC9 310-1NA00
Spring-disk coupling with clamp ¹⁾	6FC9 320-4GB 6FC9 320-4GA
INDUCTOSYN scale	6FC9 198-2CA00
INDUCTOSYN cursor	6FC9 198-2CB00
INDUCTOSYN pre-amplifier	6FC9 320-4FC
INDUCTOSYN converter (1 axis)	6FC9 320-3GK
Terminal strip converter, 37-pin with LEDs	6FC9 302-2BD01
Power supply unit 400 V AC	
– Input 3 400 V AC, output 24 V DC / 10 A	6EV1 337-5AK
– Input 3 400 V AC, output 24 V DC / 20 A	6EV1 354-5AK
– Input 3 400 V AC, output 24 V DC / 40 A	6EV1 364-5AK
Cover for power supply units to give degree of protection IP20	6XB9 798-0SV00
Standard PC keyboard (MF II) with special NC keys	6FC5 103-0AC03-0AA0 6FC5 203-0AC01-0AA0
Valitek PST-160 streamer	6FC9 310-1NB00
ST-600XD magnetic tape Memory capacity 160 Mbytes for Valitek PST-160 streamer	6FC9 310-1NC00
Valitek PST2 - M1200 streamer	6FX2 007-2AA00
CS-600SX magnetic tape Memory capacity 600 Mbytes for Valitek PST2-M1200 streamer	6FX2 007-2AB00
Rotary encoder, high-resolution, for rotary axes	
– ROD 250	6FC9 320-3CM00
– RON 255	6FC9 320-3CN00

1) 3 clamps are required for each encoder

Devices and accessories, continued

Device	Order number		
Rotary encoder, incremental, and main spindle encoder ¹⁾ with axial cable outlet <ul style="list-style-type: none"> – 500 pulses/rev – 1000 pulses/rev – 1024 pulses/rev – 1250 pulses/rev – 1500 pulses/rev – 1800 pulses/rev – 2000 pulses/rev – 2500 pulses/rev – 5000 pulses/rev 	Shaft encoder with cable <table style="width: 100%; border: none;"> <tr> <td style="width: 50%;"></td> <td style="text-align: right;">with flanged socket outlet</td> </tr> </table> 6FC9 320-3HS01 6FC9 320-3HS21 6FC9 320-3KA01 6FC9 320-3KA21 6FC9 320-3KB01 6FC9 320-3KB21 6FC9 320-3KE01 6FC9 320-3KE21 6FC9 320-3KG01 6FC9 320-3KG21 6FC9 320-3KH01 6FC9 320-3KH21 6FC9 320-3KK01 6FC9 320-3KK21 6FC9 320-3KN01 6FC9 320-3KN21 6FC9 320-3KS01 6FC9 320-3KS21		with flanged socket outlet
	with flanged socket outlet		
Rotary encoder, incremental, and main spindle encoder ¹⁾ with radial cable outlet <ul style="list-style-type: none"> – 500 pulses/rev – 1000 pulses/rev – 1024 pulses/rev – 1250 pulses/rev – 1500 pulses/rev – 1800 pulses/rev – 2000 pulses/rev – 2500 pulses/rev – 5000 pulses/rev 	Schaft encoder with cable <table style="width: 100%; border: none;"> <tr> <td style="width: 50%;"></td> <td style="text-align: right;">with flanged socket outlet</td> </tr> </table> 6FC9 320-3LS01 6FC9 320-3LS21 6FC9 320-3MA01 6FC9 320-3MA21 6FC9 320-3MB01 6FC9 320-3MB21 6FC9 320-3ME01 6FC9 320-3ME21 6FC9 320-3MG01 6FC9 320-3MG21 6FC9 320-3MH01 6FC9 320-3MH21 6FC9 320-3MK01 6FC9 320-3MK21 6FC9 320-3MN01 6FC9 320-3MN21 6FC9 320-3MS01 6FC9 320-3MS21		with flanged socket outlet
	with flanged socket outlet		
Combined rotary encoder for spindle and C axis – 1024/9000 pulses/rev	6FC9 320-3KT00		
Linear scale adapter	6FC9 320-4HM12		
Resolver	6FC9 320-2BC 6FC9 320-2HC 6FC9 320-2WD		
Resolver converter	6FC9 320-3GL		
SIPOS encoder <ul style="list-style-type: none"> – SIPOS, unconditioned signal (axial connector) – SIPOS, unconditioned signal (radial connector) – SIPOS, absolute signal (axial connector) – SIPOS, absolute signal (radial connector) 	6FC9 320-3CS 6FC9 320-3CW 6FC9 320-3CT 6FC9 320-3CV		
SIMATIC 185 U EU	see SIMATIC catalog		

1) Without spring disk coupling and clamp

5.2 Electronic handwheels

5.2.1 Electronic handwheel, large

6FC9 320-5DB

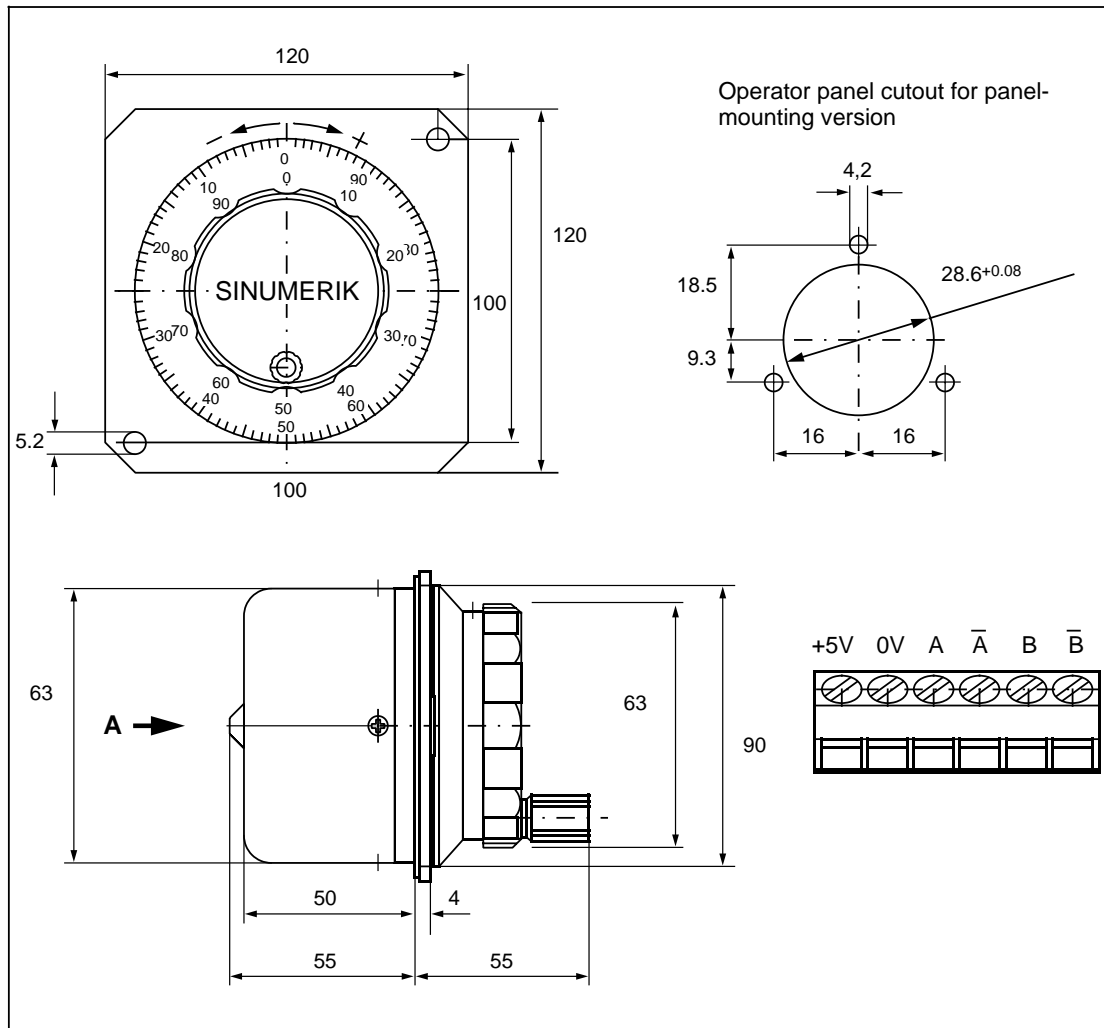

Technical data:	
Signals:	2x100 pulses/revolution
Operating voltage:	5 V±5 %
Output circuit to	RS 422 A
Housing, front panel and handwheel	Light metal with bright eloxal coating Engraving filled with paint
Degree of protection to DIN 40050	Front panel IP65 Rear IP50
Connection:	Small oblique print terminal

Outputs	
A=Antivalent	
RS 422 A	
A', B'	
Load current:	20 mA

Output pulses	

5.2.2 Electronic handwheel, small

6FC9 320-5DC

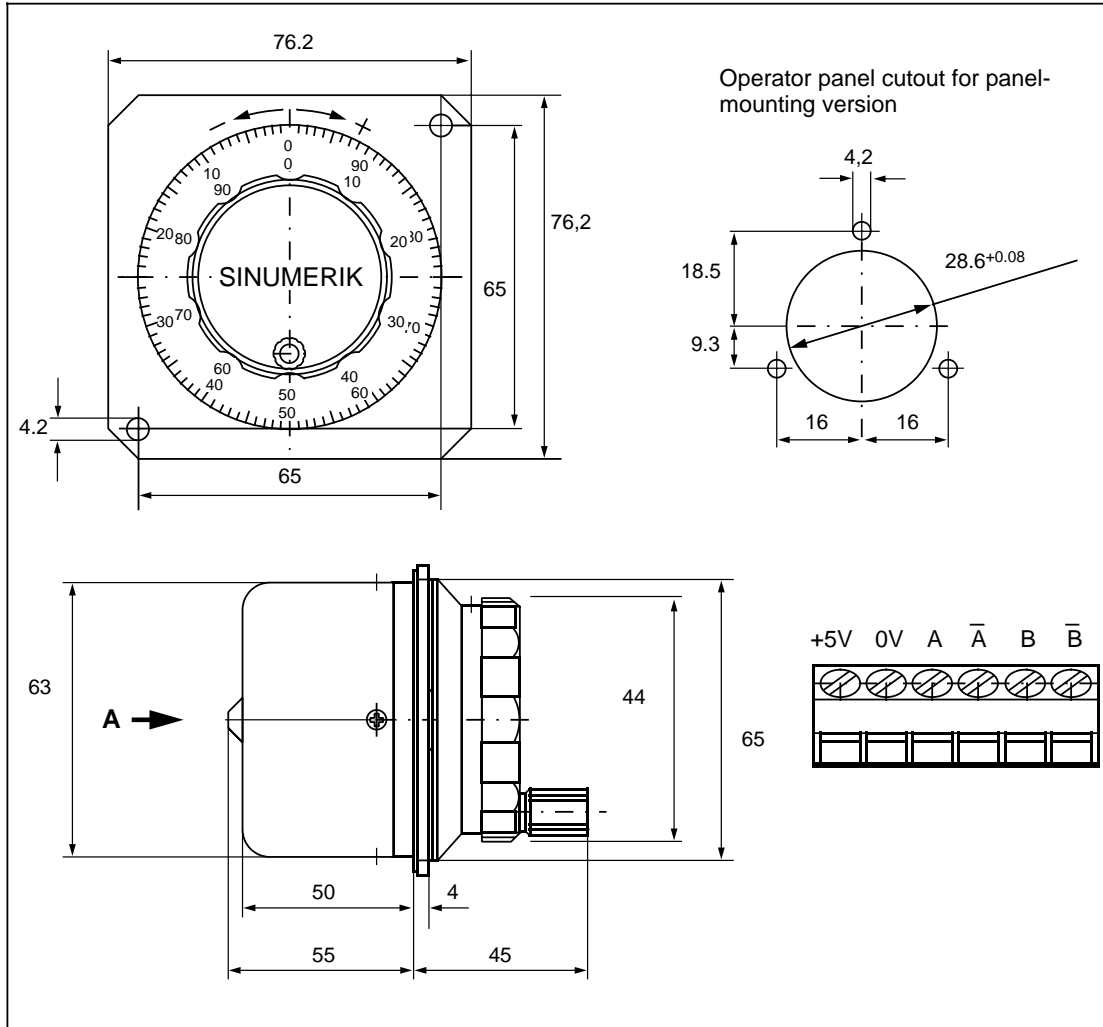

Technical data:		Outputs A=Antivalent RS 422 A	Output pulses 360° 150° 75°
Signals:	2x100 pulses /revolution		
Operating voltage:	5 V±5 %		
Output circuit to	RS 422 A		
Housing, front panel and handwheel	Light metal with bright eloxal coating Engraving filled with paint	Load current: 20 mA	
Degree of protection to DIN 40050	Front panel IP65 Rear IP50		
Connection:	Small oblique print terminal		

5.2.3 Electronic handwheel with housing

6FC9 320-5DE00

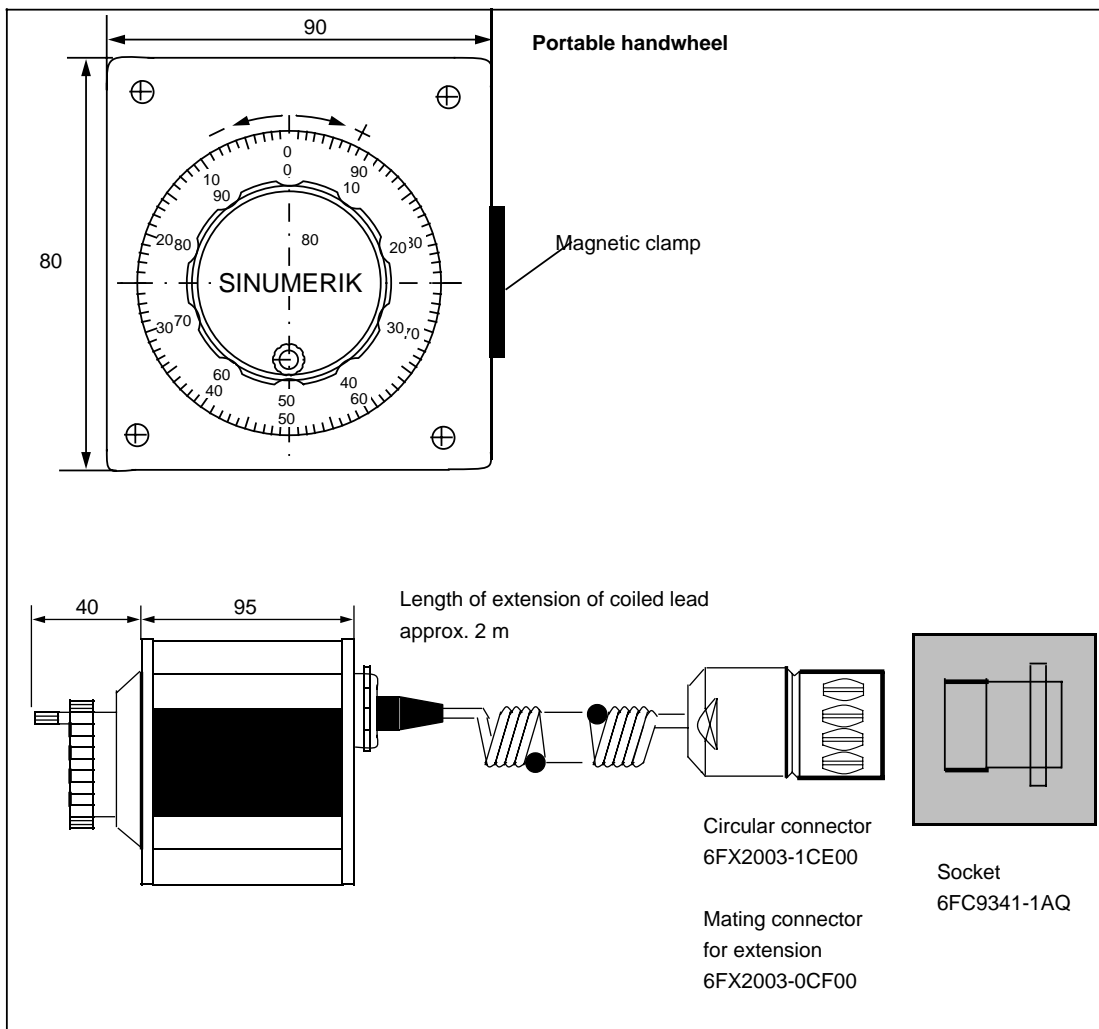

Technical data:

Signals:	2x100 pulses/revolution	Signal assignment of circular connector 6FX2003-1CE00 (6FC9341-1AT)
Operating voltage:	5 V±5 %	
Output circuit to	RS 422 A	
Housing, front panel and handwheel	Light metal with bright eloxal coating Engraving filled with paint	
Degree of protection to DIN 40050	Front panel IP65 Rear IP50	
Connection:	9-pin circular connector	
Load current:	20 mA	

Pin	Signal
1	5V
2	0V
3	B
4	A
9	Shield

5.3 3.5" FD-E1 built-in floppy drive

6FC9 310-1NA00

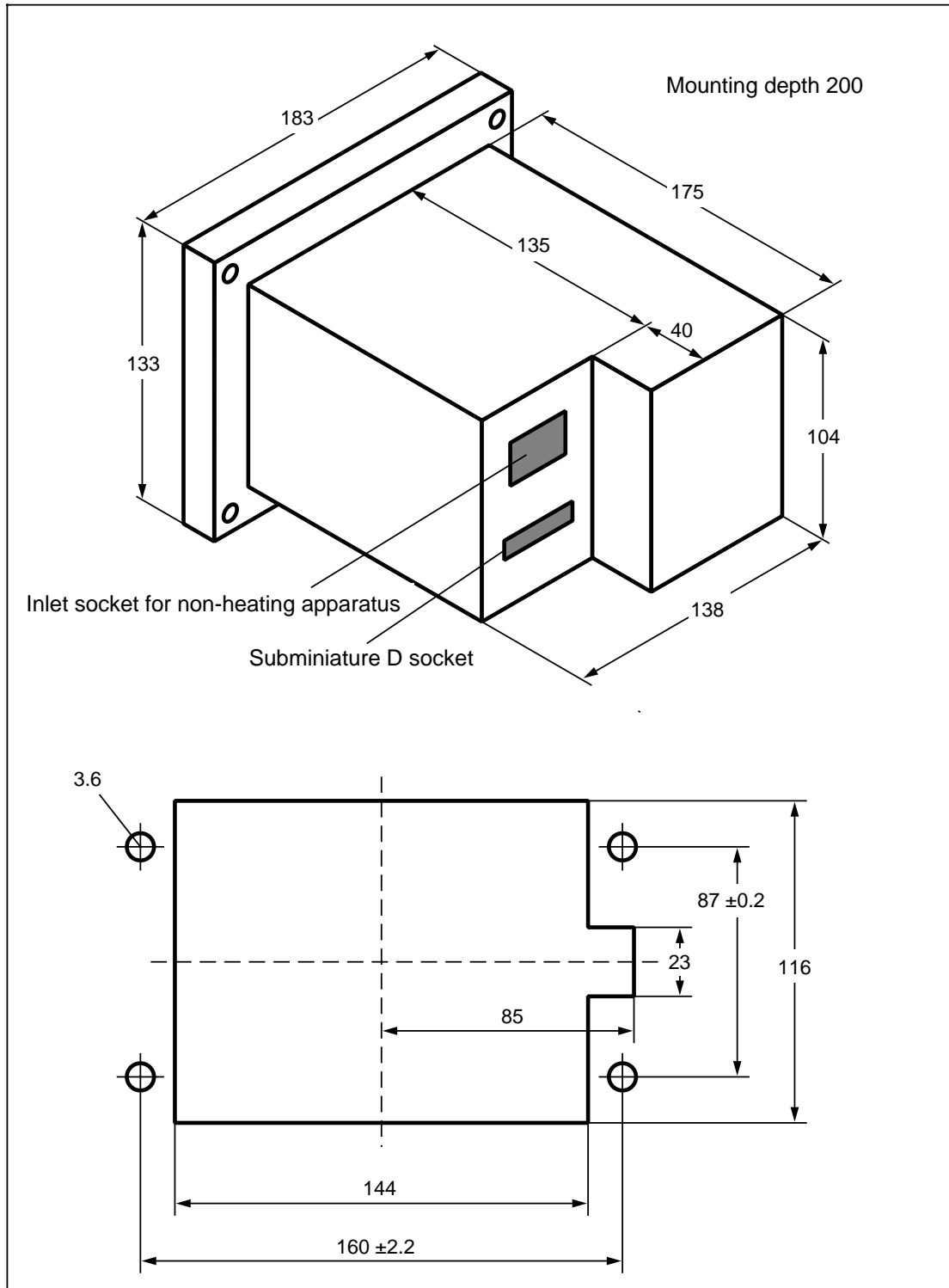

5.4 Spring disk coupling with clamp

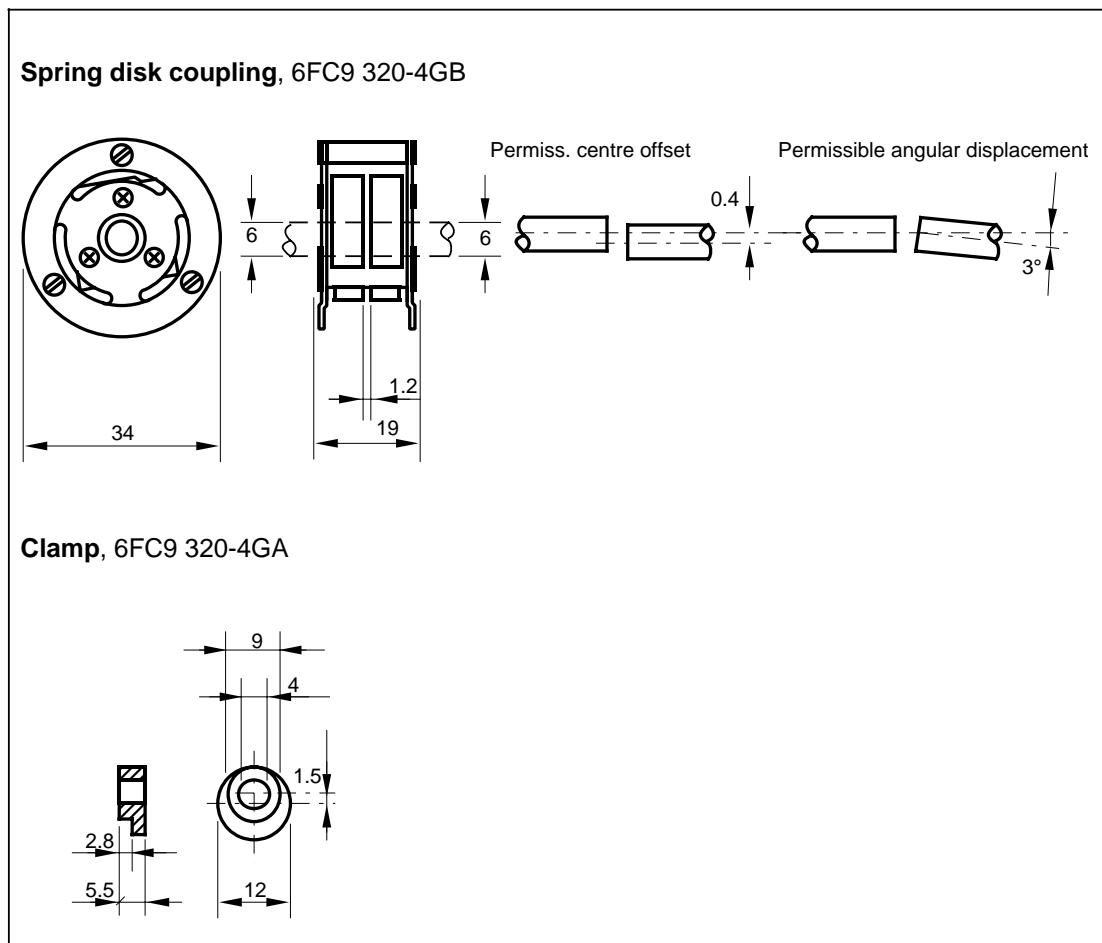

5.5 INDUCTOSYN converter INDUCTOSYN pre-amplifier

6FC9 320-3GK
6FC9 320-4FC

5.5.1 Wiring

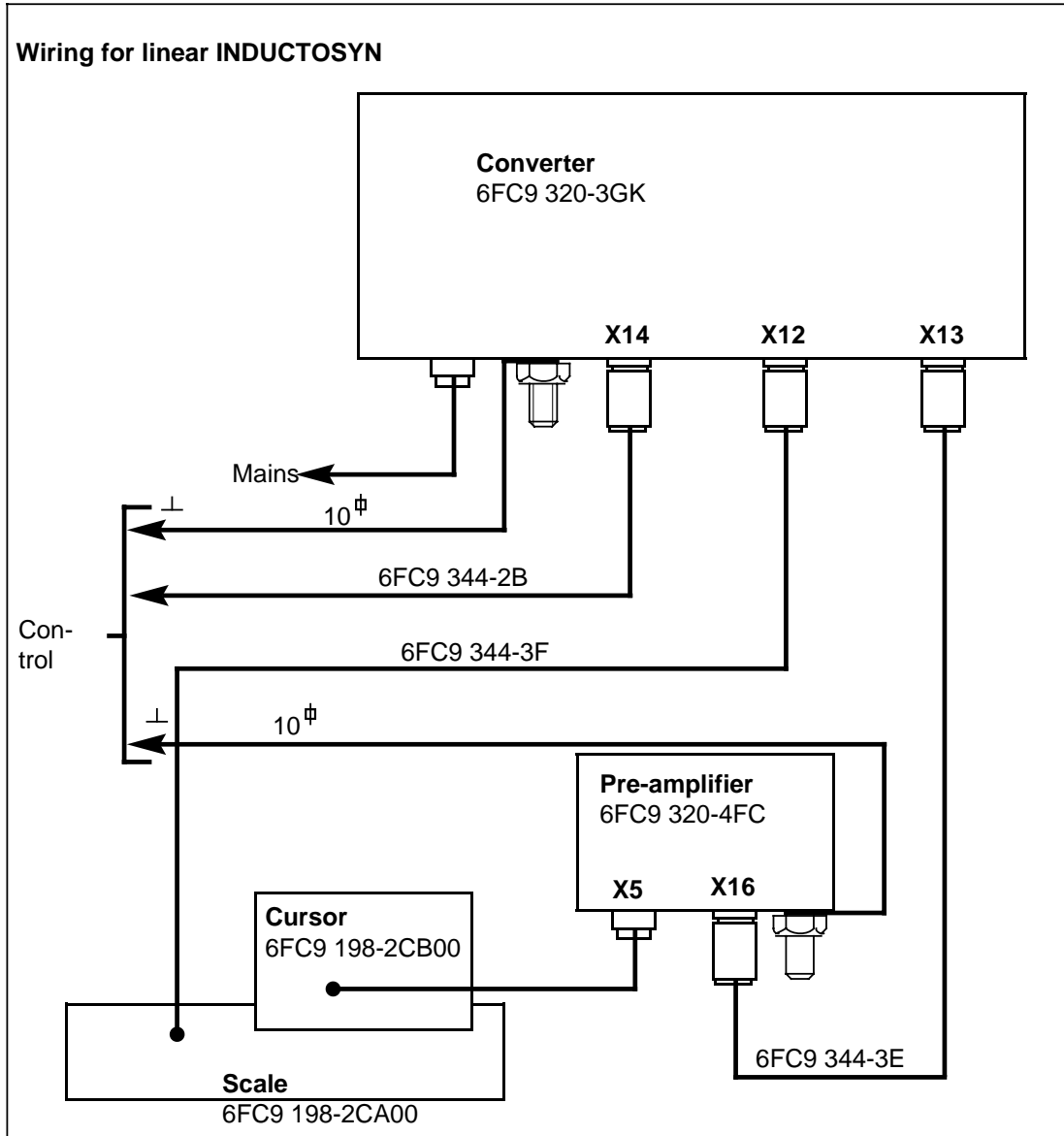

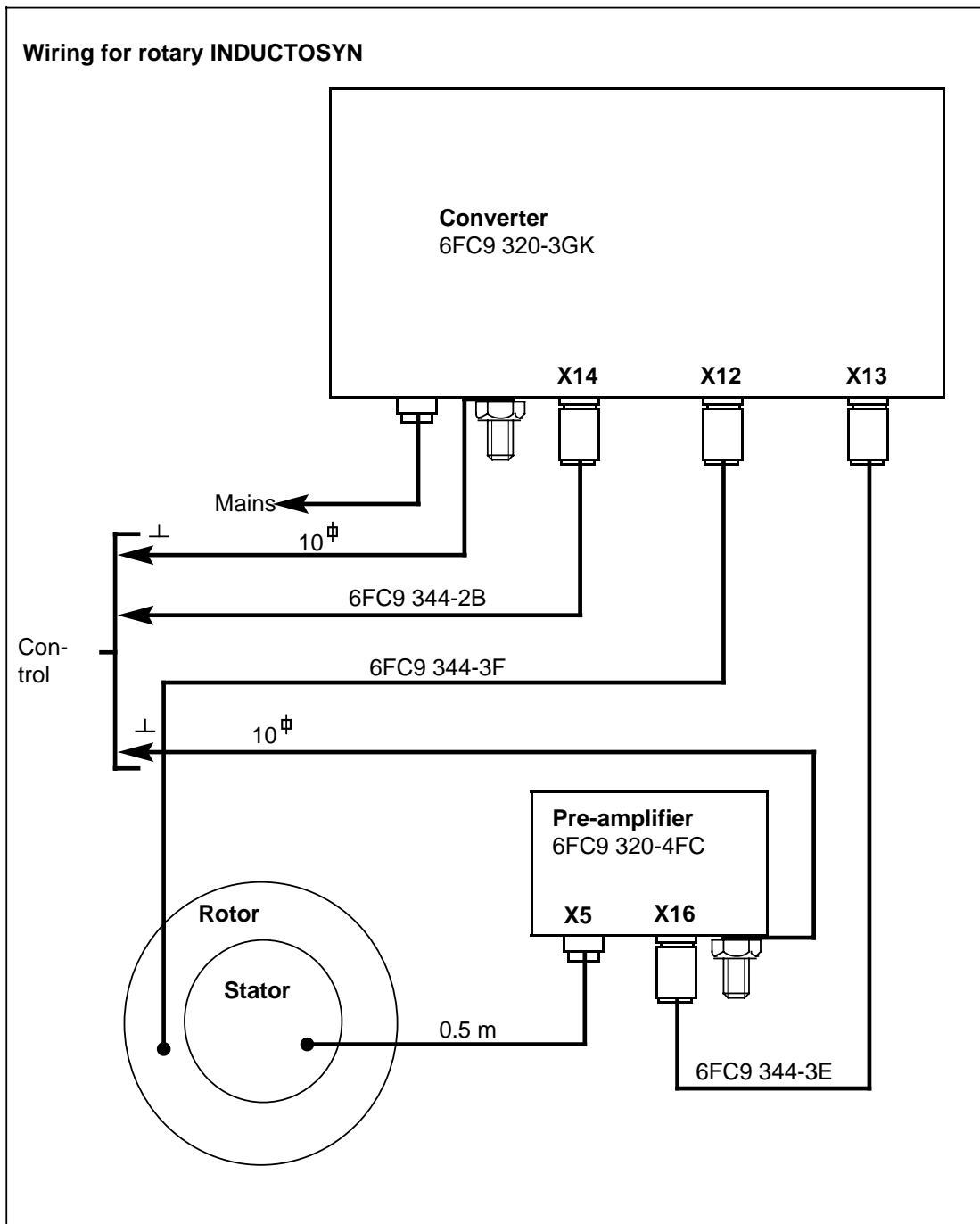

5.5.2 Dimension drawings

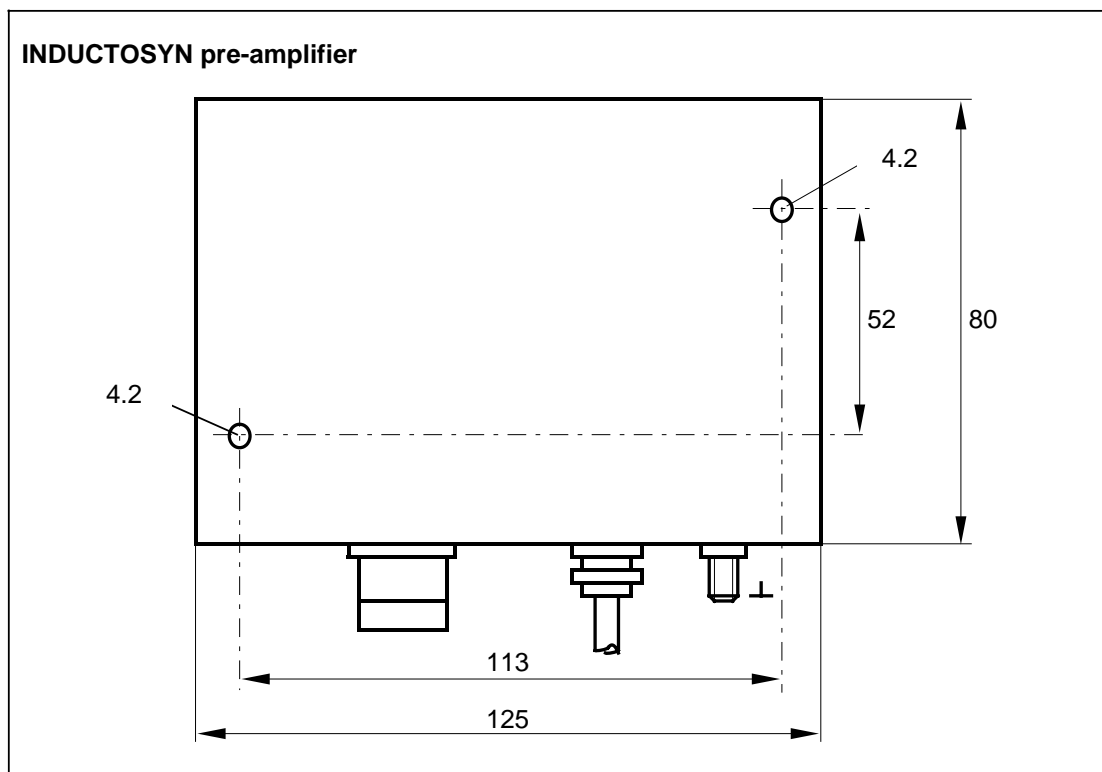
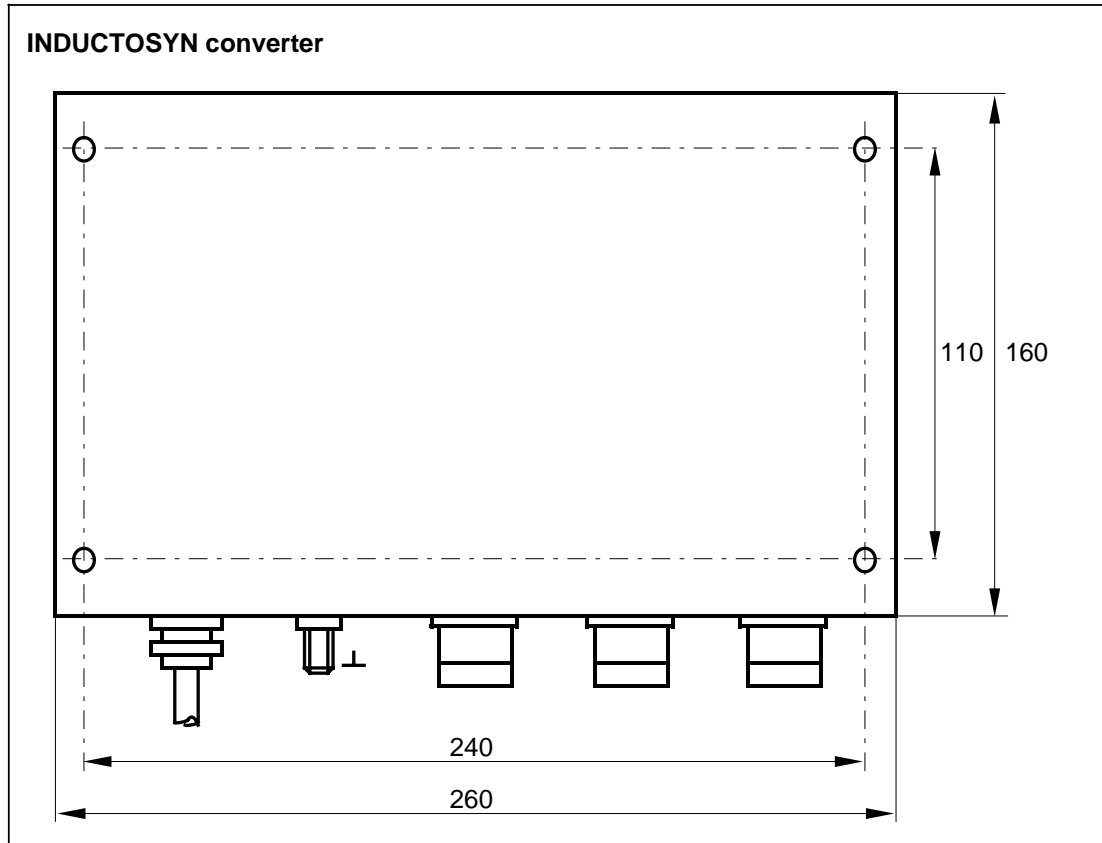

5.6 Terminal strip converter, 37-pin, for input module and mixed input/output module (with LEDs)

6FC9 302-2BD01

Nominal voltage:	24 V-
Number of transmitted signals:	37
Nominal current:	0.5 A (x 37 connections)
LEDs, green:	37-way (plug-type, replaceable)
LED current:	approx. 2 mA
Connection type:	37-pin Sub D male connector/screw terminal
Nominal cross-section:	1.5 mm ² (screw terminal)
Designation:	SIEMENS 6FC9 302-2BD01
Locating socket:	TS 32/TS 35
Color:	RAL 7032

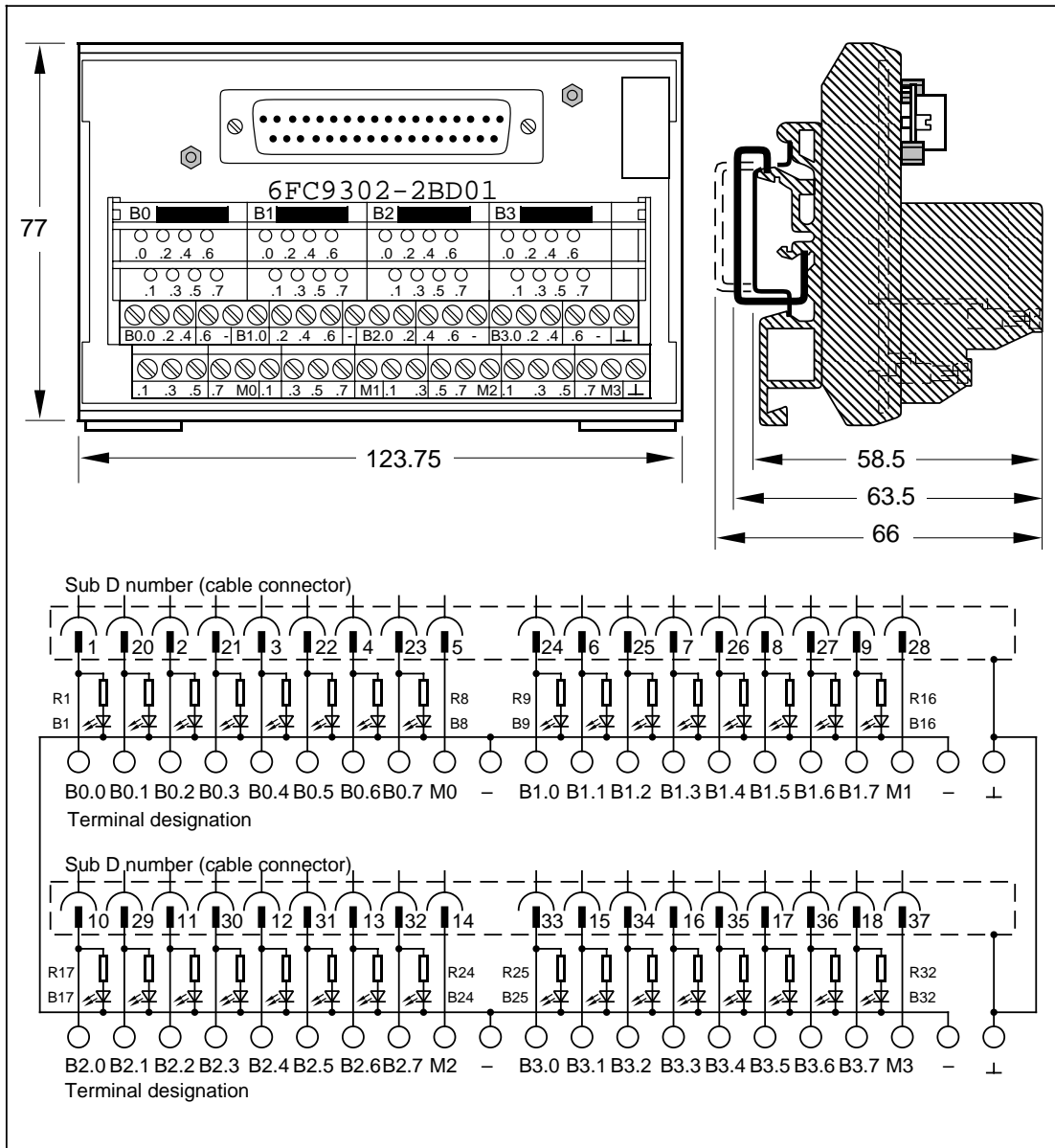

5.7 400 V AC power supply units

Input 3 400 V AC, output 24 V DC / 10 A
 Input 3 400 V AC, output 24 V DC / 20 A
 Input 3 400 V AC, output 24 V DC / 40 A

Order No.: **6EV1 337-5AK**
 Order No.: **6EV1 354-5AK**
 Order No.: **6EV1 364-5AK**

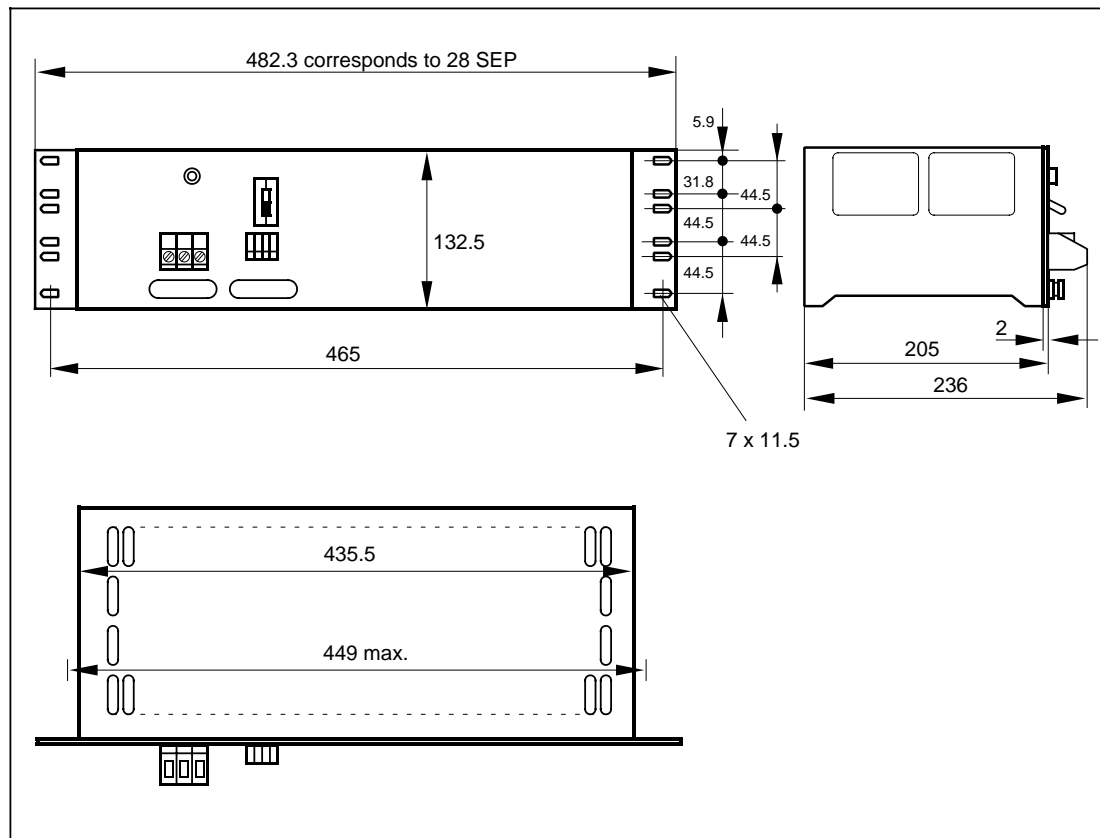

Supply	Terminal	Jumper to terminal
220 V, delta	U4, V4, W4	U4-W2, V4-U2, W4-V2
240 V, delta	U3, V3, W3	U3-W2, V3-U2, W3-V2
254 V, delta	U1, V1, W1	U1-W2, V1-U2, W1-V2
380 V, star	U4, V4, W4	U2-V2-W2
415 V, star	U3, V3, W3	U2-V2-W2
440 V, star	U1, V1, W1	U2-V2-W2

5.8 Standard PC keyboard (MF-II)

A standard PC (MFII) can be connected in addition to the full CNC keyboard via the operator panel and keyboard interface. The control can then be operated either via the CNC full keyboard or the PC keyboard.

Comments:

- Direct machine control functions should not be triggered from the standard PC keyboard.
- The MF-II keyboard should be used for startup and servicing only.
- Standard PC keyboard (MFII) with special NC keys and 5-way DIN connector, **6FC5103-0AC03-0AA0**

Note:

The standard PC keyboard can be connected to the following components:

- 19" slimline operator panel
- Keyboard interface
- MMC CPU

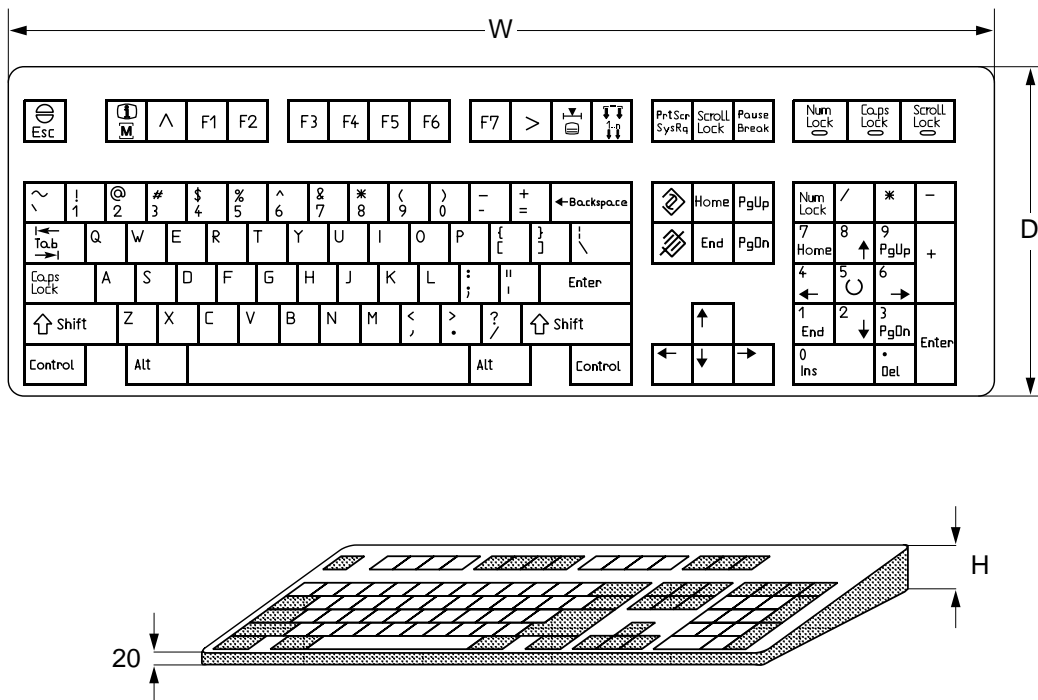

Loose key caps and insert labels are supplied with the standard PC keyboard for adapting the labelling to the softkeys of the SINUMERIK 840C.

Technical data	
Degree of protection to EN 60529 and DIN 40 050	IP 20
Permissible air humidity to DIN 40 040	Humidity class F (inlet air without aggressive gases)
Permissible ambient temperature	
• Storage and transport	-25°C to +65°C
• Operation	+5°C to +55°C
Maximum distance from operator panel or keyboard interface	5 m
Approx. weight	1.3 kg
Dimensions (W x H x D)	471 mm x 38 mm x 194 mm

- Standard PC keyboard (MF-II) and 5-way mini DIN connector, **6FC5203-0AC01-0AA0**

Note:

This keyboard can be connected to the following components:

- 19" slimline operator panel (from order no.: 6FC5103-0AB - A1)
- Keyboard interface (from order no.: 6FC5103-0AE01- A1)

Technical data	
Power consumption approx.	0.3 W
Degree of protection to EN 60529 and DIN 40 050	IP 20
Permissible air humidity to DIN 40 040	Humidity class F (inlet air without aggressive gases)
Permissible ambient temperature	
• Storage and transport	-40°C to +70°C
• Operation	+0°C to +55°C
Approx. weight	0.5 kg
Dimensions (W x H x D)	460 mm x 35 mm x 160 mm

5.9 Streamers

5.9.1 VALITEK PST 160 streamer

6FC9 310-1NB00

Capacity: 160 Mbytes
 Data cartridge type: e.g. Verbatim ST 600XD (or comparable type)
 Cart. Order No.: 6FC9 310-1NC00
 Interfaces: Parallel
 Average backup speed: Parallel: 4 Mbytes/min
 Power supply: Built-in 110/230 V universal power supply
 Weight: 4 kg
 Dimensions: 35.8 cm L x 8.8 cm H x 15.3 cm D

5.9.2 VALITEK PST 2-M1200 streamer

6FX2 007-2AA00

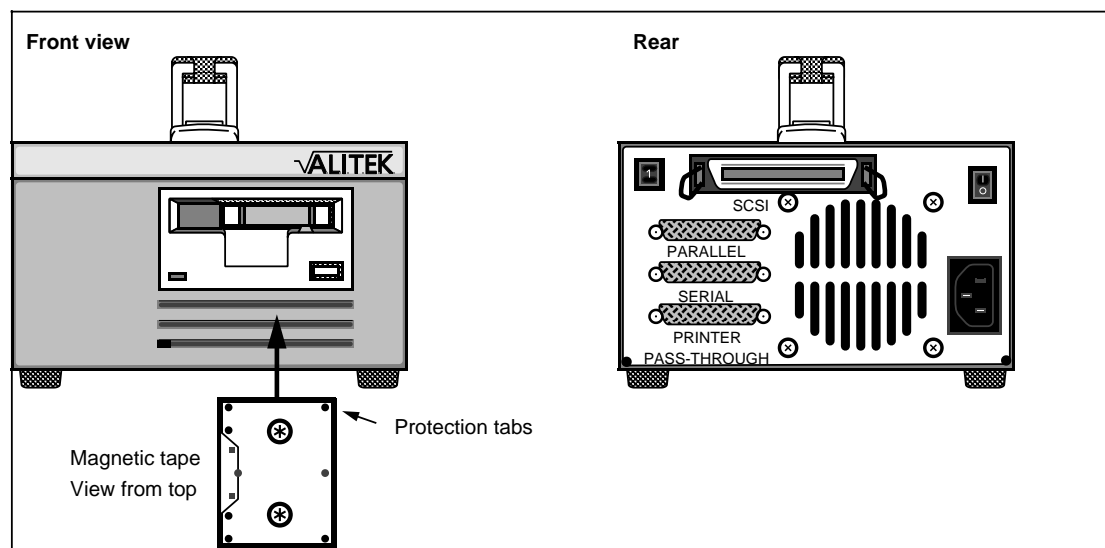

VALITEK PST 2-M1200 streamer

Capacity: 600 Mbytes
 Data cartridge type: e.g. Maxell CS 600 SX (or comparable type)
 Cart. Order No.: 6FX2 007-2AB00
 Interfaces: Parallel
 Average backup speed: Parallel: 4 Mbytes/min
 Power supply: Built-in 110/230 V universal power supply
 Weight: 3 kg
 Dimensions: 29.2 cm L x 8.9 cm H x 15.3 cm D

- **For connecting the streamer VALITEK PST 160 and PST 2-M1200 to the MMC CPU, only the SIEMENS cable 6FC9 344-4XN00 should be used.**
- **Tapes written with the PST2-M1200 cannot be read by the PST 160**

5.10 Encoders

5.10.1 High-resolution rotary encoder for rotary axes

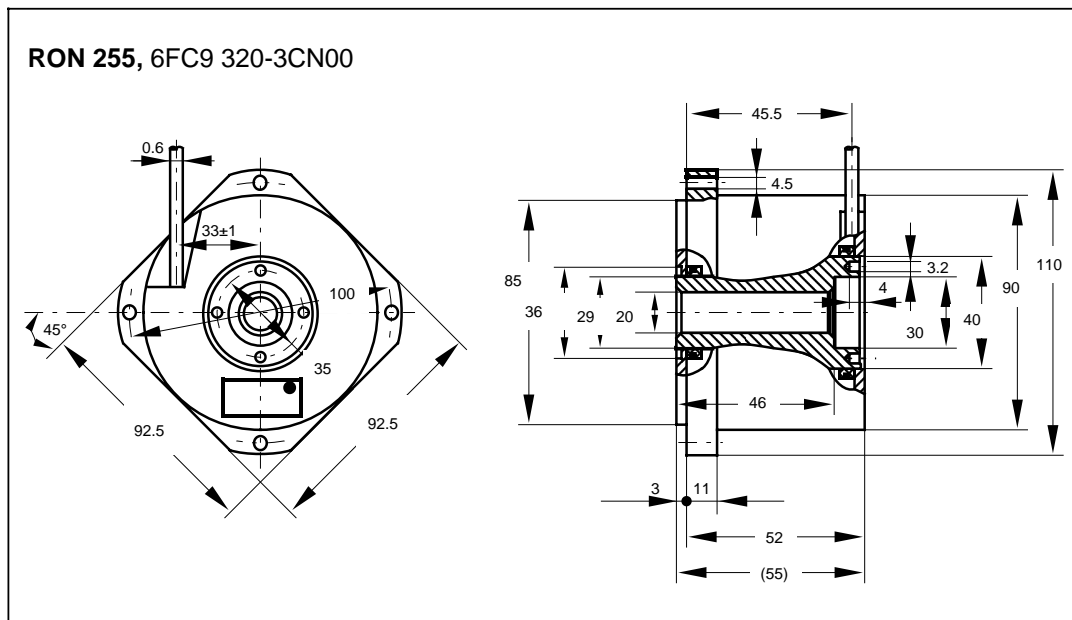
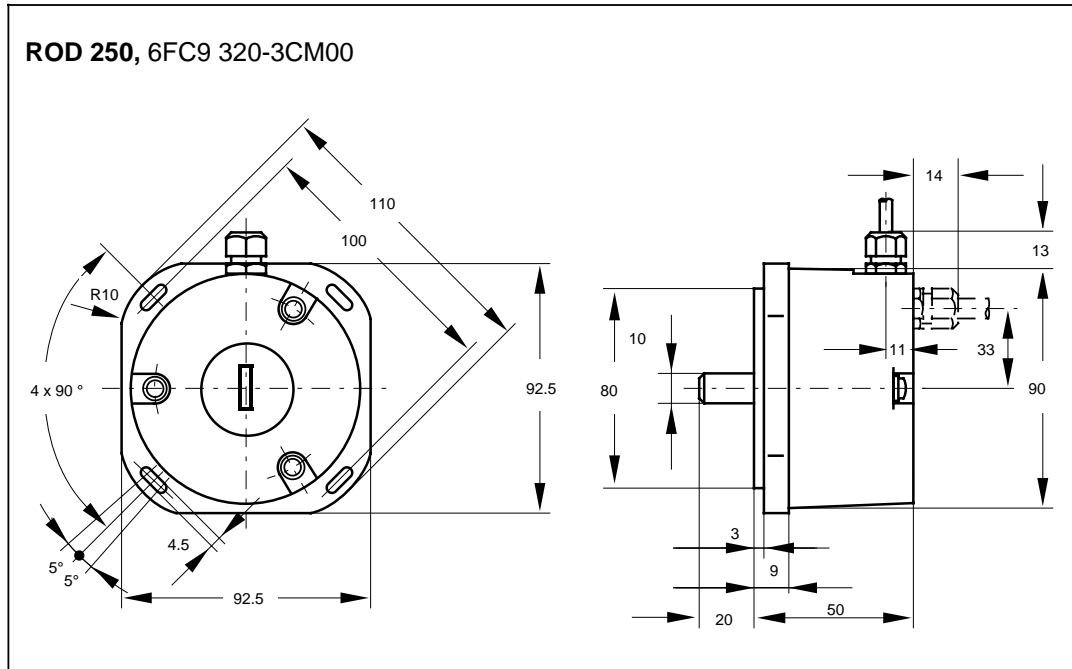

5.10.2 Incremental rotary encoder and main spindle encoder

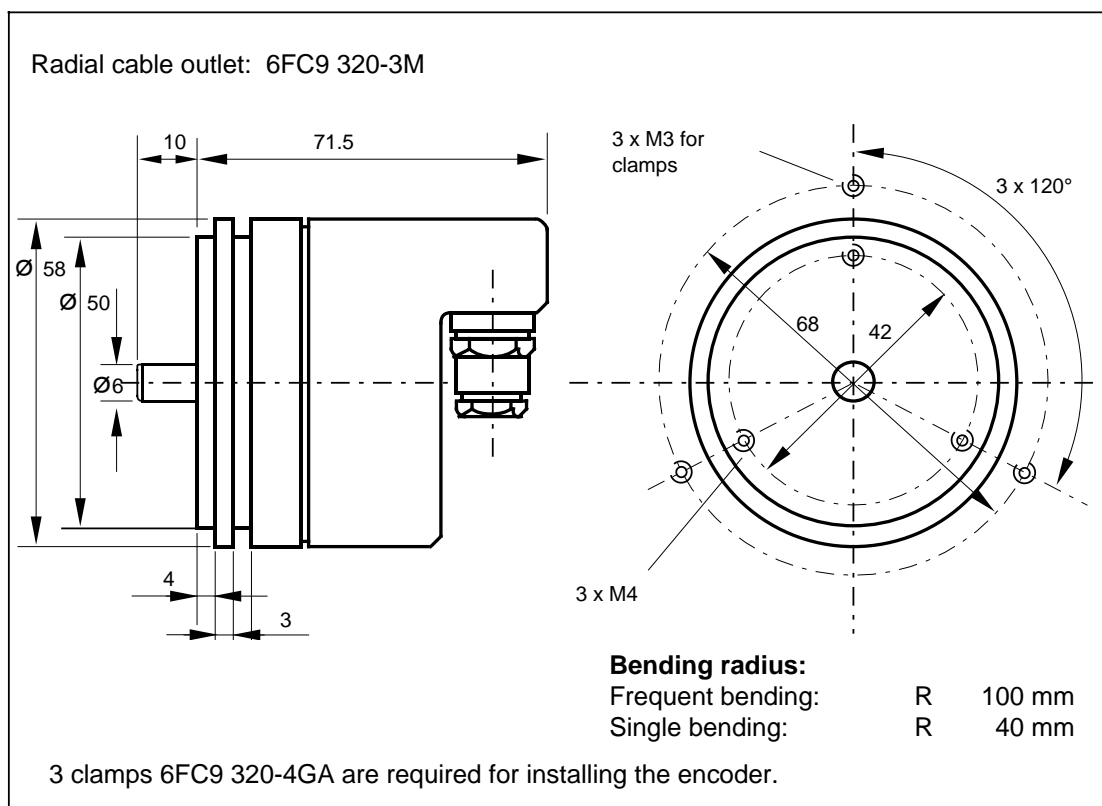
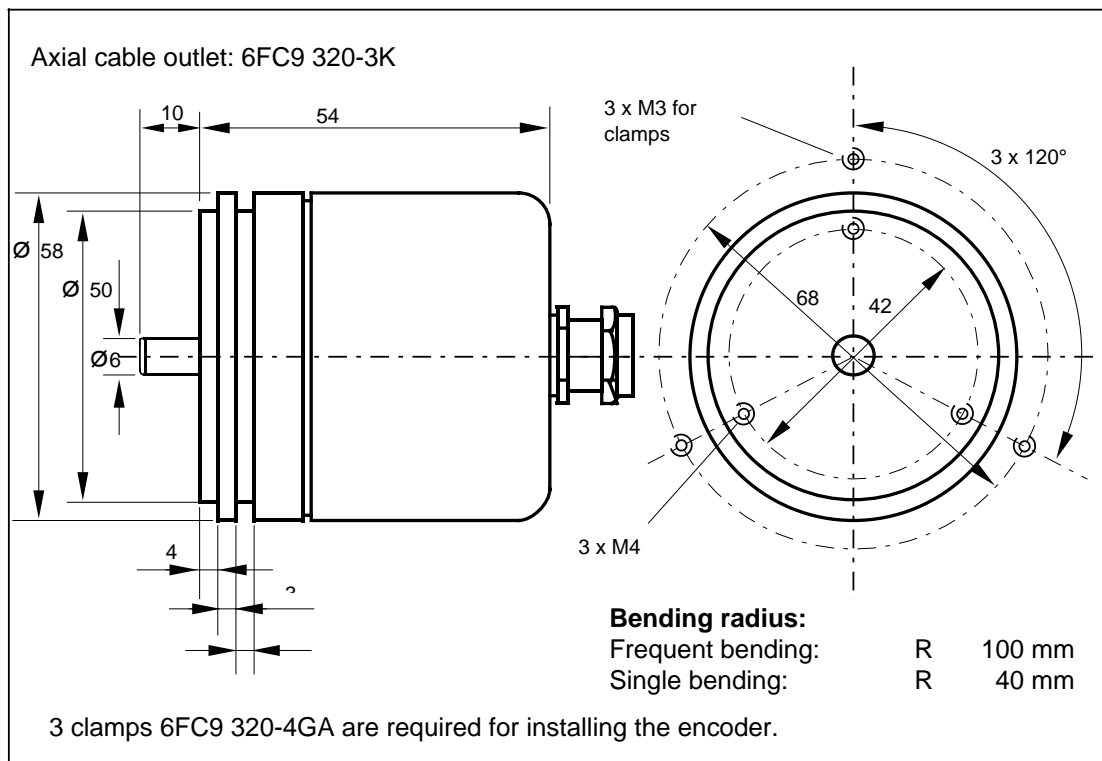

5.10.3 Combined rotary encoder for spindle and C axis

6FC9 320-3KT00

No. of pulses, spindle: 1024 pulses/rev

No. of pulses, C axis: 9000 pulses/rev

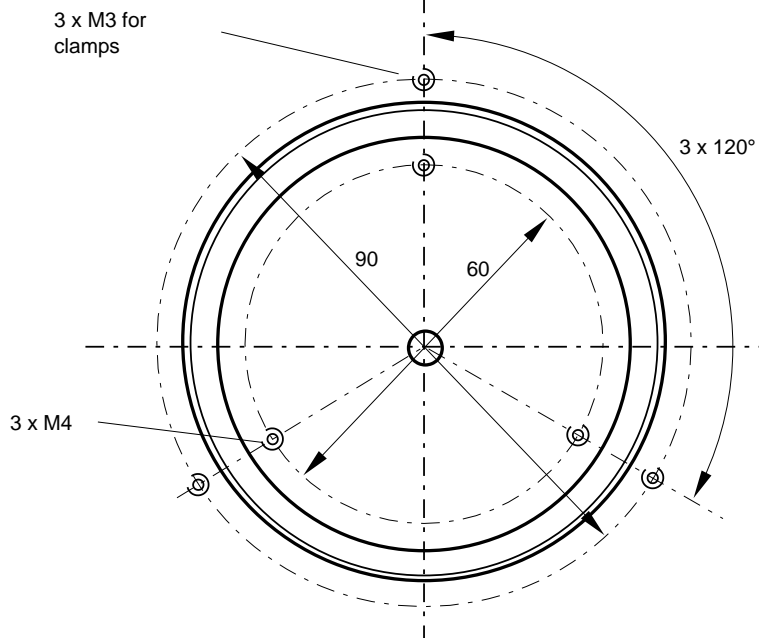
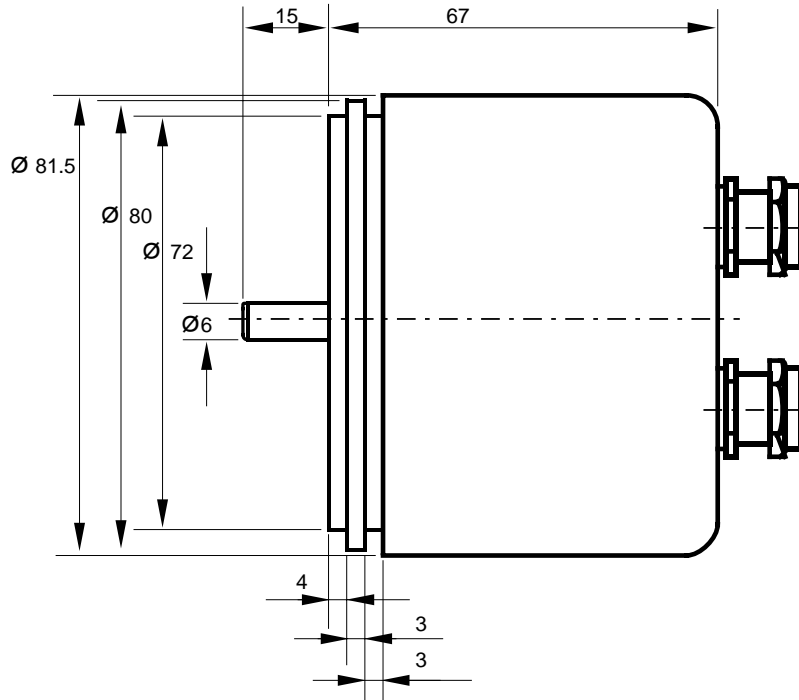

Bending radius:
 Frequent bending: R 100 mm
 Single bending: R 40 mm

3 clamps 6FC9 320-4GA are required for installing the encoder.

5.10.4 SIPOS encoders**6FC9 320-3C**

SIPOS encoders are unconditioned signal angular position encoders. The SIPOS is supplied as a purely incremental encoder or as a multiturn absolute encoder. The absolute encoder sends an absolute value to the NC on power up and then works as an incremental encoder. The sizes and cables of the SIPOS incremental encoders and SIPOS absolute encoders are identical.

SIPOS encoders can only be connected to the HMS measuring circuit module. For the absolute encoder an absolute encoder submodule is required, too.

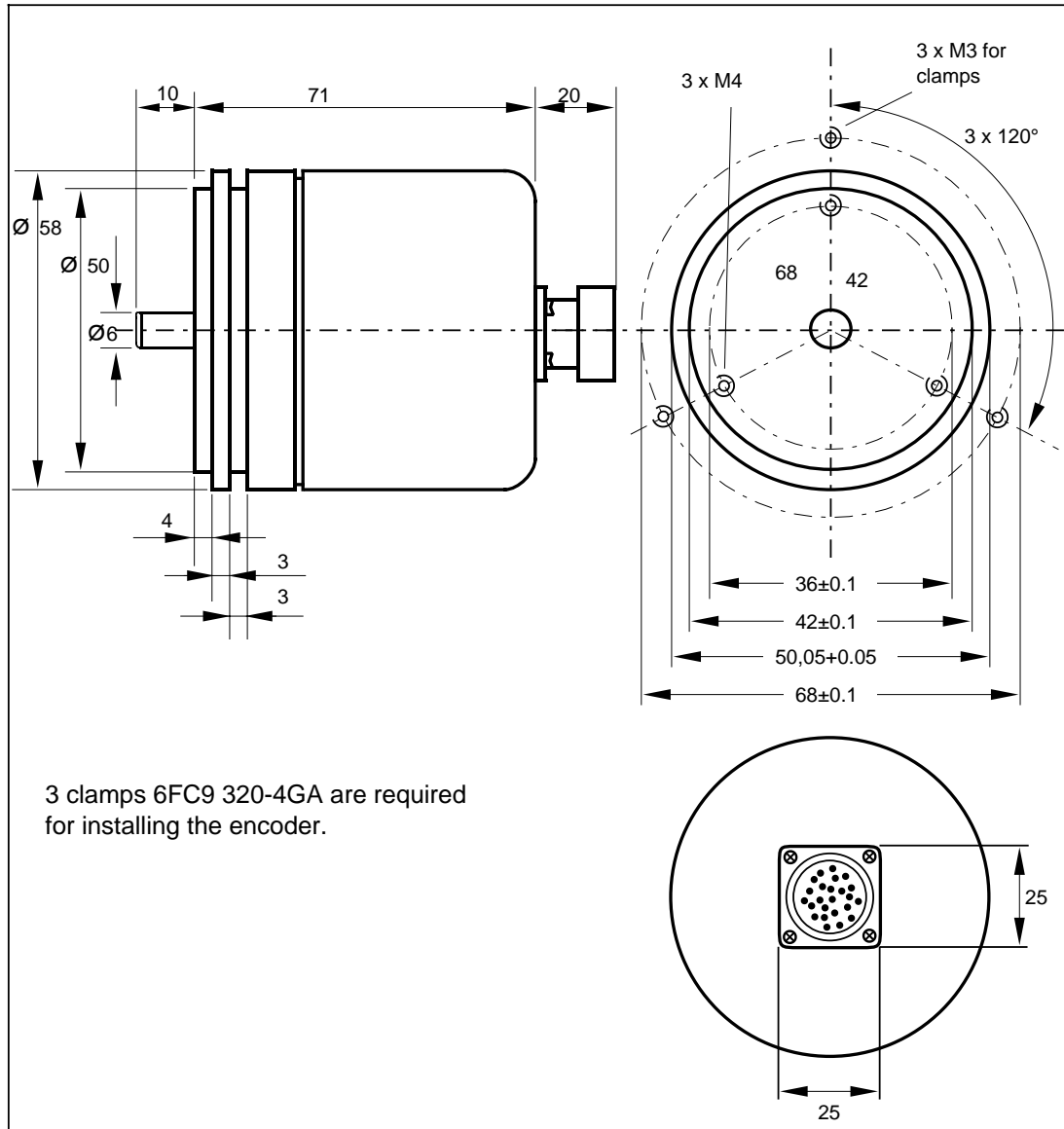
SIPOS absolute encoder with axial outgoing connector

Link to motor/leadscrew with set of fixing parts 6FC9 382-1C. When used for pure position measurement (the SIPOS encoder is **not** used for speed measurement) the spring disk coupling 6FC9 320-4GB can also be used.

Technical data

Increments of the disk	Pulses/rev.	2500
Max. sampling frequency	kHz	500
Max. output frequency	kHz	500
Output signals tracks A, B		Sinusoidal, electrical phase shift 90°, differential, amplified photoelectric signals of the incremental track
Output signal zero pulse		Signal peak of the reference mark
Output voltage tracks A, B	volts	+0.8/- 0.8V + 0.5/- 2 dB (at 100 Hz, terminating resistor: 180 Ω)
Output voltage zero pulse	volts	+0.8 /- 0.8 V; +3 /-2 dB (at 100 Hz, terminating resistor: 180 Ω)
Amplitude error track A to track B	%	5 < 25 kHz 10 25 to 500 kHz
Temperature coefficient of the output amplitude from track A, B and N	%K	0.2
Frequency response, tracks A, B and N	dB	-3 (from 0 to 500 kHz, without cable) -6 (from 0 to 500 kHz, with 100 m cable)
Phase angle error (without cable)	degrees	1.5 < 25 kHz 3.0 < 25 to 500 kHz
Offset error tracks A and B	%	2 < 25 kHz 5 < 25 to 500 kHz
Supply voltage		5 volts, ± 10%, approx. 100 mA ± 15 volts, ± 10%, approx. 60 mA
System accuracy	Output signals A and B suitable for multiplication by factor 128 for position control and factor 512 for speed control	
Light source	Infrared LED, controlled	
Scan	Photoelectrically using light	
Light receiver	Photodiodes	
Max. cable length	metres	100 (SINUMERIK cable)
Max. speed	rev/min	12000
Life of ball bearings	h	10 ⁴ at 8000 rev/min and 50°C
Friction torque	Ncm	1
Shaft loadability axially radially	N N	15 25
Max. permissible angular acceleration	rad/s ²	105

Technical data, continued

Resistance to vibration to DIN 40046 Part 7 3 Hz to 60 Hz: 60 Hz to 600 Hz: 500 Hz to 2 kHz:		$\pm 3 \text{ mm}$ 15 g 12 g	} $\div 120 \text{ ms}^{-2}$
Shock resistance to DIN 40046 test Fc	m/s^2	300 (30 g)	
Degree of protection to EN 60529 and DIN 40050		IP 65 (except for shaft inlet) IP 54 (shaft inlet)	
Temperature range during operation	$^{\circ}\text{C}$	0 to +70	
Temperature range during storage	$^{\circ}\text{C}$	-25 to +80	
Rel. air humidity during operation	%	75	
Rel. air humidity during storage and transport	%	65	
Rel. air pressure during operation	HPa	>700	
Rel. air pressure during storage and transport	HPa	>700	
Weight (incl. 1m cable und connector)	g	approx. 440	

END OF SECTION

6 Cables and Connectors

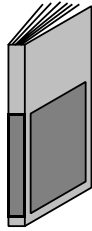

Please also refer to Catalog NC Z, Accessories for SINUMERIK, SIROTEC, SIMODRIVE and Equipment for Special Machines.

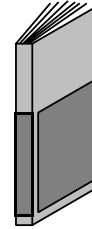

6.1 Tabular overview of cables

Order numbers for cables and connectors are listed in ascending order.

Cables, complete between	Max. permiss. length	Old Order No.	New Order No.
Operator panel components Cable set 1: between MCP and keyboard interface Length 2 x 0.5 m	0.5 m		6FC5 147-0AA03-0AA0
Cable set 2: between MCP and operator panel interface Length 1 x 0.5 m 1 x 0.27 m	0.5 m		6FC5 147-0AA04-0AA0
the INDUCTOSYN scales Length 0.34 m	0.34 m	6FC9 198-4AL00	
ANALOG measuring circuit module and digital rotary encoder in servo drive (ROD 320) Length 5 m Length 10 m Length 15 m Length 18 m Length 25 m	35 m ¹⁾	6FC9 340-8PB 6FC9 340-8PC 6FC9 340-8PD 6FC9 340-8PE 6FC9 340-8PF	6FX2 002-2CB41-0BF0 6FX2 002-2CB41-0CB0 6FX2 002-2CB41-0CB5 6FX2 002-2CB41-0CB8 6FX2 002-2CB41-0CC5
ANALOG measuring circuit module and digital linear measuring system (EXE on measuring circuit module) Length 5 m Length 10 m	17 m ²⁾	6FC9 340-8QB 6FC9 340-8QC	
ANALOG/HMS measuring circuit module and SIMODRIVE drives (setpoints) Length 5 m Length 10 m Length 18 m Length 25 m	50 m	6FC9 340-8RB 6FC9 340-8RC 6FC9 340-8RE 6FC9 340-8RF	
MMC CPU and NC keyboard (RS 232 C) Length 5 m Length 10 m Length 18 m Length 25 m	50 m	6FC9 340-8WB 6FC9 340-8WC 6FC9 340-8WE 6FC9 340-8WF	
and cable for extension of ACTIVE RS 232 C interface Length 2 m Length 5 m Length 10 m Length 18 m Length 25 m	30 m	6FC9 344-1FM 6FC9 344-1FB 6FC9 344-1FC 6FC9 344-1FE 6FC9 344-1FF	
ANALOG measuring circuit module and digital rotary measuring system/external EXEn/ INDUCTOSYN converter Length 3 m Length 5 m Length 10 m Length 15 m Length 18 m Length 25 m	50 m	6FC9 344-2BN 6FC9 344-2BB 6FC9 344-2BC 6FC9 344-2BD 6FC9 344-2BE 6FC9 344-2BF	6FX2 002-2CB51-0BD0 6FX2 002-2CB51-0BF0 6FX2 002-2CB51-0CB0 6FX2 002-2CB51-0CB5 6FX2 002-2CB51-0CB8 6FX2 002-2CB51-0CC5

1) 50 m with external 5-V supply

2) 30 m with external 5-V supply

Cables, complete between	Max. permiss. length	Old Order No.	New Order No.
MMC CPU and FD-E1 floppy drive Length 2 m Length 5 m Length 10 m Special lengths available	30 m	6FC9 344-2PM 6FC9 344-2PB 6FC9 344-2PC	
For RS 232C / RS 422 - conversion Length Special length according to order		6FC9 344-2V	
INDUCTOSYN converter and INDUCTOSYN pre-amplifier Length 5 m Length 10 m Length 18 m Length 25 m	50 m	6FC9 344-3EB 6FC9 344-3EC 6FC9 344-3EE 6FC9 344-3EF	
INDUCTOSYN converter and INDUCTOSYN scale • LMS 186 Length 5 m Length 10 m Length 18 m Length 25 m • LMS 486 Length 5 m Length 10 m Length 18 m Length 25 m	50 m	6FC9 344-3FB 6FC9 344-3FC 6FC9 344-3FE 6FC9 344-3FF	6FX2 002-2CA81-0BF0 6FX2 002-2CA81-0CB0 6FX2 002-2CA81-0CB8 6FX2 002-2CA81-0CC5 6FX2 002-2CB81-0BF0 6FX2 002-2CB81-0CB0 6FX2 002-2CB81-0CB8 6FX2 002-2CB81-0CC5
To digital linear measuring system (extension) Length 15 m		6FC9 344-3LD	
And DMP terminal blocks Length 0.25 m Length 1 m Length 2 m Length 5 m Length 10 m Length 18 m	50 m	6FC9 344-3QA 6FC9 344-3QL 6FC9 344-3QM 6FC9 344-3QB 6FC9 344-3QC 6FC9 344-3QE	
Interface DMP/Interface PLC and PLC 135 WD and terminal block, machine control panel or distribution box Length 1 m Length 2 m Length 5 m Length 10 m Length 18 m Length 25 m	50 m	6FC9 344-3SL 6FC9 344-3SM 6FC9 344-3SB 6FC9 344-3SC 6FC9 344-3SE 6FC9 344-3SF	
MIXED I/O module and terminal strip converter with LEDs Length 2 m Length 5 m Length 10 m		6FC9 344-3XM 6FC9 344-3XB 6FC9 344-3XC	
HMS and SIPOS measuring circuit module, trailing cable Length 5 m Length 10 m Length 18 m Length 25 m	50 m	6FC9 344-4DB01 6FC9 344-4DC01 6FC9 344-4DE01 6FC9 344-4DF01	

Cables , complete between	Max. permiss. length	Order No.
Distribution box and handheld unit Length 2 m Length 5 m Length 10 m	10 m	6FC9 344-4GM 6FC9 344-4GB 6FC9 344-4GC
MMC CPU and WS 800A workstation Length 5 m Length 10 m		6FC9 344-4HB 6FC9 344-4HC
HMS measuring circuit module and incremental linear measuring system Length 5 m Length 10 m	17 m	6FC9 344-4LB 6FC9 344-4LC
Resolver and resolver converter Length Special length according to order		6FC9 344-4M
MMC CPU and monitor unit/slimline operator panel (RGB), (trailing cable) Length 0.5 m Length 2 m Length 5 m Length 10 m Length 18 m Special lengths available	50 m	6FC9 344-4NA01 6FC9 344-4NM01 6FC9 344-4NB01 6FC9 344-4NC01 6FC9 344-4NE01
To SIMATIC PG 7xx Length 5 m Length 10 m	10 m	6FC9 344-4RB 6FC9 344-4RC
To SINUMERIK WS-800A NC workstation (RS 232 C), SIMATIC PG 7xx Length 5 m Length 10 m		6FC9 344-4TB 6FC9 344-4TC
MMC CPU and VALITEK streamer Length 3 m	3 m	6FC9 344-4XN
MMC CPU and ext. PC/PG for PC link Length 3 m	3 m	6FX2002-1AA02-1AD0
MMC interface and FD-E2 floppy drive Length 5 m Length 10 m Length 18 m Length 25 m	50 m	6FC9 344-5GB 6FC9 344-5GC 6FC9 344-5GE 6FC9 344-5GF
CSB and I/O device 4-way Length 5 m Length 10 m Length 18 m Length 25 m	25 m	6FC9 344-5HB 6FC9 344-5HC 6FC9 344-5HE 6FC9 344-5HF

Cables , complete between	Max. permiss. length	Old Order No.	New Order No.
CSB and I/O device 8-way Length 1 m Length 5 m Length 10 m Length 18 m Length 25 m	25 m	6FC9 344-5KL 6FC9 344-5KB 6FC9 344-5KC 6FC9 344-5KE 6FC9 344-5KF	6FX2 002-4AA21-1BB0 6FX2 002-4AA21-1BF0 6FX2 002-4AA21-1CB0 6FX2 002-4AA21-1CB8 6FX2 002-4AA21-1CC5
MIXED I/O module and analog output signals Length 1 m Length 2 m Length 5 m Length 10 m		6FC9 344-5LL 6FC9 344-5LM 6FC9 344-5LB 6FC9 344-5LC	6FX2 002-4AA11-1BB0 6FX2 002-4AA11-1BC0 6FX2 002-4AA11-1BF0 6FX2 002-4AA11-1CB0
Interface PLC/PLC 135 WD and 8 fast interrupt inputs Length 1 m Length 2 m Length 5 m Length 10 m		6FC9 344-5ML 6FC9 344-5MM 6FC9 344-5MB 6FC9 344-5MC	6FX2 002-4AA31-1BB0 6FX2 002-4AA31-1BC0 6FX2 002-4AA31-1BF0 6FX2 002-4AA31-1CB0
IP20 DMP terminal block - IP65 DMP terminal block Length 5 m Length 10 m Length 18 m	50 m	6FC9 344-5NB 6FC9 344-5NC 6FC9 344-5NE	
IP65 DMP terminal block and IP65 DMP terminal block Length 2 m Length 3 m Length 5 m	50 m	6FC9 344-5SM 6FC9 344-5SN 6FC9 344-5SB	
Interface (16 bit) and SIMATIC S5 expansion unit		see SIMATIC Catalog	
SINEC H1/SINEC H1 link		see SIMATIC Catalog	
INDUCTOSYN pre-amplifier and INDUCTOSYN cursor		Supplied with INDUCTOSYN pre-amplifier	
NC CPU and SIMODRIVE 611D (Drive bus cable) Length 1 m Length 2 m Length 5 m Length 10 m	10 m		6FX2002-1CA01-0BB0 6FX2002-1CA01-0BC0 6FX2002-1CA01-0BF0 6FX2002-1CA01-0CB0

6.2 Tabular overview of connectors

Connector, complete	Old Order No.	New Order No.
Sub D female connector, 37-pin (Siemens) with SINUMERIK housing, cable distributor	6FC5 147-0AA01-0AA0	
Round female connector, 17-pin (Tuchel)	6FC9 341-1AC	
Round male connector, 9-pin (Siemens) Cable 8 mm	6FC9 341-1AT	6FX2 003-1CE00
Round female connector, 9-pin (Siemens) Cable 8 mm	6FC9 341-1AU	6FX2 003-0CE00
Sub D female connector insert, 25-pin with 2 push latching buttons, solder connection	6FC9 341-1EB	
Sub D female connector, 15-pin (Siemens) with SINUMERIK housing	6FC9 341-1EC	6FX2 003-0AA15
Sub D female connector, 25-pin (Siemens) with SINUMERIK housing	6FC9 341-1ED	6FX2 003-0AA25
Sub D female connector, 25-pin (Siemens) Screw housing, crimped	6FC9 341-1ER	
Sub D, 25-pin female cable connector (Siemens) Post office housing	6FC9 341-1ES	
Round female connector coupling, 9-pin (Siemens) Cable 8 mm	6FC9 341-1EW	6FX2 003-0CF00
Round female connector, 12-pin (Siemens) Cable 10 mm	6FC9 341-1FD	6FX2 003-0CE12
Sub D female connector, 37-pin (Siemens) with SINUMERIK housing	6FC9 341-1FH	6FX2 003-0AA37
Round female connector, 17-pin (Siemens) Cable 8 mm	6FC9 341-1HA	
Sub D male connector, 25-pin (Siemens) with SINUMERIK housing	6FC9 341-1HB	
Sub D male connector, 25-pin (Siemens) Housing with push latch	6FC9 341-2AA	
Sub D male connector, 25-pin (Siemens) with SINUMERIK housing	6FC9 341-2AB	
Sub D female connector, 9-pin (Siemens) SBM 383 housing	6FC9 341-2AE	
Sub D male connector, 9-pin (Siemens) SBM 383 housing	6FC9 341-2AF	

6.3 Cable diagrams and connector assignment

The cable diagrams have been sorted by order number in ascending sequence.

Cables connecting INDUCTOSYN scales

Order No.: **6FC9 198-4AL**

SINUMERIK System 800
Module slot:
Module connector:

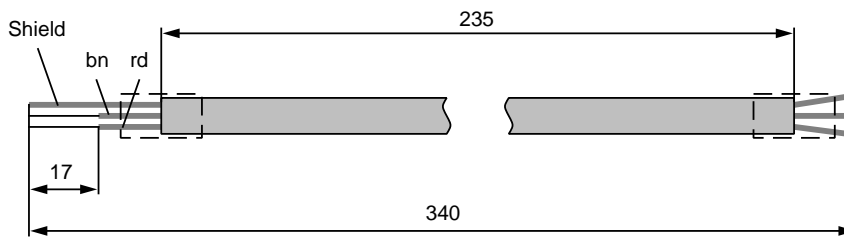

Cable:
2YD(ms)Y 2 x 0.5/1.5

Cable between ANALOG measuring circuit module and digital rotary encoder in servo drive (ROD 320)

Order No.: **6FC9 340-8P** (old)
6FX2 002-2CB41- (new)

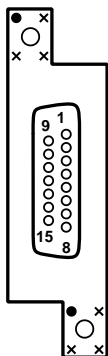
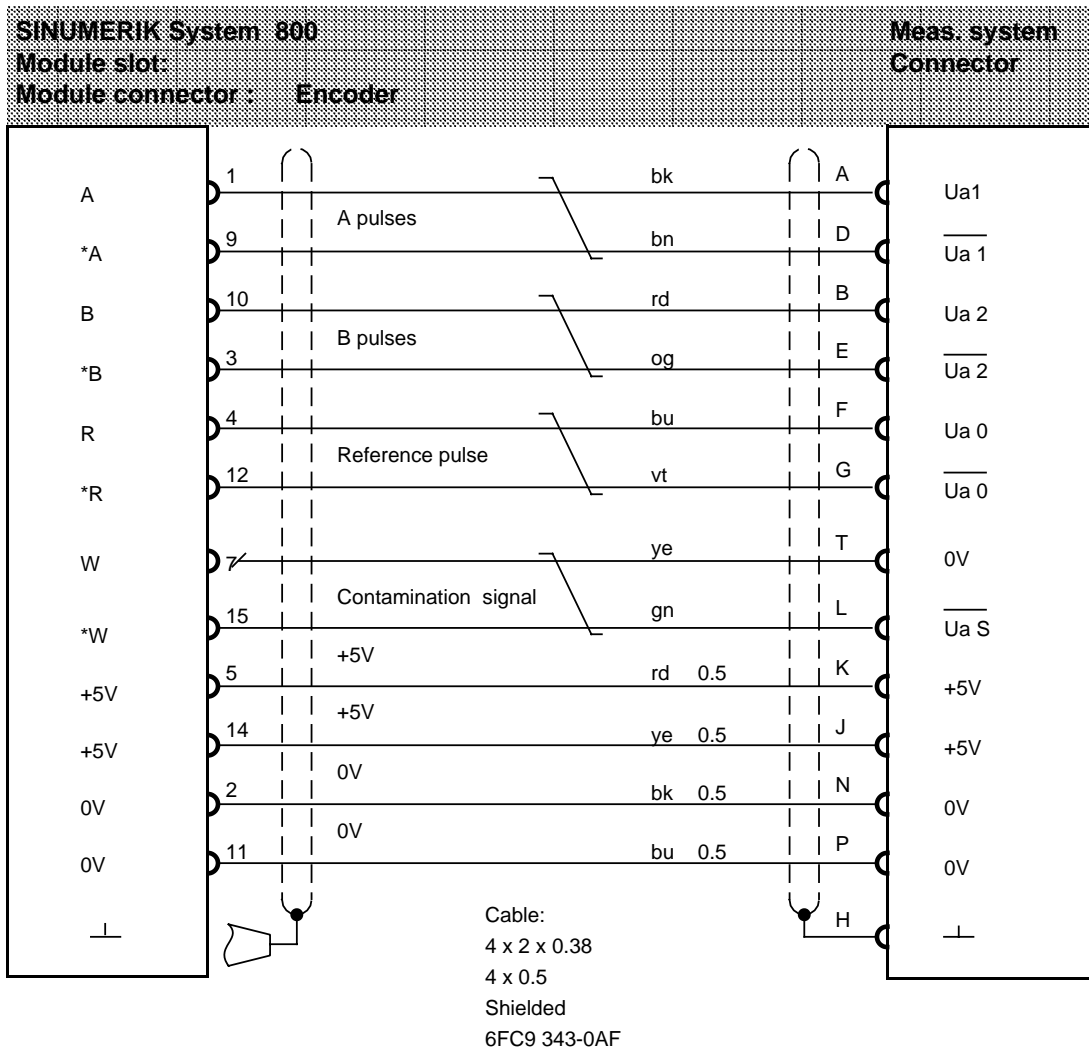

Connector
Position: 1, top
15-pin Sub D socket
Connection side
SINUMERIK housing
6FC9 341-1EC

Connector code

- Coding pin
- x No pin

Connector
17-pin socket
Tuchel
CA 08-20-295
Connection side
6FC9 341-1AC

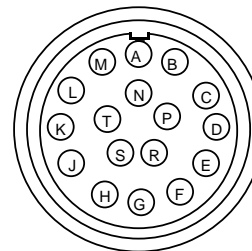

Cable between ANALOG measuring system and digital linear measuring system (EXE on measuring circuit module)

Order No.: **6FC9 340-8Q**

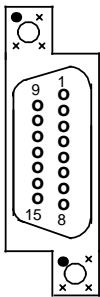
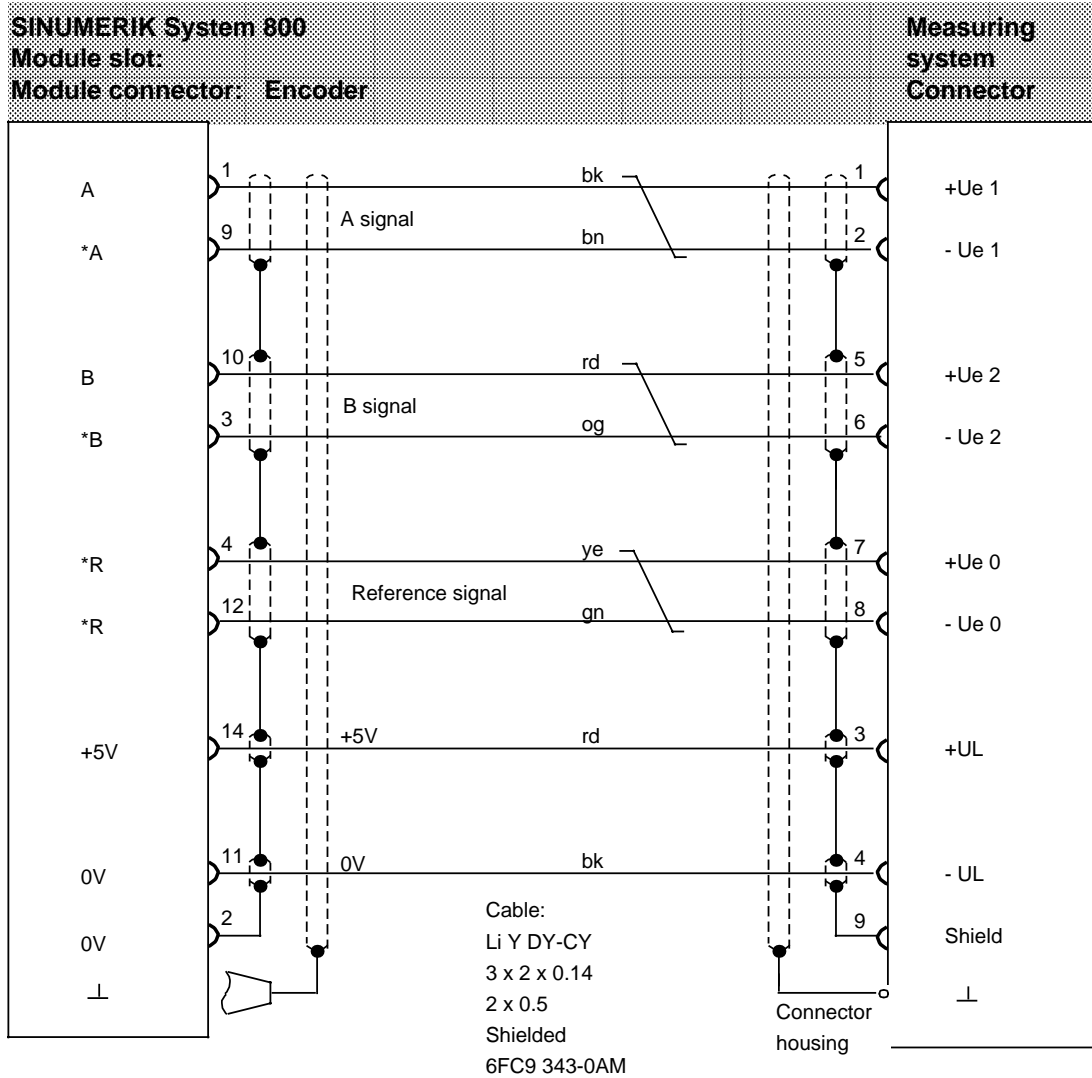

Connector
 Position : 1, top
 15-pin Sub D socket
 Connection side
 SINUMERIK housing
 6FC9 341-1EC

Connector code

- Coding pin
- × No pin

Connector coupling

9-pin socket
 SIEMENS
 Cable 8 mm
 Connection side
 6FC9 341-1EW

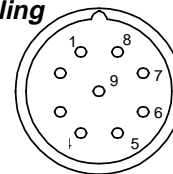

Cable between ANALOG/HMS measuring circuit module and SIMODRIVE drives (setpoints)

Order No.: **6FC9 340-8R**

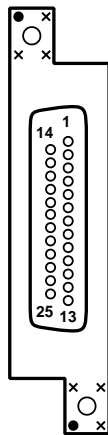
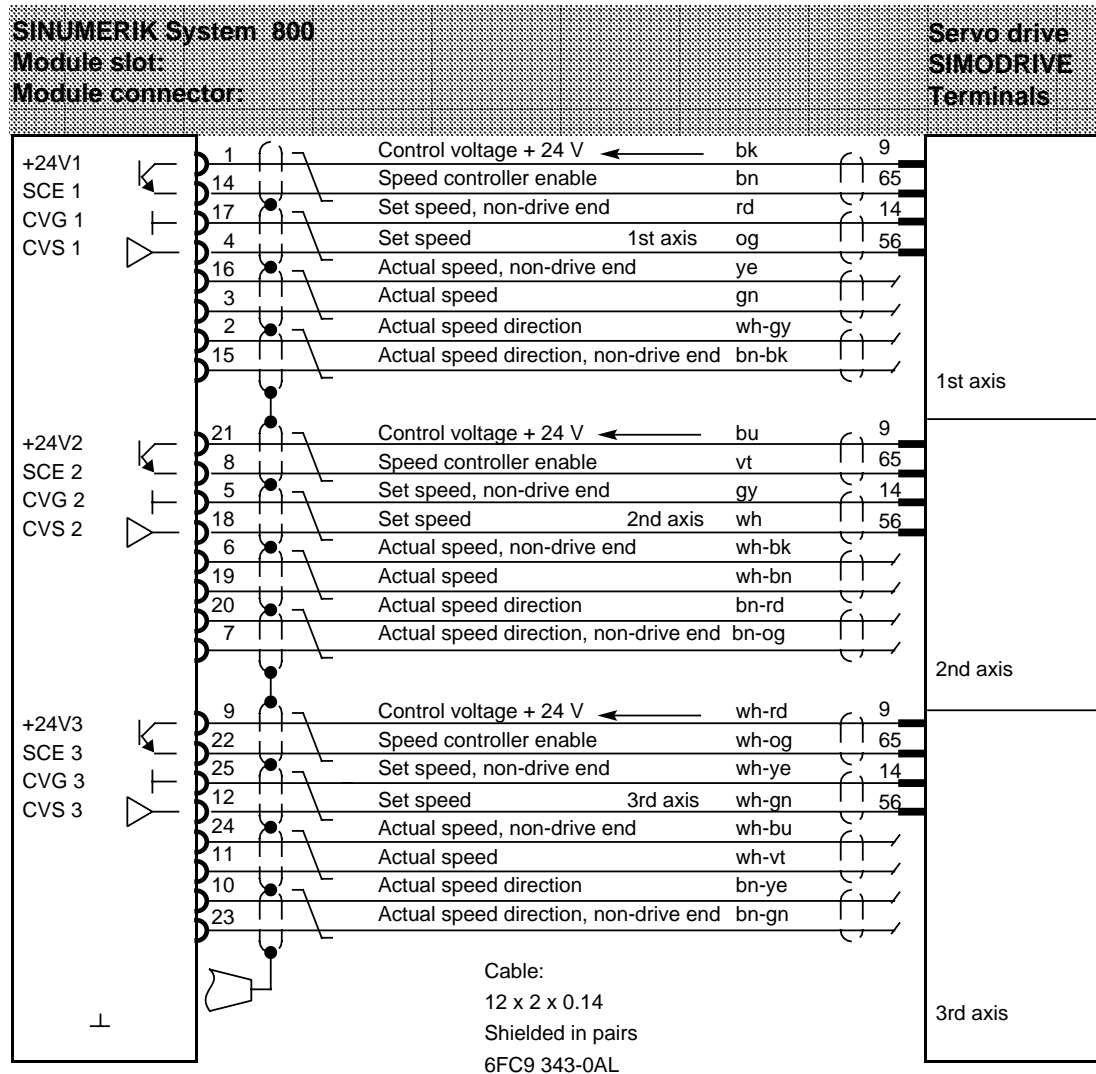

Connector

Position: 1, top
25-pin Sub D socket
Connection side
SINUMERIK housing
6FC9 341-1ED

Connector code

- Coding pin
- × No pin

Cable end
prepared for connection

Outer sheath
400 mm
Sheath removed

Bare wire ends
30 mm

Pin terminal
+terminal marking
on designated wires

Cable between MMC CPU and NC keyboard (RS232C (V.24))

Order No.: **6FC9 340-8W**

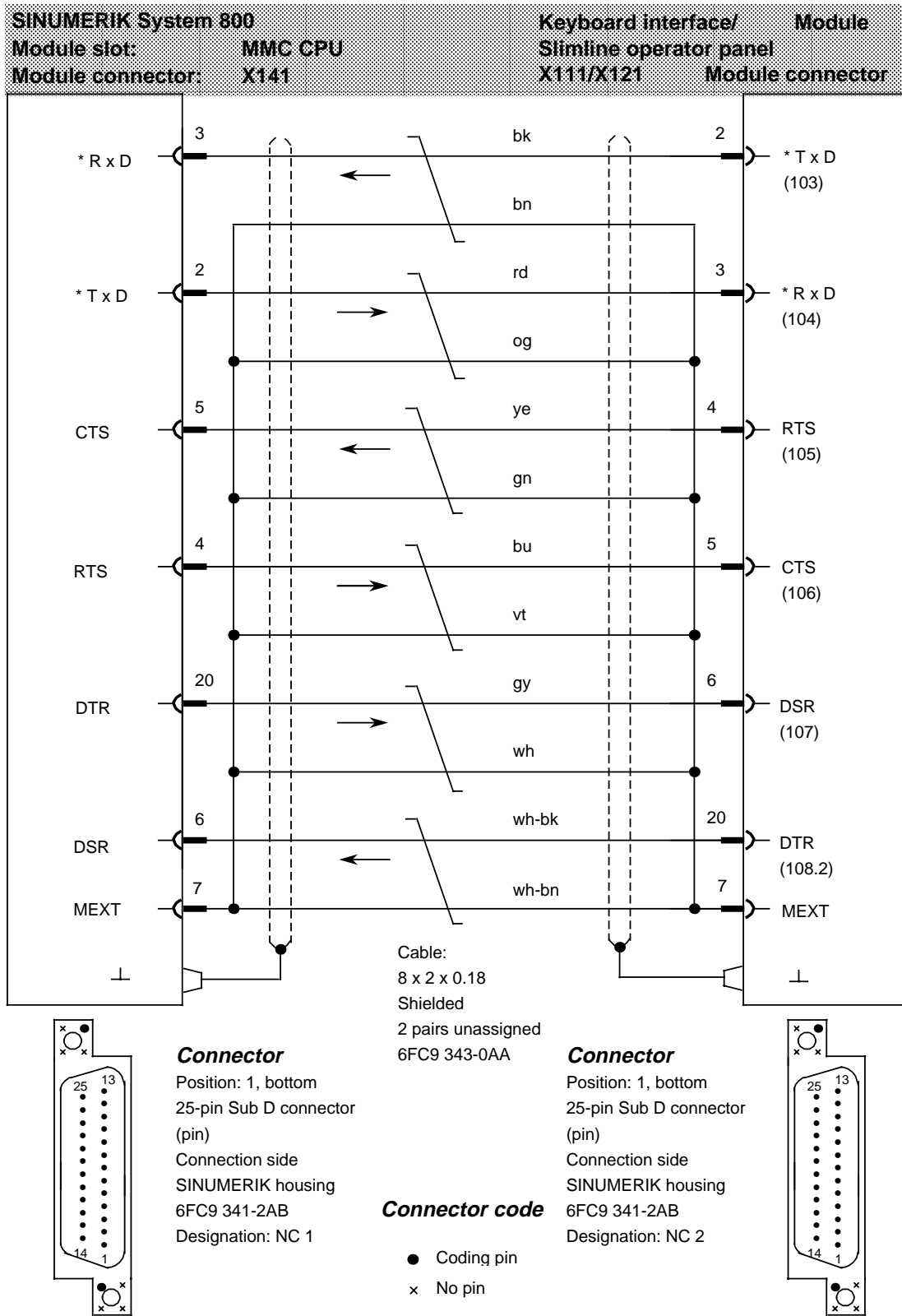

Cable for extension of RS 232 C/TTY interface

Order No.: **6FC9 344-1F**

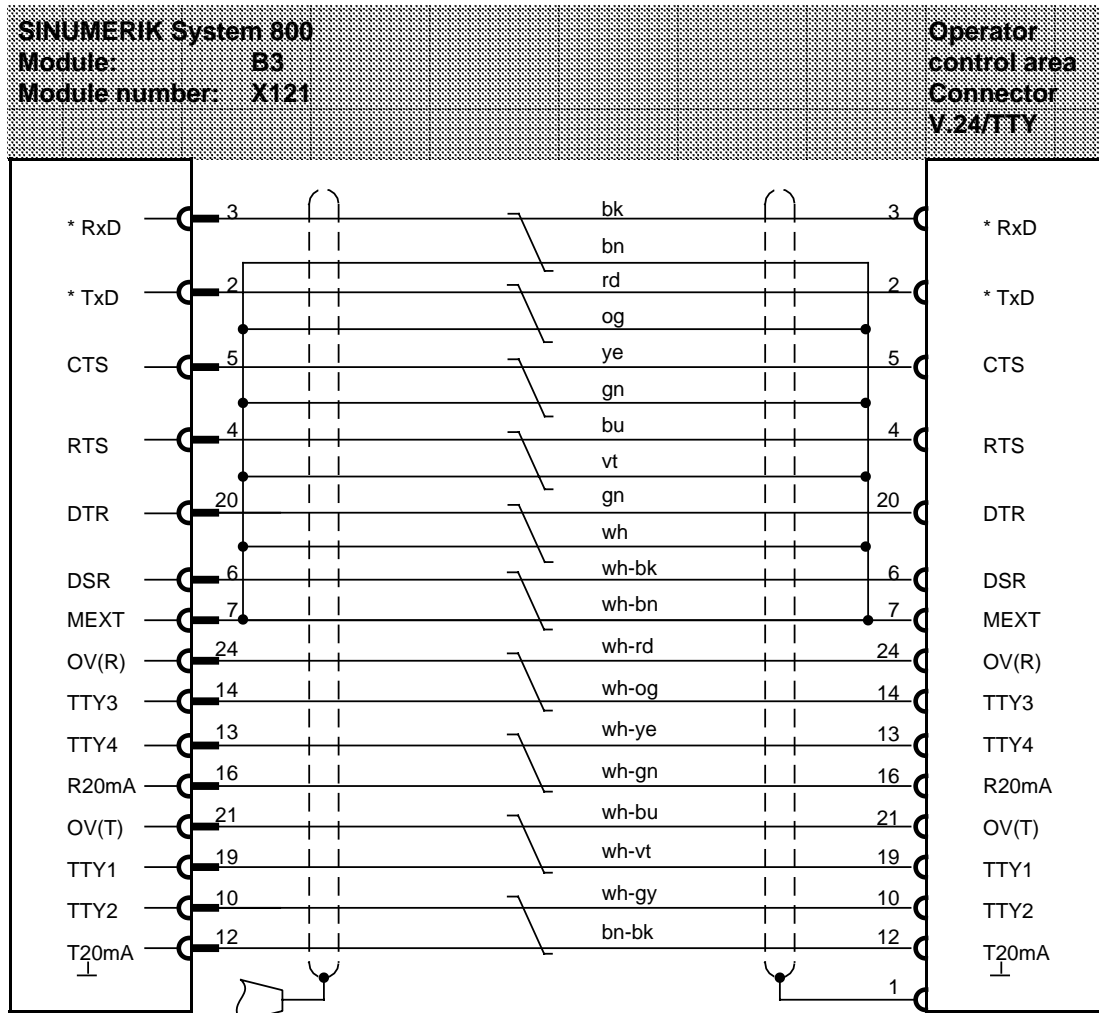

Cable:
10 x 2 x 0.18
Shielded
6FC9 343-0AB

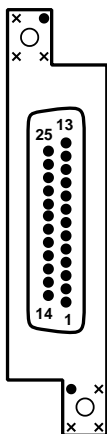

Connector
Position: 1, bottom
25-pin Sub D connector
(pin)
Connection side
SINUMERIK housing
6FC9 341-2AB

Connector code

- Coding pin
- × No pin

Connector
Position: 1, bottom
25-pin Sub D connector
(socket)
Connection side
Connector insert and
2 push latching buttons
with nuts
6FC9 341-1EB

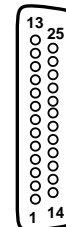

Cable between ANALOG measuring circuit module and digital rotary measuring system/
 external EXEs/INDUCTOSYN converter

Order No.: **6FC9 344-2B** (old)
6FX2 002-2CB51- (new)

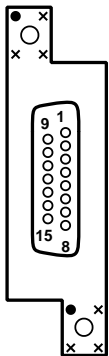
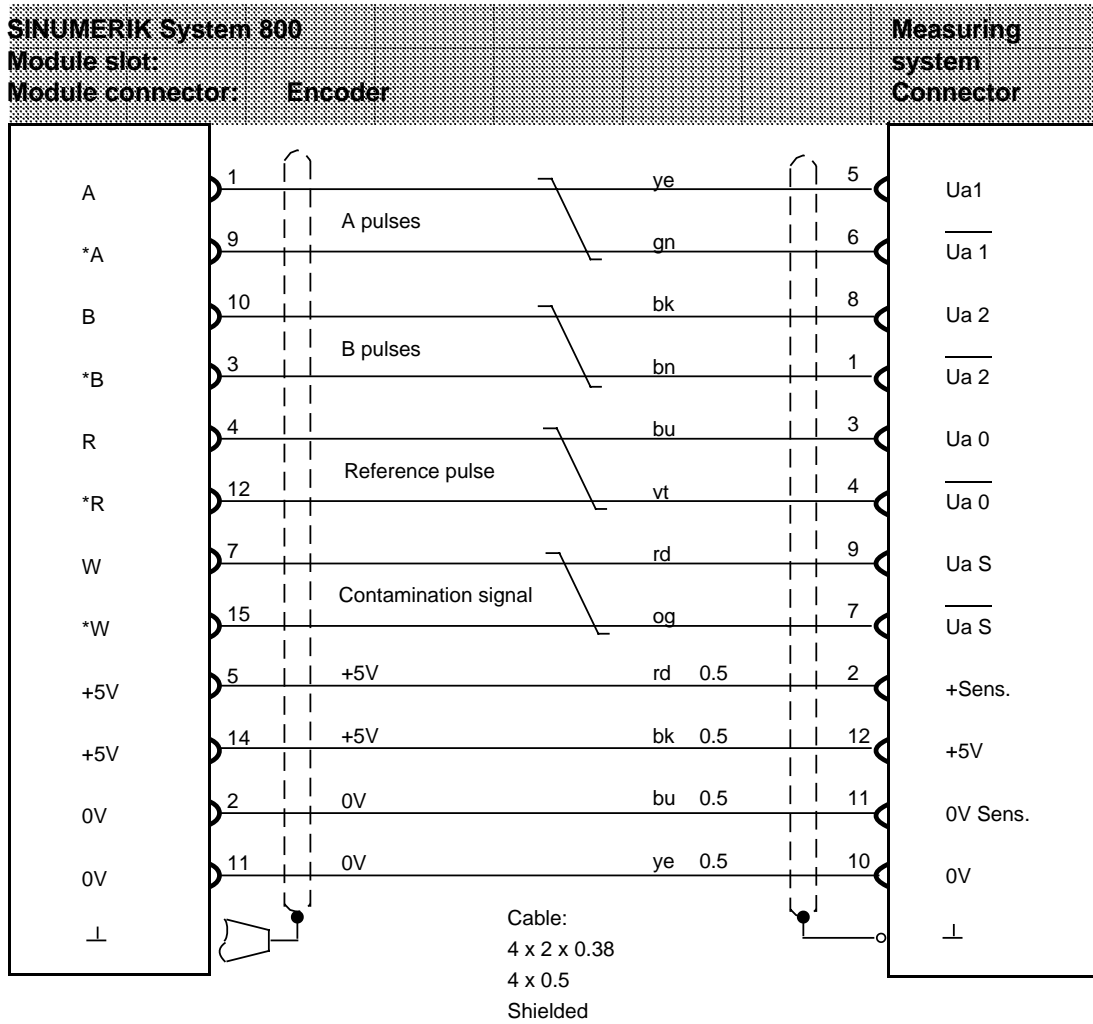

Connector
 Position: 1, top
 15-pin Sub D socket
 Connection side
 SINUMERIK housing
 6FC9 341-1EC

Connector code

- Coding pin
- x No pin

Connector
 12-pin socket
 SIEMENS
 Cable 10 mm
 Connection side
 6FC9 341-1FD

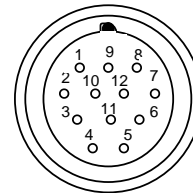

Cable between MMC CPU and FD-E1 floppy drive

Order No.: **6FC9 344-2P**

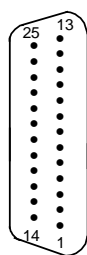
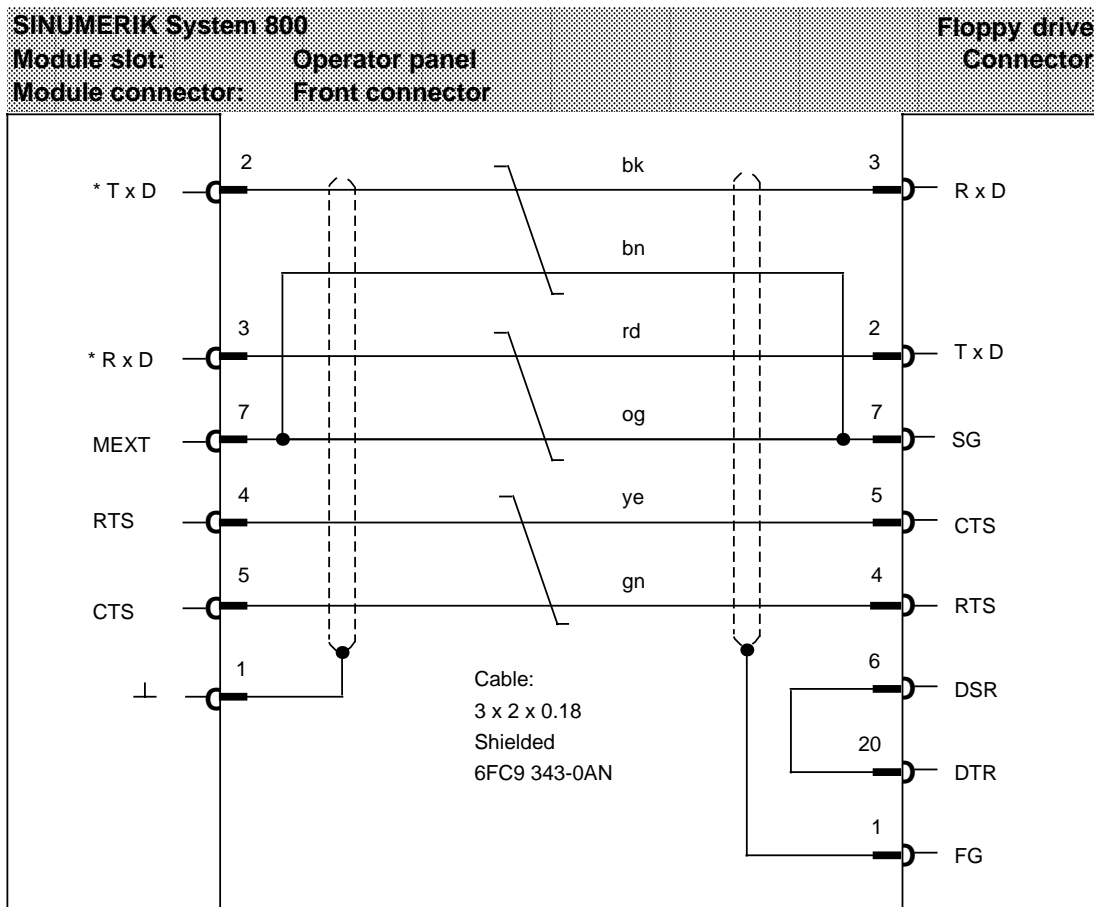

Connector
Position: 1, bottom
25-pin Sub D connector
Connection side
Housing with slide latch
6FC9 341-2AA
Designation: NC

Connector
Position: 1, bottom
25-pin Sub D connector
Connection side
Post office housing
6FC9 341-1ES
Designation: CAN

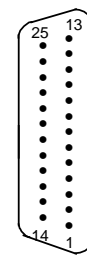

Cable to RS 232 C / RS 422 converter

Order No.: **6FC9 344-2V**

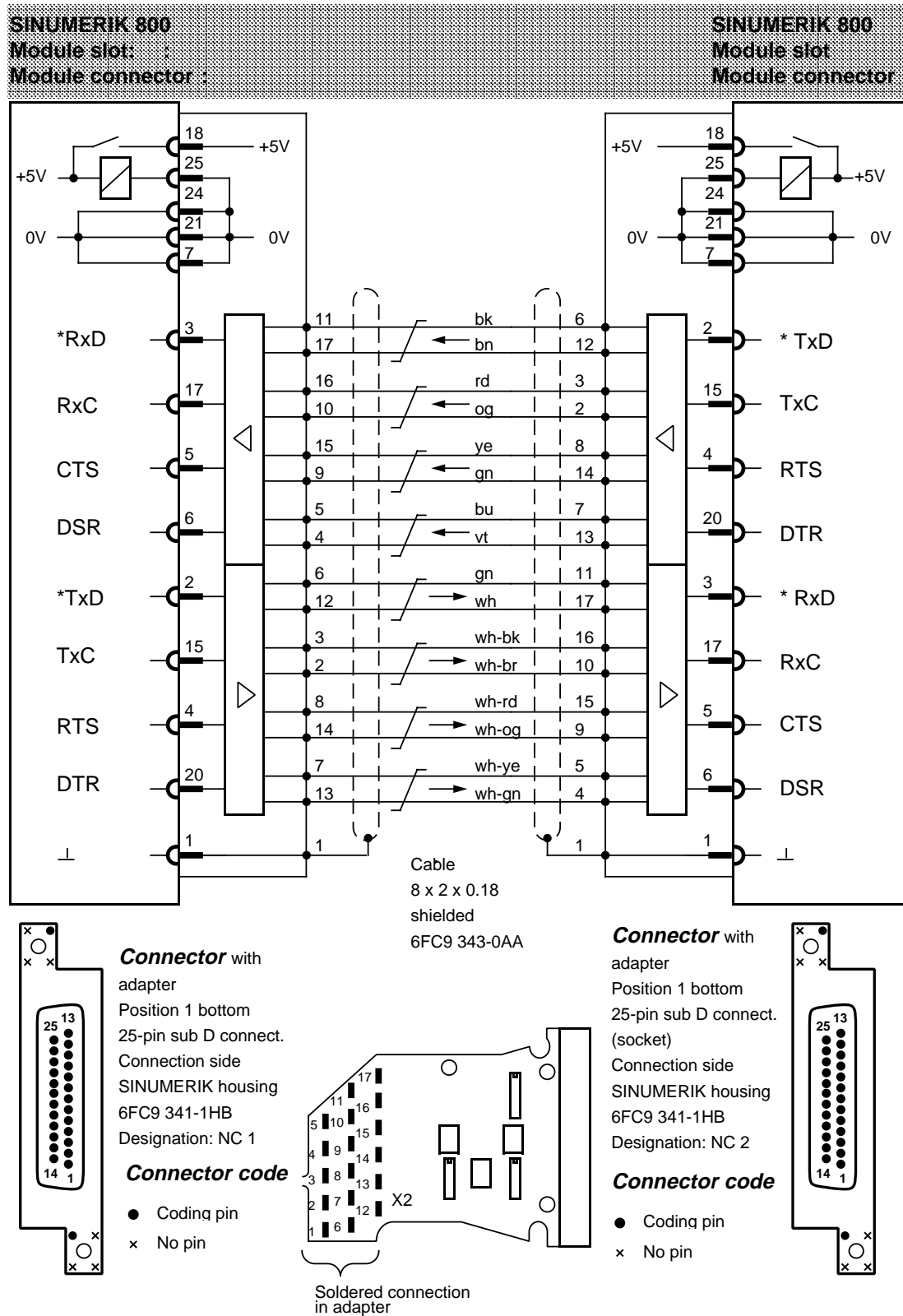

Cable between INDUCTOSYN converter and INDUCTOSYN pre-amplifier

Order No.: **6FC9 344-3E**

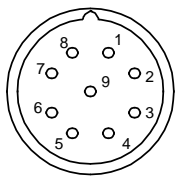
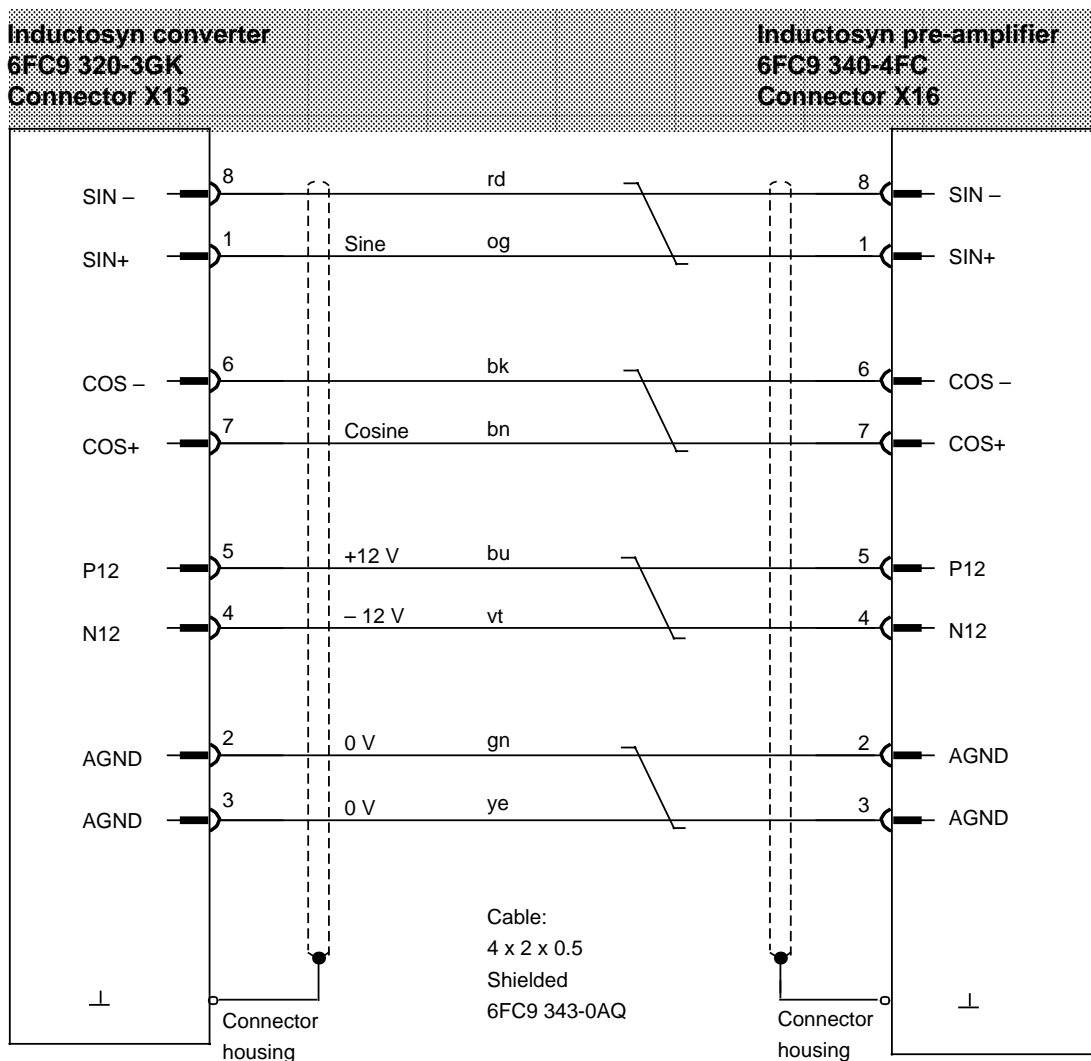

Connector
9-pin socket
SIEMENS
Cable 8 mm
Connection side
6FC9 341-1AU

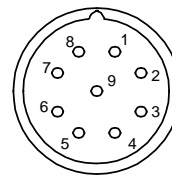

Connector
9-pin socket
SIEMENS
Cable 8 mm
Connection side
6FC9 341-1AU

Cable between INDUCTOSYN converter and INDUCTOSYN scale

Order No.: **6FC9 344-3F** (old)
6FX2 002-2C 81- (new)

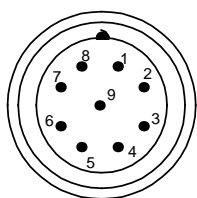
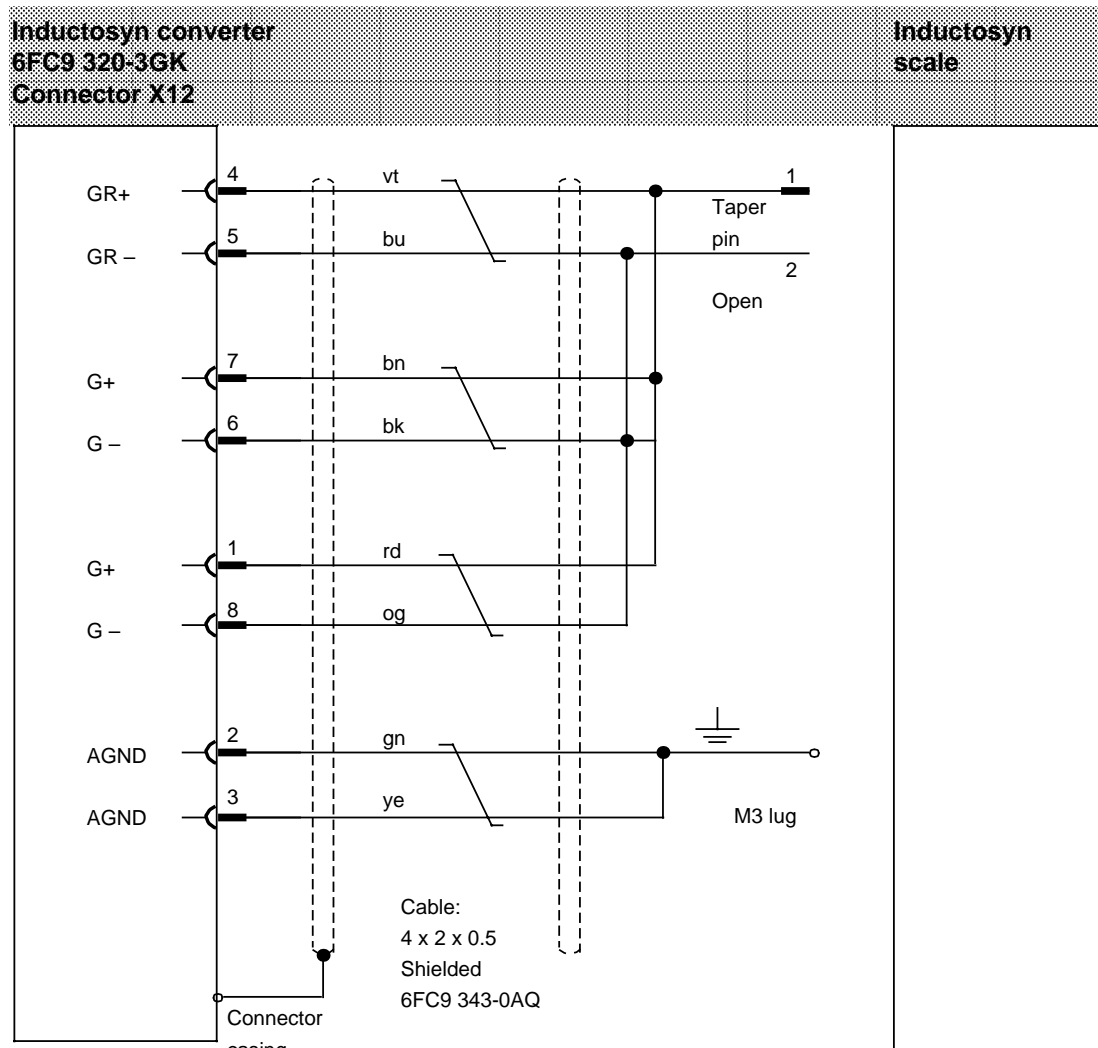

Connector
9-pin connector
SIEMENS
Cable 8 mm
Connection side
6FC9 341-1AT

Cable end prepared for connection

Bare wire ends
1.2 40 mm
60 mm

Terminal marking on designated wires

Designation: SCALA

Cable to digital linear measuring system (extension)

Order No.: **6FC9 344-3L**

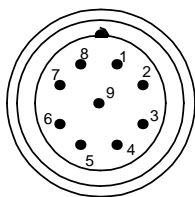
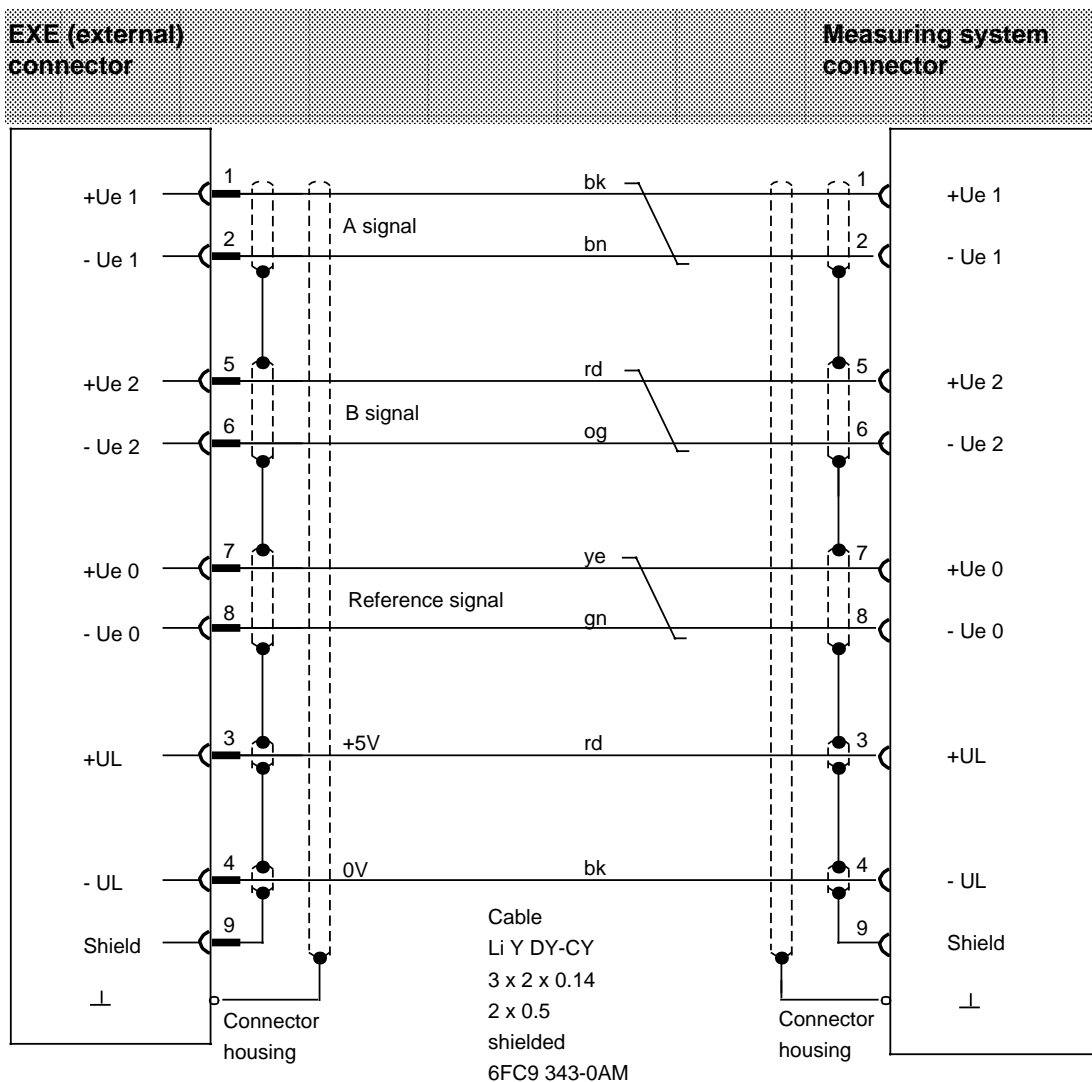

Connector
9-pin socket
SIEMENS
Cable 8 mm
Connection side

6FC9 341 - 1AT

Designation: EXE

Connector link

9-pin socket
SIEMENS
Cable 8 mm
Connection side

6FC9 341 - 1EW

Designation: LINEAL

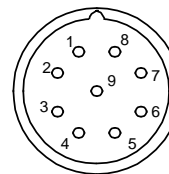

Cable between carrier modules (round cable)

Order No.: **6FC9 344-3Q**

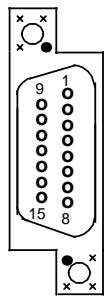
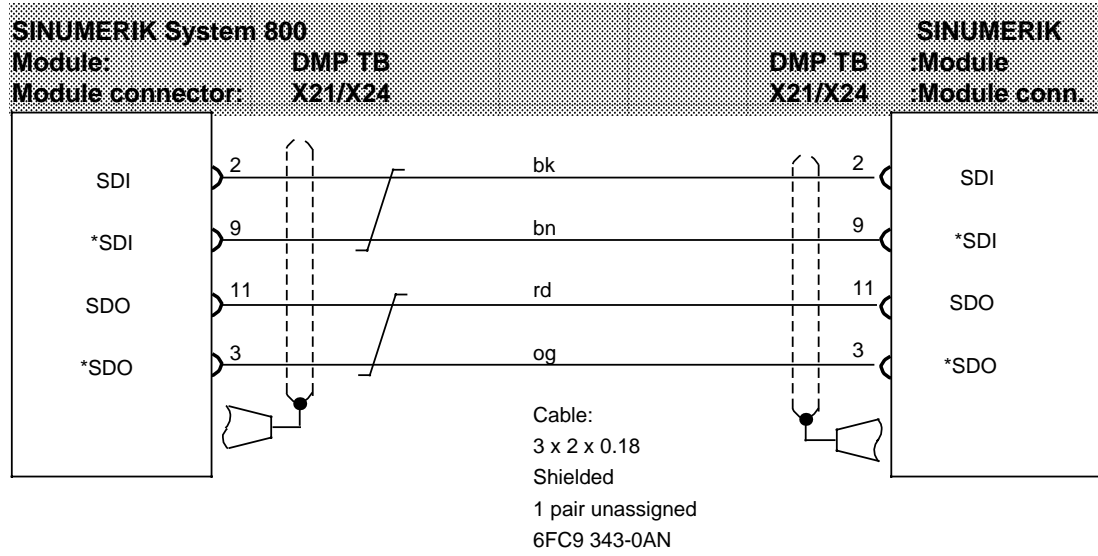

Connector

Position: 1, top
 15-pin Sub D socket
 Connection side
 SINUMERIK housing
 6FC9 341-1EC

Designation: DMP

Connector code

- Coding pin
- x No pin

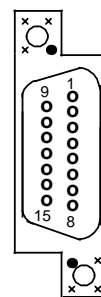

Cable between Interface DMP/Interface PLC/PLC 135 WD and terminal block, machine control panel or distribution box

Order No.: **6FC9 344-3S**

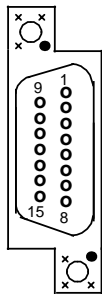
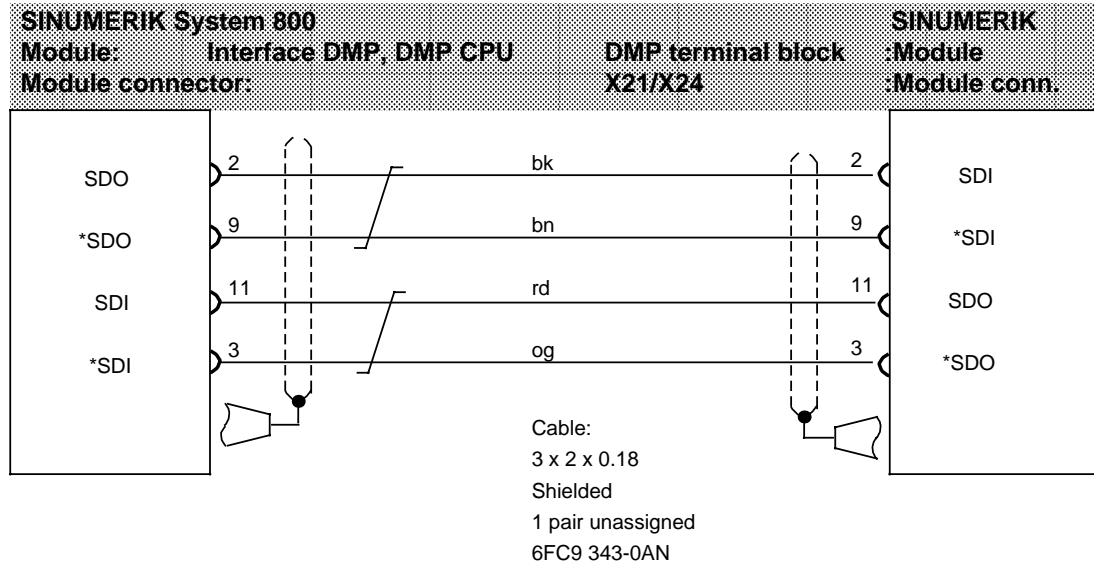

Connector

Position: 1, top
15-pin Sub D socket
Connection side
SINUMERIK housing
6FC9 341-1EC
Designation: NC

Connector code

- Coding pin
- x No pin

Connector

Position: 1, top
15-pin Sub D socket
Connection side
SINUMERIK housing
6FC9 341-1EC
Designation: DMP

Connector code

- Coding pin
- x No pin

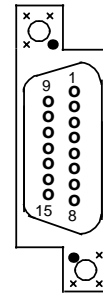

Cable between MIXED I/O module and terminal strip converter with LEDs

Order No.: **6FC9 344-3X**

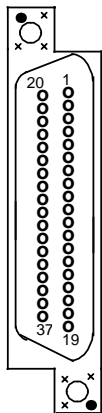
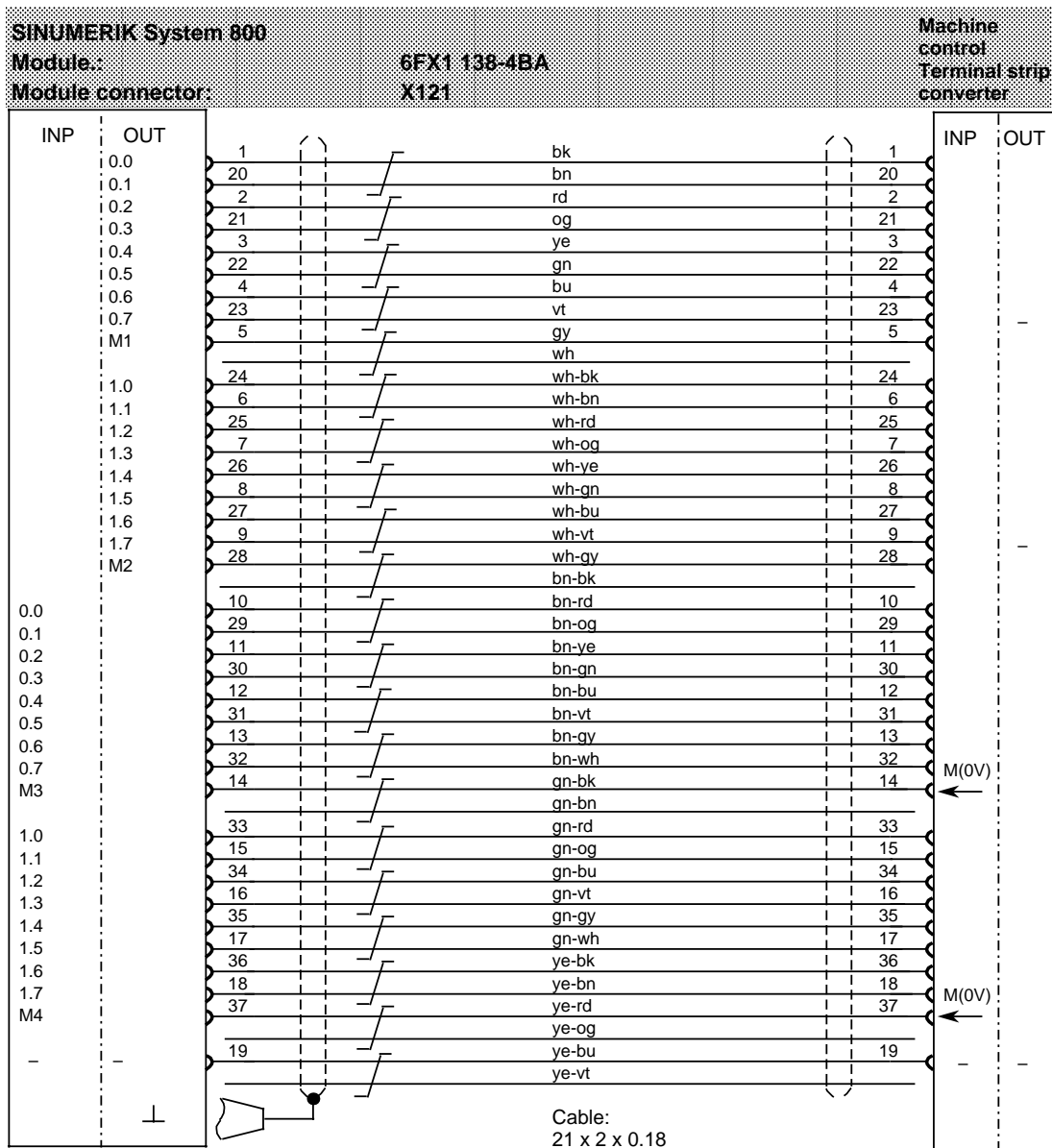

Connector

Position: 1, top
37-pin Sub D socket
Connection side
SINUMERIK housing
6FC9 341-1FH

Designation: NC

Connector code

- Coding pin
- x No pin

Connector

Position: 1, top
37-pin Sub D socket
Connection side
SINUMERIK housing
6FC9 341-1FH

Designation: KLU

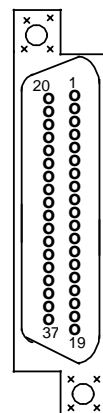

Cable between HMS and SIPOS measuring circuit module, trailing cable

Order No.: **6FC9 344-4D 01**

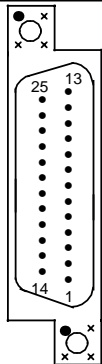
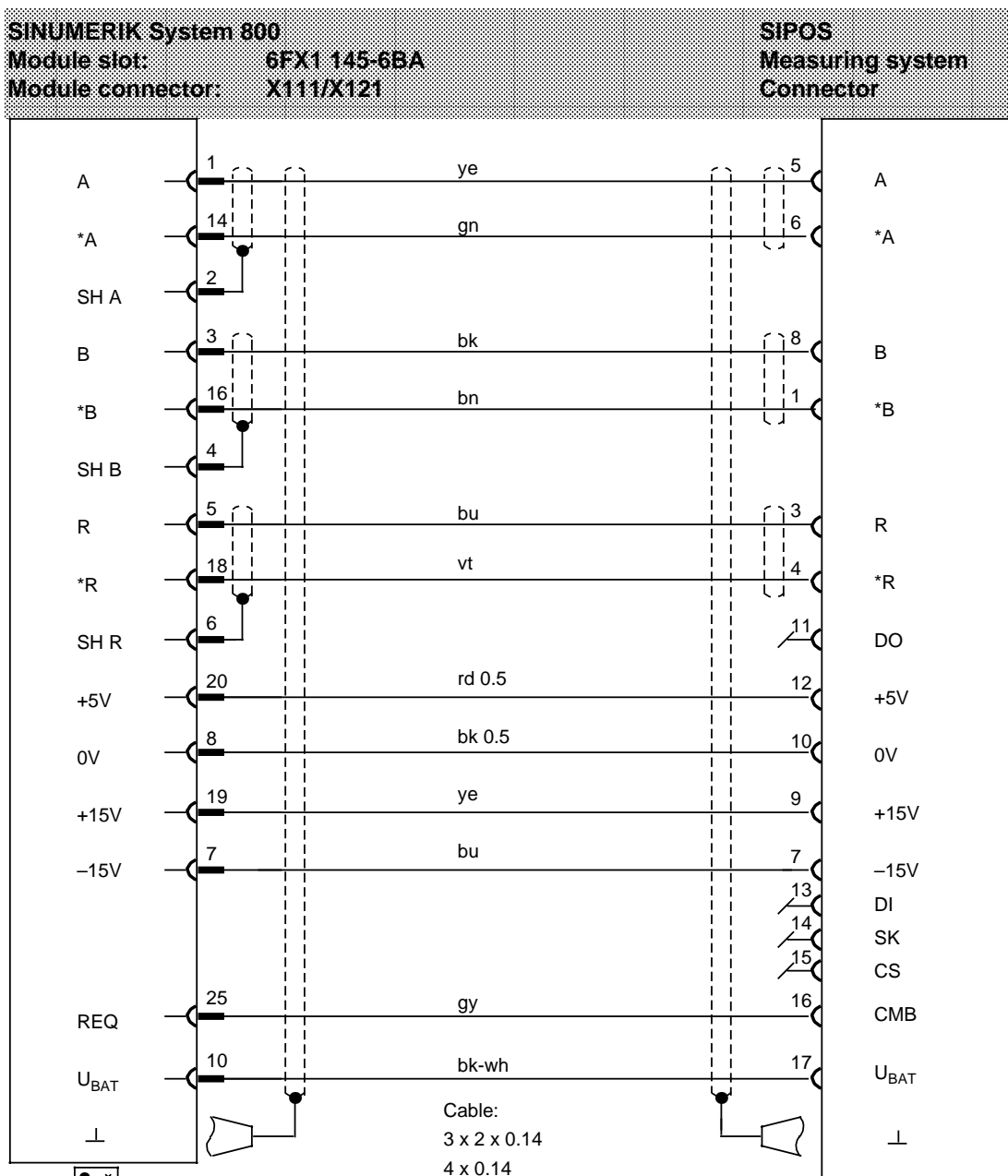

Connector
Position: 1, bottom
25-pin Sub D connector
Connection side
SINUMERIK housing
6FC9 341-2AB
Designation: NC

Connector code

- Coding pin
- x No pin

Connector
17-pin socket
SIEMENS
Cable 8 mm
Connection side
6FC9 341-1HA
Designation: SIPOS

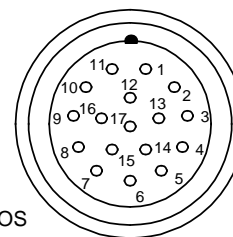

Cable between distribution box and handheld unit

Order No.: **6FC9 344-4G**

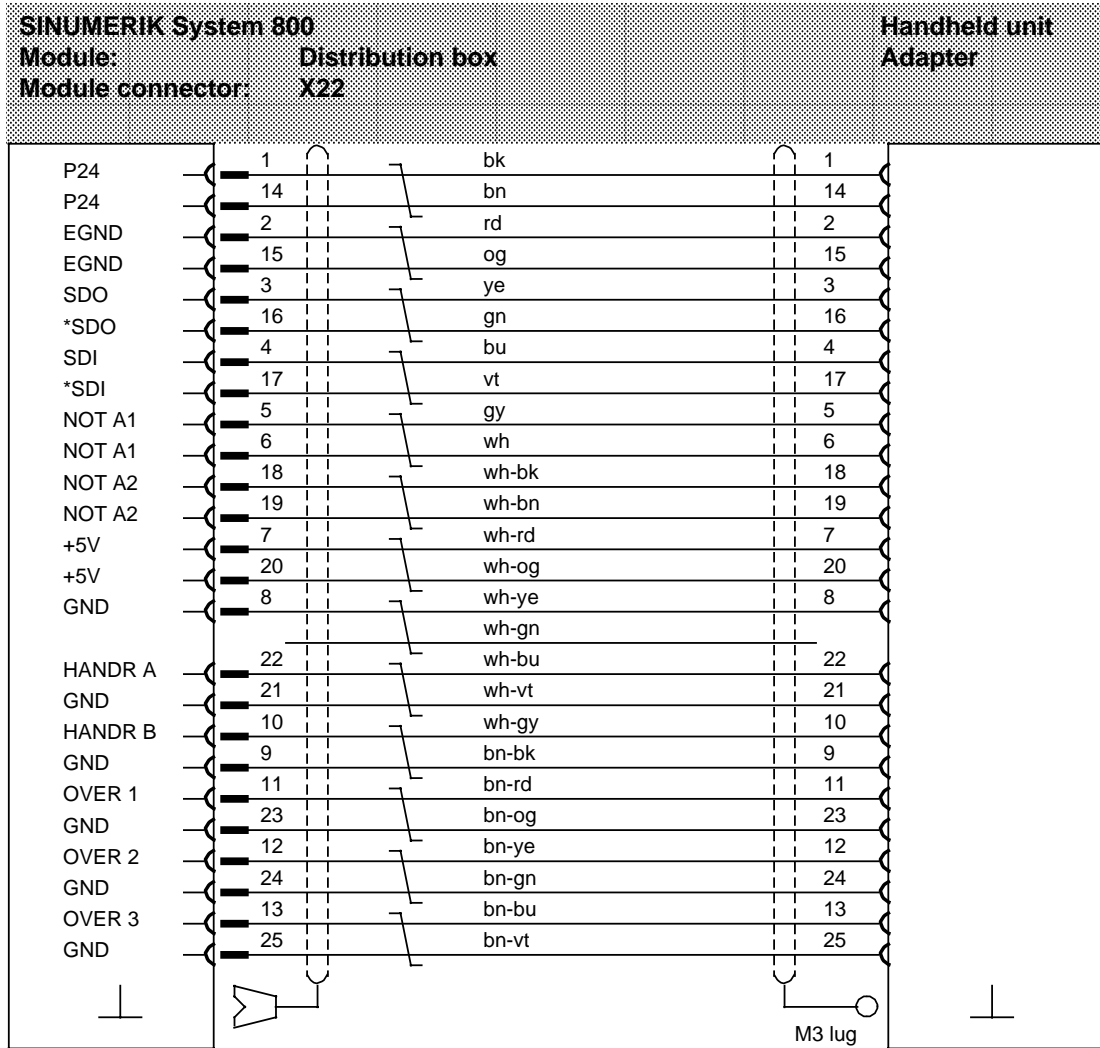

Connector

Position: 1, bottom
 25-pin Sub D connector
 Connection side
 SINUMERIK housing
 6FC9 341-2AB
 Designation: BCX

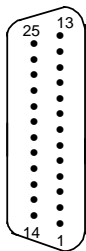

Connector

Position: 1, bottom
 25-pin Sub D socket
 Connection side
 without housing
 with buttons and nuts
 Designation: BHG
 +add-on housing
 ID No. 40013583
 +adapter blocks for
 Sub D conn. ID No. 40038511

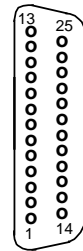

Cable between MMC CPU and WS 800A NC workstation

Order No.: **6FC9 344-4H**

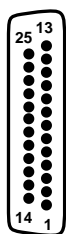
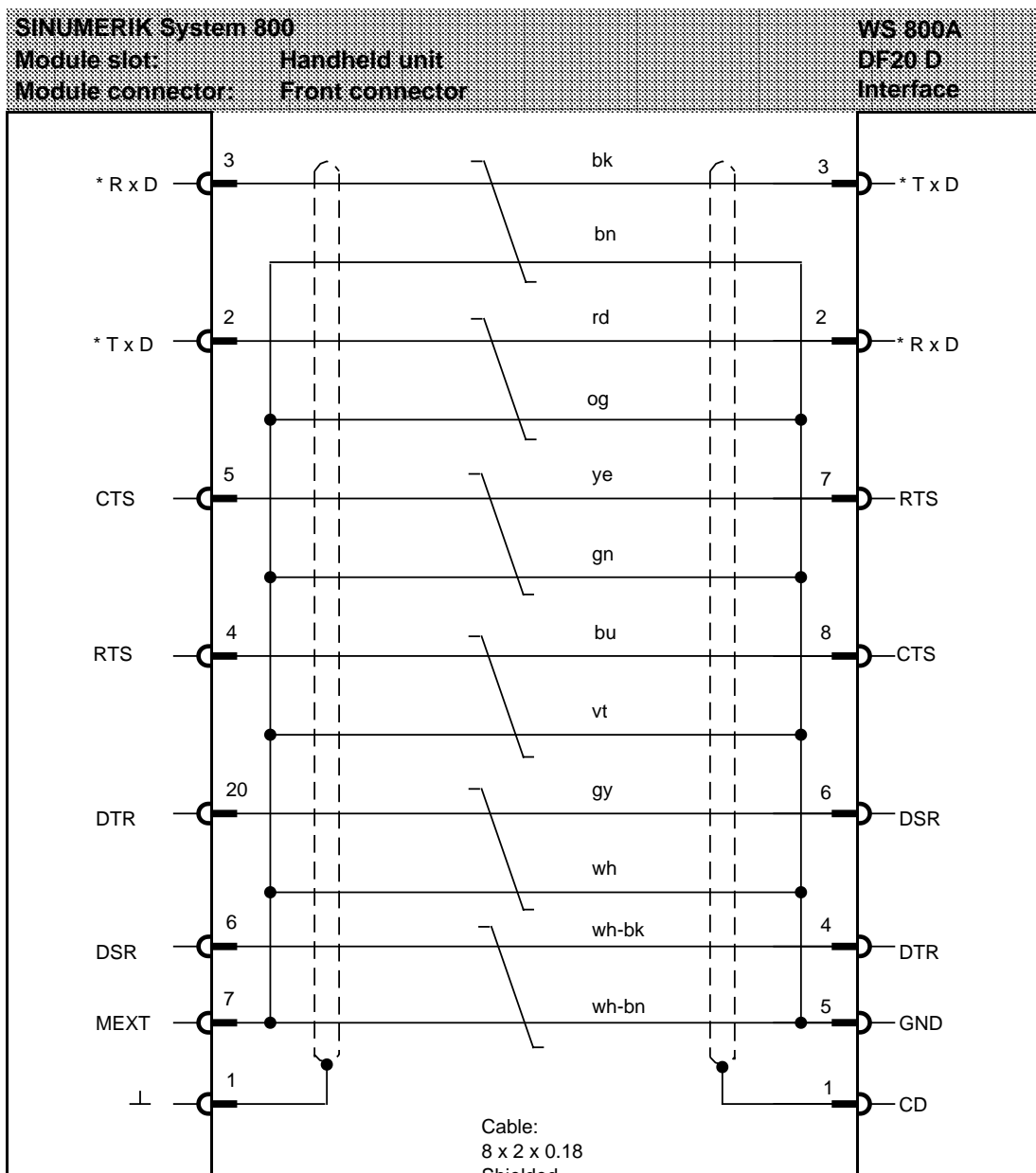

Connector
Position: 1, bottom
25-pin, Sub D connector
Connection side
Housing with push latch
6FC9 341-2AA
Designation: NC

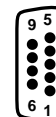

Connector
Position: 1, bottom
9-pin, Sub D connector
Connection side
SBM 383 housing
6FC9 341-2AF
Designation: PC

Cable between HMS measuring circuit module and incremental linear measuring system

Order No.: **6FC9 344-4L**

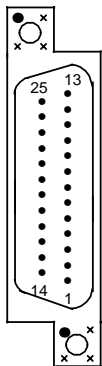
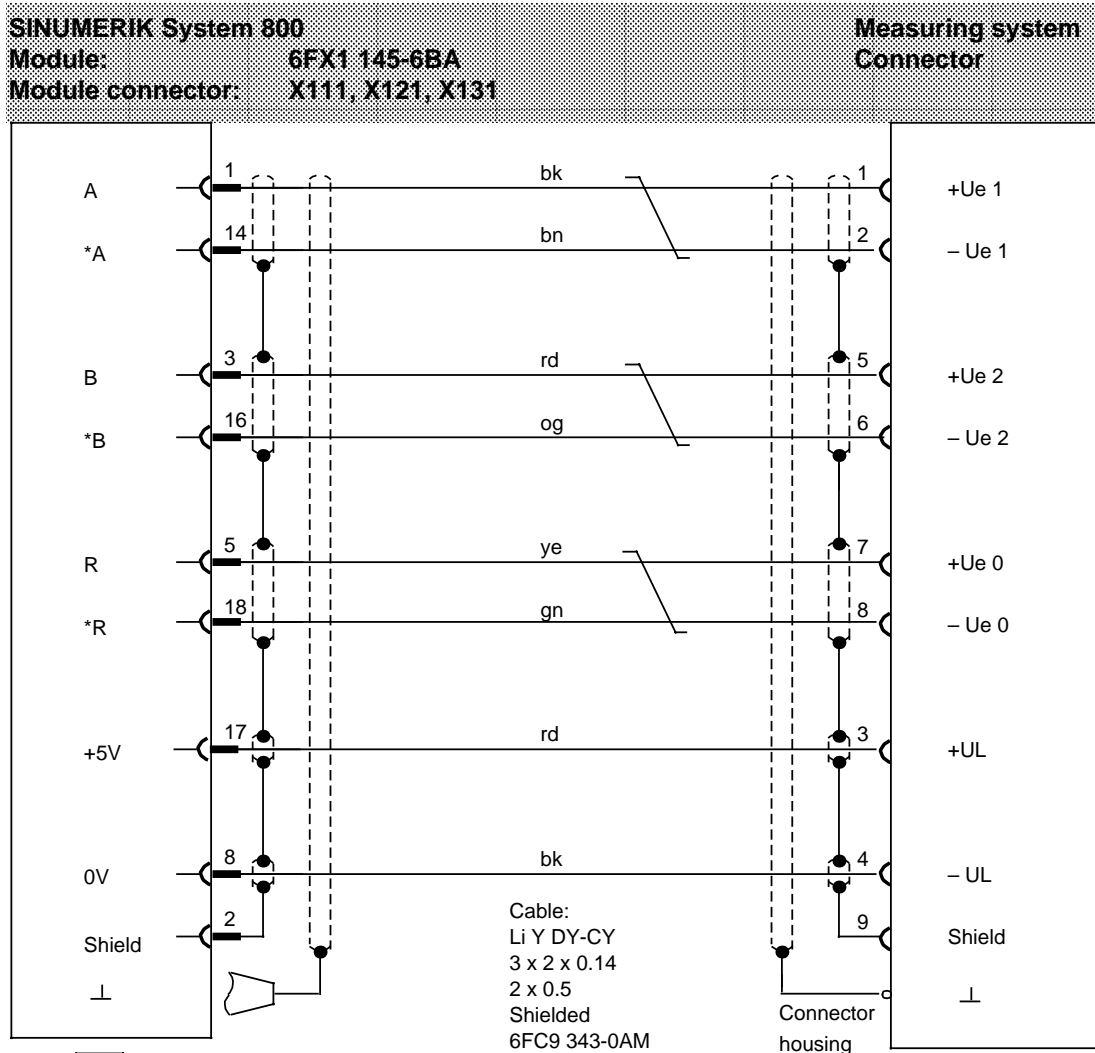

Connector
 Position: 1, bottom
 25-pin Sub D connector
 Connection side
 SINUMERIK housing
 6FC9 341-2AB
 Designation: NC

Connector coupling
 9-pin socket
 SIEMENS
 Cable 8 mm
 Connection side
 6FC9 341-1EW
 Designation: LINEAL

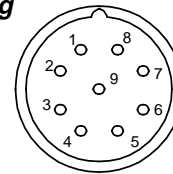

Connector code

- Coding pin
- x No pin

Cable between resolver and resolver converter

Order No.: **6FC9 344-4M**

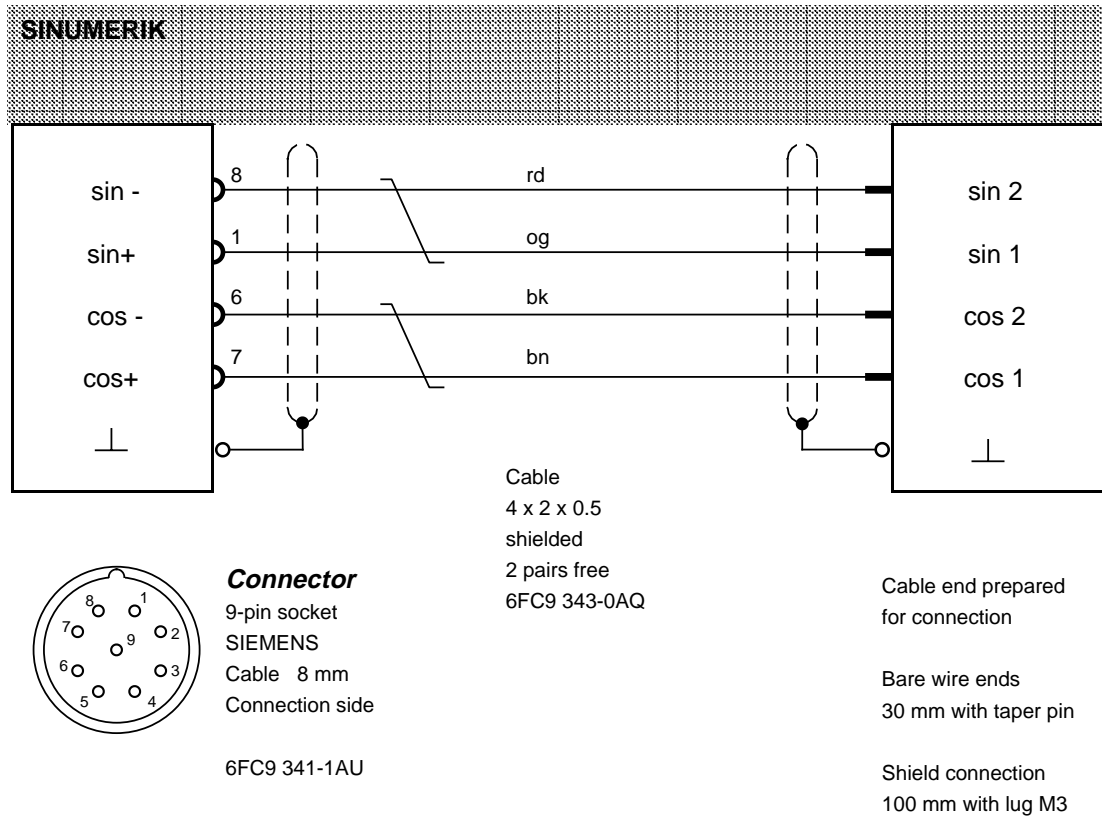

Cable between MMC CPU and monitor unit/slimline operator panel (RGB), trailing cable

Order No.: **6FC9 344-4N 01**

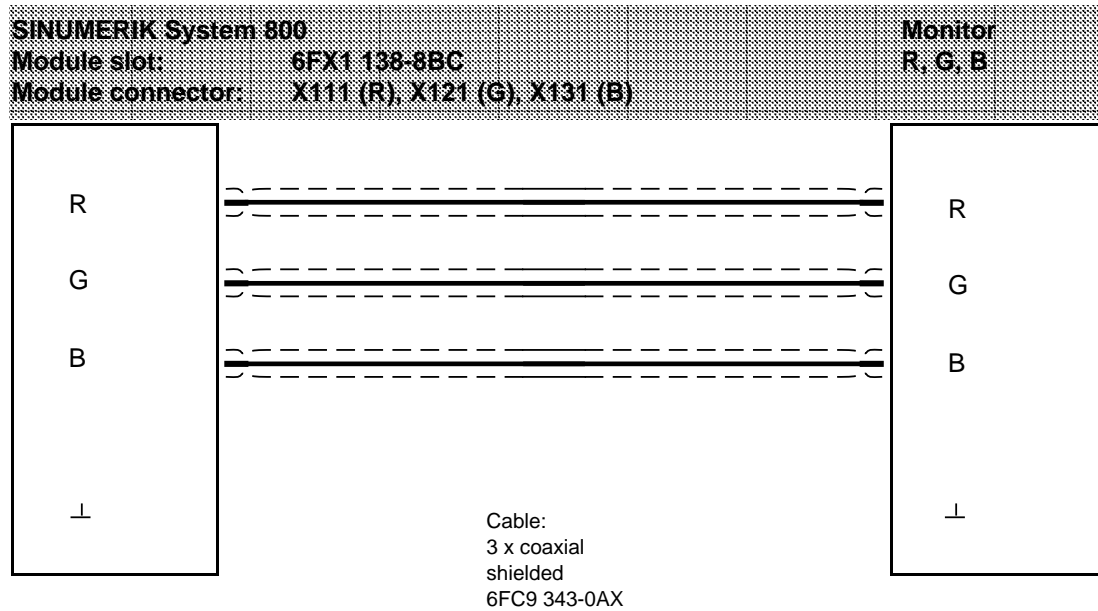

Connector
 BNC sockets

Connector
 BNC sockets

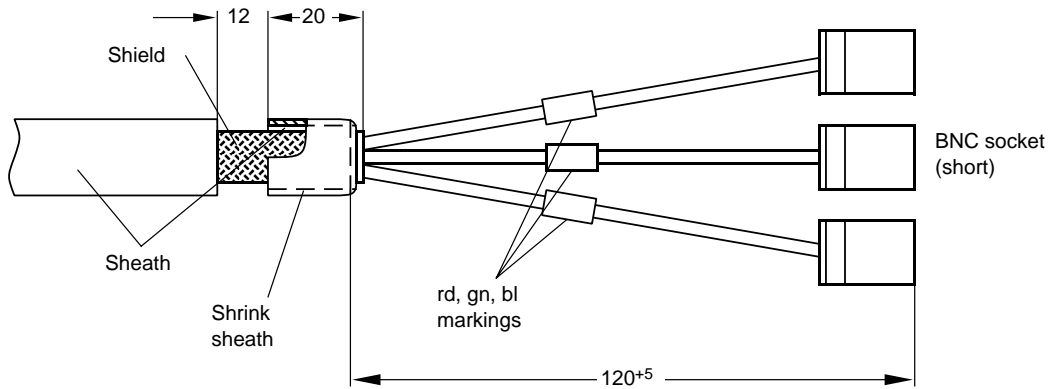

Cable characteristics:
 3 single coaxial cables, PVC sheath, polyurethane sheath, additional overall shield
 Connector: BNC
 Temperature range: -40 °C to 90 °C
 Resistance to: Oil, coolants to VDE 472/804
 Min. permiss. bending radius : 150 mm

Cable to SIMATIC PG 7xx (COM 1)

Order No.: **6FC9 344-4R**

SINUMERIK System 800 Module: Module connector:	PG 7xx COM 1
---	-------------------------------

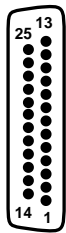
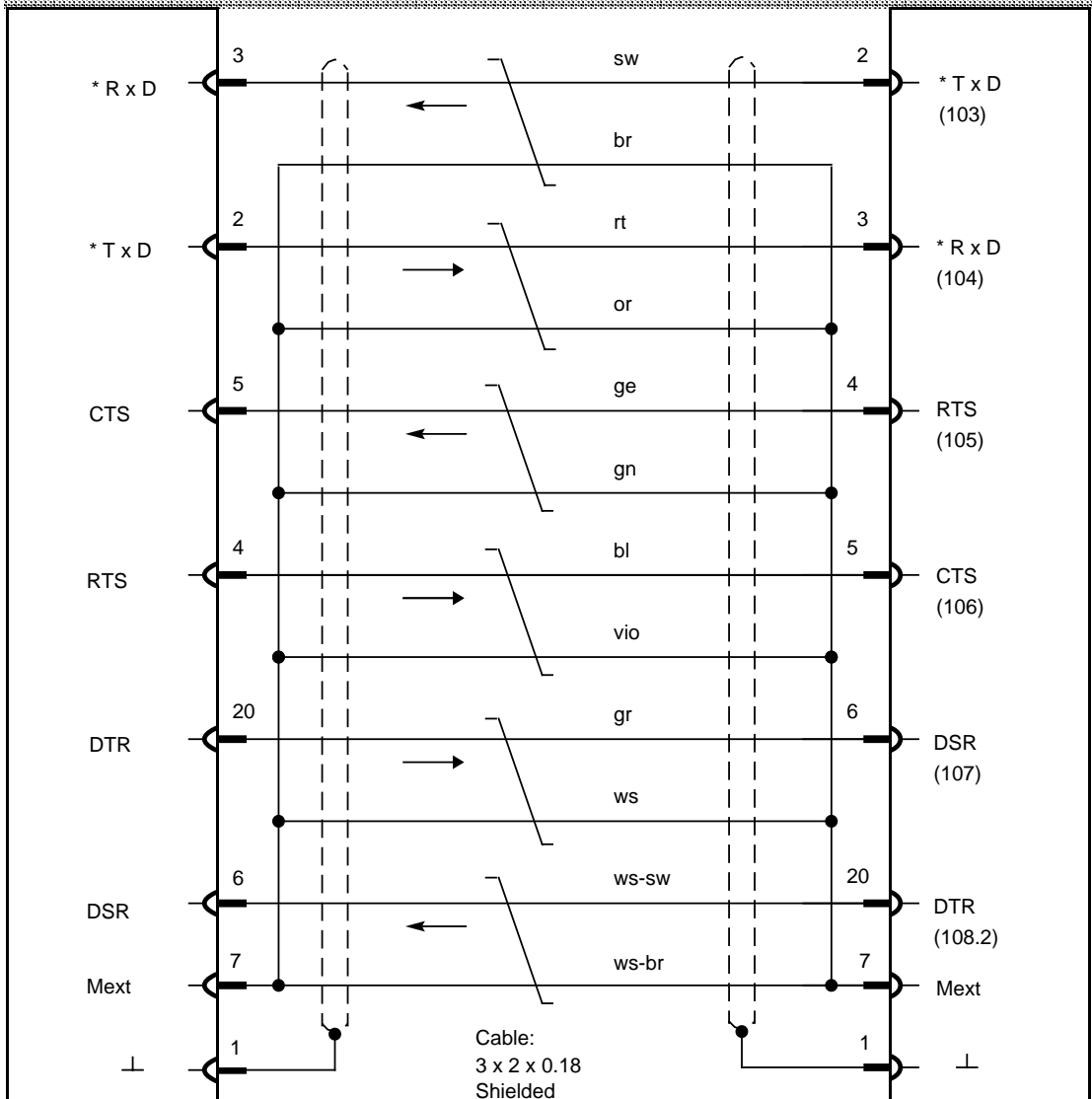

Connector
 Position: 1, bottom
 25-pin Sub D
 connector
 Connection side
 Housing with push
 latch
 6FC9 341-2AA
 Designation: NC

Connector code
 ● Coding pin
 × No pin

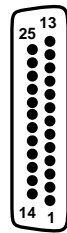

Connector
 Position: 1, bottom
 25-pin Sub D
 connector
 Connection side
 Post office housing
 6FC9 341-1ES
 Designation: PG

Cable to SINUMERIK WS-800A NC workstation (RS 232 C) , SIMATIC PG 7xx (COM 2)

Order No.: **6FC9 344-4T**

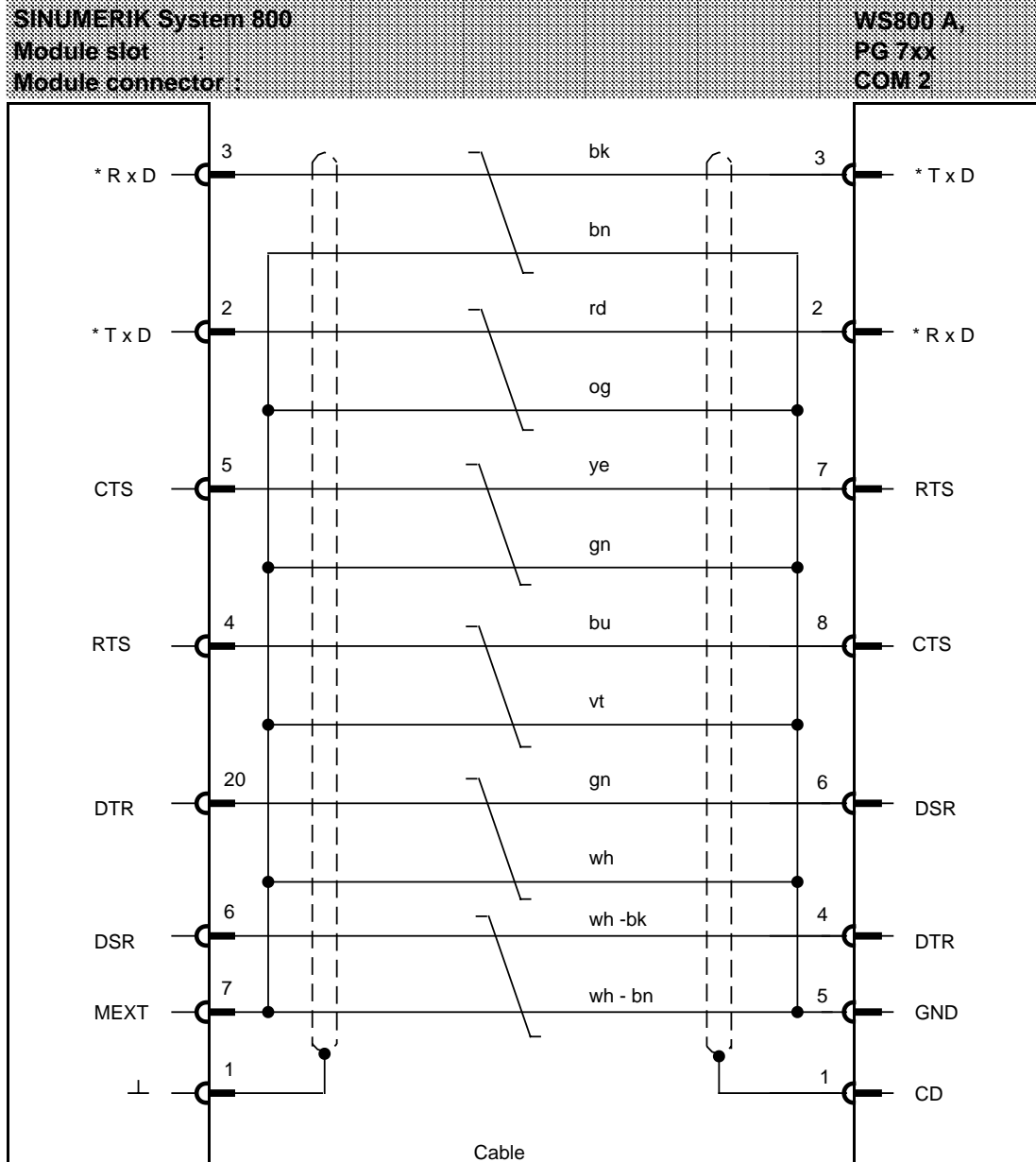

Cable
 8 x 2 x 0.18
 shielded
 6FC9 343-0AA

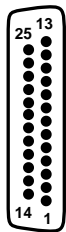

Connector
 Position 1 bottom
 25-pin sub D socket
 Connection side
 Housing with
 push latch
 6FC9 341-2AA
 Designation: NC

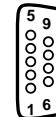

Connector
 Position 1 bottom
 9-pin sub D socket
 Connection side
 SBM 383 housing
 6FC9 341-2AF
 Designation: PC

Cable between MMC CPU and VALITEK streamer

Order No.: **6FC9 344-4X**

SINUMERIK 840C
Module:
Module connector: **X122**

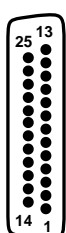
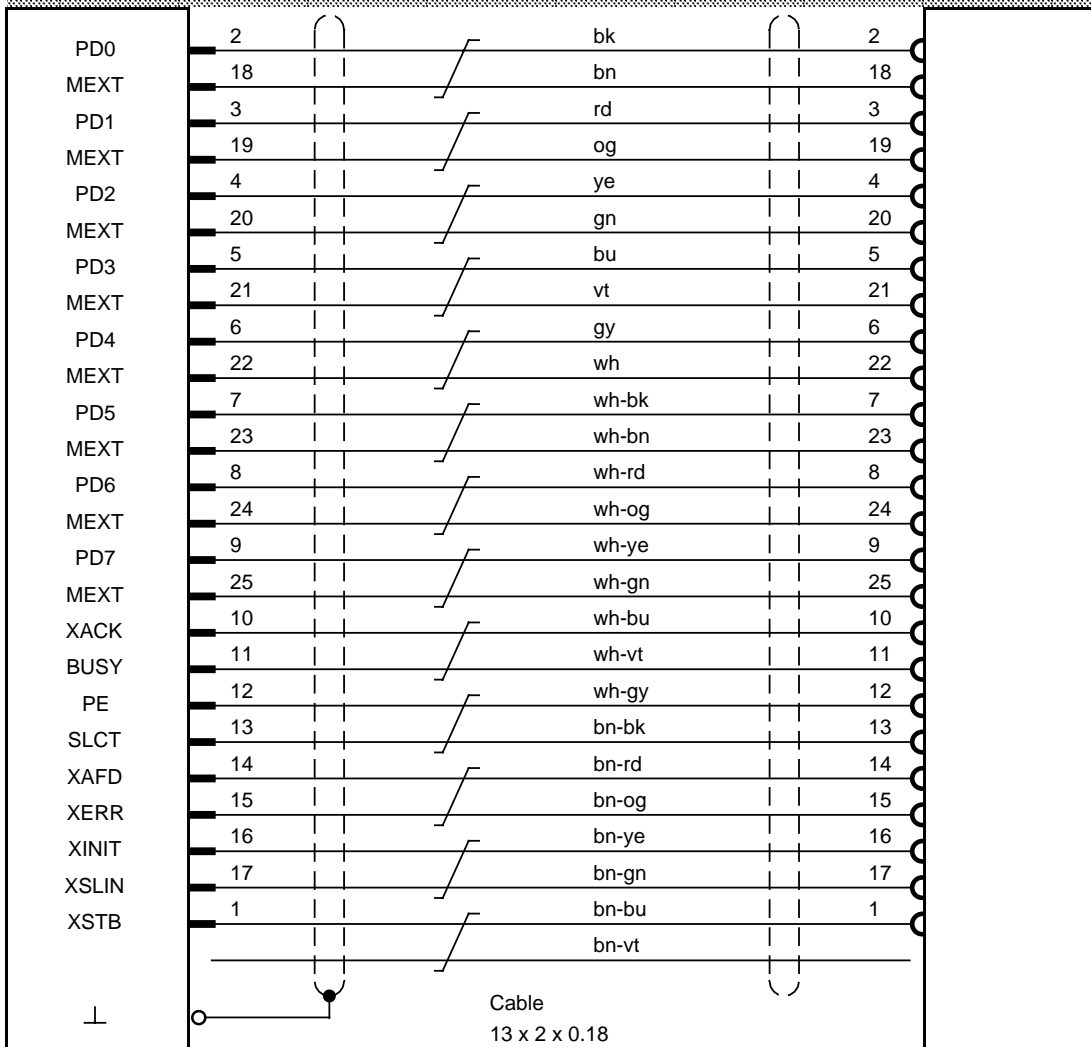

Connector
Position 1 bottom
25-pin sub D connector
crimped
Connection side
Housing with push latch
6FC9 341-2AA
Designation: NC

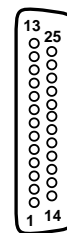

Connector
Position 1 bottom
25-pin sub D socket
crimped
Connection side
Screw housing
6FC9 341-1ER
Designation: PC-CEN

Cable between MMC CPU, PG/PC and PC link

Order No.: **6FX2002-1AA02-1AD0**

SINUMERIK 840C

Module:

Module connector: **X122**

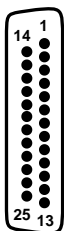
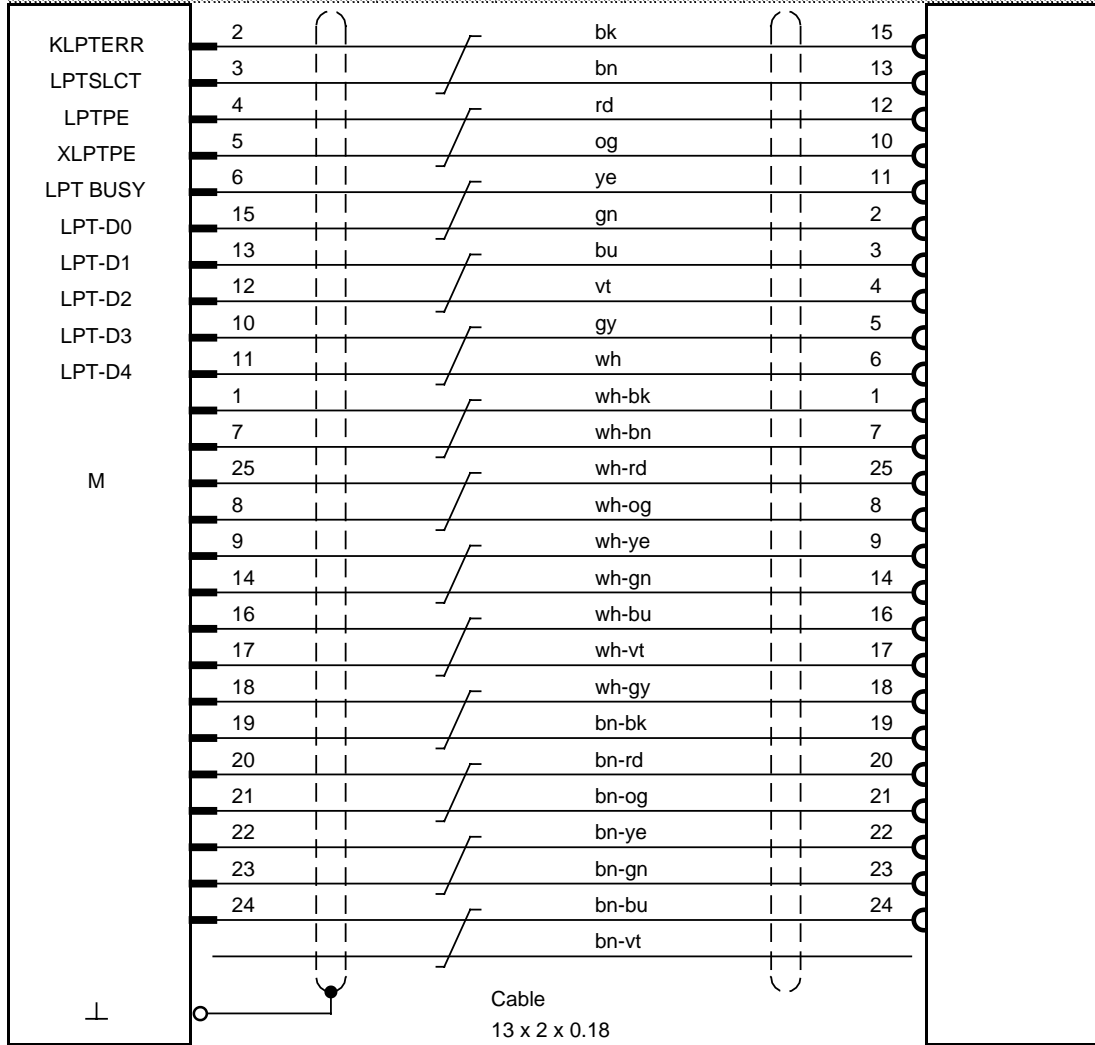

Connector

Position 1 top
 D-Sub, crimped
 25-pin, male connector
 Connection side
 SBM housing with push latch

6FC9341-2AA00

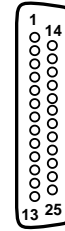

Connector

Position 1 top
 D-Sub, crimped
 25-pin, female connector
 Connection side
 Screw housing

6FC9348-7HS00

Cable between MMC interface and diskette drive FD-E2

Order No.: **6FC9 344-5G**

SINUMERIK 840C
Module slot:
Module connector:

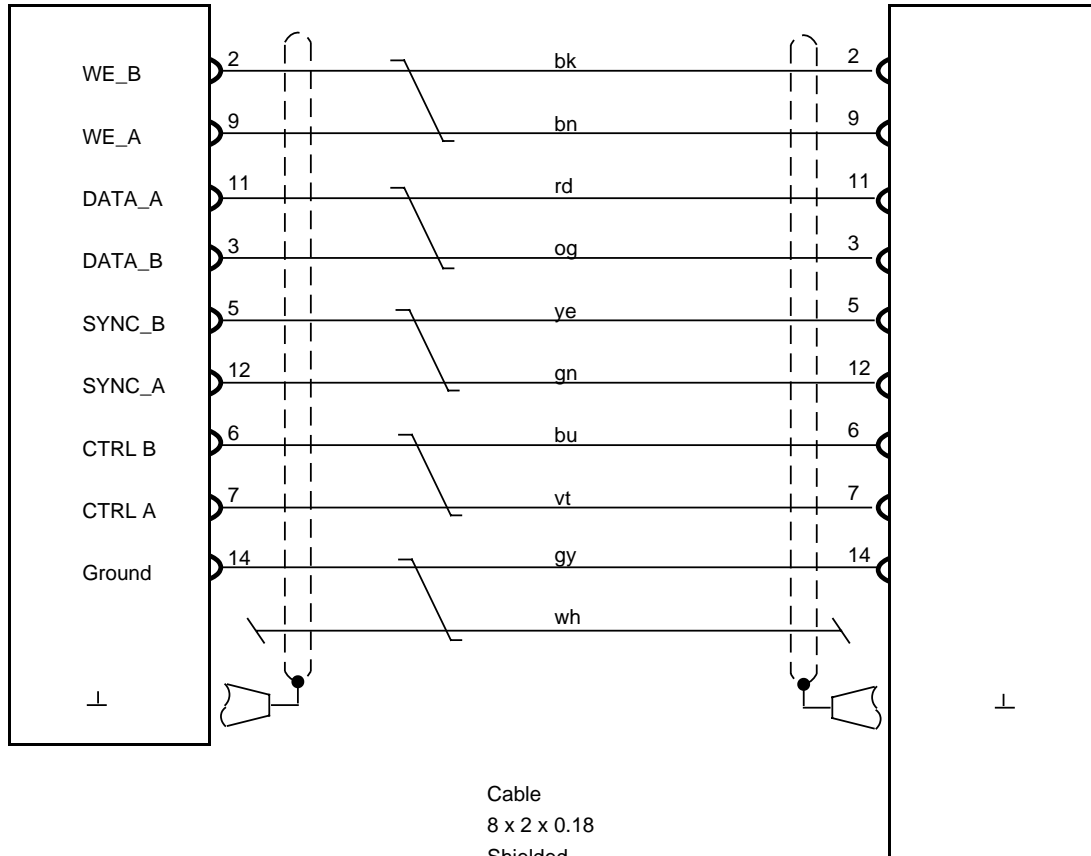

Cable
8 x 2 x 0.18
Shielded
3 pairs unassigned
6FC9 343-0AA

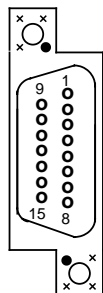

Connector
Position: 1, top
15-pin Sub D socket
Connection side
SINUMERIK housing
6FC9 341-1EC
Designation: LFI-H

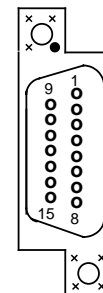

Connector
Position: 1, top
15-pin Sub D socket
Connection side
SINUMERIK housing
6FC9 341-1EC
Designation: LFI-D

Connector code

- Coding pin
- x No pin

Cable between CSB and 4-way I/O device

Order No.: **6FC9 344-5H**

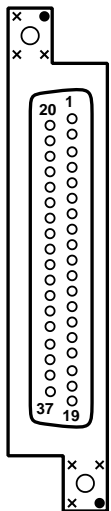
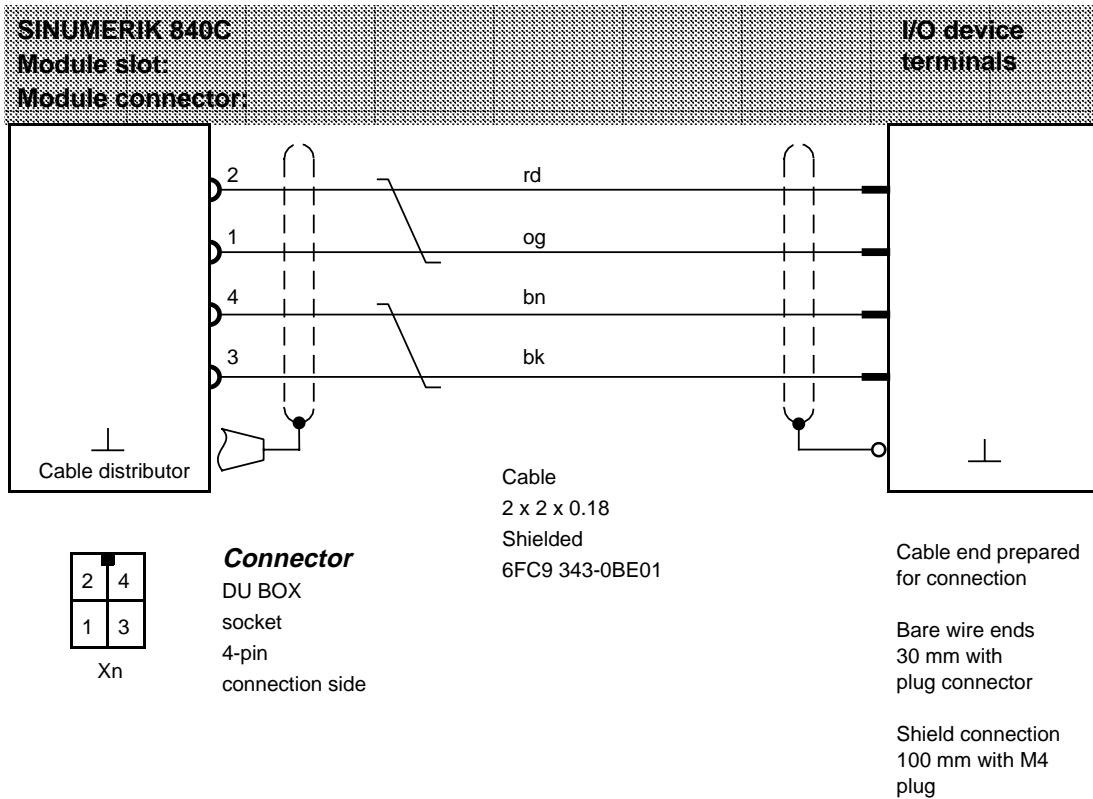

Cable distributor connector
 Position: 1 top
 37-pin sub D socket
 Connection side
 SINUMERIK housing
 6FC5 147-0AA01-0AA0

Connector code

- Coding pin
- x No pin

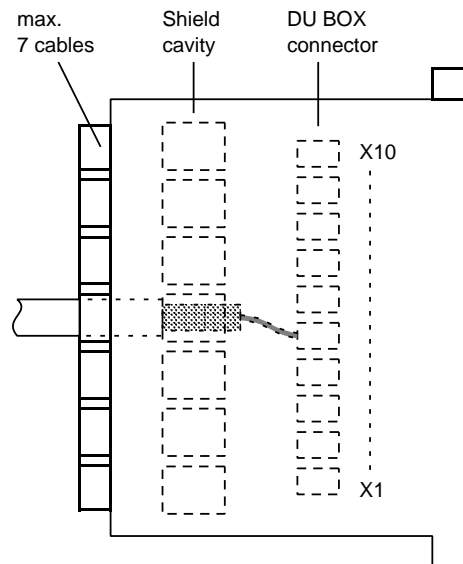

Cable between CSB and 8-way I/O device

Order No.: **6FC9 344-5K** (old)
6FX2 002-4AA21- (new)

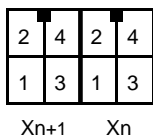
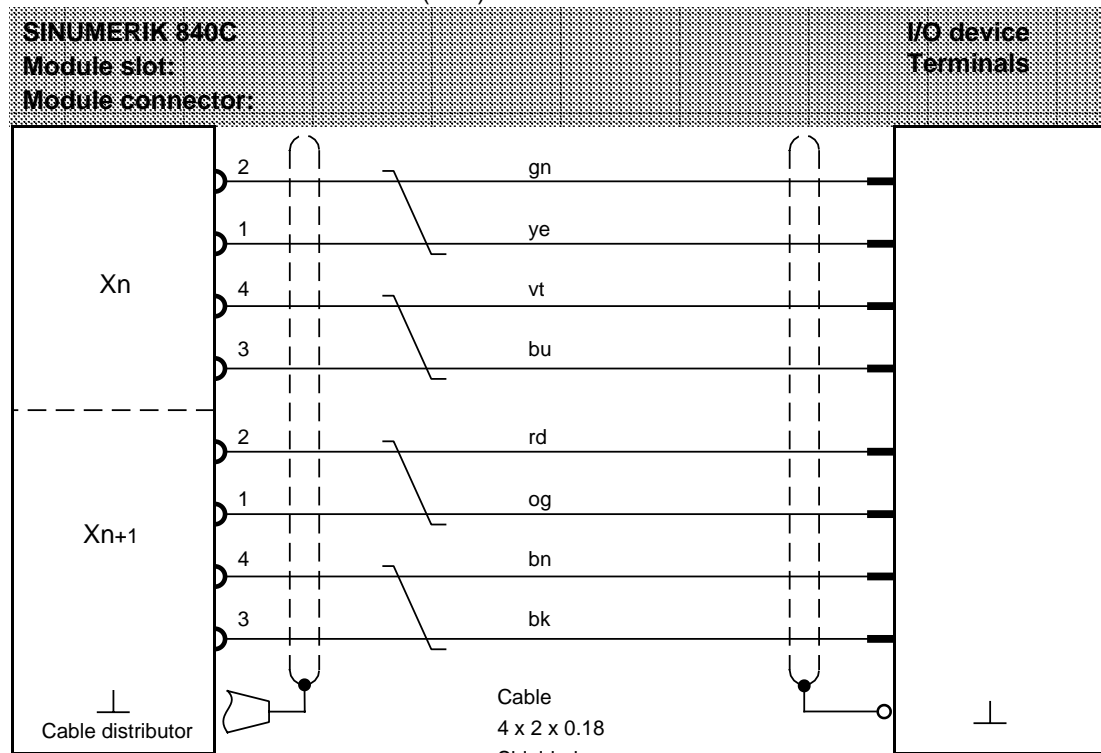

Connector
DU BOX
socket
4-pin
connection side

Cable end prepared for connection

Bare wire ends
30 mm with
plug connector

Shield connection
100 mm with M4
for plug

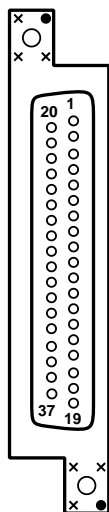

Cable distributor connector
Position: 1 top
37-pin sub D socket
Connection side
SINUMERIK housing
6FC5 147-0AA01-0AA0

Connector code
● Coding pin
x No pin

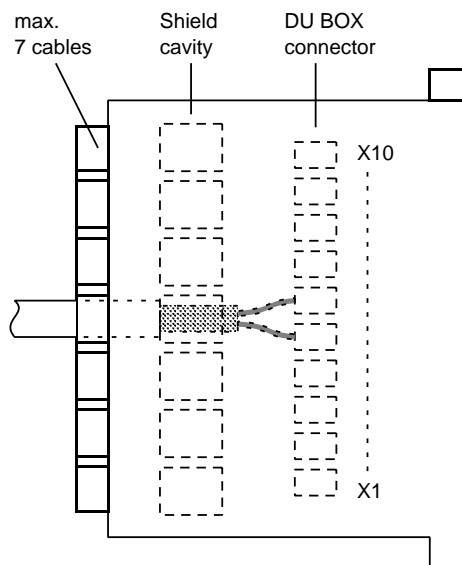

Cable between MIXED I/O module and analog output signals

Order No.: **6FC9 344-5L** (old)
6FX2 002-4AA11- (new)

SINUMERIK System 800

Module:

Module connector:

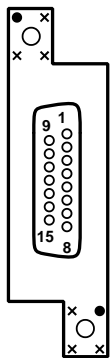
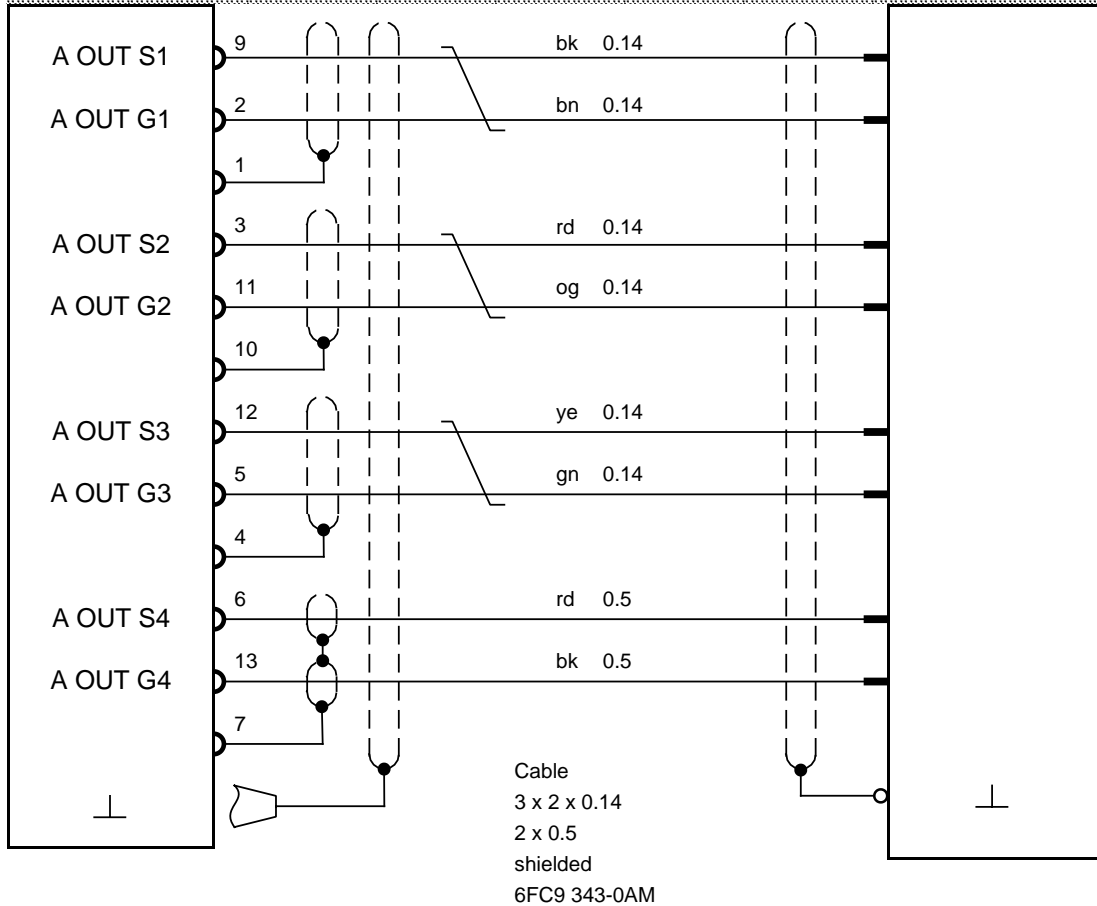

Connector

Position: 1 top
 15-pin sub D socket
 Connection side
 SINUMERIK housing
 6FC9 341-1EC

Connector code

- Coding pin
- x No pin

Cable end
 prepared for
 connection

Bare wire ends
 100 mm
 Wire end ferrules

Cable between Interface PLC/PLC 135 WD and 8 fast interrupt inputs

Order No.: **6FC9 344-5M** (old)
6FX2 002-4AA31- (new)

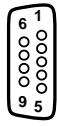
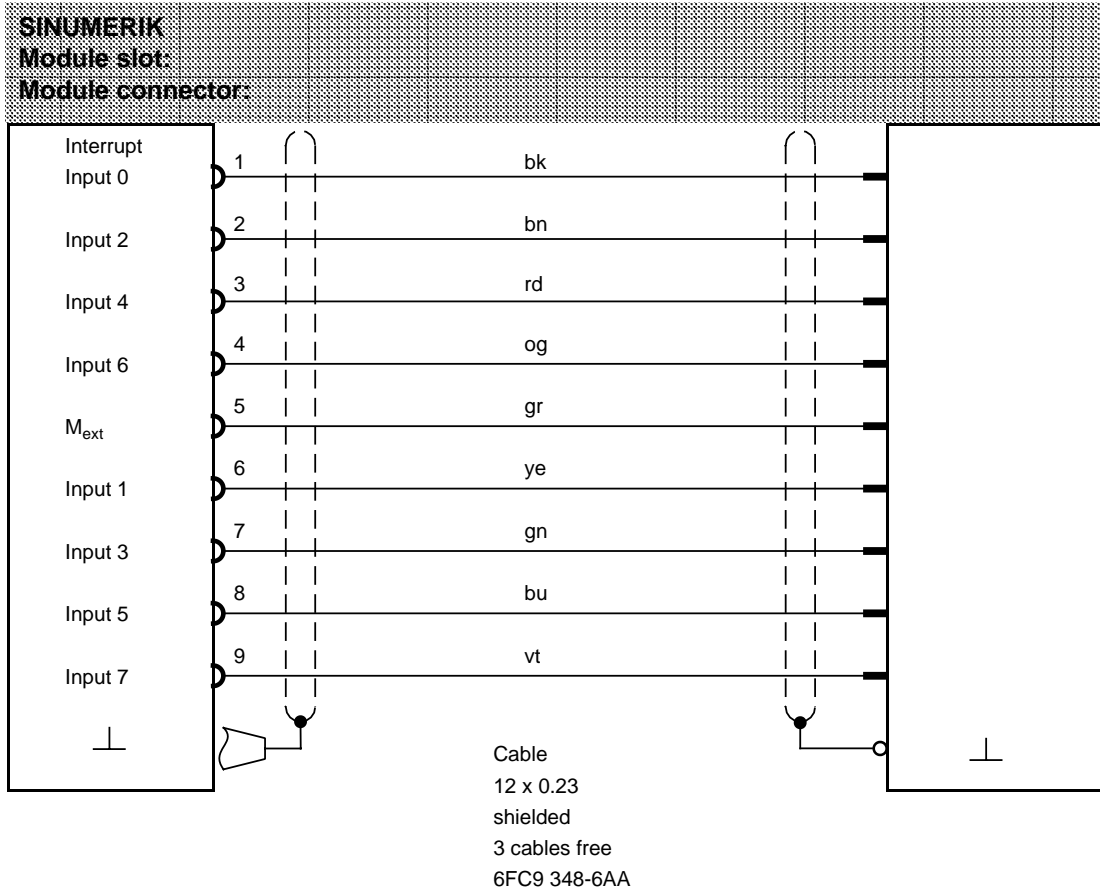

Connector

Position 1 top
9-pin sub D socket,
crimped
Connection side
SBM 383 housing
6FC9 341-2AE

Cable end
prepared for
connection

Bare wire ends
100 mm
Wire end ferrules

Cable between IP20 DMP terminal block - IP65 DMP terminal block

Order No.: **6FC9 344-5N**

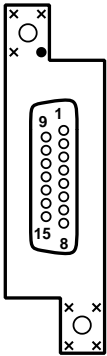
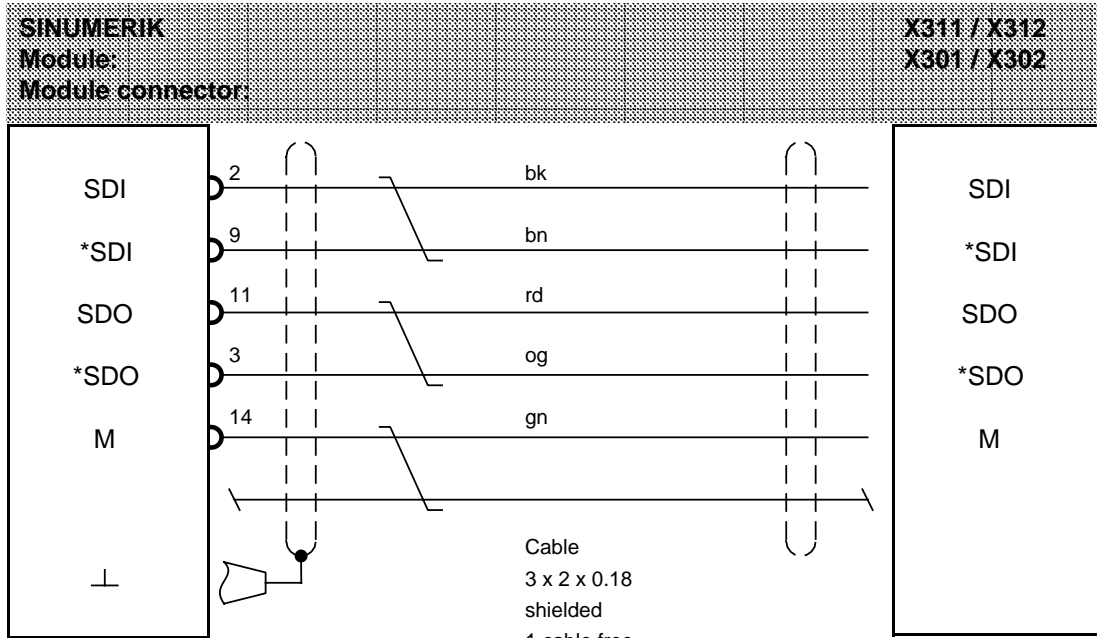

Connector
 Position: 1 top
 15-pin sub D socket
 Connection side
 SINUMERIK housing
 6FC9 341-1EC
 Designation: DMP

Connector code

- Coding pin
- x No pin

Cable end prepared for connection according to detailed drawing

Tin-coated cable ends

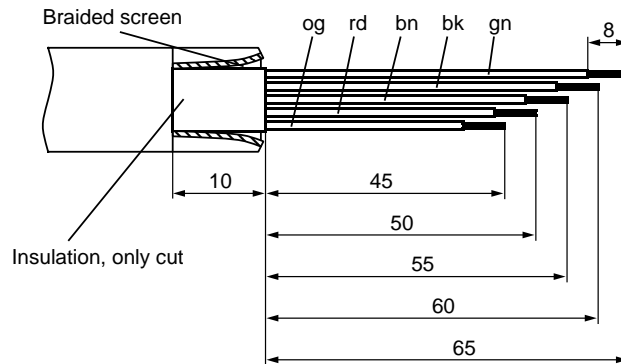

Cable between IP65 DMP terminal block and IP 65 DMP terminal block

Order No.: **6FC9 344-5S**

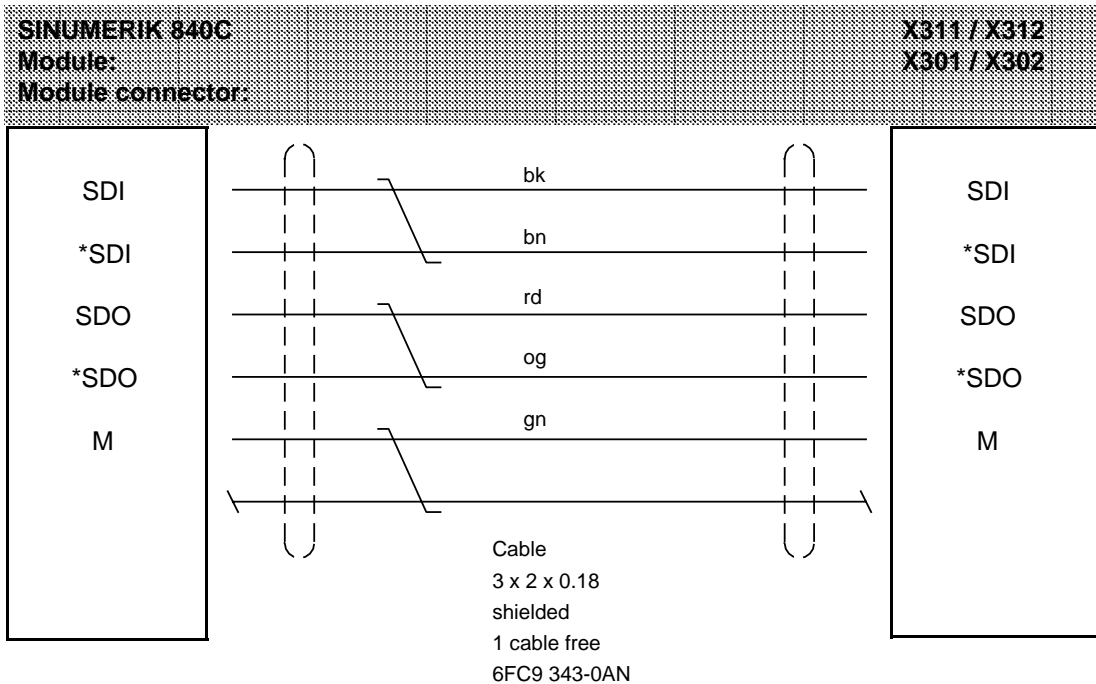

Cable end prepared for connection according to detailed drawing

Tin-coated cable ends

Cable end prepared for connection according to detailed drawing

Tin-coated cable ends

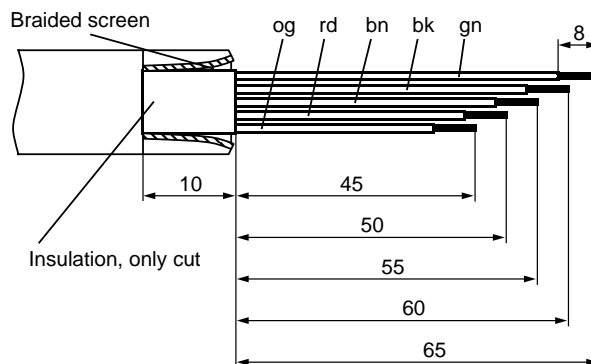

Cable between NC CPU and SIMODRIVE 611D (drive cable)

Order No.: **6FX 2002-1CB01-0B 0**

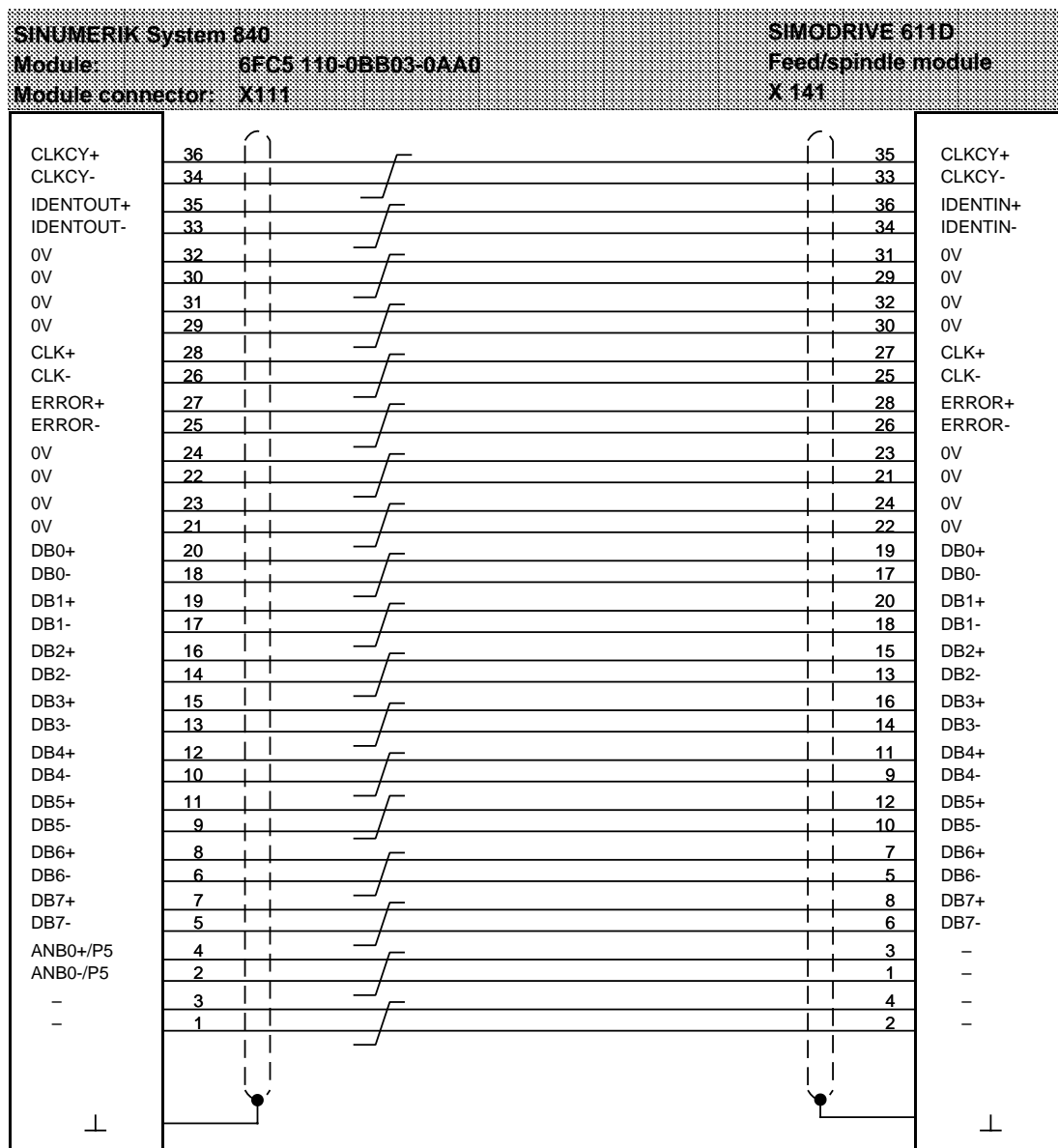

Connector
 NCP036-010BS
 Mini-Delta-Ribbon
 36-pin
 Housing
 NHA050-MC01-EMI
 Designation: OUT

Cable
 BSC1-CF-30 x 19 P
 Round cable, twisted
 in pairs, shielded

Connector
 NCP036-010BS
 Mini-Delta-Ribbon
 36-pin
 Housing
 NHA050-MC01-EMI
 Designation: IN

Note: Each cable is supplied with a shield connector (for SIMODRIVE modules).

6.4 Description of cables and connectors

The units must be connected only with the prescribed types of cable in accordance with Section 2 "Connections".

The cables must be protected against mechanical damage, for example by means of cable channels or sheet metal covers. Penetration of oil, coolant or chips must be avoided. Communications cables must not be run in parallel to power cables. Cables not belonging to the control must not be taken through the central controller.

The connectors must be securely screwed onto the front panels of the modules.

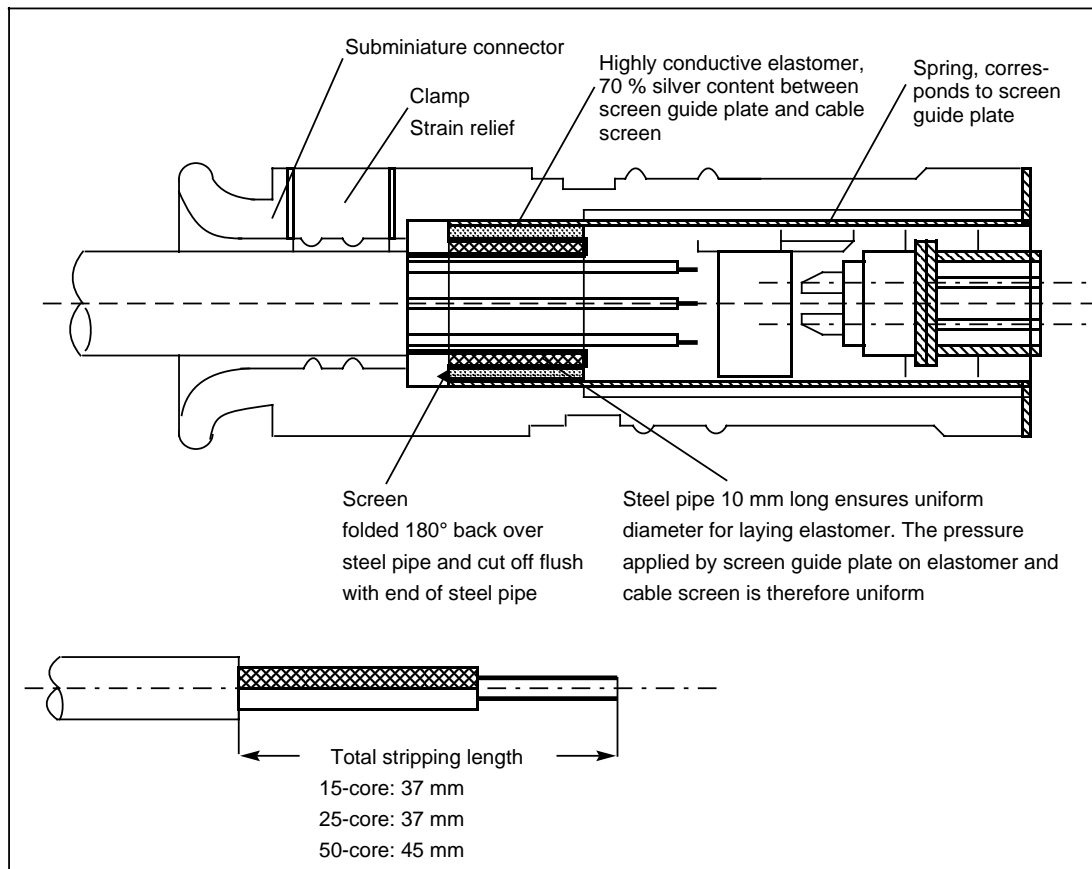

Subminiature connector

Connector features:

- Uniform international standard connector as 15, 25, 37 and 50-way version with special SINUMERIK housing
- Securing of the connector by means of captive screws on the front panels of the printed circuit boards.
- Cable strain relief in the connector.
- Plug-in coding for unmistakable connection of the cable connector.
- Perfect connection to frame between cable outside screen and in electronics of the SINUMERIK by means of springs fitted in the connector.

Installation rules

On the NC side, this SIEMENS subminiature connector must be used because no other connector housing on the market has these features.

If the customer makes his own cable, the installation rules must definitely be followed, otherwise proper functioning cannot be guaranteed.

Subminiature connector with SINUMERIK housing

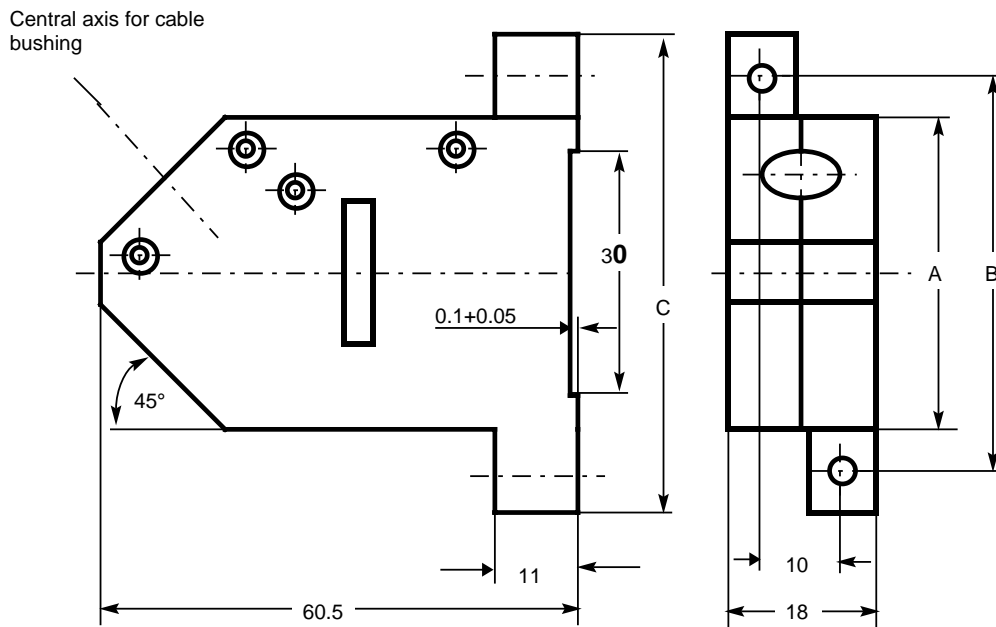

Submin. connector	Dim. A	Dim. B	Dim. C	Order No.: (complete with housing)
15-way female	43	53	63	6FX2 003-0AA15 (6FC9 341-1EC)
25-way female	57	67	77	6FX2 003-0AA25 (6FC9 341-1ED)
37-way female	71	81	91	6FX2 003-0AA37 (6FC9 341-1FH)
50-way female	71	81	91	6FC9 341-1EE
15-way male	43	53	63	6FC9 341-1EU
25-way male	57	67	77	6FC9 341-2AB
50-way male	71	81	91	6FC9 341-1EH

Installation notes

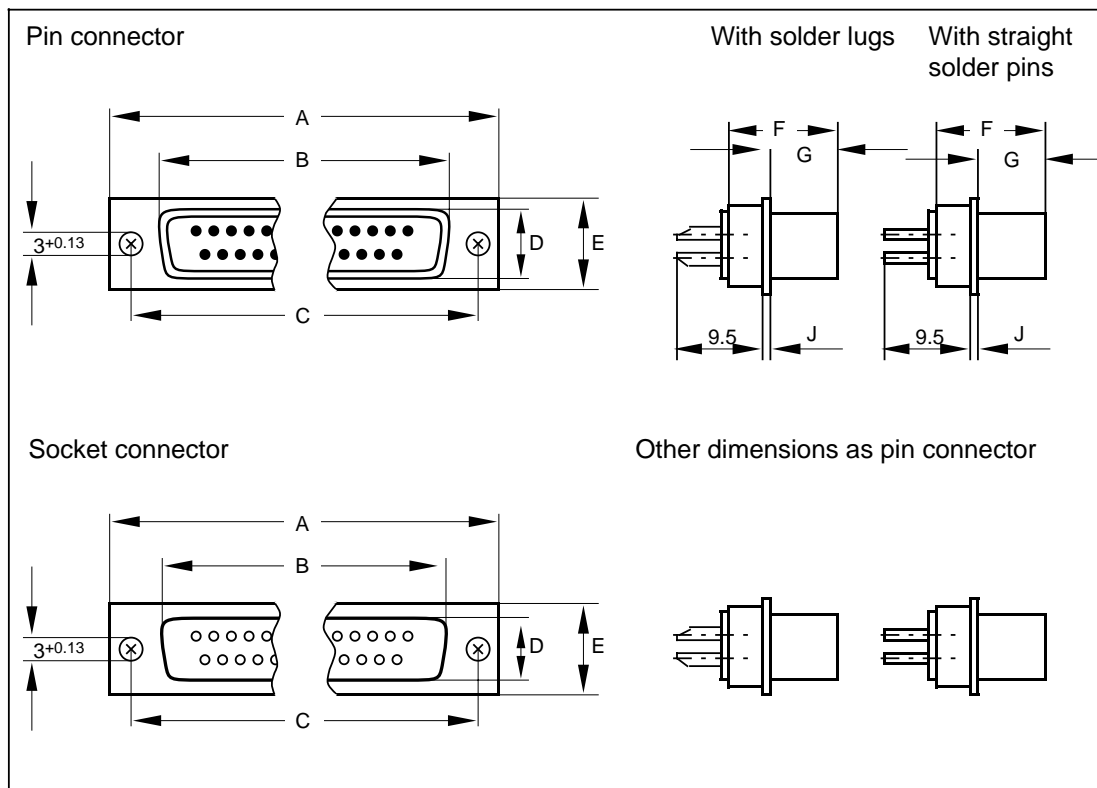

No. of pins	Connector	A in mm	B 1) in mm	C in mm	D 1) in mm	E in mm	F in mm	G in mm	J in mm
15	Male	39.1	25.2	33.3	8.4	12.5	10.8	5.9	1.0
15	Female	39.1	24.6	33.3	7.8	12.5	10.8	6.2	0.9
25	Male	53.0	38.9	47.0	8.4	12.5	10.8	5.9	1.0
25	Female	53.0	38.3	47.0	7.8	12.5	10.8	6.2	0.9
37	Male	66.9	52.8	61.1	11.1	15.4	10.8	5.9	1.0
37	Female	66.9	52.4	61.1	10.7	15.4	10.8	6.2	0.9
50 2)	Male	66.9	52.8	61.1	11.1	15.4	10.8	5.9	1.0
50 2)	Female	66.9	52.4	61.1	10.7	15.4	10.8	6.2	0.9

1) Dimensions are inside for pin connector and outside for socket connector

2) Three rows of pins/sockets

Siemens connector for rotary encoders

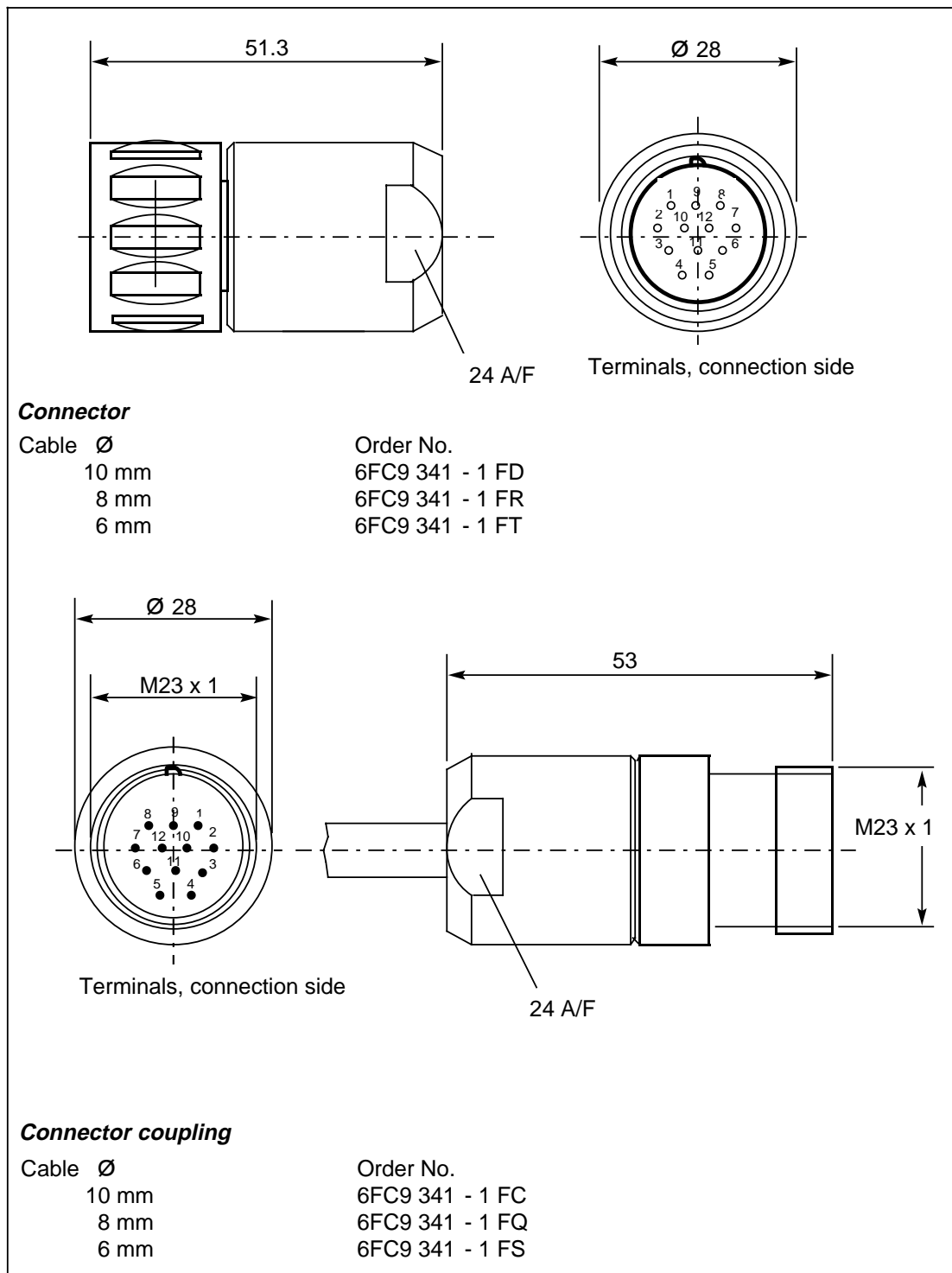

END OF SECTION

7 Terms and Abbreviations

AC	Alternating current
ACOP	Advanced co processor
ASCII	American S tandard C ode for Information Interchange
Baud	Unit of transmission speed: 1 baud = 1 bit/sec
Bit	Binary digit; binary unit of information; yes/no signal; binary place; dimensional unit for information quantity; unit for memory capacity
Bus	Link for transmitting signals, feed voltages, ground potential
Byte	Storage unit generally with 8 bits, can accommodate two decimal digits or one alphanumeric character; smallest addressable unit
CAD	Computer a ided d esign
CL	Computer link
CNC	Computerized n umerical c ontrol; numerical control with one or more integrated microcomputers and suitable operating software to implement several or all NC functions.
COP	C oprocessor
CSB	Central s ervice b oard
CPU	Central p rocessing u nit
DB	Data b lock
DB	Distribution b ox
DC	Direct c urrent
DL	Data byte left
DMP	Distributed m achine p eripherals
DMP station	A DMP station consists of a terminal block and the associated DMP module. The handheld unit and the machine control panels are also regarded as DMP stations. DMP stations are PLC input/output components which are distributed around the machine and which are responsible for data exchange with the PLC via the MPC controller. Up to 8 DMP stations (as from SW 3: 15) can be linked to one MPC line.
DNC	Direct n umerical c ontrol; several NC controls linked to a host computer
DR	Data byte right
DRF	Differential resolver function (handwheel mode)

DW	Data word
EIA	Electronic Industries Association
ELG	Electronic gearbox
EM	Error message
ENABLE	Enable signal or input
EU	Expansion unit
FB	Function block in the PLC
FD	Floppy disk (drive)
FMS	Flexible manufacturing system; group of machines linked by an automatic material handling system; manufacturing and handling are controlled by computer
FY	Flag byte
HD	Hard disk
HMS	High-resolution measuring system
IB	Input byte
IM	Interface module
Increment	Smallest unit of digital representation
Incremental dimension	A dimension measured from the preceding point in a series of points
Incremental system	A control system in which each coordinate or positional dimension is taken from the last position rather than from a common zero point as in an absolute system
ISO	International Organization for Standardization
Jog	Manual mode with feed and rapid traverse as long as a direction key is pressed
LCD	Liquid crystal display
LED	Light emitting diode
MCP	Machine control panel
MD	Machine data
MMC	Man Machine Communication
MPC	Multi-port control; used with the SINUMERIK 840C to interface DMP stations via the MPC line. The MPC has two equal interfaces to which the MPC line and the MPC partial lines are connected.

MPC controller	Control unit on the link module for one MPC line or for two MPC sublins
MPC line	The MPC line consists of the connected DMP stations and can be divided up into two MPC sublins to simplify cabling. The MPC line or sublins is/are connected to one/both MPC connector/s on the link module.
MPC subline	is a part of the MPC line and is connected to one of the two MPC connectors on the MPC controller. The two MPC sublins together make up one MPC line.
NC	N umerical c ontrol
NCK	N umerical c ontrol k ernel
OB	O rganization b lock in the PLC
OM	O perational m essage
OP	O perator p anel
OPI	O perator p anel interface
OS	O perating s ystem
Override	Correction of programmed values by manually operated step switch (e.g. feedrate override, rapid traverse override)
PB	P rogram b lock in the PLC
PCB	P rinted c ircuit b oard
PELV	P rotective e xtra l ow v oltage
PLC	P rogrammable l ogic c ontroller
PP	P art p rogram
PRESET	Setting of values before operation
PS	P ower s upply
PSU	P LC s upport u nit
QB	O utput b yte
RAM	R andom a ccess m emory
Resolver	Electromagnetic position encoder for indirect analog position measurement
RGB	r ed g reen b lue
ROM	R ead- o nly m emory
SBC	S ingle b oard c omputer
SE	S etting d ata

SN	Siemens standard
SPS	S tandard p lug-in s tation = standard slot dimension in a subrack (1 SPS = 15.24 mm)
TB	T erminal b lock
TO	T ool o ffset
UI	U ser i nterface
UMS	U ser m emory s ubmodule

END OF SECTION

A EC Declaration of Conformity

Appendix A to the EC Declaration of Conformity No. 002 V 25/02/99

Notes on CE marking:

- An excerpt from the EC Declaration of Conformity referring to the EC Directive 89/336/EC (EMC Directive) is given in the following. The entire EC Declaration of Conformity can be found in the Manual "EMC Installation Guideline for SINUMERIK SIROTEC SIMODRIVE, order no. 6FC5297-0AD30-0BP0.
- Products which are intended for a supply voltage of more than or equal to 50 V DC resp. 75 V DC comply, in addition to the a.m. EC Directive, also with the EC Directive 73/23/EC (LOW-Voltage Directive).

Safety notes which must possibly be observed during electrical installation of these devices are listed in the Planning Guide or in the Installation and Startup Instructions for these products.

- The conformity with the EC Directive(s) is confirmed through the CE marking of the products.

Siemens AG
A&D MC BMS
P.O. Box 31 80
D-91050 Erlangen
Federal Republic of Germany
Tel. +49 - 180 / 5050 - 222 [Hotline]
Fax +49 - 9131 / 98 - 2176
email: motioncontrol.docu@erf.siemens.de

Suggestions

Corrections

For Publication/Manual:
SINUMERIK 840C
Software Version 1, 2, 3, 4, 5 and 6
Interface Description
Part 2: Connection Conditions
Manufacturer Documentation

From:

Name _____

Company/Dept. _____

Address _____

Telephone / _____

/

Planning Guide

Order No.: 6FC5197-6AA10-0BP3

Edition: 09.2001

Should you come across any printing errors when reading this publication, please notify us on this sheet. Suggestions for improvement are also welcome.

Suggestions and/or corrections

Overview of SINUMERIK 840C Documentation / OEM Version for Windows

