



Deuschmann Automation

Cam Controls | Fieldbus Gateways | Industrial Ethernet Products

Instruction manual



Electronic cam control **LOCON 24, 48, 64, LTC** Display- and operating unit **TERM 24 and TERM 6**

Deuschmann Automation GmbH & Co. KG

Carl-Zeiss-Str. 8 D-65520 Bad Camberg ☎ +49-(0)6434 / 9433-0 📠 +49-(0)6434 / 9433-40
eMail: mail@deuschmann.de Internet: <http://www.deuschmann.com>

Foreword

This operating manual provides users and OEM customers with all the information necessary for the installation and operation of the product described in this manual.

All details contained in this manual have been checked carefully, however, they do not represent an assurance of product characteristics. No liability can be accepted for errors. DEUTSCHMANN AUTOMATION reserves the right to carry out alterations to the described products in order to improve the reliability, function or design thereof. DEUTSCHMANN AUTOMATION only accepts liability to the extent as described in the terms and conditions of sale and delivery.

All rights reserved, including translation. No part of this manual may be reproduced or processed, copied or distributed in any form whatsoever (print, copy, microfilm or any other process) without written permission from DEUTSCHMANN AUTOMATION.

Bad Camberg, October 2013

Version 8.8 dated 29.10.13 Art.-No. V2981E

P/C: A

Copyright by DEUTSCHMANN AUTOMATION, D-65520 Bad Camberg 1994-2013

1	Introduction	11
1.1	On this manual	11
1.1.1	Symbols	11
1.1.2	Concepts	11
1.1.3	Suggestions	11
1.2	From the mechanical system to an electronic system	12
1.3	Deutschmann Automation's range of products	12
2	EMC Directives for products of DEUTSCHMANN AUTOMATION	13
3	Electrical connections LOCON 24, 48, 64	14
3.1	Rear view LOCON 24, 48, 64	14
3.2	Pin assignment LOCON 24, 48, 64	15
3.2.1	Pin assignment X1 (2x24-pin screw terminals)	15
3.2.2	Pin assignment X2 (1x16-pin screw terminals)	15
3.2.3	Pin assignment X2 (1x16-pin screw terminals)	16
3.2.4	Pin assignment X3 (1x6-pin screw terminals)	16
3.2.5	Pin assignment X4 (1x24-pin screw terminals)	16
3.2.6	Pin assignment X5 (1x7-pin screw terminals)	16
3.2.7	Pin assignment X6 (1x3-pin screw terminal)	16
3.2.8	Pin assignment X7	17
3.2.8.1	Pin assignment X7 - Standard version (9-pin D-Sub female connector)	17
3.2.8.2	Pin assignment X7 at the Profibus-version	17
3.2.8.3	Pin assignment X7 at the MPI-version	17
3.3	Signal description LOCON 24, 48, 64	18
3.3.1	Status LEDs	19
3.3.1.1	Front view	19
3.3.1.2	Rear view	19
3.4	External program selection	19
3.4.1	Applying the corresponding voltages	19
3.4.2	Generation of the acceptance edge	20
3.4.3	Graphic representation of program selection	20
3.5	Installation and commissioning of LOCON 24, 48 and 64	20
3.5.1	Connection of the supply voltage	20
3.5.2	Connection of the equipotential bonding system	21
3.5.3	Connection of the inputs and outputs	21
3.5.4	Connection of the serial RS232 interface	22
3.5.4.1	Interface-switch	22
3.5.5	Connection of the DICNET bus interface	22
3.5.6	Connection of the floating fault alarm contact	22
4	Basic unit TERM 24, LOCON 24, 48 and 64	23
4.1	Front view	23
4.1.1	Version IP 54	23
4.1.2	Version IP 65	23

5	Mechanical installation instructions TERM 24, LOCON 24, 48, 64	24
5.1	Version IP 54	24
5.2	Version IP 65	24
5.3	PM-version	24
5.4	Dimensional drawings	25
5.4.1	LOCON 24-IP54	25
5.4.2	LOCON 24-IP65	26
5.4.3	LOCON 24PM	27
5.4.4	TERM 24-IP54	28
5.4.5	TERM 24-IP65	28
6	Electrical connections TERM 24	29
6.1	Pin assignment X1 TERM 24 (5-pin screw-type plug connector)	29
6.2	Installation and commissioning of the TERM 24	29
6.2.1	Connection of the supply voltage	29
6.2.2	Connection of the serial RS232 interface (optional)	29
6.2.3	Connection of the DICNET bus interface	29
7	LOCON 24, 48 and 64 options	30
7.1	Expansion to 32 outputs (LOCON 24 only)	30
7.2	Inputs and logic functions (LOCON 24 and 48 only)	30
7.3	SSI interface	30
7.4	Incremental encoder; incremental counting/direction inputs	30
7.5	Encoder monitoring (option G)	30
7.6	Speed display	31
7.7	Direction-cams	31
7.8	Angle-time cam	32
7.9	Memory expansion	32
7.10	Offline programming	32
7.11	Data backup and documentation on PC	33
7.12	Lockable outputs	33
7.13	Program controller function (encoder simulation)	33
7.14	Analog outputs	33
7.15	Option X37 - encoder monitoring	34
7.16	Option H08 - highspeed-idle time compensation	34
7.17	Option X53 (preset value)	34
7.18	Option X55 (locked outputs)	34
7.19	Option X59 (braking angle display)	35
7.20	Option X81 (24 Bit SSI-encoder)	35
7.21	Special versions	35
8	LOCON LTC (special version)	36
8.1	Mechanics space requirements	36
8.2	Electrical connections	37

8.2.1	Rear view: Terminal allocation	37
8.2.2	Terminal allocation	38
8.2.3	Example for the wiring scheme	39
8.3	Programming of the cams	40
8.4	Function "Apprentissage"	41
8.4.1	Presentation	41
8.4.2	Starting the function "Apprentissage"	41
8.5	Control	42
8.5.1	Control possibilities	42
8.5.2	Control type 1	43
8.5.3	Control type 2	43
8.5.4	Correspondence table	44
8.5.5	Description of the control error	44
9	Networking terminals with cam controls and PCs	47
9.1	RS232 link	47
9.2	RS485 link (DICNET)	47
9.3	Cable type for DICNET®	47
9.3.1	Earthing, shielding	48
9.3.2	Line termination at DICNET®	48
9.4	Comparison DICNET® - RS232	48
9.5	Connection examples	49
9.5.1	DICNET link LOCON-TERM	49
9.5.2	RS232 link LOCON - TERM	50
9.5.3	DICNET link LOCON-TERM-PC	51
10	LOCON 24 with Profibus and MPI	52
11	Commissioning and self-test	53
11.1	Commissioning of the terminal	53
11.1.1	Self-test of the terminal	53
11.2	Commissioning of the cam control	53
11.2.1	Self-test of the cam control	54
12	Brief Instructions TERM 24 / LOCON 24, 48, 64	55
13	Operation LOCON 24, 48, 64	57
13.1	Main menu LOCON 24, 48, 64	57
13.1.1	Programming enable (dongle)	57
13.1.2	Function, program controller	57
13.2	Configuration and initialisation	57
13.2.1	LOCON 24, 48 and 64 parameter table	58
13.3	LOCON 24 MT	58
13.3.1	Parameter description	59
13.3.1.1	Reversal, encoder	59
13.3.1.2	Encoder type.	59

13.3.1.3	Encoder resolution	59
13.3.1.4	Counting range (only in the case of incremental encoders)	59
13.3.1.5	Type of idle time compensation	59
13.3.1.6	DICNET-device number (GNR)	60
13.3.1.7	Menu Select language	60
13.3.1.8	Zero-point offset (only in the case of absolute shaft encoder)	60
13.3.1.9	Presetvalue (only for Inc).	61
13.3.1.10	Scaling for speed display	61
13.3.1.11	Fictitious encoder value (gear factor).	61
14	Operation via TERM 24	62
14.1	Fundamentals on TERM 24 and LOCON 24, 48 and 64	62
14.2	Main menu TERM 24	62
14.2.1	Changing the active program with the keyboard	63
14.2.2	Axis selection	63
14.2.3	General reset	63
14.2.4	Query software-version	64
14.3	Programming via TERM 24	64
14.3.1	Key definition	65
14.3.2	Select program	65
14.3.3	Copy program	65
14.3.4	Delete program	66
14.3.5	Select output	66
14.3.6	Copy output	66
14.3.7	Delete output	67
14.3.8	Program-dependent idle times	67
14.3.9	Change idle time compensation	67
14.3.10	Programming switch-on/switch-off points (cams)	68
14.3.11	Adding, deleting or changing switch-on/switch-off points (cams)	69
14.3.12	Programming the direction-dependent output change	69
14.3.13	Entering angle-time-cam	70
14.3.14	Entering positions for the option analog outputs	70
14.3.15	Shift cam track	72
14.4	Initialisation	72
14.4.1	Analog upper range value (only at LOCON 32)	72
14.4.2	Counting range	73
14.4.3	Zero-point offset	73
14.4.4	Reversal	73
14.4.5	National language	73
14.4.6	Speed scaling	74
14.4.7	Fictitious encoder value (Gear factor)	74
14.5	Configuration	74
14.5.1	Encoder resolution	75
14.5.2	Type of idle time compensation	75
14.5.3	DICNET No.	75

14.5.4	Defining the encoder type	76
14.6	Logic functions	76
14.6.1	Logic functions and explanation of the used symbols	78
14.6.2	Priorities of the logic operations	78
14.6.3	Operation mode of the shift register	79
14.6.3.1	Example for the use of a shift register	79
14.6.4	Trigger conditions	79
14.6.5	Example 1	79
14.6.6	Graphical illustration of example 1	80
14.6.7	Example 2	80
14.6.8	Cycle time of the units with logic function	80
14.7	Locked outputs	81
14.8	Function Speed limit value	81
15	Basic device TERM 6 (external operating unit)	82
15.1	Assembly of the instrument	82
15.2	View TERM 6	82
15.3	Technical dimensional drawings	83
15.3.1	TERM 6	83
15.3.2	TERM 6-H	84
15.3.3	TERM 6-T	85
15.4	Pin assignment TERM 6	86
15.4.1	Interface switch-over	86
15.5	Programming of several devices with TERM 6	86
15.5.1	Selecting the device number on TERM 6	86
15.6	Display of the executed program via TERM 6	87
15.7	Reading and changing cam control parameters	87
15.8	Programming angle-time-cams via TERM 6	87
16	Technical details	88
16.1	Technical data TERM 24	88
16.2	Technical data LOCON 24	89
16.3	Technical data LOCON 48	90
16.4	Technical data LOCON 64	91
16.5	LOCON 24, LOCON 48 and LOCON 64 memory expansion	92
16.6	Specification of the input levels	92
16.7	Specification of the output drivers	92
16.8	Switching accuracy of the Deutschmann cam controls	92
16.8.1	Timing diagram	94
16.9	Function of the idle-time compensation	94
16.9.1	Path-dependent idle-time compensation	95
16.9.2	Time-controlled idle-time compensation	95
16.9.3	Direct time-controlled idle-time compensation	95
16.9.4	Optimization of dynamics	95

16.10	Environmental specifications of cam controls of the LOCON series	95
16.11	DICNET®	95
16.12	Communication interface	96
16.13	Coding device numbers	97
17	Error messages	98
17.1	Error number 1..19 (irrecoverable error)	98
17.2	Error number 20..99 (warning)	98
17.3	Error number 100..199 (serious error)	100
17.4	Error number 200-299 (terminal error)	101
18	Order Code	102
18.1	TERM 24 terminal	102
18.2	LOCON 24, 48 and 64 cam controls	102
18.2.1	Explanation of the order designation	102
18.3	Order designation examples	103
18.4	Standard accessory	103
18.4.1	Standard accessory of LOCON 24, 48, 64 and TERM 24	103
19	Servicing	104
19.1	Returning a unit	104
19.2	Internet	104
20	Appendix	105
20.1	Description and connection of the DICNET®-Adapter	105
20.1.1	DICNET®-Adapter DICADAP 3	105

1 Introduction

1.1 On this manual

This manual documents installation, functions and operation of the Deutschmann unit specified on the cover sheet and in the header.

1.1.1 Symbols



Particularly important text sections can be seen from the adjacent pictogram.

You should always follow this information since, otherwise, this could result in malfunctions or operating errors.

1.1.2 Concepts

The expressions 'LOCON', 'ROTARNOCK' and TERM are frequently used throughout this Manual with no further model specifications. In such cases, the information applies to the entire model series.

1.1.3 Suggestions

We are always pleased to receive suggestions and wishes etc. and endeavour to allow for these. It is also helpful if you bring our attention to any errors.

1.2 From the mechanical system to an electronic system

The purpose of electronic cam controls is not only to take the place of mechanical controllers but to render their function more precise and simpler, to provide a universal range of application and to reduce wear.

The mechanical cam control actuates a switch over sections of a circle, and this switch is closed over the length of this section. Such a section is defined as a "cam".

Each switch represents one output. Several circuits arranged in parallel produce the number of outputs.

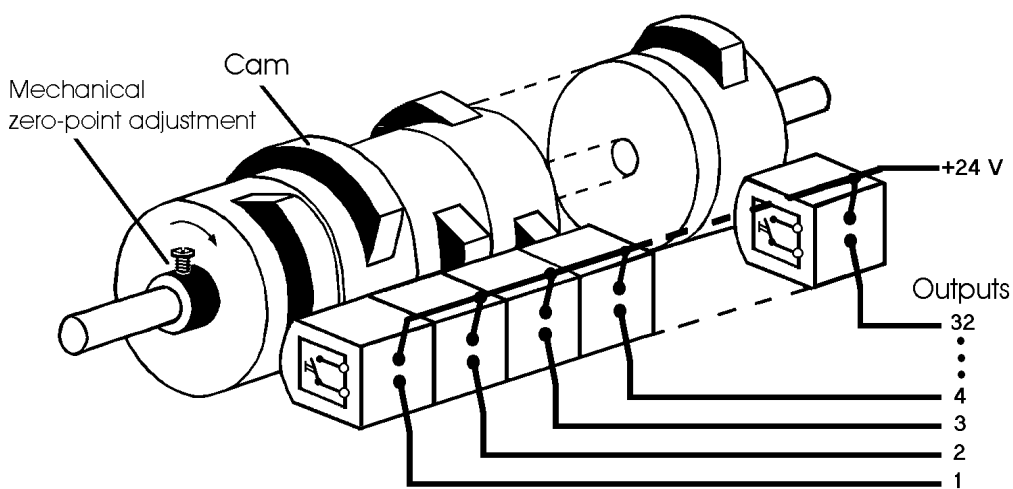

Picture 1: Mechanical cam control

This basic principle has been adopted from the mechanical cam controls. A cam is programmed for an output by entering a switch-on point and a switch-off point. The output is switched on between these points.

Thanks to twenty years of experience, consistent further development and the use of ultra-modern technology, DEUTSCHMANN AUTOMATION has now become one of the leading suppliers of electronic cam controls.

1.3 Deutschmann Automation's range of products

A detailed and up-to-date overview of our product range can be found on our homepage at <http://www.deutschmann.de>.

2 EMC Directives for products of DEUTSCHMANN AUTOMATION

The installation of our products has to be carried out considering the relevant EMC directives as well as our internal instructions.

For more information see 'EMC Directives' on our homepage at <http://www.deutschmann.com>.

3 Electrical connections LOCON 24, 48, 64

3.1 Rear view LOCON 24, 48, 64

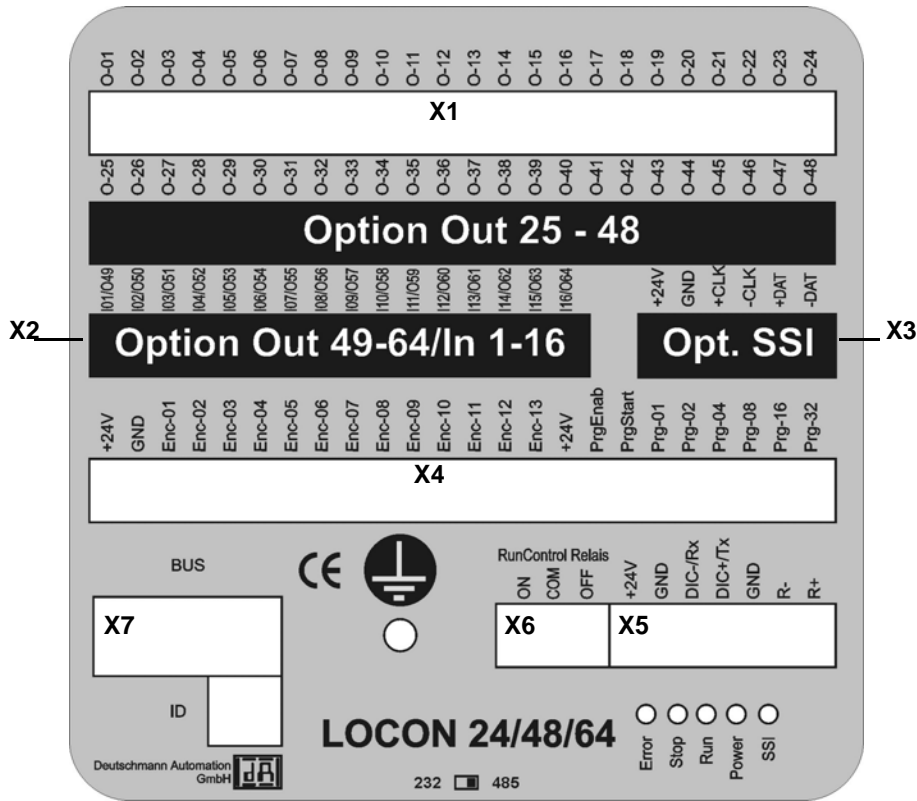

Picture 2: Rear view LOCON 24, 48 and 64 (only for devices from art.-no. V2237 on)



Devices with an article-no. lower than V2237 have a different pin assignment. Therefore please order the instruction manual with the article-no. V1249, version V 4.00 or make a download from our download-area on our homepage at www.deutschmann.de.

3.2 Pin assignment LOCON 24, 48, 64

3.2.1 Pin assignment X1 (2x24-pin screw terminals)

Pin-No.	Significance
1	Output 1
2	Output 2
3	Output 3
4	Output 4
5	Output 5
6	Output 6
7	Output 7
8	Output 8
9	Output 9
10	Output 10
11	Output 11
12	Output 12
13	Output 13
14	Output 14
15	Output 15
16	Output 16
17	Output 17
18	Output 18
19	Output 19
20	Output 20
21	Output 21
22	Output 22
23	Output 23
24	Output 24

Pin-No.	Significance	Option analog output
25	Output 25	Output 25
26	Output 26	Output 26
27	Output 27	Output 27
28	Output 28	Output 28
29	Output 29	Output 29
30	Output 30	Output 30
31	Output 31	Output 31
32	Output 32	Output 32
33	Output 33	Output 33
34	Output 34	Output 34
35	Output 35	Output 35
36	Output 36	Output 36
37	Output 37	Output 37
38	Output 38	Output 38
39	Output 39	Output 39
40	Output 40	Output 40
41	Output 41	I out 1
42	Output 42	AGND
43	Output 43	Vout 1
44	Output 44	AGND
45	Output 45	Iout 2
46	Output 46	AGND
47	Output 47	Vout 2
48	Output 48	AGND

3.2.2 Pin assignment X2 (1x16-pin screw terminals)

LOCON 64 only

Pin-No.	Significance
49	Output 49
50	Output 50
51	Output 51
52	Output 52
53	Output 53
54	Output 54
55	Output 55
56	Output 56

Pin-No.	Significance
57	Output 57
58	Output 58
59	Output 59
60	Output 60
61	Output 61
62	Output 62
63	Output 63
64	Output 64



Please note the differing pin assignment on units with binary-coded speed display option. This different assignment can be found in chapter Options: Speed display.

3.2.3 Pin assignment X2 (1x16-pin screw terminals)

LOCON 24 and 48 with the option E16 only

Pin-No.	Significance	Pin-No.	Significance
1	Input 1	9	Input 9
2	Input 2	10	Input 10
3	Input 3	11	Input 11
4	Input 4	12	Input 12
5	Input 5	13	Input 13
6	Input 6	14	Input 14
7	Input 7	15	Input 15
8	Input 8	16	Input 16

3.2.4 Pin assignment X3 (1x6-pin screw terminals)

Pin-No.	Significance for SSI-encoders	RS422 incremental
1	+24V - Encoder (Output)	+24V - Encoder (Output)
2	GND-Encoder	GND-Encoder
3	SSI CLK+	B+
4	SSI CLK-	B-
5	SSI DAT+	A+
6	SSI DAT-	A-

3.2.5 Pin assignment X4 (1x24-pin screw terminals)

Pin-No.	Significance for absolute shaft encoders	Significance for incremental encoders	Pin-No.	Significance for absolute shaft encoders
1	+24V - Encoder (Output)		13	Encodertrack 11
2	GND - Encoder		14	Encodertrack 12
3	Encodertrack 1		15	Encodertrack 13
4	Encodertrack 2	Preset Active +	16	+24V - Output
5	Encodertrack 3	LatchClr+	17	ProgEnable
6	Encodertrack 4	SelectCount+	18	ProgStart
7	Encodertrack 5	Clear+	19	PrgNr 1
8	Encodertrack 6	OutEnable+	20	PrgNr 2
9	Encodertrack 7	CountEnable-	21	PrgNr 4
10	Encodertrack 8	Clear-	22	PrgNr 8
11	Encodertrack 9	Track A/Count↑	23	PrgNr 16
12	Encodertrack 10	Track B/Down+	24	PrgNr 32

3.2.6 Pin assignment X5 (1x7-pin screw terminals)

Pin-No.	Device with RS485	Device with RS232
1	+ 24V - Supply	+ 24V - Supply
2	GND	GND
3	DICNET -	Rx-LOCON
4	DICNET +	Tx-LOCON
5	GND	GND
6	R-	R-
7	R+	R+

3.2.7 Pin assignment X6 (1x3-pin screw terminal)

Pin-No.	Significance
1	Run-On
2	Run-Common
3	Run-Off

3.2.8 Pin assignment X7

3.2.8.1 Pin assignment X7 - Standard version (9-pin D-Sub female connector)

Pin-No.	232	485
1	nc	nc
2	Rx-LOCON	DICNET-
3	Tx-LOCON	DICNET+
4	nc	nc
5	ØV-OUT	ØV-OUT
6	nc	R-
7	nc	R +
8	nc	nc
9	24 V- OUT (max. 300 mA)	24 V-OUT (max. 300 mA)

3.2.8.2 Pin assignment X7 at the Profibus-version

Pin-No.	Name	Function
1	not connected	
2	not connected	
3	B	not-inverted input-/output-signal from PROFIBUS
4	not connected	nc
5	M5	DGND-data reference potential
6	P5	5V supply voltage
7	not connected	
8	A	inverting input-/output-signal from PROFIBUS
9	not connected	

3.2.8.3 Pin assignment X7 at the MPI-version

Pin-No.	Name	Function
1	not connected	
2	not connected	
3	B	not-inverted input-/output-signal from MPI-bus
4	not connected	nc
5	M5	DGND-data reference potential
6	P5	5V supply voltage
7	not connected	
8	A	inverting input-/output-signal from MPI-bus
9	not connected	



The use of an integrated Gateway-technology may result in a signal-delay on the fieldbuses of up to 10 ms.



Please note the signal description on the following pages!

3.3 Signal description LOCON 24, 48, 64

Function	Significance
Output 1 ... Output 8	Output block 1 Each output 24 V / 0.3 A positive-switching (PNP), short-circuit-proof Total current of output block max. 1 A
Output 9 ... Output 16	Output block 2 Each output 24 V / 0.3 A positive-switching (PNP), short-circuit-proof Total current of output block max. 1 A
Output 17 ... Output 24	Output block 3 Each output 24 V / 0.3 A positive-switching (PNP), short-circuit-proof Total current of output block max. 1 A
Output 25 ... Output 32	Output block 4 Each output 24 V / 0.3 A positive-switching (PNP), short-circuit-proof Total current of output block max. 1 A
Output 33 ... Output 40	Output block 5 Each output 24 V / 0.3 A positive-switching (PNP), short-circuit-proof Total current of output block max. 1 A
Output 41 ... Output 48:	Output block 6 Each output 24 V / 0.3 A positive-switching (PNP), short-circuit-proof Total current of output block max. 1 A
Output 49 ... Output 56:	Output block 7 Each output 24 V / 0.3 A positive-switching (PNP), short-circuit-proof Total current of output block max. 1 A
Output 57 ... Output 64:	Output block 8 Each output 24 V / 0.3 A positive-switching (PNP), short-circuit-proof Total current of output block max. 1 A
+24V - Output	24 V output for Prog-Enable and external program selection
+24V - Supply	24 V power supply for overall units, including output drivers
+24V - Encoder	24 V output voltage for encoder (max. 300 mA)
GND	Ground potential of the overall cam control. All GND signals are interconnected internally. There is no connection to chassis which must be connected to the equipotential bonding system.
TxD-LOCON	RS232 transmit line
RxD-LOCON	RS232 receive line
SSI CLK+, SSI CLK-	RS422 clock line pair for SSI interface
SSI DAT+, SSI DAT-	RS422 data line pair for SSI interface
RunOn, RunCommon, RunOff (only LOCON 24, 48, 64)	Floating fault alarm changeover contact. Max. contact load of the Run-Control relay: 100 V DC/V AC, 1 A Connection Common - On: Unit OK Connection Common - Off: Fault
DICNET+, DICNET-	Data line for networking via the DEUTSCHMANN bus system DICNET® (see also chapter DICNET).
R+, R-	Termination resistor terminals for DICNET. Required if LOCON 32 is operated as the first or last device in the DICNET (see chapter DICNET)
Encodertrack 1 - Encodertrack 13	24 V input (max. 10 mA) for encoder leads if using absolute shaft encoders up to 8,192 information items/rev. with parallel output
IncTrackA	Connection of track A if using an incremental encoder 24 V
IncTrackB	Connection of track B if using an incremental encoder 24 V
LatchClr	If this input is wired to 24 V, the Clear pulses (see below) are latched, i.e. a pulse with a minimum length of 40 µs is interpreted as Clear. This Latch function should be used only in the case of really short Clear signals since the Clear input in this case also responds more sensitively to interference signals. If the input is not wired or is wired to 0 V, a minimum Clear length of 1 ms is required.
SelectCount+, Count [^] , Down+	If 24 V is applied to this input, inputs "Encodertrack9" and "Encodertrack10" are evaluated as counting and direction input. A pulse is incremented with each rising edge at "Count". If input "Down+" has 24 V, downcounting is carried out. Otherwise, upcounting is carried out. If "SelectCount+" is not wired or is wired to 0 V, an incremental encoder with A/B tracks is expected.

Clear-, Clear+	Clear pulse. As soon as one of the two signals is activated (0 V in the case of Clear-, 24 V in the case of Clear+), the count is set to 0 and is maintained at 0 until the Clear condition disappears again. The pulse width is dependent on wiring of input "LatchClr" (see above).
CountEnable-	This signal enables the counter in the case of 0 V or if unwired. If 24 V is applied to this line, the count is frozen. The speed measurement and, thus, the TZK continue to run during this time. This signal is evaluated with an accuracy of ± 0.5 ms.
OutEnable+	This signal can be used to connect and disconnect the outputs if incremental encoders are used. In the case of 0 V or unwired, the outputs are deactivated. In the case of 24 V, the outputs are set in accordance with the programmed cams. The response to a signal change occurs with an accuracy of ± 0.5 ms.
Prog.No. 1 ... Prog.No. 32	The program number is applied to these pins in the case of an external program selection. Coding is in binary form in accordance with chapter "Coding device and program number".
ProgStart	If 24 V is applied to this pin, the program number at pins Prog.No.1 to Prog.No.64 (see above) is accepted.
ProgEnable	If 24 V is applied to this pin, all parameter changes (including configuration change) are allowed in LOCON. Please refer to chapter "Programming enable" for further details.
Input 1-16	Logic inputs Each input 24 V (max. 10 mA). Please refer to chapter "Logic inputs" for further details
nc	Not connected
I out	Analog output (power)
V out	Analog output (voltage)
AGND	Reference for analog outputs (Iout + Vout)

3.3.1 Status LEDs

3.3.1.1 Front view

48 LEDs indicating the output status (LED on = 24 V at output) are arranged beneath the seven-segment display. The status of outputs 49 to 64 on LOCON 64 is not displayed.

3.3.1.2 Rear view

LED	Significance
Error	Error (see chapter „Error messages“)
Stop	Run-Control off
Run	DICNET selected
Power	Internal voltage ok
SST	SSI-connection ok

3.4 External program selection

For external program selection, the new program must be applied in the form of binary code (see chapter "Coding device and program numbers") at the connector strip and **then** a leading edge must be generated at pin "ProgStart", whereby the High level (24 V) must be held for at least 200 ms.

The following steps are required if, for example, program 7 (binary 000111) is to be activated:

3.4.1 Applying the corresponding voltages

Pin	Volt	Binäre
PROG_NR32	0V	0
PROG_NR16	0V	0
PROG_NR8	0V	0
PROG_NR4	24V	1

PROG_NR2	24V	1
PROG_NR1	24V	1

3.4.2 Generation of the acceptance edge

Pin	Volt
PROG_START = 24V	24V
Wait 200ms	
PROG_START = 0V	0V

3.4.3 Graphic representation of program selection

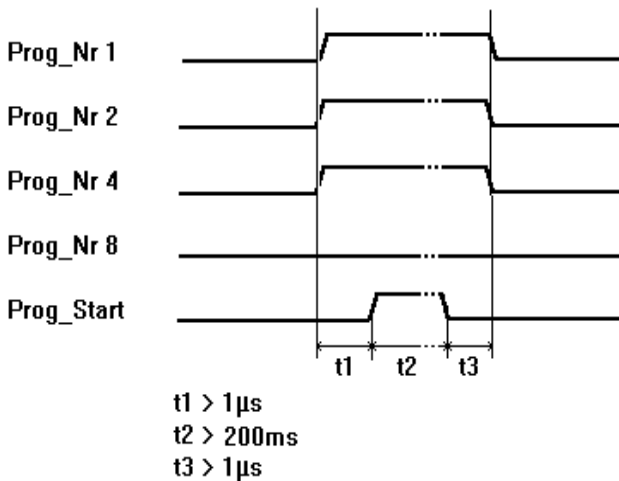

Picture 3: Program selection

The program can be changed at any time using the connector strip.



If pin "PROG_START" is permanently wired to 24 V, LOCON accepts the program applied externally each time the unit is powered up.

3.5 Installation and commissioning of LOCON 24, 48 and 64



The screw-type plug connectors of the LOCON may be unplugged and plugged in only with the power supply disconnected!!!

3.5.1 Connection of the supply voltage

The supply voltage is 24V DC (+/- 20%) and is applied to pins "+24V". The reference ground is wired to "GND". The LOCON requires maximum 200 mA when not under load and not including encoder power supply.

The corresponding inputs and outputs must be wired before switching on the supply voltage in order to avoid malfunctions.

The outputs and the encoder are also powered via this connection so that max. 9 A is required at full capacity (LOCON 64).

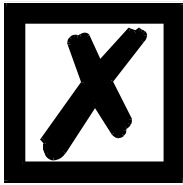

The typical voltage at the outputs and for the encoder supply is:
Supply voltage -1V; that means: is the device being supplied with 24V DC, then the typical output- and encoder voltage is 23V DC!

3.5.2 Connection of the equipotential bonding system

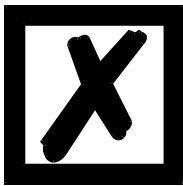

The housing must be connected to the equipotential bonding system of the overall system via the plug provided for this. The housing is not connected internally to "GND".
Equipotential bonding is important in order to reliably discharge interference affecting supply conductors.

3.5.3 Connection of the inputs and outputs

LOCON features up to 64 outputs and 52 inputs for 24 V on the card, depending on version and capacity stage.

Absolute or incremental encoders are used as the machine's sensors. These encoders are connected at pins "Encodertrack1" to "Encodertrack13" on encoders with parallel outputs, "SSICLK" and "SSIDAT" on SSI encoders or "Inc_Track_A" and "Inc_Track_B" on incremental encoders. The encoders' power supply is provided via pins "+24 V encoder" and "GND". 24 V must be applied to pin "ProgEnable" for programming enable (for example, via a key-operated switch).

Pins "Prog.No.1" to "Prog.No.32" and "ProgStart" must be wired only if external program switchover is to occur (for example, via a PLC).

The outputs and the encoder are powered jointly with the **24 V power supply of the total unit**. The outputs of LOCON 24 are positive-switching 24 V, i.e. an active output has a level equal to the supply voltage less 1 V by comparison with GND. An output which has been reset has high impedance.

The outputs are short-circuit-proof and may drive maximum 300 mA, whereby 8 interrelated outputs (output block, see chapter "Signal description") of a driver may be loaded with maximum 1 A.

If more than 300 mA is required per output, it is possible to interconnect several outputs (up to 3 outputs per driver) in which case the drive rating is up to 900 mA.

If several outputs are interconnected, the switch-on points and switch-off points in the LOCON must be programmed absolutely identically since, otherwise, the short-circuit monitor would respond.

In the event of a sustained short circuit or overload, the corresponding outputs are deactivated and a corresponding error message is shown on the display.



Free-wheeling diodes must be provided directly on the inductors if switching inductors (coils and valves) (see chapter 'EMC Directives').

3.5.4 Connection of the serial RS232 interface

The RS232 interface is connected via the connectors X5 or X7.

When connecting, please ensure that the TxD and RxD signals of LOCON and the connected unit are reversed (e.g.: Connect TxD LOCON to RxD PC) and that the "GND" reference potentials of both units are connected.

3.5.4.1 Interface-switch

The interface-switch is located under the sticker with the print RS232/RS485. In the state of delivery the position of the switch is indicated by the mark on the sticker. The position of the requested interface can be seen from the sticker at the back of the device.

For switching please use a suitable tool and carefully shift the microswitch to the left or the right. Attach a new sticker with the corresponding mark.

3.5.5 Connection of the DICNET bus interface

The DICNET bus (see chapter "DICNET") is connected via the connectors X or X7.

All "DICNET+" signals are interconnected and all "DICNET-" signals are interconnected on the bus. The signals are not reversed.

However, it must be ensured that the potential differences between the DICNET users do not exceed 7 V.



Please always follow the information in chapter DICNET!

3.5.6 Connection of the floating fault alarm contact

Signals "RunOn", "RunOff" and "RunCommon" are the three changeover contacts of a relay, whereby "RunCommon" is the common connection, "RunOn" is the make contact and "RunOff" is the break contact.

If LOCON is operating correctly, the make contact "RunOn" is connected to "RunCommon". In the event of a serious error (errors 1..19, 31, 100..199), the relay drops out and there is no connection between "RunOff" and "RunCommon".

Thus, using a relay provides a floating contact for monitoring the LOCON which may thus also be connected in series with other units.



After power-up, the optional relay remains in "RunOff" state until the LOCON has completed its self-test and is ready for operation.

4 Basic unit TERM 24, LOCON 24, 48 and 64

4.1 Front view

The units TERM 24, LOCON 24, 48, 64 are available in the versions shown in the following illustrations:

- A) Enclosure IP 54 with overall dimensions 144 x 144 (W x H)
- B) Enclosure IP 65 with overall dimensions 168 x 168 (W x H)

4.1.1 Version IP 54

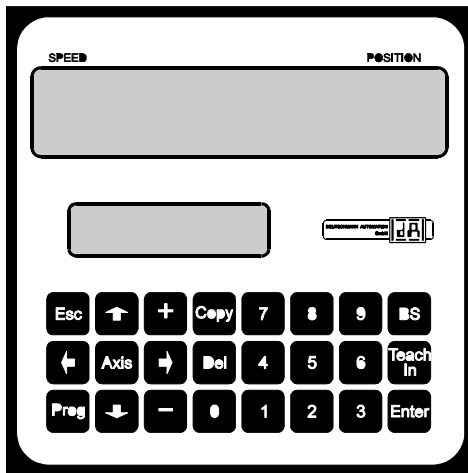

Picture 4: Front panel IP 54

4.1.2 Version IP 65

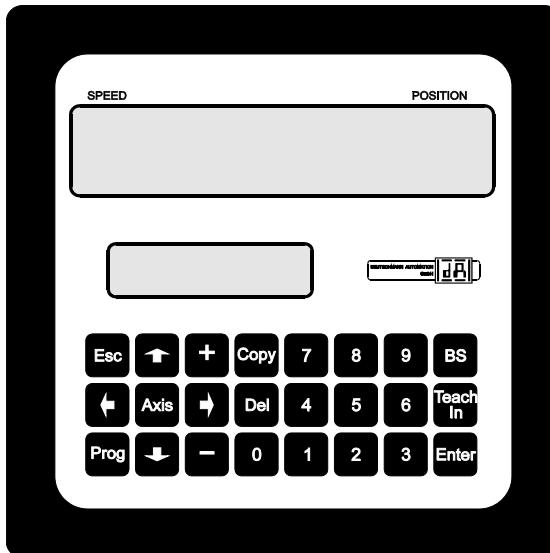

Picture 5: Front panel IP 65

5 Mechanical installation instructions TERM 24, LOCON 24, 48, 64

5.1 Version IP 54

The LOCON / TERM 24 is fitted in a cut-out $138^{+1} \times 138^{+1}$ mm in accordance with DIN for front panel installation. The earthing terminal on the rear side of the housing must be connected to the equipotential bonding system in the control cubicle. **All cable connections have to be made with the power supply disconnected!** The cable shields of the displacement measuring system and the power supply and outputs must be connected to the earthing terminal. The unit must be fitted with the four supplied mounting brackets.



The unit may be operated only with earthing conductor (equipotential bonding) connected.

5.2 Version IP 65

The LOCON / TERM 24 is fitted in a cut-out $138^{+1} \times 138^{+1}$ mm in accordance with DIN for front panel installation. Holes must be drilled in accordance with the drilling template (see download area on our homepage at <http://www.deutschmann.de>) for the bolts. The earthing terminal on the rear side of the housing must be connected to the equipotential bonding system in the control cubicle. **All cable connections must be made with the power supply disconnected!** The cable shields of the displacement measuring system and the power supply and outputs must be connected to the earthing terminals.

5.3 PM-version

The PM-version is to be installed on a mounting plate. A drilling template can be found at the download area on our homepage at <http://www.deutschmann.de>. The earthing terminal on the rear side of the housing must be connected to the equipotential bonding system in the control cubicle. **All cable connections must be made with the power supply disconnected!** The cable shields of the displacement measuring system and the power supply and outputs must be connected to the earthing terminals.



The unit may not be fitted subject to mechanical stressing. This may lead to damage to the electronic circuitry.

The unit may be operated only with earthing conductor (equipotential bonding) connected.

5.4 Dimensional drawings

5.4.1 LOCON 24-IP54

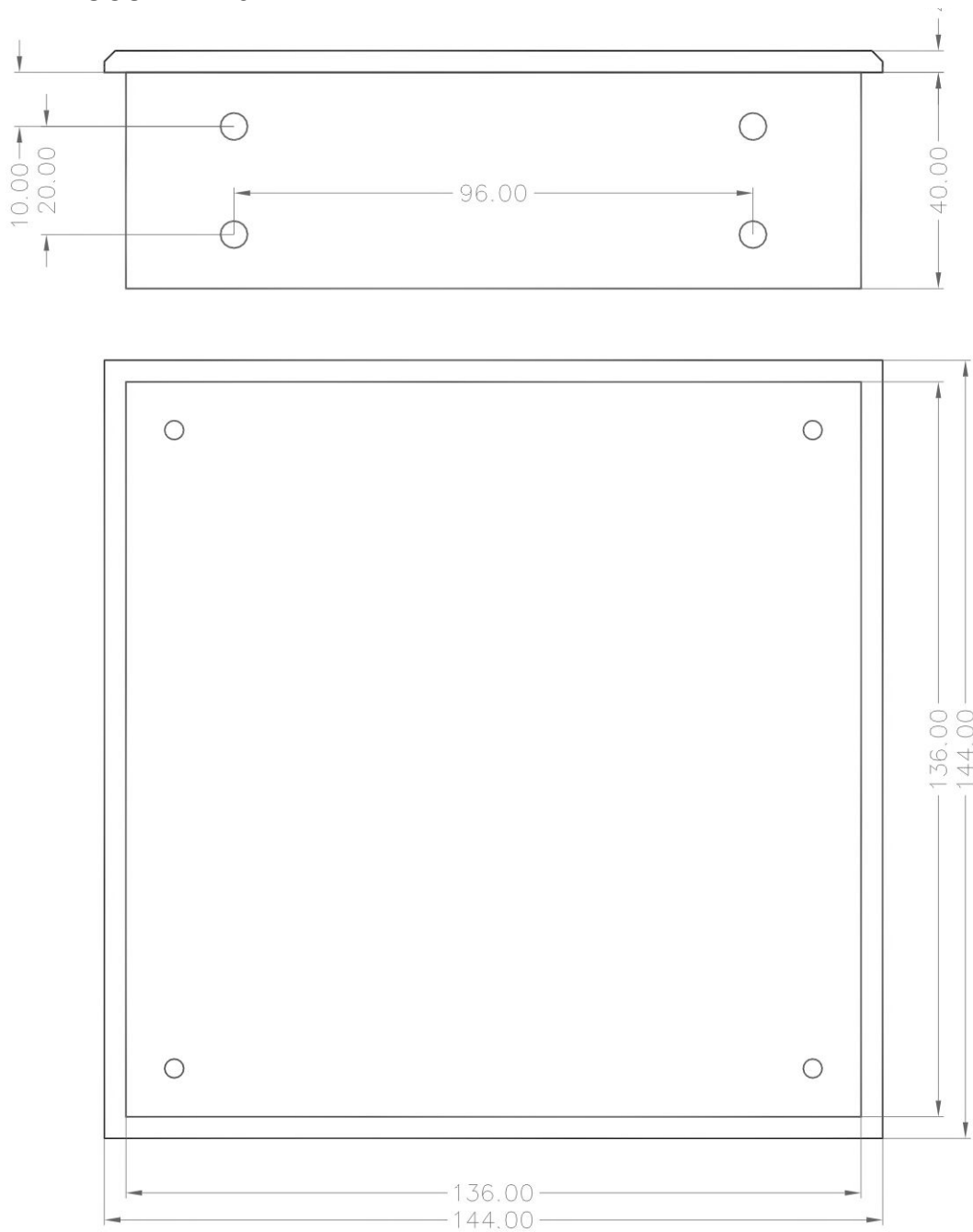

5.4.2 LOCON 24-IP65

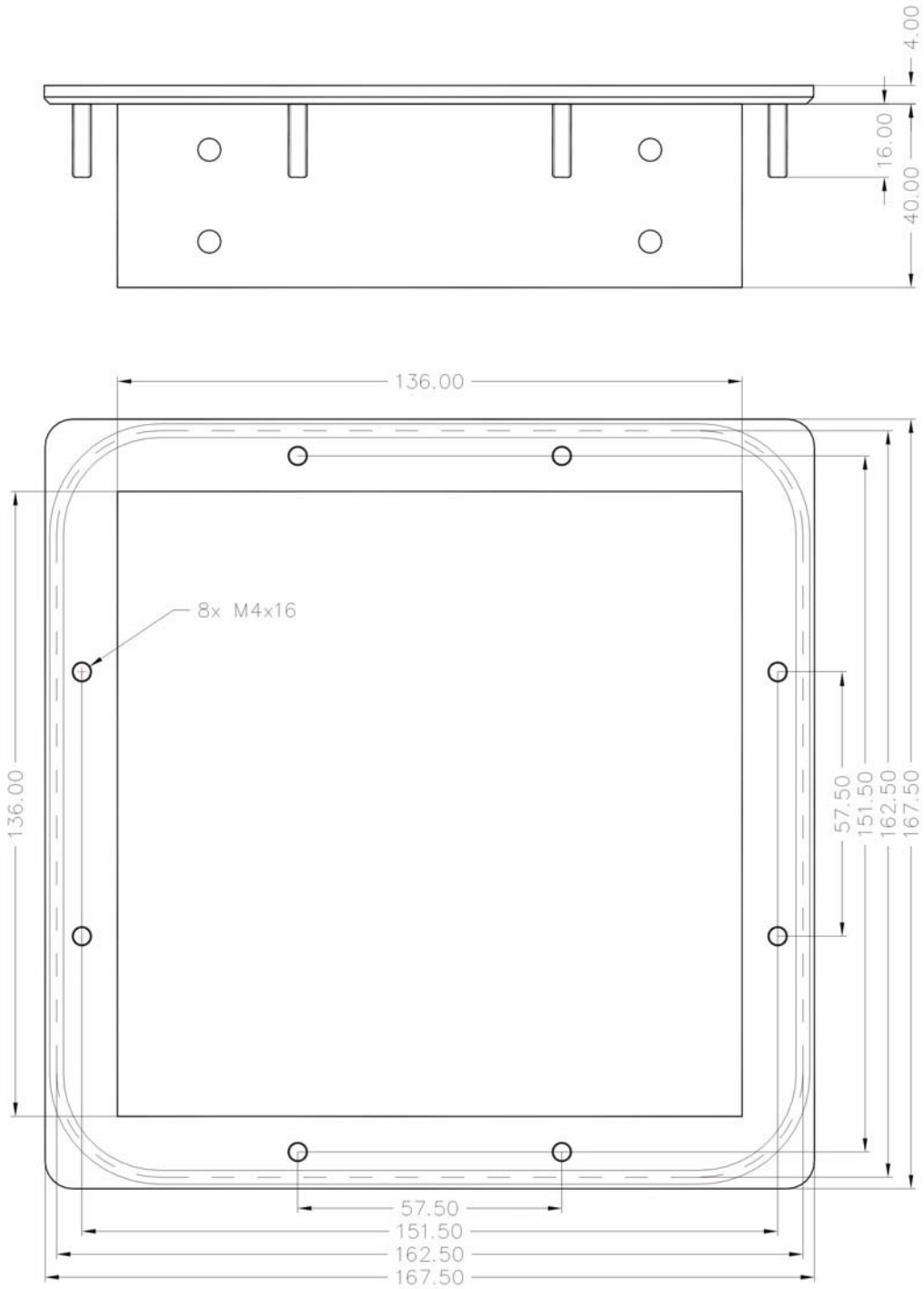

5.4.3 LOCON 24PM

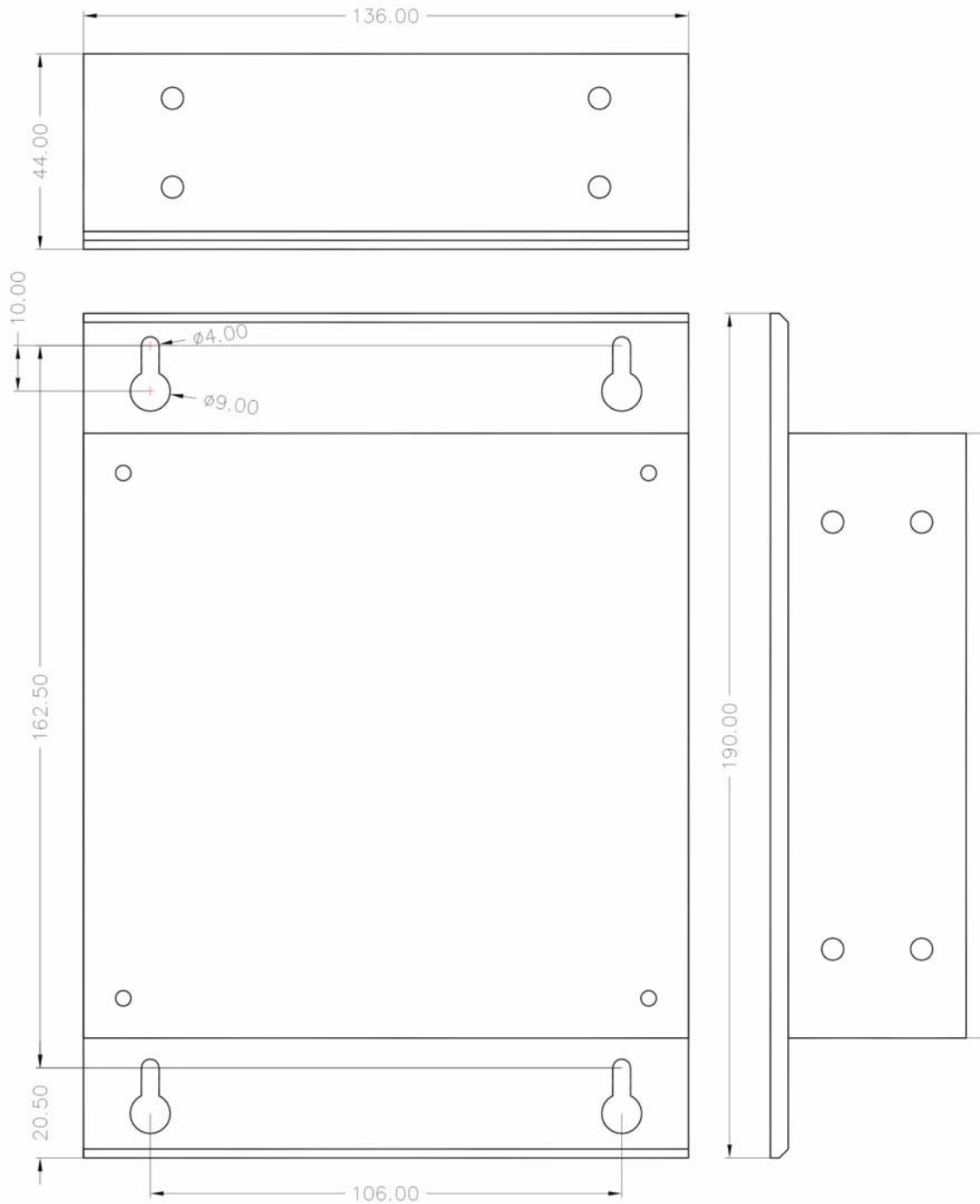

5.4.4 TERM 24-IP54

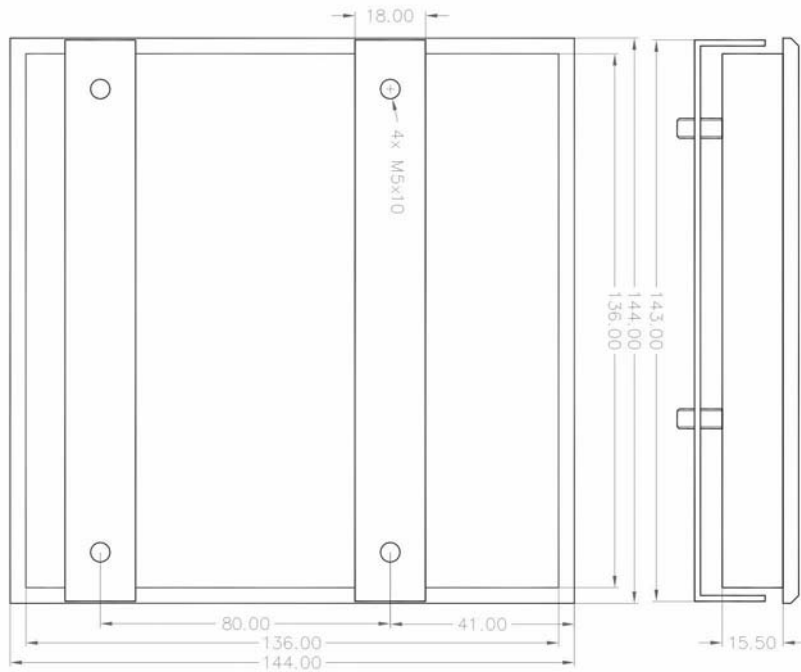

5.4.5 TERM 24-IP65

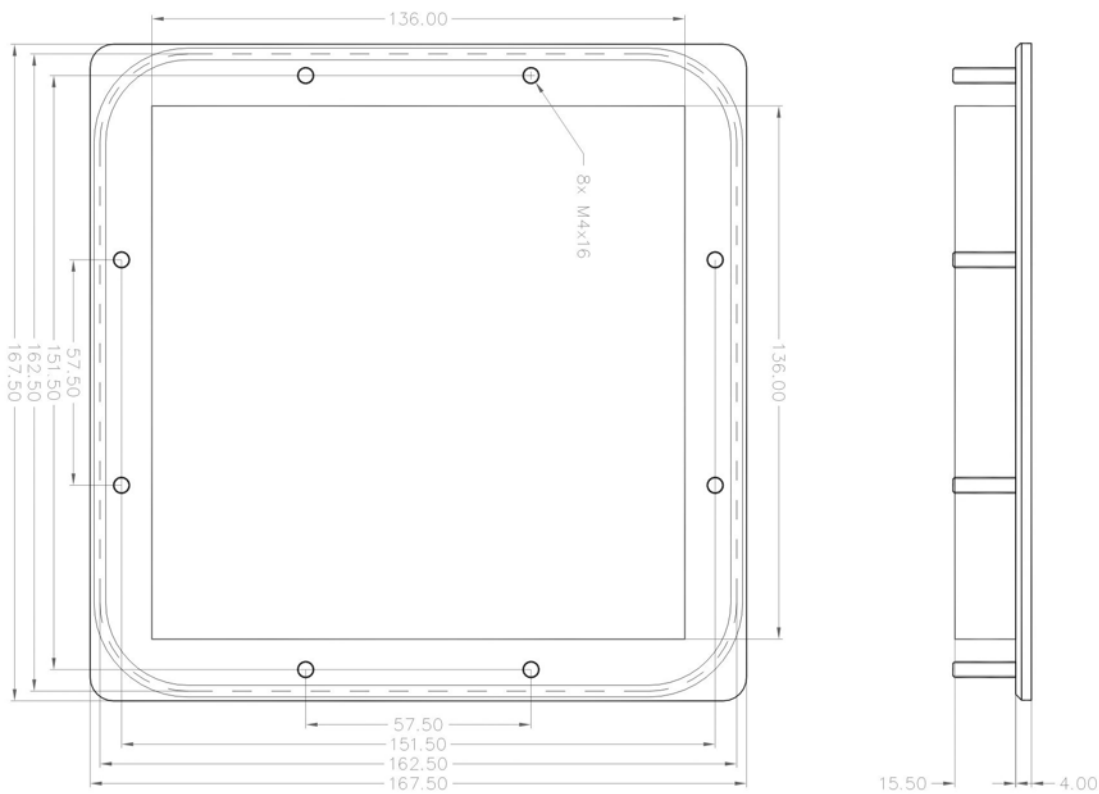

6 Electrical connections TERM 24

6.1 Pin assignment X1 TERM 24 (5-pin screw-type plug connector)

Pin No.	Units with RS485	Units with RS232
1	10-30 Volt DC	10 - 30 Volt DC
2	GND	GND
3	DICNET -	Rx-TERM 24
4	DICNET +	Tx-TERM 24
5	RS-GND	RS-GND

6.2 Installation and commissioning of the TERM 24

6.2.1 Connection of the supply voltage

The supply voltage is 10...30 V DC (typically 24 V DC), applied to pins "10 - 30 V DC". Reference ground is wired to "GND". The TERM 24 requires maximum 250 mA.

6.2.2 Connection of the serial RS232 interface (optional)

The RS232 interface is connected via the screw-type plug connector at plug X3. When connecting, please ensure that the TxD and RxD signals of the TERM 24 and of the connected unit are reversed (e. g.: connect TxD LOCON to RxD TERM 24) and that the "RS-GND" reference potentials of both units are connected.

6.2.3 Connection of the DICNET bus interface

The DICNET bus (see chapter "DICNET") is connected via the screw-type plug connector X3 and the user number is set on the rear DIP switch ("0".."F").

All "DICNET+" signals are interconnected and all "DICNET-" signals are interconnected on the bus. The signals are not reversed.

The "RS-GND" reference potentials do not necessarily have to be interconnected, however, it must be ensured that the potential differences between the DICNET users do not exceed 7 V. The TERM 24 features a permanently installed bus termination resistor.



Please always follow the information in chapter "RS485 connection (DICNET)!"

7 LOCON 24, 48 and 64 options

The following performance features are available as an option for the basic unit:

7.1 Expansion to 32 outputs (LOCON 24 only)

Upgrading from 24 to 32 outputs

7.2 Inputs and logic functions (LOCON 24 and 48 only)

16 inputs for logic gating with outputs. Chapter "Logic functions" contains a detailed description.

7.3 SSI interface

The connection of SSI absolute shaft encoders is supported as an option. Please refer to chapter "Pin assignment X3 (1x6-pin screw terminals)" on page 16 for the pin assignment of the SSI interface.

7.4 Incremental encoder; incremental counting/direction inputs

Optionally, an incremental encoder with any resolution can be connected to LOCON, whereby the limit values specified in the technical data must be observed. 24 V incremental encoders with two 90°-offset tracks A and B are supported, wired in accordance with the chapter Connection elements (INC_TRACK_A, INC_TRACK_B). Moreover, if using an incremental encoder, certain inputs to which the absolute shaft encoder is normally connected are interpreted as status signals. Please refer to chapter 'Signal description' for a more precise description of their mode of operation.

Alternatively, inputs "Encodertrack9" and "Encodertrack10" can be evaluated as counting and direction input by appropriate wiring. One pulse is incremented with each rising edge at "Count". If input "Down+" is at 24 V, down counting occurs. Otherwise, up counting occurs. If "Select-Count+" is not wired or is wired to 0 V, the system expects an incremental encoder with A/B tracks.

7.5 Encoder monitoring (option G)

Optionally, a 'genuine' encoder monitoring is available. It compares the encoder value read in each cycle with the value read in before and generates an Error 105 if a deviation greater than +/- 3 increments has been detected for a period equal to eight times the cycle time. This procedure reliably detects a defective encoder or a damaged cable, but brief interferences on the encoder line do not result in an error message.

First of all it is checked, whether the difference between last and current encoder value is > +/- 3. If it is less, the encoder value is interpreted as ok and the error counter is decremented by 1, provided that it exceeds 0. In case an encoder deviation > +/-3 inc. was detected, the error counter is incremented by „EncoderErrorStep“ (provided that it is not a zero crossover). Through it an error is weighted more than a good value.

When the error counter reaches 256, the device shows the error 105.

Through this process brief interferences and differences below 3 inc. are ignored, however, a defective encoder or a severely disturbed encoder information is recognized.

The most significant encoder can not be monitored, as the encoder acts as if it was driven back and forth between 0..EncoderHalf, in case the MSB (most significant bit) is defective.

The value „EncoderErrorStep“ by which the error counter is counted up is set by the encoder type; that means a value between 100 and 199 is set as encoder type at a device with activated encoder test (only possible for absolute shaft encoders) Then the value „EncoderErrorStep“ results as (encoder type - 100). If, for instance, 123 is entered as encoder type, the encoder counter is counted up by 23 at each incorrect encoder value.

Error 100 is not suppressed if the encoder is not connected on units for absolute shaft encoders with a resolution of 360 or 1,000 increments featuring this option.

7.6 Speed display

Optionally, a 'hardware' speed display at the upper 8 outputs of the cam control as a binary value is available. In this case, the last output corresponds to the most significant bit of the speed, e.g.: 33 rpm = 21 (hex) = 00100001 (binary). If the displayable range of 255 is exceeded, the value at the input is frozen at 255.

LOCON 24

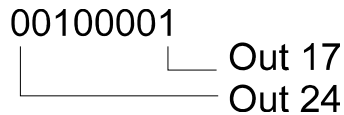

LOCON 24A

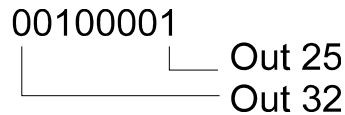

LOCON 48

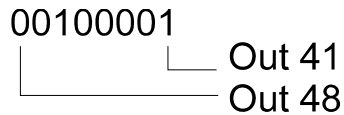

LOCON 64

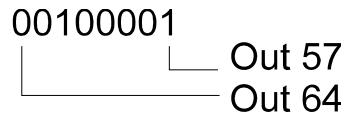

7.7 Direction-cams

This option allows you to define, for each output, with what direction of rotation the outputs are to be switched. Three options (per output) can be used:

- Switching in both directions
- Switching in positive direction only
- Switching in negative direction only

The evaluation only takes place at the cam's edge, that means, in case the control detects an edge (switch on- or switch off edge) the output is always updated whenever the direction of rotation corresponds to the programmed direction.

Example:

set direction for direction cams →

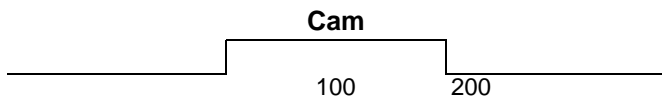

Driving direction	Position	OUT	Comment
→	100	HIGH	Edge is detected, direction is evaluated, output switched
→	200	LOW	Edge is detected, direction is evaluated, output is switched off
←	199	LOW	Edge is detected, direction is evaluated, output is not updated
← 99		LOW	Edge is detected, direction is evaluated, output is not updated
→ 100		HIGH	Edge is detected, direction is evaluated, output is set

In the first cycle after switching on the device and after each program change, all outputs are updated (independent of the programmed direction), that means, in this cycle the LOCON acts like a cam control without direction cams.

Afterwards an update of the outputs only takes place if the encoder's direction of rotation corresponds to the programmed direction of the output and a cam edge (switch on- or switch off-point) is present.



In the first cycle after switching on the device, it acts like a cam control without direction cams!

7.8 Angle-time cam

LOCON 24, 48 and 64 are available optionally with angle-time cams. The switch-on point is dependent on the angle, the switch-off point is defined by a time period (1 through 32500 ms). Please note that an idle time compensation is not possible for this optional adjustment. Please refer to chapter "Entering angle-time-cam" on page 70 for a detailed description.

Note: The switch-on point and the duration must not have the same value.

-> otherwise: Error 22.

7.9 Memory expansion

LOCON 24, 48 and 64 feature a memory for 1,000 data records as standard. Optionally, the memory can be upgraded for 1,500 data records.

7.10 Offline programming

It is possible to program the LOCON offline on a PC without the unit itself having to be connected to the PC when programming.

The program package "WINLOC" which runs on any PC with WIN95/98 or WIN-NT is used for this purpose.

After programming, the data can then be transferred to the LOCON via the PC's serial port.

It is also possible to transfer existing programs from LOCON to the PC, change these programs on the PC and then reload them back into the cam control.

The WINLOC program package is available free of charge from our sales agents. You can also download the software from our homepage.

7.11 Data backup and documentation on PC

The possibility of a data back up and documentation on a PC is also available. This is a part of the "WINLOC" program package (see above).

This allows you to back up programs of LOCON to a PC's hard disk or floppy disk, to comfortably print and also reload the programs.

7.12 Lockable outputs

The function 'Lockable outputs' offers the option of locking any number of outputs, whereby the upper outputs are generally locked. The locked outputs can only be programmed with connected programming approval (ProgEnable). The other outputs are freely programmable (also in case of unconnected programming approval). This function is implemented if necessary.

Example:

A LOCON 24 with 8 locked outputs was ordered. Here the outputs 1 to 16 are freely programmable in case of unconnected ProgEnable, the outputs 17 to 24 are only to be changed in case of connected programming approval (ProgEnable).

7.13 Program controller function (encoder simulation)

The LOCON can also be configured as a program controller (timer). In this case, it behaves in the same way as an incremental cam control. However, the count is changed not via an external incremental encoder (see above) but via an internal timebase (which can be set from 1 ms to 65535 ms).

7.14 Analog outputs

Optionally the LOCON 24 / LOCON 48 can be equipped with 2 analog outputs. A freely programmable analog voltage can be programmed in a item-based way via these outputs. The entry is carried out in mV.

Example:

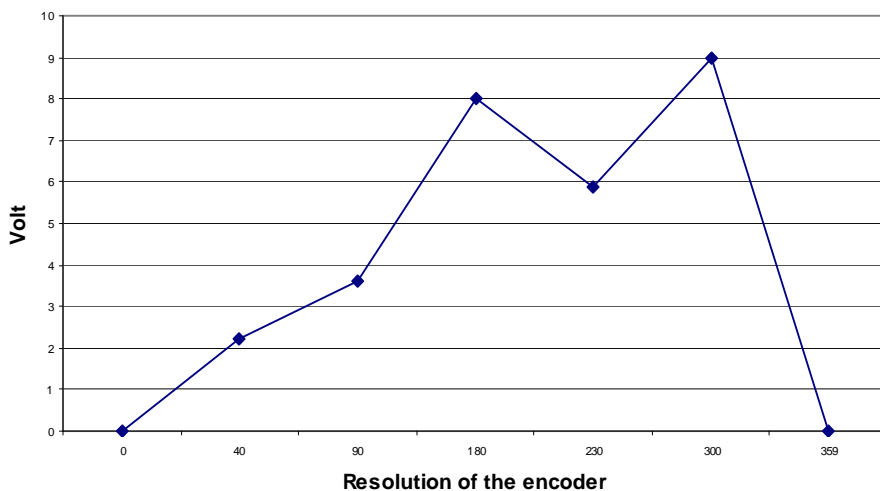

7.15 Option X37 - encoder monitoring

The encoder monitoring is the same as described in chapter "Encoder monitoring (option G)" on page 30, however, deviations that exceed +/- 1 increment are detected.

7.16 Option H08 - highspeed-idle time compensation

At this option the outputs 1 - 8 are determined according to the direct ITC-calculation method. All other outputs are treated according to the path-dependent ITC-calculation method. Further details on the idle time compensation can be found in chapter "Function of the idle-time compensation" on page 94.

7.17 Option X53 (preset value)

From the version V4.02 on the LOCON 24 features an extended scope of functions.

Function description:

In case of a configuration as incremental cam control when it comes to a "Clear" either a resetting of the count to 0 (as before) or a setting to a previously entered "preset-value" occurs.

This functionality is controlled via the signal "PresetAktiv+" at pin 4 of the connector X4 (at absolute encoders = encoder track 2). In case this pin is set on 0V or unwired (as it is the case in already existing plants at present), a resetting of the count to 0 takes place. If this pin is wired with 24V, a setting of the count to "preset-value" takes place at every Clear.

In the state of delivery the "preset-value" equals 0. At present it can be changed either via TERM 24 (from V3.02 on), the integrated front of LOCON 24 (from V4.02 on) or WINLOC (from V1.8 on) in the "Initialization menu". (Status 22.08.00)

7.18 Option X55 (locked outputs)

The device acts like a regular LOCON 24-V08 with the change that the access to the locked outputs (through the option V) is protected by a password. The password is: **0815**. The function „Clear all“ is protected by the same password.

7.19 Option X59 (braking angle display)

Principle

This function gauges the braking angle of a press, starting from the braking command up to the actual standstill.

Description

Via an input (track 13) at the LOCON the braking command is recorded.

The process angle is measured from the leading edge of the input pulse on, up to the standstill of the machine (speed = 0).

This value is then presented on the display for ten seconds (Fxxx - flashing).

If this value exceeds the set "max. angle" (adjustable from 0 to 99 in the initialization menu), the "Error 29" is displayed additionally and the run-control-relay becomes inactive.

This error can be confirmed with **Esc** and the process starts all over again.

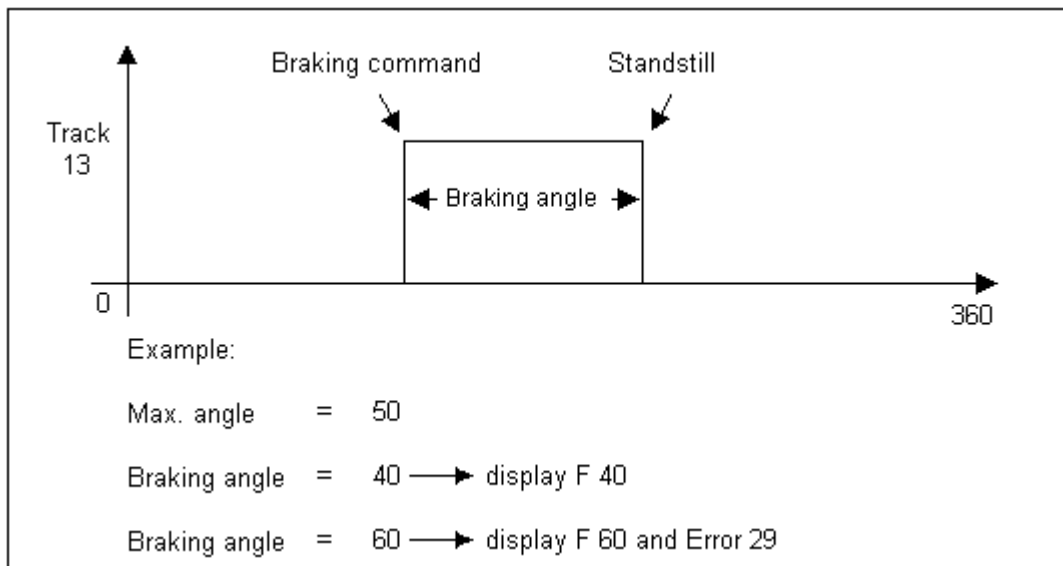

7.20 Option X81 (24 Bit SSI-encoder)

In connection with the option X81 a regular 24-Bit Multiturn encoder can be used. However, only the front disc is evaluated. Consequently it acts as if a Singleturn encoder was connected.

7.21 Special versions

Over and above the diverse performance features of the LOCON 24, 48 and 64 Series and the TERM 24 described in this manual, we offer customized adaptations and special versions, as is the case with all other models. If necessary, please contact your sales agent or ourselves with your enquiry.



If you are uncertain what device version or what options you are using, please compare the information on the rating plate with the explanations at the end of this Manual in chapter Order designation. Please do not hesitate to contact your dealer or ourselves if you have any queries.

8 LOCON LTC (special version)

8.1 Mechanics space requirements

Front cutout

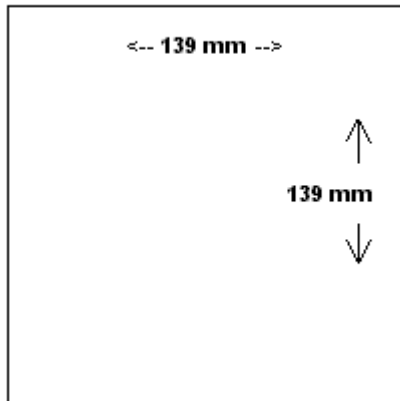

Please provide 100 mm for the branch connections behind the front cutout.

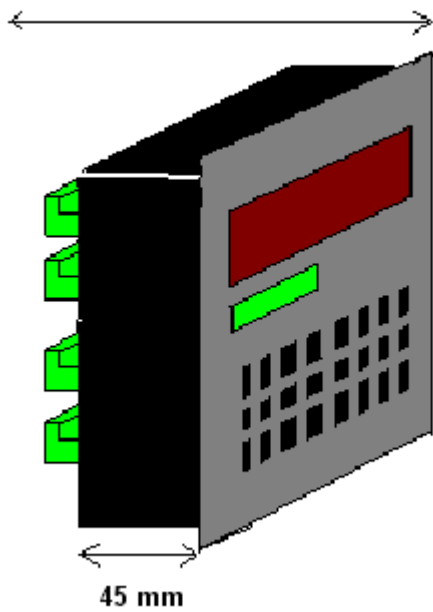

8.2 Electrical connections

8.2.1 Rear view: Terminal allocation

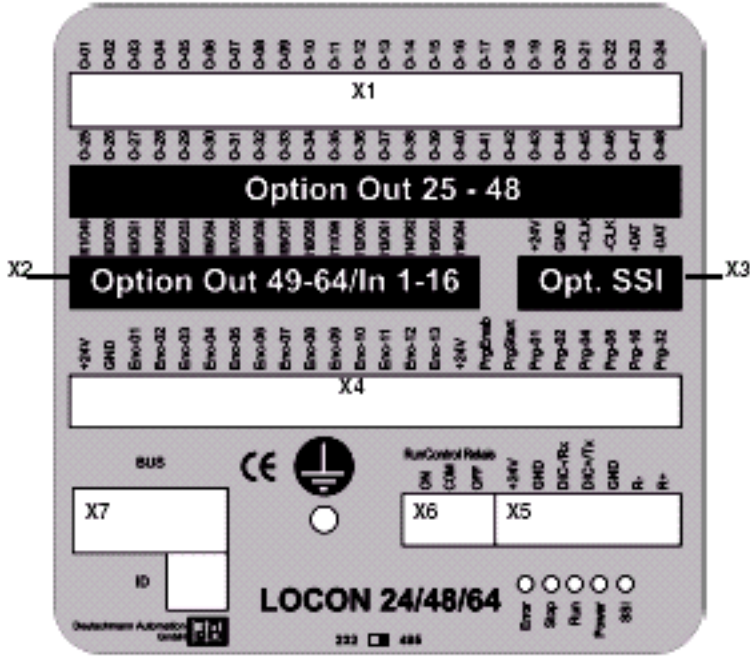

8.2.2 Terminal allocation

Terminal allocation	Connection terminal	Designation
X1	0 - 1	Output no. 1 (cam)
	0 - 2	... The outputs 1 to 8 are delayed cams and / or N-cycles.
 The outputs 1 to 8 are classical cams.

	0 - 31	Output no. 31 (cam)
	0 - 32	Output emergency power-off
	0 - 33	Output to display the control cam of signal no. 1
 (Wiring of the requirement outputs)
X2	I01	Input signal no. 1
	I02	Input signal no. 2
 These inputs allow to connect the sensors PNP 24V to the device.
	I16	Input signal no. 16
X3	nc	Option SSI
X4	+24V	Power supply +24V of the encoder (in general: color red)
	GND	Power supply 0V of the encoder (color: black)
	ENC-1	Input bit 0 of the encoder (color: white)
	ENC-2	Input bit 1 of the encoder (color: brown)
	ENC-3	Input bit 2 of the encoder (color: green)
	ENC-4	Input bit 3 of the encoder (color: yellow)
	ENC-5	Input bit 4 of the encoder (color: grey)
	ENC-6	Input bit 5 of the encoder (color: pink)
	ENC-7	Input bit 6 of the encoder (color: purple)
	ENC-8	Input bit 7 of the encoder (color: grey/pink)
	ENC-9	Input bit 8 of the encoder (color: blue)
	ENC-10	Not connected to encoder 360 pts gray excess
 Not connected to encoder 360 pts gray excess
	ENC-13	Not connected to encoder 360 pts gray excess
	+24V	Output 24V - allows the following connections.
	PRGenab	Input unblocking programming (+24V=unblocking)
	PRGStart	Input validation of the program no., provided by the following terminals. (Optional use if the keyboard is used for program change.)
	PRG-01	These 4 inputs provide a number of the binary program (up to 16). The program has to be activated by the input so that it will be active.
PRG-02		
PRG-04		
PRG-08		
PRG-16	Input control-startup (+24V = in operation).	
PRG-32	Input outer "rearmment" (pulse +24V)	
X5	+24V	Device's power supply input +24V
	GND	Device's power supply input 0V
	DIC-/RX	Communication input RS232 OR RS485 (DICNET) requirement wiring
	DIC+/TX	Communication input RS232 OR RS485 (DICNET) requirement wiring
	GND	Ground reference for communication RS232 requirement wiring
	R-	Terminal resistance for RS485 requirement wiring
	R+	Terminal resistance for RS485 requirement wiring
X6	ON	Contact "ON" differential relay (intensity max. 1A)
	COM	Jointly differential relay (intensity max. 1A)
	OFF	Contact "OFF" differential relay (intensity max. 1A)

8.2.3 Example for the wiring scheme

Following please find the electrical connections of LOCON 24 LTC

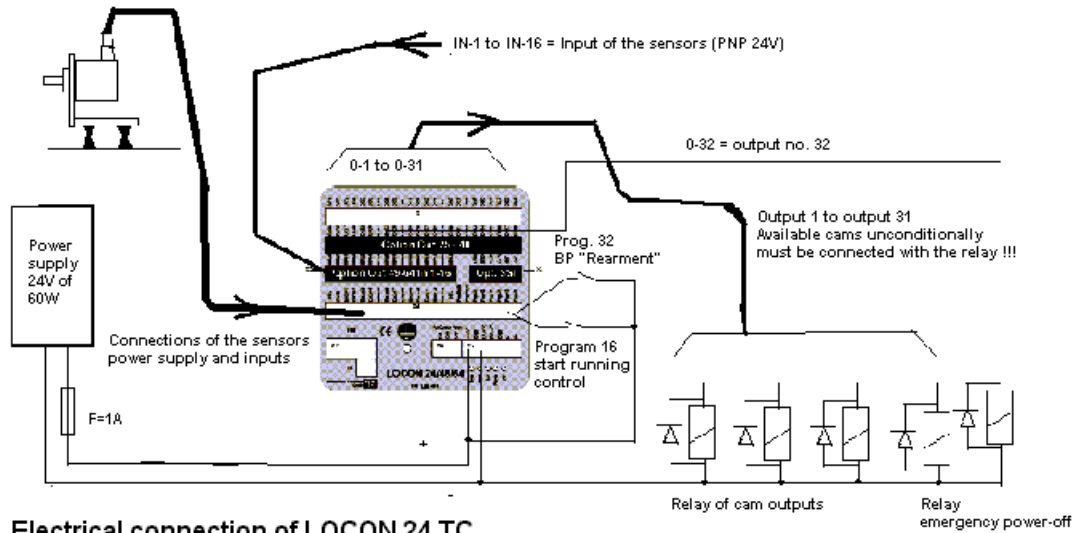

Electrical connection of LOCON 24 TC

8.3 Programming of the cams

Display	Starting Point	Key	Display	Explanation
I00 L48 PA000 MAIN MENU		Axis	X00 Select Axis MAIN MENU	Select another axis, enter value
	I00 L48 PA000 MAIN MENU	Prog	I00 L48 PA000 MAIN MENU	Change active program
		Esc Enter	Change Act.Prog? ESC=No, ENT=Yes	Safety check for program change
	I00 L48 PA000 MAIN MENU	Del	Clear all ? ESC=No ENT=Yes	Global delete, safety check



X00 L48 PA000 PROGRAMMING		Enter	PA00 O01 I000 L48 └-----┘ └---- X00	Select program
	PA00 A01 T000 L48 └-----┘ └----- X00	Del	Clear Program ? ESC=No, ENT=YES	Delete selected program
	PA00 O01 I000 L48 └-----┘ └---- X00	Copy	PA000 O01 I000 L64 Copy Prg 000→ 000	Copy selected program to
	PA00 O01 I000 L48 └-----┘ └---- X00	Enter	PA00 O01 I000 L48 └-----┘ └---- X00	Select output
	PA00 O01 I000 L48 └-----┘ └---- X00	Prog	P00 Move-Cam L48 O01-O01 00000→	Shift cam track
		←	P00 Move-Cam L48 O01-O01 00000→	Stipulate output from ... to
		Enter	P00 Move-Cam L48 O01-O01 00000→	Input value
	P00 Move-Cam L48 O01-O01 00000→	+ -	P00 Move-Cam L48 O01-O01 00000→	Stipulate shift direction, enter value
	PA00 A01 T000 L48 └-----┘ └----- X00	Del	Clear output? ESC=No, ENT=Yes	Delete selected output
	PA00 O01 I000 L48 └-----┘ └---- X00	Copy	PA000 O01 I000 L64 Copy Outp.: 01 01	Copy selected output to Enter value
	PA00 O01 I000 L48 └-----┘ └---- X00	Enter	PA00 O01 I000 L48 └----┘ └---- X00	Specify idle time, enter value
			PA00 O01 I000/123 └-----┘ └---- X00	Display with separate ON/OFF idle time compensation
		Enter	PA00 O01 I000 L48 └0100┘ └---- X00	Enter switch-on point
		Enter	PA00 O01 I000 L48 └0100┘ └0200┘ X00	Enter switch-off point
	I00 L48 PA000 O01 └----┘ └---- I000	Teach In	PA00 O01 I000 L48 └0100┘ └---- X00	Cam programming TEACH-IN



I00 L48 PA000 INITIALISATION	Enter	X00 L32 PA000 Analog-End: 0100	Enter analog upper range value
	Enter	X00 L32 PA000 Count Range: 08192	Enter counting range (only in case of incremental values)
	Enter	X00 L48 PA000 Zero Point: 0000	Stipulate zero shift (only in case of absolute values)
	Enter	X00 L32 PA000 Rot. of Enc: 0	Stipulate rotational direction
	Enter	X00 L32 PA000 Language: 0	Select language
	Enter	X00 L32 PA000 Speed Scal: 0060	Scale speed display
	Enter	X00 L32 PA000 Fict. Res.: 00360	Stipulate fictitious encoder value



I00 L48 PA000 CONFIGURATION	Enter	X00 L48 PA000 Resol. Enc: 0360	Enter encoder resolution
	Enter	X00 L32 PA000 ITC-Typ: 1	Stipulate type of dead time compensation
	Enter	X00 L2 PA000 Basis-ID: 00	Stipulate DICNET no.
	Enter	X00 L48 PA000 Typ of Enc: 1	Stipulate type of encoder

8.4 Function "Apprentissage"

8.4.1 Presentation

The function "apprentissage" ("LEARNING") of LOCON 24 LTC makes it possible for the device itself to generate input signals of its control cams. In one round LTC programs a boss on each status change of the input signal. This is carried out for the 16 input signals.

Indirectly this function enables you to learn in which moment the signal appears and therefore the best possible control can be carried out.

8.4.2 Starting the function "Apprentissage"

In the following position LOCON 24 LTC has to be on the level of the LCD-display.

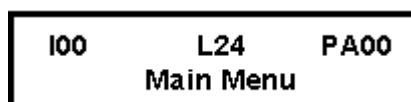

-> Please press the button **TEACH IN**.

The device shows the following text on its LCD-display:

**CLEAR COMP. CAMS ?
ESC→NO ENTER→YES**

The LOCON LTC gets ready to delete all control cams of the current program. Also this inquiry is the confirmation in order to switch to the mode "apprentissage" (LEARNING).

-> Please press the button **ENTER**.

The device shows the following text:

**LEARNING...
CANCEL WITH ESC**

In that moment the mode "apprentissage" (LEARNING) becomes activated. In order to quit just press **ESC**.

The device automatically gets out of the mode "apprentissage", when the machine has finished a round. All control cams will automatically be programmed.

8.5 Control

8.5.1 Control possibilities

In order to put control into operation a 24V-voltage has to be applied to input Prg-16.

So you can use a contact of the device's command scheme or a simple button with two positions.

In order to amplify the control you can apply a 24V-voltage to the input Prg-32, either by means of a push-button or with ESC-key of the keyboard.

A control error is displayed by the output statics O-32 (24V, 100mA). The output has to be connected in order to take in the relay contact in the machine control scheme.

Please note that the devices are able to provide several boss cams on one program controller's output. That way it becomes possible to generate **2 control types**.

The following rule is valid for both control types:

A status change of the input signal is not allowed without presence of the cam boss that corresponds to that input.

Static controls (such as a end of tape or "pilots") are possible without programming the boss.

8.5.2 Control type 1

Control type 1 (ejection of a piece)

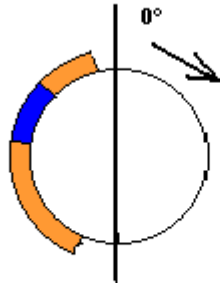

 Detection

 Synchronization cam 220° - 350°

For this control type only one cam boss is available on the corresponding output at the controlled input (see correspondence table).

LOCON 24 LTC is controlled within the cam if the input signal works well from 0V to 24V and then functions from 24V to 0V.

In the synchronization cam an increase AND a decrease of the signal has to take place so that the control functions properly.

This control type is especially needed for the short input signals or those that occur by pure chance in the cycle (as for the ejection of a piece). It does not allow the actual long signal in the cycle to be checked.

8.5.3 Control type 2

Control type 2 (exemple presence of band in the tool)

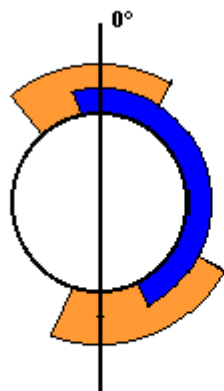

 Detection

 Synchronization cam 320° - 20° and 120° - 190°
(2 bosses)

For this control two cam bosses are available on the corresponding output at the controlled input (see correspondence table).

LOCON 24 LTC is controlled within the cam if the input signal only changes the state in the defined zones through the cam bosses.

The first cam boss determines the first change of state of the input signal and the second cam then determines the second change of state of the input signal.

Example: If the input signal is at 0V at the beginning of the first cam boss, then the signal at 24V has to be at the end of the first bosses. The second boss is supposed to show the opposite transition so that the control functions properly.

For each state of change of the sensor a detection boss has to be available.

This control type is outstandingly suitable for long signals in order to check the state of the sensor between the two bosses.

8.5.4 Correspondence table

Signal-no.	1	2	3	4	5	6	7	8	9	10	11	12	13	14	15	16
Input terminal of the signal	I01	I02	I03	I04	I05	I06	I07	I08	I09	I10	I11	I12	I13	I14	I15	I16
Control cam in correspondence with the programming	S33	S34	S35	S36	S37	S38	S39	S40	S41	S42	S43	S44	S45	S46	S47	S48

8.5.5 Description of the control error

The errors are displayed on the screen in 7 red segments. You use the number of the ERROR by continuingly identifying the error which is produced on the way to the input.

No. of the input signal I01 = 1

No. of the input signal I02 = 2

No. of the input signal X = X

Errors that are displayed by LOCON 24 LTC:

ERROR 140+X:

Only within the control type 1, this error indicates the exceeding of the control zone by means of the track signal.

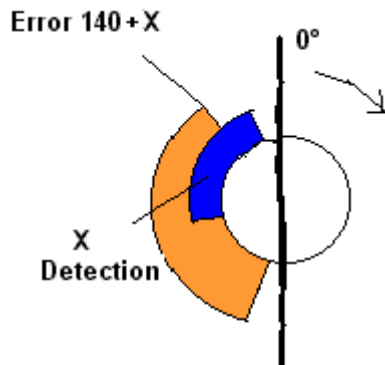

- Input signal X
- Synchronization cam

ERROR 160+X

For control type 1: No input signal no. X in the synchronization cam.

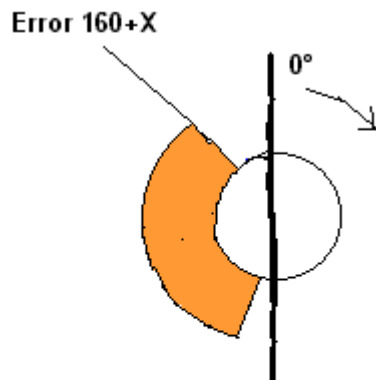

- Input signal X
- Synchronization cam

For control type 2: No change of state in the synchronization boss.

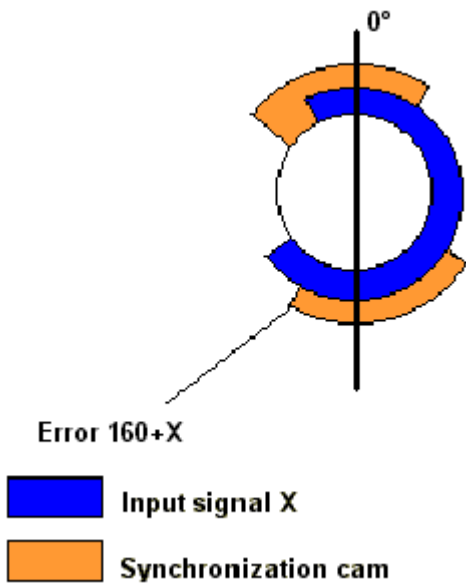

ERROR 180+X

Depending on the control type: Change of state of the signal beyond a synchronization boss.

For control type 1:

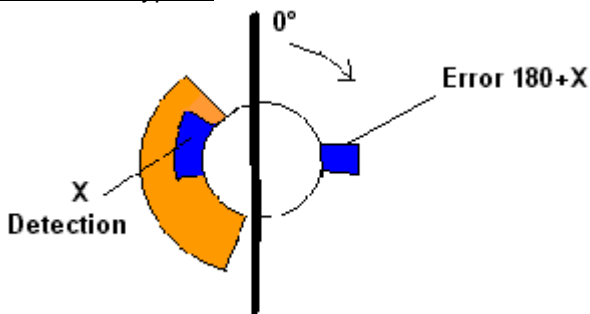

For control type 2:

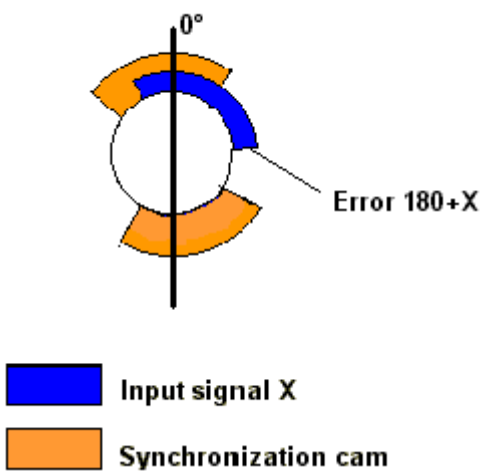

9 Networking terminals with cam controls and PCs

The chapter below illustrates certain connection examples between the units both via the DICNET bus and via the RS232 interface.

All DEUTSCHMANN controllers (LOCON, ROTARNOCK ...) with a DICNET bus can be included in this network. The following principles apply in general:

9.1 RS232 link

An RS232 link is always a **point-to-point link for 2 users**.

It must be borne in mind that, on connection, the Tx end of one user is connected to the Rx end of the other user and vice versa. Moreover, the device ground potentials must be interconnected.

9.2 RS485 link (DICNET)

A DICNET link is a bus system to which at maximum configuration level 16 cam controls (LOCON 32, LOCON 24 ...), 16 display units (TERM 4), 16 operator terminals (TERM 6, TERM 24 ...) and 1 PC can be connected **simultaneously** via a **twisted two-wire line** which should be shielded.

All "DICNET+" terminals are interconnected and all "DICNET-" terminals are interconnected. The terminals do not need to be reversed as on the RS232 interface.

Likewise, not necessarily there is a connection of the individual device ground potentials as on the RS232 interface; **however, you must ensure that the potential difference between the individual devices does not exceed 7 V.**

Consequently, equipotential bonding is generally carried out in practice at a central point (for example, in the switch cabinet).

Moreover, please ensure that the two bus users feature bus termination resistors at the start and end of the bus by connecting DICNET+ to R+ and DICNET- to R-, since, otherwise, serious transmission problems could occur.

If the devices are connected to the bus with a stub-end feeder, the length of the stub-end feeder may not exceed 1 m, so as to guarantee trouble-free operation.

9.3 Cable type for DICNET®

A shielded, twisted, 2-core cable (twisted pair) is recommended as the bus cable. The shield serves to enhance electromagnetic compatibility (EMC). However, an unshielded cable may also be used if ambient conditions permit, i.e. if no electromagnetic interference (EMI) is anticipated. The characteristic impedance of the cable should be between 100 and 130 Ω at $f > 100$ kHz; the cable capacitance should be < 60 pF / m wherever possible and the wire cross-section should be minimum 0.22 mm² (24 AWG).

A cable which fully complies with these specifications and which has been developed specifically for use in field bus systems is the UNITRONIC®-BUS LD cable 2 x 2 x 0.22, available on a drum from LAPP KABEL in Stuttgart, or by the metre from DEUTSCHMANN AUTOMATION.

The minimum wiring with shielding between two bus users is shown in the following illustration:

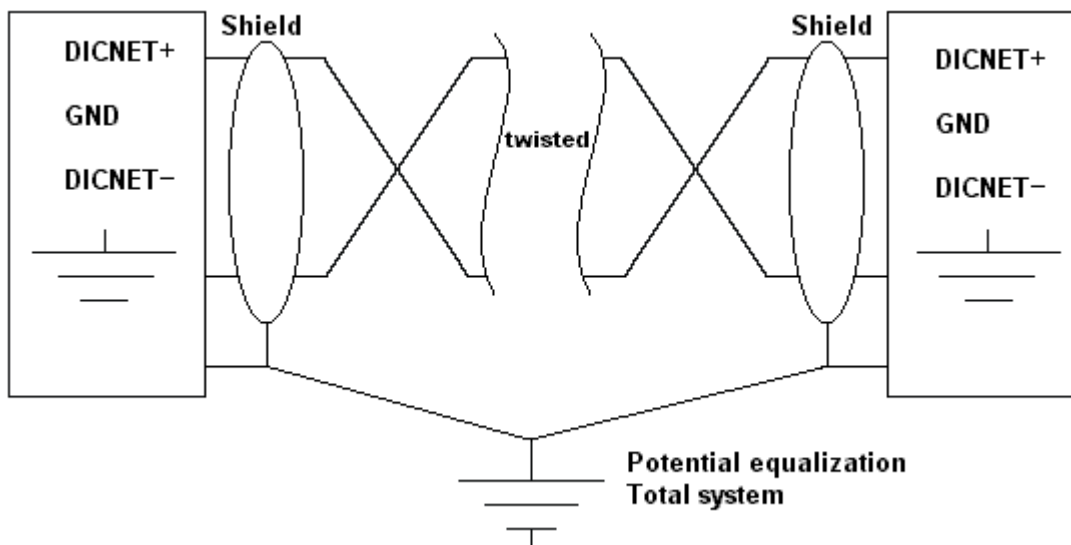

Picture 6: DICNET-wiring



The two signal wires may not be reversed!

GND of the two devices do not necessarily have to be connected.

The potential difference between the data reference potentials GND of all interface connections may not exceed ± 7 V.

9.3.1 Earthing, shielding

If using a shielded bus cable, we recommend that the shield be connected at both ends and with low inductance to PE in order to achieve optimum EMC wherever possible.

9.3.2 Line termination at DICNET®

The two ends of the entire bus cable must each be fitted with a line termination. This avoids signal reflections on the line and ensures a defined open-circuit potential if no user is transmitting (state of rest between the telegrams, so called idle state).

In this case, please ensure that the line termination is made at the physical ends of the bus cable, i.e. the integrated bus termination resistor must be activated at both devices located at the start and end of the bus.

9.4 Comparison DICNET® - RS232

If you intend to set up a permanent link between terminal and one or more cam controls, preference should be given to connection via the DICNET bus and not the RS232 interface since the bus features a higher level of data integrity, i.e. transmission errors which may occur, for instance, as the result of noise pulses are automatically detected and corrected by DICNET up to a certain extent.

Wherever possible, the RS232 interface should be used only for temporary connections (e.g. for connecting a PC).

9.5 Connection examples

9.5.1 DICNET link LOCON-TERM

LOCON and TERM are connected as follows via DICNET

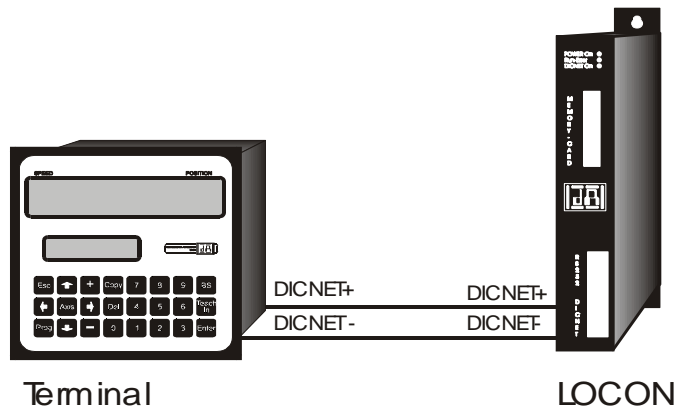

Terminal LOCON
Picture 7: DICNET link terminal - LOCON



The presented devices exemplary stand for Deuschmann terminals and cam controls of the series LOCON / ROTARNOCK respectively.

The two ground potentials do not have to be interconnected. However, you must ensure that the GND potential between the individual DICNET bus users does not differ by more than 7 V. Otherwise, equipotential bonding must be used.

The bus termination resistor must be activated on both units.

Consequently, in the case of simple wiring with a LOCON and an external operator control panel, it is the obvious choice to use the same 24 V supply for both units.

9.5.2 RS232 link LOCON - TERM

On the RS232 version, only a point-to-point connection between LOCON and the external operator control panel is possible.

In this case, the Tx LOCON line must be connected to the Rx TERM line of the operator control unit and vice versa, as can be seen from the illustration below.

The two ground potentials **must** be connected

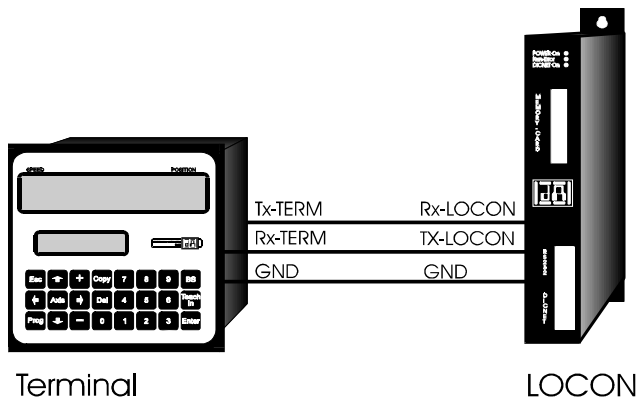

Picture 8: RS232 link Terminal - LOCON



The presented devices exemplary stand for Deutschmann terminals and cam controls of the series LOCON / ROTARNOCK respectively.

9.5.3 DICNET link LOCON-TERM-PC

A PC can be integrated in a DICNET® bus system using a DICNET adapter. The connection to the PC is made at a serial port COMx - see the illustration below

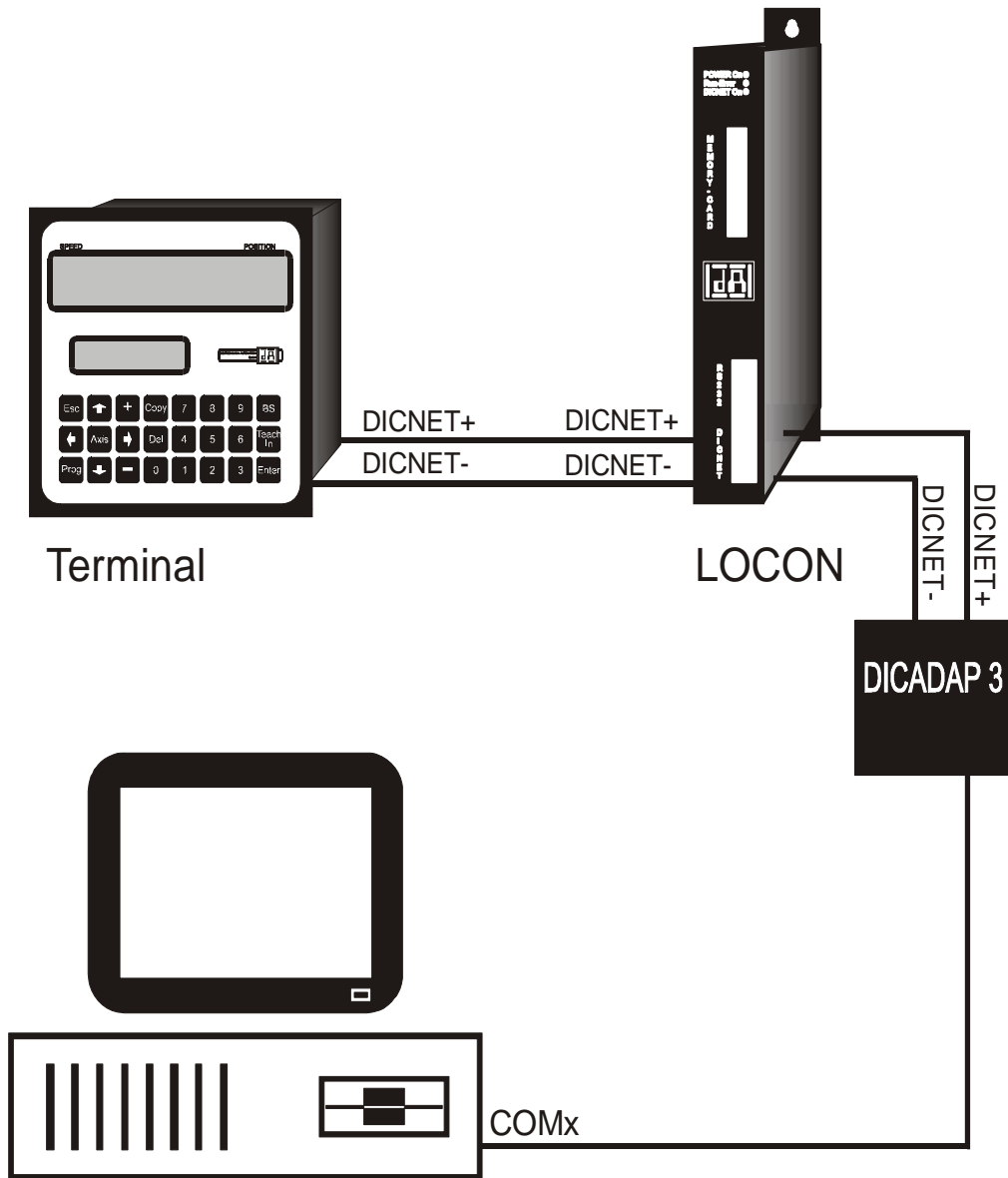

Picture 9: Link DICNET bus to PC

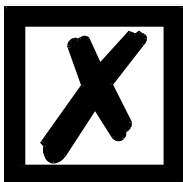

The presented devices exemplary stand for Deutschmann terminals and cam controls of the series LOCON / ROTARNOCK respectively.

10 LOCON 24 with Profibus and MPI

See instruction manual „Cam controls with Fieldbus connection“ (art.-no. V3058E).

11 Commissioning and self-test

11.1 Commissioning of the terminal

Please follow the procedure below when commissioning the terminal:

- 1) Connect the terminal to the required cam control
- 2) Connect the 24 V supply voltage

The terminal now conducts the self-test described in the following chapter, checks whether a user with the No. in accordance with the DIP switch setting is connected and then establishes the connection (provided this user is present).

The duration of the power-up phase, until the unit is ready for operation, depends on the number of network users and may take up to 10 seconds.

You will see message "not present" if no user is found with the set No.

11.1.1 Self-test of the terminal

After power-up of the terminal, the terminal conducts a self-test which takes a few seconds. The unit is then ready for operation.

The following tests are conducted during the self-test:

- Test of the entire RAM area or defective memory addresses
- Checksum test of the EPROM
- Display test; all output indicators light

Should errors occur during the self-test, these are displayed on the display if possible (see chapter Error messages).

11.2 Commissioning of the cam control

The commissioning procedure for the LOCON is as follows:

- 1) Connection of the encoder
- 2) Connection of the "ProgEnable" input if programming is to be allowed
- 3) Connection of the external program selection if required
- 4) Connection of the status signals if an incremental encoder is used
- 5) Connection of the outputs used
- 6) Connection of the serial interface, if required
- 7) Connection of the 24 V power supply

The LOCON now conducts the self-test described in the following chapter, then generates the cam tables, after which it is ready for operation, i.e. the program last active (the last time the system was powered down) is executed.

The duration of the power-up phase until the unit is ready for operation depends on the number of programmed cams and may take up to 10 seconds.

A status message together with the software version information is displayed on any optionally connected PC.

If any error conditions which LOCON can detect itself have occurred, a corresponding error number is displayed. Please refer to chapter "Error messages" for the significance of this number and the actions required.

Moreover, the optional Run-Control relay remains in dropped-out condition and the corresponding status LED "Run Error" lights.

11.2.1 Self-test of the cam control

After power-up of the LOCON, the LOCON conducts a self-test which takes a few seconds. The unit is then ready for operation.

The following tests are conducted during this self-test:

- Test the entire RAM area for defective memory addresses
- Checksum test of the EPROM
- Checksum and plausibility test of the EEROM
- Plausibility test of the cam program

Should errors occur during the self-test, these are displayed on the display if possible (see chapter Error messages).

12 Brief Instructions TERM 24 / LOCON 24, 48, 64

Following please find a summary of the menu structure. For further details see the corresponding chapter. If values are entered in the menus, the key **Enter** has to be pressed twice, once for saving the value and the second time for changing the menu point. This brief instruction contains the significant performance characteristics only.

Display	Starting Point	Key	Display	Explanation
I00 L48 PA000 MAIN MENU		Axis	X00 Select Axis MAIN MENU	Select another axis, enter value
	I00 L48 PA000 MAIN MENU	Prog	I00 L48 PA000 MAIN MENU	Change active program
		Esc Enter	Change Act.Prog? ESC=No, ENT=Yes	Safety check for program change
	I00 L48 PA000 MAIN MENU	Del	Clear all ? ESC=No ENT=Yes	Global delete, safety check
		Teach In	LOCAL T24 V2.31 REMOTE R2 V5.2	Active software version



X00 L48 PA000 PROGRAMMING		Enter	PA00 O01 I000 L48 └───┬───┘ X00	Select program
	PA00 A01 T000 L48 └───┬───┘ X00	Del	Clear Program ? ESC=No, ENT=YES	Delete selected program
	PA00 O01 I000 L48 └───┬───┘ X00	Copy	PA000 O01 I000 L64 Copy Prg 000 → 000	Copy selected program to
	PA00 O01 I000 L48 └───┬───┘ X00	Enter	PA00 O01 I000 L48 └───┬───┘ X00	Select output
	PA00 O01 I000 L48 └───┬───┘ X00	Prog	P00 Move-Cam L48 O01-O01 00000 →	Shift cam track
		←	P00 Move-Cam L48 O01-O01 00000 →	Stipulate output from ... to
		Enter	P00 Move-Cam L48 O01-O01 00000 →	Input value
	P00 Move-Cam L48 O01-O01 00000 →	+ -	P00 Move-Cam L48 O01-O01 00000 →	Stipulate shift direction, enter value
	PA00 A01 T000 L48 └───┬───┘ X00	Del	Clear output? ESC=No, ENT=Yes	Delete selected output
	PA00 O01 I000 L48 └───┬───┘ X00	Copy	PA000 O01 I000 L64 Copy Outp.: 01 01	Copy selected output to Enter value
	PA00 O01 I000 L48 └───┬───┘ X00	Enter	PA00 O01 I000 L48 └───┬───┘ X00	Specify dead time, enter value
			PA00 O01 000/123 └───┬───┘ X00	Display with separate ON/OFF dead time compensation

		Enter	PA00 O01 I000 L48 ┌0100 └--- X00	Enter switch-on point
Devices with the option W 16/32 (angle-time cam) have the possibility (if the cursor is in the switch-off position) with the button cursor up to switch to time-time-cams and reverse. The symbol changes in "ms"		Enter	PA00 O01 I000 L48 ┌0100 ┌0200 X00	Enter switch-off point
	I00 L48 PA000 O0 ┌--- └--- I000	Teach In	PA00 O01 I000 L48 ┌0100 └--- X00	Cam programming TEACH-IN



I00 L48 PA000 INITIALISATION		Enter	X00 L32 PA000 Analog-End: 0100	Enter analog upper range value
		Enter	X00 L32 PA000 Count Range: 08192	Enter counting range (only in case of incremental values)
		Enter	X00 L48 PA000 Zero Point: 0000	Stipulate zero shift (only in case of absolute values)
		Enter	X00 L32 PA000 Rot. of Enc: 0	Stipulate rotational direction
		Enter	X00 L32 PA000 Language: 0	Select language
		Enter	X00 L32 PA000 Speed Scal: 0060	Scale speed display
		Enter	X00 L32 PA000 Fict. Res.: 00360	Stipulate fictitious encoder value



I00 L48 PA000 CONFIGURATION		Enter	X00 L48 PA000 Resol. Enc: 0360	Enter encoder resolution
		Enter	X00 L32 PA000 ITC-Typ: 1	Stipulate type of dead time compensation
		Enter	X00 L2 PA000 Basis-ID: 00	Stipulate DICNET no.
		Enter	X00 L48 PA000 Typ of Enc: 1	Stipulate type of encoder



X00 R2 PA000 LOGIC FUNCTION		Enter	I00 O01 TOFF =000 =N01	Basic setting
		Enter	I00 O01 TOFF =123 =N01AE07VE03AE16	Example with 3 linkages

13 Operation LOCON 24, 48, 64

Operation of the LOCON 24, 48 and 64 cam controls is identical to the description in chapter "Operation via TERM 24". Only the differences are described below.

13.1 Main menu LOCON 24, 48, 64

You will see the following menu on the liquid-crystal display (LCD) after power-up of the unit:



Display	Significance
I00	Internal cam control (in case of LOCON 24, 48, 64) (GNR 0 in this example)
P _A 000	Program 0 of the connected user is the active program (program currently being executed)
P 000	Program 0 of the connected user is the selected but non-active program

13.1.1 Programming enable (dongle)

DEUTSCHMANN cam controls feature a dongle which must first be unlocked before programming can be carried out in order to protect against unauthorized operation.

Please refer to chapter "Pin assignment" for details of the dongle.

13.1.2 Function, program controller

Units with the program controller function are normal LOCON 24, LOCON 48 or LOCON 64 units on which a TIMER has been programmed as the encoder type. The cam control then behaves in precisely the same way as an incremental cam control, whereby the incremental pulses are generated internally. The interval between one pulse and the next is referred to as the timebase and can be set by the customer from 1 ms to 65535 ms. All functions (CountEnable, Clear ...) as on the incremental cam control are available. The counting range can also be freely defined. Units with the TIMER function do not have idle time compensation. Moreover, there is no speed display.

13.2 Configuration and initialisation

The parameters specified in the parameter table below can be configured/initialized at the works or by the user or can be set with the DIP SWITCH. Even though certain values are displayed, these values can, however, not be changed by the user for the aforesaid reasons (or only via DIP switch).

13.2.1 LOCON 24, 48 and 64 parameter table

Designation	Default	Ex-works <input type="checkbox"/> or configurable <input checked="" type="checkbox"/>	Value range
Initialisation parameters			
Counting range	16777216 (MT) 16384 (L 24) 8192 (L 48, 64)	<input checked="" type="checkbox"/>	For incremental encoder
Zero-point offset	0	<input checked="" type="checkbox"/>	Preset at inc.
Reversal	0	<input checked="" type="checkbox"/>	0 = Normal 1 = Inverted
Language	0	<input checked="" type="checkbox"/>	0 = German 5 = Flemish 1 = English 6 = Dutch 2 = French 7 = Swedish 3 = Italian 8 = Finnish 4 = Spanish 9 = Danish
Factor speed display	60	<input type="checkbox"/>	0 .. 9999 (rev./sec.)
Fictitious encoder value	Encoder resolution	<input checked="" type="checkbox"/>	Units with absolute shaft encoder: 2.. 32500 Units with incremental encoder: Max.value = $\frac{\text{Encoder resolution} \times 32500}{8192 \text{ (LOCON 48/64)}}$ 16384 (LOCON 24)
Configuration parameters			
Encoder resolution	As ordered	<input type="checkbox"/> <input checked="" type="checkbox"/> <input checked="" type="checkbox"/>	Abs. parallel Gray: 360, 720, 1000, 3600, 7200 LOCON 24: 2^n (n=0..14 bit) 2 .. 16384 LOCON 48,64: 2^n (n=0..13 bit) 2 .. 8192 DSI-Gray: 360 (others on request) SSI Gray: 360, 720, 1000, 3600, 7200 LOCON 24: 2^n (n=0..14 bit) 2 .. 16384 LOCON 48,64: 2^n (n=0..13 bit) 2 .. 8192 MT: 24 bit Incremental: 2 .. 16384 LOCON 24 2 .. 8192 LOCON 48, 64 2 .. 16777216 (MT) TIMER: Counting range can be set from 1 ms to 65535 ms
Idle time compensation TZK	As ordered	<input type="checkbox"/>	1 = Block-serial TZK 2 = Bit-serial TZK 3 = Block-serial, separate switch-on and switch-off idle time
Device ID for DICNET (hardware-configurable)	DIP switch	<input checked="" type="checkbox"/>	0 .. 15
Encoder type	As ordered	<input type="checkbox"/>	1 = Absolute shaft encoder, parallel Gray 2 = Incremental encoder 3 = Absolute shaft encoder, SSI, Gray 4 = Absolute shaft encoder, DSI, Gray 5 = Timer 6 = Multiturn

13.3 LOCON 24 MT

The devices LOCON 24 from the firmware version 4.4 on are equipped with the following functionality: Scalable encoder resolution and display of the revolutions.
The desired number of revolutions can be adjusted in powers of the base 2 (1, 2, 4, 8, ..4096) and the desired encoder resolution is freely adjustable between 1 ..4096.

Display	Starting point	Key	Display	Explanation
	100 24M PA000 MAIN MENU		100 24M PA000 CONFIGURATION	Select configuration menu.
100 24M PA000 CONFIGURATION			100 24M PA000 Resol. Enc: 04096	Enter the menu, in order to set the individual parameters.
			100 24M PA000 Resol. Enc: 00360	Set the desired virtual resolution/rev.
				To take over changes
	100 24M PA000 Resol. Enc: 00360			Press ENTER several times until the next line appears in the display.
100 24M PA000 No. of rot: 4096			100 24M PA000 No. of rot: 0002	Enter the new value
				To take over changes
				Unit exits the menu and takes over changes.

13.3.1 Parameter description

13.3.1.1 Reversal, encoder

The direction of rotation of the connected encoder (parallel, incremental, DSI or SSI) can be inverted with this parameter.

If configuring via the LCD, the reversal can be implemented with key "±" in line "Fictitious encoder value".

13.3.1.2 Encoder type

This parameter defines the encoder type. The following encoders are currently supported:

Gray absolute shaft encoders (parallel), 24 V, see parameter table

Incremental encoders, 24 V, see parameter table

Gray-SSI absolute shaft encoders, see parameter table

TIMER (value is generated internally), see parameter table

13.3.1.3 Encoder resolution

This parameter defines the resolution (information items/revolution) of the encoder.

The resolutions currently available are specified in the parameter table

13.3.1.4 Counting range (only in the case of incremental encoders)

By default, a counter overflow occurs if the counting range limit is reached if using an incremental encoder. Example: At 8192 (LOCON 48, 64), i.e. after count 8191 (or 16383), the counter counts to 0000 unless an external Clear signal has been issued.

The counting range can be set with this parameter. Please refer to the parameter table for the limited values.

13.3.1.5 Type of idle time compensation

The term "idle time" means the time which elapses from setting a PLS output through to the actual response of the connected unit (e.g. opening a valve).

This idle time is normally constant.

A PLS must shift a programmed cam as a function of the actual encoder speed in order to compensate for this idle time dynamically. This means that a valve which is to open at position 100 must, for example, already be opened at position 95 at a speed of 1 m/s and must already be opened at position 90 at a speed of 2 m/s.

This function is designated dynamic cam shifting or idle time compensation (TZK).

Idle times may be programmed block-serially, i.e. a set idle time always applies to a block of 8 outputs, or bit-serially, which provides the option of choosing different switch-on and switch-off delay times in the case of block-serial TZK.

The setting is made with the following values:

- 1 = Block-wise idle time compensation
- 2 = Bit-wise idle time compensation
- 3 = Block-wise idle time compensation with separate switch-on and switch-off times

13.3.1.6 DICNET-device number (GNR)

This parameter can be used to set the device number with which the LOCON logs on to the DICNET bus and with which, for example, it is addressed by WINLOC or communicates with TERM 4.

This value can be changed only with the rear-panel DIP switch and not in the menu.

If you use the RS232 interface, this parameter is of no significance.

13.3.1.7 Menu Select language

In conjunction with the integrated operator control panel, it is possible to select the menu language with this parameter.

The following assignment applies:

- | | |
|----------------------|-------------|
| 0 = German (default) | 5 = Flemish |
| 1 = English | 6 = Dutch |
| 2 = French | 7 = Swedish |
| 3 = Italian | 8 = Finnish |
| 4 = Spanish | 9 = Danish |

13.3.1.8 Zero-point offset (only in the case of absolute shaft encoder)

The zero-point offset or zero offset is used to synchronize the machine's mechanical zero point (datum) with the zero point of an absolute shaft encoder. It makes it possible for the encoder to be fitted in any position and means that the mechanical zero point (datum) of the machine does not have to correspond to that of the encoder.

The programmed zero-point offset value is subtracted by LOCON from the actual encoder value, i.e. if the absolute shaft encoder supplies the value 100 as the position and if a zero-point offset of 10 is programmed, LOCON processes the value as if position 90 had been read in.

If an offset towards higher values is to be made, the value to be offset must be subtracted from the encoder resolution and entered as zero-point offset. In the above example, if position 110 is to be processed and an encoder with 1000 information items/rev is connected, a correction value of 990 (1000-10) would have to be entered.

Since zero-point correction generally occurs at the machine datum in practice, it suffices to enter the displayed position value as the correction value (TEACH-IN).

If LOCON is used with an incremental encoder, zero-point correction is not required.



Note:

To transfer the adjusted value confirm it with **Enter** and finish with **Esc**.

13.3.1.9 Presetvalue (only for Inc)

When it comes to a configuration as incremental cam control "Clear" either results setting back the count to 0, or a setting to a „Preset value“ that was entered before.

This functionality is controlled via the signal "PresetAktiv+" at pin 4 of the connector X4 (for absolute shaft encoder = encoder track 2). In case this pin is set on 0V or not connected, consequently the count is set back to 0. In case this pin is connected with 24V, the count is set to the „Preset value“ at any Clear.

At the status of delivery the "Preset value" equals 0 and can be changed via TERM 24, the integrated front panel of LOCON 24 or WINLOC in the „Initialization menu“ at present.

13.3.1.10 Scaling for speed display

This parameter permits the speed display to be matched to the given application. Scaling in the range 0...9999 revolutions/second is possible.

A value of 60 is preset at the default. This means that the speed in rpm is displayed.

13.3.1.11 Fictitious encoder value (gear factor)

Regardless of the resolution of the encoder actually connected, it is possible to program a "fictitious encoder resolution", thus implementing an electronic transmission. If, for example, an encoder with a real resolution of 360 increments per revolution is used and one complete revolution corresponds to a traverse path of 1,000 mm, a "fictitious revolution" of 1,000 increments must be entered in order to program the cam control in "mm".

Please note that the entry and display are always integer. Floating-point display is not possible. In case of results with a remainder larger than 0.5, the system rounds up to the next number up.

14 Operation via TERM 24

14.1 Fundamentals on TERM 24 and LOCON 24, 48 and 64

(if used as terminal)

A cam control of the LOCON 24, 48 or 64 Series simultaneously provides you with a terminal whose scope of performance corresponds precisely to that of the TERM 24 terminal. This means that you can also use these cam controls for operating other networked Deutschmann units.

The DEUTSCHMANN AUTOMATION product range includes cam controls that can be configured by the customer and cam controls whose configuration must be specified when ordering.

The customer-configurable parameters relate to the following functions (dependent on the particular unit):

- Type of idle time compensation (block-wise, bit-wise, separate switch-on/switch-off idle time)
- Encoder type
- Encoder resolution
- Scaling of the speed display
- Analogue upper range value
- Language

A distinction is made between configuration parameters which define the fundamental mode of operation of the unit and which are normally only defined once and the system parameters (initialisation) which are defined machine-specifically.

Please refer to the description of the connected cam control or the parameter table in chapter "Configuration and initialisation" provided with the relevant unit connected for the precise scope of performance of your unit.

The following sections of this chapter must be noted when programming a cam control of the LOCON and ROTARNOCK series via a TERM 24!

14.2 Main menu TERM 24

You will see the following menu on the liquid-crystal display (LCD) after power-up of the unit:



Display	Significance
I00	Internal cam control (in case of LOCON 24, 48, 64)
X00	Selected axis (0 in the example)
P _A 000	Program 0 of the connected user is the active program (at present being executed)
P 000	Program 0 of the connected user is the selected (but not active) program
L	Connected device. "L" stands for LOCON. The digits stand for the device type in accordance with the list below
L1	LOCON 1
L2	LOCON 2
L7	LOCON 7
L9	LOCON 9
L16	LOCON 16
L17	LOCON 17
L24	LOCON 24
L48	LOCON 48
L64	LOCON 64
L32	LOCON 32, LOCON 32 PM
X32	LOCON 32-4X, LOCON 32-PM-4X
L20	LOCON 2000
R 1	ROTARNOCK 1
R 2	ROTARNOCK 2
R 3	ROTARNOCK 3
MR2	Multiturn-ROTARNOCK

14.2.1 Changing the active program with the keyboard

After you press key **Prog**, you can select a different program using the digit keys or keys **+** **-**.

After pressing **Enter** and answering the following security query, the system switches over to the selected program and this program is immediately executed by the connected cam control.

Change Act.Prog?
ESC=No, ENT=Yes

14.2.2 Axis selection

When you press key **Prog**, you can select a different axis/user with the digit keys or with keys **+** **-**. The data of the selected user is read after you press **Enter**.

14.2.3 General reset

A General reset can be used to reset all programmed cams and idle times and fully reinitialize the connected device.

The general reset is started after you press key **Del** (starting from the main menu).

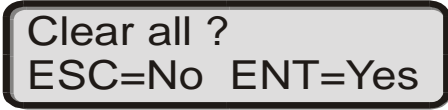

Clear all ?
ESC=No ENT=Yes

You are then prompted to confirm whether you really do wish to carry out a general reset and, if you confirm the prompt appropriately, the unit is reinitialized with the default values, followed by a warm start.

14.2.4 Query software-version

In the main menu the key  has to be pressed.

Consequently the following display turns up:

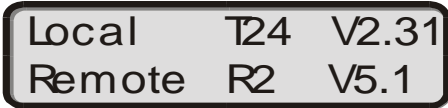

Local T24 V2.31
Remote R2 V5.1



In the first row the information of the „local“ participant is displayed. The second row displays the information of the participant, the terminal is currently connected to. In the above example it is a TERM 24 with the software V2.31 that is connected to a ROTARNOCK (softwareV5.1).

14.3 Programming via TERM 24

You will see the following on the liquid-crystal display (LCD):



X00 L48 PA000
PROGRAMMING









Basically, this menu item is a screen-based editor since all parameters (fields) can be accessed with the cursor keys   and can then be edited.

The following parameters can be edited or entered:

- Program to be edited
- Output to be edited
- Switch-on and switch-off points of the selected program and output
- Idle time compensation of the selected program and output
- Direction-dependent output change

14.3.1 Key definition

Significance of the key functions:

	Abort the function currently being performed
	Terminate the function currently being performed and accept the value
	Increment current value by 1 and transfer directly to the cam control
	Decrement current value by 1 and transfer directly to the cam control
	Accept encoder position as current value
	Clear current parameter/output/program
	Copy output/program to ...
	Backspace

You will see the following display after you choose menu item "PROGRAMMING"



14.3.2 Select program

After you have chosen the Programming menu, the cursor will be positioned at Pxx. The displayed program is the last program processed. If you see symbol P_{xx}, the displayed program is also the executed program. PA blinks constantly. A different program can be selected by entering a new value with the digit keys or "+" or "-". The display changes from P_{xx} to P_{xx}.

After you confirm with , the new program number is accepted and all other entries relate to this new program.

Program entry can be aborted with , the old program number is retained and you return to the main menu.



The selected program number refers only to programming. The "active program" which can be changed in the main menu is still executed.

14.3.3 Copy program

If you wish to copy the program currently selected whilst the cursor is positioned at Program, you should press key .

You are then prompted to enter the program number to which the program is to be copied.

```
PA000 A01 T000 L64
Copy Prg 000 => 000
```

The copy process is started with **Enter** and it can be aborted with **Esc**.

You will see the prompt "Delete program?" if the destination program is not blank.

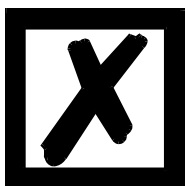

The stored idle times are also copied when copying the program!

14.3.4 Delete program

If you wish to completely delete the currently selected program, you must press key **Del** whilst the cursor is positioned at Program.

```
Clear Program ?
ESC=No, ENT=YES
```

If the following security query will be confirmed with **Enter** a complete deletion of the selected program will be carried out. **Esc** cancels the Delete process.

14.3.5 Select output

The output can be changed by positioning the cursor to Output (Axx).

You can confirm with **Enter** and abort with **Esc**.

14.3.6 Copy output

All cams of an output can be copied to another output with key **Copy**. The cursor must be positioned at Output, and you are prompted to enter the number of the destination output.

```
PA000 O01 I000 L64
Copy Outp.: 01 → 01
```

You will see the prompt "Delete output?" if the destination output is not blank.



The stored idle time is also copied when an output is copied!

14.3.7 Delete output

All cams of an output can be deleted entirely with key **Del** if the cursor is positioned at Output. You are then prompted to confirm whether you really do wish to delete, and you must answer with

Enter = YES (all data of the output is deleted) or

Esc = NO (abort the Delete function).

Clear output?
ESC=No, ENT=Yes

14.3.8 Program-dependent idle times

Various idle times can be programmed for different programs. In order to reduce the programming effort, an idle time programmed in program 0 is considered as the default idle time which applies to all other programs unless it is explicitly programmed with a different value in this program.

If, for example, an idle time of 10 ms is programmed in program 0 at output 1 and an idle time of 20 ms is programmed in program 1 at output 1, the idle time of program 0 applies as the default for all programs; an idle time of 20 ms at output 1 applies only in program 1.



If an idle time has been programmed in program 0, this idle time can be changed in other programs but cannot be deleted.

14.3.9 Change idle time compensation

For this purpose, the cursor must be positioned to the Idle time (Txxx) using the cursor keys, and the idle time can then be changed.

PA00 A01 **T000** L48
┌-----┐ ┌-----┐ X00

The idle time is processed directly (without entering **Enter**), as is the case with all other parameters, provided the currently programmed program also corresponds to the active program and provided the idle time change is made with keys **+** or **-**. That way it is possible to adapt the idle time with the machine operating.

The display changes as follows on units with separate switch-on/switch-off idle time:

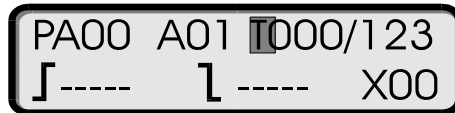

The idle time compensation option (or the option of entering a value) is available only if the connected unit supports this function.



ATTENTION: It is very important that the difference between switch-on idle time and switch-off idle time never exceed one of the times T_{Cam_On} or T_{Cam_off} (see below), as otherwise this may result in an unforeseeable output behaviour!

The cycle time is lower than having a common switch-on- and switch-off idle time (see chapter "Technical details").

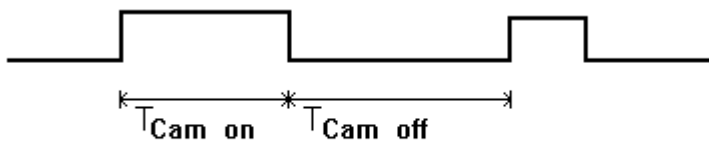









$$|ITC_{on} - ITC_{off}| < I_{cam_off}; |ITC_{on} - ITC_{off}| < I_{cam_on}$$

Picture 10: Switch on- and switch of idle time

14.3.10 Programming switch-on/switch-off points (cams)



After the cursor has been positioned to the Cam switch-on point **┌** field and '-----' is displayed in this field, you can enter the value for the switch-on point using the decimal keypad or with **+** **-**.







If cams are already present, please scroll with   until you see a blank cam array '-----'. After the value is accepted by pressing , you can enter the cam switch-off point  as described above. After this value has also been saved with , you can program further cams in the same way (the number of cams is limited only by the total memory capacity). You can scroll within the cams already programmed with keys  . The current encoder position can also be accepted in Teach-in mode. After the cursor has been positioned in the switch-on or switch-off field, the current encoder position is accepted with .



14.3.11 Adding, deleting or changing switch-on/switch-off points (cams)

If you intend to enter or change cams, you can select the corresponding entry fields with the cursor keys or .

After the switch-on point has been entered, you can accept the value with  and the cursor is then positioned at the Switch-off point. The program remains in this mode even after entering cam so that, if necessary, several cams can be programmed or changed consecutively. You can switch back to the TZK field with the corresponding cursor key or to the output with .

If more than one cam is programmed at an output, these cams can be displayed with keys  or  provided the cursor is located at the Switch-on  or Switch-off field .

Overlapping cams are not combined.

If a cam is to be deleted, the switch-on point must be set equal to the switch-off point or key  must be pressed after positioning the cursor to the Switch-on or Switch-off point. Please scroll with   until you see a blank cam array '-----' in order to program further cams.

The current encoder position can also be changed in Teach-in mode. After positioning the cursor to the Switch-on or Switch-off field, you can accept the current encoder position with .



On no account may two cams with the same switch-on points be programmed at one output!

14.3.12 Programming the direction-dependent output change

On units equipped with the Direction-dependent output change option (Option U), one of the

three values can be set output-by-output:

- Switching in both directions
- Switching only in positive direction
- Switching only in negative direction

On units with this option, you will see the symbol for the switching direction in the bottom line on the display instead of the axis number.

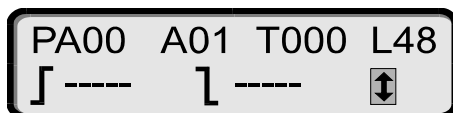

The cursor can be positioned to the symbol with key or . You can choose the required setting with keys and save it with .

Symbol	Meaning
	Switching in both rotational directions
	Switching in negative rotational direction
	Switching in positive rotational direction



Only one direction can be defined per output. Once defined, this applies to all programs.

However, outputs can be switched in parallel (wired-OR)!

14.3.13 Entering angle-time-cam

In case a LOCON 24, 48 or 64 features the option W, the first outputs are intended for entering angle-time-cams.

On these outputs as many cams as desired can be entered as angle-/angle or as angle-time-cams.

The switch-on point is programmed just like angle/angle-cams.

In case the cursor is set on the switch-off point, with the key you can switch between the angle/angle-cam and the angle/time-cam. The symbol switches from 'Switch-off point' to 'ms'. The switch-off time is entered in milliseconds. Values from 1 to 32500 are permissible.

14.3.14 Entering positions for the option analog outputs

If the LOCON 24 / LOCON 48 features the option analog outputs, 2 analog outputs are available. In this case LOCON 48 only has 40 regular outputs available.

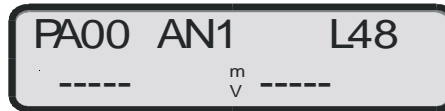

The analog outputs can be selected in the field output. They are represented with AN1 and AN2. The indication in the second line of the display changes as shown in the above picture. The position \diamond is to be entered into the left input field. The analog voltage in mV is to be entered into the right input field.

After the cursor has been positioned onto the position field \diamond and '-----' is displayed in this field, you can enter the value for the switch-on point using the decimal keypad or with **+** **-**.

If positions are already present, please scroll with **↑** **↓** until you see a blank position array '-----'. After the value is accepted by pressing **Enter**, you can enter the analog voltage in mV as described above. After this value has also been saved with **Enter**, you can program further positions with the analog voltage in the same way (the number is limited by the total memory capacity only). You can scroll within the positions already programmed with keys **↑** **↓**.

The current encoder position can also be accepted in Teach-in mode. After the cursor has been positioned in the position field, you can accept the current encoder position with **Teach In**.

The modification, completion and deletion of positions and analog voltage values is carried out analogous to **chapter "Adding, deleting or changing switch-on/switch-off points (cams)" on page 69.**

Example:

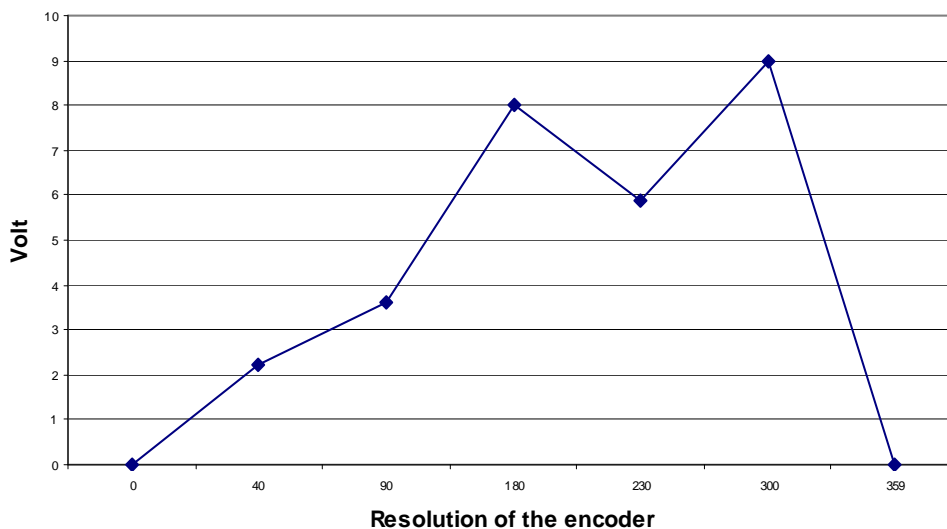

14.3.15 Shift cam track



If **all** cams of one or more outputs are to be shifted, this can be carried out by pressing key  after positioning the cursor to the output field.

```
P00 Move-Cam L48
A01-A01 ⇅ 00000 ⇨
```

You are then prompted to enter how many outputs are to be shifted by how many increments in what direction.

The outputs in which the cam tracks are to be shifted can be selected in fields 'Axx - Axx'.

By default, the last output selected is proposed. The cursor is positioned to the output with .

After entering the outputs to be shifted, you can accept this with . When the cursor is once again positioned at the symbol for cam track shift ⇅, you can define the shift direction with key  or . Depending on the direction selected, you will see a ⇨ for positive shift or ⇩ for negative shift in the bottom line on the display at the right.

The number of increments to be shifted can be entered using the numerical keypad and confirmed with .

14.4 Initialisation

The Initialisation menu can be chosen in the main menu by pressing key  several times.

```
100 L48 PA000
INITIALISATION
```

Accept the chosen menu item with key .

You will see the following menu, dependent on the particular unit:

14.4.1 Analog upper range value (only at LOCON 32)

```
X00 L32 PA000
Analog-End: 0100
```

The value can be changed accordingly with the digit keys. Please refer to chapter "Parameter description" provided with the connected cam control for a description and value ranges for the individual parameters.

14.4.2 Counting range

You will see the next sub-menu item Counting range by pressing key **Enter** or **→**.

```
X00  L32  PA000
Count Range: 08192
```

As already described above, a value can be entered with the digit keys and can be accepted or skipped by pressing key **Enter**.

14.4.3 Zero-point offset

You will see the next sub-menu item Zero-point offset by pressing key **Enter** or **→**:

```
X00  L32  PA000
Zero Pont: 0
```

As already described above, a value can be entered with the digit keys and can be accepted or skipped by pressing key **Enter**.

After this, you will see the following menus when you press **Enter** (without changing a value) or pressing **Enter** twice (and changing a value). The values can be changed in the same way as described above using the digit keys.

14.4.4 Reversal

```
X00  L32  PA000
Rot. of Enc: 0
```

14.4.5 National language

```
X00  L32  PA000
Language: 0
```

Possible languages: 0 = German, 1 = English, 2 = French, 3 = Italian, 4 = Spanish.
For further languages see page 60.

14.4.6 Speed scaling

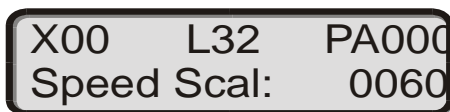

Please refer to the parameter table of the connected cam control for details.

14.4.7 Fictitious encoder value (Gear factor)

Regardless of the resolution of the encoder actually connected, it is possible to program a "fictitious encoder resolution", thus allowing you to implement an electronic transmission. If, for example, you use an encoder with a real resolution of 360 increments per revolution and one full revolution corresponds to a traverse distance of 1,000 mm, you must enter a "fictitious resolution" of 1,000 increments in order to program the cam control in "mm".

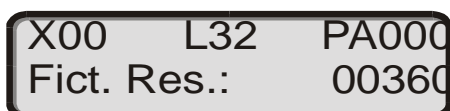

The default value corresponds to the resolution of the encoder connected. When all changes have been made and confirmed, you can quit the menu with **Esc**.



The changed parameters are only accepted by the LOCON when the menu is quit with **Esc**. You can abort the initialisation menu at any time with key **Esc**. Values already changed are accepted. Sub-menu items which are not to be changed can be skipped by pressing keys **Enter**, **→**, **←** once. Please refer to chapter "Parameter description" for the connected cam control for a description and value ranges for the individual parameters.

14.5 Configuration

Starting from the main menu, you can choose the Configuration menu by pressing key **↓** several times.



Should you move one menu item too far, you can return with key **↑** or you can press key **Esc** to move directly back to the main menu.

Pressing key **Enter** accepts the chosen menu item; you can scroll through the parameters with **→** or **←**.

14.5.1 Encoder resolution

You will see the following first item in the Configuration menu:

```
X00   L48   PA000
Resol. Enc:   0360
```

The value can be changed accordingly with the digit keys.

Please refer to chapter "Parameter description" provided with the connected cam control for a description and value ranges for the individual parameters.

The changed value is accepted when you press key .

14.5.2 Type of idle time compensation



You can move to the next menu item by pressing the same key again or pressing .

You will see the following display:

```
X00   L32   PA000
ITC-Typ:   1
```

When all changes have been made and confirmed, you can quit the menu with , whereupon the unit automatically conducts a restart in order to accept the new configuration.

You can abort the Configuration menu any time with key . Values already changed are accepted.

Sub-menu items not to be changed can be skipped by pressing key  or  once. You can move one step back at any time with .



The unit may be configured only by qualified personnel since configuration may completely change its mode of operation. Before configuration, a general reset must be carried out in order to prevent any resultant plausibility errors during the self-test.

14.5.3 DICNET No.

Pressing the same key again or pressing  moves you to the next menu item. You will see the following display:

```
X00   L2   PA000
Basis-ID:   00
```

As already described above, the address of the connected cam control on the DICNET® bus can be changed by entering the new number.

The value is accepted if you confirm with .

14.5.4 Defining the encoder type

Pressing the same key again or pressing  moves you to the next menu item. You will see the following display:

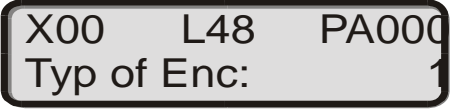

X00 L48 PA000
Typ of Enc: 1

As already described above, the encoder type can be changed by entering the new number. Please refer to the parameter description provided with the connected unit for the values permitted.

The value is accepted when you confirm with .

Pressing  quits the menu.

14.6 Logic functions

16 external hardware outputs of the cam control ('Axx' on the display) and 16 internal outputs (markers; 'M' on the display) can be programmed and assigned a switch-off delay time if necessary (outputs 1..8). Each output and marker may consist of a maximum of any three logic operations (AND, OR, NAND, NOR) and 4 operands. The following operands for the logic functions can be used:

- The 16 external hardware inputs (E01..E16)
- The 16 internal cam outputs (N01..N16)
- The 16 internal markers (M01..M16)
- A 32-bit shift register









The outputs and markers may be inverted. They are displayed on the liquid-crystal display (LCD) by the lower-case letters 'a' or 'm'.

In the state of delivery (no logic programmed), the external outputs are gated with the related internal cam outputs, i. e. the cam control behaves as if no logic were present.

When you call this menu item, you will see the following display on the LCD (if no logic has yet been programmed):









P00 A01 TOFF ↑ =000
=N01









You can make the entry in the individual fields either with keys   or with the decimal keypad. If you make the entry with keys  , you will see a cursor as shown in the illustration above. The value is saved immediately and no longer needs to be confirmed. The next entry field can be accessed with keys  or . You can move back with keys  or .

If you make an entry with the decimal keypad, the cursor changes to an underscore cursor as shown in the illustration below:













In this entry mode, each entry must be confirmed with  or aborted with . You can access the next field with keys  or . You can move one field back with keys  or .

The required program is chosen in the first entry field (P00). Notation 'Paxx' means that the chosen program is also the executed program.

The required output is chosen in the next field (A01). The entry is made on the basis of one of the above-described methods. You can switch over between output ('Axx') and marker ('Mxx') with keys  . You can invert the output ('A' ↔ 'a') or marker ('M' ↔ 'm') with keys . If you press  or , the cursor moves the field Set 'Trigger condition for switch-off delay'. Using  , you can set the required trigger condition (leading or trailing edge). After the cursor has been moved to the next field, you can enter a switch-off delay time. The entry must be made in ms (max. 255 ms). When you press  or , the cursor moves to the next line.







Outputxx at Connector/Marker xx =
 Inputxx/Cam trackxx/Markerxx AND/OR/NAND/NOR Input xx/
 Cam trackxx/Markerxx AND/OR/NAND/NOR
 Inputxx/Cam trackxx/Markerxx AND/OR/NAND/NOR Inputxx/
 Cam trackxx/Markerxx

You can choose between cam track/marker/input with cursor keys   . If you press  , the cursor moves to the field for entering the logic function (explanation of symbols, see table further below). You can choose with keys   . If you press  , the cursor moves abruptly to the next field for the second operand. This selection is also made with  or  and is saved as already described several times above. The other logic functions are created in the same way. After all required logic functions have been created and saved, you can quit the menu by pressing key  several times. The individual fields can also be accessed with keys   .

14.6.1 Logic functions and explanation of the used symbols

The following logic functions are available for selection:

Function	Displayed by symbol
UND AND	
UND_NICHT AND_NOT	
ODER OR	
ODER_NICHT OR_NOT	
Switch-off delay (time) for outputs 1-8 only	TOFF↑ = 000
Output inverted	a
Marker inverted	m
Marker	M
Cam track (nternal output)	N
Output	A
Shft register	S

The following applies in the condition as delivered:

- Ax = Nx
- Mx = Nx

14.6.2 Priorities of the logic operations

Execution is always from left to right. There are no priorities.

In field 'TOFF', it is possible to enter a time from 0 to 255 ms for outputs 1 to 8 and the edge for triggering can be defined, i.e. the output is switched off only after the entered time. The time starts with the selected edge and is restarted (re-triggered) with each trigger condition.

Logic connections, that are made in the program 0 are valid for ALL programs, provided that they are not explicitly overwritten for another program.

If different logic is supposed to be made for different programs, it is advisable not to reserve the program 0.

14.6.3 Operation mode of the shift register

The parameters of the shift register “data, pulse and reset“ are firmly assigned to the upper markers.

Here the following assignment applies:

- M16 = Shift register - Reset, if 1
- M15 = Shift register - Data input
- M14 = Shift register - Pulse (leading edge)

14.6.3.1 Example for the use of a shift register

Referring to bottle manufacturing the finished product has to be analyzed for various criterions. Therefore the bottles are handed over to a rotary table. For the examination they are placed in a mechanically fixed position, in order to be driven past the different inspection equipment. The initialization of the test equipment is carried out through the standard outputs of the cam control. Since it can always happen that no bottle is available when it comes to the supply of the part under test, for instance due to a tailback on the feed belt or when a batch is coming to an end, this would result in an error message of the camera. A possibility to avoid this is to use the shift register integrated in the cam control. It would be, to place an approximating pick-up at any test position and to report the existence of a bottle to the test equipment. In order to realize that possibility, one single approximating pick-up at the intake to the rotary table is required. The information about the existence of a specimen is reported from the approximating pick-up through the input of the cam switch unit to the shift register. Each Bit of the shift register corresponds to taking up one bottle in the rotary table. A binary One in the shift register shows the existence of a bottle, whereas a Zero indicates the lack of a bottle. The Bit, that corresponds to the position of the inspection equipment, is now linked to the output of the cam switch unit with an AND-connection, so that the camera belonging to it will only be triggered, in case a bottle for the inspection is actually available.

14.6.4 Trigger conditions

Symbol	Significance
↑	Leading edge
↓	Trailing edge

14.6.5 Example 1

An example with 3 inputs and a switch-off delay is given below

I00 A01 TOFF ↑ = 123
=N01∧E07∧E16∨E03

In this example, the status of output 1 results as follows:

The programmed cams of track 1 (N01) are first AND-ed with input 7 (E07) and with the negated input 16 (E16) (NAND). After this, this result is OR-ed with input 3 (E03). This state is then output at output 1 until the switch-off delay has elapsed (see illustration).

Max. 1.5 ms may elapse after an input change until output of the result. The input pulses must be at least as long as the cycle time (see Technical Data).



Please note that the programmed switch-off delay time of 123 ms (in this example) which is started with each leading edge ↑ has an even higher priority than the result of the logic operation, i.e. the output remains at 24 V if the delay time has not yet elapsed even if the logic operation would deactivate the output.

14.6.6 Graphical illustration of example 1

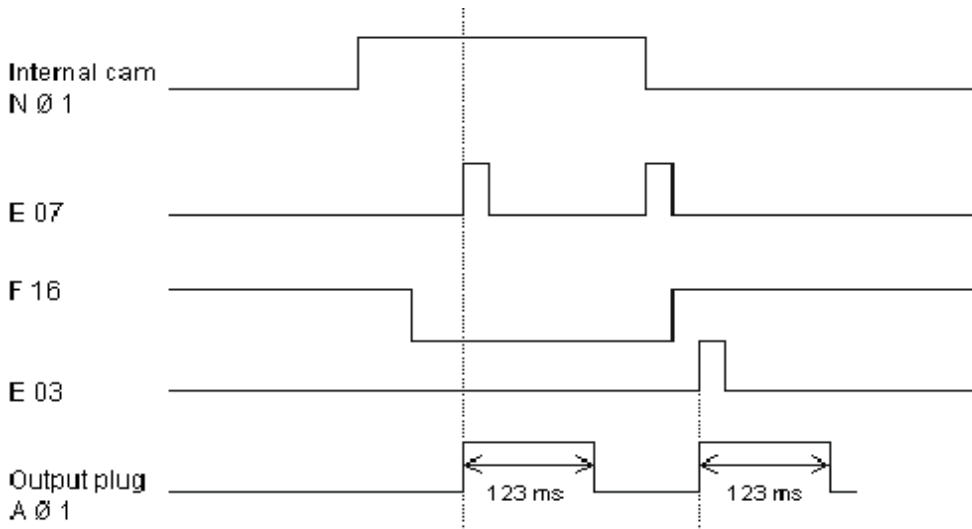

Picture 11: Example, logic operation

14.6.7 Example 2

Here is an example whose result causes output 8 to blink:

```
P00 A08 TOFF↑ =000
= M15
```

```
P00 m15 TOFF↑ =000
= M15
```

14.6.8 Cycle time of the units with logic function

The cycle time of LOCON units with logic function increases by 300 µs + 10 µs per logic operation.



The logic functions can also be programmed with the WINLOC software.

14.7 Locked outputs

In TERM 24 and at LOCON 24 the menu item „locked outputs“ is always presented from the firmware version V. 3.1 (for TERM 24) or V. 4.3 (for LOCON 24), no matter if the connected device features this option or not.

The number of locked outputs can also be changed. The test if this is allowed, only takes place in the connected cam control.

14.8 Function Speed limit value

From the firmware version V. 4.3 on LOCON 24, 48, 64 features the function „Speed limit value“. In the EEROM now there is a new parameter „Speed limit value“ that can be adjusted with TERM 6. This unit corresponds to the unit that is presented as speed, i. e. normally „rev./min.“.

The set in factory of this parameter is 0.

In case this value is changed (unequal 0) and also the logic is active, then a relational operator is activated, that compares the current speed with this limit value and copies it into the flag M13, that means M13 equals 1 in case the current speed exceeds the mentioned limit value. Otherwise M13 = 0.

Now M13 can further be processed in the logic as desired or it can also be directly connected to an output.

15 Basic device TERM 6 (external operating unit)

15.1 Assembly of the instrument

This external control- and display unit consists of a plastic housing with overall dimension W72xH96xD18 mm for front sheet installation and W72xH96xT28 mm for DIN-rail mounting.

It is adjusted for programming cam controls (LOCON, ROTARNOCK) and has the same keys, status LEDs and display possibilities as LOCON.

In this respect the programming is just like LOCON and no additional training is required.

On the 16 LEDs below the seven-segment-display the first 16 outputs of the connected cam controls are displayed with a delay of maximum 500ms.

The connection to the cam control takes place via a serial wire. According to the standard type a RS485-connection (DICNET) and optionally a RS232-connection is supported.

The correct wiring of the instruments among themselves is described in the chapter "Networking terminals with cam controls and PCs".

15.2 View TERM 6



Picture 12: TERM 6

15.3 Technical dimensional drawings

15.3.1 TERM 6

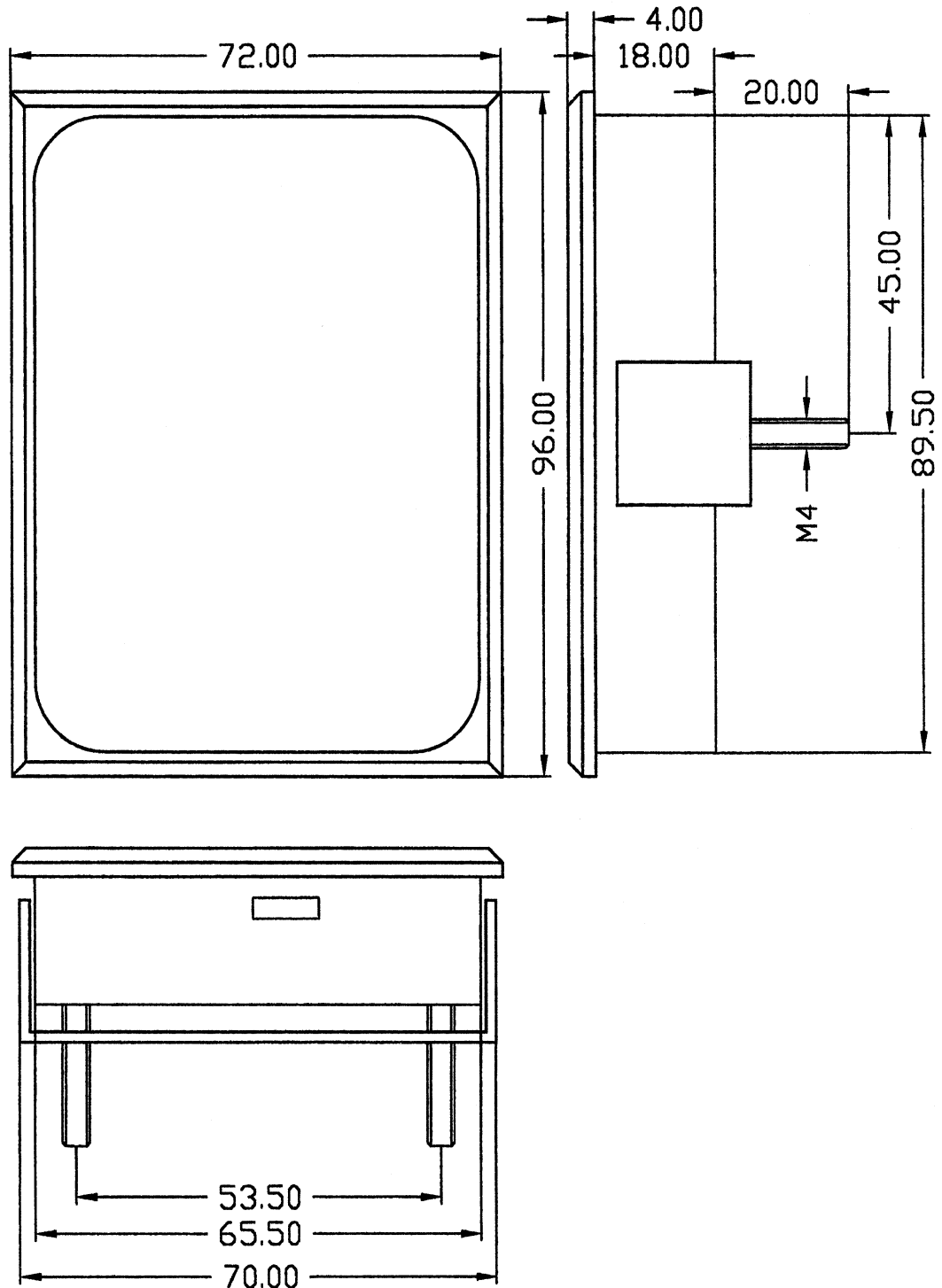

Picture 13: Technical dimensional drawing TERM 6

15.3.2 TERM 6-H

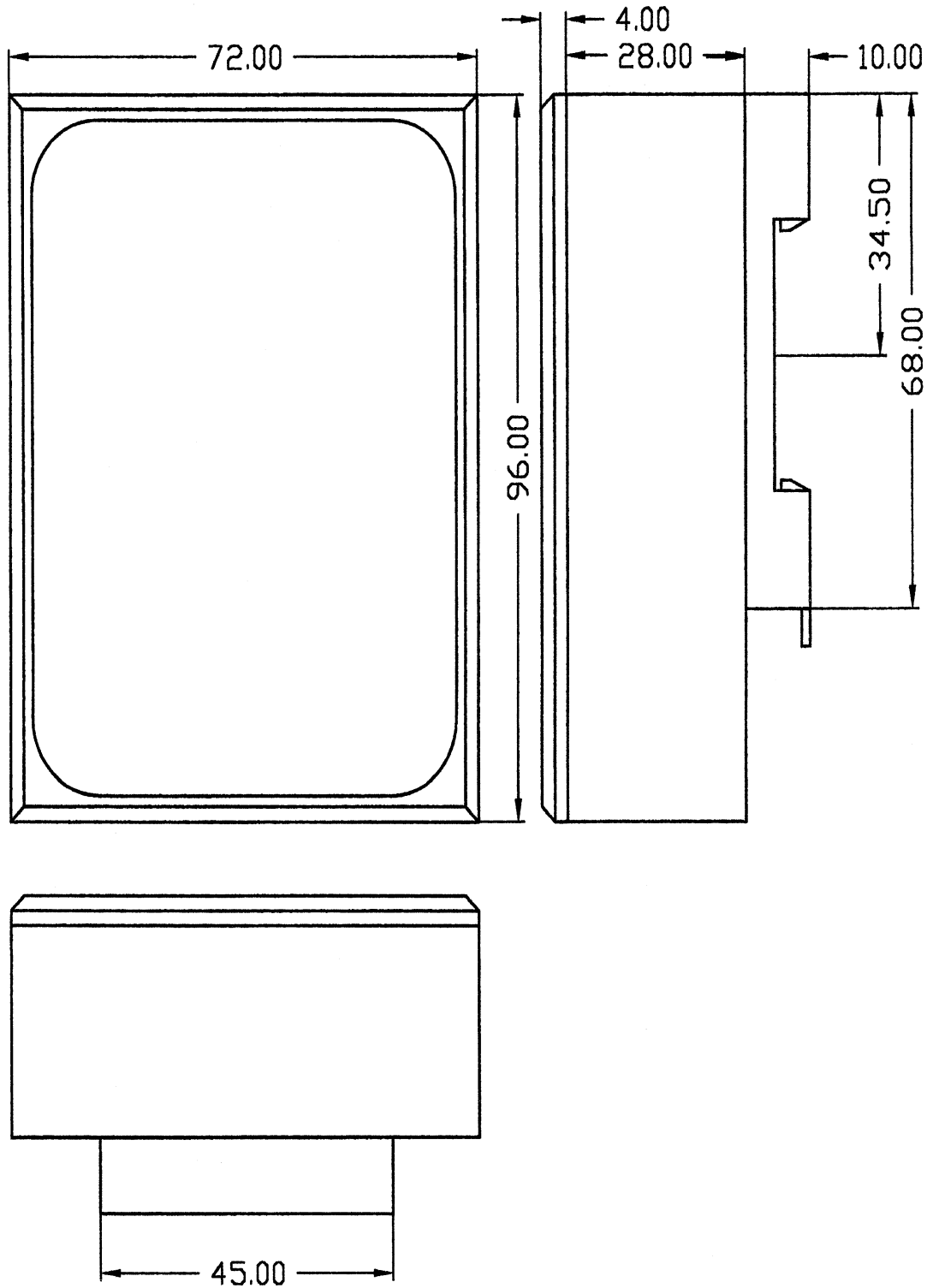

Picture 14: Technical dimensional drawing TERM 6-H

15.3.3 TERM 6-T

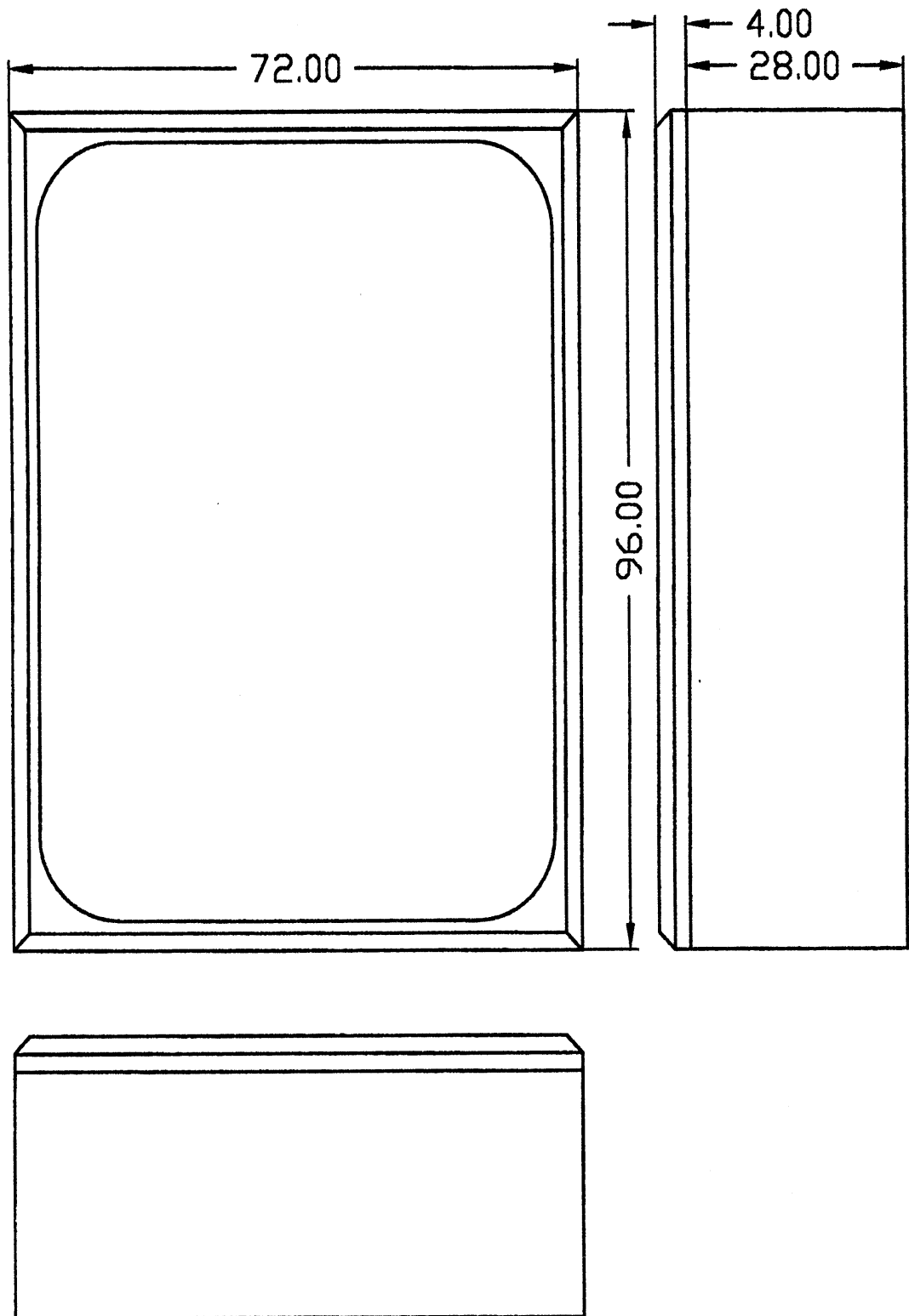

Picture 15: Technical dimensional drawing TERM 6-T

15.4 Pin assignment TERM 6

The external control unit is suitable for connection through a 5-pin-screw-plug-connection with the following assignment:

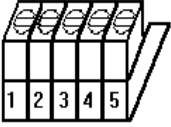

Picture 16: Pin assignment TERM 6

Pin No.	Significance
1	24 Volt DC
2	GND
3	Rx-TERM (DICNET-)
4	Tx-TERM (DICNET+)
5	GND

15.4.1 Interface switch-over

The interface switch is to be found under the sticker with the imprint RS232/RS485. In the state of delivery it is set as indicated on the marking of the sticker. The position of the desired interface can be taken from the sticker at the back of the device. Please use an appropriate tool to change the position of the microswitch to the left or to the right.

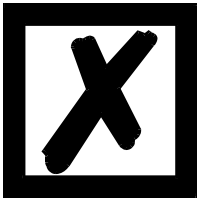

Please note the signal description on the following pages!

15.5 Programming of several devices with TERM 6

TERM 6 is network-capable in the version with DICNET-connection, i. e. up to 16 cam controls (LOCON, ROTARNOCK ...) can be connected with TERM 6 **at the same time** and they can be programmed by it.

The device number of the device TERM 6 is communicating with at the moment appears at the 1. place on the display.

15.5.1 Selecting the device number on TERM 6

TERM 6 always communicates with that LOCON whose device number is indicated at the 1. place of the display in hexadecimal spelling (0 to F, see also table in the annex).

After switching on the unit the device number, which is tuned by the rotary switch (0 to F) at the back, is displayed there.

During service this device number can be changed by the keyboard at any time. In standard mode for this purpose the key **Enter** has to be pressed for at least 3 seconds.

Then the displayed ID begins to flash and can be changed with the help of the keys **+** and **-**. After adjusting the right value, it is confirmed with **Enter** and from this time on TERM 6 communicates with the new selected LOCON, if an instrument with this coding exists in the network.

Should the adjusted value be dismissed and the old ID be restored, this takes place with the key **Esc**. In case there is no control system with the chosen ID in DICNET, it appears the display

" _ _ "

If the TERM 6 features the RS232-interface (option), the 1. place shows the actual program, of the connected cam control.

15.6 Display of the executed program via TERM 6

When connecting a LOCON with the operating and display unit TERM 6 via the RS232-interface, the first place on the left side permanently displays the program that is executed that moment. This only applies to a RS232-TERM 6, as the DICNET-version displays the device number at this place.

15.7 Reading and changing cam control parameters

All cam control parameters that can be reached via the communication profile with GET/SET-PARAMETER can be read and changed via a "menu point" that is integrated in TERM 6.

Starting from the main menu the keys **+** and **-** are pressed for the same time period. Thereupon the function LED shines and a 1 (current parameter number) appears on the display.

Now this number can be changed with **+** and **-**.

If, for instance, the encoder resolution is to be read / changed, please select (see parameter table in the manual communication profile) the number 17 (corresponds to 11H = PNR_RESOLUTION_PER_TURN). Confirm with **Enter** and the encoder resolution of the connected cam control is displayed (e. g. 1000). If you want to change this value, please press **Enter** again (long) and then the Prog-LED starts to flash. Now the value can be changed with **+** or **-**. Then by pressing **Enter** the new value is loaded into the cam control, the value is rejected with **Esc**. An error message appears if the cam control does not allow a change of this parameter. An error message also appears (Error 36), if a not existing parameter is supposed to be read. Special parameters in X-options can also be handled as described in this chapter.

15.8 Programming angle-time-cams via TERM 6

From the firmware T6V1-32.HEX of TERM 6 on, it is also possible to program angle-time-cams. The angle-time-cams are presented by the LED „Function“, which shines in addition to the LED „Off“ when the switch-off time is presented. When a switch-off point is presented, only the LED „Off“ is shining.

The switch-over between these two modes takes place when the switch-off point/time is programmed with the key **Enter**.

This is only possible when a cam is reprogrammed and no switch-off value has been entered then.

Angle-time cams can be deleted by entering 0 as switch-on time.

In case a switch-over is tried with a device that does not support angle-time-cams, the error 37 is displayed.

16 Technical details

16.1 Technical data TERM 24

Characters	TERM 24-IP54	TERM 24-IP65
Type of equipment	✓ Display and control unit	✓ Display and control unit
Connection to	✓ All Deutschmann cam controls with open communication profile	✓ All Deutschmann cam controls with open communication profile
Display	✓ 10 digit 7 section display; from them 5 digits for encoder position 4 digits for rotational speed 8 digits Pos. at MT	✓ 10 digit 7 section display; from them 5 digits for encoder position 4 digits for rotational speed 8 digits Pos. at MT
LCD-Display	✓ LCD-Display 2 lines with LED-back-ground lighting; 16 characters/line ✓ Menu multilingual	✓ LCD-Display 2 lines with LED-back-ground lighting; 16 characters/line ✓ Menu multilingual
Interface	✓ RS 485 DICNET - max. 3 Deutschmann terminals in one bus ■ RS232 (V.24)	✓ RS 485 DICNET - max. 3 Deutschmann Control-Units in one Network possible ■ RS232 (V.24)
Function-LED	✓ Output display	✓ Output display
Connection	✓ Screw-plug-connector	✓ Screw-plug-connector
Installation	✓ Frontpanel installation	✓ Frontpanel installation
Type of protection	✓ IP54	✓ IP65
Dimensions	✓ 144 x 144 x 15 mm (WxHxD)	✓ 168 x 168 x 15 mm (WxHxD)
Switchgear opening	✓ 138 ⁺¹ x 138 ⁺¹ mm	✓ 138 ⁺¹ x 138 ⁺¹ mm

✓ Standard

■ Optional without extra charge

16.2 Technical data LOCON 24

Characters	Basic equipment	Options
Operating Voltage	✓ 24 Volt DC ±20%, max. 0,2A (switched off)	
Data protection	✓ EEPROM (at least 100 years); no battery	<input type="checkbox"/> Via transfer-program on PC
Programs	✓ 64	
Number of Cams	✓ 1000 cams, optionally distributable to channels and programs; cams are interchangeable linewise	<input type="checkbox"/> 1500 cams, optionally distributable to channels and programs; <input type="checkbox"/> Angle-/time-cam
Zero-point offset	✓ Programmable over the entire range	
Position recording	✓ Absolute encoder Gray-code parallel 24 V; to 13 Bit (2 ... 8192), Gray-code 360, 720, 1000, 3600 and 7200 inf./rev. ✓ Programmable reverse direction of rotation	<input type="checkbox"/> Incremental encoder, counting area up to 16384, optional A/B-or count-/direction-signal SSI-encoder up to 13 Bit (2 ... 16384) <input type="checkbox"/> Encoder monitoring function <input type="checkbox"/> MT: Inc. counting area up to 16777216 SSI up to 24 Bit
Outputs	✓ 48, short-circuit proof, 24 Volt/0,3A, (max. 1A/8 Outputs), plus-switching	<input type="checkbox"/> Floating Run-control <input type="checkbox"/> Lockable outputs <input type="checkbox"/> Output change - dependent on the direction of rotation
Inputs	✓ 13 inputs for encoder signals ✓ 6 inputs for channel selection ✓ 1 input program change ✓ 1 input program release	<input type="checkbox"/> 16 inputs for logic-connection (cycle time increases by 300µs + 10µs per connection)
Idle time compensation (ITC)	✓ 0 ... 999ms blockwise	<input type="checkbox"/> 0 ... 999ms blockwise or bitwise <input type="checkbox"/> Separate switch-on and switch-off delay at blockwise ITC <input type="checkbox"/> Highly-dynamical ITC
Cycle time	✓ 75µs (without ITC) ✓ 150µs (with blockwise ITC) ✓ 300µs (with bitwise ITC) ✓ 350µs (with separate switch-on/switch-off ITC)	<input type="checkbox"/> At MT: 950µs + 12µs/cam
Programming	✓ Via integrated operating panel with LCD-display with LED-background lighting ✓ Menu multilingual ✓ Teach-In	<input type="checkbox"/> With external control unit TERM 6, 24, 32 <input type="checkbox"/> Offline/online via PC <input type="checkbox"/> Via open communication profile
Display	✓ Encoder position and speed (7 section display) ✓ Output display via LED ✓ Speed display scalable ✓ Gear factor	
Interface	✓ RS485 DICNET-network for up to 16 axis ✓ RS232 (switchable)	
Connection	✓ Via screw-plug-connector	
Installation	✓ Frontplate installation	<input type="checkbox"/> PM-version (without operation front) for DIN-rail mounting
Type of protection	✓ IP54	<input type="checkbox"/> IP65
Dimensions	✓ 144 x 144 x 44 mm(WxHxD)	<input type="checkbox"/> 168 x 168 x 44 mm (WxHxD)
Switchgear opening	✓ 138 x 138 mm (WxH) (DIN 43700)	<input type="checkbox"/> 138 x 138 mm (WxH) (DIN 43700)

16.3 Technical data LOCON 48

Characters	Basic equipment	Options
Operating Voltage	✓ 24 Volt DC ±20%, max. 0,2A (switched off)	
Data protection	✓ EEPROM (at least 100 years); no battery	<input type="checkbox"/> Via transfer-program on PC
Programs	✓ 64	
Number of Cams	✓ 1000 cams, optionally distributable to channels and programs; cams are interchangeable linewise	<input type="checkbox"/> 1500 cams, optionally distributable to channels and programs; <input type="checkbox"/> Angle-/time-cam
Zero-point offset	✓ Programmable over the entire range	
Position recording	✓ Absolute encoder Gray-code parallel 24 V; to 13 Bit (2 ... 8192), Gray-code 360, 720, 1000, 3600 and 7200 inf./rev. ✓ Programmable reverse direction of rotation	<input type="checkbox"/> Incremental encoder, counting area up to 8192, optional A/B-or count-/direction-signal SSI-encoder up to 13 Bit (2 ... 8192) <input type="checkbox"/> Encoder monitoring function <input type="checkbox"/> MT: Inc. counting area up to 16777216 SSI up to 24 Bit
Outputs	✓ 24, short-circuit proof, 24 Volt/0,3A, (max. 1A/8 Outputs), plus-switching	<input type="checkbox"/> Floating Run-control <input type="checkbox"/> Lockable outputs <input type="checkbox"/> Output change - dependent on the direction of rotation
Inputs	✓ 13 inputs for encoder signals ✓ 6 inputs for channel selection ✓ 1 input program change ✓ 1 input program release	<input type="checkbox"/> 16 inputs for logic-connection (cycle time increases by 300µs + 10µs per connection)
Idle time compensation (ITC)	✓ 0 ... 999ms blockwise	<input type="checkbox"/> 0 ... 999ms blockwise or bitwise <input type="checkbox"/> Separate switch-on and switch-off delay at blockwise ITC
Cycle time	✓ 100µs (without ITC) ✓ 200µs (with blockwise ITC) ✓ 500µs (with bitwise ITC) ✓ 400µs (with separate switch-on/switch-off ITC)	<input type="checkbox"/> At MT: 950µs + 12µs/cam
Programming	✓ Via integrated operating panel with LCD-display with LED-background lighting ✓ Menu multilingual ✓ Teach-In	<input type="checkbox"/> With external control unit TERM 6, 24, 32 <input type="checkbox"/> Offline/online via PC <input type="checkbox"/> Via open communication profile
Display	✓ Encoder position and speed (7 section display) ✓ Output display via LED ✓ Speed display scalable ✓ Gear factor	
Interface	✓ RS485 DICNET-network for up to 16 axis ✓ RS232 (switchable)	
Connection	✓ Via screw-plug-connector	
Installation	✓ Frontplate installation	<input type="checkbox"/> PM-version (without operation front) for DIN-rail mounting
Type of protection	✓ IP54	<input type="checkbox"/> IP65
Dimensions	✓ 144 x 144 x 44 mm (WxHxD)	<input type="checkbox"/> 168 x 168 x 44 mm (WxHxD)
Switchgear opening	✓ 138 x 138 mm (WxH) (DIN 43700)	<input type="checkbox"/> 138 x 138 mm (WxH) (DIN 43700)

16.4 Technical data LOCON 64

Characters	Basic equipment	Options
Operating Voltage	✓ 24 Volt DC ±20%, max. 0,2A (switched off)	
Data protection	✓ EEPROM (at least 100 years); no battery	<input type="checkbox"/> Via transfer-program on PC
Programs	✓ 64	
Number of Cams	✓ 1000 cams, optionally distributable to channels and programs; cams are interchangeable linewise	<input type="checkbox"/> 1500 cams, optionally distributable to channels and programs; <input type="checkbox"/> Angle-/time-cam
Zero-point offset	✓ Programmable over the entire range	
Position recording	✓ Absolute encoder Gray-code parallel 24 V; to 13 Bit (2 ... 8192), Gray-code 360, 720, 1000, 3600 and 7200 inf./rev. ✓ Programmable reverse direction of rotation	<input type="checkbox"/> Incremental encoder, counting area up to 8192, optional A/B-or count-/direction-signal SSI-encoder up to 13 Bit (2 ... 8192) <input type="checkbox"/> Encoder monitoring function <input type="checkbox"/> MT: Inc. counting area up to 16777216 SSI up to 24 Bit
Outputs	✓ 24, short-circuit proof, 24 Volt/0,3A, (max. 1A/8 Outputs), plus-switching	<input type="checkbox"/> Floating Run-control <input type="checkbox"/> Lockable outputs <input type="checkbox"/> Output change - dependent on the direction of rotation
Inputs	✓ 13 inputs for encoder signals ✓ 6 inputs for channel selection ✓ 1 input program change ✓ 1 input program release	
Idle time compensation (ITC)	✓ 0 ... 999ms blockwise	<input type="checkbox"/> 0 ... 999ms blockwise or bitwise <input type="checkbox"/> Separate switch-on and switch-off delay at blockwise ITC
Cycle time	✓ 150µs (without ITC) ✓ 250µs (with blockwise ITC) ✓ 600µs (with bitwise ITC) ✓ 500µs (with separate switch-on/switch-off ITC)	<input type="checkbox"/> At MT: 950µs + 12µs/cam
Programming	✓ Via integrated operating panel with LCD-display with LED-background lighting ✓ Menu multilingual ✓ Teach-In	<input type="checkbox"/> With external control unit TERM 6, 24, 32 <input type="checkbox"/> Offline/online via PC <input type="checkbox"/> Via open communication profile
Display	✓ Encoder position and speed (7 section display) ✓ Output display via LED ✓ Speed display scalable ✓ Gear factor	
Interface	✓ RS485 DICNET-network for up to 16 axis ✓ RS232 (switchable)	
Connection	✓ Via screw-plug-connector	
Installation	✓ Frontplate installation	<input type="checkbox"/> PM-version (without operation front) for DIN-rail mounting
Type of protection	✓ IP54	<input type="checkbox"/> IP65
Dimensions	✓ 144 x 144 x 44 mm(WxHxD)	<input type="checkbox"/> 168 x 168 x 44 mm (WxHxD)
Switchgear opening	✓ 138 x 138 mm (WxH) (DIN 43700)	<input type="checkbox"/> 138 x 138 mm (WxH) (DIN 43700)

16.5 LOCON 24, LOCON 48 and LOCON 64 memory expansion

LOCON 24, 48 and 64 are available with the following memory expansion configuration:

Memory size	Number of data records
8 kByte	1000 data records
12 kByte	1500 data records

8 bytes are required for each data record. The remaining data records are required by the firm-ware.

Data record memory usage:

Type	Usage
1 cam	1 data record
1 idle time	1 data record
1 logic record	1 data record
1 output name (max. 30 characters)	5 data records (6 characters/data record)

16.6 Specification of the input levels

Logical HIGH: > 16 V < 10 mA (typically 5 mA)

Logical LOW: < 4 V < 1 mA

16.7 Specification of the output drivers

The outputs used in the LOCON are short-circuit-proof and can drive maximum 300 mA per output at normal ambient temperature, whereby 8 interrelated outputs of a driver (1..8, 9..16, 17..24, 25..32, 33..40, 41..48, 49..56, 57..64) may be loaded with maximum 1 A.

If more than 300 mA is required per output, it is possible to interconnect several outputs (up to 3 outputs per driver), in which case the maximum load is 900 mA.

If several outputs are interconnected, the switch-on and switch-off points in the LOCON must be programmed absolutely identically since, otherwise, the short-circuit monitor does not respond.

In the event of a sustained short circuit or an overload, the corresponding outputs are deactivated and a corresponding error message is shown on the display.

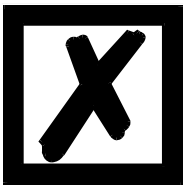

When switching inductances (coils, valves) free-running diodes are to be placed directly at the inductances (see chapter "EMC Directives for products of DEUTSCHMANN AUTOMATION" on page 13).

16.8 Switching accuracy of the Deutschmann cam controls

The accuracy of cam controls is influenced by four parameters:

1) Switching delay (SV)

This time is constant and results from the computing time required by the cam control from read-in of the encoder value to setting the output driver.

2) Repeat accuracy (WG)

This tolerance band results from asynchronous sampling of the encoder. Ideally, the encoder is scanned directly after a change. Under worst-case condition, the encoder value changes directly after read-out of the cam control.

3) Resolution

This value indicates how long the shortest cam which can still definitely be evaluated by the cam control is.

4) Idle time resolution (TZA)

This error occurs only if an idle time is programmed for the corresponding output. It is specified in ms and represents the sampling time of the encoder speed, serving as the basis of TZK (idle time compensation).

In general, the SV and WG are each shorter than the cycle time of the cam control. This means that the actual switch point lies between instants "Switch-on time + SV" and "Switch-on time + SV + WG", as indicated in the diagram below.

Without idle time compensation, the resolution is 1 increment, provided the maximum encoder speed is not exceeded, i.e. even a cam with a length of 1 increment is still reliably detected and set by the cam control.

If the encoder speed (V_{encoder}) is exceeded n-fold, the resolution increases accordingly to n increments.

If you work **with** idle time compensation, the error merely increases by 1 increment since the correction of the TZK is maximum ± 1 increment with each change of the encoder position owing to the "dynamic brake" implemented in LOCON.

To summarize, we can state the following formula:

Without idle time compensation:

Actual switch point = ideal switch point + SV (const) + WG

SV < cycle time (constant, typically cycle time/2)

WG < cycle time (fluctuating between 0 and cycle time)

Resolution = n increments with $V_{\text{encoder}} < n * V_{\text{encoderMax}}$

With idle time compensation:

Actual switch point = ideal switch point + SV (const) + WG + TZA

SV < cycle time (constant, typically cycle time/2)

WG < cycle time (fluctuating between 0 and cycle time)

TZA = Resolution of the TZK (typically 1 ms)

Resolution = n increments, with $V_{\text{encoder}} < n * V_{\text{encoderMax}}$, whereby V_{encoder} const.

Resolution = n+1 increments, with $V_{\text{encoder}} < n * V_{\text{encoderMax}}$, whereby V_{encoder} variable.

16.8.1 Timing diagram

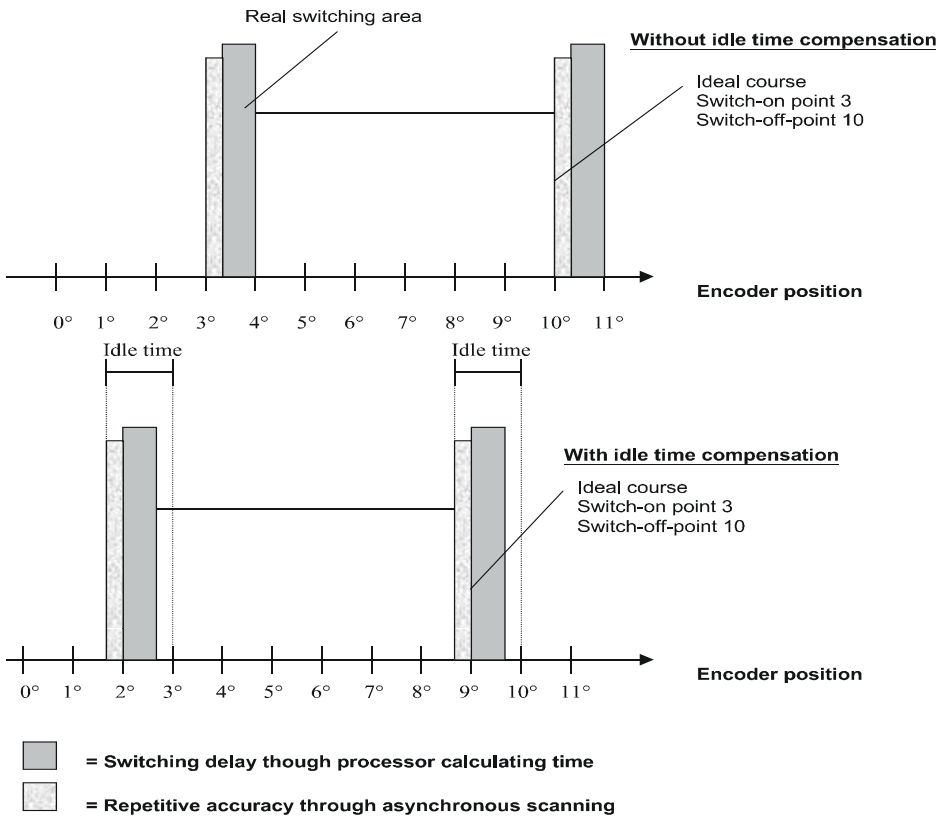

Picture 17: Timing diagram - idle time compensation

16.9 Function of the idle-time compensation

All mechanical circuit components which are usually connected to a cam control (e.g.: flood-gates, magnetic valves...) feature idle-time that means, between accessing the circuit component and the mechanical reflex lies a constant time, the idle-time.

The compensation of this idle-time depends on the speed of the cam control.

The following processes of idle-time compensation are possible:

- path-dependent idle-time compensation (standard process in every Deutschmann cam control)
- time-controlled idle-time compensation
- direct idle-time compensation (without dynamics brake)

Each of the above-mentioned methods has advantages and disadvantages and is suitable better or worse for a defaulted application.

All methods have in common, that the required idle-time value is determined again in every cycle of the cam control in dependence of the current speed. In this case, the required idle-time value indicates for how many increments the outputs must be activated earlier in order to compensate the idle-time of the connected circuit component.

If the machine - at which the cam control is operated - is in an acceleration stage, the current computed required idle-time value deviates from the actual idle-time value. In this case, the difference between actual and required value only depends on the acceleration. The following methods now differ in the kind and manner when and how the actual idle-time value is changed.

16.9.1 Path-dependent idle-time compensation

With this method the actual idle-time value is adapted for maximal ± 1 increment during every item modification. By that it is guaranteed that no cams are skipped over during the acceleration stage of the machine and that during the braking phase no double cams (see time-controlled dead-time compensation) occur. The worse dynamics is disadvantageous in the case of this procedure and therefore combined the fact, that with a brake application, that is more rapid as the adjusted idle-time, the outputs are frozen on a wrong value in the standstill, as only during a machine movement as well as an item modification a change of the idle-time actual value is allowed.

16.9.2 Time-controlled idle-time compensation

With this method the actual idle-time value is adapted for maximal ± 1 increment in every cycle of the cam control. By that it is guaranteed that no cams are skipped over during the acceleration stage of the machine, but double cams can occur during the braking phase; that means if a complete cam is between the actual encoder position and the encoder position which was slipped by the idle-time compensation, the cam appears twice at the output.

16.9.3 Direct time-controlled idle-time compensation

With this method, the required idle-time value is undertaken in every cycle as an actual idle-time value. Because of this a very high dynamics is achieved but cams can be skipped over during the acceleration and during braking double cams can occur.

16.9.4 Optimization of dynamics

In order to achieve an adaptation of the cam shift to a changed speed (high dynamics) as fast as possible, the cam tracks which are idle-time compensated should be placed onto the first outputs (independent of the chosen method of idle-time compensation), as - system-dependently - the **last** compensated output determined the cycle time of the idle-time calculation. In this case, the cycle time corresponds to the last compensated output in mS. If the outputs 10,12,14,15 are idle-time compensated for example, it results an idle-time compensation - cycle time of 15 mS. But if these 4 cam tracks are programmed on the outputs 1..4, a cycle time of 4 mS is achieved.

16.10 Environmental specifications of cam controls of the LOCON series

Storage temperature:	-25°C.. + 70°C
Operating temperature:	0°C .. 45°C (without forced convection) 0°C .. 65°C (with forced convection)
Relative humidity:	max. 80% no condensation, no corrosive atmosphere
Enclosure:	IP 20 (in the case of front-panel installation IP 54 from the front)
Shock:	15 G / 11 ms
Vibration:	0.15 mm / 10..50 Hz, 1G / 50..150 Hz
Weight:	LOCON 24, 48, 64, depending on version, 650 to 900 g

16.11 DICNET®

DICNET® (**DEUTSCHMANN Industrial Controller Net**) is a multi-master-field bus whose physical layer complies with the ISO-OSI Layer Model of DIN 19245, Part 1, i. e. a connection is established between all users in the network with one RS485 two-wire line.

The physical arrangement is thus a bus system on which the users can be connected and disconnected as required.

Logically, the system comprises a Token Ring, i. e. only the user granted bus access authorization (Token) may send on the bus. If this user has no data for another user, it forwards the token to its neighbor which was determined in a configuration phase.

This principle achieves a deterministic bus cycle time, i.e. the time (worst-case) until a data packet can be sent can be computed precisely.

Automatic reconfiguration occurs when a user is connected or disconnected.

The transmission baud rate is 312.5 kbaud with a length of 11 bits/byte. A maximum of 127 users may be operated on one bus, whereby data packets of maximum 14 bytes per cycle can be sent. An automatic check of the received information is conducted and an error message is issued should a transmission error occur twice.

The maximum extent of the network may not exceed 500 m.

In order to avoid transmission errors, it must be ensured that both ends of the bus are terminated correctly.

TERM 24 features a bus termination resistor as standard. The bus termination on units LOCON 24, 48 and 64 can be wired via pins R+/R-.

16.12 Communication interface

DEUTSCHMANN AUTOMATION encourages the use of cam controls with remote control and display unit in order to meet market requirements.

Since different combinations of cam control and terminal have been required repeatedly, specific to the particular application, it has been necessary to define a standard interface (communication profile) supported by all terminals and cam controls from the DEUTSCHMANN AUTOMATION range.

This makes it possible for each user to select the most suitable combination for his application. Through this it is also possible to make the LOCON capable for fieldbuses with Deutschmann UNIGATES (Profibus, Interbus, CANopen, Ethernet, ...).

By making the communication profile an open profile, this means that the user also has the option of communicating with DEUTSCHMANN cam controls and thus using existing information (encoder position, speed, ...) for his own applications or operating the cam control via his own terminal.

On request, we are able to supply information on this interface in the form of Manual "Communication profile for DEUTSCHMANN AUTOMATION cam controls".

16.13 Coding device numbers

The device number is set in hexadecimal code on the rotary switch.
The following assignment applies:

Display	Device number	Binary coding			
		8	4	2	1
0	0	0	0	0	0
1	1	0	0	0	1
2	2	0	0	1	0
3	3	0	0	1	1
4	4	0	1	0	0
5	5	0	1	0	1
6	6	0	1	1	0
7	7	0	1	1	1
8	8	1	0	0	0
9	9	1	0	0	1
A	10	1	0	1	0
B	11	1	0	1	1
C	12	1	1	0	0
D	13	1	1	0	1
E	14	1	1	1	0
F	15	1	1	1	1

17 Error messages

A LOCON error message can be seen from the fact that an error code is shown on the display and the „Error-LED“ at the rear side flashes.

In addition, the optional Run-Control relay drops out if a serious error (1..19, 31, 100..255) has occurred.

All errors must be acknowledged with  .

A distinction can be made between the following error types:

17.1 Error number 1..19 (irrecoverable error)

These errors are errors occurring during the self-test routine. If one of the errors 1 to 19 occurs, the unit must be returned to the manufacturer. When returning the unit, please provide the information specified in chapter 'Returning a unit'.

17.2 Error number 20..99 (warning)

The cam control continues running in the background in the case of all errors of this chapter, i.e. the outputs are still updated as a function of the encoder value in the specified cycle time.

Error No.	Significance	Remarks
20:	Error writing to EEPROM	
21:	Error saving zero-point offset	
22:	Error saving a cam value	
23:	Error deleting a data record	
24:	Error deleting a program parameter	Parameters can be deleted only in program 0
25:	Error copying a program Error shifting a cam track	
26	Timeout accessing LCD	Acknowledge error. If the error occurs again, the unit must be returned specifying the information described in chapter 'Returning a unit'.
27	Error saving a pattern value	
28	Error programming an idle time	Only in the case of pattern units
29	Error in function CLEAR_CAM	X97 only
30	No programming enable	The program can be modified only if signal "Prog-Freigabe" (Program Enable) is at 24 V on the connector or if parameter "Lockable outputs" is set appropriately (see chapter "Program enable")
31	Overload switch-off of the output driver	The output drivers are short-circuit-proof. If LOCON or ROTARNOCK senses an overcurrent for a long period (under certain circumstances, also in the case of incandescent lamps with high power rating), this error message is issued. The corresponding output load must then be reduced and after that the error then be acknowledged. Only the overloaded output is switched off. The other outputs continue to operate.

32	EEPROM full	All data records in the EEPROM are used. Either you must remove cams no longer required or the unit must be equipped with a higher-capacity memory card (LOCON 32 only).
33	Duplicate switch-on point	An attempt has been made to program two cams with the same switch-on point at an output (cam track).
34	Error programming a partial idle time compensation	Unit does not feature the 'Y' partial idle time compensation option
35	Illegal encoder resolution, no power of 2	Program a valid value
36	An attempt has been made to activate the protocol function but no 16k memory card is fitted (LOCON 32 only)	Insert 16k memory card
37	Reserved	
38	Error programming an idle time	On LOCON 17 only - idle times are permitted only for outputs 1 to 8
39	ERROR NO TZK No TZK possible	e.g. LOCON 7
40	DICNET® - transmit error Duplicate error on transmit	Duplicate error on transmit
41	DICNET® - receive error	Duplicate error on receive
42	DICNET® - ID error	There is already a user with the same device number (GNR) in the network or the network line is faulty (missing bus termination, line discontinuity or non-twisted lines).
43	DICNET® bus error	
44	Overflow of the serial receive buffer	
45		External fault signal (X26 only)
46	Save blank cam	Data record incomplete
47		Direction-dependent output update illegal
50		Outputs deactivated (Brake cam option only)



All outputs are switched briefly to 0 V when error 31 is acknowledged.

17.3 Error number 100..199 (serious error)

All outputs are switched to 0 V until the error has been remedied in the case of errors from this chapter since it is no longer feasible to set the outputs.

Error No.	Significance	Remarks
100	Error in Gray code	The (clipped) Gray code read in by the encoder is checked for plausibility in each cycle. If an illegal code is detected, this error message is issued. If the error occurs only occasionally, this probably involves a fault on the encoder line, and this fault can be remedied by improved cable shielding or different cable routing. Should the error be repeated frequently or be pending constantly, the encoder and the encoder line must be checked and exchanged if necessary. If the error still persists, the unit must be returned (see chapter 'Returning a unit').
101	Checksum error on the memory card or in EEPROM	If a checksum error on the memory card or in the EEPROM is detected on power-up, you will see the corresponding error message. After acknowledgement by the user, the memory is written with the default configuration data and all user data is deleted. You then have the option of reprogramming or, if the old data has been backed up on a PC, of reloading this data.
102	Error initializing the cam array	Illegal cams detected. Carry out a general reset
103	New memory card	
104	Plausibility error (illegal device configuration)	A device configuration which is illegal has been saved (e.g. absolute encoder with 127 increments resolution). Carry out a general reset
105	Encoder error (only in the case of "Special configuration" LOCON 32 option or LOCON 24, 48, 64 units with encoder monitoring option)	An encoder error has been detected. The current encoder value and the last encoder value read in are shown at the top right on the LCD (LOCON 32). LOCON 24, 48, 64, see chapter Options: Encoder monitoring.
107	DSI Timeout error	
108	SSI Timeout error	
111	SSI Gray code error	

17.4 Error number 200-299 (terminal error)

The following errors occur only on terminals (or if using cam controls of the LOCON 24, 48, 64 Series as a terminal).

Error No.	Significance	Remarks
201	Self-test error	
202	Internal error	
206	Error initializing the RS485 interface	
207	RS232 error	
210	RX overflow error	
211	TX overflow error	
212	TX change ID error	
213	Timeout accessing LCD	Acknowledge the error. If the error occurs again, the unit must be returned, specifying the information described in chapter 'Returning a unit'
214	Undefined field error	
215	Get key error	
216	LCD XY error	
220	Timeout connecting to cam control	
221	Incorrect data record on transmission to cam control	
222	Checksum error on reception from cam control	
223	Checksum error on transmission to cam control	
224	Unknown command on transmission to cam control	
230	Incorrect configuration data record or not possible to configure the cam control	
231	Incorrect initialisation data record	
240	DICNET® transmit error	
241	DICNET® receive error	
242	Duplicate device number in DIC-NET® or connection problems	Assign a different device number. Check for cable discontinuity, short circuit, non-twisted cable....
243	Too many terminals in network (max. 3 allowed)	Reduce to 3 terminals
244	Max. 1 external terminal in the case of multiple-axis version of the LOCON 32	
251	Internal error	
252	CMD UNKNOWN ERROR	
253	CMD CHECKSUM ERROR	

18 Order Code

18.1 TERM 24 terminal

Designation	Explanation
TERM 24-RS485	Terminal with RS485 DICNET®-interface
TERM 24-RS232	Terminal with RS232-interface

18.2 LOCON 24, 48 and 64 cam controls

18.2.1 Explanation of the order designation

The order designation for the LOCON 24, 48 and 64 cam controls comprises

- Device type, e.g. LOCON 24
- Encoder type, e.g. O
- Encoder resolution, e.g. 360
- Software options, interface, e.g. I
- Interface, e.g. RS485 (if there is a software option with digit, e.g. V8, in front of the interface, these two parts are separated with / e.g. IV8/485)

The possible device types, encoder versions and software options are specified in the tables below.

Device types with integrated control unit	Device types without integrated control unit
LOCON 24	LOCON 24-PM
LOCON 48	LOCON 48-PM
LOCON 64	LOCON 64-PM

Encoder version	Significance	Permitted resolutions
O	Absolute shaft encoder, parallel	360, 720, 1000, 3600, 7200 2^n (n=0..13 bit) 2 .. 8192
Z	Incremental encoder	2..16384
S	Absolute shaft encoder SSI	360, 720, 1000, 3600, 7200 2^n (n=0..13 bit) 2 .. 8192
T	TIMER (value is generated internally)	1 ms to 65535
MT	Multiturn, SSI	16777216 (24 Bit)

Software options Interfaces	Significance	Excludes option or possible only in the case of
A32	Expanded to 32 outputs	LOCON 24
A2	2 analog outputs	Only encoders up to 13 bit permissible
D	Binary-coded speed display at the 8 upper outputs	LOCON 24, 48 and 64
E16	16 inputs for logic operations	LOCON 24 and 48
G	Encoder monitoring	
I	Bitwise idle time compensation	L, LT
IP65	Front panel, version IP 65	
L	Blockwise idle time compensation	I
LT	Blockwise separate switch-on/switch-off time	I, LT
N2	Extended memory for 1500 data records	LOCON 24, 48 and 64
U	Direction cams	
V	Locked outputs (password request)	
W16, W32	Angle-time-cams on outputs 1-16/32, combinable as desired with angle/angle-cams	
PB	Profibus-interface	MPI, CO
MPI	MPI-interface	PB; CO
CO	CANopen-interface	MPI, PB
H08	Highly-dynamical idle time compensation on the first 8 outputs, all other outputs can be compensated bit-wise	L, LT

18.3 Order designation examples

Example 1: LOCON 24-O360-I485

LOCON 24 cam control for absolute shaft encoder, parallel, resolution 360, bitwise idle time compensation, RS485 interface

Example 2: LOCON 24-O4096-AE16HL485

LOCON 24 cam control for absolute shaft encoder, parallel, resolution 4096, 16 inputs for logic functions, high-speed processor, blockwise idle time compensation, RS485 interface

18.4 Standard accessory

18.4.1 Standard accessory of LOCON 24, 48, 64 and TERM 24

The scope of delivery of the unit includes the accessories described below:

TERM 24 front panel IP 54 LOCON 24, 48 and 64 front panel IP 54	4 mounting brackets 1 instruction manual 1 brief instruction
TERM 24 front panel IP 65 LOCON 24, 48 and 64 front panel IP 65	1 instruction manual 1 brief instruction

19 Servicing

Should an error message occur, please first take all measures described in chapter Error messages.

Should questions occur that are not covered by this manual, please contact the responsible sales partner (see internet: <http://www.deutschmann.de>) or contact us directly.

Please keep the following information ready at hand when you call:

Device designation
Serial number (S/N)
Item No.
Error number and error description (see also following chapter 'Returning a unit')

You can reach us on the following Hotline number. Lines are open from

Monday to Thursday from 8 am to 12 pm and from 1 pm to 4 pm, Friday from 8 am to 12 pm

Central office & sales department: +49-(0)6434-9433-0
 Technical hotline: +49-(0)6434-9433-33

Fax Central office & sales department: +49-(0)6434-9433-40
 Fax technical hotline: +49-(0)6434-9433-44

19.1 Returning a unit

If you return a unit to us, we require as comprehensive a description of the error as possible. We require the following information in particular:

- What error number was displayed?
- How is the unit externally wired (encoders, outputs, ...)? Please state all connections of the unit.
- What is the magnitude of the 24 V supply voltage (± 0.5 V) with connected LOCON?
- What were you last doing on the unit (programming, error on power-up, ...)?

The more precise your information and error description, the more precisely we can check the possible causes.

Devices, that are sent in without an error description undergo a standard test. You have to bear the costs for that test even though no defect was found.

19.2 Internet

The current software WINLOC is available for download from our Internet-homepage (URL). There you can also find topical information on Deutschmann products, instruction manuals and a list of our distribution partners.

URL: www.deutschmann.de

20 Appendix

20.1 Description and connection of the DICNET[®]-Adapter

20.1.1 DICNET[®]-Adapter DICADAP 3

The DICNET-Adapter serves to connect a PC to a DICNET-network of the company DEUTSCHMANN AUTOMATION.

It converts both the network protocol as well as the physical RS485-signals, so that a PC with the WINDOWS-software "WINLOC" will be in the position to communicate with those control units from DEUTSCHMANN AUTOMATION, existing in the net through a serial interface (COMx).

"WINLOC" is able to run under WIN 3.1x, WIN95/98 and WIN NT. The basic version is available free of charge.

The DICNET-Adapter is directly connected to a serial interface of the PC through the 9-pin D-SUB plug.

On the other side of the adapter (25-pin D-SUB plug) the DICNET-Bus and the supply voltage, which is allowed to range between 10V and 30V, is fed according to the below pin-assignment.

In case the DICNET-Adapter is connected as the last subscriber in the bus, the internal bus-terminating resistor has to be activated by means of bridges of the PIN's DICNET+ with R+ and DICNET- with R-. (More detailed information to the bus-termination and to the connection to the DICNET can be found in the instruction manual of the used control unit.)

Pin assignment 25-pin:

1-15	Reserved (do not wire)
16	R+
17	DICNET +
18	DICNET -
19	R-
20-23	Reserved (do not wire)
24	+24 V
25	GND

Pin assignment 9-pin:

2	Rx
3	Tx
5	GND
Others	nc

