

Service Manual

Controller

SIGMA CONTROL 2 SCREW FLUID $\geq 1.1.3$

9_9450 03 HCE

HPC

This manual is intended as a guide to the installation, operation and maintenance of your HPC Screw Compressor. It is important from a safety point of view that the work of installing and maintaining the compressor is undertaken by trained personnel and should be entrusted to an HPC Authorised Distributor

Quick User Guide

Controller

SIGMA CONTROL 2 SCREW FLUID $\geq 1.1.3$

9_9450 03 HCE

HPC

1.	Important settings	1
2.	Setting the contrast and the brightness	2
3.	Setting the display language	3
4.	Logging on with Equipment Card	4
5.	Adjusting the system setpoint pressure	6
6.	Activating the «clock» key.	7
7.	Activate the «remote control» key	10
8.	Changing the control mode	13
9.	Outputting important operational states of the machine	14
10.	Resetting maintenance interval counters	15
11.	Pressure relief valve checking	17
12.	Checking the temperature sensor and overheating shutdown function	20
13.	Interpreting operation messages	22
14.	Interpreting diagnostic messages	25
15.	Interpreting fault messages	26
16.	Interpreting warning messages	31
17.	Interpreting system messages	36

1 Important settings

In this chapter, important or often used settings are explained in brief. Detailed information on function, configuration, fault removal and important instructions concerning safe operation are found in subsequent chapters.



Setting and other work on the machine may only be carried out by the following persons:

- persons trained on the machine/controller and persons instructed by and under the supervision of a specialist,
- trained technicians,
- authorised Service personnel.

2 Setting the contrast and the brightness

The display settings for contrast and brightness are set to the highest possible values by default. Change the settings if adverse lighting conditions make it difficult to read the displayed information.

Optimising the contrast settings:

- Press and hold the «Information» key.
- At the same time, press the «Left» or «Right» key.

Optimising the brightness settings:

- Press and hold the «Information» key.
- At the same time, press the «UP» or «DOWN» key.

Precondition The display shows the operating mode.

1. Press «Enter».
The main menu is displayed.
2. Press and hold the «Information» key.

6.1 bar	08:15	80.0 °C	
Main menu			
..... Deutsch			Active line with current language
▶1 xxxxxxxxxxx			Submenu
▶2 xxxxxxxxxxx			Submenu
▶3 xxxxxxxxxxx			Submenu
▶4 xxxxxxxxxxx			Submenu
▶5 xxxxxxxxxxx			Submenu

3. Press «UP» or «DOWN» to adjust the contrast.
4. Press «Left» or «Right» to adjust the brightness.

Result The settings for contrast and brightness have been adjusted.

3 Setting the display language

Precondition The display shows the operating mode.

1. Press «Enter».
The main menu is displayed.
2. Press the «UP» or «DOWN» keys until the current language is shown as active line.

6.1 bar 08:15 80.0 °C	
Main menu	
..... Deutsch	Active line with current language
▶1 xxxxxxxxxx	Submenu
▶2 xxxxxxxxxx	Submenu
▶3 xxxxxxxxxx	Submenu
▶4 xxxxxxxxxx	Submenu
▶5 xxxxxxxxxx	Submenu

3. Use the «Enter» key to switch to setting mode.
The currently set language flashes.
4. Move to the required language with «UP »or «DOWN».
5. Confirm the setting with «Enter».
6. Press «Escape» repeatedly to return to the main menu.

Result The display texts are now in the selected language.

4 Logging on with Equipment Card

Proceed as follows:

- Take the plastic sleeve from the control cabinet.
 - Remove one Equipment Card.
 - Note the number on the reverse side of the Equipment Card.
 - Safely store the number.
 - Log on with Equipment Card
- Proceed in the prescribed sequence of actions.

Remove the Equipment Card from the control cabinet.

The supplied Equipment Cards are stored in a plastic sleeve.

This plastic sleeve is attached to the rear of the controller in the control cabinet.



The number shown on the rear of the Equipment Card is also the user name.
The user name is required for a manual log on without Equipment Card.



Fig. 1 KAESER Equipment Card

- ① KAESER Equipment Card
- ② Number of the KAESER Equipment Card

1. Open the control cabinet.
2. Remove the plastic sleeve from the rear of the controller.
3. Remove one Equipment Card from the plastic sleeve.
4. Note the number shown on the backside of the Equipment Card.
5. Store this information at a suitable location.

Log on with Equipment Card

Use a supplied KAESER Equipment Card to log on at the controller.
Two of them have been provided with the machine.

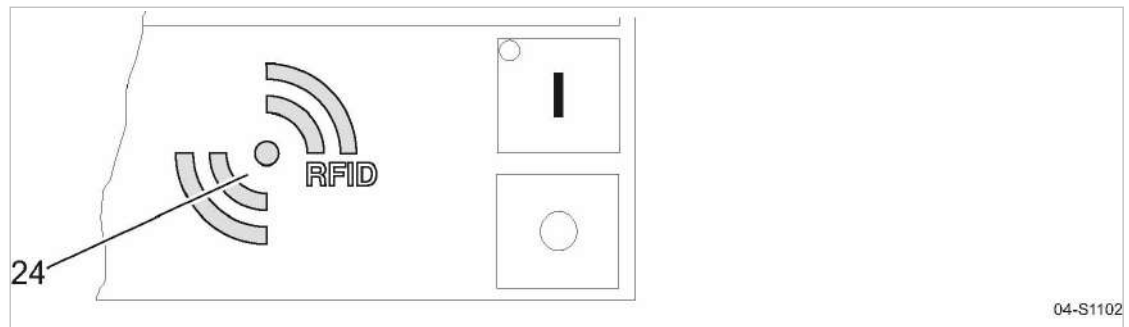

Fig. 2 RFID reader

1. Hold the Equipment Card for a short time in front of the RFID reader.
The data are read.
Your user name and access level are displayed.
2. Press «Enter» to confirm the log-on.
The operating mode is displayed.

Result You are logged on.

Further information See chapter 7.2.6 for a manual log-on to the controller.

5 Adjusting the system setpoint pressure

Precondition Access level 2 is activated.
The display shows the operating mode.

1. Press «Enter».
The main menu is displayed.
2. Select the < Configuration → Pressure control → Pressure settings > menu.
The pA switching value is displayed in the active line.

6.1 bar	08:15	80.0 °C
5.2.2 Pressure settings		
Setpoint pressure		
pA SP : 8.0 bar SD : -0.5 bar		
pB SP : 7.7 bar SD : - 0.5 bar		
.....		
System pressure low <input type="checkbox"/>		
↓ < 5.0 bar SD : 0.5 bar		

Current menu
Parameter to be adjusted
Active line, setting for switching point pA
Setting for switching point pB

3. Press «Enter» to switch into setting mode.
The current value flashes.
4. Use «UP» or «DOWN» to adjust the setting for the switching point pA .
5. Press «Enter» to accept the setting.
6. Press the «Right» key once.
7. Press «Enter» to switch into the setting mode for the switching differential.
The current value flashes.
8. Use «UP» or «DOWN» to adjust the setting for the switching differential.
9. Press «Enter» to accept the setting.
10. If necessary, adjust the value for switching point pB in the same way.
11. Press «Escape» repeatedly to return to the main menu.

Further information See chapter 7.4 for the adjustment of the machine's pressure parameters.

6 Activating the «clock» key.



Activating/deactivating the check box

Check box	Check box for reset	Status
<input checked="" type="checkbox"/>	<input checked="" type="checkbox"/>	activated
<input type="checkbox"/>	<input type="checkbox"/>	deactivated

Tab. 1 Check box status

Precondition Password level 2 is activated.
The display shows the operating mode.

Select the clock compressor menu

1. Press «Enter».
The main menu is displayed.
2. Select < Compressor clock >.
The display for setting the Compressor clock timing program appears.

6.1 bar 08:15 80.0 °C	
6 Compressor clock	Menu
Key clock: <input type="checkbox"/>	
Reset: <input type="checkbox"/>	
.....	
01 n.a. 00:00 off	Enter switching point 01 (active line)
02 n.a. 00:00 off	Enter switching point 02
03 n.a. 00:00 off	Enter switching point 03

Entering switching points

1. Press «Enter» to switch into setting mode.
The *n.a.* column flashes in the active line.
2. Use «UP» to specify the settings for the weekdays.
3. Press «Enter» to accept the setting.
4. Press the «Right» key once.
5. Press «Enter» to switch into setting mode.
Column time, hours display, *00 : 00* flashes in the active line.
6. Use «UP» to specify the settings for the hours.
7. Press the «Right» key once.
Column time, hours display, *00 : 00* flashes in the active line.
8. Use «UP» to specify the settings for the minutes.

9. Press «Enter» to accept the settings.

The display stops flashing and the time (hours/minutes) is set.

6.1 bar 08:15 80.0 °C	
6 Compressor clock	Current menu
Key clock: <input type="checkbox"/>	
Reset: <input type="checkbox"/>	
.....	
01 Mon-Fri 06:30 on	example for weekdays
02 Mon-Fri 12:00 off	example for time
03 Mon-Fri 13:00 on	For example, compressor ON action

10. Press the «Right» key once.
11. Press «Enter» to switch into setting mode.
Column *action on/off* flashes.
12. Use «UP» to specify the settings for the compressor ON action.
13. Press «Enter» to accept the setting.
The compressor ON action is setz for the first switching point.
14. Specify further switching points in the same manner.

Result Weekdays, time and the compressor ON / compressor OFF actions are set for all switching points.

Activating the «clock» key.

1. Use «UP» key to change to line *Key clock*.
2. Press «Enter» to switch into setting mode.
The check box flashes in the active line.

6.1 bar 08:15 80.0 °C	
6 Compressor clock	Menu
Key clock: <input checked="" type="checkbox"/>	Active line with check box
Reset: <input type="checkbox"/>	Resetting all current switching points
.....	
01 Mon-Fri 06:30 on	
02 Mon-Fri 12:00 off	
03 Mon-Fri 13:00 on	

3. Use the «UP» key to activate the check box.
4. Press «Enter» to accept the setting.
The «clock» key is activated.
5. Press «Escape» repeatedly to return to the main menu.
6. Press the «clock» key.



- Proceed in the same manner to deactivate the «clock» key.
- All defined switching points will be reset simultaneously if you activate the reset check box.

- Result The machine runs according to the defined switching points of the clock program.
- Further information See chapter 7.5 for configuration of starting and stopping the machine.
See chapter 7.8.2 for configuration of load changeover based on a clock program.

7 Activate the «remote control» key



Further settings have to be made to allow the machine to be remotely controlled.
 ➤ Refer to the section "Additional information" in this chapter.

Activating/deactivating the check box

Check box	Status
<input checked="" type="checkbox"/>	activated
<input type="checkbox"/>	deactivated

Tab. 2 Check box status

The following menus are used to activate the «remote control» key:

- Menu <Compressor ON>
- Menu <Load control>

The function will be available as soon as the «remote control» key in one of the menus has been activated.

Precondition Access level 2 is activated.
 The display shows the operating mode.

Activating the «remote control»key in the compressor ON menu

1. Press «Enter».
 The main menu is displayed.
2. Select < Configuration → Compressor start → Compressor on >.
3. Press «DOWN» repeatedly until *Key remote* is displayed as active line.
4. Press «Enter» to switch into setting mode.

The *check box* for «remote control» key flashes.

6.1 bar 08:15 80.0 °C	
5.4.1 Compressor on	Menu
Local mode: Key	
Remote mode: Key	

RC DI 1.12 <input type="checkbox"/>	
Key remote: <input type="checkbox"/>	Active line with check box
Key clock: <input type="checkbox"/>	

5. Press the «UP» key.
 The activated check box is displayed.

- Press «Enter» to save the setting.
The «remote control» key is activated and can be used.

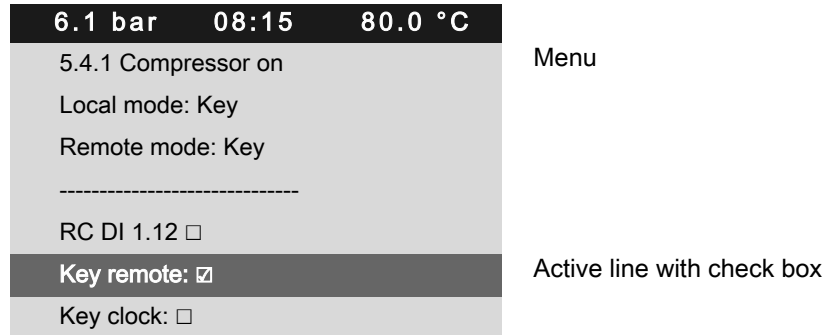

- Press «Escape» repeatedly to return to the main menu.
- Press the «remote control» key to enable remote mode.



Proceed in the same manner to deactivate the «remote control» key.

Activating the «remote control» key in the load control menu

Precondition Access level 2 is activated.
The display shows the operating mode.

- Press «Enter».
The main menu is displayed.
- Select < Configuration → Pressure control → Load control >.
- Press «UP» repeatedly until *Key remote* is displayed as active line.
- Press «Enter» to switch into setting mode.
The check box for «remote control» key flashes.

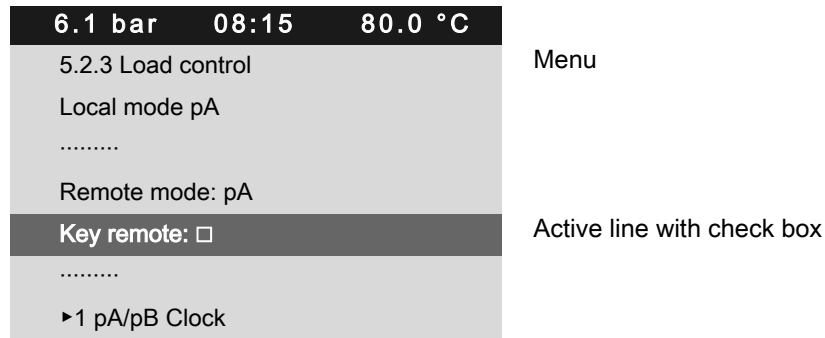

- Press the «UP» key.
The activated check box is displayed.

6. Press «Enter» to accept the setting.

The «remote control» key is activated and can be used.

6.1 bar	08:15	80.0 °C	
5.2.3 Load control			Menu
Local mode pA			
.....			
Remote mode: pA			
Key remote: <input checked="" type="checkbox"/>			Active line with check box
.....			
▶1 pA/pB Clock			

7. Press «Escape» repeatedly to return to the main menu.

8. Press the «remote control» key to enable remote mode.



Proceed in the same manner to deactivate the «remote control» key.

Further information

See chapter 7.5 for configuration of starting and stopping the machine.

See chapter 7.9 for configuration of load changeover under master control.

8 Changing the control mode



The standard setting of the control mode depends on the machine type.
As an example, the change from DUAL to QUADRO control mode is described below.

Precondition Access level 2 is activated.
The display shows the operating mode.

1. Press «Enter».
The main menu is displayed.
2. Select the < Configuration → Control mode > menu.
Local mode is displayed as active line.

6.1 bar 08:15 80.0 °C	
5.3 Control mode	Current menu
Local mode: DUAL	Active line with control mode to be adjusted

▶1 Venting period	
.....	
▶3 DUAL	
▶4 QUADRO	

3. Press «Enter» to switch into setting mode.
The display for *DUAL* control mode flashes.

6.1 bar 08:15 80.0 °C	
5.3 Control mode	Current menu
Local mode: QUADRO	Active line with changed control mode

▶1 Venting period	
.....	
▶3 DUAL	
▶4 QUADRO	

4. Use «UP» to select QUADRO.
5. Press «Enter» to accept the setting.
6. Press «Escape» repeatedly to return to the main menu.

Result The regulating mode DUAL has been switched to QUADRO.

Further information See chapter 4.7 for the functions of the control modes.
See chapter 7.6 for the parameters of the control modes.

9 Outputting important operational states of the machine

Important operational machine states can be assigned via floating relay contacts as a binary signal on the outputs DOR 1.05 – DOR 1.07. Further outputs are optionally available. You can assign every output only once.

Precondition Access level 2 is activated.
The display shows the operating mode.

Configuration → I/O Periphery → DO Functions menu

1. Press «Enter».
The main menu is displayed.
2. Select the < Configuration → I/O periphery → DO functions > menu.
A list of available messages and their assigned outputs is displayed.
Controller on line is displayed as being active.
3. Select the required message with the «UP» or «DOWN» keys.

6.1 bar	08:15	80.0 °C	
5.7.1 DO functions			Menu
Controller on			Active line
DOR 1.05 □ Logic : +			
DOT 1.02 □ Logic : +			
Compressor on			
DOR 1.03 □ Logic : +			
DOT 1.02 □ Logic : +			

Assigning a message to an output

1. Press «Enter» to switch into setting mode.
The display flashes.
2. Select a free output with the «UP» or «DOWN» key.
3. Press «Enter» to accept the setting.
A message is now sent via the assigned output.
4. Press «Escape» repeatedly to return to the main menu.

Further information See chapter 7.11 for the configuration and use of the controller's inputs and outputs.

10 Resetting maintenance interval counters

Example: Resetting the maintenance counter for the oil filter.

Precondition Maintenance has been performed.
Warning message has been acknowledged.
Access level 2 is activated.
The display shows the operating mode.

Maintenance menu

1. Press «Enter».
The main menu is displayed.
2. Select the < *Maintenance* > menu.
The maintenance counter for *Oil filter* is displayed in the active line.
3. Press «DOWN» once.
4. Press the «Right» key once.
5. Press «Enter» to switch into setting mode.
The *Reset* check box flashes.

6.1 bar 08:15 80.0 °C	
4 Maintenance	Menu
Oil filter	
6000 h 0005 h Reset: <input type="checkbox"/>	Active line, maintenance interval, remaining service life
.....	
Oil separator	
6000 h 3000 h Reset: <input type="checkbox"/>	
.....	

6. Use «UP» or «DOWN» to activate the Reset check box.

6.1 bar 08:15 80.0 °C	
4 Maintenance	Menu
Oil filter	
6000 h 6000 h Reset: <input checked="" type="checkbox"/>	Active line, maintenance interval, remaining new service life
.....	
Oil separator	
6000 h 3000 h Reset: <input type="checkbox"/>	
.....	

7. Press «Enter» to accept the setting.
The remaining service life of the new oil filter complies with the defined maintenance interval of 3000 h (depending on the machine type).

Result The check box for Reset is deactivated automatically.

6.1 bar	08:15	80.0 °C	
4 Maintenance			Menu
Oil filter			
6000 h 6000 h Reset: <input type="checkbox"/>			Active line, check box is deactivated
.....			
Oil separator			
6000 h 3000 h Reset: <input type="checkbox"/>			
.....			

Further information See chapter 8.9 for setting the maintenance intervals.
See chapter 10 for the maintenance of the controller.

11 Pressure relief valve checking

Overview

- Preparing the test
- Performing the test
- Correct conclusion of the test
- Resetting



When the check mode is activated, monitoring of internal pressure (blow-off protection - if provided) and regulation of network pressure are deactivated.

The measured value of internal pressure p_i is used to describe the following check.

Check box	Status
<input checked="" type="checkbox"/>	activated
<input type="checkbox"/>	deactivated

Tab. 3 Check box status



WARNING

Danger of injury from pressurised components!

- Perform the following actions in the sequence provided.

Preparing the test

1. Note the activating pressure of the pressure relief valve from the machine's nameplate.
2. Press the «OFF» key to shut down the machine.
3. Close the user's shut-off valve between the machine and the air distribution network.
4. Log on to SIGMA CONTROL 2 with access level 2 (see chapter 7.2.6).
5. In operating mode, switch to the main menu with the «Enter» key.
6. Select the *< Machine test → TÜV inspection >* menu.

Pressure relief valve is displayed as an active line.



Menu

Active line with check box

Relief valve activating pressure (example)

Performing the test

1. Press «Enter».
The *check box* flashes in the active line.
2. Use the «UP» key to activate the check box.

3. Press «Enter» to accept the setting.

The test mode is now activated.

The monitoring of internal and network set point pressures is deactivated!

6.1 bar	08:15	80.0 °C
9.1 TÜV inspection		
Safety valve: <input checked="" type="checkbox"/>		
pRV: 16.00 bar pi 2.50 bar		
Reset: <input type="checkbox"/>		
.....		

Menu

Active line with check box

Relief valve activating pressure



4. **WARNING!**

Excessive noise is caused when the pressure relief valve blows off!

- > Close all access doors; replace and secure all removable panels.
- > Wear hearing protection.



5. **WARNING!**

Risk of burns due to released cooling oil and compressed air when blowing off the pressure relief valve!

- > Close all access doors; replace and secure all removable panels.
- > Wear eye protection.

6. Press and hold the «ON» key.

The machine switches to load, the machine's internal pressure pi rises.

7. Monitor on the display the pressure rise pi during the check.

8. If the internal pressure pi increases to more than 10% above the correct opening pressure of the pressure relief valve, shut down the machine with the «OFF» key and replace the pressure relief valve.



If the alarm message *pRV ≠* appears, the pressure relief valve is defective. The permissible internal pressure was exceeded by 2 bar.

- > Have the pressure relief valve replaced.



Avoid oil mist:

- > Release the «ON» key immediately when the pressure relief valve responds, in order to prevent unnecessary oil mist.

Correct conclusion of the test

1. Press «Enter» to switch into setting mode.
The check box in the active line flashes.
2. Use the «DOWN» key to deactivate the check box.
3. Press «Enter» to accept the setting.
The test mode is de-activated and the test is completed.
4. Press «Escape» repeatedly to return to the main menu.
5. Open the shut-off valve from the machine.

Result The machine is ready for operation.

Resetting

If the test is canceled when opening the pressure relief valve, SIGMA CONTROL 2 will indicate the highest measured value as internal pressure.

Activate the check box for reset in order to reset the stored value.

- Activate the check box.

Further information See chapter 8.10 to test the pressure relief valve.

12 Checking the temperature sensor and overheating shutdown function

The machine should shut down if the airend discharge temperature (ADT) reaches a maximum of 110 °C.

SIGMA CONTROL 2 will simulate a higher temperature for checking this function.

For this purpose, SIGMA CONTROL 2 automatically determines an offset value to be displayed. During the test mode, this offset is added to the actual airend discharge temperature to cause the machine to shut down prematurely.

In standard operation, SIGMA CONTROL 2 generates the "overtemperature" fault message when the maximum airend discharge temperature is reached. Since the modified test temperature is 2 K below the fault message switching point for overtemperature, the system will not generate a fault message in test mode.

Overview

- Shut down the machine and allow to cool down slightly
- Performing the test
- Correct conclusion of the test
- Resetting

Performing the test

Precondition Machine has cooled down by approx. 5 °C

1. Log on to SIGMA CONTROL 2 with access level 2. (see section 7.2.6).
2. In operating mode, switch to the main menu with the «Enter» key.
3. Select the *< Machine test → TÜV inspection >* menu.
Pressure relief valve is displayed in the active line.
4. Press «DOWN» repeatedly until *Airend discharge temperature ADT †* is displayed as active line.
5. Press «Enter» to switch into setting mode.
The check box in the active line flashes.

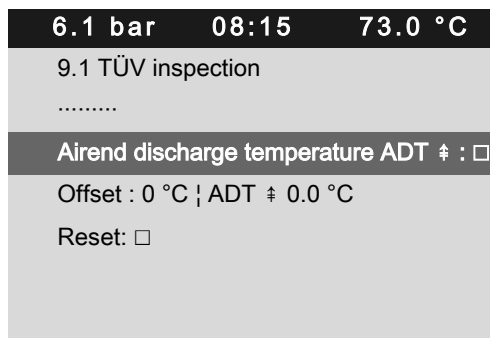

Fallen airend discharge temperature Menu

Active line

6. Use the «UP» key to activate the check box.

- Press «Enter» to accept the setting.
The *Offset* display changes to 35 °C.
The *Airend discharge temperature ADT* ≠ display changes to 108 °C.
The test mode is now activated.

6.1 bar	08:15	73.0 °C	
9.1 TÜV inspection			Menu
.....			
Airend discharge temperature ADT			Active line
‡ : <input checked="" type="checkbox"/>			
Offset : 35 °C ADT ‡ 108 °C			Offset, airend discharge temperature in test mode
Reset: <input type="checkbox"/>			

- Press the «ON» key to switch the machine to LOAD.
The machine switches to LOAD and the airend discharge temperature rises again.
The machine will switch off as soon as the airend discharge temperature attains a value of 108 °C.



- The machine does not shut down?
- Abort the test and contact HPC Service as soon as possible.

Correct conclusion of the test

- Press «Enter» to switch into setting mode.
The check box in the active line flashes.
- Use the «DOWN» key to deactivate the check box.
- Press «Enter» to accept the setting.
The offset is reset to 0 °C.
The test mode is de-activated and the test is completed.
- Press «Escape» repeatedly to return to the main menu.

Resetting

SIGMA CONTROL 2 will display the highest measured value if the test for switching off at overtemperature is aborted.

Activate the *Reset* check box in order to reset the stored value.

- Activate the *Reset* check box.

Further information See chapter 8.11 for testing the temperature sensor.

13 Interpreting operation messages

The controller will automatically display operation messages informing you about the current operational state of the machine.

Operating messages are identified with the letter O.

The message numbers are not numbered consecutively.

Messages 0081 to 0095 are customer-specific and undefined. Complete them with your defined message text and interpretation.

Message	Meaning
0001 O Load control pA	The machine is regulated by system set point pressure pA.
0002 O Load control pB	The machine is regulated by system set point pressure pB.
0003 O Load control RC	The machine is regulated via the remote contact.
0004 O Load control RB	The machine is remotely regulated via the bus connection.
0005 O ready	The machine is switched on and in READY operating mode.
0006 O Idle	The machine is switched on and in IDLE operating mode.
0007 O On load	The machine is switched on and in LOAD operating mode.
0008 O off	The machine is switched off. The power supply is connected.
0009 O Compressor on	The machine is switched on.
0010 O Controller on	The power supply is connected. The controller is powered.
0011 O Cold start release	The machine can be switched on although the machine temperature is below the permissible starting temperature. The machine can be switched on only as long as the message is displayed.
0025 O Setpoint pressure pA	The value for pA is output.
0026 O Setpoint pressure pB	The value for pB is output.
0027 O Power OFF → ON	Request: Switch the power supply off and on.
0028 O DYNAMIC motor temperature ↑	Control mode DYNAMIC: The temperature of the compressor motor is too high.

Message	Meaning
0081 O	
0082 O	
0083 O	
0084 O	
0085 O	
0086 O	
0087 O	
0088 O	
0089 O	
0090 O	
0091 O	
0092 O	
0093 O p-Switch pi	
0094 O T-Switch ADT	
0095 O p-Switch pN	
0200 O IOSlot1 Undervoltage error 50	The internal voltage monitoring reports undervoltage fault IO-Slot1
0201 O IOSlot2 Undervoltage error 50	The internal voltage monitoring reports undervoltage fault IO-Slot2
0202 O IOSlot3 Undervoltage error 50	The internal voltage monitoring reports undervoltage fault IO-Slot3
0203 O IOSlot4 Undervoltage error 50	The internal voltage monitoring reports undervoltage fault IO-Slot4
0204 O IOSlot5 Undervoltage error 50	The internal voltage monitoring reports undervoltage fault IO-Slot5

Message	Meaning
0205 O IOSlot6 Undervoltage error 50	The internal voltage monitoring reports undervoltage fault IO-Slot6

Tab. 4 Operational Messages

14 Interpreting diagnostic messages

Diagnostic messages are identified with the letter D.

They provide information on the status of the controller, the connected input and output modules and support the HPC service in trouble-shooting.

15 Interpreting fault messages

Alarm messages are identified with the letter A.

The message numbers are not numbered consecutively.

Messages 0081 to 0095 are customer-specific and may differ from the suggested values. Complete them with your defined message text, possible causes and remedies.

Message	Possible cause	Remedy
0001 A Direction of rotation	The compressor drive motor is turning in the wrong direction.	Change over phase lines L1 and L2.
0002 A Motor temperature ‡	Compressor drive motor overheated.	Clean the motor. Keep ambient conditions within specified limits.
0003 A pRV ‡	The activating pressure of the pressure relief valve on the oil separator tank has been exceeded.	Change the pressure relief valve.
0004 A EMERGENCY STOP	EMERGENCY STOP control device actuated.	Unlatch the push-button.
0005 A Oil separator Temperature ‡	Maximum air temperature at the oil separator tank outlet is exceeded.	Check the line to the trip relay.
0007 A Power supply monitor	Fault in mains power supply.	Have the mains power supply checked.
0009 A SIGMA CONTROL 2 T ‡	Permissible enclosure temperature for SIGMA CONTROL 2 exceeded.	Keep ambient conditions within specified limits. Control cabinet: Check filter mats and fan.
0010 A Blow-off protection ‡	The activating pressure of the pressure relief valve on the oil separator tank has been exceeded.	Change the oil separator cartridge. Open the shut-off valve in the venting line.
0011 A Oil-/air cooler fan Overcurrent	Overload shut-down of the first fan motor.	Investigate cause of shut-down. Reset the overload relay.
0012 A Access doors	Door open / interlocked panel removed while the machine is running.	Fit and secure all panels and close access doors.

Message	Possible cause	Remedy
0013 A Compressor motor overcurrent	Overload shut-down of the compressor drive motor.	Investigate cause of shut-down. Change the oil separator cartridge.
0014 A Oil-/air cooler fan Overcurrent	Overload shut-down of the second fan motor.	Investigate cause of shut-down. Reset the overload relay.
0015 A Airend discharge temperature ADT ‡	Maximum permissible airend discharge temperature (ADT) exceeded.	Keep ambient conditions within specified limits. Clean the cooler. Check the cooling oil level.
0016 A Oil-/air cooler fan Overcurrent	Overload shut-down of the third fan motor.	Investigate cause of shut-down. Reset the overload relay.
0019 A Internal pressure pi ‡	–	–
0021 A Refrigeration dryer T ‡	Refrigeration dryer: Compressed air temperature too low.	Contact HPCservice.
0022 A Oil separator Δp ‡	Oil separator cartridge clogged.	Change the oil separator cartridge.
0023 A Motor bearings	Drive motor bearings overheated.	Re-grease the motor bearings.
0024 A Water-cooling water shortage	Cooling water pressure is too low.	Check cooling water supply.
0034 A Mains contactor on?	Mains contactor does not close.	Check mains contactor and wiring.
0035 A Cabinet fan I ‡	Overload shut-down of the control cabinet fan motor.	Contact HPCservice.
0038 A PD temperature ‡	Package discharge (PD) temperature too low.	Contact HPCservice.
0039 A PD temperature ‡	Package discharge (PD) temperature too high.	Check the cooling oil level. Clean the cooler. Check the fan motor.
0040 A Mains contactor off?	Mains contactor does not open.	Check mains contactor and wiring.

Message	Possible cause	Remedy
0041 A Mains voltage ‡	Second power failure.	Check power supply voltage. Check the door interlock switch.
0042 A Back pressure stop	Back pressure in the oil separator tank caused by defective venting.	Check venting line.
0043 A Airend discharge temperature ADT rise dT/dt ‡	The rate of rise of the airend discharge temperature (ADT) is too fast.	Check the cooling oil level.
0044 A No pressure buildup	The machine produces no compressed air. The working pressure does not rise above 3.5 bar within a default period.	Check the machine for leaks. Check coupling / V-belts
0045 A Compressor T ↓↓	Thermostatic valve defective	Contact HPCservice.
0048 A High-voltage cell	Fault in the high voltage cell.	Contact HPCservice.
0051 A Aggregate A	Aggregate A failed.	Contact HPCservice.
0052 A Aggregate B	Aggregate B failed.	Contact HPCservice.
0056 A RD condensate drain	Refrigeration dryer: The condensate drain is defective.	Refrigeration dryer: Check condensate drain and condensate conduits.
0057 A Model?	Compressor model uncertain.	Contact HPCservice.
0058 A Condensate drain	The condensate drain is defective.	Check condensate drain and condensate conduits.
0059 A Back pressure run	Drive belts or coupling broken.	Drive belt: Replace drive belts. Coupling: Contact HPC service.
0061 A Oil separator rise dT/dt ‡	The rate of rise of the airend discharge temperature is too fast.	Check the cooling oil level.

Message	Possible cause	Remedy
0062 A Refrigeration dryer p ‡	Refrigeration dryer: Pressure too high in the refrigerant circuit. Safety pressure switch tripped.	Clean the refrigerant condenser. Check the fan motor. Maintain operating conditions.
0063 A Refrigeration dryer p ‡	Refrigeration dryer: Refrigerant lost; pressure in the refrigerant circuit too low. Inlet pressure switched tripped.	Contact HPC service.
0081 A		
0082 A		
0083 A		
0084 A		
0085 A		
0086 A		
0087 A		
0088 A		
0089 A		
0090 A		
0091 A		
0092 A		
0093 A p-Switch pi		
0094 A T-Switch ADT		
0095 A p-Switch pN		
0097 A High-voltage cell on?	High-voltage cell does not activate.	Check high-voltage cell and wiring.

Message	Possible cause	Remedy
0098 A High-voltage cell off?	High-voltage cell does not de-activate.	Check high-voltage cell and wiring.
0099 A Mains contactor on?	Mains contactor does not close.	Check mains contactor and wiring.
0100 A Mains contactor off?	Mains contactor does not open.	Check mains contactor and wiring.
0101 A Compressor motor overcurrent	Overload shut-down of the compressor drive motor.	Investigate cause of shut-down. Change the oil separator cartridge.
0102 A Oil-/air cooler fan Overcurrent	Overload shut-down of the first fan motor.	Investigate cause of shut-down. Reset the overload relay.
0200 A Compressor motor USS alarm	Frequency converter fault	Contact HPC service.
0201 A Compressor motor USS alarm	Frequency converter fault	Contact HPC service.
0202 A Compressor motor USS alarm	Frequency converter fault	Contact HPC service.
0205 A Compressor motor USS alarm	Communications error	Check connection and line path.
0210 A Compressor motor FC Motor overload alarm	Frequency converter fault	Contact HPC service.
0211 A Compressor motor FC Motor overload alarm	Frequency converter fault	Contact HPC service.

Tab. 5 Alarm messages and measures

16 Interpreting warning messages

Warning messages are identified with the letter W.

The message numbers are not numbered consecutively.

Messages 0081 to 0092 are customer-specific and may differ from the suggested values. Complete them with your defined message text, possible causes and remedies.

Message	Possible cause	Remedy
0002 W Motor temperature ↑	Drive motor overheating.	Clean the motor. Keep ambient conditions within specified limits.
0004 W Oil separator Δp ↑	Increased differential pressure of the oil separator cartridge. Oil separator cartridge clogged.	Change the oil separator cartridge.
0007 W Motor bearings	Drive motor bearing defective.	Contact HPC Service.
0008 W Airend discharge temperature ADT ↑	Maximum airend discharge temperature will soon be reached.	Clean the cooler. Check the cooling oil level. Replace the oil filter cartridge. Ensure adequate ventilation. Keep surrounding temperature within recommended limits.
0011 W Oil filter Δp ↑	Increased pressure differential of the oil filter. Oil filter clogged.	Change the oil filter.
0013 W Air filter Δp ↑	Air filter clogged.	Change the air filter.
0015 W Bus alarm	The bus link via the Profibus DP interface is interrupted.	Check the bus cables and plugs.
0024 W Mains contactor operations ‡	The maximum permissible number of switching cycles has been exceeded.	Have the mains contractor replaced by an authorised HPC service representative.
0025 W Oil separator h ‡	Oil separator cartridge: Maintenance interval has elapsed.	Change the oil separator cartridge.
0026 W Oil change h ‡	Cooling oil: Maintenance interval has elapsed.	Change the cooling oil.

Message	Possible cause	Remedy
0027 W Oil filter h ‡	Oil filter: Maintenance interval has elapsed.	Change the oil filter.
0028 W Air filter h ‡	Air filter: Maintenance interval has elapsed.	Change the air filter.
0029 W Valve inspection h ‡	Valves: Maintenance interval has elapsed.	Contact HPC Service.
0030 W Belt/coupling inspection h ‡	Belt tension/coupling: Maintenance interval has elapsed.	Carry out a visual inspection. Re-tension the drive belt.
0031 W Motor bearings h ‡	Motor bearing of compressor motor: Maintenance interval has elapsed.	Contact HPC Service.
0032 W Electrical equipment h ‡	Electric components and installation: Maintenance interval has elapsed.	Inspect and reset the maintenance interval counter.
0033 W Fan bearings h ‡	Motor bearing of fan motors: Maintenance interval has elapsed.	Contact HPC Service.
0034 W PD temperature ↓	Package discharge (PD) temperature too low.	Contact HPC Service.
0035 W PD temperature ↑	Compressed air discharge temperature too high.	Clean the cooler. Check the cooling oil level.
0036 W Motor starts/h ‡	The permissible number of motor starts was exceeded in the last 60 minutes.	Extend the idle period. Increase the capacity of the air receiver. Increase the cross-section of piping between compressor and air receiver.
0037 W Motor starts/d ‡	The permissible number of motor starts was exceeded in the last 24 hours.	Extend the idle period. Increase the capacity of the air receiver. Increase the cross-section of piping between compressor and air receiver.
0038 W Blow-off protection ↑	The pressure relief valve's activating pressure will soon be reached.	Change the oil separator cartridge. Open the shut-off valve in the venting line.

Message	Possible cause	Remedy
0041 W Mains voltage ↓	1. Power failure: The machine is automatically re-started.	Check power supply. Check the door interlock switch.
0043 W External load signal?	Ambiguous external load signal: Increased cut-out pressure exceeded. The external load control has not switched to idle.	Check settings of the external controller. Take into account pressure drops across filters and dryer.
0044 W Oil temperature ↓	Cooling oil temperature too low.	Check temperature switch, line and connection. Check the oil circuit. Increase room temperature.
0046 W System pressure ↓	Network pressure has fallen below the set 'system pressure low' value. Air consumption too high.	Check air demand. Check cable runs and sensor connections. Check the 'system pressure low' warning value.
0047 W No pressure buildup	The compressor cannot build-up to working pressure.	Check for air leaks. Check the value for internal pressure given in the <Analog data> menu against the reading on the oil separator tank pressure gauge.
0048 W Bearing lube h †	Re-grease the motor bearings. Maintenance interval has elapsed.	Re-grease the motor bearings.
0049 W Annual maintenance	Last maintenance was 1 year ago.	Carry out the necessary maintenance and reset the corresponding maintenance interval counter.
0059 W Start temperature ↓ ↓	The airend temperature is too low (<-10 °C) for the machine to be operated.	Keep ambient conditions within specified limits.
0060 W Start temperature ↓	The airend temperature is too low (<+2 °C).	Keep ambient conditions within specified limits.
0061 W Compressor T ↓	The airend discharge temperature (ADT) did not reach the minimum value within the specified time.	Contact HPC Service.
0066 W Air filter Δp †	Initial warning: Air filter clogged.	Change the air filter element soon.
0068 W Condensate drain	The condensate drain is defective.	Check the condensate drain and drain line.

Message	Possible cause	Remedy
0069 W Error operation without RD → Call service!	Refrigeration dryer defective. Compressed air supply with un-dried air is activated.	Immediately contact HPC service.
0070 W Refrigeration dryer T ↑	Refrigeration dryer: Compressed air temperature too high.	Maintain operating conditions. Clean the refrigerant liquefier. Clean the cooler. Install an extractor fan.
0071 W Oil level ↓	Cooling oil level too low.	Replenish the cooling oil.
0072 W RD condensate drain	Refrigeration dryer: The condensate drain is defective.	Check condensate drainage
0081 W		
0082 W		
0083 W		
0084 W		
0085 W		
0086 W		
0087 W		
0088 W		
0089 W		
0090 W		
0091 W		
0092 W		
0093 W p-Switch pi		
0094 W T-Switch ADT		

Message	Possible cause	Remedy
0095 W p-Switch pN		

Tab. 6 Warning messages and remedies

17 Interpreting system messages

System messages are identified with the letter Y.

The message numbers are not numbered consecutively.

Message	Possible cause	Remedy
0001 Y Hardware watchdog reset	System error	Contact HPC Service.
0002 Y Internal software error	System error	Contact HPC Service.
0003 Y Filesystem Read/Write failure	System error	Contact HPC Service.
0004 Y CPU load too high	System error	Contact HPC Service.
0005 Y RAM out of memory	System error	Contact HPC Service.
1000 Y RFID error: switch SIGMA CONTROL power supply OFF → ON!	System error	Contact HPC Service.

Tab. 7 System messages and remedies

1	Regarding this document	
1.1	Using this document	1
1.2	Copyright	1
1.2.1	Software	1
1.3	Updating the operating manual	1
1.4	Symbols and labels	2
1.4.1	Warnings	2
1.4.2	Potential damage warnings	2
1.4.3	Other alerts and their symbols	3
2	Technical Specifications	
2.1	SIGMA CONTROL 2 Controller	4
2.1.1	User interface with display, CPU and interfaces	4
2.1.2	Input/output modules	5
2.1.3	Sensors	7
3	Safety and Responsibility	
3.1	Basic instructions	9
3.2	Specified use	9
3.3	Improper use	9
4	Design and Function	
4.1	The controller	10
4.2	Operating panel	11
4.3	Display	14
4.3.1	Operating mode	14
4.3.2	Main menu	15
4.3.3	Setting parameters	15
4.3.4	Activating keys with check boxes	16
4.4	Access rights	16
4.4.1	Secure storage of the RFID Equipment Cards	17
4.5	Checking the machine status with KAESER CONNECT	17
4.6	Menus – overview	18
4.6.1	Operating mode	18
4.6.2	Menu structure	19
4.7	Operating modes and control modes	30
4.7.1	Operating modes	30
4.7.2	Control modes	31
4.7.3	Frequency-controlled drive (SFC)	32
4.7.4	MODULATING control	33
5	Installation and Operating Conditions	
5.1	Maintaining ambient conditions	34
5.2	Installation conditions	34
6	Installation	
6.1	Reporting Transport Damage	35
6.2	Machine identification	35
7	Initial Start-up	
7.1	Outline	36
7.2	Configuring the controller	36
7.2.1	Selecting menu options	36
7.2.2	Changing the display language	37
7.2.3	Note the number of the KAESER Equipment Card	38
7.2.4	Control access to SIGMA CONTROL 2 with the Equipment Card	38
7.2.5	Generate password for SIGMA CONTROL 2	38

7.2.6	Control access to SIGMA CONTROL 2 via manual input	40
7.2.7	Generate password for KAESER CONNECT	42
7.2.8	Check/set time and date	42
7.2.9	Set display formats	44
7.2.10	Setting and activating summer/winter time	47
7.3	Using KAESER CONNECT	47
7.3.1	Calling up KAESER CONNECT for SIGMA CONTROL 2	48
7.3.2	Displaying the system status	49
7.3.3	Display graphs	51
7.3.4	Displaying messages	53
7.3.5	Calling up the IO display	54
7.3.6	Creating additional user accounts	54
7.3.7	Settings	57
7.3.8	Performing a data backup	58
7.3.9	Closing KAESER CONNECT:	58
7.4	Adjusting the pressure parameters of the machine	59
7.4.1	Displaying pressure parameters	60
7.4.2	Configuring the pressure parameters for compressors	61
7.4.3	Activating/deactivating the «LOAD/IDLE» key	64
7.5	Configuring machine start and stop	65
7.5.1	Automatic start/stop in programmed clock mode	65
7.5.2	Setting up the holiday period	68
7.5.3	Starting the machine remotely from a control centre (remote ON/OFF)	69
7.5.4	Activating/deactivating the idle phase (unloading function)	72
7.5.5	Activating/deactivating and adjusting the "automatic restart after a power failure" function	73
7.6	Activating and adjusting the control modes	75
7.6.1	Selecting a control mode	75
7.6.2	Adjust the idle time of DUAL mode	76
7.6.3	Adjusting the minimum running and unloaded period in QUADRO control mode	77
7.7	Activating the settings for the refrigeration dryer	78
7.7.1	Setting the CLOCK mode	79
7.7.2	Output messages	80
7.7.3	Fault in the refrigeration dryer – call Service	81
7.7.4	Fault in the refrigeration dryer – activate fault mode	81
7.8	Configuring the machine for local mode	83
7.8.1	Select the < Configuration → Pressure control → Load control > menu	83
7.8.2	Configuring the system pressure setpoint changeover using the clock program	83
7.8.3	Configure the system pressure setpoint change-over using the clock	86
7.9	Configuring the machine for master control	88
7.9.1	List of the various master controllers	88
7.9.2	Configuring Profibus mode (SIGMA AIR MANAGER or VESIS)	89
7.9.3	Configuring the Profibus interface without SIGMA AIR MANAGER or VESIS ..	98
7.9.4	Configuring the master control of two machines in master/slave operation (Ethernet interface)	99
7.9.5	Configuring master control using the LOAD remote contact (e.g., SIGMA AIR MANAGER BASIC)	105
7.9.6	Configuring the master control with local/LOAD remote contact	108
7.9.7	Configuring setpoint pressure pre-selection via remote contact	111
7.9.8	Configuring master control of compressors regulated by pressure switch	113
7.9.9	Examples of time settings for equal overall load	121
7.10	Configuring e-mail	122

7.11	Configuring input and output signals	124
7.11.1	Outputting important operational states of the machine	125
7.11.2	Displaying analog input values	126
7.11.3	Displaying additional binary input signals	130
7.12	Activating remote acknowledgement	134
7.12.1	Selecting the < Configuration → Acknowledgement > menu	135
7.12.2	Setting the remote acknowledgement function	135
7.12.3	Activate the «Remote control» key	135
7.12.4	Assigning an input	136
7.13	Linking to an external pressure transducer	137
7.13.1	Selecting the < Configuration → Pressure control > menu	138
7.13.2	Assigning an input to an external sensor	138
7.14	Starting the machine	139
8	Operation	
8.1	Switching on and off	141
8.1.1	Switching on	141
8.1.2	Switching off	141
8.2	Switching off in an emergency and switching on again	142
8.3	Acknowledging fault and warning messages	142
8.4	Displaying messages	144
8.4.1	Select Status menu	145
8.5	Displaying the current operating mode	146
8.6	Adjusting working pressure	147
8.7	Displaying analog data	148
8.8	Displaying operating data	149
8.8.1	Interpreting operation messages	150
8.9	Setting the maintenance interval	152
8.10	Pressure relief valve checking	153
8.11	Checking the temperature sensor and overheating shutdown function	155
9	Fault Recognition and Rectification	
9.1	Basic instructions	158
9.2	Interpreting fault messages	158
9.3	Interpreting system messages	163
9.4	Interpreting diagnostic messages	163
9.5	Interpreting warning messages	164
10	Maintenance	
10.1	Maintenance Work	169
11	Spares, Operating Materials, Service	
11.1	Note the nameplate	170
11.2	HPC AIR SERVICE	170
11.3	Service Addresses	170
11.4	Displaying the version number, machine model, material number and serial number	170
12	Decommissioning, Storage and Transport	
12.1	De-commissioning	172
12.2	Packing	172
12.3	Storage	172
12.4	Transporting	172
12.5	Disposal	172

Fig.	KAESER Equipment Card	4
Fig.	RFID reader	5
Fig. 1	System structure	10
Fig. 2	Keys – overview	11
Fig. 3	Indicators – overview	12
Fig. 4	RFID reader	13
Fig. 5	KAESER CONNECT for SIGMA CONTROL 2	17
Fig. 6	Header	18
Fig. 7	Back of the KAESER Equipment Card	38
Fig. 8	Login window	48
Fig. 9	KAESER CONNECT	49
Fig. 10	Language selection	49
Fig. 11	Status display	50
Fig. 12	Main menu	50
Fig. 13	Status menu with submenus	51
Fig. 14	Pressure/temperature graphs	52
Fig. 15	Arrow keys	52
Fig. 16	Messages	53
Fig. 17	User administration menu	55
Fig. 18	"Log on to write" window	55
Fig. 19	Creating a new user	56
Fig. 20	Settings	57
Fig. 21	Data backup	58
Fig. 22	Header	59
Fig. 23	Pressure rise in frequency-controlled machines	63
Fig. 24	Profibus plug wiring	90
Fig. 25	Electrical diagram example with SIGMA AIR MANAGER	91
Fig. 26	Communication interface	93
Fig. 27	Insert the communication module.	93
Fig. 28	Front plate of the PROFIBUS communication module	94
Fig. 29	Direct connection of two SIGMA CONTROL 2	101
Fig. 30	LOAD remote contact	106
Fig. 31	Wiring diagram for local/LOAD remote contact:	108
Fig. 32	Machine with pressure switch regulation	114
Fig. 33	Function diagram	117
Fig. 34	Switching on and off	141
Fig. 35	Switching off in an emergency	142
Fig. 36	Acknowledging messages	143

Tab. 1	Danger levels and their definitions (personal injury)	2
Tab. 2	Danger levels and their definition (damage to property)	2
Tab. 3	User interface	4
Tab. 4	Display data	4
Tab. 5	Interfaces	5
Tab. 6	RFID	5
Tab. 7	SC2IOM-1	5
Tab. 8	SC2IOM-2	6
Tab. 9	SC2IOM-3	6
Tab. 10	Power supply specifications	6
Tab. 11	Cable lengths	7
Tab. 12	Degree of protection, IOM	7
Tab. 13	IOM dimensions	7
Tab. 14	Pressure transducer	7
Tab. 15	Resistance thermometer	7
Tab. 16	Keys	11
Tab. 17	Indicators	12
Tab. 18	RFID reader	13
Tab. 19	Reset check box status	16
Tab. 20	Check box status	16
Tab. 21	Menu structure	20
Tab. 22	Status menu	22
Tab. 23	Configuration menu	23
Tab. 24	Pressure control menu	24
Tab. 25	I/O periphery menu	25
Tab. 26	Communication menu	26
Tab. 27	Profibus	27
Tab. 28	Modbus	27
Tab. 29	Modbus TCP	28
Tab. 30	DEVICENET	28
Tab. 31	PROFINET	28
Tab. 32	Connections menu	29
Tab. 33	Components menu	29
Tab. 34	Power switching module – menu	30
Tab. 35	Machine identification	35
Tab. 36	Remote control identification	35
Tab. 37	Machine identification	35
Tab. 38	Language diversity	37
Tab. 39	Date format	44
Tab. 40	Time formats	44
Tab. 41	Units of pressure	45
Tab. 42	Units of temperature	46
Tab. 43	Display illumination	46
Tab. 44	Arrow keys and functions	52
Tab. 45	Compressor pressure parameters	59
Tab. 46	Setting limits for system set-point pressure (* Cut-in pressure min)	61
Tab. 47	Pressure condition for LOAD	61
Tab. 48	Pressure condition for IDLE	61
Tab. 49	Example: Activated output	62
Tab. 50	Settings for machine start and stop.	65
Tab. 51	Example of a machine ON/OFF timer program	66
Tab. 52	Local operating mode (local mode)	83
Tab. 53	Example of system pressure changeover switching points	84
Tab. 54	Master control – overview	88

Tab. 55	Profibus DP pin connection	89
Tab. 56	Master-slave configuration procedure	100
Tab. 57	Function diagram	116
Tab. 58	Example switching points	118
Tab. 59	Example for a clock program for equal duty cycling during the day	121
Tab. 60	Example for a clock program for equal duty cycling during the week	122
Tab. 61	Assigned output signals	125
Tab. 62	Logic	133
Tab. 63	Transmission of sensor value	137
Tab. 64	Checklist of installation conditions	139
Tab. 65	Information of a message	144
Tab. 66	Message abbreviations	144
Tab. 67	Operating mode display	146
Tab. 68	Displaying possible operating modes	147
Tab. 69	Operational Messages	150
Tab. 70	Check box status	153
Tab. 71	Fault messages and remedies	158
Tab. 72	System messages and remedies	163
Tab. 73	Warning messages and remedies	164

1 Regarding this document

1.1 Using this document

The operating manual contains important information to the entire life cycle of SIGMA CONTROL 2.

The operating manual is a component of the product.

- Keep the manual in a safe place throughout the life of SIGMA CONTROL 2.
- Pass the manual on to the next owner/user of the machine.
- Ensure that all amendments received are inserted into the operating manual.

1.2 Copyright

This operating manual is protected by copyright. Any queries regarding the use or duplication of this documentation should be referred to KAESER. Correct use of information will be fully supported.

1.2.1 Software

The software used in SIGMA CONTROL 2 contains copyright-protected software which is licensed by GNU General Public License in versions 2 and 3.

A copy of these licenses is contained in SIGMA CONTROL 2.

Display the licenses by pointing your browser to the "COPYING" file in the root directory of SIGMA CONTROL 2.

URL:

[http:// <Hostname>/ SIGMA CONTROL 2 COPYING](http://<Hostname>/SIGMA%20CONTROL%20COPYING)

The licenses can be also found under this address:

<http://www.gnu.org/licenses/gpl-2.0.txt>

<http://www.gnu.org/licenses/gpl.txt>

Within three years from receipt of SIGMA CONTROL 2, you may obtain the complete source code by sending a corresponding order to the following address:

HPC Engineering PLC

Victoria Gardens, Industrial Estate,

Burgess Hill, West Sussex, RH 15 9RQ.

Telephone (01444) 241671

Fax (01444) 247304

This offer is valid for anybody having this information.

1.3 Updating the operating manual

The page <http://www.kaeser.com/sc2manual> of our website provides frequently updated version of the operating manual.

Be prepared to provide the material number and the serial number of the machine in which the SIGMA CONTROL 2 is installed.

Both numbers can be found on the nameplate of the machine.

- Download the desired operating manual from our server and forward it to your operators.

1.4 Symbols and labels

➤ Please note the symbols and labels used in this document.

1.4.1 Warnings

Warning notices indicate dangers that may result in injury when disregarded.

Warning notices indicate three levels of danger identified by the corresponding signal word:

Signal term	Meaning	Consequences of non-compliance
DANGER	Warns of an imminent danger	Will result in death or severe injury
WARNING	Warns of a potentially imminent danger	May result in death or severe injury
CAUTION	Warns of a potentially dangerous situation	May result in a moderate physical injury

Tab. 8 Danger levels and their definitions (personal injury)

Warning notices preceding a chapter apply to the entire chapter, including all sub-sections.

Example:



DANGER

The type and source of the imminent danger is shown here!

The possible consequences of ignoring a warning are shown here.

If you ignore the warning notice, the "DANGER" signal word indicates a lethal or severe injury will occur.

➤ The measures required to protect yourself from danger are shown here.

Warning notes referring to a sub-section or the subsequent action are integrated into the procedure and numbered as an action.

Example:



1. **WARNING!**

The type and source of the imminent danger is shown here!

The possible consequences of ignoring a warning are shown here.

If you ignore the warning notice, the "WARNING" signal word indicates that a lethal or severe injury may occur.

➤ The measures required to protect yourself from danger are shown here.

2. Always read and comply with warning instructions.

1.4.2 Potential damage warnings

Contrary to the warnings shown above, damage warnings do not indicate a potential personal injury.

Warning notices for damages are identified by their signal term.

Signal term	Meaning	Consequences of non-compliance
NOTICE	Warns of a potentially dangerous situation	Damage to property is possible

Tab. 9 Danger levels and their definition (damage to property)

Example:

**NOTICE**

The type and source of the imminent danger is shown here!
Potential effects when ignoring the warning are indicated here.

➤ The protective measures against the damages are shown here.

➤ Carefully read and fully comply with warnings against damages.

1.4.3 Other alerts and their symbols

This symbol identifies particularly important information.

Material Here you will find details on special tools, operating materials or spare parts.

Precondition Here you will find conditional requirements necessary to carry out the task.
The conditions relevant to safety shown here will help you to avoid dangerous situations.

➤ This symbol denotes lists of actions comprising one stage of a task.
Operating instructions with several steps are numbered in the sequence of the operating steps.



Information referring to potential problems are identified by a question mark.
The cause is named in the help text ...

➤ ... as is a solution.



This symbol identifies important information or measures regarding the protection of the environment.

Further information Further subjects are introduced here.

2 Technical Specifications

2.1 SIGMA CONTROL 2 Controller

Industrial computer

- Internal temperature monitoring
- Internal undervoltage monitoring
- Battery-buffered real-time clock
 - Battery life span more than 10 years
 - Battery replaceable

2.1.1 User interface with display, CPU and interfaces

User interface

Feature	Value
Material	Plastics
Width [mm]	190
Height [mm]	130
Depth [mm]	45
Number of membrane keys	13
Number of LEDs	9
Degree of protection, control cabinet exterior	IP 54
Degree of protection, control cabinet interior	IP 20
Voltage [V]	24
Current [A]	0,3
Voltage source	Input/output module

Tab. 10 User interface

Display

Feature	Value
Graphical display [px]	255 x 128
Width [mm]	82
Height [mm]	41
Maximum number of lines/characters	8/30
Colours	Black/white with gray levels
Lighting	LED backlit
px $\hat{=}$ pixel	

Tab. 11 Display data

Interfaces

Interface	Connection	Marking
Ethernet 10/100 Base T	RJ 45 socket	X1
IO bus	9-pole SUB-D pins	X2
RS485–FC (USS interface)	9-pole SUB-D socket	X3
COM modules, slot for communications module	Module optional for: Profibus, Modbus, Profinet, Devicenet	X4
SD card, SD card slot	SD/SDHC card	X5

The positions of the interfaces X1–X5 are marked on the rear of the controller.

Tab. 12 Interfaces

Identification with RFID Equipment Card

Feature	Value
Hardware on the SIGMA CONTROL 2 controller	RFID write/read device
Hardware (external)	KAESER Equipment Card
Recognition distance [m]	Max. 0.05
Frequency [MHz]	13,56

Tab. 13 RFID

2.1.2 Input/output modules

There are three different types of input/output modules with different amounts of inputs and outputs.

The actually available number of input/output modules depends on the machine type and the available options.

Refer to the machine's wiring diagram for the input/output modules installed in your equipment.

Every input/output module is equipped with:

- Internal temperature monitoring
- Internal undervoltage monitoring
- LED indication of operational status

IOM 1

Input/Output	Input/output module 1		
	Internal, into the control cabinet	available in parallel on both sides	External, into the compressor interior
Digital input (DI), 24 VDC	4	10	2
Analog input current (AII), 0–20 mA	–	1	2
Analog input resistor (AIR), PT100	–	1	3
Digital output relay (DOR), 250 VAC, 8 A	8	–	–
Digital output transistor (DOT), 24 VDC, 0.5 A	–	2	1

Input/Output	Input/output module 1		
	Internal, into the control cabinet	available in parallel on both sides	External, into the compressor interior
Analog output current (AOI), 0–20 mA	–	–	–

Tab. 14 SC2IOM-1

IOM 2

Input/Output	Input/output module 2		
	Internal, into the control cabinet	available in parallel on both sides	External, into the compressor interior
Digital input (DI), 24 VDC	6	–	2
Analog input current (AII), 0–20 mA	–	1	2
Analog input resistor (AIR), PT100	–	3	–
Digital output relay (DOR), 250 VAC, 8 A	4	–	–
Digital output transistor (DOT), 24 VDC, 0.5 A	–	2	2
Analog output current (AOI), 0–20 mA	–	1	–

Tab. 15 SC2IOM-2

IOM 3

Input/Output	Input/output module 3		
	Internal, into the control cabinet	available in parallel on both sides	External, into the compressor interior
Digital input (DI), 24 VDC	6	–	2
Analog input current (AII), 0–20 mA	–	1	3
Analog input resistor (AIR), PT100	–	3	8
Digital output relay (DOR), 250 VAC, 8 A	8	–	–
Digital output transistor (DOT), 24 VDC, 0.5 A	–	1	1
Analog output current (AOI), 0–20 mA	–	1	–

Tab. 16 SC2IOM-3

2.1.2.1 Power supply specifications

Power is provided by the power supply unit within the machine.

Feature	Value
Rated power supply (stabilised) [V DC]	24
Current consumption SIGMA CONTROL 2 with IOM 1 [A]	2,4
Current consumption IOM 2 [A]	2,5
IOM ≙ input/output module	

Feature	Value
Current consumption IOM 3 [A]	1,6
IOM \triangleq input/output module	

Tab. 17 Power supply specifications

2.1.2.2 Maximum cable lengths

Input/Output	Conductor length [m]
Analog input current (AI), Analog input resistor (AIR) Analog output current (AOI)	< 30
Digital input (DI), Digital output relay (DOR)	< 100
Digital output resistor (DOT)	< 30

Tab. 18 Cable lengths

2.1.2.3 Input/output modules – degree of protection

Feature	Value
Degree of protection within the machine	IP 54
Degree of protection within the control cabinet	IP 20

Tab. 19 Degree of protection, IOM

2.1.2.4 Input/output modules – dimensions

Feature	Value
Width [mm]	125
Height [mm]	250
Depth [mm]	44

Tab. 20 IOM dimensions

2.1.3 Sensors
Pressure transducer

Feature	Value
Output signal [mA]	0/4–20
Connection	Twin cable

Tab. 21 Pressure transducer

Resistance thermometer

Feature	Value
Sensing resistance (to DIN IEC 751)	PT100

Feature	Value
Connection	Twin cable

Tab. 22 Resistance thermometer

3 Safety and Responsibility

3.1 Basic instructions

SIGMA CONTROL 2 is manufactured to the latest engineering standards and acknowledged safety regulations.

The safety regulations of the machine in which SIGMA CONTROL 2 is installed apply.

3.2 Specified use

SIGMA CONTROL 2 is solely intended for the control of machines in which SIGMA CONTROL 2 is factory-installed. Any other use is considered incorrect. The manufacturer is not liable for any damages that may result from incorrect use. The user alone is liable for any risks incurred.

- Adhere to the specifications given in these operating instructions and the machine's service manual.
- Operate the machine only within its performance limits and under the permitted ambient conditions.

3.3 Improper use

Improper usage can cause damage to property and/or (severe) injuries.

- Use SIGMA CONTROL 2 only as intended.
- Do not use SIGMA CONTROL 2 to control other machines or products for which SIGMA CONTROL 2 is not intended.

4 Design and Function

4.1 The controller

SIGMA CONTROL 2 controls, regulates, monitors, and protects the machine.

All parameters needed to operate HPC rotary screw compressors can be set and displayed using the controller. Various user-dependent password mechanisms protect the parameters.

Components

SIGMA CONTROL 2 has the following components:

- **Main Control System (MCS):**
 - Industrial PC
 - Software for the control, regulation, and monitoring of the machine, for the display and modification of settings and for communication.
 - User interface with backlit display, touch keys, LEDs, and interfaces.
 - **Radio Frequency Identification (RFID):**
Identification with the KAESER RFID Equipment Card
 - Slot for customer interface; optional communications module
 - SD card slot for SD/SDHC cards:
Manual loading of updates with an SC card, reading or recording process data
- **Input-Output-Module (IOM):**
Modules with digital and analog inputs and outputs with their own power supply.

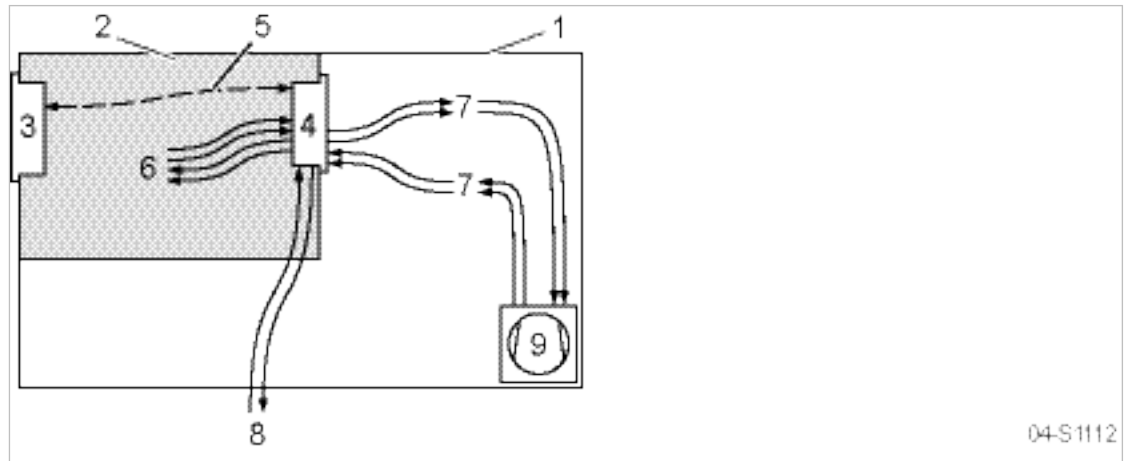

Fig. 3 System structure

- | | |
|-----------------------|---------------------------------------------------------|
| ① Machine enclosure | ⑥ Inputs/outputs in the interior of the control cabinet |
| ② Control cabinet | ⑦ Inputs/outputs in the interior of the compressor |
| ③ SIGMA CONTROL 2 | ⑧ Inputs/outputs for external sensors |
| ④ Input/output module | ⑨ Compressor |
| ⑤ IO bus | |

Function

The **control and regulating function** allows:

- Automatic changeover of the machine from LOAD to IDLE or READY.

- Optimum utilisation of the drive motor in relation to the user's actual air demand.
- Automatic restart of the machine after a power failure (can be deactivated).

The **monitoring function** allows:

- Supervision of all maintenance-relevant components via the maintenance interval counters.
- Display of warning and maintenance messages for due maintenance on the display of the SIGMA CONTROL 2 .

The **protective function** allows:

- Automatic machine shutdown on alarms that may lead to damage to the machine, e.g. overcurrent, overpressure, overtemperature.

4.2 Operating panel

Keys

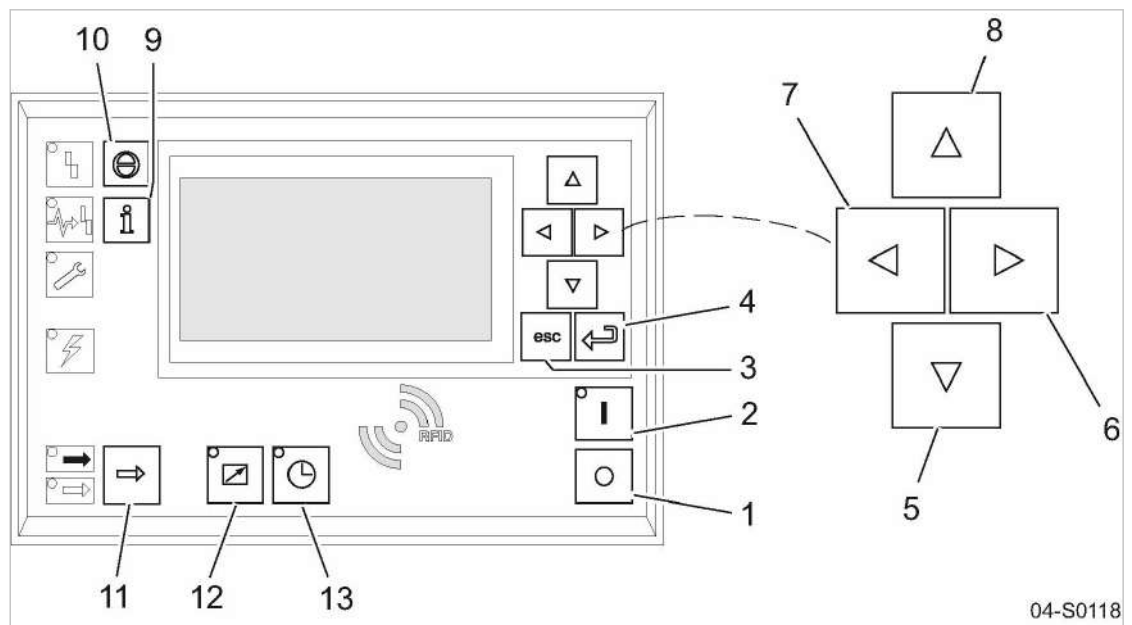

Fig. 4 Keys – overview

Position	Name	Function
1	«OFF»	Switches the machine off.
2	«ON»	Switches the machine on.
3	«Escape»	Returns to the next higher menu option level. Exits the edit mode without saving.
4	«Enter»	Jumps to the selected menu option. Exits the edit mode and saves.
5	«Down»	Scrolls down the menu options. Reduces a parameter value.
6	«Right»	Jumps to the right. Moves the cursor position to the next right field.

Position	Name	Function
7	«Left»	Jumps to the left. Moves the cursor position to the next left field.
8	«Up»	Scrolls up the menu options. Increases a parameter value.
9	«Information»	Operating mode: Displays the event memory.
10	«Acknowledgement»	Confirms/acknowledges alarms and warning messages. If permissible: Resets the fault counter (RESET).
11	«LOAD/IDLE»	Toggles between the LOAD and IDLE operating modes.
12	«Remote control»	Switches the remote control on and off.
13	«Time control»	Switches the time control on and off.

Tab. 23 Keys

Indicators

Fig. 5 Indicators – overview

Position	Name	Function
14	Display	Graphic display with 8 lines and 30 characters per line.
15	<i>Fault</i>	Flashes red to indicate a machine fault. Continuous red light after acknowledgement.
16	<i>Communications error</i>	Continuous red light to indicate a faulty communication connection, or an external fault message without machine shut-down.

Position	Name	Function
17	<i>Warning</i>	Flashes in yellow in the following events: <ul style="list-style-type: none"> ■ Maintenance work due ■ Warning message <p>Continuous yellow light after acknowledgement.</p>
18	<i>Voltage applied to controller</i>	Continuous green light when voltage is applied to the controller.
19	<i>LOAD</i>	Continuous green light when the machine is running in LOAD.
20	<i>IDLE</i>	Continuous green light when the machine is running in IDLE. Flashes when the «LOAD/IDLE» toggle key is pressed.
21	<i>Remote control</i>	Continuous green light when the machine is in remote control.
22	<i>Time control</i>	Continuous green light when the machine is controlled by the timer.
23	<i>ON</i>	Continuous green light when the machine switched on.

Tab. 24 Indicators

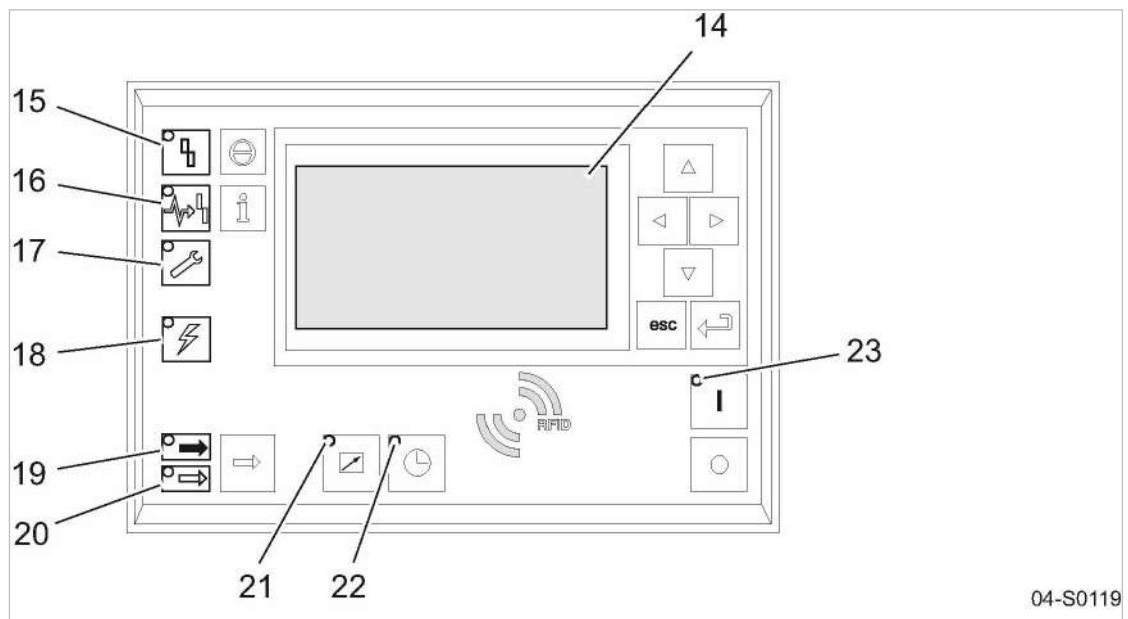
RFID reader

RFID is the abbreviation for “Radio Frequency Identification” and enables the identification of persons or objects.

Placing a suitable transponder in front of the RFID reader of the controller will automatically activate the communication between transponder and SIGMA CONTROL 2 .

A suitable transponder is the KAESER RFID Equipment Card. Two of them have been provided with the machine.

Typical application:

- Users log on to the machine.
(no manual input of the password required.)



The KAESER RFID Equipment Cards are carefully packed in a plastic sleeve. This plastic sleeve is attached to the rear of the controller in the control cabinet.

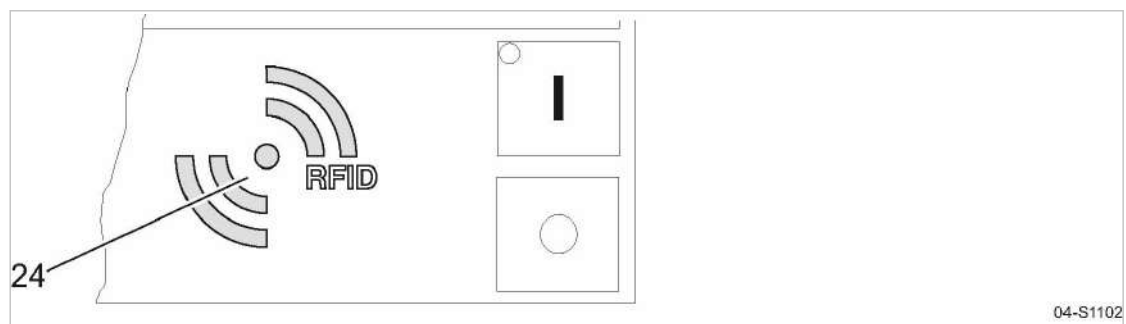

Fig. 6 RFID reader

Position	Name	Function
24	RFID	RFID reader for the communication with a suitable RFID transponder.

Tab. 25 RFID reader

4.3 Display

Use the display to read information and to enter data. The display comprises 8 lines, each of 30 characters.

During operation, the display will indicate the operating mode.

Pressing «Enter» or one of the arrow keys opens the main menu. Here, you can set the language to be used for the display of texts or open the various submenus.

4.3.1 Operating mode

6.1 bar 08:15 80.0 °C	
----- Alarm -----	Current operating mode
Key – off # – off -----	Operating parameters
Run 2500 h Load 2490 h Maintenance in 500 h	Operating parameters

Header

The header is the topmost line on the display. It is always shown as white text on a black background.

The following parameters are displayed permanently on the title bar:

- Working pressure
- Time
- Aired discharge temperature

Lines 3 and 5: Operational state

Depending on the settings, either the current state of the machine or a menu text is shown in line 3. The following parameters with their current values are displayed in line 5:

- Remote control yes/no
- Time control yes/no
- Pressure control

Lines 7 and 8: Machine state

The following parameters with their current values are displayed in lines 7 and 8:

- The hours during which the machine was activated
- The hours during which the machine ran in operating mode LOAD.
- Remaining working hours of the machine before the next maintenance

4.3.2 Main menu

6.1 bar 08:15 80.0 °C	
..... Deutsch	Language
▶1 Status	Submenu
▶2 Performance data	Submenu (here: active line)
▶3 Operating data	Submenu
▶4 Maintenance	Submenu
▶5 Configuration	Submenu
▶6 Compressor clock	Submenu

Representation

The main menu is the top menu level. You open the individual submenus in the main menu.

A scrollbar appears at the right side of the display if you open a menu with more than 6 lines. It represents the currently visible portion of the menu. A short scrollbar thus indicates that the opened menu is very long as only a small portion can be displayed.

The image above provides an example for the appearance of the main menu (without scrollbar).

Numbering

Each menu is numbered.

Not all menus may be displayed because the access to certain menus is restricted by the access level, and some menus are displayed or hidden due to specific settings or options.

For example, you can recognise subordinate menus in the menu structure by the number preceding their designation. The menu structure is explained in chapter 4.6.2.

Active line

The active line is always shown as white text on a dark background. Do not confuse this with the header which is also shown with white lettering on a black background.

Press «Enter» to open a menu in the active line. This opens the selected menu. Here, you can change parameters.

Further information For the setting of parameters see chapter 4.3.3.

4.3.3 Setting parameters



In order to set a parameter in the active line of the selected menu, you must always switch to setting mode.

You move to setting mode by:

Press «Enter». The value of the parameter will flash indicating that it can be changed.

Changing parameters

Press «Enter». The value of the parameter will flash indicating that it can be changed.

The «Enter» key affects only the active line.

In some lines, you can change more than a single parameter.

In this case, you must first select the specific parameter with the «Left» or «Right» keys.

Resetting current parameters

In order to reset current parameters to Zero, activate the check box for *Reset* in the active line of the display.

First, press «Enter» to switch into setting mode. The check box *Reset* will flash.

You then press «UP». The check box is activated and flashes.

Press «Enter» to save the settings.

The parameters no longer flash and are reset. The check box for *Reset* is again deactivated.

Check box <i>Reset</i>	Status
<input checked="" type="checkbox"/>	activated
<input type="checkbox"/>	deactivated

Tab. 26 Reset check box status

4.3.4 Activating keys with check boxes

Certain keys of the SIGMA CONTROL 2 are locked by default. Activate the corresponding check boxes in the active line of the display to unlock these keys.

First, press «Enter» to switch into setting mode. The check box will flash.

You then press «Up». The check box is activated and flashes.

Press again «Enter» to save the settings.

The display line no longer flashes and the key is activated.

Proceed correspondingly to deactivate a key.

Check box	Status
<input checked="" type="checkbox"/>	activated
<input type="checkbox"/>	deactivated

Tab. 27 Check box status

4.4 Access rights

Access to the controller is governed by the user name combined with a password.

Users log on using an RFID Equipment Card by default. Alternatively, you can manually enter the user name and the password.



Throughout this operating manual, the RFID Equipment Card will be simply called the "Equipment Card".

When the controller is switched on, the lowest level of access (level 0) is activated.

You have access to a further level: Level 2.

In level 2, you can display and specify further parameters and, for instance, reset the system pressure or the maintenance counters.

The access level will automatically return to level 0 after 10 minutes without any key being pressed.

4.4.1 Secure storage of the RFID Equipment Cards

You will receive 2 RFID Equipment Cards with each machine.

They are stored in a plastic sleeve.

This plastic sleeve is attached at the rear of the controller in the control cabinet.

If you lose both Equipment Cards, you can register a new Equipment Card only after having entered the user name and the password. A new Equipment Card may be registered by the HPC Service subject to a fee, if the user name and the password are lost.

4.5 Checking the machine status with KAESER CONNECT

Using a PC with web browser, you can call up a visualisation of your machine's controller and thus check the economy and energy efficiency of the machine. KAESER CONNECT does not require additional and expensive special software applications. KAESER CONNECT selectively visualises the current status of your controller in your country's language.

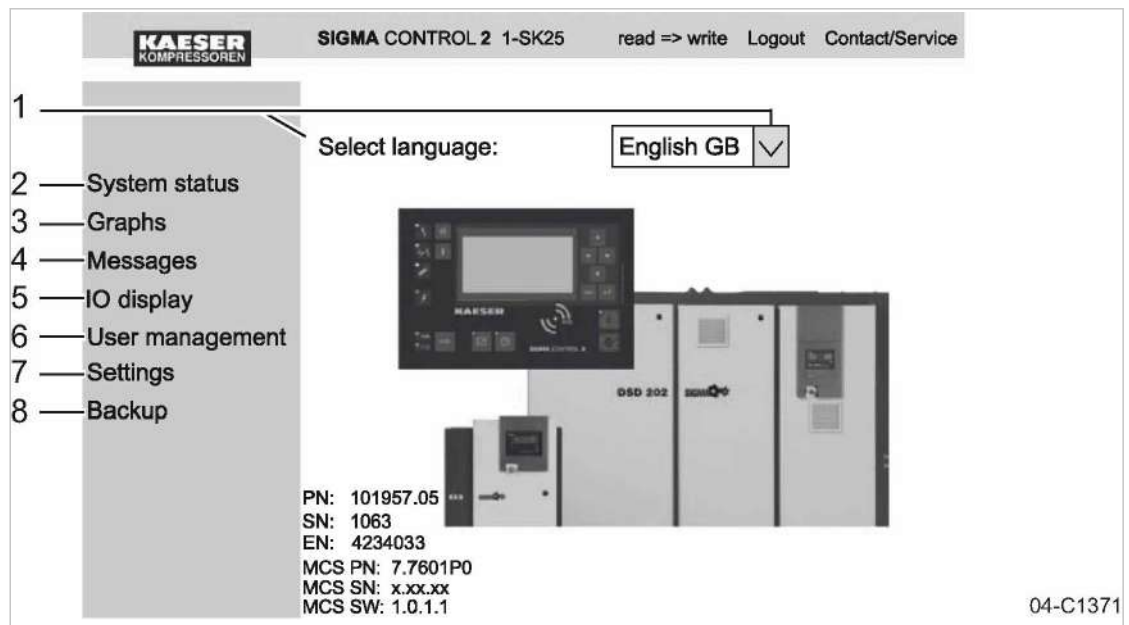

Fig. 7 KAESER CONNECT for SIGMA CONTROL 2

- | | |
|----------------------|-----------------------|
| ① Language selection | ⑤ IO display |
| ② System status | ⑥ User administration |
| ③ Graphs | ⑦ Settings |
| ④ Messages | ⑧ Data backup |

KAESER CONNECT functions:

- System status
 - Mapping of the local menu
- Graphs
 - Graphic representation of the mains pressure and airtend discharge temperature along the time axis.
 - Graphic representation of the compressor status (STOP, IDLE, LOAD) and RPM along the time axis.

- Messages
 - Current messages
 - Message history (event memory)
- IO display
 - Assignment of the input/output modules
- User administration
 - Creating and activating new user accounts.
 - Deactivating existing user accounts.
 - Changing passwords.
- Settings
 - Unit display format
 - Date display format
 - Time display format
- Data backup
 - Writing data to your own PC.

Further information For the installation of the Ethernet cables, the Login and other procedures, please see chapter 7.3.

Header

- Please note the designations in the menu's header. The designations cover user-friendly functions such as:
- Activate write mode:
 - You switch from read mode to write mode to create a new user account, for example.
- Closing KAESER CONNECT:
 - Logout function in the header.
- Contact KAESER Service:
 - Display of KAESER Service addresses.

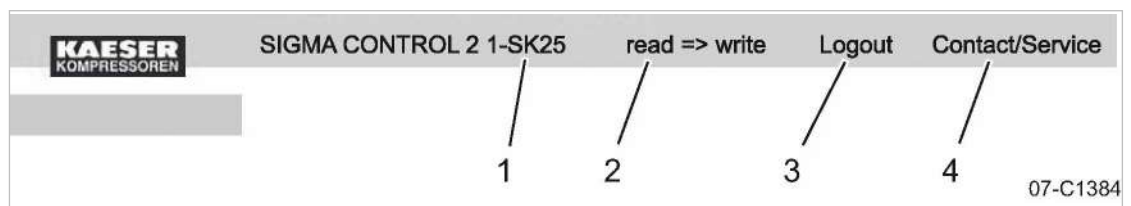

Fig. 8 Header

- | | | | |
|---|---------------------|---|------------------------|
| ① | Machine designation | ③ | Logout |
| ② | Write mode | ④ | Contact KAESER Service |

4.6 Menus – overview

4.6.1 Operating mode

When the machine is switched on, details of the software are displayed, for example,

Compressor		
PN :	SN :	Machine model
EN :		Material number and serial number of the machine
		Equipment number of the machine
SIGMA CONTROL 2 MCS		MCS: Main Control System
PN :	SN :	Material number and serial number of the controller
Software :		Software version

Subsequently, the software is loaded and the current operating mode is displayed (example):

6.1 bar	08:15	80.0 °C	

Alarm			Current operating mode

Key – off # – off			Operating parameters

Run 2500 h Load 2490 h			Operating parameters
Maintenance in 500 h			

The following parameters are displayed:

- Operating mode of the machine
- Information to the «LOAD/IDLE» keys, «Remote control» or «Timer»
- Value for the system setpoint pressure pA
- Number of operating hours and hours of the machine being in LOAD mode.

The operations menu provides the most important parameters during the machine's operation.

4.6.2 Menu structure

Pressing «Enter» or one the arrow keys opens the main menu.

In the main menu, you can:

- Retrieve displayed information
- Enter customer-specific settings

The menus shown require access level 2.

Main menu

Navigation	Function/submenu
1 Status	<ul style="list-style-type: none"> ■ Messages <ul style="list-style-type: none"> – Status report – Current warnings – Current faults ■ Statistics ■ Current pressure regulation ■ Current operating mode ■ DI/DO display ■ Diagram: Nominal pressure/airend discharge temperature <p>For details of the <Status> menu, see table 29 “Status menu”.</p>
2 Performance data	<p>Display of the following measured data:</p> <ul style="list-style-type: none"> ■ System pressure pNloc ■ ADT (airend discharge temperature) Increased speed ADT ■ Δp/Oil separator ■ Starting temp. ■ Temperature MCS (Main Control System) ■ Temperature, first IOM
3 Operating data	<p>Operating hours</p> <ul style="list-style-type: none"> ■ Compressor ■ Load ■ Motor ■ Airend ■ SIGMA CONTROL 2 <p>kWh counter</p> <ul style="list-style-type: none"> ■ Active ■ Counting pulses ■ kWh ■ Reset <hr/> <p>Load valve ON</p>

Navigation	Function/submenu
4 Maintenance	<ul style="list-style-type: none"> ■ Oil filter ■ Oil separator ■ Oil change ■ Air filter ■ Valve inspection ■ Belts, coupling inspection ■ Bearing lubrication ■ Motor bearings ■ Electrical equipment ■ Annual maintenance
5 Configuration	For details of the <i><Configuration></i> menu, see table 30 “Configuration menu”.
6 Compressor clock	Activate/deactivate compressor timer Delete/reset the existing clock program Entering weekdays and times: <ul style="list-style-type: none"> ■ Switching point 01: ■ Switching point 02: ■ Switching point 03: ■ Switching point 04: ■ Switching point 05: ■ Switching point 06: ■ Switching point 07: ■ Switching point 08: ■ Switching point 09: ■ Switching point 10
7 User	<ul style="list-style-type: none"> ■ Name ■ Password ■ Current access level
8 Communication	<ul style="list-style-type: none"> ■ Ethernet ■ COM module Activating/deactivating the «Remote control» key For details of the <i><Communication></i> menu, see table 33 “Communication menu”.
9 Machine test	<ul style="list-style-type: none"> ■ TÜV check
10 Components	<ul style="list-style-type: none"> ■ Compressor motor <ul style="list-style-type: none"> – Power switching For details of the <i><Components></i> menu, see table 40 “Components menu”.

Tab. 28 Menu structure

4.6.2.1 Status menu

Navigation	Function/submenu
1.1 Messages	<ul style="list-style-type: none"> ■ Current messages ■ Message history (event memory) <ul style="list-style-type: none"> – Compressor messages – Diagnostic messages – System messages <hr/> Status report <hr/> Current warnings Current faults
1.2 Statistics	<ul style="list-style-type: none"> ■ Overall load ■ pNloc actual system pressure <ul style="list-style-type: none"> – maximal – minimal ■ Total number of motor starts ■ Motor starts per day Motor starts per hour ■ Total number of motor starts below minimum temperature ■ Last load run ■ Last idle run ■ Last motor OFF
1.3 Current pressure control	<ul style="list-style-type: none"> ■ SIGMA CONTROL 2 ■ Cut-out pressure ■ Actual system pressure
1.4 Current operating mode	<ul style="list-style-type: none"> ■ Compressor ON Load control ■ Regulating mode Idle time ■ Acknowledgement
1.5 DI/DO status	<ul style="list-style-type: none"> ■ First I/O module <ul style="list-style-type: none"> – DI/DO display ■ Second I/O module <ul style="list-style-type: none"> – DI/DO display ■ Third I/O module <ul style="list-style-type: none"> – DI/DO display ■ Fourth I/O module <ul style="list-style-type: none"> – DI/DO display ■ Fifth I/O module <ul style="list-style-type: none"> – DI/DO display ■ Sixth I/O module <ul style="list-style-type: none"> – DI/DO display

Navigation	Function/submenu
1.6 pN/ADT curve	Diagram: Nominal pressure/air end discharge temperature

Tab. 29 Status menu

4.6.2.2 Configuration menu

Navigation	Function/submenu
5.1 General	Machine model Date and time Date format Time format Pressure unit Temperature unit Display illumination <hr/> System data <ul style="list-style-type: none"> ■ SIGMA CONTROL 2 MCS <ul style="list-style-type: none"> – Software – KAESER: <ul style="list-style-type: none"> Material number Serial number – Controller manufacturer: <ul style="list-style-type: none"> Material number Serial number Date of manufacture ■ Compressor <ul style="list-style-type: none"> – Equipment number – Material number – Serial number ■ IO modules <ul style="list-style-type: none"> – First IOM
5.2 Pressure control	<ul style="list-style-type: none"> ■ Pressure sensors ■ Pressure settings ■ Load control ■ Actual system pressure <p>For details of the <Pressure control> menu, see table 31 “Pressure control menu”.</p>
5.3 Control mode	Local mode <ul style="list-style-type: none"> ■ Venting period ■ DUAL ■ QUADRO ■ Mod.valves

Navigation	Function/submenu
5.4 Compressor start	<ul style="list-style-type: none"> ■ Compressor ON ■ Compressor OFF Auto start Cut-in lock Start temperature
5.5 Acknowledgement	Remote operation «Remote control» key Acknowledging the remote contact
5.6 ADT	<ul style="list-style-type: none"> ■ AIR 1.00 Conduit correction ■ Rate of rise of the airend discharge temperature
5.7 I/O periphery	<ul style="list-style-type: none"> ■ DO functions ■ Analog values ■ External messages ■ Switch For details of the <i></I/O periphery></i> menu, see table 32 "I/O periphery menu".
5.8 Timer	<ul style="list-style-type: none"> ■ ON ■ OFF ■ DOR 1.03
5.9 Refrigeration dryer	<ul style="list-style-type: none"> ■ Control mode <ul style="list-style-type: none"> – Compressor standby – Compressor clock/FK/FB off ■ Temperature high ■ Temperature low ■ Activate fault mode

Tab. 30 Configuration menu

Pressure control menu

Navigation	Function/submenu
5.2.1 Pressure sensors	<ul style="list-style-type: none"> ■ System pressure pNloc ■ Internal pressure pi
5.2.2 Pressure settings	<ul style="list-style-type: none"> ■ pRV Pressure relief valve opening pressure ■ Pressure increase ■ Nominal pressure ■ System setpoint pressure ■ System pressure low ■ Minimum cut-in pressure

Navigation	Function/submenu
5.2.3 Load control	<ul style="list-style-type: none"> ■ Set local mode ■ Set remote operation Activate/deactivate «Remote control» key ■ Timer operating mode pA/pB ■ Remote contact operating mode pA/pB ■ Assign load mode remote contact ■ Assign local load remote contact: ■ Activate/deactivate the IDLE key
5.2.4 Network actual pressure	Actual system pressure (pNloc) All

Tab. 31 Pressure control menu

I/O periphery menu

Navigation	Function/submenu
5.7.1 DO functions	Controller on ON Motor running IDLE LOAD Group fault Group warning Remote operation Timer active EMERGENCY-OFF <ul style="list-style-type: none"> ■ Timer contact (enter timing program)
5.7.2 Analogue values	Configure display of measured values <ul style="list-style-type: none"> ■ Display 1 (p) ■ Display 2 (p) ■ Display 3 (T) ■ Display 4 (T) ■ Display 5 (I) ■ Display 6 (I)
5.7.3 External messages	Configure display of external messages <ul style="list-style-type: none"> ■ External message 1 ■ External message 2 ■ External message 3 ■ External message 4 ■ External message 5 ■ External message 6

Navigation	Function/submenu
5.7.4 Switch	Configuring the switching points for pressure and temperature <ul style="list-style-type: none"> ■ System pressure pNloc ■ Internal pressure pi ■ Airend discharge temperature (ADT) ■ Inlet temperature ■ Compressed air outlet temperature (PD)

Tab. 32 I/O periphery menu

4.6.2.3 Communication menu

Navigation	Function/submenu
8.1 Ethernet	<ul style="list-style-type: none"> ■ IP configuration <ul style="list-style-type: none"> – IP address – Subnet mask – Gateway – DNS Server 1 – DNS Server 2 – Network restart ■ Connections <ul style="list-style-type: none"> – SIGMA CONTROL 2 – Control technology <p>Restart Time-out Cycle time</p> <p>For details of the < <i>Connections</i> > menu, see table 39 "Connections menu".</p> <ul style="list-style-type: none"> ■ E-mail <ul style="list-style-type: none"> – Activate/deactivate e-mail Compressor number Language Interval – Sender address Sender name Telephone number contact person Recipient address – SMTP server User name – Port Repeated sending to

Navigation	Function/submenu
8.2 Com-Module	The following communications module may be used optionally: Profibus Modbus Modbus TCP DeviceNet Profinet Details regarding the <Com modules> menu are provided in tables 34, 35, 36, 37, 38.

Tab. 33 Communication menu

4.6.2.4 COM module – menu

Navigation	Function
8.2 Com-Module	Profibus: Status Start Com module Slave number Reset Bus fault Start time Time-out

Tab. 34 Profibus

Navigation	Function
8.2 Com-Module	Modbus: Status Start Com module Slave number Reset Bus fault Start time Time-out Baud rate Stop bits Parity Time-out Modus

Tab. 35 Modbus

Navigation	Function
8.2 Com-Module	Modbus TCP Status COM module start Reset Bus fault Start time Time-out Use P settings IP address Subnet mask Gateway DNS Server 1 DNS Server 2

Tab. 36 Modbus TCP

Navigation	Function
8.2 Com-Module	DeviceNet Status Start Com module Slave number Reset Bus fault Start time Time-out

Tab. 37 DEVICENET

Navigation	Function
8.2 Com-Module	Profinet Status COM module start Reset Bus fault Start time Time-out Permit IP configuration IP address Subnet mask Gateway DNS Server 1 DNS Server 2 Station name

Tab. 38 PROFINET

4.6.2.5 Menu: Connections

Navigation	Function/submenu
8.1.2 Connections	<ul style="list-style-type: none"> ■ SIGMA CONTROL 2 <ul style="list-style-type: none"> – Status – Mode: Master/Slave Port – IP address of communication partner – Communication alarm ■ Control technology <ul style="list-style-type: none"> – JSON-RPC active – IP address – Port

Tab. 39 Connections menu

4.6.2.6 Menu: Components

Navigation	Function/submenu
10.1 Compressor motor	<ul style="list-style-type: none"> ■ Power switching <ul style="list-style-type: none"> – Star-delta start – Direct start – High-voltage cell – SFC USS – Softstart <p>Mains contactor hysteresis, total For details of the <i><Power switching module></i> menu, see table 41 “Power switching module – menu”.</p>

Tab. 40 Components menu

4.6.2.7 Menu: Power switching

Navigation	Function/submenu
10.1.1 Power switching	<ul style="list-style-type: none"> ■ Star-delta start <ul style="list-style-type: none"> – Temperature, warm start – Star time at warm start – Star time at cold start – Star/Delta changeover time – Overload relay – Mains contactor – Star contactor – Delta contactor ■ Direct start <ul style="list-style-type: none"> – Acceleration time – Overload relay – Mains contactor ■ High-voltage cell <ul style="list-style-type: none"> – Acceleration time – ready – Mains contactor ■ SFC USS <ul style="list-style-type: none"> – Service mode – Mains contactor ■ Softstart <ul style="list-style-type: none"> – ready – Engine running – Run-up over – Start – Reset – Mains contactor

Tab. 41 Power switching module – menu

4.7 Operating modes and control modes

4.7.1 Operating modes

STOP

The machine is connected to the power supply.
 The *Controller on* LED lights green.
 The machine is switched off. The *ON*LED is extinguished.

READY

The machine has been activated with «ON»:

- The *ON*LED lights green.

- The drive motor is stopped.
- The inlet valve is closed.
- The minimum pressure/check valve shuts off the oil separator from the distribution network.
- The venting valve is open.

The compressor motor starts as soon as system pressure is lower than the set point pressure (cut-off pressure).

In addition, timing and/or remote control may affect the start of the motor.

LOAD

The compressor motor runs under load.

- The inlet valve is open.
- The airend delivers compressed air to the distribution network.

IDLE

The compressor motor runs unloaded with low power consumption.

- The inlet valve is closed.
- The minimum pressure/check valve shuts off the oil separator from the distribution network.
- The venting valve is open.

A small volume of air circulates through the bleed hole in the inlet valve, through the airend and back to the inlet valve via the venting line.

4.7.2 Control modes

Using the selected control mode, the controller switches the machine between its various operational states in order to compensate for air being drawn by consumers, and to maintain the system pressure between the set minimum and maximum values. The control mode also rules the degree of energy efficiency of the machine.

The machine-dependant venting phase between the LOAD and READY operating modes ensures load changes at minimum material stresses.

The controller SIGMA CONTROL 2 can operate in the following modes:

- DUAL
- QUADRO
- VARIO
- DYNAMIC
- Option C1 ■ MODULATING control

DUAL

In the DUAL control mode, the machine is switched back and forth between LOAD and IDLE to maintain the machine working pressure between the preset minimum and maximum values. When maximum pressure is reached, the machine switches to IDLE. When the preset *idling time* has elapsed the machine is READY.

The *idling time* is factory preset according to the maximum starting frequency of the compressor motor. The shorter the *idling time* setting, the sooner (and more frequently) the drive motor is stopped.

QUADRO

In contrast to the the DUAL regulating mode, the machine will switch from LOAD to READY in QUADRO mode after periods with low compressed air consumption.

After periods with a high compressed air consumption, the machine will switch from LOAD to READY after passing through IDLE.

In this control mode, the controller requires two specified times: The *running time* and the *idle/standstill time*.

The shorter these times are set, the sooner (and more frequently) the motor is stopped.

VARIO

The VARIO mode is based on the DUAL control mode. The difference to DUAL is that the *idling time* is automatically lengthened or shortened to compensate for higher or lower machine starting frequencies.

CONTINUOUS

In the DUAL control mode, the machine is switched back and forth between LOAD and IDLE, in order to maintain the machine working pressure between the preset minimum and maximum values. When maximum pressure is reached, the machine switches to IDLE. However, the machine does **not** switch to READY.

DYNAMIC

In contrast to the the DUAL regulating mode, the machine will switch from LOAD to READY in DYNAMIC mode at low drive motor temperature.

And from LOAD via IDLE to READY at a high drive motor temperature.

The lower the drive motor temperature, the sooner (and, therefore, more often and longer) it is stopped.

Option C1 MODULATING control

The MODULATING control is an additional mechanical regulation. It continuously changes the delivery volume within the machine's control range.

A control valve, the proportional controller, changes the degree of opening of the inlet valve when the machine transports compressed air into the air network (LOAD)

The load and power consumption of the drive motor rises and falls with the air demand.

4.7.3 Frequency-controlled drive (SFC)

If the machine runs in LOAD, the frequency converter compares the ACTUAL value with the TARGET value of the system pressure and regulates, depending on the difference, the speed of the compressor motor and the air end.

The speed of the air end determines the rate of compressed air delivery and the working pressure.

If air consumption rises, the frequency converter increases motor speed and therefore increases the volume of air delivered.

If air consumption drops, the converter reduces motor speed and therefore reduces the volume of air delivered.

The network pressure remains constant – within the control range of the converter – regardless of fluctuating air demand.

If the network pressure exceeds the TARGET value:



Outside the frequency converter's range of control the machine reverts to the selected control mode.

DUAL:

The minimum controllable speed is reached and the machine switches to IDLE. The drive motor runs unloaded with low power consumption.

When the preset idling time has elapsed, the machine switches to READY.

VARIO/QUADRO/CONTINUOUS:

The minimum controllable speed is reached and, depending on the air demand at the time, the machine switches either to READY or to IDLE.

DYNAMIC:

The minimum controllable speed is reached and, depending on the air temperature of the drive motor, the machine switches either to READY or to IDLE.

If the network pressure falls below the TARGET value:

The frequency converter runs the motor up to a speed at which air delivery matches the air demand.

The inlet valve opens and the machine delivers compressed air.

The frequency converter varies the speed of the drive motor according to the air demand. The power consumption of the drive motor rises and falls according to air demand.

4.7.4 MODULATING control

With the help of a mechanical control valve (the proportional controller), the opening and closing of the inlet valve is continuously varied in relation to the actual air demand. The machine delivers compressed air to the distribution network.

The load and power consumption of the drive motor rises and falls with the air demand.

To ensure optimal control on large compressors, the control air for the proportional controller is taken from an external air receiver.

5 Installation and Operating Conditions

5.1 Maintaining ambient conditions

- Follow the instructions in the machine's service manual.

5.2 Installation conditions

The installation and operating conditions depend the machine into which the controller is installed.



NOTICE

UV radiation!

Direct sunlight (UV radiation) can destroy the display screen.

- Do not allow the display screen to be subjected to direct sunlight.
- See the machine's operating manual for required conditions.

6 Installation

6.1 Reporting Transport Damage

1. Check the machine for visible and hidden transport damage.
2. Inform the carrier and the manufacturer in writing of any damage without delay.

6.2 Machine identification

If the machine is run in sequenced operation its identification as detailed in the installation diagram is to be taken into account.

Identifying the machine for operation in remote mode.

- Attach the following notice to warn of remote machine operation (suggestion):

⚠ WARNING

Remote control: danger of unexpected starting!

- Make sure the power supply disconnecting device is switched off before commencing any work on the machine.

Tab. 42 Machine identification

- Label the starting device in the remote control centre as follows (suggestions):

⚠ WARNING

Remote control: danger of unexpected starting!

- Before starting, make sure that no one is working on the machine and that it can be safely started.

Tab. 43 Remote control identification

Identifying the machine for clock control mode operation

- Attach the following notice to warn of remote machine operation (suggestion):

⚠ WARNING

Clock control: danger of unexpected starting!

- Make sure the power supply disconnecting device is switched off before commencing any work on the machine.

Tab. 44 Machine identification

7 Initial Start-up

7.1 Outline

SIGMA CONTROL 2 was designed and developed for a number of applications. Potential settings are correspondingly varied.

It is possible that only a few of these settings are needed for the initial start-up. This depends on the application.

The following sections explain the large number of practical applications, but only one configuration is relevant for any specific use.

7.2: Configuring the controller (display format, units, languages, etc.)

7.3: Using KAESER CONNECT

7.4: Adjusting the pressure parameters of the machine and possible modules

7.5: Configuring machine start and stop

7.6: Activating and adjusting the control modes

7.8: Configuring the machine for local mode

7.9: Configuring the machine for master control

7.10: Configuring e-mail

7.11: Configuring input and output signals

7.12: Activating remote acknowledgement

7.13: Linking to an external pressure transducer

7.14: Commissioning the machine

7.2 Configuring the controller



All controller settings are explained in detail in the following sections. The most common settings are summarised for experienced users in section "Important settings" in the beginning of this manual.

- Carry out settings as required:
 - 7.2.1: Selecting menu options (introduction)
 - 7.2.2: Changing the display language
 - 7.2.3: Note the number of the KAESER Equipment Card
 - 7.2.4: Control access to SIGMA CONTROL 2 with the Equipment Card
 - 7.2.5: Generate password for SIGMA CONTROL 2
 - 7.2.6: Control access to SIGMA CONTROL 2 via manual input
 - 7.2.7: Generate password for KAESER CONNECT
 - 7.2.8: Set time and date
 - 7.2.9: Set display formats (date, time, units of pressure and temperature)
 - 7.2.10: Activate summer/winter time
 - 7.3.6: Add user accounts

7.2.1 Selecting menu options

All menu options can be selected with the «DOWN», «UP» and «Enter» keys.

Example: Select < Configuration → General> menu option

Precondition The display shows the operating mode.

1. Press «Enter».
The main menu is displayed.
2. Press the «UP» or «DOWN» key until *Configuration* is displayed as active line.
3. In order to open the < *Configuration* > menu, press «Enter» once.
4. Use the «DOWN» or «UP» keys to select a submenu in the < *Configuration* > menu, < *General* > or < *Pressure control* > for instance.
5. Press «UP» repeatedly until *General* is displayed as active line.
6. Press «Enter».
The current menu is the < *General* > submenu in the < *Configuration* > menu.
7. Use the «DOWN» or «UP» keys to select a menu option in the < *General* > submenu, < *System information* > for instance.

7.2.2 Changing the display language

The controller can display text messages in the following languages:

...	Estonian	Italian	Norwegian	Spanish
Bulgarian	Finnish	Japanese	Polish	Spanish (South-America)
Chinese	French	Korean	Portuguese	Czech
Danish	French (Canada)	Croatian	Romanian	Turkish
German	Greek	Latvian	Russian	...
English	Hebrew	Lithuanian	Swedish	...
English (USA)	Indonesian	Dutch	Slovenian	...

Tab. 45 Language diversity

Some of the units, as well as clock and date format, will be adjusted according to the language selected.

Precondition The display shows the operating mode.

1. Press «Enter».
The main menu is displayed.
2. Press the «UP» key once.
The set language is displayed as being active.
3. Use the «Enter» key to switch to setting mode.
The currently set language flashes.
4. Use the «DOWN» or «UP» keys to select the desired language.
5. Press «Enter» to accept the setting.
6. Press «Escape» repeatedly to return to the main menu.
The display texts are now in the selected language.

7.2.3 Note the number of the KAESER Equipment Card



The number of your KAESER Equipment Card is identical with the *user name* displayed on SIGMA CONTROL 2 after you have successfully logged on using your Equipment Card.



Fig. 9 Back of the KAESER Equipment Card

- ① Back of the KAESER Equipment Card
- ② Number of your Equipment Card

1. Hold your KAESER Equipment Card with its back upward.
2. Note your user name (the number of your Equipment Card).
3. Store this information at a suitable location.



If your Equipment gets damaged or can no longer be found?
 ➤ If you know your user name and password, you can manually log on to SIGMA CONTROL 2.

7.2.4 Control access to SIGMA CONTROL 2 with the Equipment Card

Use the Equipment Card to quickly and easily check the advanced access rights to the SIGMA CONTROL 2 .



Advanced access rights let you:

- Read additional data
- Change other settings

1. Hold the Equipment Card in front of the controller's reader.
(see also chapter 4.2)
Your user name and access level will be displayed.
2. Press «Enter» to confirm the access right.



The Equipment Card is damaged or lost.
 ➤ Manually enter the user name and password, see chapter 7.2.6.

7.2.5 Generate password for SIGMA CONTROL 2

In the event that your Equipment Card is damaged or lost, you must manually log on to SIGMA CONTROL 2.

Prerequisite for this is that you know your

- User name and
- Password

You have noted your user name and stored it at a suitable location. You now generate a password at the SIGMA CONTROL 2. Note this generated password as well, and store it a suitable location. If your Equipment Card is damaged or lost, you can use these two data to manually log on to the SIGMA CONTROL 2 without an Equipment Card.

Precondition The customer is logged on with the Equipment Card
The display shows the operating mode.

1. Press «Enter».
The main menu is displayed.
2. Use the «DOWN» key to select the <User> menu.
The *Name* line is displayed as being active.

6.1 bar 08:15 80.0 °C	
7 User	Menu
Name : E00019895	Active line, display of your Equipment Card's number
Password: *****	
[Logout]	

Current access level: 2	Display access level 2

3. Press «DOWN» twice.
[Logout] is displayed as the active line.

6.1 bar 08:15 80.0 °C	
7 User	Menu
Name : E00019895	
Password: *****	
[Logout]	Active line

Current access level: 2	Display access level 2

4. Press «Enter».
[Login] is displayed as the active line.

6.1 bar 08:15 80.0 °C	
7 User	Menu
Name : E00019895	
Password: *****	
[Login]	Active line

Current access level: 0	Display access level 0

5. Hold the Equipment Card in front of the controller's reader.



Menu

Prompt, whether the password is to be changed

6. Press the «Right» key.

The generated *password* is displayed in a new screen.

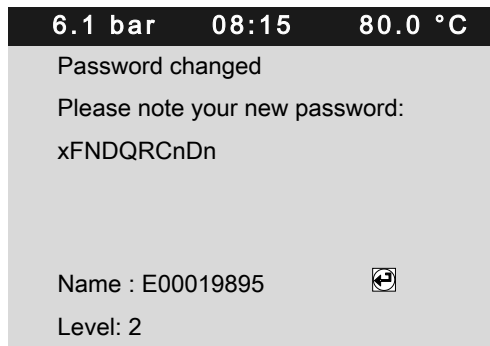

Menu

Note the new password

7. Note the generated password.
8. Store the password at a suitable location, if it should become necessary to manually log-on without Equipment Card.
9. Press «Enter» to accept the setting.

7.2.6 Control access to SIGMA CONTROL 2 via manual input

In the event that your Equipment Card is damaged or lost, you must manually log on to SIGMA CONTROL 2.

Precondition The Equipment Card is damaged or lost.

User name (number of Equipment Card) must be known

A password was generated at the SIGMA CONTROL 2 before the Equipment Card was damaged or lost.

The display shows the operating mode.

1. Press «Enter».
The main menu is displayed.
2. Use the «DOWN» key to select the *<User>* menu.
The *Name* line is displayed as being active.

3. Press «Enter» to switch into setting mode.

A column with alphanumeric characters is displayed.

6.1 bar	08:15	80.0 °C	
7 User			Menu
Name : E00019895			
Password: *****			Active line
[Login]			

Current access level: 0			Display access level 0

4. Repeatedly press «DOWN» or «UP» until the requested character is displayed.

5. Press the «Right» key.

The cursor jumps to the next position.

6. Complete the remaining characters of the name.

7. Press «Enter» to accept the settings.

The user name has been entered.

6.1 bar	08:15	80.0 °C	
7 User			Menu
Name : E00019895			Active line, user name
Password: *****			
[Login]			

Current access level: 0			Display access level 0

8. Press «DOWN» once.

The *Password* line is displayed as being active.

9. Press «Enter» to switch into setting mode.

A column with alphanumeric characters is displayed.

6.1 bar	08:15	80.0 °C	
7 User			Menu
Name : E00019895			
Password: *****			Active line, password
[Login]			

Current access level: 0			Display access level 0

10. Repeatedly press «DOWN» or «UP» until the requested character is displayed.

11. Press the «Right» key.

The cursor jumps to the next position.

12. Complete the remaining characters of the password.

13. Press «Enter» to accept the settings.

14. Press «DOWN» once.

The *[Login]* line is displayed as active line.

6.1 bar	08:15	80.0 °C	
7 User			Menu
Name : E00019895			
Password: *****			
[Login]			Active line

Current access level: 2			Display access level 0

15. Press «Enter» to accept the settings.

Access level 2 is displayed.

Result You are now logged on to SIGMA CONTROL 2 with access level 2, having manually input your user name and the generated password.

7.2.7 Generate password for KAESER CONNECT

You also need a password to access KAESER CONNECT for the SIGMA CONTROL 2. This password is also generated at the SIGMA CONTROL 2.

Entering the password is necessary to

- Log on to KAESER CONNECT
- Activate the write mode in the User accounts menu
- Proceed as described for "Generate password for SIGMA CONTROL 2", see chapter 7.2.5.

7.2.8 Check/set time and date

Precondition Access level 2 is activated.
The display shows the operating mode.

Check and set time



- When operating the machine with a timer program, check the time settings at least once a year.

1. Press «Enter».
The main menu is displayed.
2. Select the *< Configuration → General >* menu.

3. Press the «DOWN» key repeatedly until the current time is displayed as active line.



4. Press the «Right» key.
5. Press «Enter» to switch into setting mode.
The hours display flashes. 00: 00: 00.
6. Use «UP» or «DOWN» to change the hour setting.
7. Press the «Right» key.
The minutes display flashes. 00: 00: 00.
8. Use «UP» or «DOWN» to change the minute setting.
9. Press the «Right» key.
The seconds display flashes. 00: 00: 00.
10. Use «UP» or «DOWN» to change the second setting.
11. Press «Enter» to save the settings.
12. Press «Escape» repeatedly to return to the main menu.

Check/set the date

Precondition Password level 2 is activated,
the < Configuration → General > menu is selected (see 7.2.1).

1. Press the «DOWN» key repeatedly until the current date is displayed as active line.

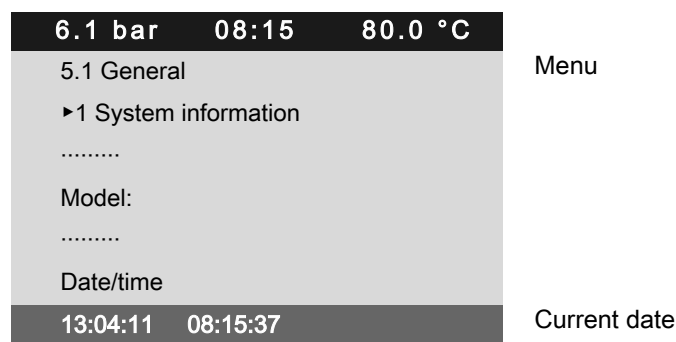

2. Press «Enter» to switch into setting mode.
The day display flashes. 00: 00: 00.
3. Use «UP» or «DOWN» to change the day setting.
4. Press the «Right» key.
The month display flashes. 00: 00: 00.
5. Use «UP» or «DOWN» to change the month setting.
6. Press the «Right» key.
The year display flashes. 00: 00: 00.

7. Use «UP» or «DOWN» to change the year setting.
8. Press «Enter» to save the settings.
9. Press «Escape» repeatedly to return to the main menu.

7.2.9 Set display formats

When setting the language, several display formats will automatically adjust to local usage.

Set the date format

Select your preferred format.

Format	Example:
DD.MM.YY	30.07.10
YY-MM-DD	10-07-30
MM/DD/YY	07/30/10

Tab. 46 Date format

Precondition Password level 2 is activated, menu < Configuration > General > is selected (see 7.2.1).

1. Press the «DOWN» key repeatedly until *Date format* is displayed as active line.

6.1 bar 08:15 80.0 °C	
5.1 General	Menu
Date/time	
13:04:11 08:15:37	
Europe/Berlin	
.....	
Date format DD.MM.YY	Current date format
Time format hh:mm:ss	

2. Press «Enter» to switch into setting mode.
DD.MM.YY flashes.
3. Change the format with the «DOWN» or «UP» keys.
4. Press «Enter» to save the setting.
5. Press «Escape» repeatedly to return to the main menu.

Setting the time format

Select your preferred format for the time display:

Format	Example:
hh:mm:ss	13:33:45
hh:mm	13:33
hh:mm:ssAM/PM	01:33:45PM
hh:mmAM/PM	01:33PM

Tab. 47 Time formats

Precondition Password level 2 is activated,
menu < Configuration> General > is selected (see 7.2.1).

1. Press the «DOWN» key repeatedly until *Time format* is displayed as active line.

6.1 bar 08:15 80.0 °C	
5.1 General	Menu
Date/time	
13:04:11 08:15:37	
Europe/Berlin	
.....	
Date format DD.MM.YY	
Time format hh:mm:ss	Current time format

2. Press «Enter» to switch into setting mode.
hh:mm:ss flashes.
3. Change the format with the «DOWN» or «UP» keys.
4. Press «Enter» to save the setting.
5. Press «Escape» repeatedly to return to the main menu.

Setting the pressure display units

Select your preferred display of the pressure unit:

Format	Example:
bar	5.5 bar
hPa	5523 hPa
MPa	0.55 MPa
psi	80 psi
at	5.6 at
"Hg	162.9 "Hg

Tab. 48 Units of pressure

Precondition Password level 2 is activated,
menu < Configuration> General > is selected (see 7.2.1).

1. Press the «DOWN» key repeatedly until *Pressure unit* is displayed as active line.

6.1 bar 08:15 80.0 °C	
5.1 General	Menu
Time format hh:mm:ss	
.....	
Pressure unit bar	Current unit of pressure
Temperature unit °C	
.....	
Display lighting	

2. Press «Enter» to switch into setting mode.
The *bar* parameter flashes.

3. Change the unit with the «DOWN» or «UP» keys.
4. Press «Enter» to save the setting.
5. Press «Escape» repeatedly to return to the main menu.

Setting the temperature display units

Select your preferred display of the temperature unit:

Format	Example:
°C	46 °C
K	319 K
°F	114 °F

Tab. 49 Units of temperature

Precondition Password level 2 is activated, menu < Configuration> General > is selected (see 7.2.1).

1. Press the «DOWN» key repeatedly until *Temperature unit* is displayed as active line.

6.1 bar 08:15 80.0 °C	
5.1 General	Menu
Time format hh:mm:ss	
.....	
Pressure unit bar	
Temperature unit °C	Current unit of temperature
.....	
Display lighting	

2. Press «Enter» to switch into setting mode.
The °C parameter flashes.
3. Change the unit with the «DOWN» or «UP» keys.
4. Press «Enter» to save the setting.
5. Press «Escape» repeatedly to return to the main menu.

Setting the display illumination

Select your personal mode for the display illumination:

Mode	1	2	3
Display	<i>automatic</i>	<i>ON</i>	<i>OFF</i>
Function	The illumination extinguishes after the <i>time-out</i> has elapsed.	Permanent setting Illumination "on"	Permanent setting Illumination "off"

Tab. 50 Display illumination

Precondition Password level 2 is activated, menu < Configuration> General > is selected (see 7.2.1).

1. Press «DOWN» repeatedly until *Display lighting* is displayed.

2. Press «DOWN» once until *Mode* is displayed as active line.

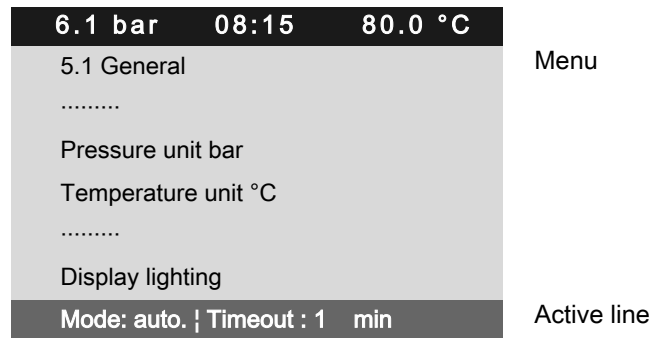

3. Press «Enter» to switch into setting mode.
The *on* display flashes.
4. Use «UP» to select the *auto.* mode.
5. Press «Enter» to save the setting.
6. Enter the setting for *Time-out* in the same manner.
7. Press «Enter» to save the setting.
8. Press «Escape» repeatedly to return to the main menu.

Result The display illumination is set for automatic operation with deactivation after one minute without user intervention.

7.2.10 Setting and activating summer/winter time

The system automatically switches between summer and winter time.

7.3 Using KAESER CONNECT

Using a PC with web browser, KAESER CONNECT enables you to view the following displays of SIGMA CONTROL 2:

- System status
- Graphs
- Messages
- IO display
- User administration
- Settings
- Data backup

Thus, KAESER CONNECT provides an excellent option for an easy and quick check of the economy and energy efficiency of your compressors.



The following functions are not available with KAESER CONNECT:

- Remotely starting the machine
- Remotely changing parameters

7.3.1 Calling up KAESER CONNECT for SIGMA CONTROL 2

Precondition The password for KAESER CONNECT has already been generated, see chapter 7.2.7
The IP address of your controller is known.

1. Use an Ethernet cable to connect the PC and the SIGMA CONTROL 2.
2. In the web browser, enter the controller's IP address.
The *Login* window opens.

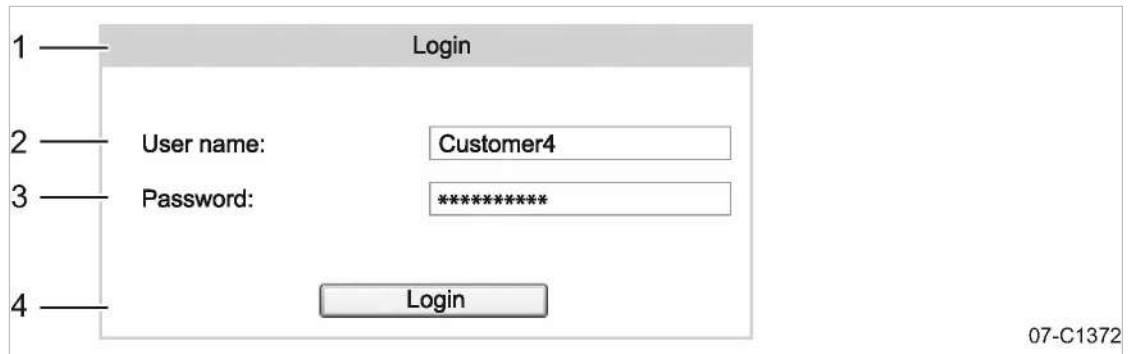

Fig. 10 Login window

- | | | | |
|---|--------------|---|--------------------|
| ① | Login window | ③ | Generated password |
| ② | User name | ④ | «Login» key |

3. Enter the user name.
4. Enter the generated password.
5. Click «Login».
KAESER CONNECT for SIGMA CONTROL 2 is displayed.

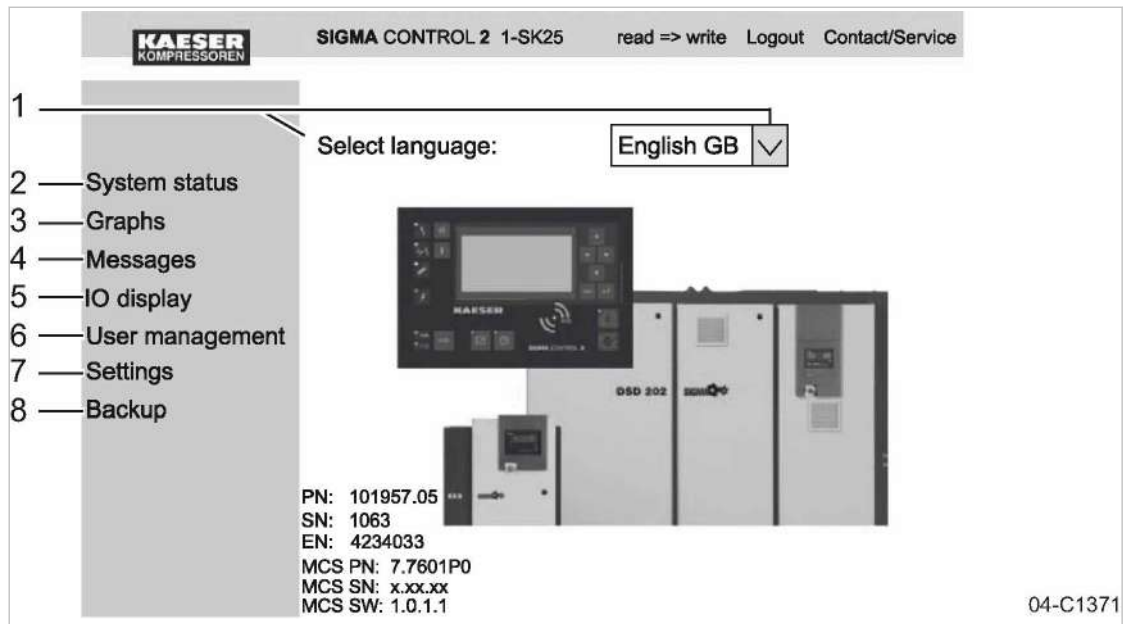

Fig. 11 KAESER CONNECT

- | | |
|----------------------|-----------------------|
| ① Language selection | ⑤ User administration |
| ② System status | ⑥ Settings |
| ③ Graphs | ⑦ Data backup |
| ④ Messages | |

6. Click the «arrow key» ① to open the language selection.
The Language selection ② window opens.

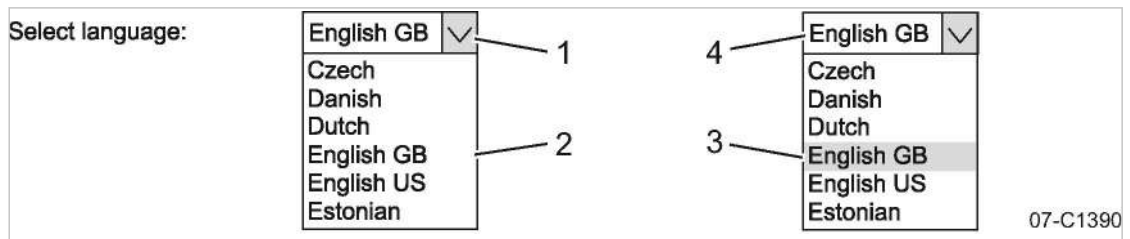

Fig. 12 Language selection

- | | |
|----------------------------------|---------------------|
| ① «Arrow key» Language selection | ③ Select a language |
| ② Language selection window | ④ Selected language |

7. Select the required language ③.
KAESER CONNECT is displayed in the selected language.

7.3.2 Displaying the system status

Precondition KAESER CONNECT for SIGMA CONTROL 2 is displayed.

1. Select the <System status> menu.
The system displays the status information.

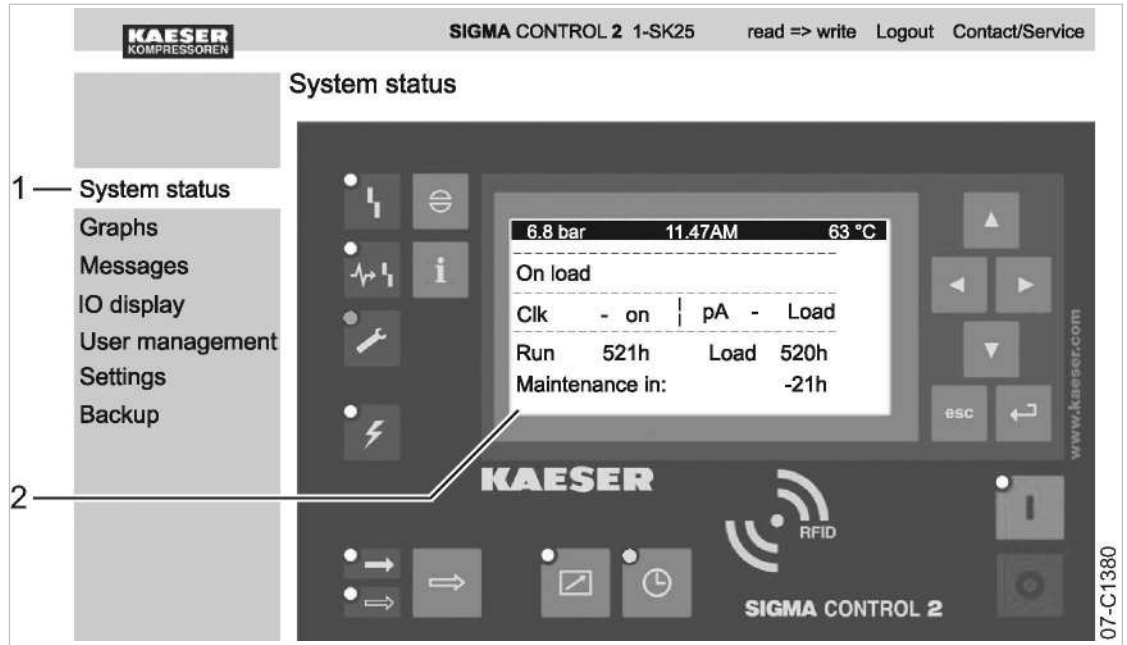

Fig. 13 Status display

- ① <System status> menu
- ② Display SIGMA CONTROL 2 with status information

2. Check the status information.

The entire local menu can be displayed at your PC.

- 1. Simply click in the display of the operating mode.
The <main menu> is displayed.

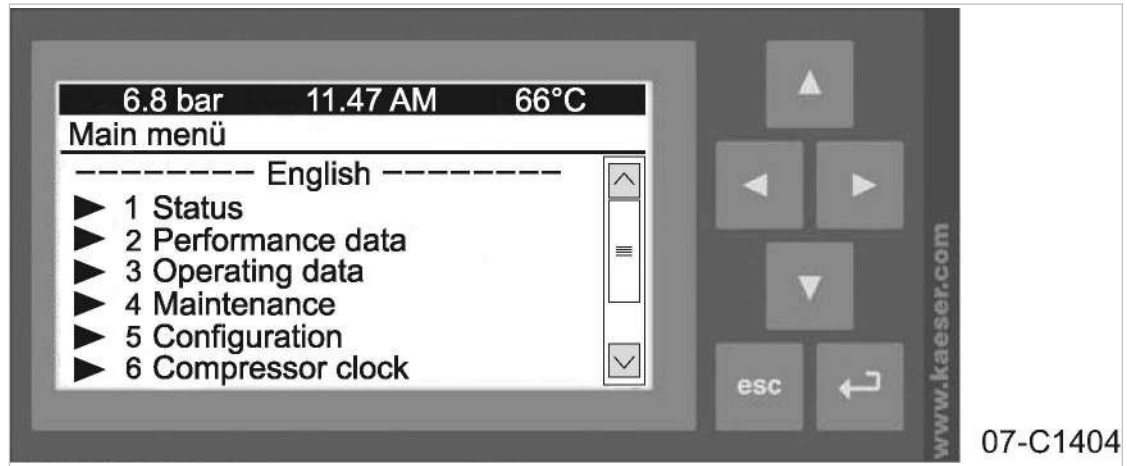

Fig. 14 Main menu

- 2. You now may click the <Status> menu.
The system displays the corresponding <submenus>.

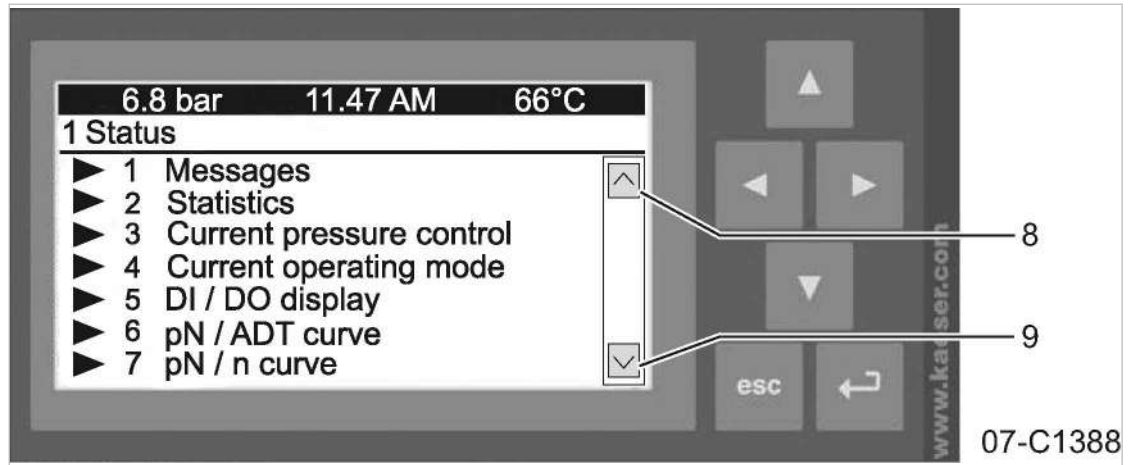

Fig. 15 Status menu with submenus

- | | | | |
|---|-----------------------------|---|-------------------|
| ① | Messages | ⑥ | pN / ADT curve |
| ② | Statistics | ⑦ | pN / n curve |
| ③ | Current pressure regulation | ⑧ | «Scroll down» key |
| ④ | Current operating mode | ⑨ | «Scroll up» key |
| ⑤ | DI/DO display | | |

3. Navigate through the submenus by additional clicks in the display.
4. Click «Scroll up» [9] to start the upward scroll.
Data not visible prior to the scroll action are now displayed.
5. Click «Scroll down» [8] to start the downward scroll.
6. To move back between the menus, click «esc» as often as required.

7.3.3 Display graphs

When starting this menu, the recorded data from the last 60 minutes are loaded. The last 20 minutes are displayed in a graph. The system updates the graph every ten seconds whilst the current time is displayed.

Moving the mouse pointer across the graph calls up a ruler. The time selected with the ruler and the associated values are displayed in the legend above the graph. When the ruler is hidden, the time and associated values are displayed at the right edge of the graph.

The following graphs can be displayed:

- System pressure
- Airend discharge temperature
- Machine status
 - OFF
 - IDLE
 - LOAD
- Speed



The display of the *Speed* is implemented only for machines with frequency converter.

Precondition KAESER CONNECT for SIGMA CONTROL 2 is displayed.

1. Select the <Graphs> menu.
The system displays graphs.

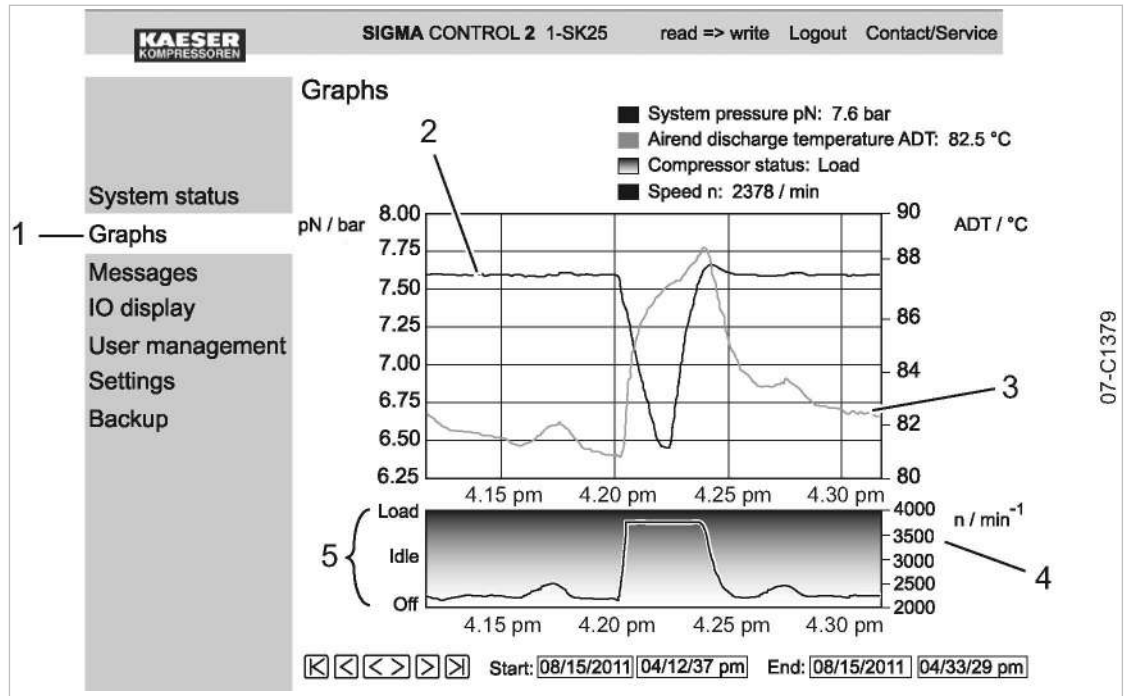

Fig. 16 Pressure/temperature graphs

- | | |
|-------------------------------|------------------|
| ① <Graphs> menu | ④ Speed |
| ② System pressure | ⑤ Machine status |
| ③ Aired discharge temperature | |

2. Check pressure development
3. Check aired discharge temperature.

7.3.3.1 Zoom and arrow key functions

Use the Zoom-in function to enlarge significant curve developments:
Highlight a specific area within the graph by drawing a rectangle with the mouse pointer pressed.
The selected area will be enlarged as soon as the mouse pointer is released.

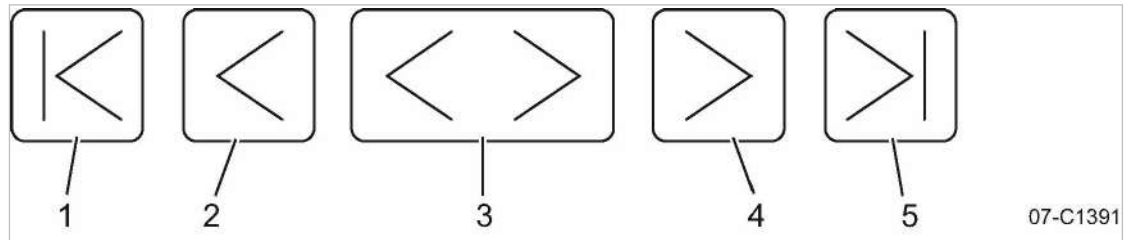

Fig. 17 Arrow keys

Position	Name	Function
1	«Start»	Display of oldest data
2	«Scroll left»	Shift the display area by 1/3 to the left
3	«Zoom-out»	Time range is enlarged

Position	Name	Function
4	«Scroll right»	Shift the display area by 1/3 to the right
5	«End»	Display of newest data

Tab. 51 Arrow keys and functions

1. Click the «Start» (1) arrow key.
The oldest data are displayed.
2. Click the «Scroll right» (4) arrow key.
The display area is shifted to the right by 1/3.
3. Draw a rectangle with the mouse pointer pressed.
4. Release the mouse pointer.
The selected area is enlarged (zoom-in function).
5. Click the «Zoom-out» (3) arrow key.
Time range is enlarged (zoom-out function).

7.3.4 Displaying messages

The following messages are shown:

- Current messages
- Compressor messages
- System messages
- Diagnostic messages

Precondition KAESER CONNECT for SIGMA CONTROL 2 is displayed.

1. Open menu <messages>.
Menu <messages> is displayed.

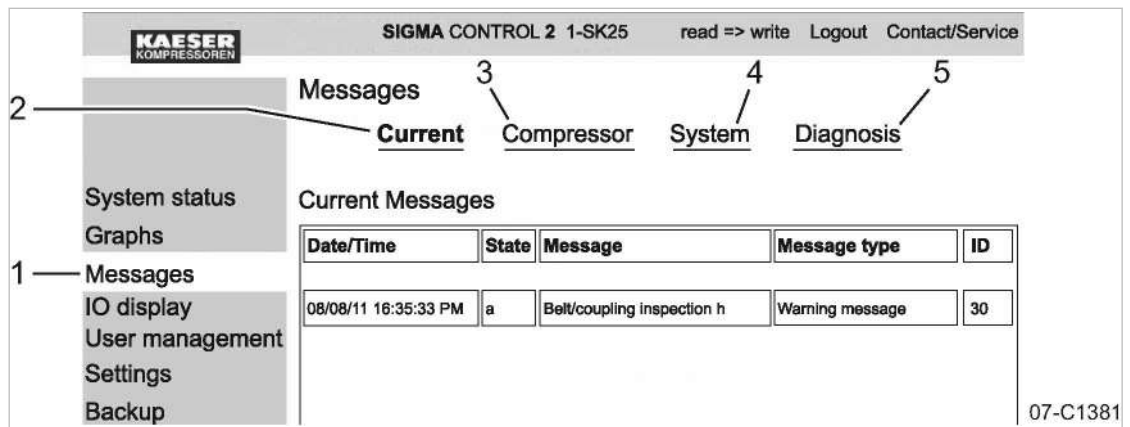

Fig. 18 Messages

- | | |
|-------------------------|-------------------------|
| (1) Menu < Messages > | (4) System messages |
| (2) Current messages | (5) Diagnostic messages |
| (3) Compressor messages | |

2. Check messages.

7.3.5 Calling up the IO display

The assignment of the I/O modules is displayed in the *<IO display>* menu.

- Select the *<IO display>* menu.

The assignment of the input/output modules is displayed.

7.3.6 Creating additional user accounts

Use the *<User administration>* menu to create additional user accounts for other employees.



In order to be able to create user accounts, you must activate the write mode [2]. The system will prompt you to enter and confirm your user name and your password (see chapter 7.2.7). Subsequently, the write mode is activated.

The write mode is granted only to one person at a time.

If a second user attempts to log on in write mode, he will be refused by the system.

The system will return an error message.

String length for personally created user names and passwords:

- User name: 6 to 16 characters, the second character must not be a number.
- Password: 6 to 16 characters

Precondition The generated password is available.

KAESER CONNECT for SIGMA CONTROL 2 is displayed.

1. Select the *<User administration>* menu.

The system displays the *<User administration>* menu.

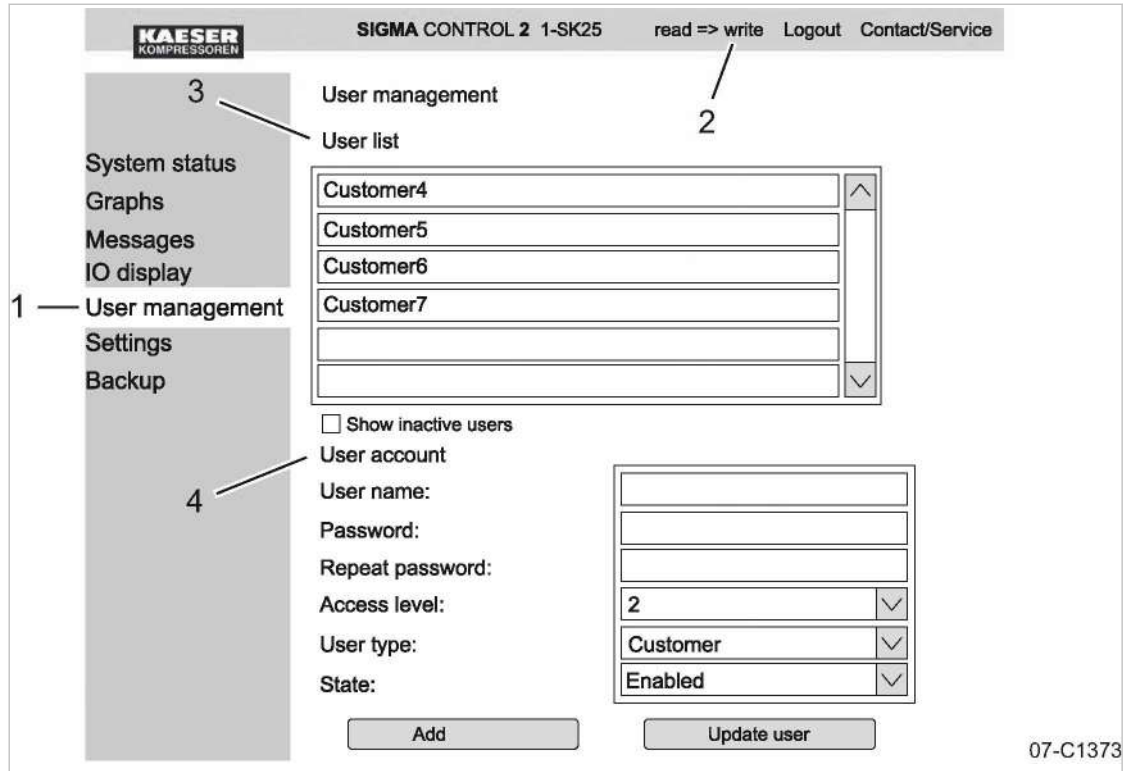

Fig. 19 User administration menu

- ① <User administration> menu
- ② Activate write mode
- ③ User list
- ④ User account

2. Activate the write mode ②.
The *Log on to write* window opens.

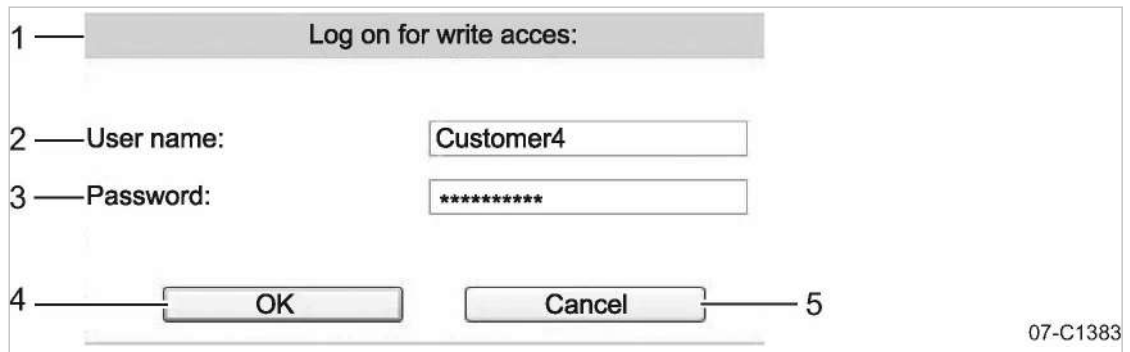

Fig. 20 "Log on to write" window

- ① *Log on to write* window
- ② User name
- ③ Password
- ④ «OK» key
- ⑤ «esc» key

3. Enter your own user name.
4. Enter your own password.
5. Click «OK».

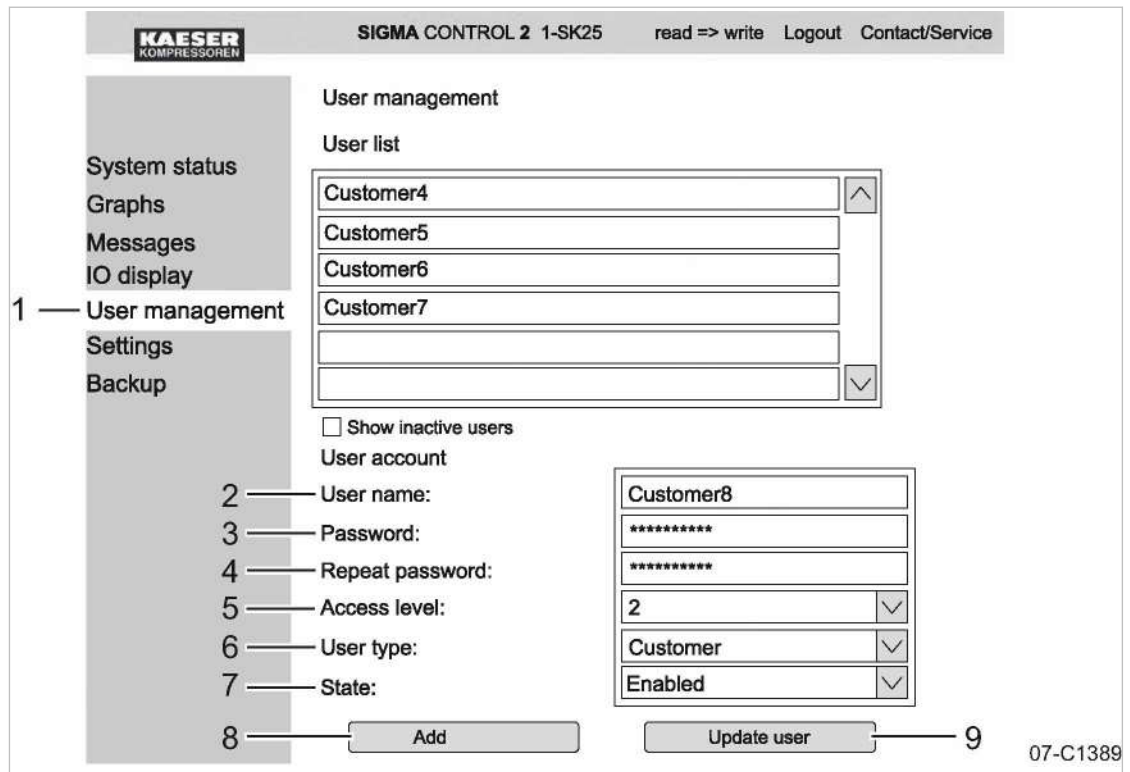

Fig. 21 Creating a new user

- | | | | |
|---|----------------------------|---|--------------|
| ① | <User administration> menu | ⑥ | User type |
| ② | New user name | ⑦ | Status |
| ③ | Password | ⑧ | «Add» key |
| ④ | Confirm the password | ⑨ | «Update» key |
| ⑤ | Access level | | |

6. Enter the new user name ② for an additional employee.
7. Enter the new password ③.
8. Confirm the new password ④.
9. Select access level 2 ⑤.
10. Select the user type Customer ⑥.
11. Select the status Activated ⑦.
12. Click «Add» ⑧.

The new user name has been added to the user list.

Result A new user account has been created and activated.

Updating user accounts

Similar to the creation of new user accounts, you can also update existing user accounts.

- Changing the password
- Changing the access level
- Changing the status

As an example, we show here how to change a password.

Precondition The system displays the *<User administration>* menu.
Write mode is activated.

1. Click on the existing user account.
2. Enter the new password.
3. Confirm the new password.
4. Click «Update» [9].

Result The existing user account has been updated.

7.3.7 Settings

Settings via KAESER CONNECT apply only to your PC and your Browser.

The following settings are possible.

- Units
- Date format
- Time format

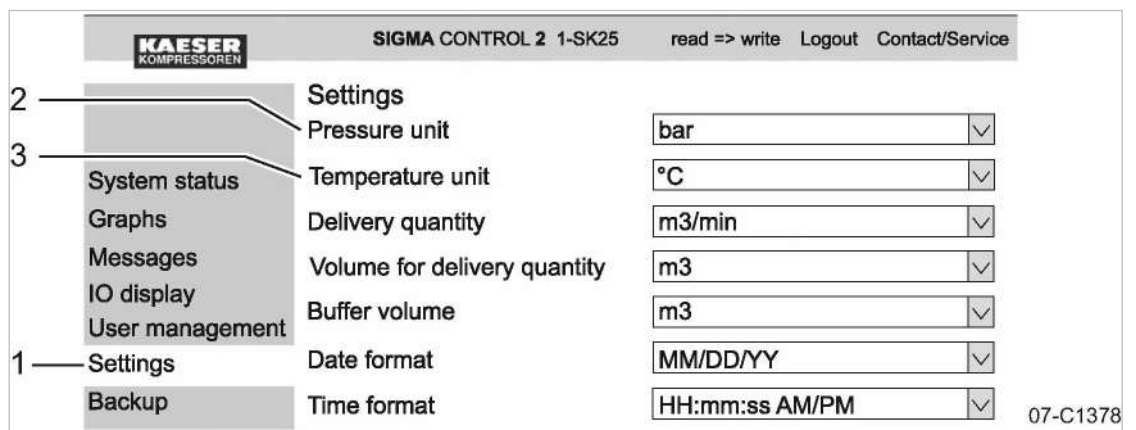

Fig. 22 Settings

- ① *<Settings>* menu
- ② Unit of pressure
- ③ Unit of temperature

You want to convert your units to US values:

Precondition KAESER CONNECT for SIGMA CONTROL 2 is displayed.

1. Select the *<Settings>* menu.
The system displays the *<Settings>* menu.
2. Click the arrow key for the unit of pressure.
A selection list of units of pressure is displayed.
3. Select the desired unit.
4. Click the arrow key for the unit of temperature.
A selection list of units of temperature is displayed.
5. Select the desired unit.
6. Set additional units and date and time formats.

7.3.8 Performing a data backup

In order to use KAESER CONNECT to easily back up data from SIGMA CONTROL 2 to your own PC, use the *<Data backup>* menu.

You can choose to either perform a full backup or partial backups.

- Full
- Log files
- Settings
- User data

Precondition KAESER CONNECT for SIGMA CONTROL 2 is displayed.

1. Open the *<Data backup>* menu.
The system displays the *<Data backup>* menu.

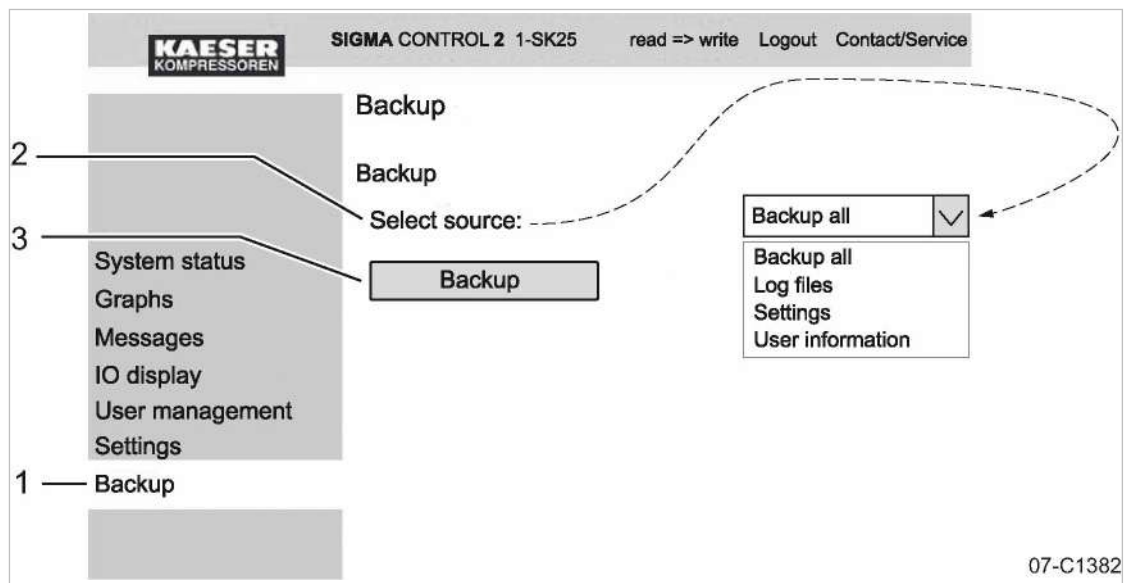

Fig. 23 Data backup

- ① *<Data backup>* menu
- ② Selection
- ③ «Data backup» key

2. Select ②.
3. Click the «Data backup» ③ key.

Result Data are saved to your PC.

7.3.9 Closing KAESER CONNECT:

In order to close KAESER CONNECT for SIGMA CONTROL 2, click **Logout** ③ in the header.

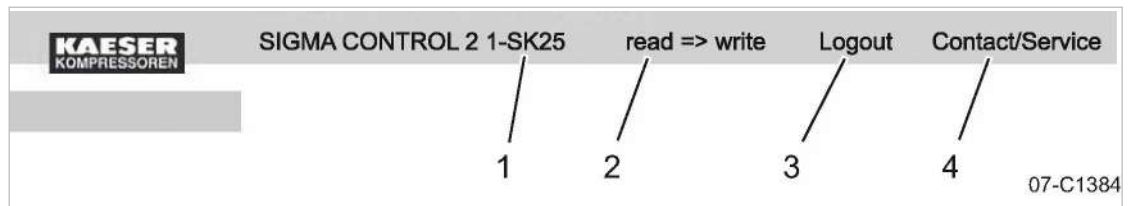

Fig. 24 Header

- ① Machine designation
- ② Activation Write mode
- ③ Logout
- ④ Contact HPC Service

➤ Click Logout.
The logout message is displayed.

Result You have closed KAESER CONNECT for SIGMA CONTROL 2.

7.4 Adjusting the pressure parameters of the machine

This subchapter contains instructions for how to display and adjust the pressure parameters of the machine.

The subchapter is divided into the following sections:

- 7.4.1: Displaying pressure parameters
- 7.4.2: Configuring the pressure parameters

"Display:" means that the parameter will only be shown.

"Setting:" means that the parameter can also be changed.

Parameter	Explanation
pRV	Display: Activating pressure of the pressure relief valve on the oil separator tank
pE	Pressure increase Setting: <ul style="list-style-type: none"> ■ pE SP: Switching point for pressure increase; upper safety limit for machine maximum pressure; in an external LOAD control, this value is used to switch the machine from LOAD to IDLE in the event of a fault. ■ pE SD: Switching differential of pressure increase
ΔpFC	Limiting value for machines with frequency-controlled drive (SFC). Setting: <ul style="list-style-type: none"> ■ dp FC: Limit of the lowest delivery quantity. When the value [switching point system set-point presre +dp FC] is exceeded, the compressor switches from LOAD to IDLE.
Nominal pressure	Display: The compressor is designed for this pressure (maximum system pressure set-point)

Parameter	Explanation
Setpoint pressure	Set-point pressure can be regulated to two values: pA and pB Setting: <ul style="list-style-type: none"> ■ Switching point pA or control pressure pA in machines with frequency converter (SFC) ■ Switching point pB or control pressure pB in machines with frequency converter (SFC)
System pressure low	A warning message is displayed when the limit value for the system pressure is reached. Setting: <ul style="list-style-type: none"> ■ SD: Switching differential for system pressure low, SP: Switching point for system pressure low ■ Option: Configure the output signal, Warning message displayed or an additional output signal is sent, e.g., to a control centre
Cut-in pressure min	Display: For design reasons, pressure can only be built up above this value.

Tab. 52 Compressor pressure parameters

➤ Parameters correspond to the following specifications

7.4.1 Displaying pressure parameters

Precondition Access level 2 is activated.
The < Configuration → Pressure control > menu is selected.

Open the menu for pressure parameters.

1. Press «DOWN» or «UP» repeatedly until *Pressure settings* is displayed as active line.
2. Press «Enter».

The system displays the pressure parameters.

6.1 bar 08:15 80.0 °C	
5.2.2 Pressure settings	Menu
pA SP : 8.0 bar SD : - 0.5 bar	Active line
pB SP : 7.5 bar SD : - 0.4 bar	
.....	
System pressure low <input type="checkbox"/>	
↓ < 5.0 bar SD : 0.5 bar	
ta : 600 s DOR 1.04 <input type="checkbox"/>	

Displaying compressor parameters

1. Press «DOWN» repeatedly until *Setpoint pressure* is displayed.

6.1 bar 08:15 80.0 °C	
5.2.2 Pressure settings	Menu
Setpoint pressure	Active line
pA SP : 8.0 bar SD : - 0.5 bar	Current system set-point pressure pA and switching differential
pB SP : 7.5 bar SD : - 0.4 bar	Current system set-point pressure pB and switching differential
System pressure low <input type="checkbox"/>	

2. Display further parameters with «UP» and «DOWN».

7.4.2 Configuring the pressure parameters for compressors

7.4.2.1 Adjust the system set-point pressure: pA and pB

The pressure parameters can only be set within certain limits:

$$\text{Rated machine pressure} \geq \text{SP pA / pB} \geq \text{minimum cut-in pressure}^* + \text{switching differential}$$

Tab. 53 Setting limits for system set-point pressure (* Cut-in pressure min)

The machine switches to LOAD under the following condition:

$$\text{System pressure} \leq \text{SP: pA / pB} - \text{switching differential}$$

Tab. 54 Pressure condition for LOAD

The machine switches to IDLE under the following condition:

$$\text{System pressure} = \text{System set-point pressure}$$

Tab. 55 Pressure condition for IDLE

Precondition Access level 2 is activated.

1. Select < Configuration → Pressure control → Pressure settings > (see Section 7.4.1)
2. Press «UP» or «DOWN» repeatedly until the following is displayed as active line:

6.1 bar 08:15 80.0 °C	
5.2.2 Pressure settings	Menu
Setpoint pressure	
pA SP : 8.0 bar SD : - 0.5 bar	Active line with current value for system set-point pressure pA
pB SP : 7.5 bar SD : - 0.4 bar	
System pressure low <input type="checkbox"/>	

7 Initial Start-up

7.4 Adjusting the pressure parameters of the machine

3. Press «Enter» to switch into setting mode.
The 8.0 bar parameter flashes.
4. Use «UP» or «DOWN» to adjust the system set-point pressure pA.
5. Press «Enter» to accept the setting.
6. Adjust the switching differential in the same way.
7. Adjust the pB and the switching differential in the same manner, if necessary.
8. Press «Escape» repeatedly to return to the main menu.

Result The settings for the system set-point pressure pA and pB are adjusted.

7.4.2.2 Adjust value: System pressure low

If the system pressure falls to the *sys.press.low* value, SIGMA CONTROL 2 will display a warning message for the system pressure being too low. The switching differential influences the pressure at which the message can be acknowledged or the optionally activated output will again switch:

Message	Output
5.0 bar message appears	Active
5.5 bar messages disappears	Inactive

Tab. 56 Example: Activated output

Precondition Access level 2 is activated.

1. Select < Configuration → Pressure control → Pressure settings > (see Section 7.4.1)
2. Press the «DOWN» key repeatedly until the following is displayed as active line:

6.1 bar 08:15 80.0 °C	
5.2.2 Pressure settings	Menu
.....	
System pressure low <input type="checkbox"/>	
↓ < 5.0 bar SD : 0.5 bar	Current value system pressure low, current switching differential
ta : 600 s DOR 1.04 <input type="checkbox"/>	
.....	
Cut-in pressure min 5.0 bar	

3. Press «Enter» to switch into setting mode.
The 5.0 bar parameter flashes.
4. Use «UP» or «DOWN» to adjust the setting.
5. Press «Enter» to accept the setting.
6. Adjust the switching differential if necessary in the same way.
7. Press «Escape» repeatedly to return to the main menu.

7.4.2.3 Adjusting pressure rise pE

The value for pressure rise pE serves as a safety limit value when the machine is externally controlled. When the system set pressure reaches the value pE (for example, when the external control functions incorrectly) the machine switches to IDLE.

The warning message *ext.load signal?* is displayed.

Precondition Access level 2 is activated.

1. Select < Configuration → Pressure control → Pressure settings > (see Section 7.4.1)
2. Press the «DOWN» key repeatedly until the following is displayed as active line:

6.1 bar 08:15 80.0 °C	
5.2.2 Pressure settings	Menu
pRV 16.0 bar	
.....	
Pressure rise	
pE SP : 8.4 bar SD : - 0.5 bar	Active line with current switching point pressure rise, current switching differential
ΔpFC : 0.2 bar	
.....	

3. Press «Enter» to switch into setting mode.
The 8.4 bar parameter flashes.
4. Use «UP» or «DOWN» to adjust the setting.
5. Press «Enter» to accept the setting.
6. Adjust the switching differential if necessary in the same way.
7. Press «Escape» repeatedly to return to the main menu.

7.4.2.4 Adjust pressure rise: Machine with variable frequency drive (SFC)

The pressure rise value *dpFC* is the limit from which the machine switches to IDLE.

This value can be between 0.2 bar and 0.4 bar. The factory setting is 0.2 bar.

The pressure rise is added to the system set-point pressure. In this way, the system set-point pressure can be changed without having to adjust the parameter again.

Precondition Access level 2 is activated.

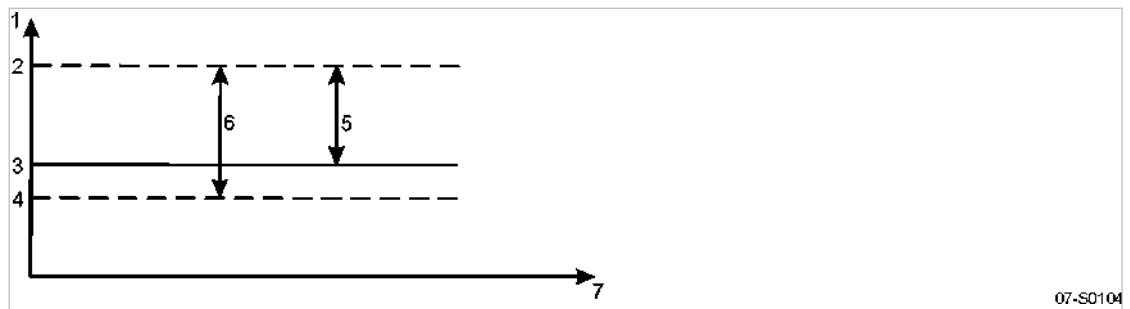

Fig. 25 Pressure rise in frequency-controlled machines

- | | |
|-----------------------------------------------------------------------------------------------------------------------------------------------------------------------------------------|-------------------------------------------------------------------------------------------------------------------------------------------------------------------------------------------------------------------|
| <ul style="list-style-type: none"> ① System pressure ② IDLE switching point:
System set-point pressure + dpFC ③ System set-point pressure pA or pB | <ul style="list-style-type: none"> ④ LOAD switching point:
(System set-point pressure + dpFC) -
switching differential ⑤ Pressure rise dpFC ⑥ System pressure band width |
|-----------------------------------------------------------------------------------------------------------------------------------------------------------------------------------------|-------------------------------------------------------------------------------------------------------------------------------------------------------------------------------------------------------------------|

1. Select < Configuration → Pressure control → Pressure settings > (see Section 7.4.1)

7 Initial Start-up

7.4 Adjusting the pressure parameters of the machine

2. Press «DOWN» repeatedly until the following is displayed:

6.1 bar	08:15	80.0 °C	
5.2.2 Pressure settings			Menu
Pressure rise			
pE SP : 8.4 bar SD : - 0.5 bar			Pressure increase
ΔpFC : 0.2 bar			Active line with pressure rise dpFC
.....			
Nominal pressure 8.0 bar			
.....			

3. Press «Enter» to switch into setting mode.
4. Use «UP» or «DOWN» to adjust the setting.
5. Press «Enter» to accept the setting.
6. Press «Escape» repeatedly to return to the main menu.

7.4.3 Activating/deactivating the «LOAD/IDLE» key

In order to prevent unauthorised users from switching the machine to IDLE, you can deactivate the «LOAD/IDLE» key on the operating panel.

Precondition Password level 2 is activated,
The < Configuration → Pressure control → Load control > menu is selected (see Section 7.2.1).

1. Press «UP» or «DOWN» repeatedly until < Key idle > is displayed as active line.
2. Press «Enter» to switch into setting mode.
The check box < Key idle > will flash.

6.1 bar	08:15	80.0 °C	
5.2.3 Load control			Menu
pA/pB DO DOR1.04 <input type="checkbox"/>			
.....			
Load RC DI1.13 ok <input checked="" type="checkbox"/>			
loc.-load RC DI1.09 <input checked="" type="checkbox"/>			
.....			
Key idle : <input type="checkbox"/>			Active line with check box

3. Press «UP».
The deactivated check box is displayed.

4. Press «Enter» to save the setting.
The «IDLE» key is de-activated.



5. Press «Escape» repeatedly to return to the main menu.

Result Thus, it is ensured that unauthorised users can press the «IDLE» key without the machine switching to IDLE.

7.5 Configuring machine start and stop

- In addition to manually starting the machine locally, you have the following alternatives:

Function	State on delivery, setting	See
Automatic start/stop in programmed clock mode	No clock (time) program entered	7.5.1
Holidays	Not set	7.5.2
Remote start, e.g. from a control centre.	Deactivated	7.5.3
IDLE (venting)	Activated	7.5.4
Automatic restart after power failure (after delay period).	Activated	7.5.5

Tab. 57 Settings for machine start and stop.

7.5.1 Automatic start/stop in programmed clock mode

Overview

- Activate access level 2
- Selecting the compressor clock menu
- Set/adjust the time program.
- Activate the «Timer» key

7.5.1.1 Selecting the compressor clock menu

Precondition Access level 2 is activated.
The display shows the operating mode.

1. Press «Enter».
The main menu is displayed.

2. Select < Compressor clock >.

The display for setting the *Compressor clock* timing program appears.

6.1 bar 08:15 80.0 °C	
6 Compressor clock	Menu
Key clock : <input type="checkbox"/>	Release of Compressor clock key
Reset: <input type="checkbox"/>	All current switching points are reset
.....	
01 n.a. 00:00 off	Active line
02 n.a. 00:00 off	
03 n.a. 00:00 off	

7.5.1.2 Setting the clock program (example)



When setting a timer program for the first time, note the switching times on a sheet of paper first.

In addition to individual week days, the controller has the following cycles:

- Mon-Thu
- Mon-Fri
- Mon-Sat
- Mon-Sun
- Sat-Thu

You can also program an OFF time (plant vacation shutdown) (see Section 7.5.2).

Example:

- Machine ON: Weekdays 6:30 – 17:00, Fridays 6:30 – 15:00.
- Machine OFF: Sat – Sun and during midday break from 12:00 – 13:00.

The following switching points result:

No.	Day	Time	Function
1	Mon-Fri	06:30	ON
2	Mon-Fri	12:00	OFF
3	Mon-Fri	13:00	ON
4	Mon-Thu	17:00	OFF
5	Fri	15:00	OFF

Tab. 58 Example of a machine ON/OFF timer program

Precondition Password level 2 is activated, the «timer» key is activated, the "timer" menu is selected.

1. Press «DOWN» repeatedly until the *01 switching point* is displayed as active line.

6.1 bar	08:15	80.0 °C	
6 Compressor clock			Menu
.....			
01 n.a. 00:00 off			Active line with switching point 01
02 n.a. 00:00 off			Switching point 02:
03 n.a. 00:00 off			Switching point 03:
04 n.a. 00:00 off			Switching point 04:
05 n.a. 00:00 off			Switching point 05:

2. Press «Enter» to switch into setting mode.
The *n.a.* column flashes in the active line.
3. Use «UP» to specify the settings for the weekdays.
4. Press «Enter» to accept the setting.
5. Press the «Right» key once.
6. Press «Enter» to switch into setting mode.
The column time, display for hours, *00: 00* in the active line flashes.
7. Use «UP» to specify the settings for the hours.
8. Press the «Right» key once.
9. The column time, display for minutes, *00: 00* in the active line flashes.
10. Use «UP» to specify the settings for the minutes.
11. Press «Enter» to accept the settings.
The display stops flashing and the time (hours/minutes) is set.

6.1 bar	08:15	80.0 °C	
6 Compressor clock			Menu
.....			
01 Mon-Fri 06:30 on			Switching point 01 is set
02 Mon-Fri 12:00 off			Switching point 02 is set
03 Mon-Fri 13:00 on			Switching point 03 is set
04 Mon-Thu 17:00 off			Switching point 04 is set
05 Fri 15:00 off			Switching point 05 is set

12. Press the «Right» key once.
The *Action on/off* column flashes.
13. Press «Enter» to switch into setting mode.
14. Use «UP» to specify the settings for the action Compressor ON.
15. Press «Enter» to accept the setting.
The action Compressor ON is set for the first switching point.
16. Specify further switching points in the same manner.

Result Weekdays, time and the actions Compressor ON/Compressor OFF are set for all switching points.

7.5.1.3 Activating the«compressor timer» key

1. Press «UP» repeatedly until *Key clock* is displayed as active line.

2. Press «Enter» to switch into setting mode.
The check box flashes in the active line.

6.1 bar 08:15 80.0 °C	
6 Compressor clock	Menu
Key clock : <input checked="" type="checkbox"/>	Active line with deactivated check box
Reset: <input type="checkbox"/>	
.....	
01 Mon-Fri 06:30 on	Switching point 01:
02 Mon-Fri 12:00 off	Switching point 02:
03 Mon-Fri 13:00 on	Switching point 03:

3. Use the «UP» key to activate the check box.
4. Press «Enter» to accept the setting.
5. Press «Escape» repeatedly to return to the main menu.
The «Timer» key is activated and can be used.
6. Press «Timer» to enable the operation with a timing program.

7.5.2 Setting up the holiday period

In addition to the fixed cycles of a timing programme or timer, you can also specify a longer lasting standstill time. For example, you may specify a standstill period for vacation close-down by defining the following:

Precondition The display shows the operating mode.

1. Press «Enter».
The main menu is displayed.
2. Select < Configuration → Compressor start → Compressor off >.
3. Press «DOWN» repeatedly until *Holidays* is displayed as active line.

6.1 bar 08:15 80.0 °C	
5.4.2 Compressor off	Menu
Venting period : <input type="checkbox"/>	
.....	
Holidays : <input type="checkbox"/>	Active line
Start : 23.12.12	
00:00	
End : 07.01.13	

4. Press «Enter» to switch into setting mode.
The *check box* flashes.

5. Press the «UP» key.

6.1 bar	08:15	80.0 °C	
5.4.2 Compressor off			Menu
Venting period : <input type="checkbox"/>			
.....			
Holidays : <input type="checkbox"/>			Active line with deactivated check box
Start : 23.12.12			
00:00			Time for start
End : 07.01.13			

6. Press Enter to accept the setting.



You may manually adjust the start and end of vacation close-down (date) in the setting mode. Adjust the times for start and end (hours and minutes) of the vacation close-down in the same manner described in chapter 7.5.1.2 (timing programme) for the times of the switching points.

Result You have set a standstill time 23.12.12–07.01.13 for your machine.

7.5.3 Starting the machine remotely from a control centre (remote ON/OFF)

If the machine is to be started and stopped from a remote control centre then the following settings have to be made:

Overview

- Make the electrical connection (a spare input for the remote contact is to be found in the electrical wiring diagram for the machine, DI 1.0 being preferred).
- Switch machine start to remote mode.
- Press the «remote» key.
- If necessary, activate the «clock » key and configure the clock program (see section 7.5.1.2).
- If required, assign the remote contact to another input.
- Press the «remote» key.

7.5.3.1 Switch machine start to remote mode

Two methods are available to start the machine remotely from a control centre:

- **Method A:** Starting the machine with the input signal from the remote control centre.
- **Method B:** Starting the machine from the remote control centre in addition to a configured ON/OFF clock program.
The machine can be started from the remote control centre even though the clock is activated and the program has selected compressor OFF at this point in time.

Precondition The electrical connection has been made.
Password level 2 is activated.
The display shows the operating mode.

1. Press «Enter».
The main menu is displayed.
2. Select the < Configuration → Compressor start → Compressor on > menu.

3. Press «UP» repeatedly until *Remote mode* is displayed as active line.
4. Press «Enter» to switch into setting mode.

Keyflashes.

6.1 bar 08:15 80.0 °C	
5.4.1 Compressor on Local mode : Key	Menu
Remote mode : Key	Active line
..... current Key RC DI 1.12 ok <input checked="" type="checkbox"/>	

5. Press «DOWN» repeatedly until *Key+RC* is displayed.
6. Press «Enter» to accept the setting.

6.1 bar 08:15 80.0 °C	
5.4.1 Compressor on Local mode : Key	Menu
Remote mode : Key+RC	Active line
..... current Key RC DI 1.12 ok <input checked="" type="checkbox"/>	

Result The machine start is set to remote operation with *Tst+FK*.

7.5.3.2 Activating/deactivating the «Remote control» key

Precondition The electrical connection has been made.
Password level 2 is activated.
The display shows the operating mode.

1. Press «Enter».
The main menu is displayed.
2. Select the *< Configuration → Compressor start → Compressor on >* menu.
3. Press «DOWN» repeatedly until *Key remote* is displayed as active line.

- Press «Enter» to switch into setting mode.
The *check box* for the remote control key will flash.

6.1 bar	08:15	80.0 °C	
5.4.1 Compressor on			Menu
Local mode : Key			
Remote mode : Key+RC			
.....			
RC DI 1.12 ok <input checked="" type="checkbox"/>			
Key remote : <input type="checkbox"/>			Active line with check box
Key clock : <input type="checkbox"/>			

- Press the «UP» key.
The activated check box is displayed.
- Press «Enter» to save the setting.

6.1 bar	08:15	80.0 °C	
5.4.1 Compressor on			Menu
Local mode : Key			
Remote mode : Key+RC			
.....			
RC DI 1.12 ok <input checked="" type="checkbox"/>			
Key remote : <input checked="" type="checkbox"/>			Active line with deactivated check box
Key clock : <input type="checkbox"/>			The Timer key is not activated.

- Press «Escape» repeatedly to return to the main menu.
The «Remote control» key is activated and can be used.
- If method **B** with the timer program is selected, the «Timer» key must be activated in the same manner.

7.5.3.3 Assigning another input



Inputs already assigned cannot be further assigned.

- Press the «DOWN» key repeatedly until the following is displayed as active line:

6.1 bar	08:15	80.0 °C	
5.4.1 Compressor on			Menu
Local mode : Key			
Remote mode : Key+RC			
.....			
RC DI 1.12 ok <input checked="" type="checkbox"/>			Remote contact DI 1.12 (preset)
Key remote : <input checked="" type="checkbox"/>			
Key clock : <input type="checkbox"/>			

- Press «Enter» to switch into setting mode.
Display for input flashes.
- Select another input with the «UP» or «DOWN» keys.

4. Press «Enter» to accept the setting.
The input has now been assigned.
5. Press the «Remote control» key to enable the machine to be started from the remote control centre.



If an input is rejected it means it is already assigned.
➤ Select a different input.

7.5.4 Activating/deactivating the idle phase (unloading function)

After receiving the OFF signal from the remote control centre, an additional idling (Venting function) phase can be activated before the machine is stopped completely. The duration of the idling phase can be timed and/or regulated by internal pressure.

Precondition Password level 2 is activated.
The display shows the operating mode.

1. Press «Enter».
The main menu is displayed.
2. Select the < Configuration → Compressor start → Compressor off > menu.
The "Venting" function is displayed in the active line.

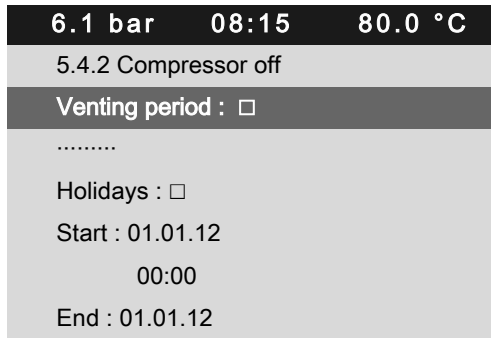

Menu
Actual setting: venting deactivated

3. Press «Enter» to switch into setting mode.
The check box for the "Venting" function will flash.
4. Press the «UP» key.

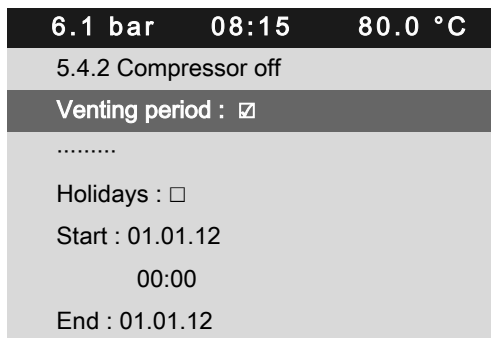

Menu
Actual setting: venting activated

5. Press «Enter» to save the setting.
The check box for the "Venting" function is activated.



The function can be deactivated in the same manner.

You may also activate the Venting function by pressing the «OFF» key on the controller.

- Press the «OFF» key.

Result The "Venting" function is activated.

Press the «OFF» key twice to immediately shut the machine off.

- Press the «OFF» key twice.

Result The machine is switched off without venting (idle time).

7.5.5 Activating/deactivating and adjusting the "automatic restart after a power failure" function

'Autostart:' is activated as standard.

To avoid overloading the mains power supply through several machines starting simultaneously a delay period determining the restart of each machine can be entered.

Overview

- If not activated, enter password for level 2
- Select the < Configuration → Compressor start > menu.
- Activate/deactivate the restart function
or
set the restart delay.

Precondition Access level 2 is activated.
The < Configuration → Compressor start > menu option is selected.

1. Press «Enter».
The *Compressor start* menu is displayed.

6.1 bar 08:15 80.0 °C	
5.4 Compressor start	Menu
▶1 Compressor on	Active line
▶2 Compressor off	
.....	
Autostart: : <input checked="" type="checkbox"/>	Automatic restart activated.
Target 10 s Actual 0 s	
.....	

Deactivating/activating automatic restart

1. Press «DOWN» repeatedly until *Autostart:* is displayed as active line.

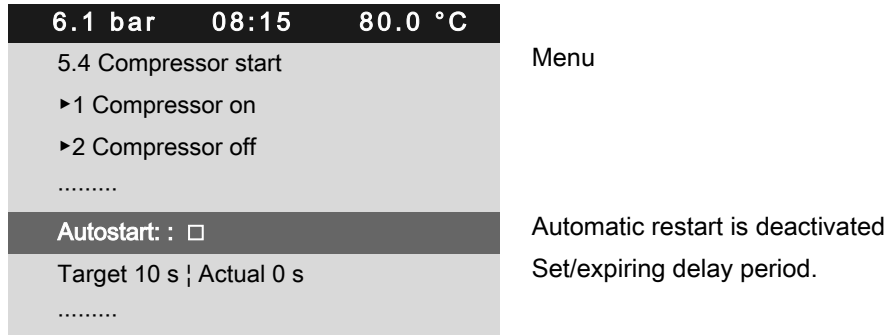

2. Press «Enter» to switch into setting mode.
The *check box* for the "Autostart" function will flash.
3. Press the «UP» key.
The check box for the "Autostart" function is deactivated.
4. Press «Enter» to accept the setting.



Activate the "Autostart" function in the same manner.

5. Press «Escape» repeatedly to return to the main menu.

Result Automatic restart after a power failure is now deactivated.

Setting up the automatic restart delay period



If you operate several machines, it is better to start them in sequence.
Time for restart: Use the set times (IDLE to LOAD) of the other machines as base.

Precondition Password level 2 is activated.
The < *Compressor start* > menu is selected.

1. Press «DOWN» repeatedly until the delay time for the restart is displayed as active line.

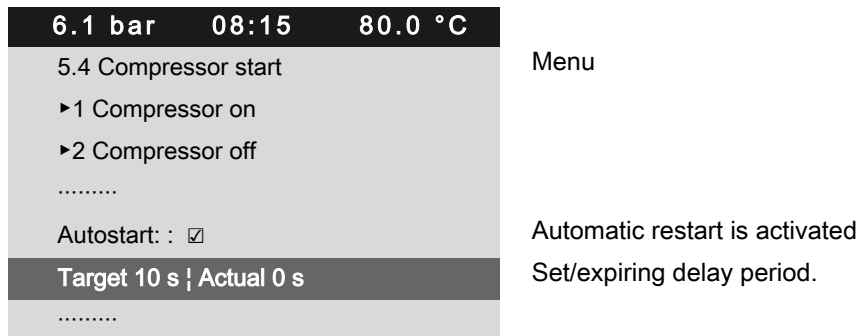

2. Press «Enter» to switch into setting mode.
The display for the delay time *Set point* flashes.

3. Change the time using the «DOWN» or «UP» keys.

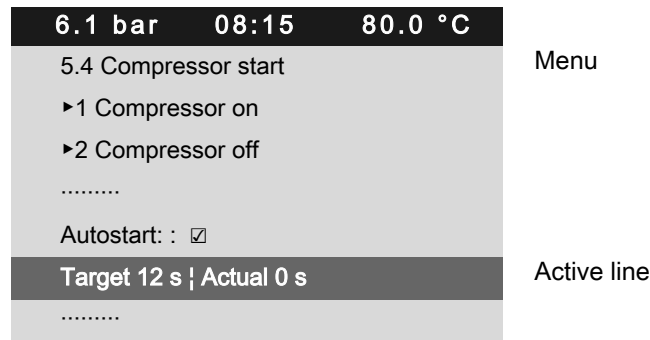

4. Press «Enter» to accept the setting.
5. Press «Escape» repeatedly to return to the main menu.

Result You have adjusted the delay time for the restart after a mains failure from 10 s to 12 s.

7.6 Activating and adjusting the control modes

The controller is provided with various control modes that can bring about different capacity utilisation depending on machine application. Chapter 4.7 provides a comprehensive description of all control modes.

7.6.1 Selecting a control mode

The following control modes are possible:

- DUAL
- QUADRO
- VARIO
- DYNAMIC
- CONTINUOUS



The standard setting of the control mode depends on the machine type.

Precondition Password level 2 is activated.
The display shows the operating mode.

1. Press «Enter».
The main menu is displayed.

- Select the *< Configuration → Control mode >* menu.
Local mode is displayed as active line.

6.1 bar	08:15	80.0 °C	
5.3 Control mode			Menu
Local mode : DUAL			Active line

▶1 Venting period			Venting period menu
.....			
▶2 DUAL			
▶3 QUADRO			

- Press «Enter» to switch into setting mode.
The display for *DUAL* control mode flashes.

6.1 bar	08:15	80.0 °C	
5.3 Control mode			Menu
Local mode : QUADRO			Active line

▶1 Venting period			Venting period menu
.....			
▶2 DUAL			
▶3 QUADRO			

- Use «UP» to change the regulating mode to *QUADRO*.
- Press «Enter» to accept the setting.
- Press «Escape» repeatedly to return to the main menu.

7.6.2 Adjust the idle time of DUAL mode

The machine is *READY* when the specified idle time has elapsed.
The shorter the period, the more often the machine will switch from *IDLE* to *READY*.
SIGMA CONTROL 2 will take into account the maximum motor switching capacity.
Depending on the machine type, the machine's motor may not fall below a minimum idling or standstill time.

Precondition Password level 2 is activated.
The control mode is selected.
The display shows the operating mode.

- Press «Enter».
The main menu is displayed.

2. Select the *< Configuration → Control mode → DUAL >* menu. (See section 7.6.1)
The setting for idle time is shown in the active line.

6.1 bar	08:15	80.0 °C	
5.3.2 DUAL			Menu
Idle period			
Target 240 s Actual 0 s			Active line

3. Press «Enter» to switch into setting mode.
The current idle time of *240 s* flashes.

6.1 bar	08:15	80.0 °C	
5.3.2 DUAL			Menu
Idle period			
Target 300 s Actual 0 s			Active line with changed Idle period , (example: 300 seconds)

4. Use «UP» to change to the desired idle time.
5. Press «Enter» to accept the setting.
6. Press «Escape» repeatedly to return to the main menu.

7.6.3 Adjusting the minimum running and unloaded period in QUADRO control mode

When the minimum running period has elapsed, the machine switches from IDLE to READY. Depending on the setting for the unloaded period, the machine switches first from LOAD to IDLE or directly to READY.

Precondition Password level 2 is activated.
QUADRO control mode is selected.
The display shows the operating mode.

1. Press «Enter».
The main menu is displayed.
2. Select the *< Configuration → Control mode → QUADRO >* menu.

7 Initial Start-up

7.7 Activating the settings for the refrigeration dryer

- Press «DOWN» repeatedly until *Target* is displayed as active line.

6.1 bar 08:15 80.0 °C	
5.3.3 QUADRO	Menu
Min. run period	
Target 240 s Actual 0 s	Active line set-point value for minimum run-time
.....	
Unloaded period	
Target 240 s Actual 100 s	

- Press «Enter» to switch into setting mode.
The set-point value *240 s* flashes.

6.1 bar 08:15 80.0 °C	
5.3.3 QUADRO	Menu
Min. run period	
Target 260 s Actual 0 s	Active line with changed set-point value for minimum run-time
.....	
Unloaded period	
Target 260 s Actual 100 s	Changed set-point value for unloaded period

- Use «UP» to change the minimum run-time.
- Press «Enter» to accept the setting.
- Change the unloaded period accordingly.
- Press «Escape» repeatedly to return to the main menu.

Further information See chapter 4.7 for an overview of the control modes.

7.7 Activating the settings for the refrigeration dryer

Overview:

- Set the operating mode
- Output messages
- Procedures following a fault of the refrigeration dryer:
 - Compressed air quality has priority
Call Service immediately
- Procedures following a fault of the refrigeration dryer:
 - Compressed air quantity has priority,
Activate fault mode without refrigeration dryer
- It is mandatory to follow the procedures indicated according to the priorities established for the compressed air quality or compressed air quantity!

7.7.1 Setting the CLOCK mode

You may select either CONTINUOUS or CLOCK mode for controlling the refrigeration dryer. If the CLOCK setting is used, the refrigeration dryer is shut-down under timing control whenever compressed air is not required.

The operating temperature in the refrigeration dryer is kept constant within narrow limits under this method of control by cycling the refrigerant circulation.

Precondition Access level 2 is activated.

1. In operating mode, switch to the main menu with the «Enter» key.
2. Select the < Configuration → Refrigeration dryer > menu.

The < Refrigeration dryer > menu is displayed.

6.1 bar	08:15	80.0 °C	
5.9 Refrigeration dryer			Menu
Control mode			Active line
Compressor ready:			
Continuous			
Compressor Clk/RC/RB off:			
off			
.....			

3. Press «DOWN» twice.
The *Continuous* line is displayed as being active.
4. Press «Enter» to switch into setting mode.
Display flashes.

6.1 bar	08:15	80.0 °C	
5.9 Refrigeration dryer			Menu
Control mode			
Compressor ready:			
Continuous			
Continuous			Active line
Compressor Clk/RC/RB off:			
off			
.....			

5. Press «UP» once.
The *Clock* mode is displayed.

- Press «Enter» to accept the setting.

6.1 bar 08:15 80.0 °C	
5.9 Refrigeration dryer	Menu
Control mode	
Compressor ready:	
Timer	Active line
Compressor Clk/RC/RB off:	
off	
.....	

- Press «Escape» repeatedly to return to the main menu.

Result The CONTINUOUS operating mode has been switched to CLOCK.

7.7.2 Output messages

If required, you can activate messages regarding the operating temperature of the refrigeration dryer as a binary signal.

You can assign to *DOR* or *DOT*.

If you have correctly parameterised, *ok* will be displayed.

Precondition Access level 2 is activated.

The *< Configuration → Refrigeration dryer >* menu is selected.

- Press «DOWN» repeatedly until *Temperature ↑* is displayed as active line.

6.1 bar 08:15 80.0 °C	
5.9 Refrigeration dryer	Menu
Temperature ↑	Active line, temperature high
DOR 1.07 <input type="checkbox"/> Logic : +	
DOT 1.01 <input type="checkbox"/> Logic : +	
Temperature ‡	
DOR 1.03 <input type="checkbox"/> Logic : +	
DOT 2.01 <input type="checkbox"/> Logic : +	

- Press «DOWN» once.
- Press «Enter» to switch into setting mode.
- Choose a spare DOR with the «UP» key.
- Press «Enter» to accept the setting.

6.1 bar 08:15 80.0 °C	
5.9 Refrigeration dryer	Menu
Temperature ↑	Temperature high
DOR 1.05 <input type="checkbox"/> Logic : +	Active line, example: DOR selected
DOT 1.01 <input type="checkbox"/> Logic : +	
Temperature ‡	
DOR 1.03 <input type="checkbox"/> Logic : +	
DOT 2.01 <input type="checkbox"/> Logic : +	

6. Press the «Right» key.
7. Press «Enter» to switch into setting mode.
8. Press «UP».
9. Press «Enter» to accept the setting.
ok is displayed in the active line.

6.1 bar	08:15	80.0 °C	
5.9 Refrigeration dryer			Menu
Temperature ↑			Temperature high
DOR 1.05 <input checked="" type="checkbox"/> Logic : +			Active line
DOT 1.01 <input type="checkbox"/> Logic : +			
Temperature ‡			Temperature low
DOR 1.03 <input type="checkbox"/> Logic : +			
DOT 2.01 <input type="checkbox"/> Logic : +			

10. Proceed in the same manner when configuring the *Temperature ‡* message.



- Upon activation of the check box, *err* is displayed.
- The parameterisation is incorrect.
 - Assign another and/or free output.

7.7.3 Fault in the refrigeration dryer – call Service

After a fault occurs in the refrigeration dryer, the SIGMA CONTROL 2 shut the machine down. No compressed air is delivered. Because compressed air quality is decisive factor (dried compressed air), you must call HPC Service immediately. The HPC Service Technician eliminates the fault and executes a reset.

Precondition The operator decides: Compressed air quality has a higher priority than the compressed air quantity

1. Keep machine shut down because the required compressed air quality is no longer delivered.
2. Immediately contact HPC Service.
The HPC Service Technician eliminates the fault and executes a reset.
The machine is ready for the delivery of high-quality, dried compressed air.

7.7.4 Fault in the refrigeration dryer – activate fault mode



NOTICE

Higher residual humidity in the compressed air
Higher residual humidity in the compressed air encourages corrosion.

- Carefully assess a "Fault mode without refrigeration dryer" in respect to the further use of the compressed air.

After a fault occurs in the refrigeration dryer, the SIGMA CONTROL 2 shut the machine down. In order to ensure compressed air delivery for a defined period of time, the operator can activate the "fault mode without refrigeration dryer" function. The quality of the compressed air (dried compressed air) is compromised in this case. The *0069 Error operation without RD → Call service!* warning message is displayed. The *0069* warning message remains active for the entire time of operation in fault mode.

Precondition The operator decides: Compressed air quantity has a higher priority than the compressed air quality

Access level 2 is activated.

The < Configuration → Refrigeration dryer > menu is selected.

1. Press «DOWN» repeatedly until *Error operation without RD* is displayed as active line.

6.1 bar	08:15	80.0 °C	
5.9 Refrigeration dryer			Menu
.....			
Error operation without RD			Active line
active: <input type="checkbox"/>			
Run time max.: 8h			Running time (fixed)
Actual			

2. Press the «DOWN» key.

The check box for activation of the fault mode is displayed as active line.

6.1 bar	08:15	80.0 °C	
5.9 Refrigeration dryer			Menu
.....			
Error operation without RD			
active: <input type="checkbox"/>			Active line
Run time max.: 8h			Running time (fixed)
Actual			

3. Press «Enter» to switch into setting mode.

The *check box* flashes.

4. Press «UP».

5. Press «Enter» to accept the setting.

6.1 bar	08:15	80.0 °C	
5.9 Refrigeration dryer			Menu
.....			
Error operation without RD			
active: <input checked="" type="checkbox"/>			Active line
Run time max.: 8h			Running time (fixed)
Actual			

Result "Fault mode without refrigeration dryer" is activated.

The compressor provides compressed air for connected consumers.

The compressed air delivered in this mode contains a higher residual humidity because the function of the refrigeration dryer is defective.

7.8 Configuring the machine for local mode

In local mode the machine is regulated with the system setpoint pressure pA or pB. The controller is provided with the following modes of operation:

Operating mode	Description	See section
pA	The machine is controlled by the system setpoint pressure pA.	7.8.3.3
pB	The machine is controlled by the system setpoint pressure pB.	
pA/pB Clock	The changeover between the system setpoint pressures pA and pB is regulated by a timer program.	7.8.2
pA/pB Cycle	The changeover between the system setpoint pressures pA and pB is regulated by a programmed time pulse.	7.8.3

Tab. 59 Local operating mode (local mode)

- Adjust the system setpoint pressure as described in Section 7.4.

Overview

- Enter access level 2.
- Select *< Configuration >*.
- Set/adjust the clock program (see section 7.8.2)
or
Set/adjust the clock (see section 7.8.3)
- Local mode

7.8.1 Select the *< Configuration → Pressure control → Load control >* menu

Precondition Access level 2 is activated.

1. In operating mode, switch to the main menu with the «Enter» key.
2. Select *< Configuration → Pressure control → Load control >*.
The *< Load control >* menu is displayed.

7.8.2 Configuring the system pressure setpoint changeover using the clock program



Note the configuration sequence:

- First, determine the clock program.
- Then select the operating mode.

Overview

- If not activated, enter password for level 2
- Set the day of the week for the first switching point (delete any existing clock program).
- Enter the time of the first switching point.
- Select the system setpoint pressure for the first switching point pA or pB.
- Define further switching points.
- Select the pA/pB Clock operating mode, see Section 7.8.3.3.



When setting a clock program for the first time, note first the switching times on a sheet of paper.

In addition to individual weekdays, the controller has the following cycles:

- Mon-Thu
- Mon-Fri
- Mon-Sat
- Mon-Sun
- Sat-Thu

Example:

- Peak load period: Weekdays 06:30 – 17:00, Fridays 06:30 – 16:00;
- Low load period: Midday from 12:00 – 13:00 and the remaining period.

The clock program is established with the following switching points (maximum 10 switching points available):

No.	Weekday	Time	System setpoint pressure
01	Mon-Fri	06:30	pA on
02	Mon-Fri	12:00	pB on
03	Mon-Fri	13:00	pA on
04	Mon-Thu	17:00	pB on
05	Fri	16:00	pB on

Tab. 60 Example of system pressure changeover switching points

Setting the day of the week for the first switching point

Precondition Password level 2 is activated,
The < Configuration → Pressure settings → Load control > menu is selected (see Section 7.8.1).

1. Press «DOWN» repeatedly until *pA/pB Clock* is displayed as active line.
2. Press «Enter».

The system displays the setting options for the switching points.

6.1 bar 08:15 80.0 °C	
5.2.3.1 pA/pB Clock	Menu
.....	
01 n.a. 00:00 pA	
02 n.a. 00:00 pA	
03 n.a. 00:00 pA	
04 n.a. 00:00 pA	
05 n.a. 00:00 pA	

3. Press «Enter» to switch into setting mode.
n.a. flashes in the active line.

6.1 bar 08:15 80.0 °C	
5.2.3.1 pA/pB Clock	Menu
01 Mon-Fri 06:30 pA	Active line (settings for weekdays, time, pA) (settings for weekdays, time, pB)
02 Mon-Fri 12:00 pB	
03 Mon-Fri 13:00 pA	
04 Mon-Thu 17:00 pB	
05 Fri 16:00 pB	

4. Use «DOWN» or «UP» to set the weekdays and confirm by pressing «Enter».
5. Press the «Right» key once.
6. Press «Enter» once.
The column time, display for hours, *00:00* in the active line flashes.
7. Use «UP» or «DOWN» to change the hour setting.
8. Press the «Right» key once.
9. Column, minutes display, *00 00* flashes in the active line.
10. Use «DOWN» or «UP» to set the time (minutes) and confirm by pressing «Enter».
The display stops flashing and the time (hours/minutes) is set.
11. Press the «Right» key once.
12. Press «Enter».
The display for the system setpoint pressure pA/pB flashes.
13. Use «UP» or «DOWN» to change the setting for pA or pB.
14. Specify further switching points in the same manner.

Delete the existing clock program

Take the following steps to delete an existing clock program:

Precondition Password level 2 is activated.

The < Configuration → Pressure settings → Load control > menu is selected.

1. Press «DOWN» repeatedly until *pA/pB Clock* is displayed as active line.
2. Press «Enter».
The current clock program is displayed.
3. Press the «UP» repeatedly until *Reset* is displayed as active line.

6.1 bar 08:15 80.0 °C	
5.2.3.1 pA/pB Clock	Menu
Reset: <input type="checkbox"/>	Active line
.....	
01 Mon-Fri 06:30 pA	
02 Mon-Fri 12:00 pB	
03 Mon-Fri 13:00 pA	
04 Mon-Thu 17:00 pB	

4. Press «Enter» to switch into setting mode.
The *Reset* check box flashes.
5. Press «UP».
The check box is activated.
6. Press «Enter» to accept the settings.

Result The clock program is now deleted.

Select the operating mode

1. Press the «DOWN» key.
2. Press «Enter» and use the «DOWN» or «UP» key to select pA or pB (not required in this example).
3. Set up the remaining switching points in the same way.
The clock program is now finished.
4. Select the pA/pB Clock operating mode, see Section 7.8.3.3.
5. Press «Escape» repeatedly to return to the main menu.

7.8.3 Configure the system pressure setpoint change-over using the clock

Overview

- Enter access level 2.
- Delete the old clock configuration, if necessary
- Set clock periods pA and pB
- Select starting time for pA or pB.
- Select the pA/pB Cycle operating mode, see Section 7.8.3.3.

7.8.3.1 Set clock periods pA and pB



- Keep to the order of the configuration. The operating mode pA/pB Cycle must not be activated when configuring the timer period.
- Configure the clock first and then select the operating mode or select another operating mode first.

Precondition Password level 2 is activated.
The < *Configuration* → *Pressure control* → *Load control* > menu is selected.

1. Press «DOWN» repeatedly until the *Settings pA / pB* menu section is displayed as the active line.
2. Press «Enter» to switch into setting mode.
pA flashes.
3. Press the «UP» repeatedly until the desired clock period is displayed as active line.

- Press «Enter» to accept the setting.

6.1 bar	08:15	80.0 °C
5.2.3 Load control		
pA/pB Cycle		
pA : 10 h – 10 h pB : 18 h – 18 h		
1.Start pA 00:00		
.....		

Menu

Active line, manually set setpoint value – automatically elapsing value (example)

- Set the timer period for pB in the same manner.
- Press «Enter» to accept the setting.

Result The timer period for the system setpoint pressure pA and pB is set.

7.8.3.2 Set starting time for pA or pB

- Press the «DOWN» key.
- Press the «Right» key.
- Press «Enter» to switch into setting mode.
The starting time *h* flashes.

6.1 bar	08:15	80.0 °C
5.2.3 Load control		
pA/pB Cycle		
pA : 10 h – 10 h pB : 18 h – 18 h		
1.Start pA 06:30		
.....		

Menu

Active line, starting time

- Press «UP» to set the hours.
- Press the «Right» key.
The starting time *min* flashes.
- Press «UP» to set the minutes.
- Press «Enter» to accept the settings.

Result The starting time for pA is set.



The period is to start with pB.
➤ Press «Enter» and specify the first start pB with «UP».

7.8.3.3 Select local mode

Precondition Password level 2 is activated.
The < Configuration → Pressure control → Load control > menu is selected.
The clock program or timer is set up.

7 Initial Start-up

7.9 Configuring the machine for master control

1. Press «UP» repeatedly until *Local mode* is displayed as active line.
2. Press «Enter» to switch into setting mode.

Operating mode flashes.

6.1 bar 08:15 80.0 °C	
5.2.3 Load control	Menu
Local mode pA/pB Cycle	Active line
.....	
Remote mode : pA	
Key remote : <input type="checkbox"/>	
.....	
current pA/pB Cycle	Display of the current operating mode

3. Press the «UP» or «DOWN» key to select the required operating mode (pA, pB, pA/pB Clock or pA/pB Cycle).
4. Press «Enter» to accept the setting.
The actual operating mode is displayed.
5. Press «Escape» repeatedly to return to the main menu.

Result The clock is fully configured.

7.9 Configuring the machine for master control

7.9.1 List of the various master controllers

The machine controller is provided with several methods of working under other controllers.

Method	Description	Section
Master control with Profibus (requires an additional module)	The controller (and therefore the compressor) receives the instruction LOAD, IDLE or local operation via the Profibus master (e.g. SIGMA AIR MANAGER or VESIS). The system setpoint pressures pA and pB are irrelevant for the LOAD/IDLE signals.	7.9.2
Master control of two compressors with SIGMA CONTROL 2 via Ethernet interface	2 The SIGMA CONTROL 2 controllers operate as master and slave. The slave receive the command to switch between the two system setpoint pressures pA and pB from the master.	7.9.4
Master control via LOAD remote contact. Master control via a LOAD remote contact is another method of controlling the machine externally. There are 2 possibilities:	LOAD remote contact An input signal from a superordinate controller switches the machine to LOAD or IDLE. The setpoint pressure settings pA and pB have no relevance.	7.9.5
	Local/LOAD remote contact: Using two inputs, a master controller (e.g. MVS 8000) switches the machine between LOAD/IDLE and local operation.	7.9.6

Method	Description	Section
Setpoint pressure pre-selection	pA/pB remote contact: An input contact provides the signal to switch from the system setpoint pressure pA to pB.	7.9.7
Master control of compressors regulated by pressure switch There are two possibilities of linking to a machine regulated by pressure switch:	On machines with the same FAD, SIGMA CONTROL 2 controls the pressure switch via a floating relay output.	7.9.8.1
	On machines supplying an unequal FAD, the pressure ranges are matched to each other.	7.9.8.2

Tab. 61 Master control – overview

Further information Examples of clock programs for equal machine loading are given in section 7.9.9.

7.9.2 Configuring Profibus mode (SIGMA AIR MANAGER or VESIS)

Overview

- Profibus DP-V0 Retrofit Kit required
- Establishing the electrical connection
- Set the remote operating mode pB.
- Configure the Profibus interface
- Activate the «Remote control» key

Precondition Profibus DP-V0 Retrofit Kit required

Establishing the electrical connection

Pin	Connections
1	Spare
2	Spare
3	Profibus connection B
4	TTL signal RTS
5	Earth
6	+5 V for bus terminal
7	Spare
8	Profibus connection A
9	Spare

Tab. 62 Profibus DP pin connection

Interface plug wiring

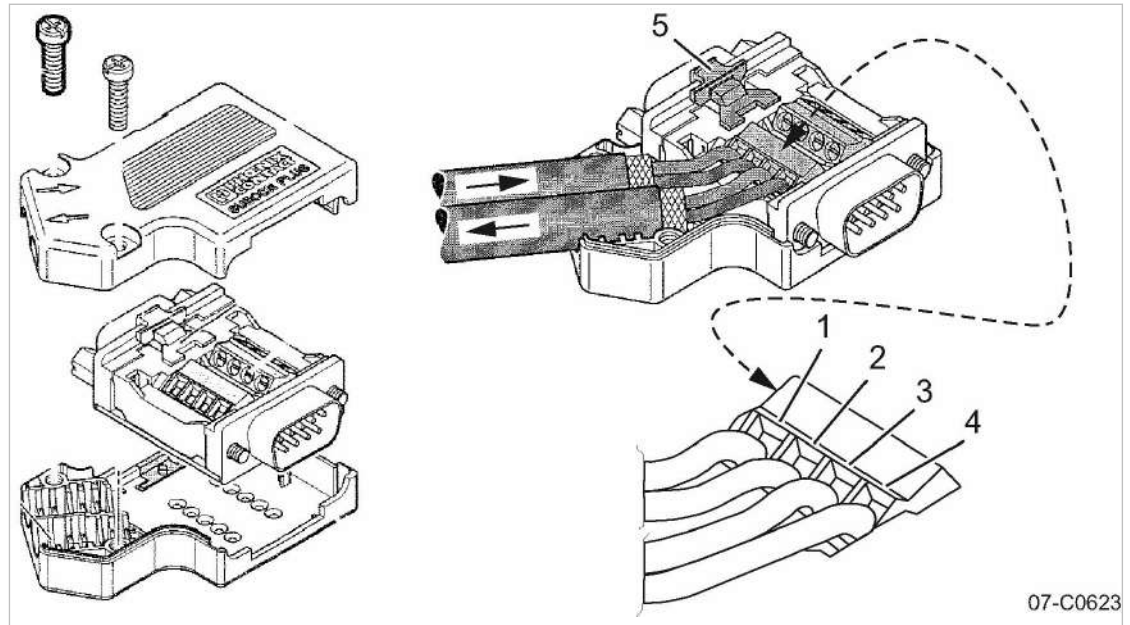

Fig. 26 Profibus plug wiring

- | | |
|---------------------------------------------------------------------------------------------------------------|---------------------------------------------------------------------------------------------------------------|
| <ul style="list-style-type: none"> ① Terminal 1A ② Terminal 1B ③ Terminal 2A | <ul style="list-style-type: none"> ④ Terminal 2B ⑤ Slide switch, terminating resistor |
|---------------------------------------------------------------------------------------------------------------|---------------------------------------------------------------------------------------------------------------|

Wiring possibilities for master control (excerpt)

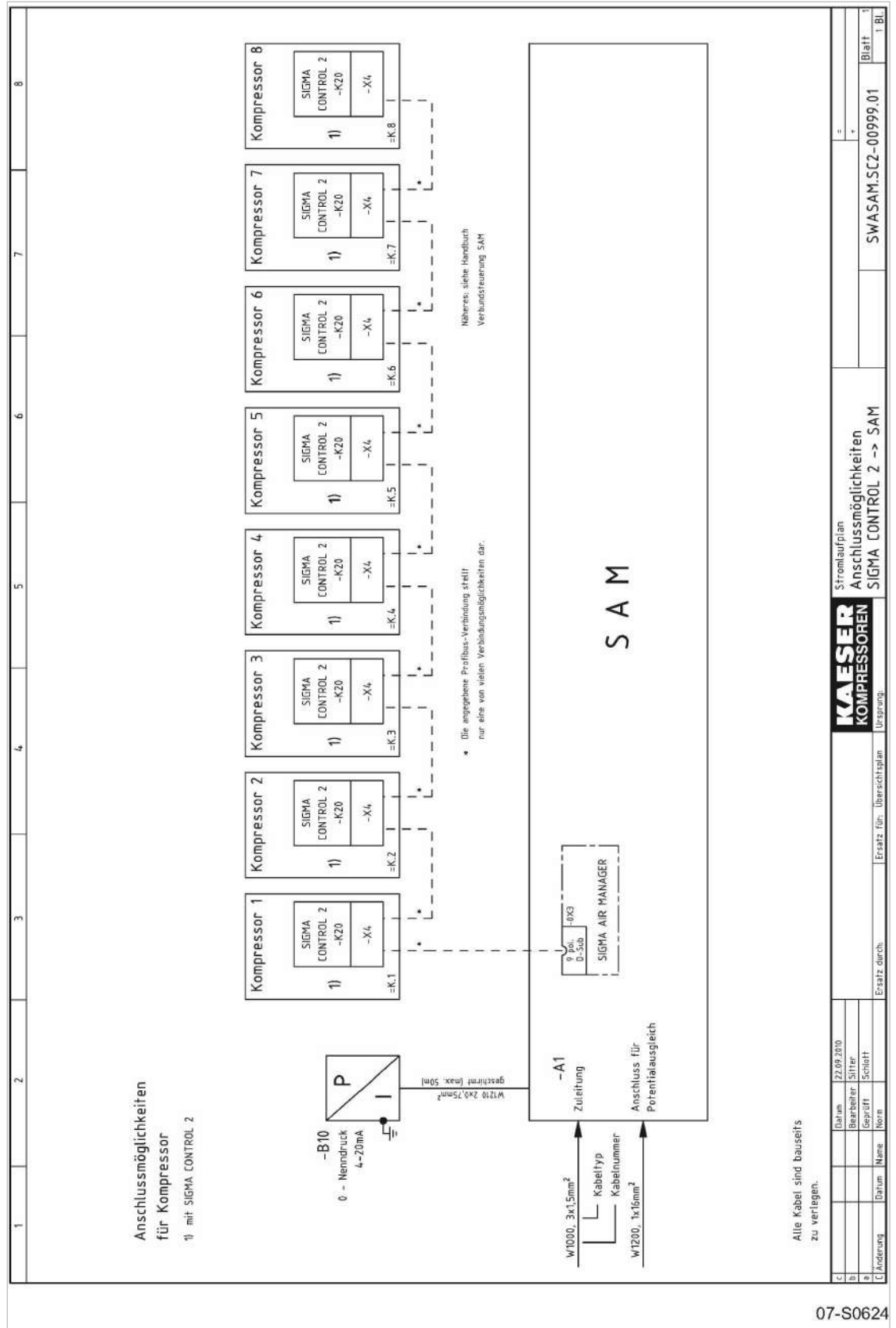

Fig. 27 Electrical diagram example with SIGMA AIR MANAGER

1. Connect the bus subscribers one after the other according to the pin assignment below.
2. Connect the screening to the plug housings at both ends.
3. Switch in the terminating resistor in the plugs of the first and last subscribers to the Profibus.

Result The terminals for the remaining bus conduit (2A/2B) are switched off.

Set the remote operating mode pB.



When automatic mode is changed to manual mode at the master controller, SIGMA CONTROL 2 changes into the set remote mode. In such a case it is preferable to set the operating mode to "remote mode pB".

- Note that multiple machines may be set to local operation when you set the the system setpoint pressure pB.

Precondition Access level 2 is activated.
Menu < Configuration → Pressure control → Load control > is selected.

1. Press «DOWN» repeatedly until *Remote mode* is displayed as active line.
2. Press «Enter» to switch into setting mode.
The operating mode display flashes.

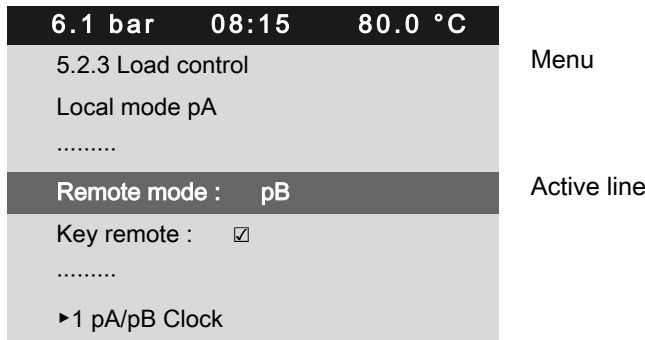

3. Use «UP» or «DOWN» to set pB operating mode.
4. Press «Enter» to accept the setting.
Remote operating mode pB is set.
5. Adjust the system setpoint pressure pB, if necessary.

Further information See chapter 7.4 for system setpoint pressure adjustment.

7.9.2.1 Inserting the communication module

The SIGMA CONTROL 2 communication interface is closed with a plastic cover when shipped from the factory. Before you can insert the communication module in the X4 interface, you must remove the plastic cover from the SIGMA CONTROL 2 . The designation of the interfaces is provided on the rear of the SIGMA CONTROL 2.

Material Small screwdriver
Torx screwdriver, size 9

Precondition The machine is disconnected from the power supply.
The absence of voltage has been verified.

- Work carefully.

Proper removal of the plastic cover

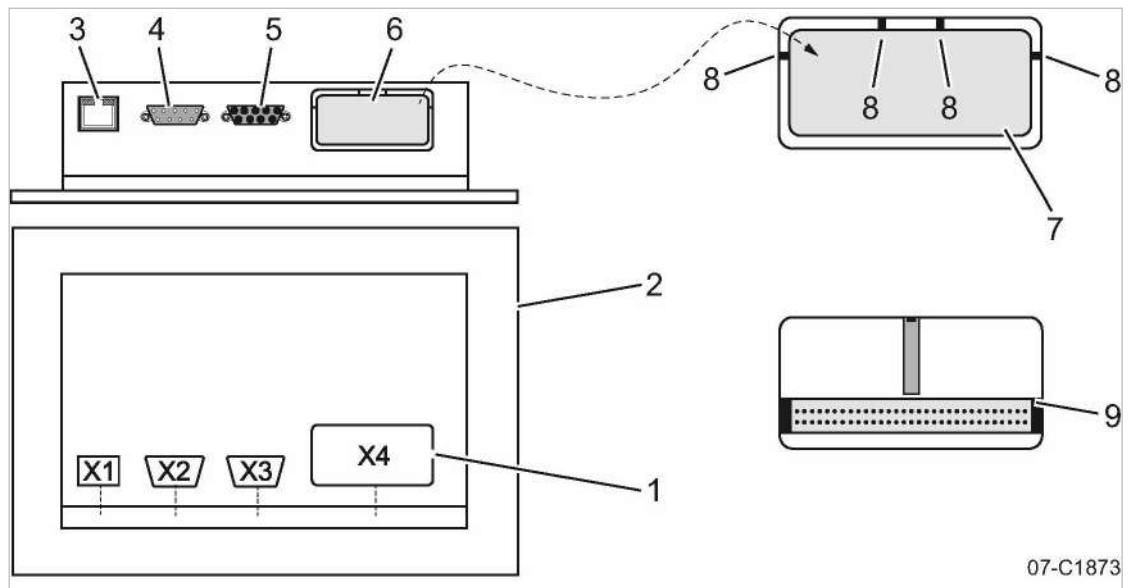

Fig. 28 Communication interface

- | | |
|-----------------------------------------------|----------------------------------------------------|
| ① Designation of the interfaces | ⑥ Communication interface X4 (customer interface) |
| ② Rear side of the controller SIGMA CONTROL 2 | ⑦ Plastic cover |
| ③ Ethernet interface X1 | ⑧ Fin |
| ④ IO BUS X2 | ⑨ Communication interface X4 without plastic cover |
| ⑤ RS485-FC (USS interface) X3 | |

1. Place the screwdriver next to the fin.
2. Insert the tip into the slot between the plastic cover and the enclosure of the SIGMA CONTROL 2.
3. Press the screwdriver down until the fin breaks.
4. Break all other fins in the same manner.
5. Remove the plastic cover.

Inserting and fixing the communication module

Align the communication module until both cable connectors are at the same height.

Precondition The plastic cover is removed.

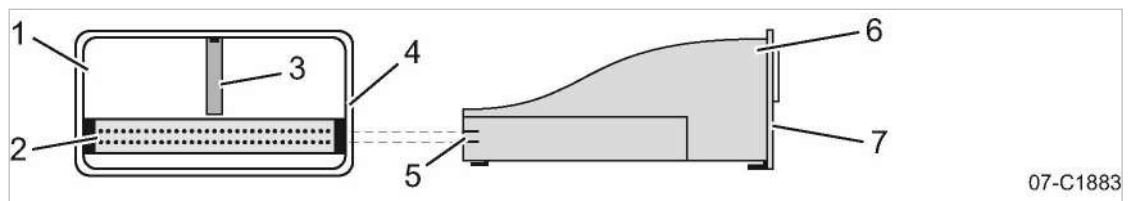

Fig. 29 Insert the communication module.

- | | |
|---------------------------------|-----------------------------------------|
| ① Bay, interface X4 | ⑤ Cable connector, communication module |
| ② Cable connector, interface X4 | ⑥ Communication module |
| ③ Guiding plate | ⑦ Front plate |
| ④ Recess, module bay | |

1. Align the communication module.
2. Insert the communication module into the bay of interface X4 until it latches (see Fig. 29)
The module is correctly installed when its front plate is seated solidly in the recess of the module bay.
3. Tighten both screws.

7.9.2.2 Activating operation via Profibus

Overview:

- Set the slave number
- Set reaction for a bus fault
- Activate the communications module
- Activate the remote mode

Precondition The communication module is plugged and screwed into the X4 interface.
The bus is wired to the bus master.
The machine's voltage supply is activated.
The machine is parameterised as a slave in the bus master.
The bus master is operational.

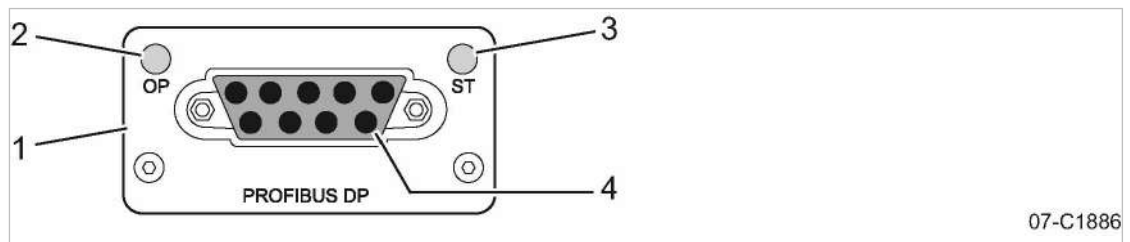

Fig. 30 Front plate of the PROFIBUS communication module

- | | | | |
|---|-------------------------------|---|--------------------|
| ① | PROFIBUS communication module | ③ | Status |
| ② | Operation | ④ | PROFIBUS interface |

➤ Proceed as shown.

Set the slave number



You only need to set the slave address for the communication with the SIGMA AIR MANAGER.
The other parameters do not require adjustment.
When connected to a SIGMA AIR MANAGER, the slave address is determined as follows:
Compressor number used at SIGMA AIR MANAGER +102.

1. In operating mode, switch to the main menu with the «Enter» key.

- Select the *< Communication → Com-Module >* menu.
The *< Com-Module >* menu is displayed.

6.1 bar 08:15 80.0 °C	
8.2 Com-Module	Menu
Status Counter 0	Active line
Com module not recognised	
Type None	
Com-Module Start : <input type="checkbox"/>	
Reset: <input type="checkbox"/>	

- Press «DOWN» six times.
The *Slave* line is displayed as being active.

6.1 bar 08:15 80.0 °C	
8.2 Com-Module	Menu
Type Profibus	Detected communication module
Com-Module Start : <input type="checkbox"/>	
Reset: <input type="checkbox"/>	
Slave No. : 103	Active line
.....	
Bus alarm	

- Press «Enter» to switch into setting mode.
The *Slave* display flashes.
- Press «DOWN» once.
- Press «Enter» to accept the setting.

6.1 bar 08:15 80.0 °C	
8.2 Com-Module	Menu
Type Profibus	Detected communication module
Com-Module Start : <input type="checkbox"/>	
Reset: <input type="checkbox"/>	
Slave No. : 102	Active line
.....	
Bus alarm	

Result Slave address 102 is set.

Set reaction for a bus fault

Exchange of data with a Profibus connection takes place in fixed cycles. The Profibus connection can be monitored with the help of the cycle time:
The bus connection is considered to be interrupted if no data is exchanged between the bus master and the controller (as bus subscriber) after the expiry of a set time period (time-out).
Time-out monitoring is activated. You may neither adjust nor deactivate time-out for SIGMA AIR MANAGER.



After switching on the power supply, the bus alarm can be suppressed temporarily.

- Settings for SIGMA AIR MANAGER **without** SIGMA AIR CONTROL PLUS
 - Start: 30 seconds
- Settings for SIGMA AIR MANAGER **with** SIGMA AIR CONTROL PLUS
 - Start: 40 seconds

1. Press «DOWN» five times.
The *Start* line is displayed as being active.

6.1 bar	08:15	80.0 °C	
8.2 Com-Module			Menu
Reset: <input type="checkbox"/>			
Slave No. : 102			
.....			
Bus alarm			
Start td : 30 s			Active line
Timeout : 5 s <input checked="" type="checkbox"/>			

2. Press «Enter» to switch into setting mode.
3. Use «UP» or «DOWN» to adjust the setting.
4. Press «Enter» to accept the setting.

Activate the communications module

1. Press «UP» five times.
The *Com-Module Start* line is displayed as being active.
2. Press «Enter» to switch into setting mode.
The *check box* flashes.

6.1 bar	08:15	80.0 °C	
8.2 Com-Module			Menu
Status Counter 0			
Com module not recognised			
.....			
Type None			
Com-Module Start : <input type="checkbox"/>			Active line
Reset: <input type="checkbox"/>			

3. Press «UP».

- Press «Enter» to accept the setting.
The communication module is activated.

6.1 bar	08:15	80.0 °C	
8.2 Com-Module			Menu
Status Counter 1			Status counter 1 is displayed.
No error			
.....			
Type	Profibus		Detected communication module
Com-Module Start : <input checked="" type="checkbox"/>			Active line
Reset: <input type="checkbox"/>			

- Press «Escape» repeatedly to return to the main menu.

Activate the «Remote control» key

- In operating mode, switch to the main menu with the «Enter» key.
- Select < *Communication* >.
The < *Communication* > menu is displayed.

6.1 bar	08:15	80.0 °C	
8 Communication			Menu
▶1 Ethernet			Active line
▶2 Com-Module			
Key remote : <input type="checkbox"/>			

- Press «DOWN» twice.
The «*Remote control*» key is displayed as active line.
- Press «Enter» to switch into setting mode.
- Press «UP» once.
- Press «Enter» to accept the setting.
The «Remote control» key is activated.

6.1 bar	08:15	80.0 °C	
8 Communication			Menu
▶1 Ethernet			
▶2 Com-Module			
Key remote : <input checked="" type="checkbox"/>			Active line

- In order to activate the remote control, press «Remote control» on the operating panel of SIGMA CONTROL 2.

Result The *green LED* of the «Remote control» key illuminates.

The bus master can remotely control the SIGMA CONTROL 2.

7.9.3 Configuring the Profibus interface without SIGMA AIR MANAGER or VESIS



Contact HPC Service for information on configuring the Profibus interface if Profibus is to be used.

Overview

- Select the Profibus interface
- Assign the slave address
- If necessary, set suppression time for bus fault
- Activate the communications module
- Assign an output contact for the bus fault message (spare output can be found in the electrical diagram)

Precondition Communications module from Profibus DP-V0 retrofit kit is installed.

The electrical connection to the bus master is made.

Access level 2 is activated.

The required data have been provided by HPC.

The display shows the operating mode.

Select the Profibus interface

1. Press «Enter».
2. Press «DOWN» repeatedly until *< Communication >* is displayed as active line.
3. Press «Enter».
4. Press the «DOWN» key.

The *< Com-Module >* menu is displayed as being active.

6.1 bar	08:15	73.0 °C	
8 Communication			Menu
▶1 Ethernet			
▶2 Com-Module			Active line
Key remote : <input checked="" type="checkbox"/>			

5. Press «Enter».

The *Status* line is displayed as being active.

6.1 bar	08:15	80.0 °C	
8.2 Com-Module			Menu
Status Counter 0			Active line
No error			

Type Profibus			Displayed communication module
Com-Module Start : <input type="checkbox"/>			
Slave No. 103			

Assign the slave address



The permissible address length is between 3 and 126.

For the configuration of the Profibus interface **without** SIGMA AIR MANAGER or VESIS, the rule "compressor number +102" **does not** apply.

1. Press the «DOWN» key repeatedly until *Slave* is displayed as active line.
2. Press «Enter» to switch into setting mode.

The slave display flashes.

6.1 bar	08:15	80.0 °C	
8.2 Com-Module			Menu
Status Counter 0			
No error			

Type Profibus			
Com-Module Start : <input type="checkbox"/>			
Slave No. 103			Active line, current slave address assigned

3. Set the slave address with «UP» or «DOWN».
4. Press «Enter» to accept the setting.

Result The slave address is assigned.

Further steps

Proceed with the further configuration as outlined in chapter 7.9.2:

- If required, set also the suppression time for the bus fault.

7.9.4 Configuring the master control of two machines in master/slave operation (Ethernet interface)

Two machines with SIGMA CONTROL 2 work as master/slave in the same air network. The master controls the machine configured as a slave and provides the signal for the system pressure set-point.

Example: Two machines with different delivery quantities

Local operating mode of the master: Local mode pA/pB Clock.

- Toggles between system pressure setpoints pA and pB by a clock program.
- At peak load times, pressure is regulated to system set-point pressure pA. During periods of low air demand, pressure is regulated to system setpoint pB (e.g., at week-ends).
- The machine with the lesser air delivery is the slave. In times with lower air demand, the machine with the smaller delivery is used more frequently.

Example: Two machines with equal delivery quantities

- Local operating mode of the master: Local mode pA/pB Cycle. (Toggles between system pressure setpoints pA and pB by a clock). The clock ensures even loading of both machines. The system pressure setpoints are set the same for both machines.
- During timer period 1, the master regulates to pA and signals the slave for pB. During timer period 2, the master regulates to pB and signals the slave to pA.



If two machines SIGMA CONTROL 2 are to work in master-slave mode, their controllers must have the same software version.

- Follow the configuration steps as described in table 63 .

Controller	Procedure	Chapter
Both	Establishing the electrical connection	7.9.4.1
Both	Set system pressure setpoints pA and pB. The pressure for switching points pA and pB is measured directly at the compressor. Pressure losses in the network do not need to be taken into account.	7.9.4.2and7.9.4.3
Master	Either set up switching times for the clock program	7.9.4.2
	or set switching times for the clock	7.9.4.2
Master	Set the type of LOAD control (clock program or clock) in local mode.	7.9.4.2
Slave	Set remote mode: pA/pB SC2	7.9.4.3
Slave	Activate the «Remote control» key	7.9.4.3
Both	Set IP addresses for Ethernet	7.9.4.2and7.9.4.3
Both	Activate controller as master or slave	7.9.4.2and7.9.4.3

Tab. 63 Master-slave configuration procedure

7.9.4.1 Establishing the electrical connection

Prepare the following for the Ethernet connection:

- Ethernet cable, 100 m maximum, depending on connection.
- For each machine with SIGMA CONTROL 2 :
 - Ethernet connector set
- For connecting the machines to a network (LAN):
 - 2 Ethernet connection plugs

- Make the electrical connections as shown in the table below.

Install the Ethernet cable



Use a cross-link Ethernet cable for the direct connection of two machines.

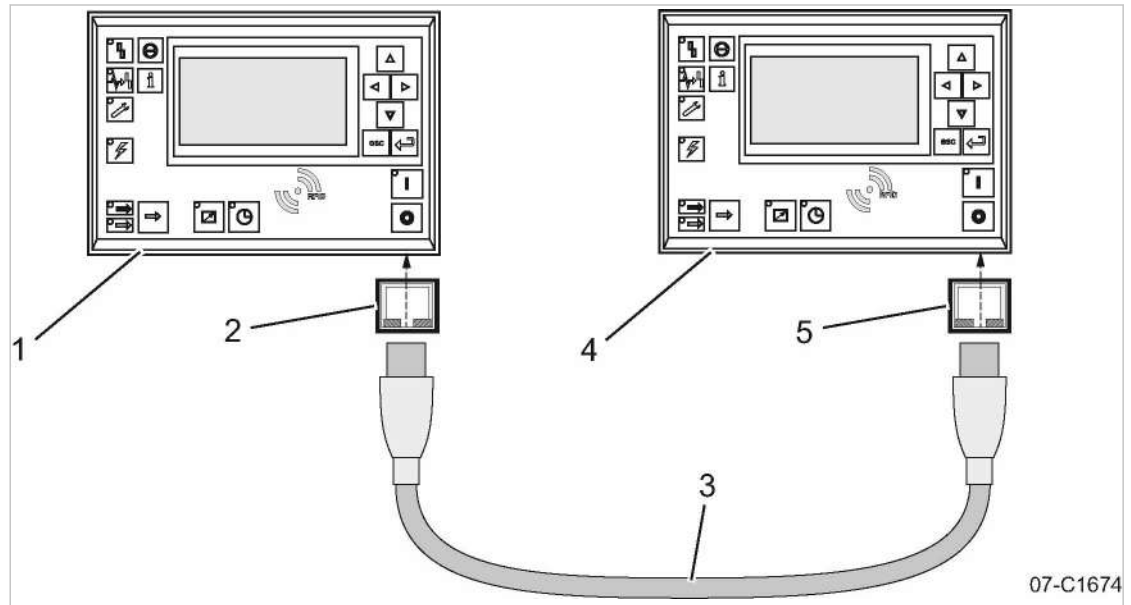

Fig. 31 Direct connection of two SIGMA CONTROL 2

- | | |
|--------------------------------------|-------------------------------------|
| ① Controller machine 1 (Master mode) | ④ Controller machine 2 (Slave mode) |
| ② Ethernet interface X1 | ⑤ Ethernet interface X1 |
| ③ Ethernet cable, cross-link cable | |

➤ Install the Ethernet cable between the two machines.

For connecting the machines to a network (LAN):

➤ Install the Ethernet cable from each machine to the next LAN connection.

Connect the Ethernet cable with the machine

For each machine:

1. Insert the Ethernet cable into the machine and the machine's control cabinet, using an EMC connection.
2. Lead the Ethernet cable through the cable ducts to SIGMA CONTROL 2 . Use the wiring path in the 24V range (blue wiring) of the ducts.
3. Install the Ethernet bus plug at the cable end.
4. Push the bus plug into the Ethernet interface X1 of the SIGMA CONTROL 2 until it latches.

For connecting the machines to a network (LAN):

Connect the Ethernet cable for each machine to the LAN connection.

1. Install the Ethernet bus plug at the cable end.
2. Push the bus plug into the LAN socket until it latches.

7.9.4.2 Configure the controller of machine 1 as master

Precondition The electrical connection is made.

Set the switching points pA and pB

1. Select the *< Configuration → Pressure control → Pressure settings >* menu.
The switching point pA is displayed as the active line.
2. Press «Enter» to switch into setting mode.
The display of switching point pA flashes.
3. Use «UP» or «DOWN» to set the required value.
4. Press «Enter» to accept the setting.
5. Press «DOWN» once.
The switching point pB is displayed as the active line.
6. Proceed as described for switching point pA.

Deactivate the «Remote control» key

1. Select the *< Configuration → Pressure control → Load control >* menu.
Local mode line is displayed as being active.
2. Press «DOWN» three times.
The «Remote control» key is displayed as active line.
3. Press «Enter» to switch into setting mode.
The check box flashes.
4. Press «UP» key to deactivate the check box.
5. Press «Enter» to accept the setting.

Setting the times

SIGMA CONTROL 2 provides the following options for selecting times:

- Clock program, or
 - Timer
1. Decide your desired method.
 2. Apply the corresponding settings (table).

Set a clock program	Setting the timer
<ol style="list-style-type: none"> 1. Select the < <i>Configuration</i> → <i>Pressure control</i> → <i>Load control</i> > menu. 2. Press «DOWN» five times. 3. Press «Enter» to open the < <i>pA/pB Clock</i> > menu. 4. Press «Enter» to switch into the setting mode for the first switching point. 5. Use «UP» or «DOWN» to set the week-days. 6. Press «Enter» to accept the setting. 7. Press «Right» to set the time. 8. Press «Enter» to switch into the time setting mode. 9. Use «UP» or «DOWN» to set the hours. 10. Press «Right» to set the minutes. 11. Use «UP» or «DOWN» to set the minutes. 12. Press «Enter» to accept the time settings. 13. Press «Right» to set the system setpoint pressure. 14. Press «Enter» to switch into the setting mode for system setpoint pressure pA or pB. 15. Press «UP» or «DOWN» to set the system setpoint pressure. 16. Press «Enter» to accept the setting. 	<ol style="list-style-type: none"> 1. Select the < <i>Configuration</i> → <i>Pressure control</i> → <i>Load control</i> > menu. 2. Press «DOWN» eight times to define the timer period for system setpoint pressure pA and pB. 3. Press «Enter» to switch into the setting mode for the system setpoint pressure pA. 4. Use «UP» or «DOWN» to set the timer period for the system setpoint pressure pA. 5. Press «Enter» to accept the setting. 6. Press the «Right» key. 7. Press «Enter» to switch into the setting mode for system setpoint pressure pB. 8. Use «UP» or «DOWN» to set the timer period for the system setpoint pressure pB. 9. Press «Enter» to accept the setting. 10. Press «DOWN» once. 11. Press «Enter» to switch into the setting mode for the first start of system setpoint pressure pA or pB. 12. Use «UP» or «DOWN» to set the first start of system setpoint pressure pA. 13. Press «Enter» to accept the setting. 14. Press «Right» to set the starting time. 15. Press «Enter» to switch into the setting mode for the starting time. 16. Use «UP» or «DOWN» to set the hours. 17. Press «Right» to set the minutes. 18. Use «UP» or «DOWN» to set the minutes. 19. Press «Enter» to accept the settings for the starting time.

IP configuration

If the controllers of both machines are linked directly, they must have different IP addresses.

Example:

- Controller machine 1 (Master mode): 169.254.100.101
- Controller machine 2 (Slave mode): 169.254.100.102

1. Select < *Communication* → *Ethernet* → *IP configuration* >.
2. Enter IP address for the slave.
3. Select < *Communication* → *Ethernet* → *Connections* → *SIGMA CONTROL 2* >.
4. Press «DOWN» twice.
5. Press «Enter» to switch into setting mode.
6. Use «UP» to set the controller of machine 1 to "Master".

7. Press «Enter» to accept the setting.
8. Press «DOWN» four times.
9. Press «Enter» to switch into setting mode.
10. Enter the IP address of the communication partner (slave).
11. Press «Enter» to accept the setting.

7.9.4.3 Configure the controller of machine 2 as slave

Precondition The electrical connection is made.

The < *Configuration* → *Pressure control* → *Pressure settings* > menu option is selected.

Set the switching points pA and pB

1. Select the < *Configuration* → *Pressure control* → *Pressure settings* > menu.
The switching point pA is displayed as the active line.
2. Press «Enter» to switch into setting mode.
The display of switching point pA flashes.
3. Use «UP» or «DOWN» to set the required value.
4. Press «Enter» to accept the setting.
5. Press «DOWN» once.
The switching point pB is displayed as the active line.
6. Set the switching point pB in the same manner.

Activate the «Remote control» key

1. Select the < *Configuration* → *Pressure control* → *Load control* > menu.
Local mode line is displayed as being active.
2. Press «DOWN» three times.
The «Remote control» key is displayed as active line.
3. Press «Enter» to switch into setting mode.
The check box flashes.
4. Press «UP» to activate the check box.
5. Press «Enter» to accept the setting.

Set the remote operating mode

1. Select the < *Configuration* → *Pressure control* → *Load control* > menu.
Local mode line is displayed as being active.
2. Press «DOWN» twice.
Remote mode line is displayed as being active.
3. Press «Enter» to switch into setting mode.
4. Use «UP» or «DOWN» to set the required value for pA/pB SC2.
5. Press «Enter» to accept the setting.

IP configuration

If the controllers of both machines are linked directly, they must have different IP addresses.

Example:

- Controller machine 1 (Master mode): 169.254.100.101
 - Controller machine 2 (Slave mode): 169.254.100.102
1. Select < *Communication* → *Ethernet* → *IP configuration* >.
 2. Enter IP address for the master.
 3. Select < *Communication* → *Ethernet* → *Connections* → *SIGMA CONTROL 2* >.
 4. Press «DOWN» twice.
 5. Press «Enter» to switch into setting mode.
 6. Use «UP» to set the controller of machine 2 to "Slave".
 7. Press «Enter» to accept the setting.
 8. Press «DOWN» four times.
 9. Press «Enter» to switch into setting mode.
 10. Enter the IP address of the communication partner (master).
 11. Press «Enter» to accept the setting.

7.9.5 Configuring master control using the LOAD remote contact (e.g., SIGMA AIR MANAGER BASIC)

Outline

- Establish the electrical connection for LOAD remote contact
 - Set the LOAD remote contact operating mode and assign the input
 - Adjust the pressure increase pE, if necessary.
 - Activate the «Remote control» key
- Configure master control as described below.

7.9.5.1 Establish the electrical connection for remote LOAD contact (excerpt)

Machine (example)

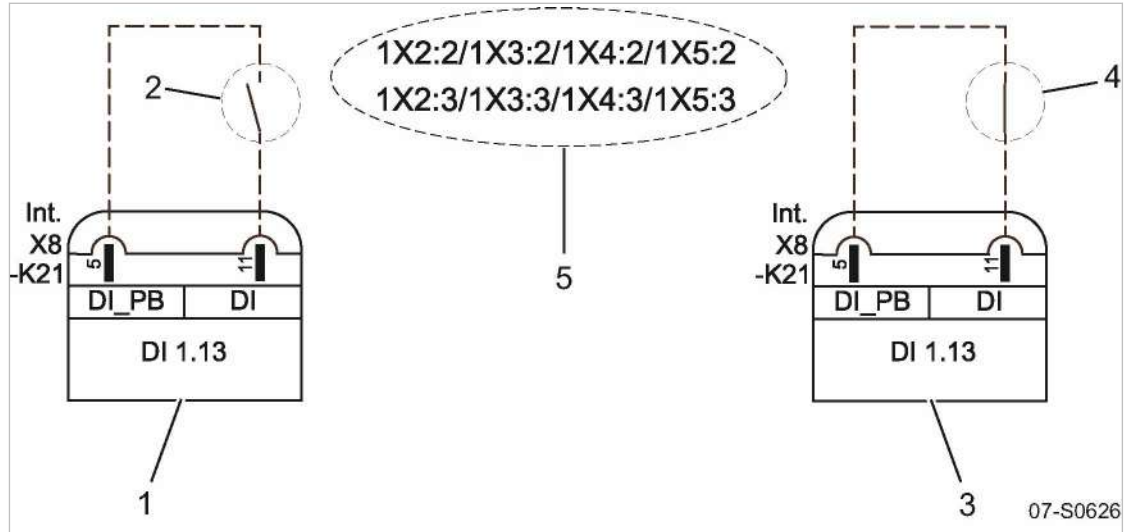

Fig. 32 LOAD remote contact

- ① Electrical connection DI 1.12
- ② LOAD remote contact open (IDLE)
- ③ Electrical connection DI 1.12
- ④ LOAD remote contact closed (LOAD)
- ⑤ SIGMA AIR MANAGER BASIC contacts

➤ Establish the electrical connection for DI 1.13 according to the diagram.

7.9.5.2 Setting the remote LOAD contact operating mode and assigning the input for LOAD remote contact

Precondition Access level 2 is activated.
The < Configuration → Pressure control → Load control > menu is selected.

Set the LOAD remote contact operating mode

1. Press «UP» or «DOWN» repeatedly until *Remote mode* is displayed as active line.
2. Press «Enter» to switch into setting mode.
The Remote operation display flashes.

6.1 bar 08:15 80.0 °C	
5.2.3 Load control	Menu
Local mode	
.....	
Remote mode : Load RC	Active line, current operating mode
Key remote : <input type="checkbox"/>	
.....	

3. Use «UP» to select the LOAD remote contact operating mode.
4. Press «Enter» to accept the setting.

Result The remote LOAD contact operating mode is set.

Assign the input for LOAD remote contact

The input for the LOAD remote contact is pre-assigned.



Setting is only necessary if you deliberately want to use a different input.

1. Press «DOWN» repeatedly until *Load RC* is displayed as active line.
2. Press «Enter» to switch into setting mode.

The *digital input* display flashes.

6.1 bar 08:15 80.0 °C	
5.2.3 Load control	Menu
pA/pB DO DOR 1.04 <input type="checkbox"/>	
.....	
Load RC DI 1.13 ok <input checked="" type="checkbox"/>	Active line; standard DI 1.13
loc.-load RC DI 1.09 <input type="checkbox"/>	
.....	
Key idle : <input checked="" type="checkbox"/>	

3. Use the «UP» or «DOWN» keys to select the input for the LOAD remote contact.
4. Press «Enter» to accept the setting.
5. Activate the check box for *DI 1.13*.
ok is displayed.

Result The operating mode is now configured.

7.9.5.3 Adjust pressure increase pE.

- Adjust the pressure increase pE as described in section 7.4.2.3.

Further information Detailed information on the pressure parameters is provided in chapter 7.4.2.

7.9.5.4 Activate the «Remote control» key

Precondition Access level 2 is activated.
The < *Configuration* → *Pressure control* → *Load control* > menu is selected.

1. Press «UP» repeatedly until *Key remote* is displayed as active line.
2. Press «Enter» to switch into setting mode.

The check box for *Remote control* flashes.

6.1 bar 08:15 80.0 °C	
5.2.3 Load control	Menu
Local mode	
.....	
Remote mode : Load RC	
Key remote : <input checked="" type="checkbox"/>	Active line
.....	

3. Use the «UP» key to activate the check box.

4. Press «Enter» to accept the setting.
The «Remote control» key is activated and can be used.
5. Press the «Remote control» key to enable remote mode.

7.9.6 Configuring the master control with local/LOAD remote contact

Outline

- Establishing the electrical connection
 - Set the local/LOAD remote contact operating mode and assign the input.
 - Configure the local operating mode, if necessary.
 - Activate the «Remote control» key
- Configure master control as described below.

7.9.6.1 Establishing the electrical connection



Use the input "Controller On (DOR 1.03) for the "alarm machine X" message to prevent line breaks!

➤ Wire the "motor running" and "Controller on" (DOR 1.03) messages from the compressor to the MVS 8000 controller.

- Contact A open: SIGMA CONTROL 2 controls with system setpoint pressurepB
- Contact A closed: SIGMA CONTROL 2 controls using a remote contact input.
- DI 1.13: LOAD/IDLE external
- DI 1.09: LOAD control – switchover local/LOAD remote contact.

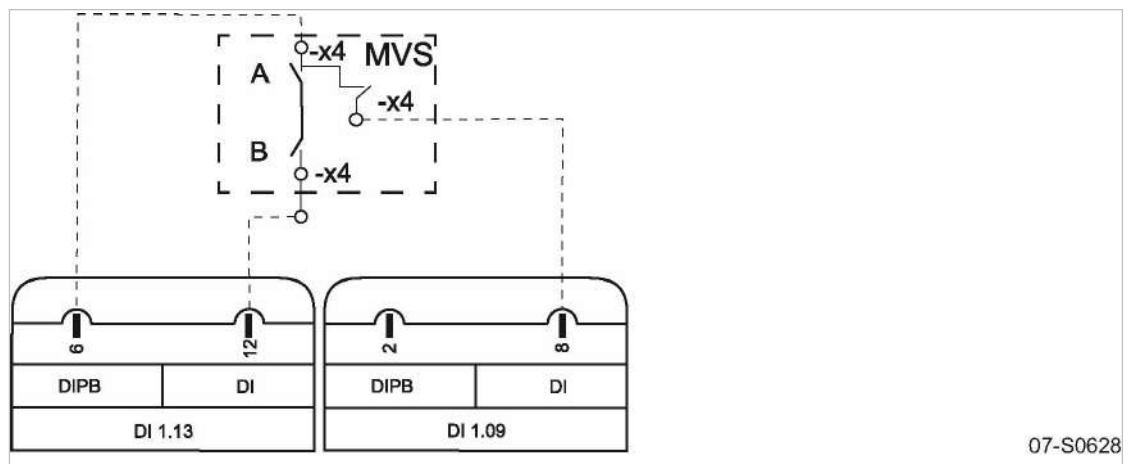

07-S0628

Fig. 33 Wiring diagram for local/LOAD remote contact:

- (A) Changeover between automatic and manual modes
- (B) LOAD/IDLE contact

➤ Make the electrical connection according to the diagram.

7.9.6.2 Set the local/LOAD remote contact operating mode and assign the input.

Precondition Access level 2 is activated.
The < Configuration → Pressure control → Load control > menu is selected.

Set local/LOAD remote contact operating mode:

1. Press «UP» repeatedly until *Remote mode* is displayed as active line.
2. Press «Enter» to switch into setting mode.

Remote mode flashes.

6.1 bar	08:15	80.0 °C	
5.2.3 Load control			Menu
.....			
Remote mode : loc.-load RC			Active line, current operating mode
Key remote : <input type="checkbox"/>			
.....			
current pA			

3. Use «UP» to select the *loc.-load RC* operating mode.
4. Press «Enter» to accept the setting.

Result The local/LOAD remote contact operating mode is set.

Assign an input for the local/LOAD remote contact for switching the pressure control

1. Press «DOWN» repeatedly until *loc.-load RC* is displayed as active line.
2. Press «Enter» to switch into setting mode.

D/ flashes.

6.1 bar	08:15	80.0 °C	
5.2.3 Load control			Menu
pA/pB DO DOR 1.04 <input type="checkbox"/>			No input assigned
.....			
Load RC DI 1.13 ok <input checked="" type="checkbox"/>			
loc.-load RC DI 1.09 ok <input checked="" type="checkbox"/>			Active line
.....			
Key idle : <input checked="" type="checkbox"/>			

3. Use «UP» to select a new input for local/LOAD remote contact.
4. Press «Enter» to accept the setting.

Result The input for local/LOAD remote contact operating mode is assigned.

7.9.6.3 Setting local operating mode pB



System setpoint pressure pB is normally set for local operation.

- When setting the system setpoint pressure pB, bear in mind that, under certain circumstances, more than one compressor may be operating in local mode (see section 7.4 for adjusting the system setpoint pressure).

Precondition Access level 2 is activated.
The < Configuration → Pressure control → Load control > menu is selected.

1. Press «UP» repeatedly until *Local mode* is displayed as active line.

2. Press «Enter» to switch into setting mode.
Setpoint pressure flashes.

6.1 bar 08:15 80.0 °C	
5.2.3 Load control	Menu
Local mode pB	Active line, current operating mode
.....	
Remote mode : loc.-load RC	
Key remote : <input type="checkbox"/>	
.....	
current pB	

3. Use «UP» to select the pB operating mode.
4. Press «Enter» to accept the setting.
5. Adjust the system setpoint pressure pB if necessary (see section 7.4).

Result The local operating mode pB is set.

7.9.6.4 Activate the «Remote control» key

Precondition Access level 2 is activated.
The < Configuration → Pressure control → Load control > menu is selected.

1. Press «UP» or «DOWN» repeatedly until *Key remote* is displayed as active line.
2. Press «Enter» to switch into setting mode.
The check box for *Key remote* flashes.

6.1 bar 08:15 80.0 °C	
5.2.3 Load control	Menu
.....	
Remote mode : loc.-load RC	
Key remote : <input checked="" type="checkbox"/>	Active line
.....	
current pB	

3. Use the «UP» key to activate the check box.
4. Press «Enter» to accept the setting.
The «Remote control» key is activated and can be used.
5. Press the «Remote control» key to enable remote mode.

Result The master control is fully configured.

7.9.6.5 Set the LOAD remote contact operating mode and assign the input

Precondition Access level 2 is activated.
The < Configuration → Pressure control → Load control > menu is selected.

Set the LOAD remote contact operating mode

Precondition Access level 2 is activated.
The < Configuration → Pressure control → Load control > menu is selected.

1. Press «DOWN» repeatedly until *Remote mode* is displayed as active line.
2. Press «Enter» to switch into setting mode.
Remote mode flashes.

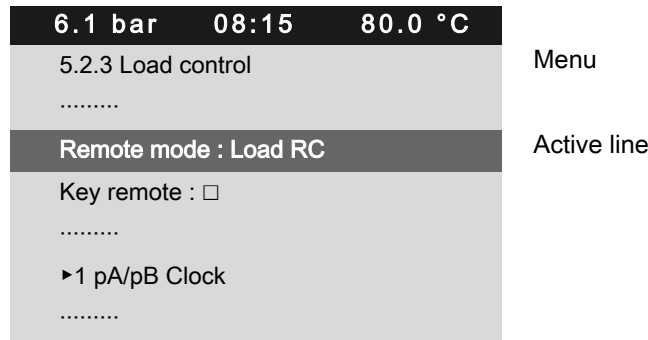

3. Use «UP» to select the *Load RC* operating mode.
4. Press «Enter» to accept the setting.

Result The LOAD remote contact operating mode is set.

Assign an input for the LOAD remote contact for switching the pressure control

1. Press «DOWN» repeatedly until *Load RC* is displayed as active line.
2. Press «Enter» to switch into setting mode.
*D/*flashes.

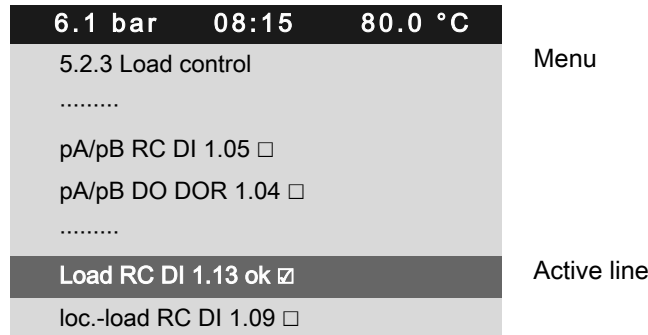

3. Use «UP» to select a new input for LOAD remote contact.
4. Press «Enter» to accept the setting.

Result The input for LOAD remote contact is assigned.

7.9.7 Configuring setpoint pressure pre-selection via remote contact

The signal to changeover from setpoint pressure pA to setpoint pressure pB comes from an input contact. If there is a signal at the input then system pressure is regulated on setpoint pressure pB.

Overview

- Setting up remote contact mode pA/pB

- Assigning the remote contact input
- Activating the «remote control» key
- Configure the setpoint pressure pre-selection as described.

7.9.7.1 Setting up remote contact mode pA/pB

Precondition Password level 2 is activated,
The electrical connections are made,
Menu < Configuration → Pressure control → Load control > is selected.

1. Press «UP» repeatedly until *Remote mode* is displayed as active line.
2. Press «Enter» to switch into setting mode.
Display for remote mode flashes.

6.1 bar 08:15 80.0 °C	
5.2.3 Load control	Menu
Remote mode : pA/pB RC	active line, current operating mode
Key remote : <input type="checkbox"/>	
▶1 pA/pB Clock	

3. Use the «UP» key to select operating mode pA/pB RC.
4. Press «Enter» to accept the setting.

Result Operating mode pA/pB remote contact is selected.

7.9.7.2 Assigning the remote contact input

A spare input can be found in the machine circuit diagram.

1. Press «UP» repeatedly until *pA/pB RC* is displayed as active line.
2. Press «Enter» to switch into setting mode.
D/flashes.

6.1 bar 08:15 80.0 °C	
5.2.3 Load control	Menu
pA/pB RC DI 1.05 ok <input checked="" type="checkbox"/>	Active line
pA/pB DO DOR 1.04	
Load RC DI 1.13 ok <input checked="" type="checkbox"/>	
loc.-load RC DI 1.09 ok <input checked="" type="checkbox"/>	No input assigned

3. Use the «UP» key to select input pA/pB RC.
4. Press «Enter» to accept the setting.

Result The input for remote contact has now been assigned.

7.9.7.3 Activating the «remote control» key

Precondition Password level 2 is activated,
Menu < Configuration → Pressure control → Load control > is selected.

1. Press «UP» repeatedly until *Key remote* is displayed as active line.
2. Press «Enter» to switch into setting mode.
Check box flashes.

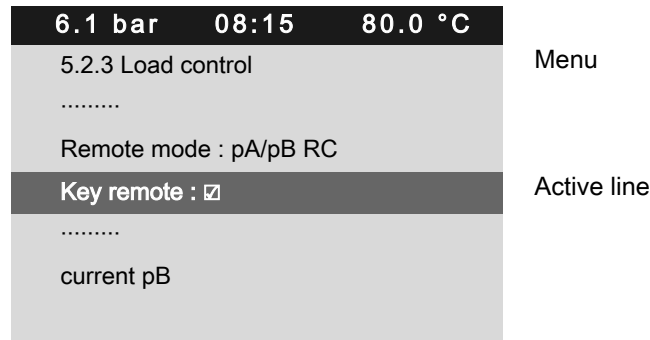

3. Use the «UP» key to activate the check box.
4. Press «Enter» to accept the setting.
The «remote control» key can be used.
5. Press the «remote control» key to enable remote mode.

Result The operating mode is now configured.

7.9.8 Configuring master control of compressors regulated by pressure switch

- Configure the master control as previously described.

7.9.8.1 Configuring master control via floating relay contact

Requirement:

A machine with SIGMA CONTROL 2 (e.g. series BSD) and a conventional machine **without** SIGMA CONTROL 2 of the same capacity are to run in sequence as base load or peak load machines.

Proposal:

- Set/adjust the clock program or clock on SIGMA CONTROL 2 .
- Select local mode with time control pA/pB Clock or clock pA/pB Cycle.
- Set the system setpoint pressures pA and pB analogous to the required values. They must be identical to the pressure switch settings on the machine without SIGMA CONTROL 2 .
- To make the setpoint changeover between the two machines possible, a floating relay contact must be assigned to the selected local operating mode. An auxiliary contactor can be energised via this contact to activate the pressure switches for pA and pB on the compressor without SIGMA CONTROL 2 . See the example wiring diagram below.

Overview

- Establishing the electrical connection
- Set the system setpoint pressure pA and pB.
- Configure/adjust the local operating mode

- Assigning the floating relay contact
- Set local operating mode

Establishing the electrical connection

- Contact A **open**: SIGMA CONTROL 2 controls with system setpoint pressure pB
- Contact A **closed**: SIGMA CONTROL 2 controls with system setpoint pressure pA
- B 1.1: Pressure switch for system setpoint pressure pB
- B 1.2: Pressure switch for system setpoint pressure pA

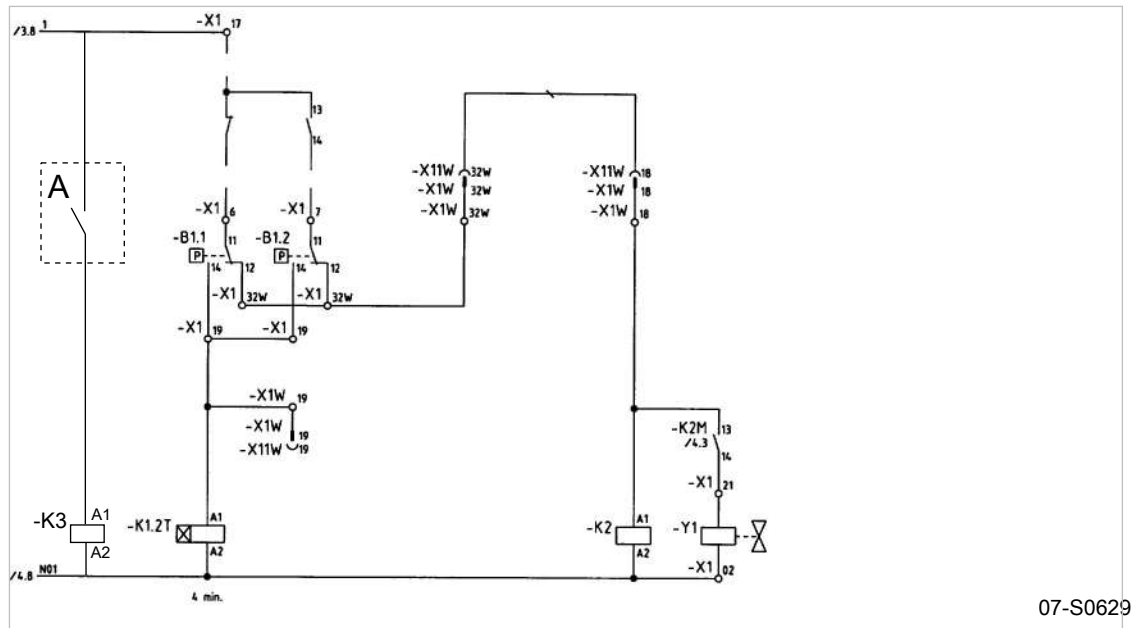

Fig. 34 Machine with pressure switch regulation

A potential-free contact SIGMA CONTROL 2

- Make the electrical connection according to the diagram.

Set the system setpoint pressure pA and pB.

Precondition Access level 2 is activated,
The electrical connections are made.

1. Select menu < Configuration → Pressure control → Pressure settings > (see section 7.4.1).

2. Press «Enter» to switch into setting mode.
Setpoint pressure pA flashes.

6.1 bar	08:15	80.0 °C	
5.2.2 Pressure settings			Menu
Setpoint pressure			
pA SP : 8.5 bar SD : - 0.5 bar			Active line
pB SP : 8.2 bar SD : - 0.5 bar			
.....			
System pressure low			
↓ < 5.0 bar SD : 0.5 bar			:

3. Use «UP» or «DOWN» to adjust the value.
4. Press «Enter» to accept the setting.
5. Adjust the switching differential pA in the same manner.
6. If necessary, adjust the value for pB in the same way.
7. Press «Escape» repeatedly to return to the main menu.

Configuring local mode

- Set the clock program or clock as described in section 7.8.

Assigning the potential-free contact (activate)

Precondition Access level 2 is activated, the electrical connection made (select spare contact from the machine's electrical diagram).

1. Select < Configuration → Pressure control → Load control >.
2. Press the «DOWN» key repeatedly until the following is displayed as active line:

6.1 bar	08:15	80.0 °C	
5.2.3 Load control			Menu
.....			
pA/pB RC DI 1.10 <input type="checkbox"/>			
pA/pB DO DOR 1.03 <input type="checkbox"/>			Active line, no output assigned
.....			

3. Press «Enter» to switch into setting mode.
Output display flashes.
4. Use «DOWN» or «UP» to select the required output (DOR).
5. Press «Enter» to accept the setting.
This output can now be used for the changeover between the two pressure switches.

Set local mode

Precondition Access level 2 is activated.

1. Select the < Configuration → Pressure control → Load control > menu.

7 Initial Start-up

7.9 Configuring the machine for master control

2. Press «UP» repeatedly until *Local mode* is displayed as active line.
3. Press «Enter» to switch into setting mode.

The *Local operation* display flashes.

6.1 bar	80.0 °C	
5.2.3 Load control		Menu
Local mode pA		Active line, current local operating mode
.....		
Remote mode : pA		
Key remote : <input type="checkbox"/>		
.....		
▶1 pA/pB Clock		

4. Use «UP» or «DOWN» to set pA/pB Clock or pA/pB Cycle operating mode.
 5. Press «Enter» to accept the operating mode.
- The actual operating mode is displayed.

7.9.8.2 Configuring the master control without an electrical connection

Requirement:

A high-capacity machine with SIGMA CONTROL 2 (e.g., BSD) is to work as base load machine. A second machine (e.g., SK) **without** SIGMA CONTROL 2 is to supply air in times of low demand.

Proposal:

- Select the system setpoint pressures pA and pB of the BSD machine for the switching point of the SK machine's pressure switch to be in between. When pB is activated for the periods of low demand, the SK machine automatically functions as the base load machine.
- Set the required values for a clock program on SIGMA CONTROL 2 .
- Select local mode pA/pB SC2 Clk.
- Activate the compressor timer

Function diagram:

Time period t1–t7: high compressed air demand	Time period t8–t14: low compressed air demand
t1 Air demand rises. System pressure pNloc drops.	t8: Air demand rises. System pressure pNloc drops.
t2 BSD switches to LOAD.	t9: SK switches to LOAD.
t3: System setpoint pressure pA reached. BSD switches to IDLE.	t10: System setpoint pressure pB reached. SK switches to IDLE.
t4: BSD switches to LOAD. Air demand not covered.	t11: BSD switches to LOAD. Air demand not covered.
t5: SK also switches to LOAD. System pressure pNloc starts to rise.	t12: SK switches to LOAD. System pressure pNloc starts to rise.

Time period t1–t7: high compressed air demand	Time period t8–t14: low compressed air demand
t6: SK switches to IDLE.	t13: SK switches to IDLE.
t7: BSD switches to IDLE.	t14: BSD switches to IDLE.

Tab. 64 Function diagram

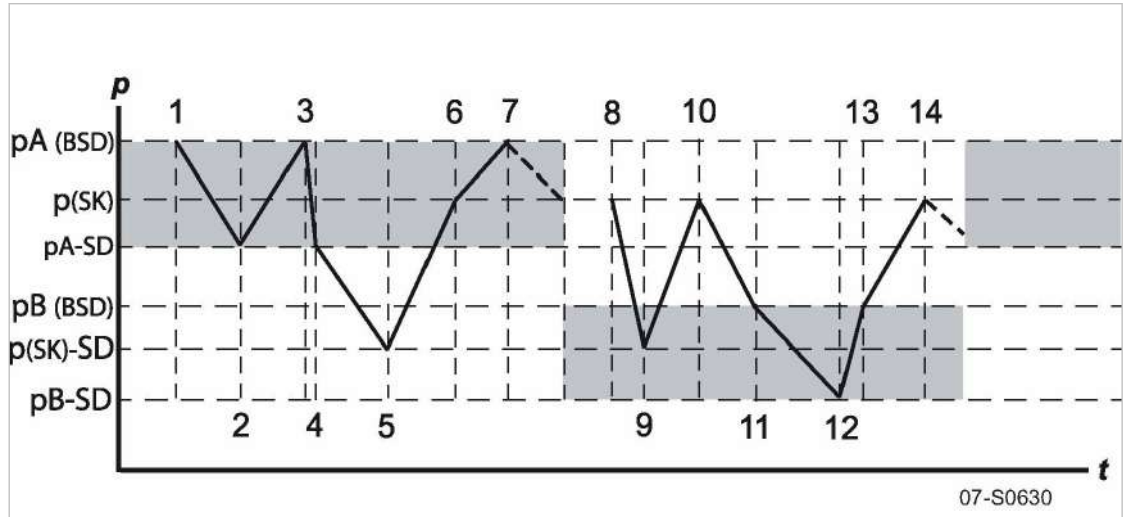

Fig. 35 Function diagram

- (SD) Switching differential
- (p) Pressure
- (t) Time

Set the system setpoint pressure pA and pB.

Precondition Access level 2 is activated.

1. Select < Configuration → Pressure control → Pressure settings > (see Section 7.4.1)
The < Pressure settings > menu is displayed.
2. Press «DOWN» repeatedly until *Setpoint pressure pA SP* is displayed as active line.

6.1 bar 08:15 80.0 °C
5.2.2 Pressure settings
Setpoint pressure
pA SP : 8.5 bar SD : -0.5 bar
pB SP : 8.2 bar SD : -0.5 bar
.....
System pressure low
< 5.0 bar SD : 0.5 bar

Menu

Active line with system set-point pressure pA and switching differential
System pressure setpoint pB and switching differential.

3. Press «Enter» to switch into setting mode.
The *display* for system setpoint pressure pA flashes.
4. Use «UP» or «DOWN» to adjust the value.

5. Press «Enter» to accept the setting.
6. Adjust the switching differential in the same way.
7. If necessary, adjust the values for system setpoint pressure pB in the same manner.
8. Press «Escape» repeatedly to return to the main menu.

Configuring the clock program

The clock program for the example is set up using the following switching points: A maximum of 10 switching points are available:

No.	Weekday	Time	System setpoint pressure
01	Mon-Fri	06:30	pA On
02	Mon-Fri	17:00	pB On

Tab. 65 Example switching points

Overview

- Set the day of the week for the first switching point.
- Set the time for the first switching point
- Set the system setpoint pressure for the first switching point
- Define further switching points.

Precondition Password level 2 is activated.
The < Configuration → Pressure settings → Load control > menu is selected.

➤ Configure the switching program as described below.

Enter the weekday for the first two switching points

1. Press the «DOWN» key repeatedly until < pA/pB Clock > is displayed as active line.

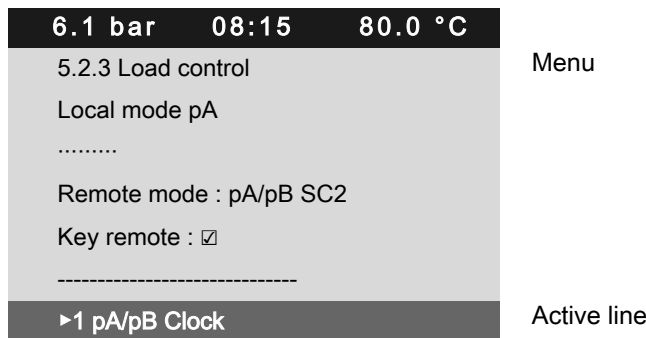

2. Press «Enter».
The < pA/pB Clock > menu is displayed.
3. If you want to delete an existing clock program, press «UP» until *Reset:* is displayed as the active line.
4. Press «Enter» to switch into setting mode.
The check box will flash.

- Press «UP».
The check box is activated.

6.1 bar	08:15	80.0 °C	
5.2.3.1 pA/pB Clock			Menu
Reset: <input checked="" type="checkbox"/>			Active line, delete existing clock program
.....			
01 n.a. 00:00 pA			First switching point deleted
02 n.a. 00:00 pA			Second switching point deleted
03 n.a. 00:00 pA			Third switching point deleted
04 n.a. 00:00 pA			Fourth switching point deleted

- Press «Enter» to accept the setting.
You have deleted the existing clock program.
All switching points are reset to *pA* .
The *Reset* check box is deactivated automatically.
- Press the «DOWN» key repeatedly until the switching point 01 is displayed as active line.
- Press «Enter» to switch into setting mode.
The *Weekdays* column flashes.
- Press «UP» repeatedly until Mon-Fri appears.
- Press «Enter» to accept the setting.

6.1 bar	08:15	80.0 °C	
5.2.3.1 pA/pB Clock			Menu
Reset: <input type="checkbox"/>			
.....			
01 Mon-Fri 00:00 pB			Active line, First switching point, set weekdays
02 Mon-Fri 00:00 pB			Weekday Second switching point
03 n.a. 00:00 pB			
04 n.a. 00:00 pB			

- Enter the weekdays for the second switching point in the same manner.

Result The weekdays for the first two switching points are set.

Set the time for the first two switching points

- Press the «UP» key repeatedly until the switching point 01 is displayed as active line.
- Press the «Right» key once.
- Press «Enter» to switch into setting mode.
The column time, display for hours, *00 : 00* in the active line flashes.
- Use «UP» to specify the settings for the hours.
- Press the «Right» key once.
The column time, display for minutes, *00 : 00* in the active line flashes.
- Use «UP» to specify the settings for the minutes.

7 Initial Start-up

7.9 Configuring the machine for master control

- Press «Enter» to accept the settings.

The display stops flashing and the time (hours/minutes) is set.

6.1 bar	08:15	80.0 °C	
5.2.3.1 pA/pB Clock			Weekday setting.
Reset: <input checked="" type="checkbox"/>			
.....			
01 Mon-Fri 06:30 pB			Active line, time, first switching point
02 Mon-Fri 17:00 pB			Time, second switching point
03 n.a. 00:00 pB			
04 n.a. 00:00 pB			

- Enter the time for the second switching point in the same manner.

Result The times for the first two switching points are set.

Select the system setpoint pressure pA or pB for the first two switching points.

- Press the «UP» key repeatedly until the switching point 01 is displayed as active line.
- Press the «Right» key twice.
The column for system setpoint pressure pA or pB is displayed.
- Press «Enter» to switch into setting mode.
The column for the system setpoint pressure flashes.
- Use «UP» to specify the settings for the system setpoint pressure pA or pB.
- Press «Enter» to accept the settings.

6.1 bar	08:15	80.0 °C	
5.2.3.1 pA/pB Clock			Weekday setting.
Reset: <input checked="" type="checkbox"/>			Current start time
.....			
01 Mon-Fri 06:30 pA			System setpoint pressure for the first switching point
02 Mon-Fri 17:00 pB			System setpoint pressure for the second switching point
03 n.a. 00:00 pB			
04 n.a. 00:00 pB			

- Enter the system setpoint pressure for the second switching point in the same manner.
- Press «Escape» repeatedly to return to the main menu.

Result Select the system setpoint pressure pA or system setpoint pressure pB for the first two switching points.

Set local mode

Precondition Access level 2 is activated.

- Select the < Configuration → Pressure settings → Load control > menu.
The *Local mode* mode is displayed as being active.

2. Press «Enter» to switch into setting mode.
The *Local operation* display flashes.

6.1 bar	08:15	80.0 °C	
5.2.3 Load control			Menu
Local mode	pA/pB Clock		Active line
.....			
Remote mode : pA/pB SC2			
Key remote : <input type="checkbox"/>			

▶1 pA/pB Clock			

3. Press «UP» repeatedly until *Local mode pA/pB Clock* appears.
4. Press «Enter» to accept the setting.

Result The current local mode *pA/pB Clock* is set.

7.9.9 Examples of time settings for equal overall load

Requirement:

Two machines of the same capacity are to be equally loaded. Versions A, B and C describe the different possibilities of achieving this requirement.



A detailed description for configuring a clock or timer program can be found in chapter 7.8.

Variant A: Daily switch between system set-point pressure pA and system set-point pressure pB after 24 hours

The compressors start with a system set-point pressure pB at 00:00 hours. A timer triggers the switch between system set-point pressure pA and system set-point pressure pB (local operating mode: Local mode pA/pB Cycle).

Precondition The setpoint pressure pA/pB is configured the same for both machines.

- Establish a cycle with the following switching points:
 - Cycle time pA: 24 h
 - Cycle time pB: 24 h
 - Start pB: 01:00:00

Variant B: Equal duty cycle during the day

A timer triggers the switch between system set-point pressure pA and system set-point pressure pB (local operating mode pA/pB Clock).

Precondition The setpoint pressure pA/pB is configured the same for both machines.

- The clock program is set up using the following switching points:

No.	Weekday	Time	System set-point pressure
01	Mon-Sun	00:00	pA On
02	Mon-Sun	06:00	pB On

No.	Weekday	Time	System set-point pressure
03	Mon-Sun	12:00	pA On
04	Mon-Sun	18:00	pB On

Tab. 66 Example for a clock program for equal duty cycling during the day

Variant C: Equal duty cycle during the week

A timer triggers the switch between system set-point pressure pA and system set-point pressure pB (local operating mode: pA/pB SC2 Clk).

Precondition The setpoint pressure pA/pB is configured the same for both machines.

➤ The clock program is set up using the following switching points:

No.	Weekday	Time	System set-point pressure
01	Mon	00:00	pA On
02	Mon	21:00	pB On
03	Tue	18:00	pA On
04	Wed	15:00	pB On
05	Thu	12:00	pA On
06	Fri	09:00	pB On
07	Sat	06:00	pA On
08	Sun	03:00	pB On

Tab. 67 Example for a clock program for equal duty cycling during the week

7.10 Configuring e-mail

SIGMA CONTROL 2 uses e-mail to send information (messages) to an e-mail address. For this purpose, an Ethernet connection with an SMTP server is required.

Overview

- Select the menu < *Communication* → *Ethernet* >.
- Configure and activate the e-mail function.
- Set interval and suppress repeats.

Select menu

1. Select the menu < *Communication* → *Ethernet* >.

2. Press «DOWN» twice.

E-mail sub-menu line is displayed as being active.

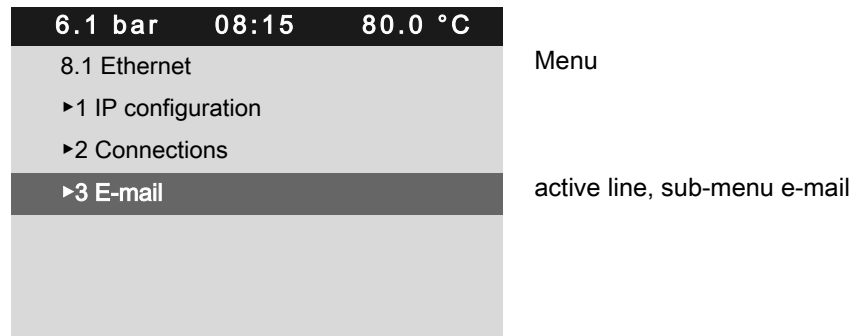

Configure and activate the e-mail function

Precondition Password level 2 is activated.

E-mail sub-menu is displayed as being active.

1. Press «Enter».
The display shows *E-mail function* as the active line..
2. Press «Enter» to switch into setting mode.
The *check box* for the e-mail function flashes.
3. Press «UP» to deactivate the e-mail function.
4. Press «Enter» to accept the setting.
The e-mail function is deactivated.

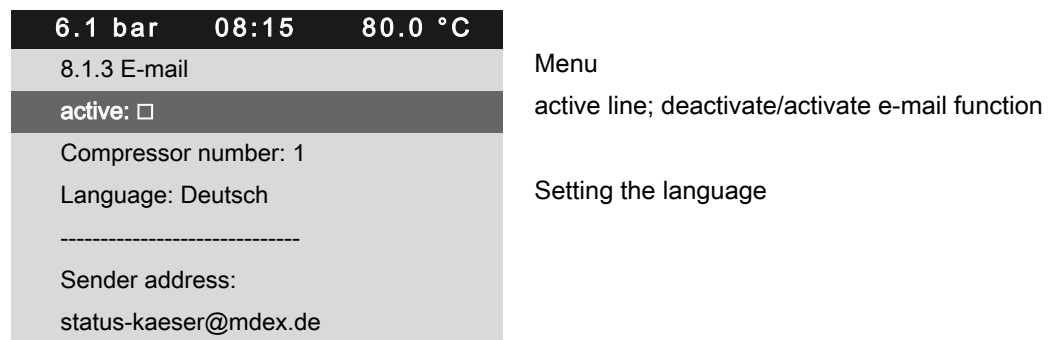

5. Set:
 - Compressor number
 - Language
 - Sender address
 - Sender's name
 - Telephone number of contact person
 - Recipient address
 - SMTP server:
 - Username
 - Password
6. Reactivate the e-mail function.
7. Press «Escape» repeatedly to return to the main menu.



Further setting options:

- SMTP port
- Timeout
- Interval (repeats)

Result The e-mail functions are configured and activated.

Suppress repeat messages (interval)

To suppress messages repeating at short intervals, a period of 0 – 900 minutes can be set during which a repeat of the same message is suppressed, i.e. is not sent.

Precondition Password level 2 is activated.
E-mail sub-menu is displayed as being active.

1. Press «Enter».
2. Press «DOWN» repeatedly until *Interval:* is displayed as active line.
3. Press «Enter» to switch into setting mode.
The *value* for the time of suppression flashes.



4. Use the «UP» or «DOWN» keys to set the desired duration of suppression.
5. Press «Enter» to accept the setting.
6. Press «Escape» repeatedly to return to the main menu.

Result Interval is set.

7.11 Configuring input and output signals

The controller's binary and analog inputs and outputs can be used for other requirements.

This chapter deals with the various options in the following sections:

- 7.11.1: Outputting important operational states of the compressors.
- 7.11.2: Display of analog input values
- 7.11.3: Displaying additional binary input signals



The controller only allows assignment of spare inputs and outputs. Any assignment of a pre-assigned input or output is discarded by the controller. When delivered from the factory, the outputs DO0.3 to DO0.5 are available for assignment. Further spare outputs can be found in the machine circuit diagram.

- Configure the inputs and outputs as described in the following.

7.11.1 Outputting important operational states of the machine

Important operational machine states can be made available as a binary signal via floating contacts.

Each output can be assigned only once.

The following messages can be output:

Message	Explanation	Output
Controller on	Controller is powered up	
Compressor on	The machine is switched on.	
Motor running	Compressor motor running	
IDLE	The machine is running in IDLE mode	
ON LOAD	The machine is running in LOAD mode	
Group alarm	Fault has occurred	
Group warning	Warning message has appeared	
Remote mode	Remote mode is activated	
Clock active	The clock is activated	
Clock contact	The clock contact is closed.	
EMERGENCY STOP	The «EMERGENCY OFF» button has been pressed	

Tab. 68 Assigned output signals

Overview

Navigate to the < Configuration → I/O periphery → DO functions > menu for the configuration:

- Access level 2 is activated.
- Assigning a message to an output

7.11.1.1 Selecting the < Configuration → I/O periphery > menu

Precondition Access level 2 is activated.

1. In operating mode, switch to the main menu with the «Enter» key.
2. Select < Configuration → I/O periphery → DO functions >.
A list of available messages and their assigned outputs is displayed.

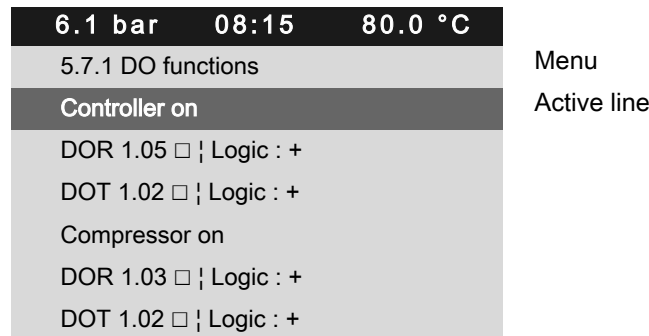

7.11.1.2 Assigning a message to an output

1. Select the required message with the «DOWN» key.

2. Press «Enter» to switch into setting mode.
The display of the selected message flashes.

6.1 bar	08:15	80.0 °C	
5.7.1 DO functions			Menu
Controller on			
DOR 1.05 <input checked="" type="checkbox"/> Logic : +			Active line with assigned output
DOT 1.02 <input type="checkbox"/> Logic : +			
Compressor on			
DOR 1.03 <input type="checkbox"/> Logic : +			
DOT 1.02 <input type="checkbox"/> Logic : +			

3. Select a free output with the «UP» or «DOWN» key.
4. Press «Enter» to accept the setting.
5. Press the «Right» key.
6. Press «Enter» to switch into setting mode.
7. Activate the check box.
8. Press «Enter» to accept the setting.
If the message is correctly assigned to the output and activate, *ok* is displayed.
9. If necessary, set *Logic*.
A message is now sent via the assigned output.



You are missing an organised display of assigned output signals?
➤ Enter the selected output in table 68.

7.11.2 Displaying analog input values

The *< Performance data >* menu can display up to six values from analog measuring sensors of pressure or temperature, for example.
Of these, two each are assigned to pressure and temperature transducers; two further inputs can be assigned to freely selectable sensor types. A list of standard analog data that can be displayed is found in chapter 8.7.

Overview

Navigate to the *< Configuration → I/O periphery → Analogue values >* menu for the configuration.

- Select *< Configuration → I/O periphery → Analogue values >*.
- Select display (display 1–6)
- Edit sensor designation and unit of measure
- Assigning the analog input
- Selecting the type of signal (4–20 mA / 0–20 mA)
- Assign a value range to the measurement signal (calibration)

Example:

The configuration is explained with the following example:
The signal value from a flow measuring device is to be displayed in the measured *<data menu>*.

- Sensor designation: Volume flow 01.
- The sensor is connected to analog input All 1.03.

- The sensor has a measuring range of 0 – 50 m³/h.
- The sensor is operated with 4–20 mA.

7.11.2.1 Select the Analog data menu

Precondition Password level 2 is activated,
The electrical connection is made.

1. Select menu < Configuration → I/O periphery → Analogue values > (see chapter 7.11).

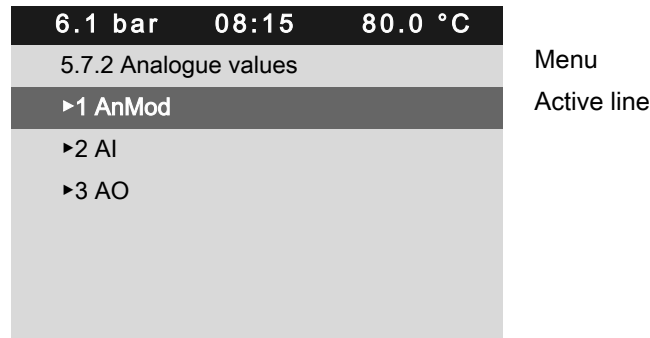

2. Press «DOWN» once.
The menu for analog measuring devices is displayed as being active.

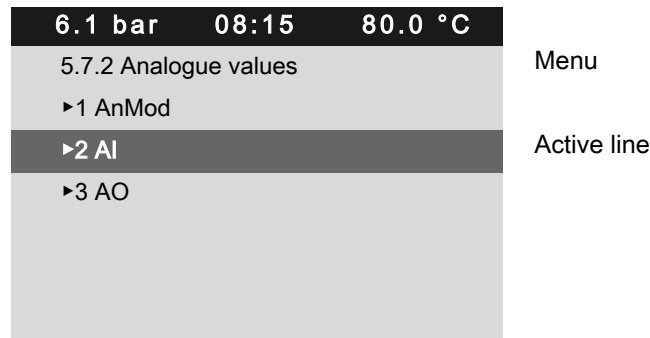

3. Press «Enter».
The menu for pressure transducers, temperature sensors, and freely selectable sensor types is displayed.
4. Press «DOWN» four times.

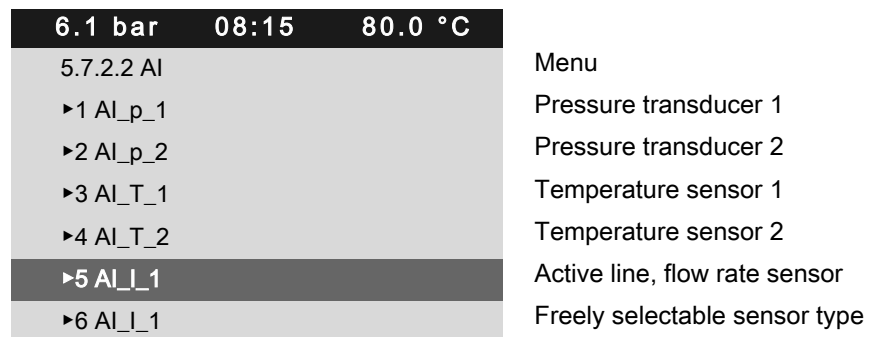

5. Press «Enter».

Result The < AI_I_1 > menu is displayed.

7.11.2.2 Edit sensor designation and unit of measure

The display shows the line for the sensor designation as active line.

1. Press «Enter» to switch into setting mode.
2. Use the «UP» and «DOWN» keys to select characters from the character set in order to assign a name to the sensor signal. There are 20 characters to choose from.

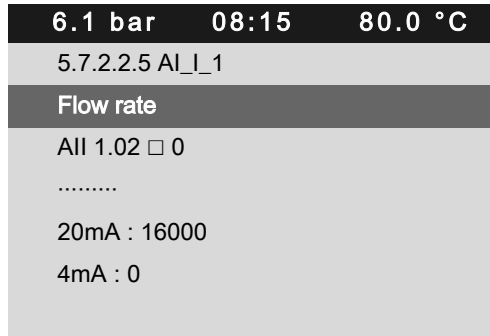

Menu
The line for sensor designation

3. Press «Enter» to accept the setting.
4. Press «DOWN» once.
5. Press the «Right» key twice.
6. Press «Enter» to switch into setting mode.
The Unit display of the sensor flashes.
7. Use the «UP» and «DOWN» keys to select characters from the character set in order to assign the unit to the sensor signal.

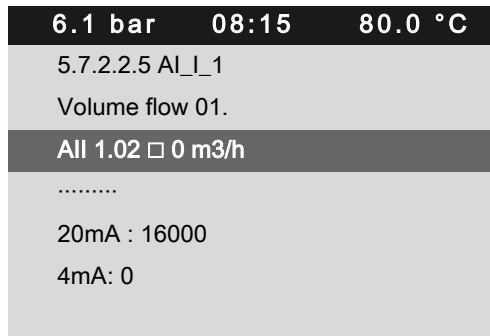

Menu
The line for sensor designation
Unit of measure

8. Press «Enter» to accept the setting.

Result Editing sensor designation and unit of measure.

7.11.2.3 Assigning the analog input

1. Press «left» twice, until *All 1.02* is displayed.
2. Press «Enter» to switch into setting mode.
The display of the analog input flashes.
3. Use «UP» to select *All 1.03*.

- Press «Enter» to accept the setting.

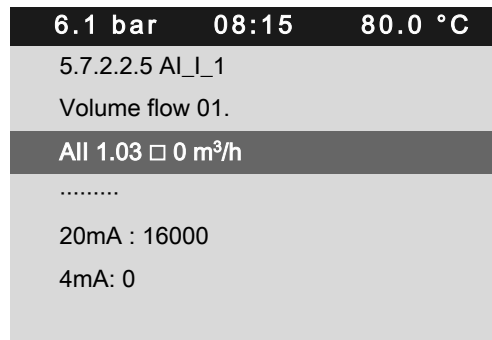

Menu
The line for sensor designation
Active line

- Press the «Right» key once.
- Press «Enter» to switch into setting mode.
The check box of the analog input flashes.
- Activate the check box for All 1.03.

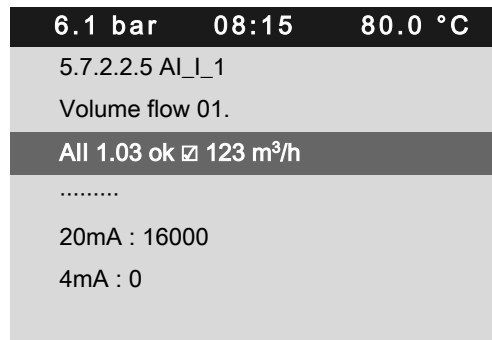

Menu
The line for sensor designation
Active line; the measured value is displayed

- Press «Enter» to accept the setting.
ok is displayed.
The measured value is displayed in the active line.

7.11.2.4 Determine the type of current signal (0/4–20 mA)

- Press «DOWN» three times.
- Press «Right» once to set the type of current signal.
As 4 -20 mA is preset, no further setting is needed.

7.11.2.5 Assign a value range to the measurement signal (calibration)

The factory setting is a range from 0-16,000 that represents a signal current between 4–20 mA. This value range has to be adapted to represent the measurement range of the sensor of 0 – 50 m³/h.

- Press «DOWN» once until *20 mA* is displayed as active line.

2. Press «Enter» to switch into setting mode.
Quality range flashes.

6.1 bar 08:15 80.0 °C	
5.7.2.2.5 AI_I_1	Menu
Volume flow 01.	The line for sensor designation
All 1.03 ok <input checked="" type="checkbox"/> 123 m³/h	Measured value prior to calibration
.....	
20mA : 16000 4mA: 0	Signal top range/signal bottom range

3. Press and hold the «DOWN» key and to set the top of the range to 50.
The quantity reduces initially in steps of units, then tens, hundreds and finally in thousands.
4. Using this method, reduce the value to 100 and then set to 50 with the «DOWN» key.
5. Press the «Enter» key to accept the value.

6.1 bar 08:15 80.0 °C	
5.7.2.2.5 AI_I_1	Menu
Volume flow 01.	The line for sensor designation
All 1.03 ok <input checked="" type="checkbox"/> -12 m³/h	Measured value after calibration
.....	
20mA : 50 4mA: 0	Signal top range/signal bottom range

6. Set the value for the bottom range (4 mA) to zero accordingly.
The measured value adjusts to the calibration.

Result The signal value from the sensor can now be displayed in the *< Performance data >* menu (see chapter 8.7).

7.11.3 Displaying additional binary input signals

As well as the defined fault and warning messages there are six additional, freely selectable input signals that can be used to display messages. A list of the defined fault and warning messages is provided in chapters 9.2 and 9.5. Information on spare inputs is given in the machine circuit diagram.

An input signal can be classified as either a fault, a service or an operational message. To suppress any possible contact bounce or similar problems, the input signal can be delayed by an adjustable period. This ensures that the signal must be apparent for a minimum period before it can be processed as a message.



If an input signal is classified as fault, the controller goes into the alarm state and shuts down the machine.

Overview

Navigate to the *< Configuration → I/O periphery → External messages >* menu for the configuration.

- Enter the message text

- Assign and activate the input
- Set the time delay
- Setting the logic
- Assign and activate the output
- Select the message type (operational, fault, warning)
- Activate the message.

7.11.3.1 Selecting the < External messages > menu

Precondition Access level 2 is activated,
The electrical connections are made.

1. In operating mode, switch to the main menu with the «Enter» key.
2. Select < Configuration → I/O periphery → External messages > (see Section 7.11.1.1)
The *External messages* menu is displayed.

6.1 bar 08:15 80.0 °C	
5.7.3 External messages	Menu
▶1 External message 1	Active line with external message No. 1
▶2 External message 2	
▶3 External message 3	
▶4 External message 4	
▶5 External message 5	
▶6 External message 6	

7.11.3.2 Enter the message text

External message 1 is shown as example.

1. Press «Enter».
External message 1 is displayed as active line.
2. Press «Enter» to switch into setting mode.
The display of the character set flashes.
3. Enter the individual message text.
4. Press «Enter» to accept the setting.

6.1 bar 08:15 80.0 °C	
5.7.3.1 External message 1	Menu
External message 1	Message number
DI 1.11 <input type="checkbox"/>	No input assigned
td : 0 s Logic +	Logic
DOR 1.04 <input type="checkbox"/>	
Warning <input checked="" type="checkbox"/>	Message type (operational, alarm, warning)

7.11.3.3 Assign and activate the input

1. Press «DOWN» repeatedly until "Input" is displayed as active line.

2. Press «Enter» to switch into setting mode.
Input flashes.
3. Select the relevant input with the «UP» or «DOWN» keys.
4. Press «Enter» to accept the setting.

6.1 bar 08:15 80.0 °C	
5.7.3.1 External message 1	Menu
External message 1	Message name
DI 1.11 ok <input checked="" type="checkbox"/>	Input is selected and activated
td : 0 s Logic +	Logic
DOR 1.04 <input type="checkbox"/>	
Alarm <input checked="" type="checkbox"/>	Example: Fault message type

5. Press the «Right» key.
6. Press «Enter» to switch into setting mode.
The check box will flash.
7. Press «UP» to activate the check box.
8. Press «Enter» to accept the setting.
ok is displayed.
The input is assigned and activated.

7.11.3.4 Set the time delay



The delay can be set between 0.01 and 600 seconds. The delay is counted down from 600 with the «DOWN» key and counted upwards from zero in 0.01 second increments with the «UP» key.

1. Press «DOWN» once.
2. Press «Enter» to switch into the setting mode for the time delay.
The display for the delay time flashes.

6.1 bar 08:15 80.0 °C	
5.7.3.1 External message 1	Menu
External message 1	
DI 1.11 ok <input checked="" type="checkbox"/>	
td :1 s Logic +	Active line, set time delay
DOR 1.04 <input type="checkbox"/>	
Alarm <input checked="" type="checkbox"/>	

3. Select the required delay time with the «UP» key.
4. Press «Enter» to accept the setting.

Result The delay time is set.

7.11.3.5 Setting the logic

Possible logic settings

Message at	Symbol
24 V	+
0 V	-

Tab. 69 Logic

1. Press the «Right» key once.
2. Press «Enter» to switch into the logic setting mode.
The *Logic* display flashes.
3. Use «UP» to set the desired behaviour, see table 69.

6.1 bar	08:15	80.0 °C	
5.7.3.1 External message 1			Menu
External message 1			
DI 1.11 ok <input checked="" type="checkbox"/>			
td : 1 s Logic +			Active line, set logic
DOR 1.04 <input type="checkbox"/>			
Alarm <input checked="" type="checkbox"/>			Example: Fault message type

4. Press «Enter» to accept the setting.
For messages at 24 V, the logic is set with the + symbol.

7.11.3.6 Assign and activate the output

1. Press «DOWN» repeatedly until "Output" is displayed as active line.
2. Press «Enter» to switch into setting mode.
The Output display flashes.
3. Select the output with the «UP» or «DOWN» keys.
4. Press «Enter» to accept the setting.

6.1 bar	08:15	80.0 °C	
5.7.3.1 External message 1			Menu
External message 1			Message name
DI 1.11 ok <input checked="" type="checkbox"/>			
td : 1 s Logic +			Logic
DOR 1.04 ok <input checked="" type="checkbox"/>			Output is selected and activated
Alarm <input checked="" type="checkbox"/>			Example: Fault message type

5. Press the «Right» key.
6. Press «Enter» to switch into setting mode.
The check box will flash.
7. Press «UP» to activate the check box.

8. Press «Enter» to accept the setting.
ok is displayed.
 The output is assigned and activated.

7.11.3.7 Select the message type (operational, fault, warning)

1. Press «DOWN» once until message type is displayed as active line.
2. Press «Enter» to switch into setting mode.
 The display of *Message type* flashes.
3. Use «UP» to select the corresponding message type.

6.1 bar	08:15	80.0 °C	
5.7.3.1 External message 1			Menu
External message 1			Message name
DI 1.11 ok <input checked="" type="checkbox"/>			
td : 1 s Logic +			Logic
DOR 1.04 ok <input checked="" type="checkbox"/>			
Alarm <input checked="" type="checkbox"/>			Example: Fault message type

4. Press «Enter» to accept the setting.

Result The input signal is available as external message 1 and/or as output.

7.12 Activating remote acknowledgement

When warning or fault messages are routed to a remote control centre via an output it makes sense to have these messages acknowledged by the control centre.

Acknowledging the message without correcting the cause, however, can lead to machine damage. Safety-relevant messages such as "Emergency-Off" **cannot** be acknowledged with this function.

The following conditions must be fulfilled:

- The "Remote acknowledgement" function and the «Remote control» key are activated.
- A controller input has been assigned for the acknowledgement signal.

Overview

- Enter access level 2.
- Select the < Configuration → Acknowledgement > menu.
- Set the "Remote acknowledgement" function.
- Activate the «Remote control» key
- Assigning an input
- Press the «Remote control» key.



CAUTION

Machine damage can result from acknowledging a fault message without remedying its cause!

- Find the fault and then decide to acknowledge or not.

7.12.1 Selecting the < Configuration → Acknowledgement > menu

Precondition Access level 2 is activated.

1. In operating mode, switch to the main menu with the «Enter» key.
2. Select the < Configuration → Acknowledgement > menu.
Remote mode line is displayed as being active.

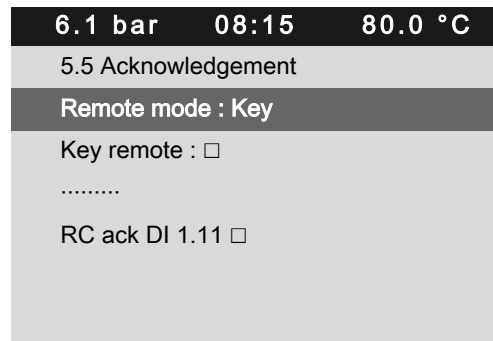

Menu
Active line with "Key" setting
The Remote control key is deactivated.

7.12.2 Setting the remote acknowledgement function

1. Press «Enter» to switch into setting mode.
Key flashes.
2. Press «UP».
The *Key+RC* menu is displayed.

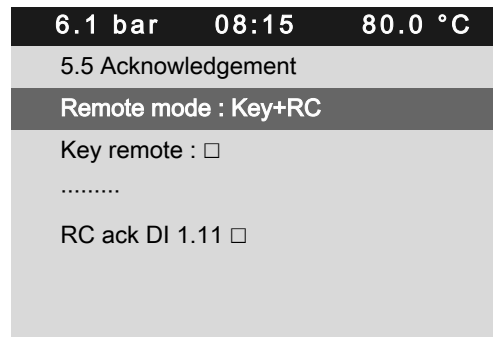

Menu
Active line with "Key + Remote contact" setting

3. Press «Enter» to accept the setting.

Result The Remote acknowledgement function is set.

7.12.3 Activate the «Remote control» key

1. Press «DOWN» once.
Key remote line is displayed as being active.
2. Press «Enter» to switch into setting mode.
The check box for *Key remote* will flash.

3. Press «UP».

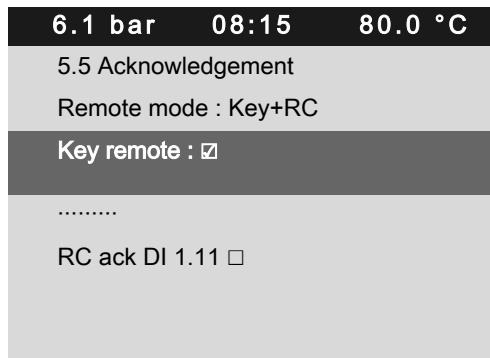

Menu

Active line with activated check box for the Remote control key

4. Press «Enter» to accept the setting.

Result The «Remote control» key is activated.

7.12.4 Assigning an input

1. Press «DOWN» repeatedly until the active line is displayed.

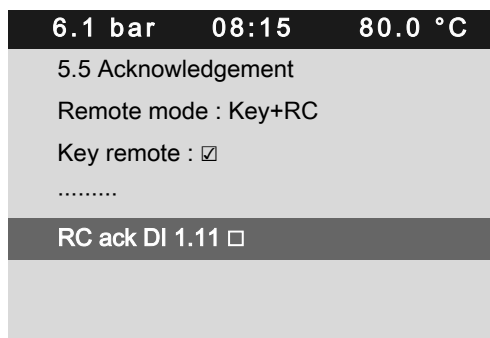

Menu

Active line

2. Press «Enter».
DI flashes.
3. Use «UP» to select the desired input.
4. Press «Enter» to accept the setting.
The input has now been assigned.
5. Press the «Right» key.
6. Press «Enter» to switch into setting mode.
The check box for input will flash.
7. Press «UP».

8. Press «Enter» to accept the setting.
ok is displayed,
the input is assigned and activated.

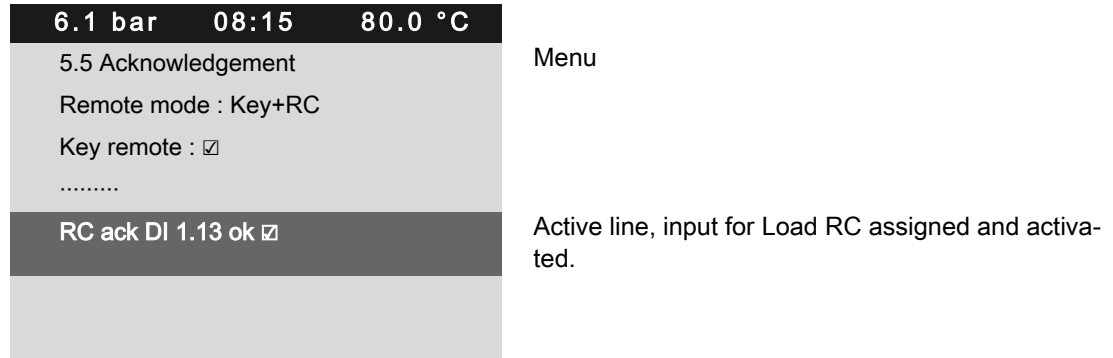

Result Should a warning message occur, it can now be acknowledged from a control centre.

7.13 Linking to an external pressure transducer

If the air system is operated with an air receiver, the pressure in the receiver can be regulated by an external pressure transducer.

Transmission of sensor value	Assignment to an input
Profibus connection (from a master controller)	Not necessary
External pressure transducer is connected to SIGMA CONTROL 2 . Characteristics, pressure transducer: <ul style="list-style-type: none"> ■ 4–20 mA ■ 0–16 bar 	Assign <i>A//</i>
USS protocol (External pressure transducer connected to the frequency converter)	Assign <i>FC USS</i>

Tab. 70 Transmission of sensor value

The controller processes the options in the following sequence:

- Profibus value
- Pressure according to the assigned external transducer
- The local system pressure transducer (pNloc) remains active.

Overview

Example: External pressure transducer is connected to SIGMA CONTROL 2 .

- Enter access level 2.
- Select the < *Configuration* → *Pressure control* > menu.
- Assigning an input

7.13.1 Selecting the < Configuration → Pressure control > menu

Precondition Access level 2 is activated.

1. In operating mode, switch to the main menu with the «Enter» key.
2. Select the < Configuration → Pressure control > menu.
< Pressure settings > sub-menu line is displayed as being active.

6.1 bar 08:15 80.0 °C	
5.2 Pressure control	Menu
▶1 Pressure sensors	
▶2 Pressure settings	Active line
▶3 Load control	
▶4 Network actual pressure	

3. Press «DOWN» twice.
< Network actual pressure > sub-menu is displayed as being active.
4. Press «Enter».
The < Network actual pressure > menu is displayed.

6.1 bar 08:15 80.0 °C	
5.2.4 Network actual pressure	Menu
pNloc 6.1 bar	Active line (local sensor)
All 1.01 □ 0.0 bar	

7.13.2 Assigning an input to an external sensor

1. Press «Enter» to switch into setting mode.
pNloc flashes.
2. Press the «UP» key once.
The All is displayed.

6.1 bar 08:15 80.0 °C	
5.2.4 Network actual pressure	
All 6.1 bar	Active line (external sensor)
All 1.01 □ 0.0 bar	

3. Press «Enter» to accept the setting.
Input *All* (analog value via frequency converter) is displayed.
4. Press «DOWN» once.
The line for activating the input is displayed.
5. Press the «Right» key.
6. Press «Enter» to switch into setting mode.
The *check box* flashes.

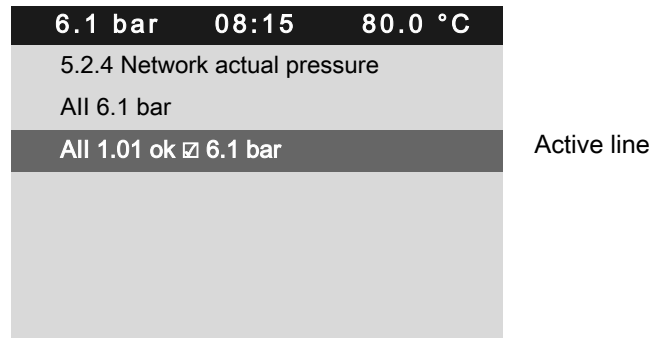

7. Press «UP».
8. Press «Enter» to accept the setting.

Result The input for the external transducer is now activated.



You have connected an external pressure transducer to a frequency converter (USS protocol).
➤ Assign the input *FC USS* to the pressure transducer.

7.14 Starting the machine

Checking the controller settings	Section	Complied?
➤ Language correctly set?	7.2.2	
➤ Date and time correct?	7.2.8	
➤ Display format correctly set?	7.2.9	
➤ System pressure setpoint correctly set?	7.4	

Tab. 71 Checklist of installation conditions

1. Check and confirm all the items in the checklist before starting the machine.

When power is applied to the machine the controller boots and carries out a self test. The display and the *Controller on* LED illuminate.

The actual system pressure (pNloc), the time and the airend discharge temperature are displayed in the first line of the display.

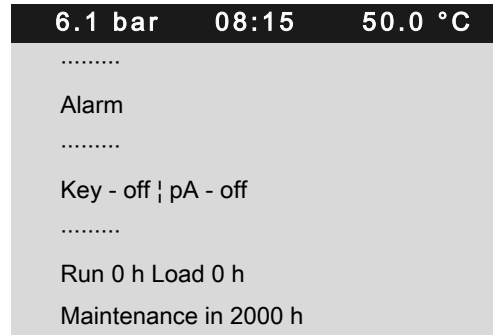

2. Continue the commissioning process as described in chapter "Commissioning" of the machine's operating manual.

8 Operation

8.1 Switching on and off

Always switch the machine on with the «ON» key and off with the «OFF» key.
A power supply disconnecting device has been installed by the user.

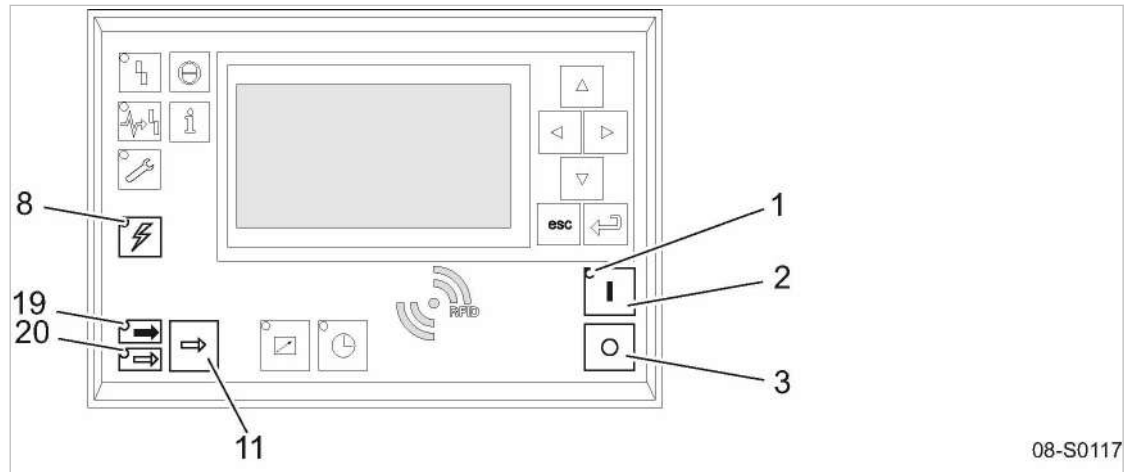

Fig. 36 Switching on and off

- | | | | |
|---|-----------------------------------|---|------------------------|
| ① | ON LED | ⑪ | «LOAD/IDLE» toggle key |
| ② | «ON» key | ⑲ | LOAD LED |
| ③ | «OFF» key | ⑳ | IDLE LED |
| ⑧ | Voltage applied to controller LED | | |

8.1.1 Switching on

Precondition No personnel are working on the machine.
All access doors and panels are closed and secure.

1. Switch on the power supply isolating device.
The *Voltage applied to controller* LED lights green.
2. Press the «ON» key.
The ON LED lights green.



If a power failure occurs, the machine is **not** prevented from re-starting automatically when power is resumed.
It can re-start automatically as soon as power is restored.

Result The compressor motor starts as soon as system pressure is lower than the set point pressure (cut-off pressure).

8.1.2 Switching off

1. Press the «OFF» key.
The machine switches to IDLE and the IDLE LED flashes. The SIGMA CONTROL 2 displays *Stopping*. The ON LED extinguishes as soon as the automatic shut-off action is completed.
2. Switch off and lock out the power supply disconnecting device.

Result The *Voltage applied to controller* LED extinguishes. The machine is switched off and disconnected from the mains supply.



In rare cases, you may want to shut down the machine immediately and cannot wait until the automatic shut-down process is finished.

- Press «OFF» once again.

8.2 Switching off in an emergency and switching on again

The EMERGENCY STOP push-button is located below the control panel.

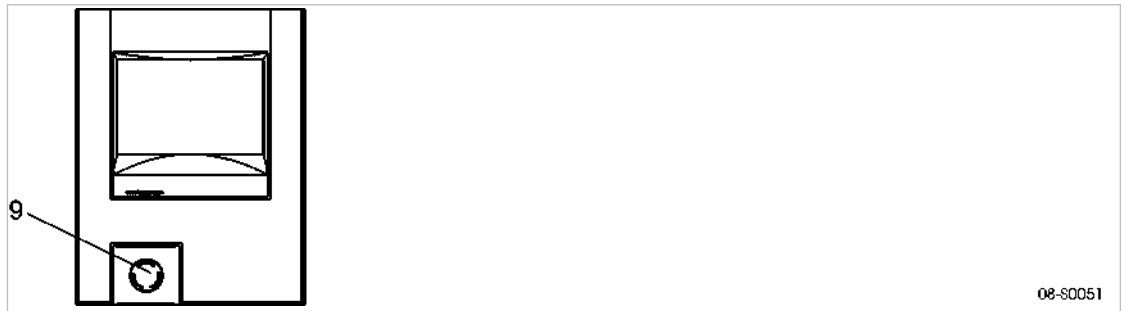

Fig. 37 Switching off in an emergency

⑨ EMERGENCY STOP control device:

Switching off

- Press the EMERGENCY STOP control device.

Result The EMERGENCY STOP button remains latched after actuation. The compressor's pressure system is vented and the machine is prevented from automatically re-starting.

Switching on

Precondition The fault has been rectified

1. Turn the EMERGENCY STOP device in the direction of the arrow to unlatch it.
2. Acknowledge any existing alarm messages.

Result The machine can now be started again.

8.3 Acknowledging fault and warning messages

Messages are displayed on the "new value" principle:

- Message coming: LED flashes
- Message acknowledged: LED illuminates
- Message going: LED off

or

- Message coming: LED flashes

- Message going: LED flashes
- Message acknowledged: LED off

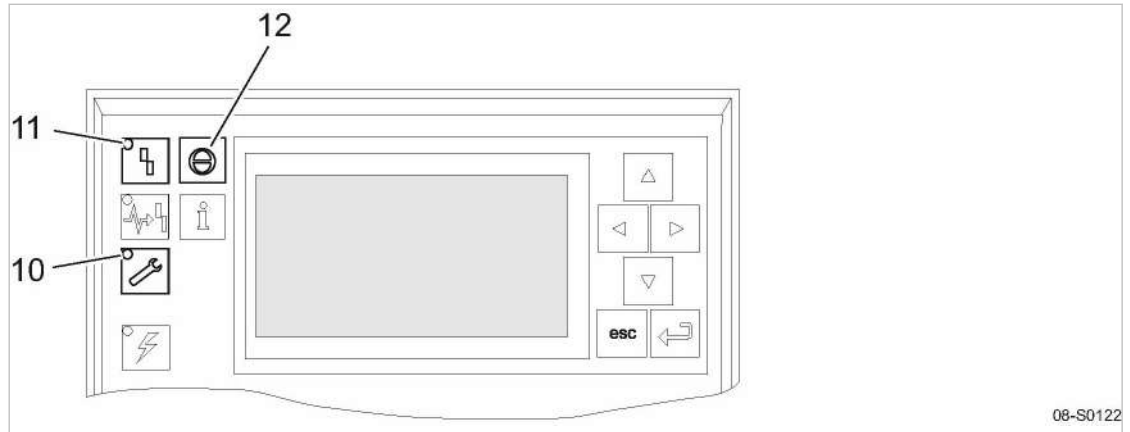

Fig. 38 Acknowledging messages

- ⑩ *Warning* LED (yellow)
- ⑪ *Fault* LED (red)
- ⑫ «Acknowledge» key

Fault message

An alarm shuts the machine down automatically. The *Fault* LED flashes red. The system displays the appropriate message.

Precondition The fault has been rectified

- Acknowledge the message with the «acknowledge» key. The *Fault* LED extinguishes. The machine is again ready for operation.



If the machine was switched off with the EMERGENCY STOP button:

- Unlatch the EMERGENCY STOP button (turn in direction of the arrow) before acknowledging the fault message.

Further information Please refer to the 9.2 operating manual for a list of possible fault messages during operation.

Warning message

If maintenance work is to be carried out or if the warning is displayed before an alarm, the *Warning* LED flashes yellow. The system displays the appropriate message.

Precondition The danger of a fault has been eliminated, maintenance has been carried out.

- Acknowledge the message with the «acknowledge» key. The *Warning* LED extinguishes.

Further information Please refer to the 9.5 operating manual for a list of possible warning messages during operation.

8.4 Displaying messages

The following information can be called up in the *< Status → Messages >* menu:

- Current messages
 - Last fault
 - Last warning
 - Number of currently registered fault and/or warnings
- The event memory stores the last 1000 events, these include fault and warning messages.
 - Compressor messages
 - Diagnostic messages
 - System messages

The information (message) is shown in three lines of the display.

Line	Submenu/Segment/Text
1	Selected submenu: <ul style="list-style-type: none"> ■ Compressor messages ■ Diagnostic messages ■ System messages
2	Segment: <ul style="list-style-type: none"> ■ Message number ■ Type of message ■ Message status ■ Message date ■ Message time
3	Text: <ul style="list-style-type: none"> ■ message text ■ –

Tab. 72 Information of a message

Message type and status are shown abbreviated.

Segment	Display	Meaning
Message number	0059 (example)	Message 0059
Type of message	<i>W</i>	Warning/service message
	<i>S</i>	Fault message
Message status	<i>c</i>	Message has come
	<i>g</i>	Message gone
	<i>a</i>	Message acknowledged (reset)
Date	21.01.11 (example)	Date
Time	16:10:31 (example)	Time

Tab. 73 Message abbreviations

8.4.1 Select Status menu

1. In operating mode, switch to the main menu with the «Enter» key.
2. Select the < *Status* → *Messages* > menu.

The *Messages* menu is displayed.

The number of current Alarms and Warnings is displayed in the two bottom lines.

6.1 bar 08:15 80.0 °C	
1.1 Messages	Menu
▶1 Current messages	Active line
▶2 Message history	
Status report 01:00 <input type="checkbox"/>	

current Alarms 2	Number of currently registered faults
Warnings2	Number of currently registered warnings

Displaying the last fault/warning

1. In operating mode, switch to the main menu with the «Enter» key.
2. Select the < *Status* → *Messages* → *Current messages* > menu.

The third line displays the last fault or warning message.

6.1 bar 08:15 80.0 °C	
1.1.1 Current messages	Menu
0021 S q 16.04.13 13:32:49	Active line
Refrigeration dryer T ‡	
0015 W q 21.01.11 13:06:43	
Bus alarm	
0911 D q 21.01.11 13:07:47	
AIR1.3 — Sensor fault	

3. Press «Escape» repeatedly to return to the main menu.

Displaying the event history

1. In operating mode, switch to the main menu with the «Enter» key.
2. Select the < *Status* → *Messages* → *Message history* > menu.

The *Message history* menu is displayed.

The messages in the three submenus are displayed in the order of their occurrence.

6.1 bar 08:15 80.0 °C	
1.1.2 Message history	Menu
▶1 Compressor messages	Active line with Compressor messages submenu
▶2 Diagnostic messages	Diagnostic messages
▶3 System messages	System messages

3. Press «Enter».

The Compressor messages menu is displayed.

6.1 bar	08:15	80.0 °C	
1.1.2.1 Compressor messages			Menu
0021 S q 16.04.13 13:32:49			Last compressor message
Refrigeration dryer T ‡			Message text for fault message 0021
0008 S k 20.01.11 13:33:25			
Diagnostics group alarm			Message text for message 0008
0042 S q 19.01.11 13:11:19			
Back pressure stop			Message text for message 0042

4. Press «Escape» repeatedly to return to the main menu.

8.5 Displaying the current operating mode

The operating mode is displayed in 4 segments (example):

On/off switching via	Machine state	LOAD control via	State of the LOAD control
Key	on	pA	Idle

Tab. 74 Operating mode display

1. In operating mode, switch to the main menu with the «Enter» key.
2. Select < Status >.
The < Status > menu is displayed.
3. Press the «DOWN» key repeatedly until < Current operating mode > is displayed as active line.

6.1 bar	08:15	80.0 °C	
1 Status			Menu
▶1 Messages			
▶2 Statistics			
▶3 Current pressure control			
▶4 Current operating mode			Active line
▶5 DI/DO status			

4. Press «Enter».

The < *Current operating mode* > submenu is displayed.

6.1 bar 08:15 80.0 °C	
1.4 Current operating mode	Menu
Compressor on Key	Active line
Load control pA	
Control mode DUAL	
Idle period Remains 140 s	

Abbreviation of operating modes

Segment	Display	Meaning
On/off switching via	Key	«ON» key on the control panel
	Clk	Internal clock
	RC	Remote contact (external LOAD signal)
	RB	Remote bus (external bus signal)
	cRC	Clock or remote contact (external LOAD signal)
	Holidays	Holidays (see chapter 7.5.2)
Machine state	on	Switched on
	off	Switched off
	AL	Alarm There is a fault registered
LOAD control via	pA	System setpoint pressure pA
	pB	System setpoint pressure pB
	pE	Raised system pressure pE (at a dubious LOAD signal)
	Load RC	Remote contact (external LOAD signal)
	Load RB	Remote bus (external bus signal)
State of the LOAD control	Idle	IDLE
	Load	LOAD
	ready	Compressor motor off and machine ready Compressor motor starts at compressed air demand
	off	Compressor motor is off

Tab. 75 Displaying possible operating modes

8.6 Adjusting working pressure

➤ Adjust the pressure parameter to suit the compressor and application.

Further information A detailed explanation of all pressure parameter settings is given in chapter 7.4.

8.7 Displaying analog data

The following information can be called up in the *< Performance data >* menu option:

- Local system pressure
- Aired discharge temperature
Rise rate, aired discharge temperature
- Differential pressure, oil separator cartridge
- Start temperature, compressor motor
- Temperature MCS (SIGMA CONTROL 2)
- Temperature, first IOM

The data for the actual pressure can be displayed in *< Configuration → Pressure control → Network actual pressure >*.

Displaying analog data

Precondition Password level 2 is activated.

The display shows the operating mode.

1. In operating mode, switch to the main menu with the «Enter» key.
2. Select the *< Performance data >* menu.

An overview of the analog data is displayed.

6.1 bar	08:15	80.0 °C
2 Performance data		
System pressure pNloc 6.10 bar		
.....		
ADT T 80.0 °C		
dT/dt 0.0 °C /s		
Oil separator Δp 0.0 bar		
.....		

- Menu
- Local System pressure pNloc
- Aired discharge temperature
- Rise of aired discharge temperature
- Differential pressure, oil separator cartridge

3. Press «DOWN» to display additional analog data.

6.1 bar	08:15	80.0 °C
2 Performance data		
.....		
Starting temperature 0.0 °C		
.....		
.....		
MCS T 36.4 °C		
First IOM T 0.0 °C		

- Menu
- Temperature of compressor motor
- Temperature of the controller (Main Control System)
- Temperature, first I/O module

4. Press «Escape» repeatedly to return to the main menu.

8.8 Displaying operating data

The following information can be called up in the *<Operating data>* menu option:

- *<Operating hours>*
 - Compressor: Total machine running time
 - Load run: Machine running time in LOAD mode
 - Compressor motor: Running time of compressor motor (adjustable)
 - Airend: Running time of airend (adjustable)
 - SIGMA CONTROL 2 : Controller running time

Displaying operating data

Precondition Access level 2 is activated.

1. In operating mode, switch to the main menu with the «Enter» key.
2. Select *< Operating data >*.

The *Operating data* menu is displayed.

6.1 bar 08:15 80.0 °C	
3 Operating data	Menu
▶1 Operating hours	Active line
▶2 kWh counter	
.....	
Load valve on 383	Total number of switching actions

Changing the operating hours

The running times of the compressor motor and the airend can be adjusted. This may be required after a replacement, for example.

Precondition Access level 2 is activated.

1. Select the *< Operating data → Operating hours >* menu.

The *Operating hours* menu is displayed.

6.1 bar 08:15 80.0 °C	
3.1 Operating hours	Menu
Compressor 3050 h	Active line
On load 3030 h	
Motor 3050 h	
Compressor block 3050 h	
SIGMA CONTROL 2 3050 h	

2. Press «DOWN» repeatedly until *Compressor block* is displayed as active line.

- Press «Enter» to switch into setting mode.
The display of the running time flashes (e.g., 3050h).

6.1 bar	08:15	80.0 °C	
3.1 Operating hours			Menu
Compressor 3050 h			
On load 3030 h			
Motor 3050 h			
Compressor block 0 h			Active line
SIGMA CONTROL 2 3050 h			

- Use «DOWN» or «Up» to set the value for operating hours to zero.
- Press «Enter» to accept the setting.
- Press «Escape» repeatedly to return to the main menu.

Result The operating hours for the new airend are set to 0 h.

8.8.1 Interpreting operation messages

The controller will automatically display operation messages informing you about the current operational state of the machine.

Operating messages are identified with the letter O.

The message numbers are not numbered consecutively.

Messages 0081 to 0095 are customer-specific and undefined. Complete them with your defined message text and interpretation.

Message	Meaning
0001 O Load control pA	The machine is regulated by system set point pressure pA.
0002 O Load control pB	The machine is regulated by system set point pressure pB.
0003 O Load control RC	The machine is regulated via the remote contact.
0004 O Load control RB	The machine is remotely regulated via the bus connection.
0005 O ready	The machine is switched on and in READY operating mode.
0006 O Idle	The machine is switched on and in IDLE operating mode.
0007 O On load	The machine is switched on and in LOAD operating mode.
0008 O off	The machine is switched off. The power supply is connected.
0009 O Compressor on	The machine is switched on.

Message	Meaning
0010 O Controller on	The power supply is connected. The controller is powered.
0011 O Cold start release	The machine can be switched on although the machine temperature is below the permissible starting temperature. The machine can be switched on only as long as the message is displayed.
0025 O Setpoint pressure pA	The value for pA is output.
0026 O Setpoint pressure pB	The value for pB is output.
0027 O Power OFF → ON	Request: Switch the power supply off and on.
0028 O DYNAMIC motor temperature ↑	Control mode DYNAMIC: The temperature of the compressor motor is too high.
0081 O	
0082 O	
0083 O	
0084 O	
0085 O	
0086 O	
0087 O	
0088 O	
0089 O	
0090 O	
0091 O	
0092 O	
0093 O p-Switch pi	

Message	Meaning
0094 O T-Switch ADT	
0095 O p-Switch pN	
0200 O IOSlot1 Undervoltage error 50	The internal voltage monitoring reports undervoltage fault IO-Slot1
0201 O IOSlot2 Undervoltage error 50	The internal voltage monitoring reports undervoltage fault IO-Slot2
0202 O IOSlot3 Undervoltage error 50	The internal voltage monitoring reports undervoltage fault IO-Slot3
0203 O IOSlot4 Undervoltage error 50	The internal voltage monitoring reports undervoltage fault IO-Slot4
0204 O IOSlot5 Undervoltage error 50	The internal voltage monitoring reports undervoltage fault IO-Slot5
0205 O IOSlot6 Undervoltage error 50	The internal voltage monitoring reports undervoltage fault IO-Slot6

Tab. 76 Operational Messages

8.9 Setting the maintenance interval

Example: Changing the oil change service interval.

Precondition Password level 2 is activated.
The display shows the operating mode.

Select menu Maintenance >

1. Press «Enter».
The main menu is displayed.
2. Select < Maintenance >.
The maintenance interval oil filter is displayed as active line.

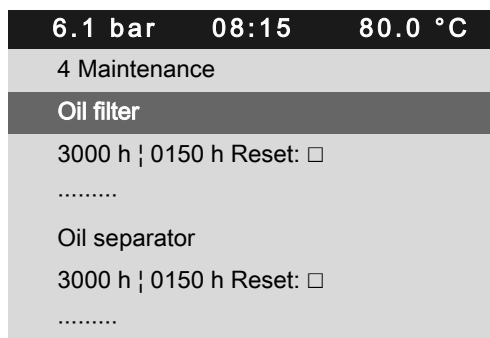

active line, Description maintenance interval
Preset interval 3000 h

3. Press the «DOWN» key repeatedly until the maintenance interval for oil change is displayed as active line.

6.1 bar	08:15	80.0 °C
4 Maintenance		
Oil separator		
3000 h 0150 h Reset: <input type="checkbox"/>		
.....		
Oil change		
3000 h 0150 h Reset: <input type="checkbox"/>		
.....		

Maintenance interval description
active line, preset interval

4. Press «Enter» to switch into setting mode.
Maintenance interval display flashes.
5. Use the «UP» key to set the new value for the maintenance interval.



Simply keep the «UP» key pressed to quickly change the maintenance interval in increments of 10, 100 or 1000.

6. Press «Escape» repeatedly to return to the main menu.

8.10 Pressure relief valve checking

Overview

- Preparing the test
- Performing the test
- Correct conclusion of the test
- Resetting



When the check mode is activated, monitoring of internal pressure (blow-off protection - if provided) and regulation of network pressure are deactivated.

The measured value of the internal pressure p_i is used to describe the test below.

Check box	Status
<input checked="" type="checkbox"/>	activated
<input type="checkbox"/>	deactivated

Tab. 77 Check box status



WARNING

Danger of injury from pressurised components!

- Perform the following actions in the sequence provided.

Preparing the test

1. Note the activating pressure of the pressure relief valve from the machine's nameplate.
2. Press the «OFF» key to shut down the machine.
3. Close the user's shut-off valve between the machine and the air distribution network.
4. Log on to SIGMA CONTROL 2 with access level 2 (see chapter 7.2.6).

5. In operating mode, switch to the main menu with the «Enter» key.
6. Select the < *Machine test* → *TÜV inspection* > menu.

Pressure relief valve is displayed as an active line.

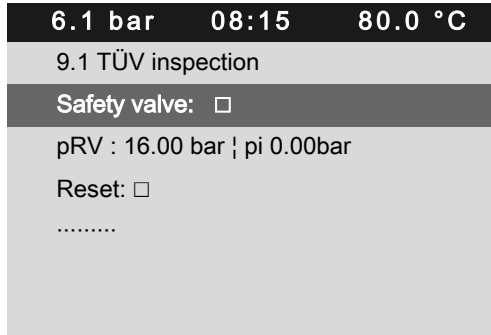

Menu

Active line with check box

Relief valve activating pressure (example)

Performing the test

1. Press «Enter» to switch into setting mode.
The check box flashes in the active line.
2. Use the «UP» key to activate the check box.
3. Press «Enter» to accept the setting.
The test mode is now activated.
The monitoring of internal and network set point pressures is deactivated!

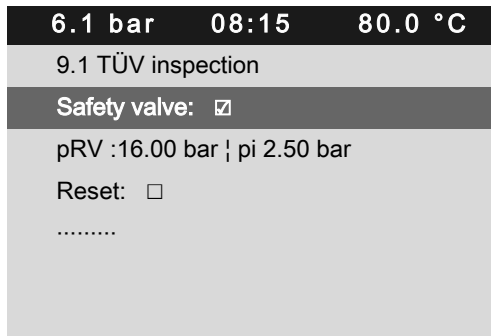

Menu

Active line with check box

Relief valve activating pressure



4. **WARNING!**
Excessive noise is caused when the pressure relief valve blows off!
 - > Close all access doors; replace and secure all removable panels.
 - > Wear hearing protection.



5. **WARNING!**
Risk of burns due to released cooling oil and compressed air when blowing off the pressure relief valve!
 - > Close all access doors; replace and secure all removable panels.
 - > Wear eye protection.

6. Press and hold the «ON» key.
The machine switches to load, the machine's internal pressure pi rises.
7. Monitor on the display the pressure rise pi during the TÜV check.
8. If the internal pressure pi increases to more than 10 % above the correct opening pressure of the pressure relief valve, shut down the machine with the «OFF» key and replace the pressure relief valve.



If the alarm message $pRV \neq$ appears, the pressure relief valve is defective. The permissible internal pressure was exceeded by 2 bar.

- Have the pressure relief valve replaced.



Avoid oil mist:

- Release the «ON» key immediately when the pressure relief valve responds, in order to prevent unnecessary oil mist.

Correct conclusion of the test

1. Press «Enter» to switch into setting mode.
The check box flashes in the active line.
2. Use the «DOWN» key to deactivate the check box.
3. Press «Enter» to accept the setting.
The test mode is de-activated and the test is completed.
4. Press «Escape» repeatedly to return to the main menu.
5. Open the shut-off valve from the machine.

Result The machine is ready for operation.

Resetting

If the test is canceled when opening the pressure relief valve, SIGMA CONTROL 2 will indicate the highest measured value as internal pressure.

Activate the check box for reset in order to reset the stored value.

- Activate the check box.

8.11 Checking the temperature sensor and overheating shutdown function

The machine should shut down if the airend discharge temperature (VET) reaches a maximum of 110 °C.

SIGMA CONTROL 2 will simulate a higher temperature for checking this function.

For this purpose, SIGMA CONTROL 2 automatically determines an offset value to be displayed. During the test mode, this is added to the actual airend discharge temperature to cause the machine to shut down prematurely.

In standard operation, SIGMA CONTROL 2 generates the "overtemperature" fault message when the maximum airend discharge temperature is reached. Since the modified test temperature is 2 K below the fault message switching point for overtemperature, the system will not generate a fault message in test mode.

Overview

- Shut down the machine and allow to cool down slightly
- Performing the test
- Correct conclusion of the test
- Resetting

Performing the test

Precondition Machine cooled down by approx. 5 °C

1. Log on to SIGMA CONTROL 2 with access level 2. (see section 7.2.6).
2. In operating mode, switch to the main menu with the «Enter» key.
3. Select the *< Machine test → TÜV inspection >* menu.
Safety valve is displayed in the active line.
4. Press «DOWN» repeatedly until *Airend discharge temperature ADT ‡* is displayed as active line.
5. Press «Enter» to switch into setting mode.
The check box in the active line flashes.

6.1 bar	08:15	73.0 °C	Fallen airend discharge temperature (73.0 °C)
9.1 TÜV inspection			Menu
.....			
Airend discharge temperature ADT ‡ : <input type="checkbox"/>			Active line
Offset : 0 °C ADT ‡ 0.0 °C			
Reset: <input type="checkbox"/>			

6. Use the «UP» key to activate the check box.
7. Press «Enter» to accept the setting.
The *Offset* display changes to *35 °C*.
The *Airend discharge temperature ADT ‡* display changes to *108 °C*.
The test mode is now activated.

6.1 bar	08:15	73.0 °C	Menu
9.1 TÜV inspection			
.....			
Airend discharge temperature ADT ‡ : <input checked="" type="checkbox"/>			Active line
Offset : 35 °C ADT ‡ 108 °C			Offset, airend discharge temperatur in test mode
Reset: <input type="checkbox"/>			

8. Press the «ON» key to switch the machine to LOAD.
The machine switches to LOAD and the airend discharge temperature rises again.
The machine will switch off as soon as the airend discharge temperature attains a value of *108 °C*.



The machine does not shut down?
➤ Abort the test and contact HPC Service as soon as possible.

Correct conclusion of the test

1. Press «Enter» to switch into setting mode.
The check box in the active line flashes.
2. Use the «DOWN» key to deactivate the check box.

3. Press «Enter» to accept the setting.
The offset is reset to 0 °C.
The test mode is de-activated and the test is completed.
4. Press «Escape» repeatedly to return to the main menu.

Resetting

SIGMA CONTROL 2 will display the highest measured value if the test for switching off at overtemperature is aborted.

Activate the check box for reset in order to reset the stored value.

- Activate the check box.

9 Fault Recognition and Rectification

9.1 Basic instructions

The following tables are intended to assist in locating faults.

SIGMA CONTROL 2 will indicate three types of faults:

- Fault on the machine:
The *red LED* flashes, the machine is shut down, see chapters 9.2 and 9.4.
- Fault on the controller:
The machine is shut down, see chapter 9.3.
- Warning:
The *yellow LED* illuminates, the machine is **not** shut down, see chapter 9.5.

The messages valid for your machine are dependent on the controller and individual equipment.

1. Do not attempt fault rectification measures other than those given in this manual!
2. In all other cases:
Have the fault rectified by an authorised HPC Service representative.

9.2 Interpreting fault messages



If an input signal is classified as a fault, the controller will display the fault upon the signal's arrival.

Consequences

- The *red LED* flashes:
- The controller switches the machine off.

Fault messages are identified with the letter A.

The message numbers are not numbered consecutively.

Messages 0081 to 0095 are customer-specific and may differ from the suggested values. Complete them with your defined message text, possible causes and remedies.

Message	Possible cause	Remedy
0001 A Direction of rotation	The compressor drive motor is turning in the wrong direction.	Change over phase lines L1 and L2.
0002 A Motor temperature †	Compressor drive motor overheated.	Clean the motor. Keep ambient conditions within specified limits.
0003 A pRV †	The activating pressure of the pressure relief valve on the oil separator tank has been exceeded.	Change the pressure relief valve.
0004 A EMERGENCY STOP	EMERGENCY STOP control device actuated.	Unlatch the push-button.

Message	Possible cause	Remedy
0005 A Oil separator Temperature ‡	Maximum air temperature at the oil separator tank outlet is exceeded.	Check the line to the trip relay.
0007 A Power supply monitor	Fault in mains power supply.	Have the mains power supply checked.
0008 A Diagnostics group alarm	A diagnostic message has occurred.	For more details, see the text of the diagnostic message.
0009 A SIGMA CONTROL 2 T ‡	Permissible enclosure temperature for SIGMA CONTROL 2 exceeded.	Keep ambient conditions within specified limits. Control cabinet: Check filter mats and fan.
0010 A Blow-off protection ‡	The activating pressure of the pressure relief valve on the oil separator tank has been exceeded.	Change the oil separator cartridge. Open the shut-off valve in the venting line.
0011 A Oil-/air cooler fan Overcurrent	Overload shut-down of the first fan motor.	Investigate cause of shut-down. Reset the overload relay.
0012 A Access doors	Door open / interlocked panel removed while the machine is running.	Fit and secure all panels and close access doors.
0013 A Compressor motor overcurrent	Overload shut-down of the compressor drive motor.	Investigate cause of shut-down. Change the oil separator cartridge.
0014 A Oil-/air cooler fan Overcurrent	Overload shut-down of the second fan motor.	Investigate cause of shut-down. Reset the overload relay.
0015 A Airend discharge temperature ADT ‡	Maximum permissible airend discharge temperature (ADT) exceeded.	Keep ambient conditions within specified limits. Clean the cooler. Check the cooling oil level.

9 Fault Recognition and Rectification

9.2 Interpreting fault messages

Message	Possible cause	Remedy
0016 A Oil-/air cooler fan Overcurrent	Overload shut-down of the third fan motor.	Investigate cause of shut-down. Reset the over-load relay.
0019 A Internal pressure pi ‡	–	–
0021 A Refrigeration dryer T ‡	Refrigeration dryer: Compressed air temperature too low.	Contact HPC Service.
0022 A Oil separator Δp ‡	Oil separator cartridge clogged.	Change the oil separator cartridge.
0023 A Motor bearings	Drive motor bearings overheated.	Re-grease the motor bearings.
0024 A Water-cooling water shortage	Cooling water pressure is too low.	Check cooling water supply.
0034 A Mains contactor on?	Mains contactor does not close.	Check mains contactor and wiring.
0035 A Cabinet fan I ‡	Overload shut-down of the control cabinet fan motor.	Contact HPC Service.
0038 A PD temperature ‡	Package discharge (PD) temperature too low.	Contact HPC Service.
0039 A PD temperature ‡	Package discharge (PD) temperature too high.	Check the cooling oil level. Clean the cooler. Check the fan motor.
0040 A Mains contactor off?	Mains contactor does not open.	Check mains contactor and wiring.
0041 A Mains voltage ‡	Second power failure.	Check power supply voltage. Check the door interlock switch.
0042 A Back pressure stop	Back pressure in the oil separator tank caused by defective venting.	Check venting line.
0043 A Airend discharge temperature ADT rise dT/dt ‡	The rate of rise of the airend discharge temperature (ADT) is too fast.	Check the cooling oil level.
0044 A No pressure buildup	The machine does not produce compressed air. The working pressure does not rise above 3.5 bar within the preset period.	Check the machine for leaks. Check coupling and V-belt.
0045 A Compressor T ↓ ↓	Thermostatic valve defective	Contact HPC Service.

Message	Possible cause	Remedy
0048 A High-voltage cell	Fault in the high voltage cell.	Contact HPC Service.
0051 A Aggregate A	Aggregate A failed.	Contact HPC Service.
0052 A Aggregate B	Aggregate B failed.	Contact HPC Service.
0056 A RD condensate drain	Refrigeration dryer: The condensate drain is defective.	Refrigeration dryer: Check condensate drain and condensate conduits.
0057 A Model?	Compressor model uncertain.	Contact HPC Service.
0058 A Condensate drain	The condensate drain is defective.	Check condensate drain and condensate conduits.
0059 A Back pressure run	Drive belt or coupling broken.	Drive belt: Replace drive belt. Coupling: Contact HPC Service.
0061 A Oil separator rise dT/dt †	The rate of rise of the aird discharge temperature is too fast.	Check the cooling oil level.
0062 A Refrigeration dryer p ‡	Refrigeration dryer: Pressure too high in the refrigerant circuit. Safety pressure switch tripped.	Clean the refrigerant liquefier. Check the fan motor. Maintain operating conditions.
0063 A Refrigeration dryer p ‡	Refrigeration dryer: Refrigerant lost; pressure in the refrigerant circuit too low. Inlet pressure switched tripped.	Contact HPC Service.
0081 A		
0082 A		
0083 A		
0084 A		
0085 A		

Message	Possible cause	Remedy
0086 A		
0087 A		
0088 A		
0089 A		
0090 A		
0091 A		
0092 A		
0093 A p-Switch pi		
0094 A T-Switch ADT		
0095 A p-Switch pN		
0097 A High-voltage cell on?	High-voltage cell does not activate.	Check high-voltage cell and wiring.
0098 A High-voltage cell off?	High-voltage cell does not deactivate.	Check high-voltage cell and wiring.
0099 A Mains contactor on?	Mains contactor does not close.	Check mains contactor and wiring.
0100 A Mains contactor off?	Mains contactor does not open.	Check mains contactor and wiring.
0101 A Compressor motor overcurrent	Overload shut-down of the compressor drive motor.	Investigate cause of shut-down. Change the oil separator cartridge.
0102 A Oil-/air cooler fan Overcurrent	Overload shut-down of the first fan motor.	Investigate cause of shut-down. Reset the overload relay.
0200 A Compressor motor USS alarm	Frequency converter fault	Contact HPC Service.
0201 A Compressor motor USS alarm	Frequency converter fault	Contact HPC Service.
0202 A Compressor motor USS alarm	Frequency converter fault	Contact HPC Service.

Message	Possible cause	Remedy
0205 A Compressor motor USS alarm	Communications error	Check connection and line path.
0210 A Compressor motor FC Motor overload alarm	Frequency converter fault	Contact HPC Service.
0211 A Compressor motor FC Motor overload alarm	Frequency converter fault	Contact HPC Service.

Tab. 78 Fault messages and remedies

9.3 Interpreting system messages



A system message causes the machine to shut down.

System messages are identified with the letter Y.

The message numbers are not numbered consecutively.

Message	Possible cause	Remedy
0001 Y Hardware watchdog reset	System error	Contact HPC Service.
0002 Y Internal software error	System error	Contact HPC Service.
0003 Y Filesystem Read/Write failure	System error	Contact HPC Service.
0004 Y CPU load too high	System error	Contact HPC Service.
0005 Y RAM out of memory	System error	Contact HPC Service.
1000 Y RFID error: switch SIGMA CONTROL power supply OFF → ON!	System error	Contact HPC Service.

Tab. 79 System messages and remedies

9.4 Interpreting diagnostic messages



A diagnostic message causes the machine to shut down.

Diagnostic messages are identified with the letter D.

They provide information on the status of the controller, the connected input and output modules and support the HPC service in trouble-shooting.

9.5 Interpreting warning messages



If an input signal is classified as a warning, the controller will display the warning upon the signal's arrival.

Consequences

- The *yellow LED* flashes.
- The controller does **not** switch off the machine.

Warning messages are identified with the letter W.

The message numbers are not numbered consecutively.

Messages 0081 to 0092 are customer-specific and may differ from the suggested values. Complete them with your defined message text, possible causes and remedies.

Message	Possible cause	Remedy
0002 W Motor temperature ↑	Drive motor overheating.	Clean the motor. Keep ambient conditions within specified limits.
0004 W Oil separator Δp ↑	Increased differential pressure of the oil separator cartridge. Oil separator cartridge clogged.	Change the oil separator cartridge.
0007 W Motor bearings	Drive motor bearing defective.	Contact HPC Service.
0008 W Airend discharge temperature ADT ↑	Maximum airend discharge temperature will soon be reached.	Clean the cooler. Check the cooling oil level. Replace the oil filter cartridge. Ensure adequate ventilation. Keep surrounding temperature within recommended limits.
0011 W Oil filter Δp ↑	Increased pressure differential of the oil filter. Oil filter clogged.	Change the oil filter.
0013 W Air filter Δp ↑	Air filter clogged.	Change the air filter.
0015 W Bus alarm	The bus link via the Profibus DP interface is interrupted.	Check the bus cables and plugs.
0025 W Oil separator h ‡	Oil separator cartridge: Maintenance interval has elapsed.	Change the oil separator cartridge.
0026 W Oil change h ‡	Cooling oil: Maintenance interval has elapsed.	Change the cooling oil.

Message	Possible cause	Remedy
0027 W Oil filter h ‡	Oil filter: Maintenance interval has elapsed.	Change the oil filter.
0028 W Air filter h ‡	Air filter: Maintenance interval has elapsed.	Change the air filter.
0029 W Valve inspection h ‡	Valves: Maintenance interval has elapsed.	Contact HPC Service.
0030 W Belt/coupling inspection h ‡	Belt tension/coupling: Maintenance interval has elapsed.	Carry out a visual inspection. Re-tension the drive belt.
0031 W Motor bearings h ‡	Motor bearing of compressor motor: Maintenance interval has elapsed.	Contact HPC Service.
0032 W Electrical equipment h ‡	Electric components and installation: Maintenance interval has elapsed.	Inspect and reset the maintenance interval counter.
0033 W Fan bearings h ‡	Motor bearing of fan motors: Maintenance interval has elapsed.	Contact HPC Service.
0034 W PD temperature ↓	Package discharge (PD) temperature too low.	Contact HPC Service.
0035 W PD temperature ↑	Compressed air discharge temperature too high.	Clean the cooler. Check the cooling oil level.
0036 W Motor starts/h ‡	The permissible number of motor starts was exceeded in the last 60 minutes.	Extend the idle period. Increase the capacity of the air receiver. Increase the cross-section of piping between compressor and air receiver.
0037 W Motor starts/d ‡	The permissible number of motor starts was exceeded in the last 24 hours.	Extend the idle period. Increase the capacity of the air receiver. Increase the cross-section of piping between compressor and air receiver.
0038 W Blow-off protection ↑	The pressure relief valve's activating pressure will soon be reached.	Change the oil separator cartridge. Open the shut-off valve in the venting line.

Message	Possible cause	Remedy
0041 W Mains voltage ↓	1. Power failure: The machine is automatically re-started.	Check power supply. Check the door interlock switch.
0043 W External load signal?	Ambiguous external load signal: Increased cut-out pressure exceeded. The external load control has not switched to idle.	Check settings of the external controller. Take into account pressure drops across filters and dryer.
0044 W Oil temperature ↓	Cooling oil temperature too low.	Check temperature switch, line and connection. Check the oil circuit. Increase room temperature.
0046 W System pressure ↓	Network pressure has fallen below the set 'system pressure low' value. Air consumption too high.	Check air demand. Check cable runs and sensor connections. Check the 'system pressure low' warning value.
0047 W No pressure buildup	The compressor cannot build-up to working pressure.	Check for air leaks. Check the value for internal pressure given in the <Analog data> menu against the reading on the oil separator tank pressure gauge.
0048 W Bearing lube h †	Re-grease the motor bearings. Maintenance interval has elapsed.	Re-grease the motor bearings.
0049 W Annual maintenance	Last maintenance was 1 year ago.	Carry out the necessary maintenance and reset the corresponding maintenance interval counter.
0059 W Start temperature ↓ ↓	The airend temperature is too low (<-10 °C) for the machine to be operated.	Keep ambient conditions within specified limits.
0060 W Start temperature ↓	The airend temperature is too low (<+2 °C).	Keep ambient conditions within specified limits.
0061 W Compressor T ↓	The airend discharge temperature (ADT) did not reach the minimum value within the specified time.	Contact HPC Service.
0066 W Air filter Δp †	Initial warning: Air filter clogged.	Change the air filter element soon.
0068 W Condensate drain	The condensate drain is defective.	Check the condensate drain and drain line.

Message	Possible cause	Remedy
0069 W Error operation without RD → Call service!	Refrigeration dryer defective. Compressed air supply with un-dried air is activated.	Immediately contact HPC service.
0070 W Refrigeration dryer T ↑	Refrigeration dryer: Compressed air temperature too high.	Maintain operating conditions. Clean the refrigerant liquefier. Clean the cooler. Install an extractor fan.
0071 W Oil level ↓	Cooling oil level too low.	Replenish the cooling oil.
0072 W RD condensate drain	Refrigeration dryer: The condensate drain is defective.	Check condensate drainage
0081 W		
0082 W		
0083 W		
0084 W		
0085 W		
0086 W		
0087 W		
0088 W		
0089 W		
0090 W		
0091 W		
0092 W		
0093 W p-Switch pi		
0094 W T-Switch ADT		

Message	Possible cause	Remedy
0095 W p-Switch pN		

Tab. 80 Warning messages and remedies

10 Maintenance

10.1 Maintenance Work

The SIGMA CONTROL 2 and the I/O modules are maintenance-free.

11 Spares, Operating Materials, Service

11.1 Note the nameplate

The nameplate contains all information to identify your machine. This information is essential to us in order to provide you with optimal service.

- Please give the information from the nameplate with every enquiry and order for spares.

11.2 HPC AIR SERVICE

HPC AIR SERVICE offers:

- authorised service technicians with HPC factory training,
- increased operational reliability ensured by preventive maintenance,
- energy savings achieved by avoidance of pressure losses,
- optimum conditions for operation of the compressed air system,
- the security of genuine HPC spare parts,
- increased legal certainty as all regulations are kept to.

- Why not sign a HPC AIR SERVICE maintenance agreement!

Result Your advantage:
lower costs and higher compressed air availability.

11.3 Service Addresses

Any inspection, maintenance or repair tasks not described in this manual should be carried out by an authorised HPC service representative.

HPC Engineering PLC
Victoria Gardens, Industrial Estate,
Burgess Hill, West Sussex, RH 15 9RQ.
Telephone (01444) 241671
Fax (01444) 247304

11.4 Displaying the version number, machine model, material number and serial number

1. In operating mode, switch to the main menu with the «Enter» key.

2. Select the *< Configuration → General → System information >* menu.

6.1 bar 08:15 80.0 °C	
5.1.1 System information	Menu
▶1 SIGMA CONTROL 2 MCS	Active line
▶2 Compressor	
▶3 IO modules	

3. Press «Enter» to open the submenu.
The system information is displayed.

6.1 bar 08:15 80.0 °C	
5.1.1.1 SIGMA CONTROL 2 MCS	Menu
Software 1.1.3	Software
.....	
Kaeser	
PN 7.7601.0	Material number
SN x.xx.xx	Serial number
.....	

4. Keep pressing the «DOWN» key to display further settings.

6.1 bar 08:15 80.0 °C	
5.1.1.1 SIGMA CONTROL 2 MCS	Menu
SN x.xx.xx	
.....	
Prodrive	Manufacturer
PN 6309.1000.7900	Material number
SN 10.34.000.961	Serial number
MFGDT 2010/08	Manufacturing date

12 Decommissioning, Storage and Transport

12.1 De-commissioning

- Follow the instructions in the machine's service manual.

12.2 Packing

- Follow the instructions in the machine's service manual.

12.3 Storage

- Follow the instructions in the machine's service manual.

12.4 Transporting

- Follow the instructions in the machine's service manual.

12.5 Disposal

- Follow the instructions in the machine's service manual.