

坤巨資訊股份有限公司
GROOVY TECHNOLOGY CORP.



SPECIFICATIONS OF TOUCH PANEL

觸控面板標準規範書

Data Date(資料日期) : 2013.07.22

Version(版本) : 1.0

Customer(客戶) :

Model(型式) : GP-156F-5M-NT01B (2 Layer)

Type(種類) : 5 Wire Resistive Touch Panel

Customer Approval(客戶確認)

Signature Date _____

Approve(確認)	Checked(審閱)	Preparation(製表)
Gerald	Scott	Mike

GROOVY TECHNOLOGY CORP.
3F,NO.9, ALLEY 2, LANE 35, CHI HU ROAD,NEI
HU DIST, TAIPEI,TAIWAN
TEL : +886-2-2656-2589 FAX : +886-2-2657-8282
EMAIL : service@gtouch.com.tw
[http : //www.gtouch.com.tw](http://www.gtouch.com.tw)

坤巨資訊股份有限公司
台北市內湖區基湖路 35 巷 2 弄 9 號 3 樓
電話 : 02-2656-2589 傳真 : 02-2657-8282
EMAIL : service@gtouch.com.tw
網址 : [http : //www.gtouch.com.tw](http://www.gtouch.com.tw)

CATALOG

00. Revision History 2

01.Characteristics 3

02.Features 3

03.General Specification 3

04.Environmental Characteristics..... 3

05.Optical Characteristics..... 3

06.Electrical Characteristics 4

07.Mechanical Characteristics..... 4

08.Reliability 4

09.Durability 5

10.Inspection Methods..... 5

11.Appearance Inspection..... 6

12.Attention of Mounting Condition..... 7

13.Warranty..... 8

14.Caution..... 8

15.Appearance Specification..... 9

01.Characteristics**he specification is for Five-Wire analog resistive touch panel.**

1. It is working well even the surface suffered scraped damage if the ITO Glass won't been hurt.
2. 500°C high temperature manufacture process.
3. Warranty is as longer as 2 years for normal operating with 10,000,000 touching times.
4. We provide touch panel with high transparency (more than 80%).It is quite clear even your monitor with low brightness.
5. We could customize various size for customers' request between 5 to 22 inch.
6. It is easy to install into varied brands of monitor.

02.Features

Item	Specifications
(1).Type	Five-Wire Analog Resistive Touch Panel
(2).Input Mode	Stylus Pen or Finger
(3).Connector	FFC

03.General Specification

(1).Frame Size	386.81 x 237.12 mm
(2).View Area	347.63 x 196.94 mm
(3).Active Area	345.23 x 194.54 mm
(4).Total Thickness	2.10mm
(5).Tail Length	200mm

04.Environmental Characteristics

Item	Temperature	Humidity (Non Condensing)
(1).Operation	-20°C ~ +70°C	10%RH ~90%RH
(2).Storage	-30°C ~ +80°C	10%RH ~ 90%RH

Note: All terms under 1 atmosphere.

05.Optical Characteristics

Item	Specifications
(1).Transparency	$\geq 80\% \pm 3\%$ (Measured by BYK-Gardner)
(2).Haze	Antiglare Finish $\leq 8\% \pm 3\%$

06.Electrical Characteristics	
Item	Specifications
(1).Loop Resistance	X:20~500Ω, Y:20~500Ω
(2).Linearity	$X \leq 1.5\%$, $Y \leq 1.5\%$
(3).Chattering	$\leq 15\text{ms}$
(4).Insulation	$\geq 20\text{M}\Omega/25\text{V}(\text{DC})$
(5).Endurance	No acting damage at DC50V/60sec.

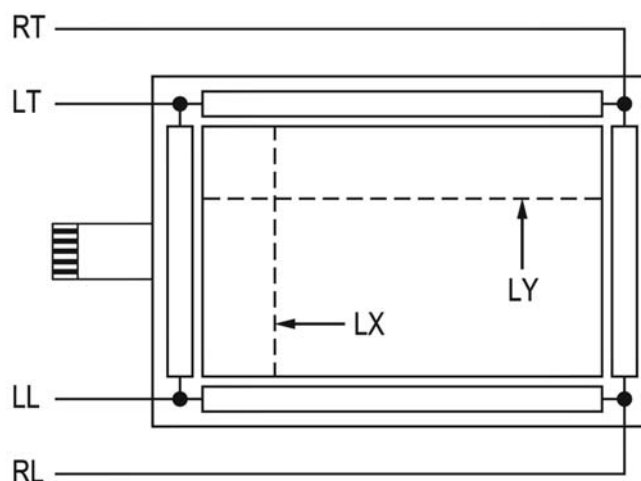

Note : Loop Resistance X = short RT and RL , short LT and LL , measure the resistance between RT and LT
 Loop Resistance Y = short RT and LT , short RL and LL , measure the resistance between RT and RL

07.Mechanical Characteristics		
Item	Specification	Condition
(1).Operating Force	Stylus=R0.8	$\leq 80\text{g}$
(2).Impact	25.0 φ DIA. Steel Ball/67g Height=50cm	1 time, no damage [Impact at center area]
(3).Static Load	5kg within 10 cm ² area for 30sec	Satisfy (1) of Item 07 and (1), (2),(4) of Item 06
(4).Hardness	3H pencil, pressure 1N/45°	$\geq 3\text{H}$
(5).Peeling	800g by vertical 90°	Satisfy (1) of Item 06
(6).Bending	90° 10 times left & right	Satisfy (1) of Item 06
08.Reliability		
Item	Specification	Condition
(1).Constant Temperature /Humidity	60°C /90%RH, 240 hrs and normalized for 4 hrs	After the reliability test, the film may have the condition of bubble; nevertheless the electric characteristic still satisfies the following standard. Satisfy (1), (2) of 05; (1), (4) of 06; (2) of 06 satisfies
(2).Heat Cycle	80°C /240 hrs and normalized for 4 hrs	
(3).Cold Cycle	-30°C /240 hrs and normalized for 4 hrs	
		$X \leq 2.5\%$, $Y \leq 2.5\%$ Operating force must not

(4).Thermal Cycle	-30°C ~80°C [60 min./cycle] ×50 cycles and normalized for 4 hrs	exceed 400g after reliability test
09.Durability		
(1).Knock Test	10,000,000 times	Satisfy (1), (2) of Item 5; (1), (4) of Item 6; (2) of item 6 satisfies $X \leq 2.5\%$, $Y \leq 2.5\%$; Operating force must not exceed 400g after reliability test

10. Inspection Methods

(1). Linearity Condition
 Short RT and RL(or short RL and LL) and voltage DC 5V is applied , short LT and LL (or short RT and LT) and ground is applied , using stylus to draw straight points LX and LY at 5.0mm intervals within pattern area and detect the voltage at SG. To measure the voltage differences between RT and LT(or RT and RL) (Fig 10-1) (Fig 10-2)

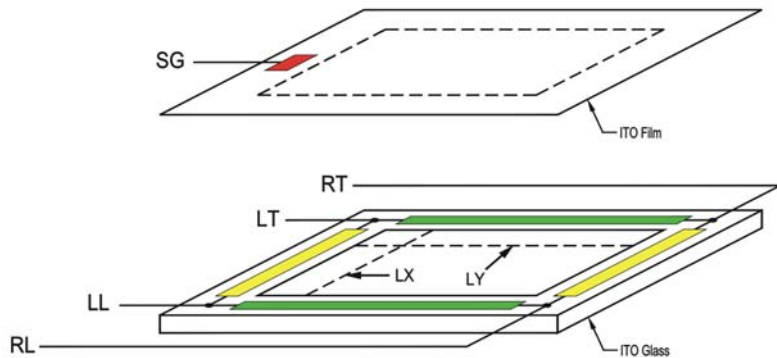

Figure 10-1

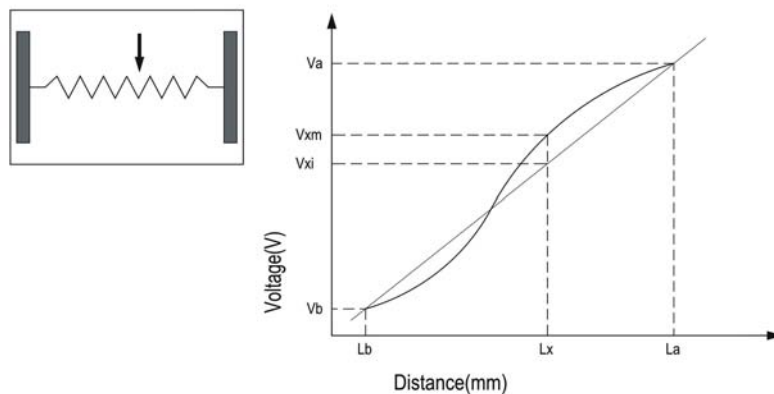
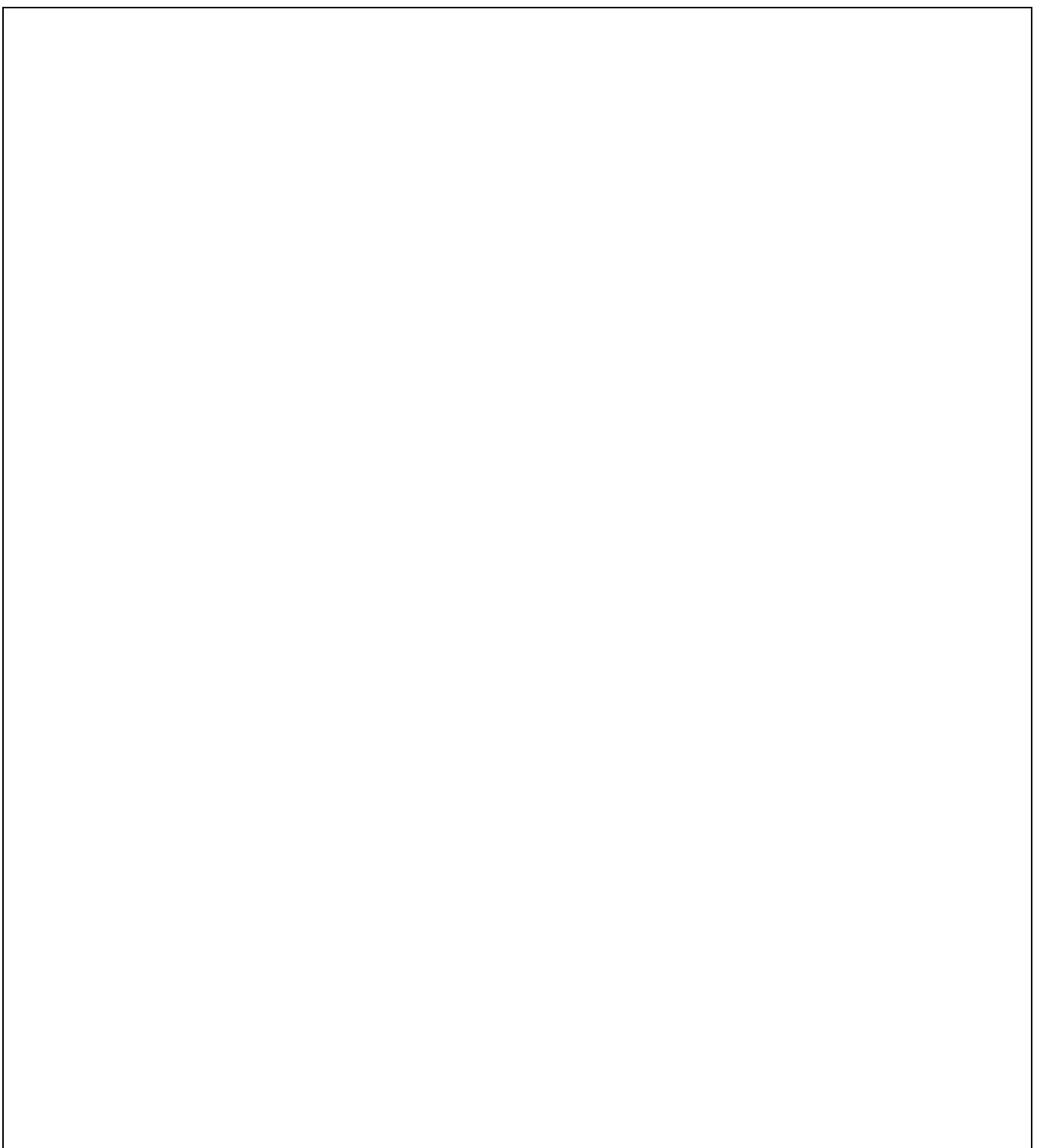

Figure 10-2

※ Linearity: $[| V_{xm} - V_{xi} |] / (V_a - V_b) \times 100\%$ (for reference only)

(2).Specification

The linearity must be meet the electrical specification outlined in item 6.



11. Appearance Inspection

(1) The flaws and impurities are allowed outside viewing area except for those affecting electrical functions.

(2) The inspection was performed with one 17W fluorescent lamp lighting from back or side. The panel was placed 30cm away from eyes. (Figure 11-1)

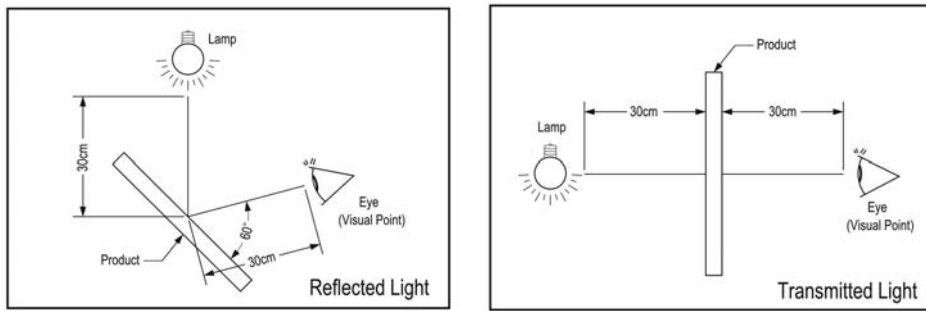

Figure 11-1

(3) Glass Flaw

Item	Picture	Specification
Corner Flaw		$X \leq 3.0\text{mm}$ $Y \leq 3.0\text{mm}$ $Z \leq T$
Edge Flaw		$X \leq 3.0\text{mm}$ $Y \leq 3.0\text{mm}$ $Z \leq T$
Progressive Flaw		Not allowed

Note: T=Glass thickness

12.Attention of Mounting Condition

- (1) The gasket support of touch panel must be designed on the outside of Viewable area, as well as to avoid pressing on touch panel accidentally, the enclosure must be designed with enough clearance to panel surface. To avoid pressing error on touch panel accidentally, please remain space between the surface of panel and the Bezel.
- (2) Bezel opening must be designed between Viewable area and Active area. Bezel opening must not touch Viewable area.
- (3) We recommend elastic material made support.
- (4) Do not use adhesive to bond top surface (ITO Film) of touch panel with enclosure.
- (5) The edge of touch panel is conductive. Don't touch it with metal after mounting.
- (6) Proper grounding of controller at all times assure normal operation.

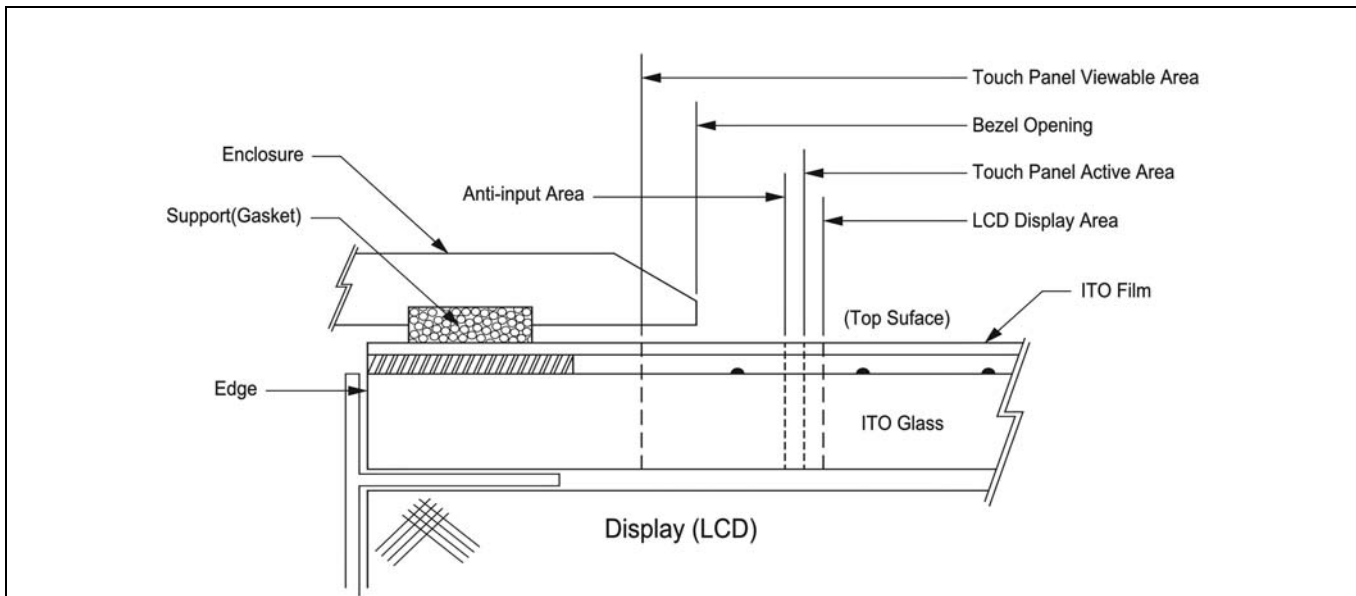

Figure 12-1

13. Warranty

GROOVY comes with a 2-year guaranty on 5 wire resistive touch panel. GROOVY guaranty provide for repair and replacement without any charge during this period.

GROOVY reserves the right in its sole discretion to determine the defects received, and will take the responsibility if there is any defect or damages.

Notice: GROOVY is not responsible for following situation:

1. Damages caused by improper handling from clients, such as the shipping period or manufacturing processes.
2. Damages caused by either natural disaster or human factors after receiving the products.
3. Damage caused by self-repairs, and modifications or disassembling of GROOVY products from clients without prior notice.

14. Caution

Storage	(1)Storage shall be under the temperature and humidity that mentioned in the specification. Do not expose the products to direct sunlight or piling caused damage on the surface.
Unpacking	(1)Check for the correct vertical direction of the package before unpacking.
Handing	(1) In order to prevent fingerprints or stain on the products, and get a cut by sharp edges of glass, clean finger sacks or glove and mask are required during handing. (2) Do not touch the viewing area of the panel. (3) Do not handle the tail (connector) of panel directly, when you handle the touch panel. It will cause the problem of combination and reliability

Cleaning	<p>(1) Clean and soft clothes with neutral detergent and with isopropyl alcohol may be used for cleaning.</p> <p>(2) Do not use any chemical solvent, acidic or alkali solution.</p> <p>(3) The panel is designed with air groove. Insulation and cushioning pads should be designed around the edges of the panel to prevent water and dust.</p>
Install and Assembling	<p>(1) Excessive force or strain to the panel or tail is prohibited.</p> <p>(2) Retain at least 0.3 mm clearance between panel and display module.</p> <p>(3) Gasket or cushion pads around the edge of the panel may segregate water and/or dust contamination.</p>
Operating	<p>(1) Use a plastic stylus (tip R0.8 or over) or finger. Sharp edged or hard articles are prohibited.</p> <p>(2) The gathering of dew in the panel may occur with abrupt temperature or humidity changes. A stable environment condition is recommended.</p>
Others	<p>(1) Keep the surface clean. No adhesives should be applied.</p> <p>(2) Avoid high voltage and static charge.</p> <p>(3) GROOVY has the right to change the materials and specification.</p>

15.Appearance Specification

Particle	<p>(1) $D \leq 0.5 \rightarrow \text{OK}$</p> <p>(2) $0.5 < D \leq 0.7$ (each area contains ≤ 3, total ≤ 6) $\rightarrow \text{OK}$</p> <p>(3) $D > 0.7 \rightarrow \text{NG}$</p>
Linear Object	<p>(1) $W \leq 0.05 \rightarrow \text{OK}$</p> <p>(2) $0.05 < W \leq 0.1$ and $L \leq 20$, total $\leq 5 \rightarrow \text{OK}$</p> <p>(3) $W > 0.1 \rightarrow \text{NG}$</p> <p>Remark: the particle will be ignored when it is cleanable.</p>
Scratch	<p>(1) $W \leq 0.04 \rightarrow \text{OK}$</p> <p>(2) $0.04 < W \leq 0.06$ and $L \leq 12$, total $\leq 7 \rightarrow \text{OK}$</p> <p>(3) $0.07 < W \leq 0.1$ and $L \leq 6$, total $\leq 6 \rightarrow \text{OK}$</p> <p>(4) $W > 0.1 \rightarrow \text{NG}$</p>

< Remark >

1. D=Diameter
2. W=Width
3. L=Length
4. Each area contains=20 ϕ
5. Unit=mm

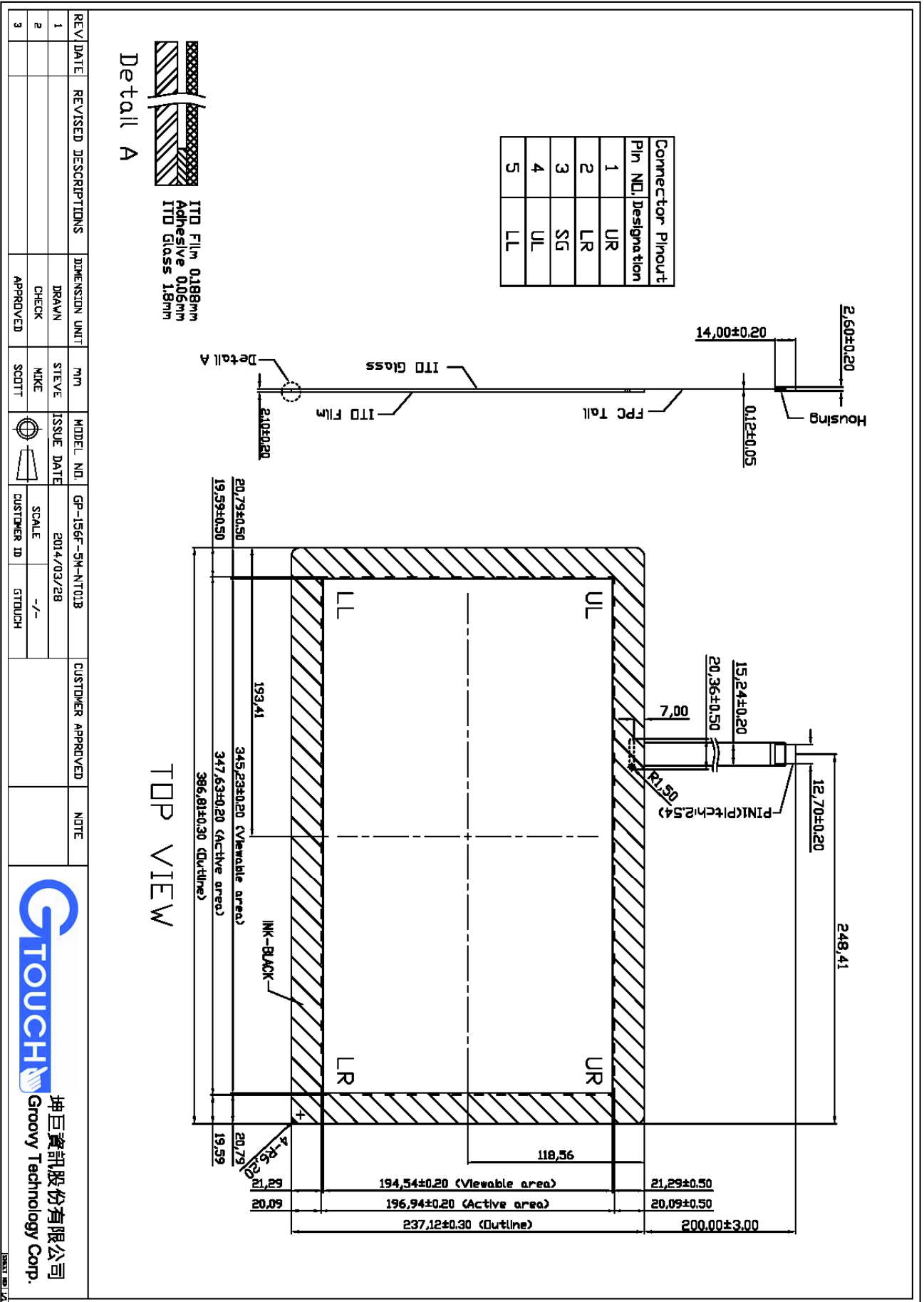

REV/DATE	REVISED DESCRIPTIONS	DIMENSION UNIT	MM	MODEL NO.	GP-156F-SM-N101B	CUSTOMER APPROVED	NOTE
1	DRAWN	STEVE	ISSUE DATE	2014/03/28			
2	CHECK	MIKE	SCALE	-/-			
3	APPROVED	SCOTT	CUSTOMER ID	GTOUCH			

坤巨資訊股份有限公司
 Groovy Technology Corp.