

# User manual

## Panel-PC:



EPC PM 1700tc Nautic



EPC PM 1900tc Nautic



EPC PM 2100tc Nautic

## TFT Monitor + PC-Box:



MT 217 Nautic



MT 219 Nautic



MT 221 Nautic



EPC PM box Nautic

CiS-Nr.: 360.610.0120  
Reg 10509/0805  
Version 2/03.06  
© Elektronik-Systeme LAUER GmbH & Co. KG

**LAUER**  
Ein Unternehmen der AUGUSTA Technologie AG

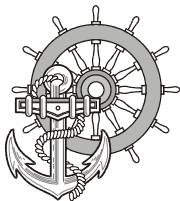

Elektronik Systeme LAUER GmbH & Co. KG  
P.O Box 1465  
D-72604 Nürtingen

Operating instructions: EPC PM Nautic devices  
issue: 13. März 2006  
editor: Jung

Operating instructions, manuals and software are copyrighted. All rights are reserved. Copying, duplicating, translating, transcribing en bloc or partially is prohibited. An exception is the making of a software back up copy for private use.

- We reserve the right to make amendments to the manual without prior notice.
- We can not guarantee the accuracy and correctness of the programmes and data stored on the CD-ROM.
- Helpful suggestions, improvements as well as references to errors are welcome at any time.
- The stipulations are also valid for any special annexes to this manual.

Microsoft, Windows 2000, Windows XP and the Windows Logo are either registered trademarks or trademarks of the Microsoft Corporation in the USA and/or other countries.

The above terms in this documentation can be brands, whose use by third parties can breach the rights of the proprietor.

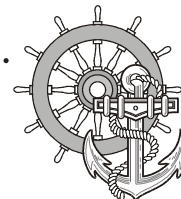

---

## User tips

Please read the manual prior to using for the first time and keep it in a safe place for future use.

### Target group

The documented information in this manual refers to the appliance, place of use, transport, storage, assembly, use and maintenance.

This manual is directed to the following target groups:

- User
- Service technicians/maintenance technicians

Especially observe the chapter „safety instructions and general instructions“.

Knowledge of PC and Microsoft-operating systems are assumed. General knowledge in the area of automation technology is recommended.

### Diagram convention

[Key] Key entries by the user are shown in squared brackets, for example [CTRL] or [DEL]

*italic* Names of pushbuttons to be used, menus or other screen elements as well as brand names are shown in italic letters.

### Necessary basic knowledge

A solid Knowledge of the personal computer and Microsoft-operating systems is assumed and a general knowledge in the area of automation technology is recommended.

### Approbation's & standards

You will find information in the annex, chapter „certificate and guide lines“.

### Safety instructions

Anywhere in the automation equipment, where dangerous errors may occur, i.e. that an occurring error may cause major material or personal damage, additional external precautions or facilities have to be made (for example by means of independent limit switches, mechanical interlocks etc.), which in case of an error guarantee or enforce a secure operating condition.

The test and aptitude of the intended usage by the user res. the usage under operational conditions is the responsibility of the user. Therefore Elektronik-Systeme LAUER does not assume liability.



## User Tips

### Icons

The following icons are used in the manual to mark certain paragraphs:



#### Danger!

Means that death or severe injury will occur when the relevant precautionary measures are not taken



#### Caution!

Means that death or severe injury may occur when the relevant precautionary measures are not taken.



#### Warning!

With warning triangle means that a light injury may occur when the relevant precautionary measures are not taken.

#### Attention!

Without warning triangle means that material damage may occur when the relevant precautionary measures are not taken.



#### Notice!

Means that an undesirable effect or situation may occur if the respective advise is ignored.

The warning advise for the highest level is used if various danger levels occur. When a warning advise with a warning triangle warns about personal damage then an additional warning for material damage can be added.

### Qualified personnel

The described appliance may only be installed and operated in accordance with this documentation. Only qualified personnel may put it into operation and operate this appliance. Qualified personnel are persons, who in accordance with the safety regulations contained in this documentation, are authorised to put into operation, earth and stamp appliances, systems and circuits.

### Intended use

The appliance can only be used for the designated purposes as described in the catalogue and the technical write up and only in conjunction with external devises i.e. components recommended and authorised by Elektronik-Systeme LAUER GmbH & Co. KG. The efficient and safe operation of the appliance presupposes appropriate transport, storage, assembly and installation as well as accurate handling and maintenance.

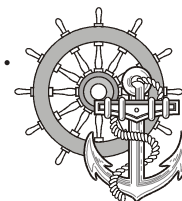

# Contents

<b>User tips</b>	<b>3</b>
<b>Contents</b>	<b>5</b>
<b>Preamble</b>	<b>6</b>
<b>Certificates and guide lines</b>	<b>7</b>
<b>1 Preparation</b>	<b>9</b>
1.1 List of supplied equipment .....	9
1.1.1 Organisation driver-CD .....	10
1.2 Preparing the installation of the appliance .....	10
<b>2 Description</b>	<b>11</b>
2.1 Installation .....	11
2.2 Display .....	13
2.3 Ports .....	14
2.4 Motherboard – slots, memory module .....	15
<b>3 Putting in to operation</b>	<b>17</b>
3.1 Power supply .....	17
3.1.1 How to handle ATX-power packs .....	17
3.2 Earthing system .....	19
3.3 Assembly .....	19
3.4 Operating system .....	20
3.5 BIOS-settings .....	21
3.6 Important items regarding software installation .....	23
3.7 Touch installation 6.10 Windows 2000 / XP (only if required) .....	24
3.8 Graphic board installation .....	28
3.9 Installation LAN-/network card .....	29
<b>4 Service</b>	<b>31</b>
4.1 Changing the fan .....	32
4.2 PCI-board installation .....	34
4.3 Memory expansion, -change .....	38
<b>5 Technical data</b>	<b>41</b>
5.1 Detailed drawings .....	43
5.1.1 EPC PM 1700 Nautic .....	43
5.1.2 EPC PM 1900 Nautic .....	47
5.1.3 EPC PM2100 Nautic .....	51
5.1.4 MT 217 Nautic .....	55
5.1.5 MT 219 Nautic .....	59
5.1.6 MT 221 Nautic .....	63
5.1.7 EPC PM Box Nautic .....	67



## Preamble

Elektronik-Systeme LAUER GmbH & Co. KG

Kelterstraße 59

D-72669 Unterensingen

Tel. +49 (0) 7022 / 9660-0

Fax +49 (0) 7022 / 9660-274

<http://www.lauer-systeme.net>



### our philosophy

Elektronik-Systeme LAUER is a reliable internationally orientated partner. From the text display LCA, the high-tech operating console PCS, to the industrial computer we supply a complete range to:

- operate, observe and control

Systeme LAUER stands for an almost unlimited product range and competent service, under the umbrella of AUGUSTA Technologie AG – a global group of companies.

Through active co-operation with our customers, persuasive concepts are developed harmonising efficiently man, and interface. Proximity to customers – the direct dialog – is the basis of our success.

### Support contact

Telephone: +49 (0) 7022 / 9660 -209

eMail: [Support@systeme-lauer.de](mailto:Support@systeme-lauer.de)

**for support inquiries always have the serial number of your appliance at hand!**

Up to date driver units, software, driver units, manuals ...and innovations can be found in our download-forum:

<http://forum.systeme-lauer.de/>

### Sales contact

Telephone: +49 (0) 7022 / 9660 -0

eMail: [Sales@systeme-lauer.de](mailto:Sales@systeme-lauer.de)

### additionally on offer ...

... courses and technical training in our modern equipped training centre or alternatively at your place of business. Please ask your distribution agent for the latest training course schedule.

... not only demo-appliances but also specialists who will personally assist you when you first take your appliance into operation..

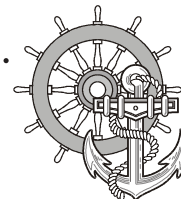

## Certificates and guide lines

The following applies for the products described in this documentation:

### EMV-directives

#### Alternating - AC supply

The appliances running on AC supply comply with the EC-directive „89/336/EEC electromagnetic compatibility“ and are according to the CE-marking designed for following applications:

<b>Application</b>	<b>Standard</b>	
	Emitted interference	interference resistant
industrial	EN 61000-6-4: 2001	EN 61000-6-2: 2001

#### Direct current –DC supply

The appliances running on DC supply comply with the EC-directive „89/336/EEC electromagnetic compatibility“ and are according to the CE-marking designed for following applications:

<b>Application</b>	<b>Standard</b>	
	Emitted interference	interference resistant
industrial	EN 61000-6-4: 2001	EN 61000-6-2: 2001

### low voltage directive 230V

The appliances running on AC supply comply with the EC-directive 73/23/EEC, low voltage directive. Compliance with this standard was tested in accordance with EN 60950.

### Declaration of conformity

The EC- declaration of conformity and the associated documentation and are kept at the disposal of the responsible authorities. Your distribution agent can make these available on demand.

### Assembly directives

Please note the assembly directives and safety instructions mentioned in this documentation, when putting into operation and during operation.



## Certificates and guide lines



The following certifications apply from summer 2005 for the products described in this documentation:

- Germanischer Lloyd (GL)
- Lloyds Registers (LR)
- Bureau veritas (BV)
- Det norske veritas (DNV)
- American Bureau of Shipping (ABS)



These products are also tested in accordance with EN 60945 for „Bridges“!





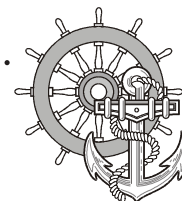

# 1 Preparation

## 1.1 List of supplied equipment

The transport cardboard box contains the following parts and materials:



CD with operating system.



Driver software CD for all pre-installed components like mother board, touch, key board etc. Further information will be found in chapter „installation“.



User manual  
Notice! Separate documentation of third party components is included on the enclosed CD. This manual only describes specific information about LAUER products – not about third party components.

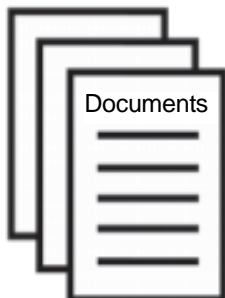

The LAUER appliance pass is supplied with every appliance. It contains important information for the user. Ready to hand are important address data, serial number, then there are the components and type designation corresponding with the company internal appliance designation. Also shown are all components contained in the system – therefore the CPU and hard disk type or the operation system are easily identifiable for the user.

Your advantages:

- all important contact data for a fast and uncomplicated handling for desired improvements, general queries or for service purposes.
- complete configuration of your system including serial number.



Fixing kit  
8 Stainless steel screws with washers/nuts and O-ring seals are contained in the parcel of each EPC PM 1700, 1900, 2100 Nautic, MT 217, 219 and MT 221 Nautic.



# 1 Preparation



Cable set, consisting of VGA- and USB-cable (Length 3m)  
Only supplied with MT 217 or MT 219 (optional) .



1 standard power cable/cooling device cable  
(European or US standard) - Length approx. 3m  
Only supplied with MT 217 or MT 219 .  
Tip! Power-cable is NOT contained with the DC-version.

## 1.1.1 Organisation driver-CD

On the supplied driver CD you will find the available drivers necessary for your installation.

- AUDIO (Onboard Sound)
- CHIPSET
- Graphic (Graphic cards driver for a resolution up to 1600 x 1200 for a 21" Display)
- LAN (Onboard network)

## 1.2 Preparing the installation of the appliance

Open the package and check, whether the contents match the list above. The cardboard box should be kept for an eventual future safe transport. After removing the appliance from the parcel, lay the parts on a suitable clean and open surface (for example a table. Workbench etc.). Follow exactly the instructions described in the following chapters.

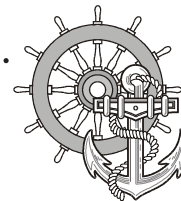

## 2 Description

### 2.1 Installation

Compact solution

The installation of the EPC PM Nautic is independent of the display size, shown as follows:



- 1 front unit
- 2 PC-unit



## 2 Description

Monitor solution

The installation of the Monitors is independent of the display size, shown as follows:



- 1 front unit
- 2 PC-unit

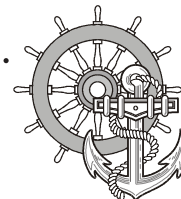

---

## 2 Description

### 2.2 Display

Display sizes of 17" and 19" are available.



Front with USB-port, ON/OFF-switches and dimmer switches to regulate the brightness.



## 2 Description

### 2.3 Ports

PC-Module

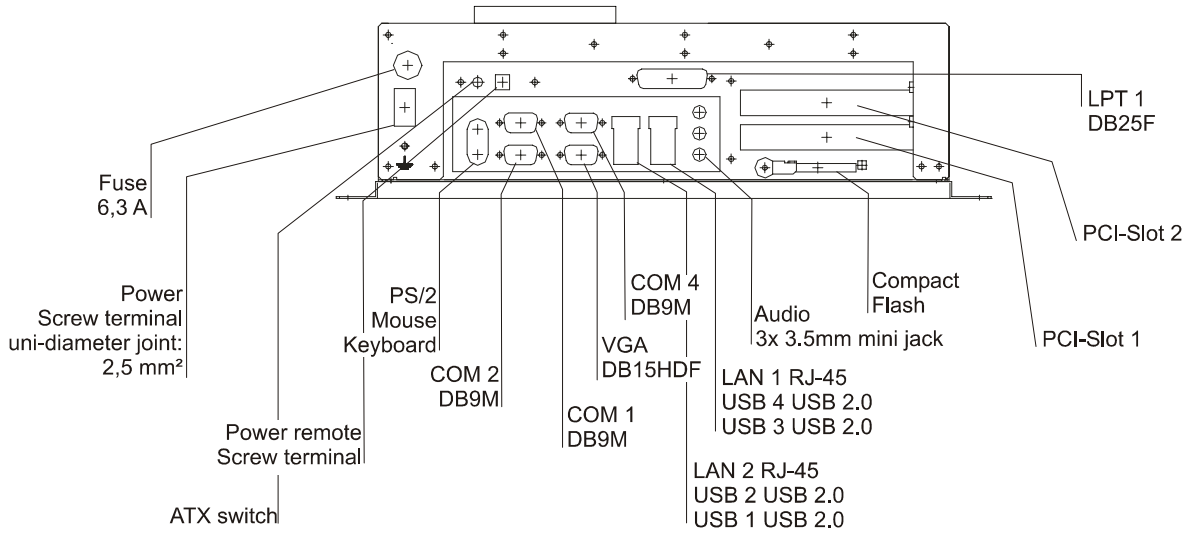

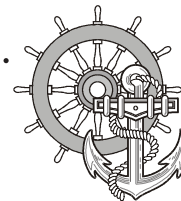

---

## 2 Description

### 2.4 Motherboard – slots, memory module

The panel-PC and the PC-module have 2 DIMM slots for the main storage, 2 PCI-slots.

Further details on the motherboard can be found in the manual with the supplied materials.



---

Notice!

Individual slots may be part of the supply depending on configuration and customer requirements!

The quality of the memory module may influence the system stability. Please only use memory modules cleared by Systeme LAUER.

Memory modules are electrostatic sensitive components. Relevant protective measures (earth) have to be considered during assembly/disassembly.

ESD-protective measures to be considered when opening and working on the appliance.

---



## 2 Description



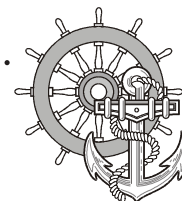

### 3 Putting in to operation

#### 3.1 Power supply

The Panel-PC, TFT Display and the PC-Box are available as DC-24V- or AC-115/230V-power system.

##### Power supply system

The Panel-PC and PC-Box can be operated with extra-low-voltage in accordance with EN60950!

The controlling transformer has to comply with EN60742!

Check the power supply system with the relevant data on the type plate. All cable connections have to be checked prior to putting the system in to operation.

It has to be ensured that all voltages and signals comply with the relevant specifications.

- 1 fuse 6,3 A
- 2 power supply 24V
- 3 earth screw
- 4 ATX switch
- 5 Power remote terminal
- 6 power supply 230V



The power supply 24V is carried out via a double-pole connector (Phoenix MST BT 2,5/2).

##### 3.1.1 How to handle ATX-power packs

Power packs, main boards and operation systems are used in the Panel-PC and the PC-Box, using up to date PC-technologies like „ATX“ and „ACPI“. Switching on the appliances is done in accordance with ATX-specification via the ATX-Power-switch (red button underneath the appliance).

Should a correct automatic booting not function then this can have the following reasons.

In the BIOS the option AC PWR Loss Restart i.e. PWRON After PWRFail must be set to Enable i.e. On .

The operating system must be ended correctly via the button abandon – shut down, so that the operating system of the VPC is shut down. The computer must not be switched while with the operating system is still running!



### 3 Putting in to operation

The power pack now has to be separated for at least 15 seconds from the power supply, prior to a re-start. During the booting process the mains voltage may not fall (not even for a short time) below the permissible value.

A manual actuation of the ATX-Power-switch becomes necessary i.e. the BIOS-menu starts automatically to check and confirm correctness of settings, if the system registers an error during shut down or booting.

**This is not a malfunction but a safety feature!!**

#### Supply build up

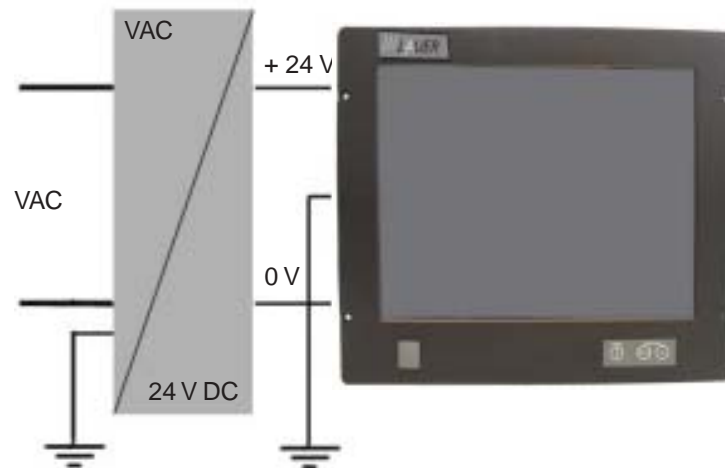

#### Power supply Monitor

- 1 Supply connection 24 VDC
- 2 Earth screw
- 3 VGA-connection
- 4 2x USB, Power Remote connection



- 1 Supply connection 115/230 VA
- 2 Earth screw
- 3 VGA-connection
- 4 2x USB, Power Remote connection

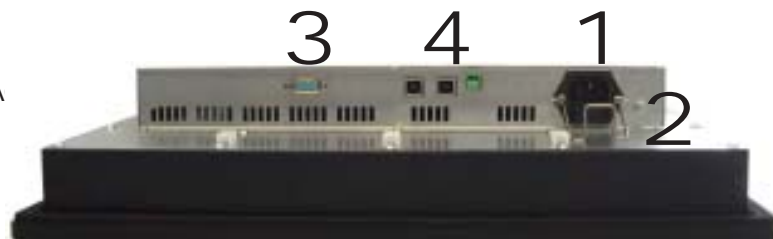

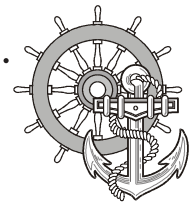

## 3 Putting in to operation

### 3.2 Earthing system

The following items have to be observed to guarantee a safe dissipation of electronic interference:

- Appliance and switch board have to be connected to the nearest possible central earthing point.
- make sure of a possibly low inductive connection between appliance and switch board.
- All data cables connected to the appliance have to be the screened type.
- The screens have to be earthed on both sides. There has to exist a low ohm connection between the connected systems. High equalising currents through the cable screen due to voltage fluctuations are to be avoided.
- The earthing connection is to be carried out with min. 4 mm<sup>2</sup> cross section.

### 3.3 Assembly

Assembly

To dissipate the heat generated in the appliance a free space for air circulation, of 100 mm has to be provided around the appliance!

The installation is done by means of screws.

---

Notice!

Possibility of damage to the appliance!

Protection class IP65 to the front panel is only guaranteed with a perfect fitting seal.

Pay attention to the torque when fixing the front panel!

---



## 3 Putting in to operation

### 3.4 Operating system

Supply incl. operating system

hard disk version:

We offer our appliances with installed operating system software. In this case we opt for following installation concept. The respective operating system and other programmes are installed on C: drive. D: drive is a complete free partition and can for example be used for your data (beneficial for example for data back up). On E: drive are all the data required for a new installation (drivers and operation system). This partition always uses a FAT 16-data system.

At present the following operating systems are available:

Windows 2000 German, English and multi-language pack

(C: and D: NTFS)

Windows XP professional German and English

(C: and D: NTFS)

depending on the configuration, the respective user interface of the installed operating system appears, once the EPC has booted from the hard disk.

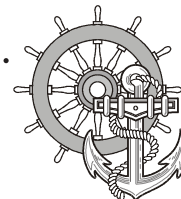

### 3 Putting in to operation

#### 3.5 BIOS-settings

Settings DFI-ACP G5M100N:

Switch on the Panel-PC and press the [DEL] i.e. [Entf]-button shown in the first screen image, to start the set up.

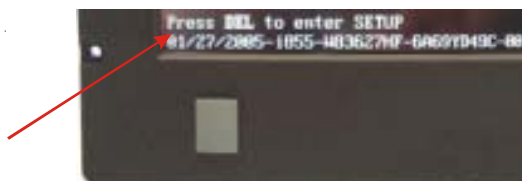

Select the menu item „Load Optimised Default“ and affirm the selected operation.





### 3 Putting in to operation

Settings for the Mini-ITX Board DFI ACP G5M100N:

1. Load „Load Optimised Default“ and carry out the respective settings in the shown menus.

Menu/ sub menu	Menu item	Setting
Standard CMOS Features	Date	current date
Standard CMOS Features	Time	current time
Standard CMOS Features	check if all IDE-Devices (HD, CD and CF) were correctly recognised!	
Advanced BIOS Features	First Boot Device	HDD-1
Advanced BIOS Features	Second Boot Device	HDD-0
Advanced BIOS Features	Third Boot Device	Disabled
Advanced BIOS Features	Boot Other Device	Disabled
Advanced BIOS Features	Boot up Floppy Seek	Disabled
Advanced Chipset Features	Panel Number	
	12"	2: 800x600 18(bit)
	15"	8: 1024x768 24(bit)
	17" and Box	4: 1260x1024 48(bit)
	21"	10: 1600x1200 48(bit)
Integrated Peripherals/ Super IO Device	PWRON After PWR-Fail	On
Integrated Peripherals/ Super IO Device	Serial Port 3 Use IRQ	IRQ4
Integrated Peripherals/ Super IO Device	Serial Port 4 Use IRQ	IRQ3

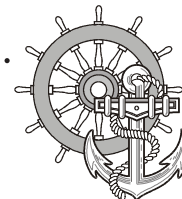

### 3 Putting in to operation

#### 3.6 Important items regarding software installation

To carry out a successful re-installation you have to observe the following items:

- For the set up please use the supplied operating system-CD.
- After the re-installation, the Chipset driver has to be installed first. This can also be found on E:\drivers\Chipset.
- Install the graphic drivers (select E:\graphic\operating system).

The picture refresh rate has to remain at 60 Hz, as the TFT displays do not have an electron beam for image formation, and therefore no improvement is achieved from a higher setting. Higher settings can even result in the destruction of the graphic board/display.

- install the touch drivers in accordance with the instructions.

---

#### Notice!

To avoid always having to re-start the installation procedure of the operating system, we recommend image production of the new hard disc (for example Norton Ghost, Drive Image etc.).

So, if needed, you can always fall back on the operational image.

---

---

#### Notice!

We recommend after operating the system for the first time that you reproduce Start i.e. Emergency discs. These might be needed to restore an operational system. Additionally you should make backup copies of your own data and applications!

---

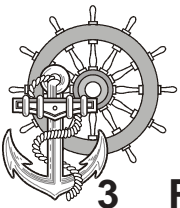

## 3 Putting in to operation

### 3.7 Touch installation 6.10 Windows 2000 / XP (only if required)

technical data: (check the BIOS entries when re-installing)

- Serial Tsharc 12 Touch-Controller
- Com 3 (check the BIOS entries)
- 3E8 hex
- IRQ 4
- 9600 bps

Carry out the SETUP.EXE under

- drive E:\Driver\Driver-EPC-PM\Touch\Touch (with the ordered operation system)
- CD-ROM: (D:) E:\EPC-PM\Touch

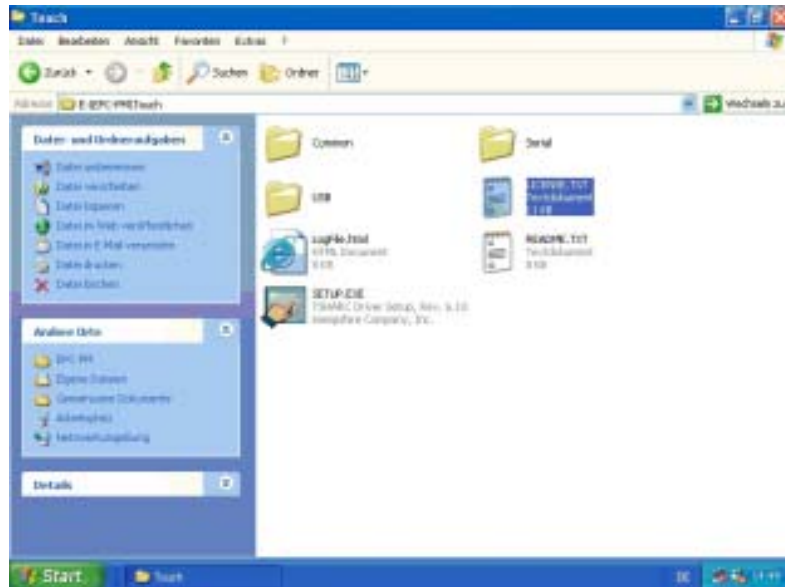



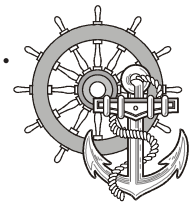

### 3 Putting in to operation

- follow the instructions on the monitor, press [CONTINUE].

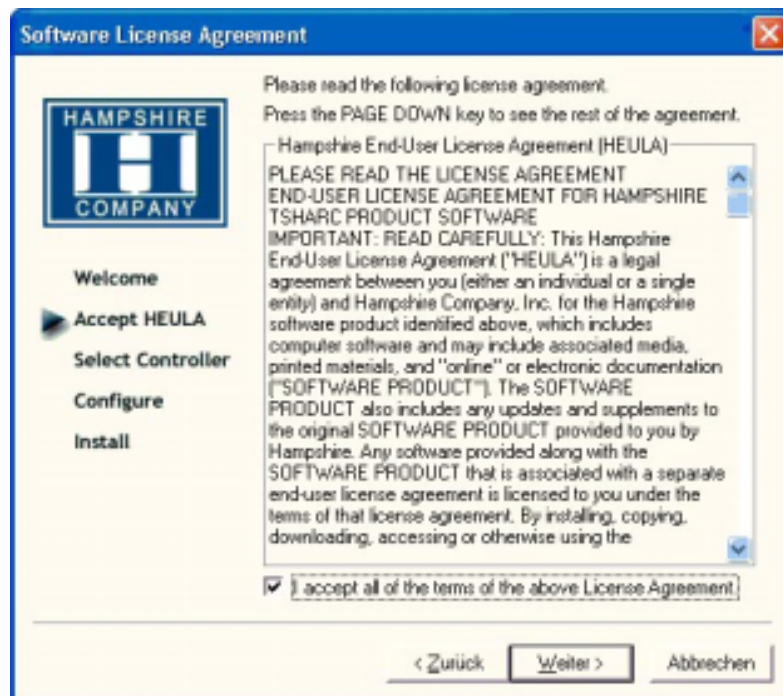
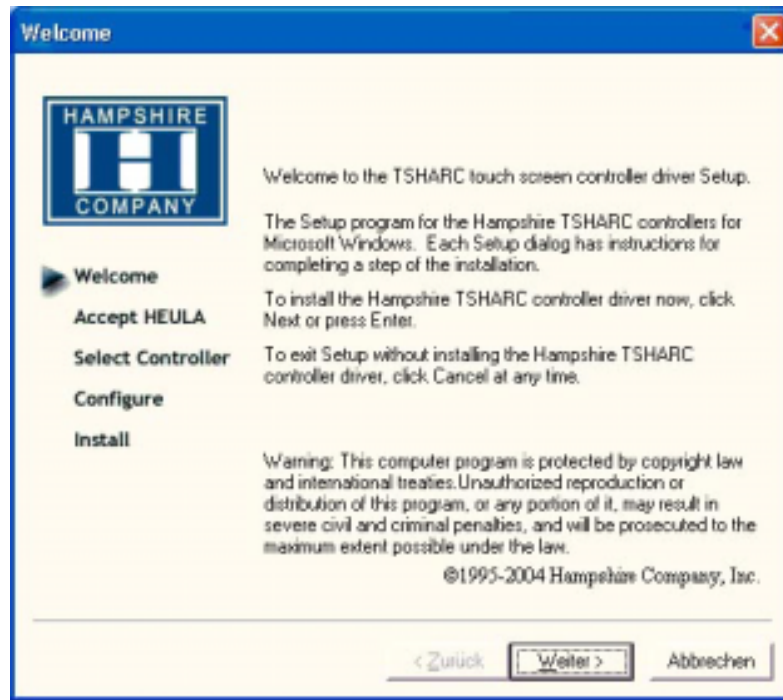

- accept the license provisions

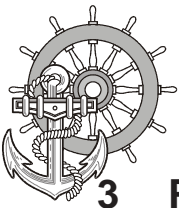

### 3 Putting in to operation

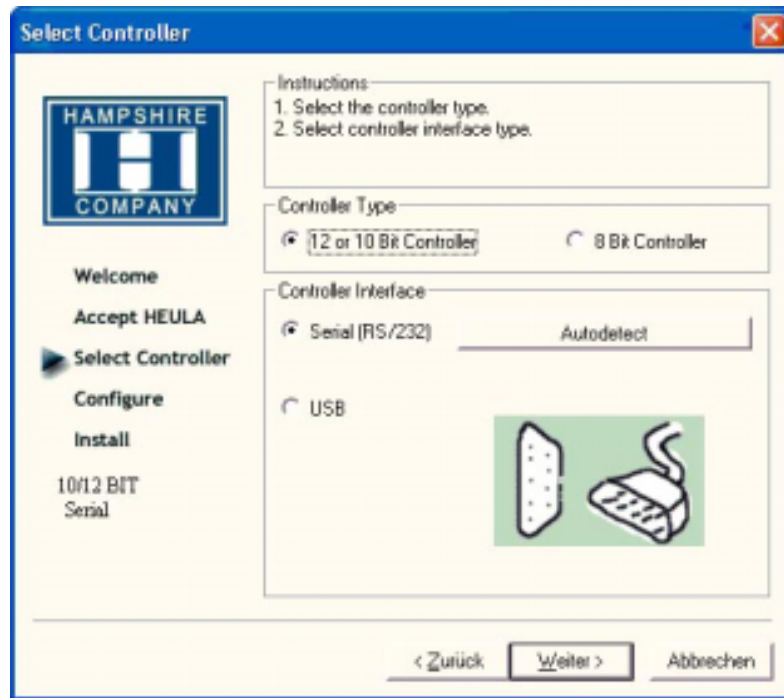

- select the „Auto detect Function“ or manually select the technical connection data.

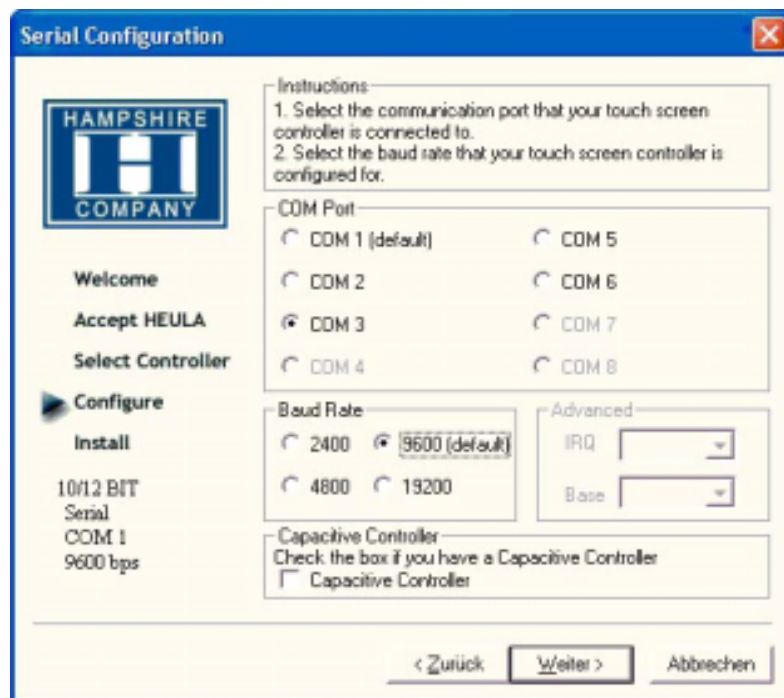

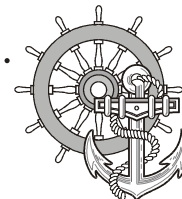

### 3 Putting in to operation

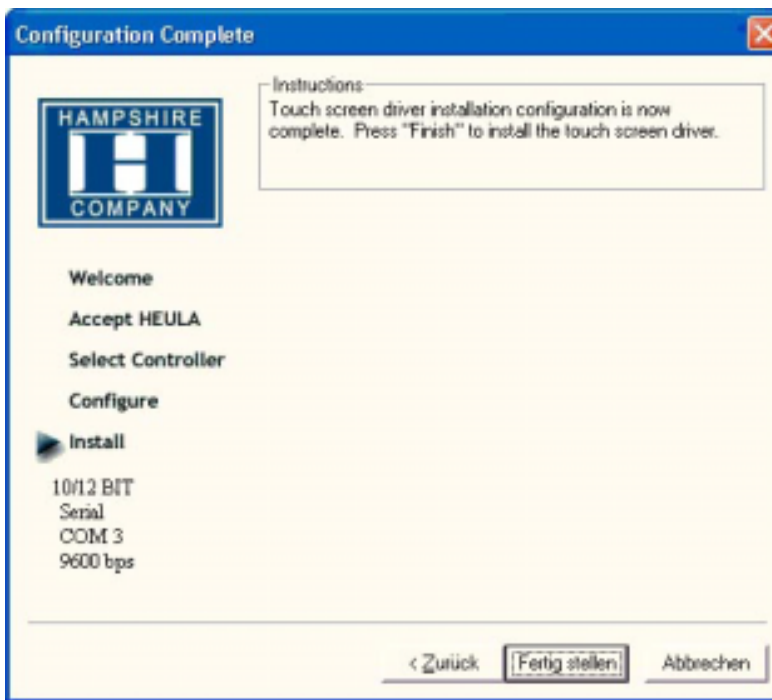

- Press the [finalise]-Button and follow the instructions for a re-start.
- After a re-start of the operating system you will find amongst the programs the entry „Hampshire Control Panel“.
- Calibrate the touch screen with your finger or with a rounded pointed touch pen.

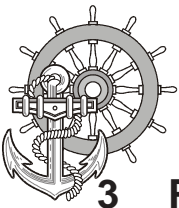

## 3 Putting in to operation

### 3.8 Graphic board installation

After conclusion the Windows installation (chip set driver) and restart of the device, close the installation window for the automatic driver search of the graphic board driver.

- The graphic driver is on the delivered Driver CD or on Partition E:\ EPC-PM \ Grafic
- Start *SETUP.EXE* in the directory *UTILITIES* and accept the following messages.

Attention!

The graphic driver will be installed 2x!

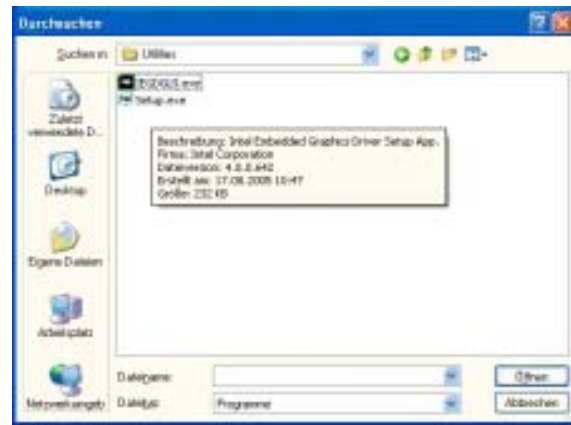
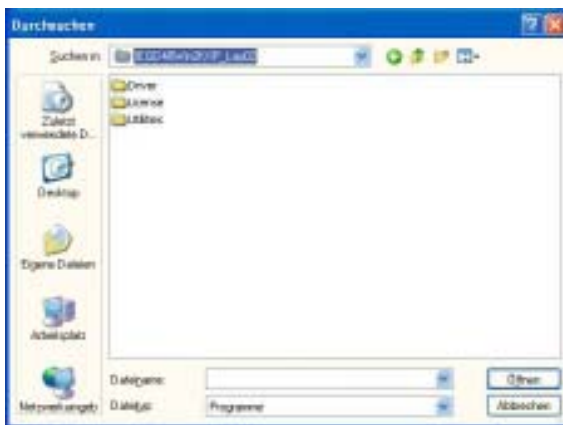

- After conclusion the installation and restart the PPC the following entries can be seen in the Control Panel or in the display properties.

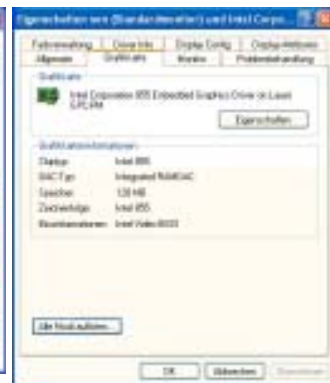
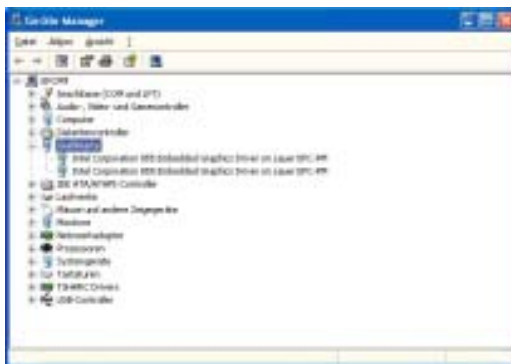

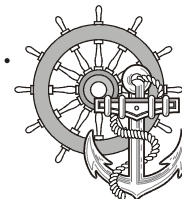

---

## 3 Putting in to operation

### 3.9 Installation LAN-/network card

proceed as follows to install the LAN-/network card(s):

- following the installation of the operating system and the chipset driver, the system automatically makes a link to a network connection. You find the relevant icon (Network icon) in the right hand lower taskbar.
- call-up the EXE-file from the drive-directory, drive E:\Driver\EPC-PM\LAN for the installation of the second network card.
- confirm each installation step and re-start the EPC PM at the end of the installation.
- After the re-start 2 new network icons appear in the right hand side lower taskbar.
- You can now configure both network cards to your own needs (IP-address etc.) via the system control.
- Via the MS-DOS window, under *Start -> accessories -> entry prompt*, you can set a „connection PING“. Herewith you can then test your connections to the server and other PC's.

(for example: C:\ping 192.168.5.100).



### 3 Putting in to operation

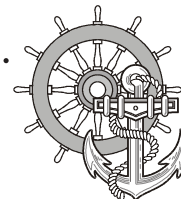

## 4 Service

### Tools



You can carry out the assembly with an Allan key 2,5 and a Phillips screw driver size 3.

### Preparation

Disconnect the appliance from the power supply.

**Attention!**

Deadly peril .....

Please pay attention that your electrostatic pad does not damage the front panel of the EPC PM.

### Open the appliance

All operations to the opened appliance may only be carried out by authorised personnel. Only the expansion of hardware with memory and plug-in-cards is permissible within the defects liability period.

---

**Attention!**

There are electronic components within the appliance which can be destroyed by electrostatic charges.

Therefore cautionary measures have to be taken from the moment the appliance is opened. These can be consulted in the guidelines for electrostatic endangered components (EGB-guidelines).

---



## 4 Service

### 4.1 Changing the fan

To change the fan you have to remove the left hand part of the rear enclosure.

To open the enclosure remove the marked screws with an Allen key.



Then lift the enclosure and pull out the fan cable.





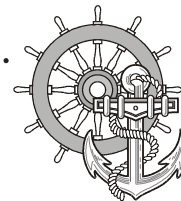

## 4 Service

Please note the correct location of the cable prior to pulling the cable out so that the new fan can be plugged in correctly.

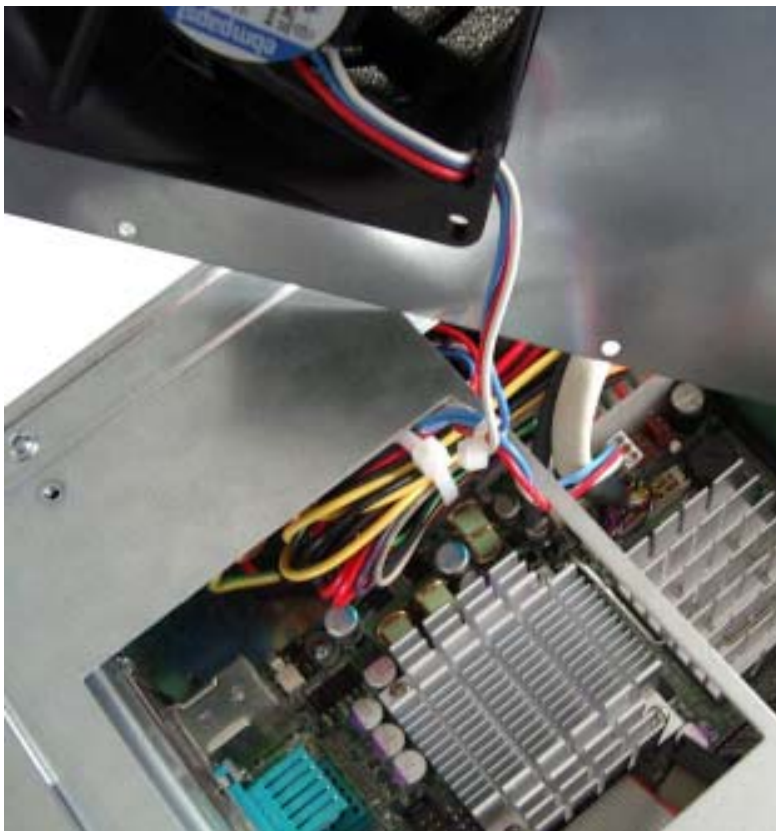

Remove the protective cover of the fan and remove the fan with a Phillips head screw driver.

After changing the fan, assemble the appliance in the reverse order.





## 4 Service

### 4.2 PCI-board installation

To install a PCI-board the right hand side part of the rear enclosure has to be removed.

To open the enclosure remove the marked screws with an Allen key



After removing 7 screws the enclosure can be lifted easily.

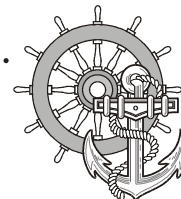

## 4 Service

A look at the opened appliance shows the 2 PCI-slots and the board holder.



Remove the slot cover of the desired slot to insert your PCI-board.



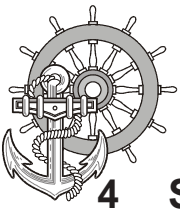

## 4 Service

Unscrew the board holder.



Insert your PCI-board.  
Please ensure a correct fit at the lower edge of the slot.



Screw your PCI-board tight.



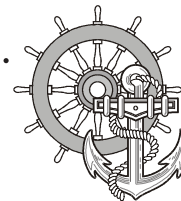

## 4 Service

Subsequently the board holder has to be re-fixed.



To ensure an optimal use of the board holder, we suggest that you put wide boards in the lower slots and narrow boards in the upper slots. Following picture shows this once more in detail.



The short support can be removed with boards of the same design. Otherwise the two supports can be individually adjusted.



## 4 Service

### 4.3 Memory expansion, -change

To change the memory board you have to remove the left hand part of the rear enclosure.

To open the enclosure remove the marked screws with an Allen key.



Then lift the enclosure and pull out the fan cable.

Please note the correct location of the cable prior to pulling the cable out so that it can be plugged in correctly.



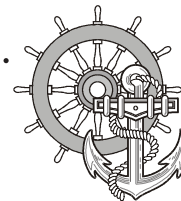

## 4 Service

Put the enclosure to one side and you have a free view of the slots.  
Pull out ribbon cable (see arrow) and move it to the top.



The picture shows a free and an occupied slot.  
If a memory expansion is carried out the memory module is positioned vertically and pushed in, the fixing brackets snap shut.





## 4 Service

If a memory board is changed then the holding brackets have to be pushed outwards simultaneously.



The memory board is now loose and can be removed. Locate the memory board vertically and push it down, the brackets snap shut

Bend back and plug in the ribbon cable.

Subsequently plug in the fan cable and reposition the enclosure.

Re-fix the enclosure.



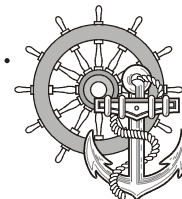

## 5 Technical data

### Technical datas for EPC PM 1700; 1900; 2100 Nautic; EPC PM Box Nautic

#### Computer Specifications

Processor	Intel Celeron M 1.3 GHz
Cache / PCI Clock	512MB Level 2 Cache / 400 MHz Bus
System Chipset	Intel 82855GME
BIOS	Award 2MBit Flash, Supports ACPI
PCI Slot	2x Short length, STD Profile, 32 Bit
Memory Slot	2x DDR-SDRAM (max 2GB)
Graphics Chip	Intel 82855GME (Integrated/250 MHz)
IDE Controller	1x IDE Ports, Ultra DMA33/66/100
IDE HDD	Automotive 20GB internal, 2.5" IDE
Parallel Port (LPT)	1x EPP/ECP Port
Ethernet	2x 10/100 Mbps
Serial Ports	3x RS232
USB Ports	4x USB (2.0 compliant, 480 Mbps)
Keyboard Ports	1x PS/2
Mouse Ports	1x PS/2
Audio Ports	Line In/Out, Mic In
Remote Controll	

#### Power Specifications

Power Supply Options	<ul style="list-style-type: none"> <li>• 24 VDC <math>\pm</math> 15%</li> <li>• 3A max (Inrush Current ca. 15A)</li> </ul> <p>or</p> <ul style="list-style-type: none"> <li>• 110-230 VAC <math>\pm</math> 15%</li> <li>• 1A max (Inrush Current &gt; 30A)</li> </ul>
Power Consumption	<p>Operating : 60W (max) (Configuration depending)</p> <p>or</p> <p>Operating : 100W (max) (Configuration depending)</p>

#### General Specifications

External dimensions (W x H x D)	EPC PM Box Nautic:	389 x 276 x 114 mm
	EPC PM 1700 Nautic:	430 x 390 x 145 mm
	EPC PM 1900 Nautic:	483,2 x 444 x 145 mm
	EPC PM 2100 Nautic:	534 x 481 x 144 mm
Weight	EPC PM Box Nautic:	5,5 kg
	EPC PM 1700 Nautic:	10,7 kg
	EPC PM 1900 Nautic:	13,0 kg
	EPC PM 2100 Nautic:	18,5 kg
Protection type	EPC PM Box Nautic:	IP 20 all sides
	EPC PM 1700/1900/2100 Nautic:	IP 54 Front side; IP 20 Back side
Approvals	GL, ABS, DNV, BV, LR,	Prepared for IEC 60945

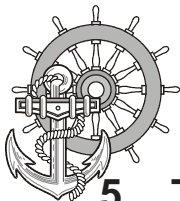

## 5 Technical data

### Environmental Considerations

---

Operating	Temperature 0° C to +55° C Humidity 30% to 90% (non condensing)
Storage	Temperature -20° C to +70° C Humidity 10% to 90% (non condensing)

### Technical data TFT Display

#### TFT Technology

---

17.0 inch viewable image size  
 19.0 inch viewable image size  
 Active Matrix, Thin Film Transistor (TFT)  
 PVA™ Technology  
 21.3 inch viewable image size  
 Active Matrix, Thin Film Transistor (TFT)  
 SPVA™ Technology

#### TFT Characteristics

---

Pixel number	17": 1280 x 1024 19": 1600 x 1200
Pixel Pitch (RGB)	17": 0,264 (H) x 0,264 (V) mm 19": 0,294 (H) x 0,294 (V) mm 21": 0,270 (H) x 0,270 (V) mm
Response Time	17"; 19": 15 ms (typical), "black" to "white" 21": 16 ms (typical), "black" to "white" to "white"
Contrast Ratio	17": 600:1 19"; 21": 1000:1
Light Intensity	17"; 19": 250cd/m <sup>2</sup> (typical) 21": 300cd/m <sup>2</sup> (typical)
Viewable Angle	± 89° (typical) (Up/Down/Left/Right)
Active Display Area	17": 337.92 (H) x 270.34 (V) mm 19": 376.32 (H) x 301.056 (V) mm 21": 432 (H) x 324 (V) mm
Max Colors	16.7 millions

#### Supported Signal Inputs

---

Resolutions	
VGA	640 x 480 (including 640 x 350)
SVGA	800 x 600 (including 720 x 400)
XGA	1024 x 768
SXGA	1280 x 1024*
UXGA	1600 x 1200

\*Recommended for optimum picture quality

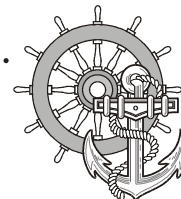

## 5 Technical data

### 5.1 Detailed drawings

#### 5.1.1 EPC PM 1700 Nautic

frontal view

overall measurement: 430,0 x 390,0 mm

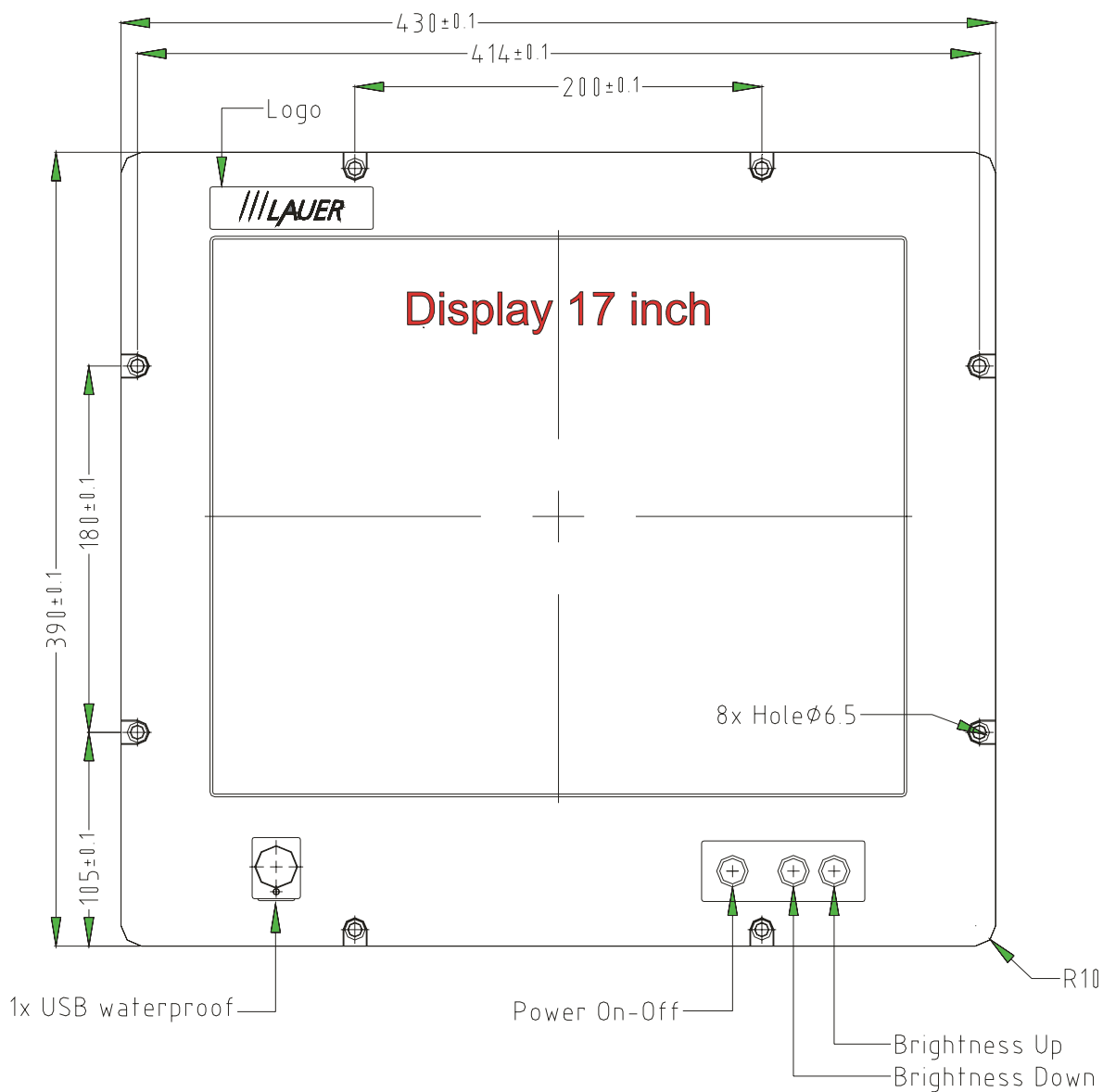

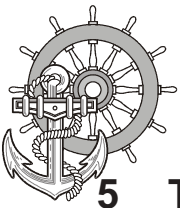

## 5 Technical data

Front panel assembly aperture  
Aperture size: 396,0 x 264,0 mm

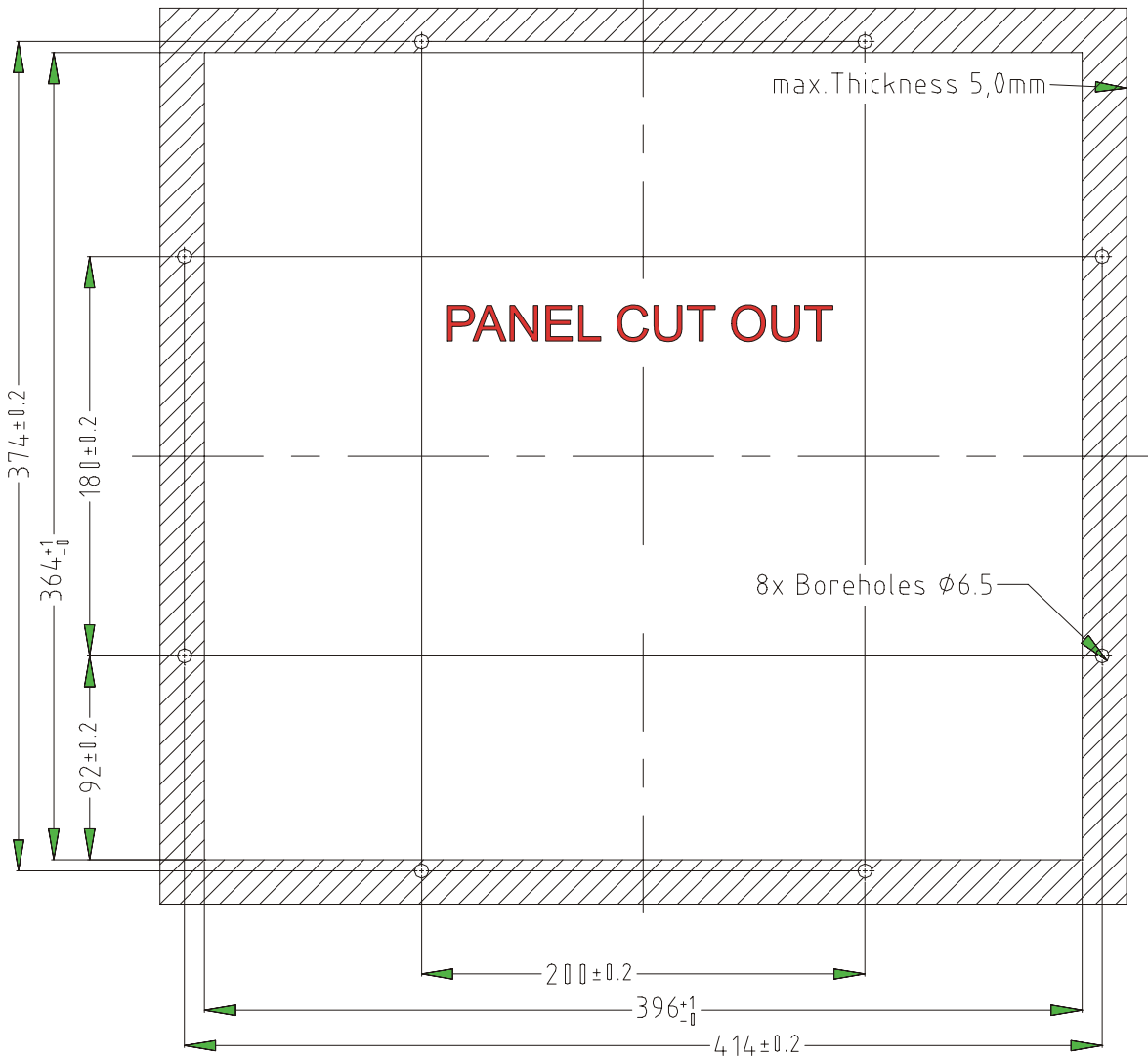

Fixing with 8 off M6 x 25.screws. Max. 5 mm thick mounting frame

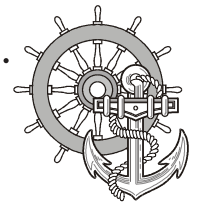

## 5 Technical data

24V

view of the appliance's underneath

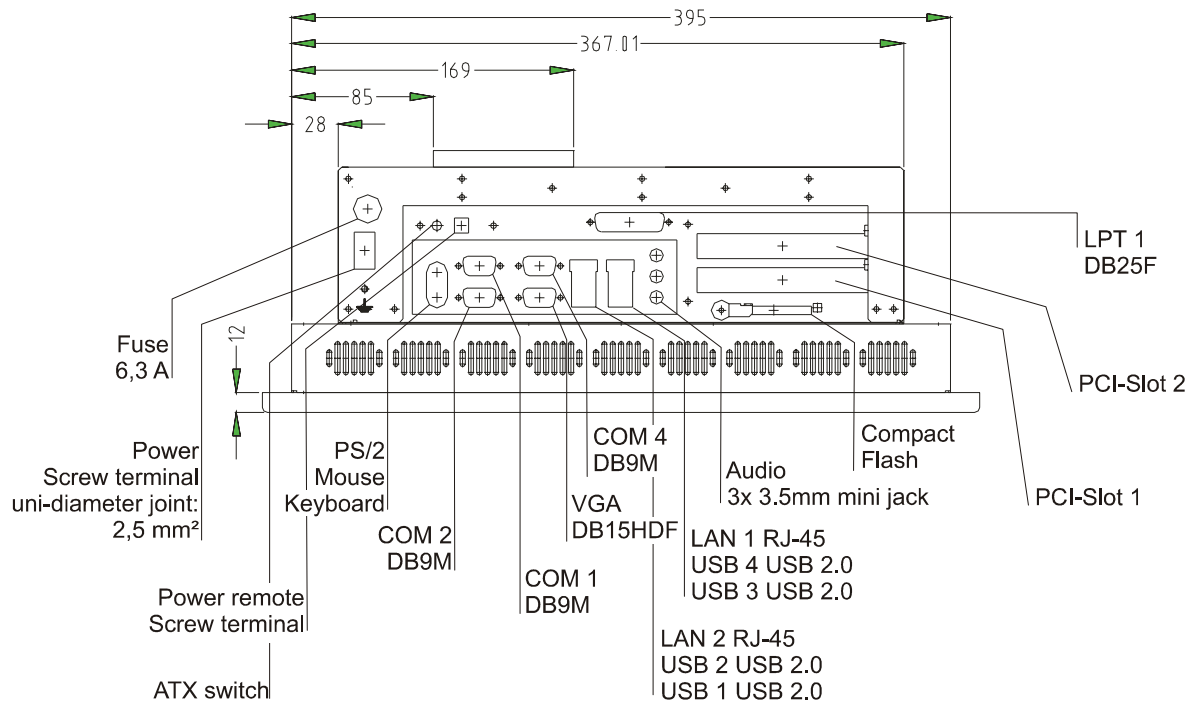

230V

view of the appliance's underneath

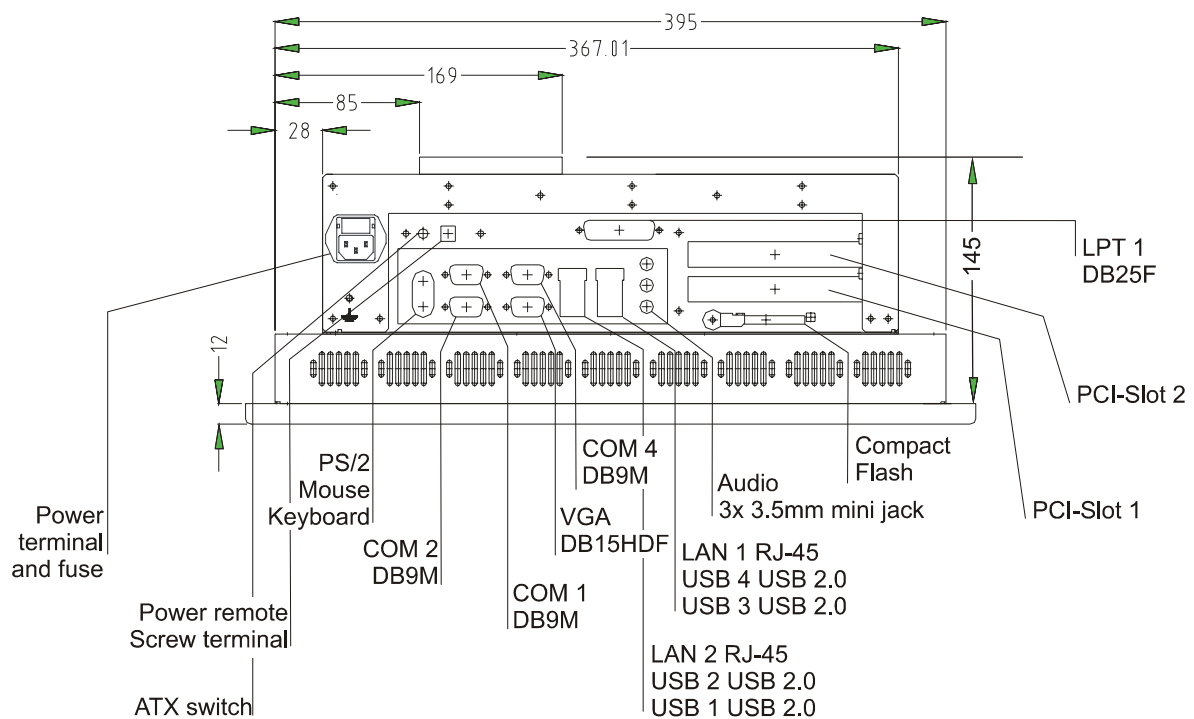



## 5 Technical data

Rear view of the appliance

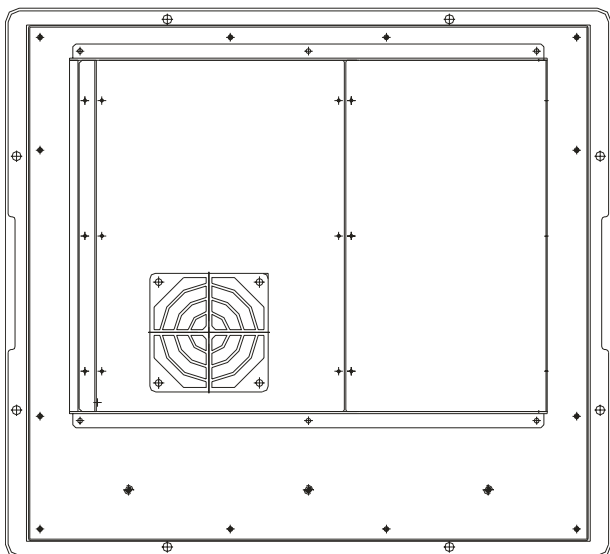

lateral view

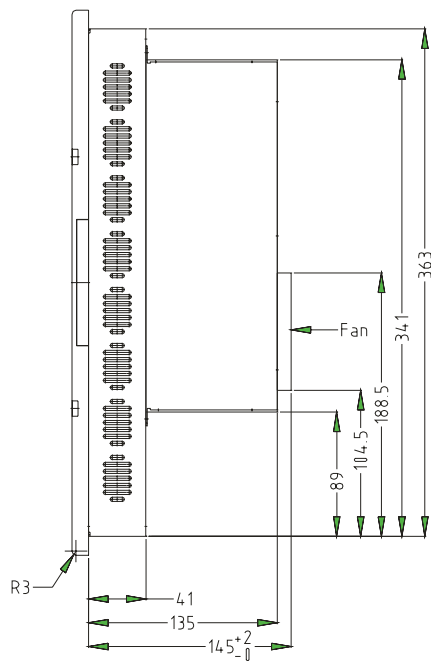

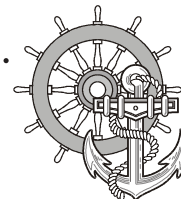

## 5 Technical data

### 5.1.2 EPC PM 1900 Nautic

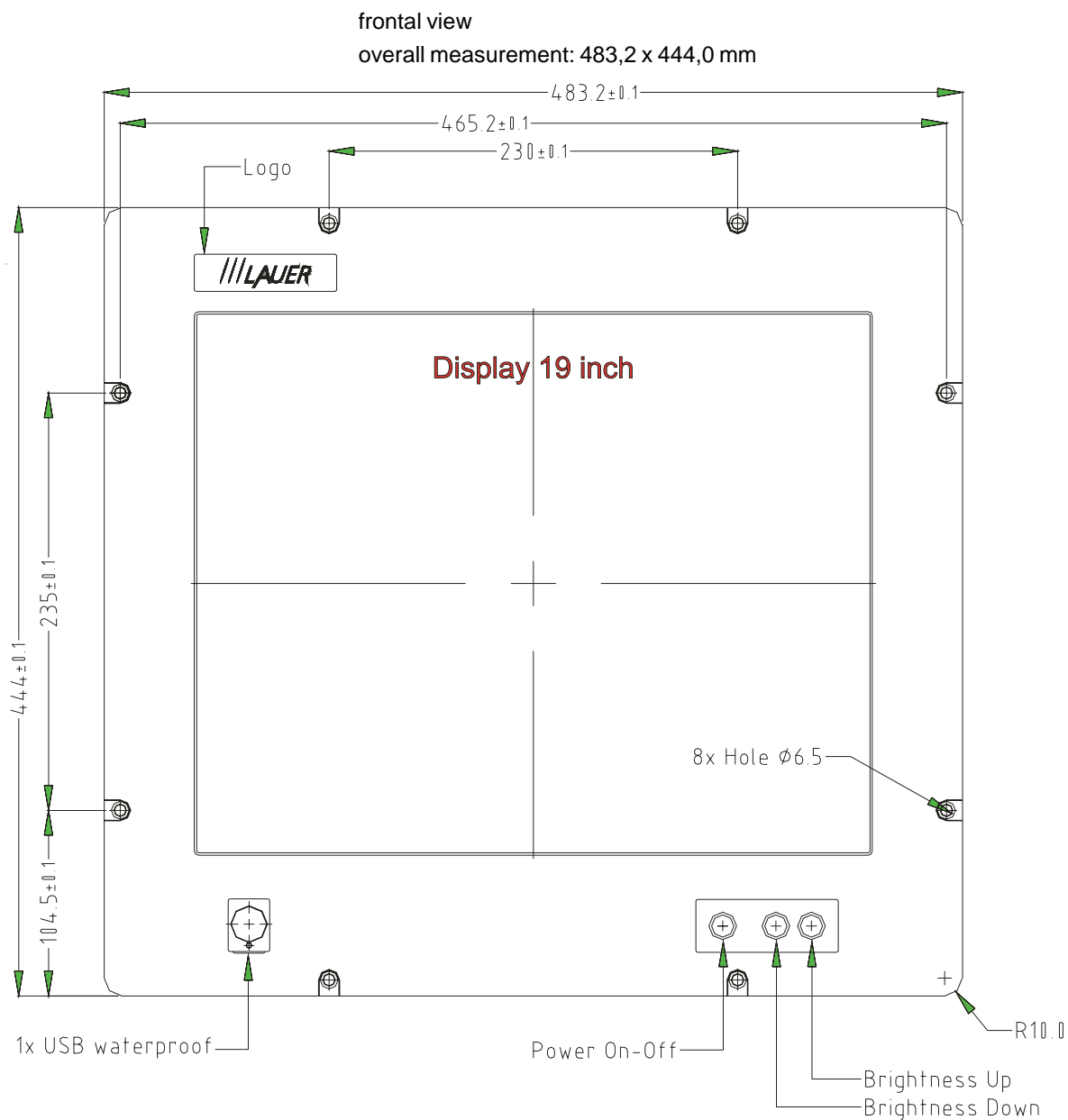

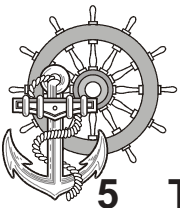

## 5 Technical data

Front panel assembly aperture  
Aperture size: 466,0 x 416,0 mm

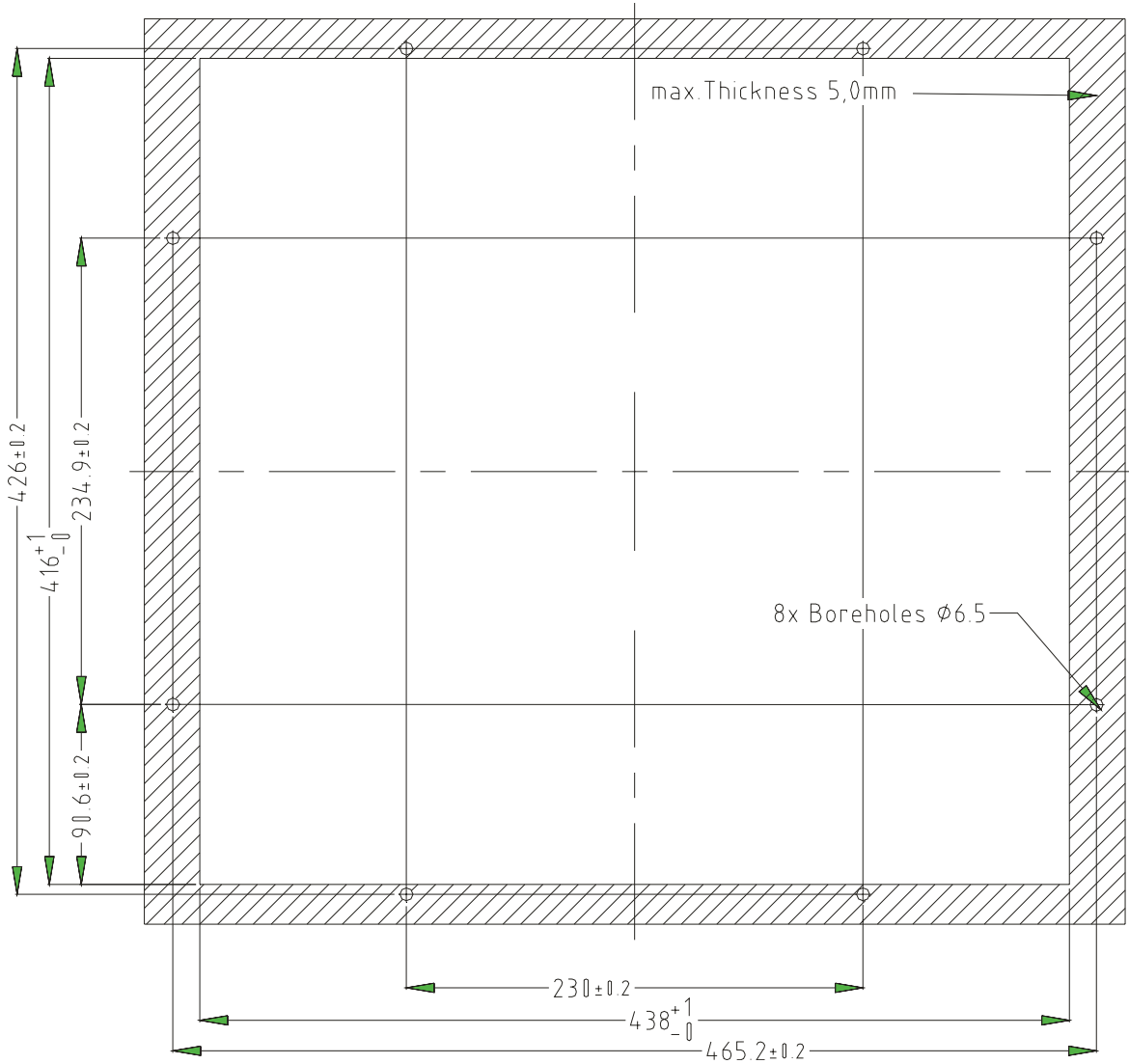

Fixing with 8 off M6 x 25.screws. Max. 5 mm thick mounting frame



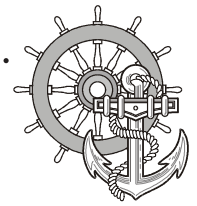

## 5 Technical data

24V

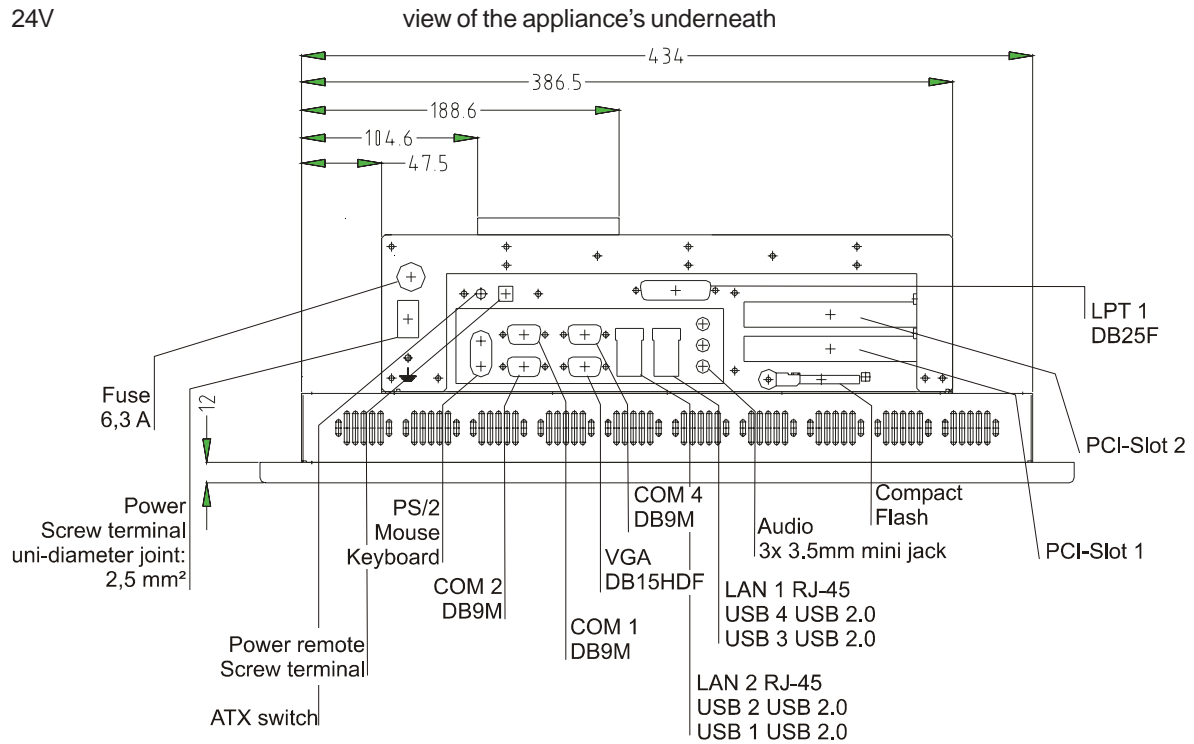

230V

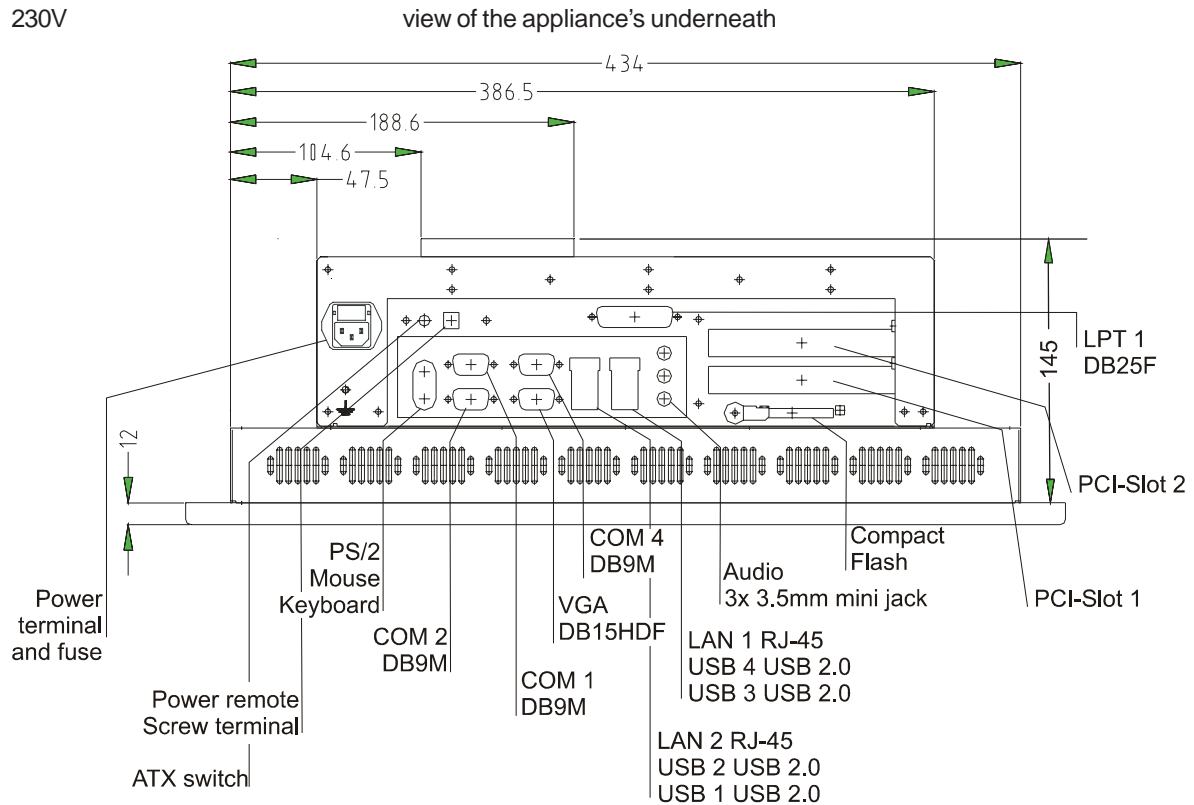



## 5 Technical data

Rear view of the appliance

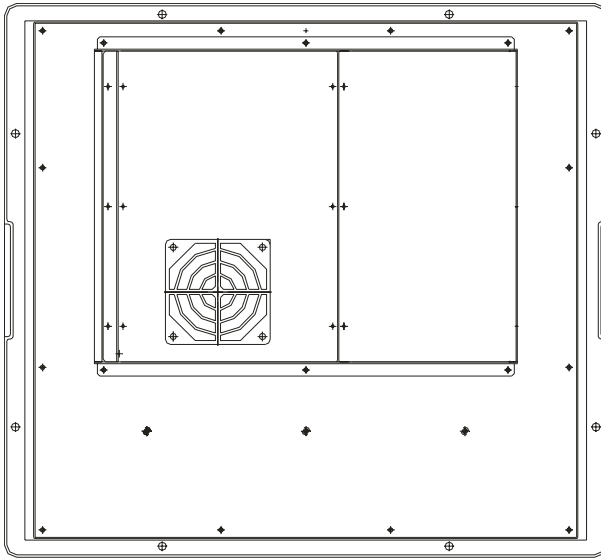

lateral view

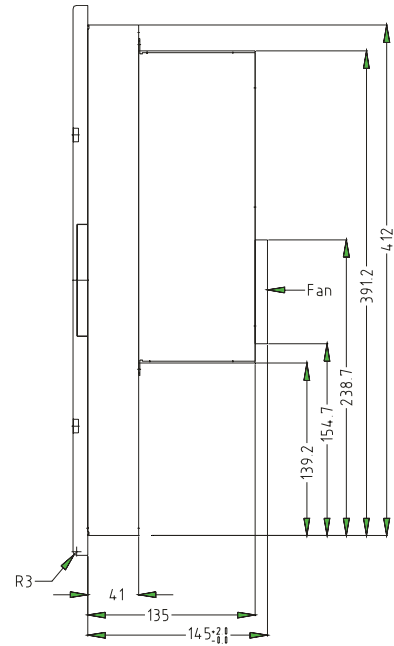

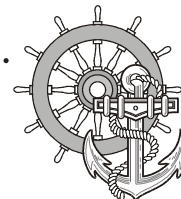

## 5 Technical data

### 5.1.3 EPC PM2100 Nautic

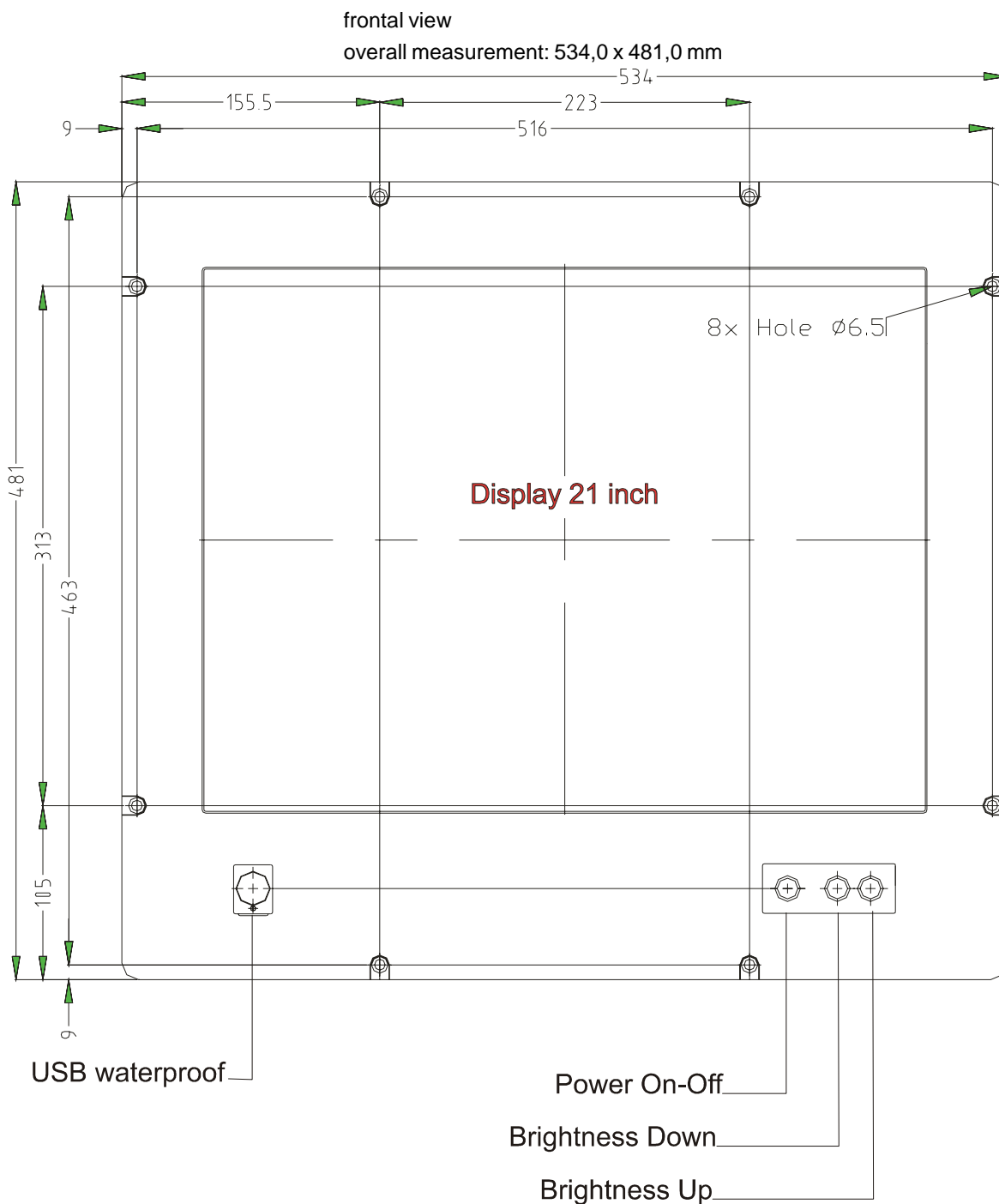

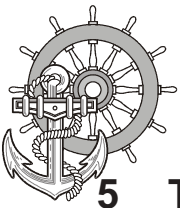

## 5 Technical data

Front panel assembly aperture  
Aperture size: 500,0 x 443,0 mm

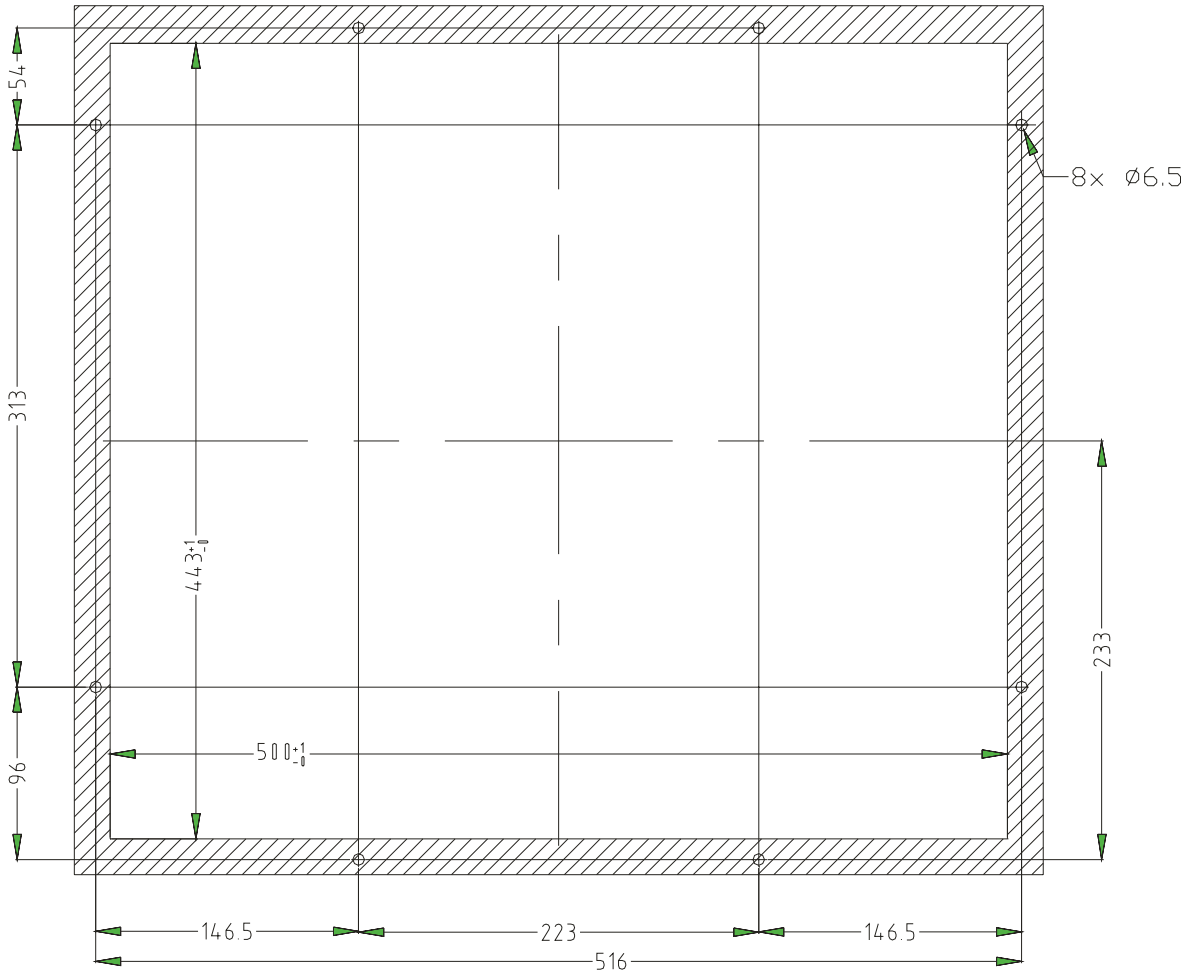

Fixing with 4 off M6 x 25 screws. Max. 5 mm thick mounting frame

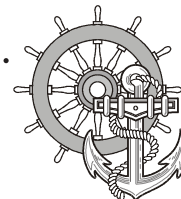

## 5 Technical data

24V DC

view of the appliance's underneath

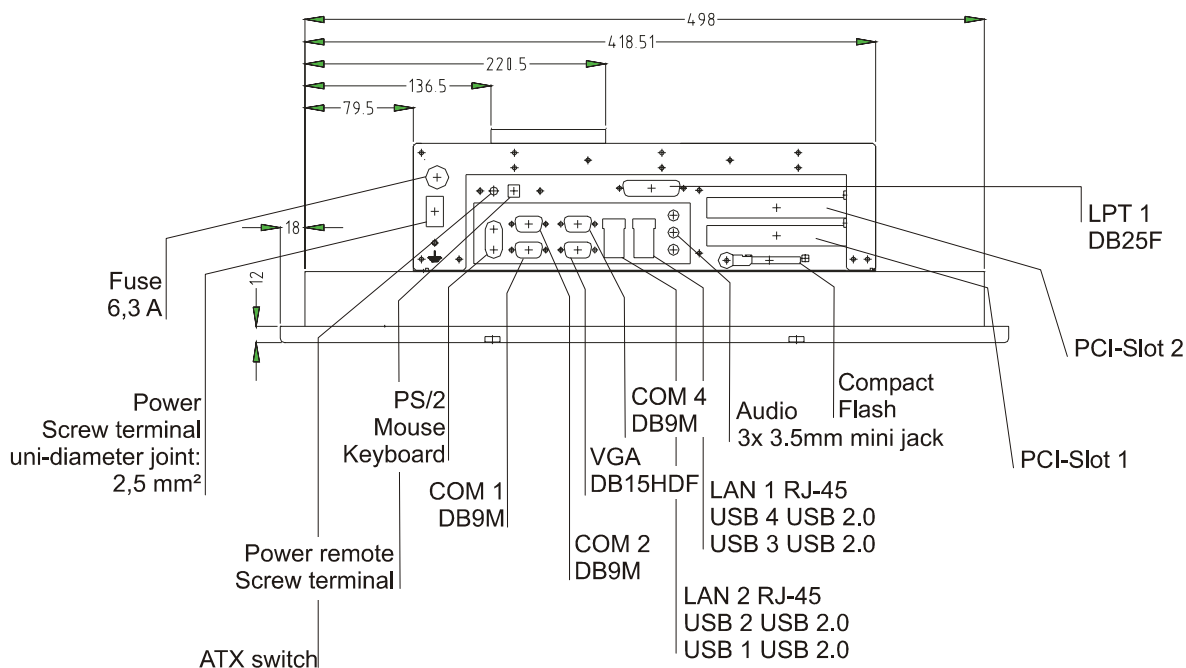

23V0 AC

view of the appliance's underneath

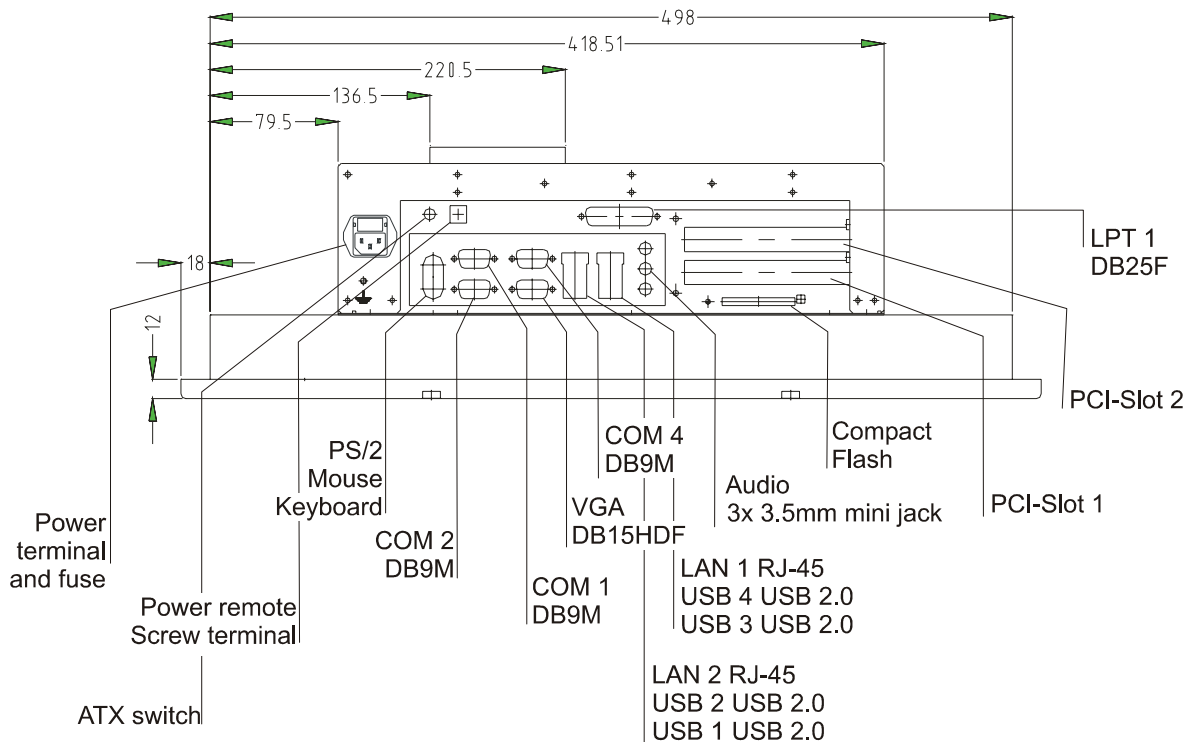

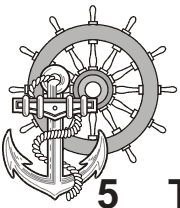

## 5 Technical data

Appliance's rear view

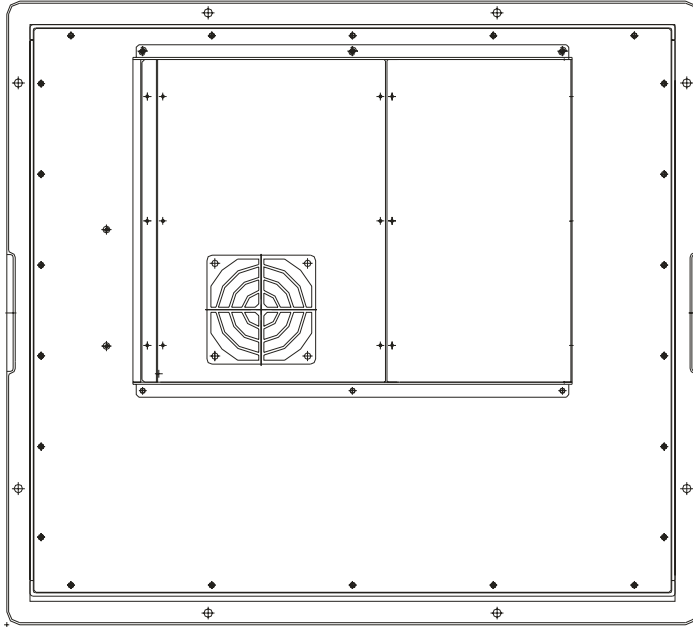

lateral view

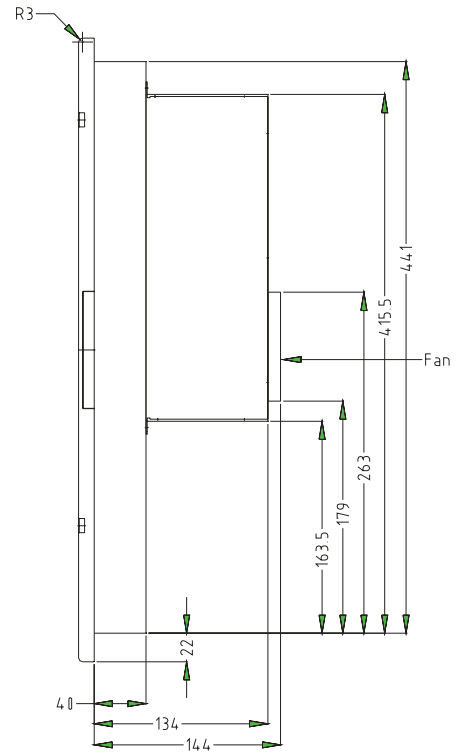

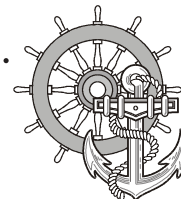

## 5 Technical data

### 5.1.4 MT 217 Nautic

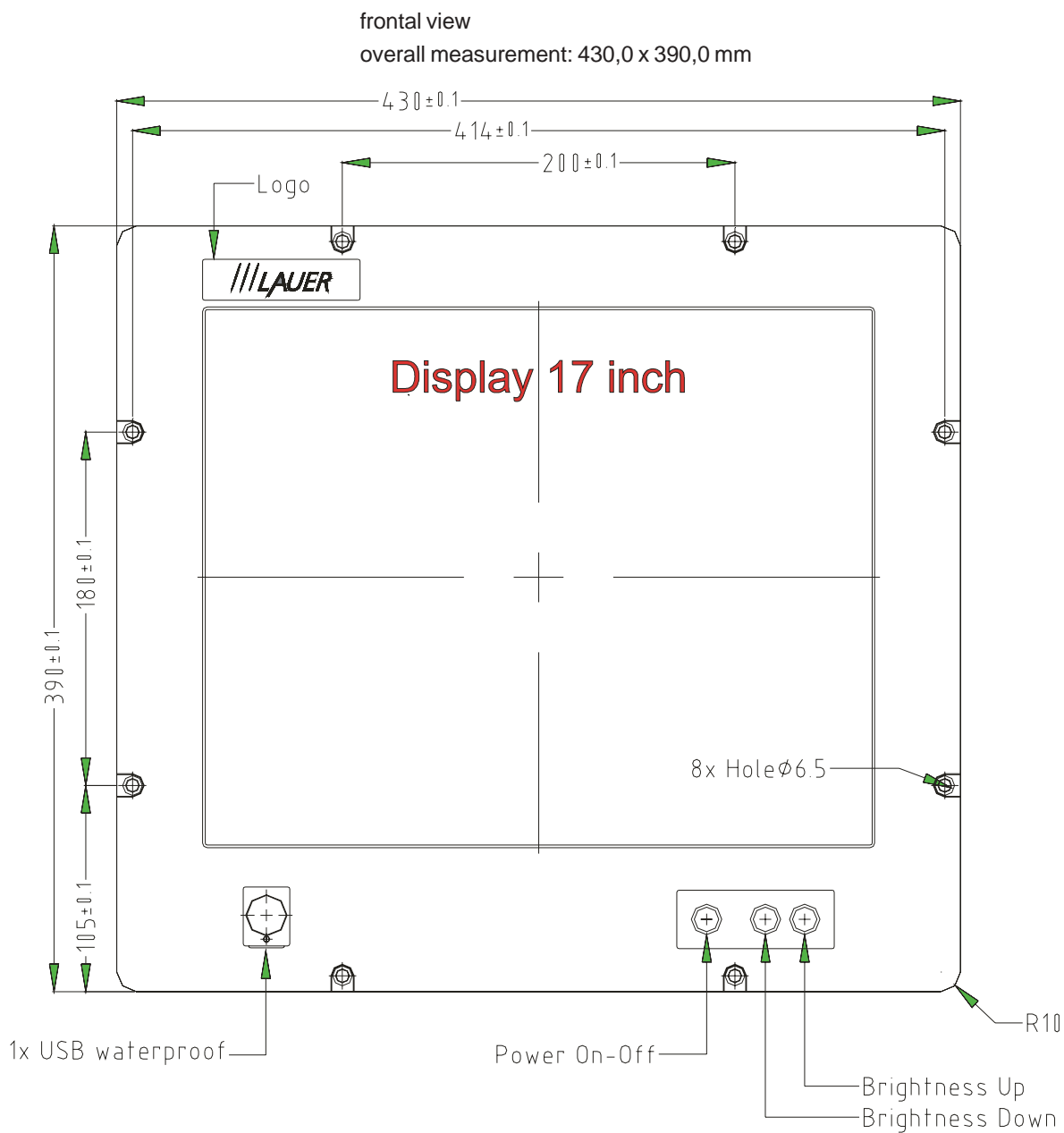

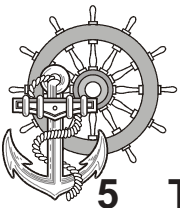

## 5 Technical data

Front panel assembly aperture  
Aperture size: 396,0 x 364,0 mm

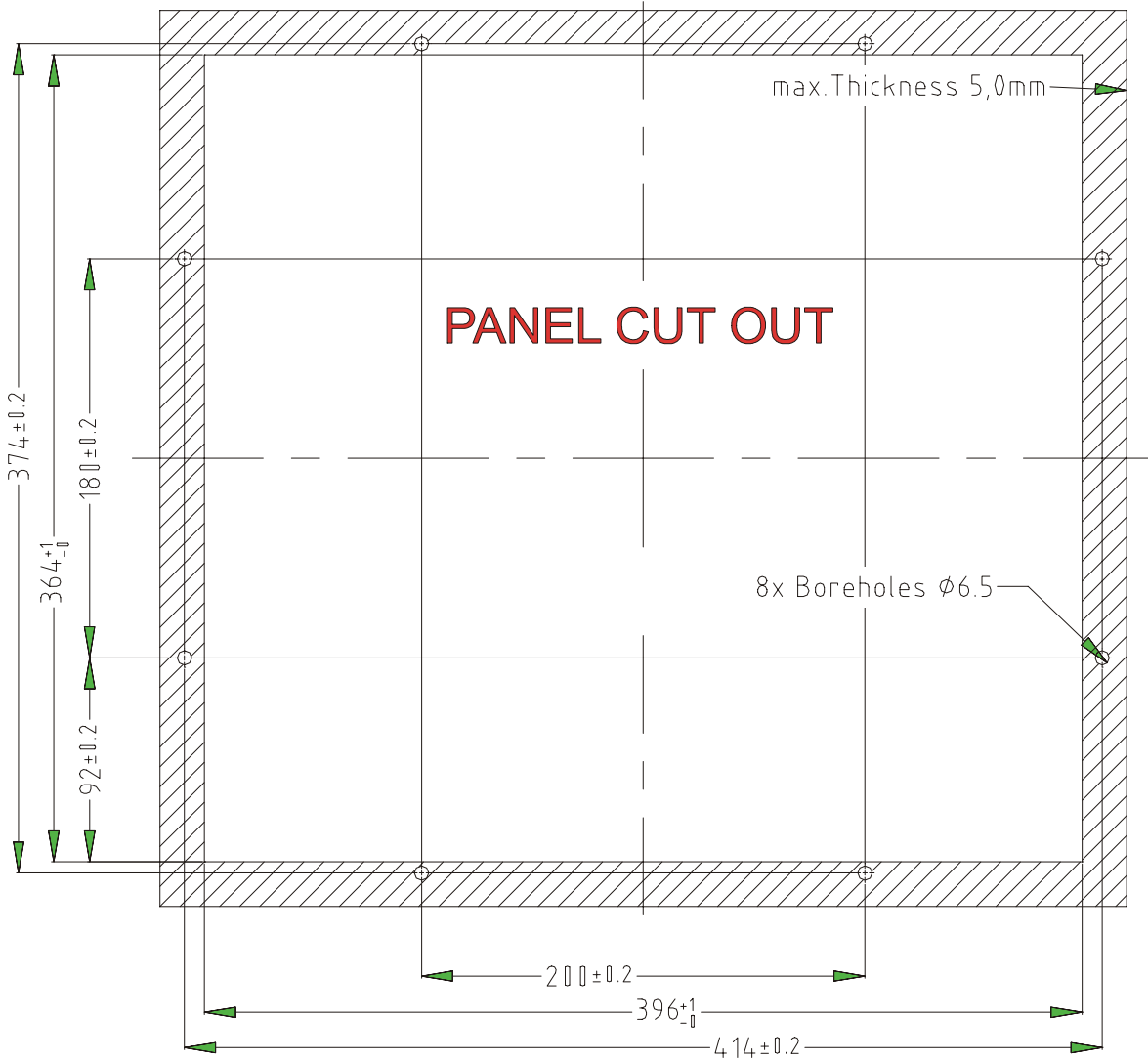

Fixing with 8 off M6 x 25.screws. Max. 5 mm thick mounting frame



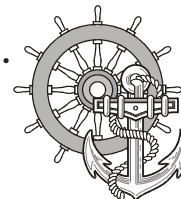

## 5 Technical data

24V-Monitor

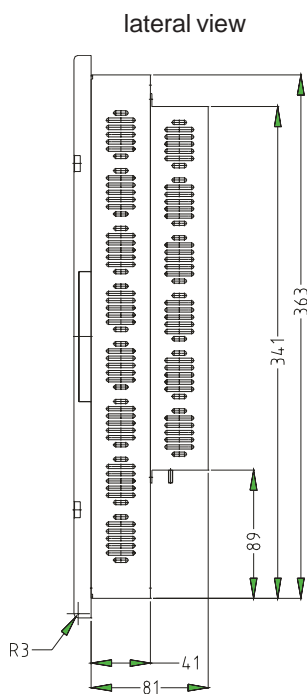
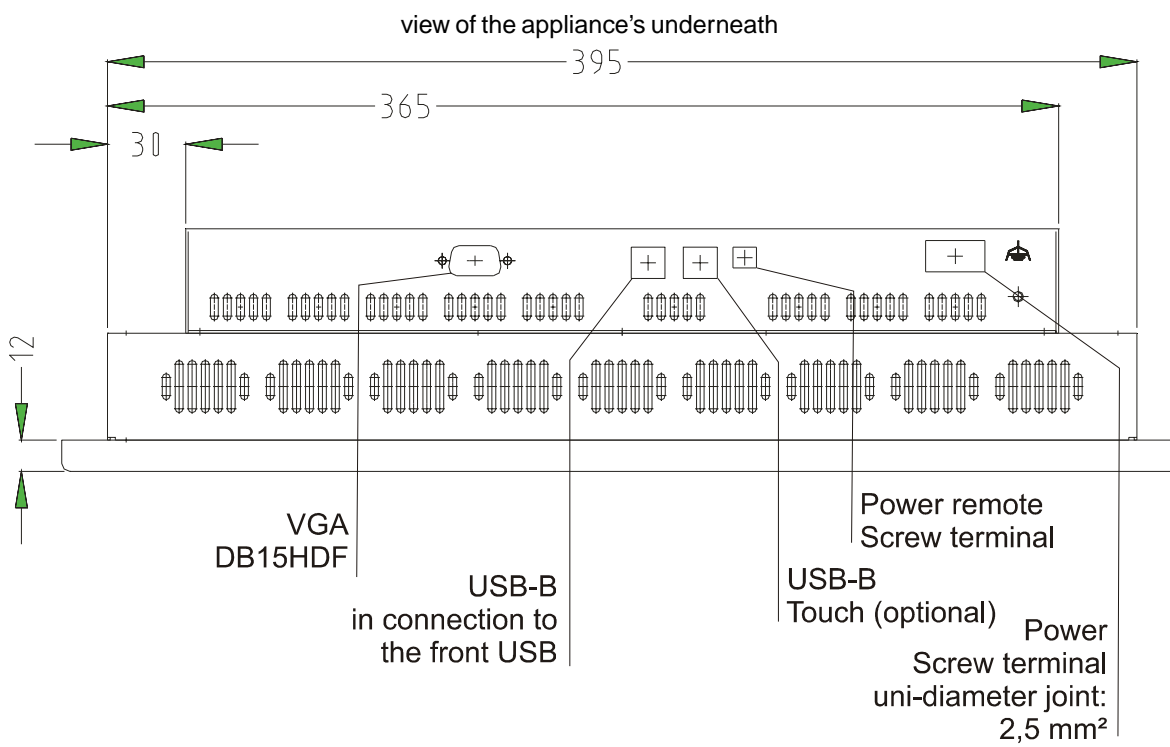

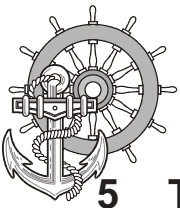

## 5 Technical data

230V-Monitor

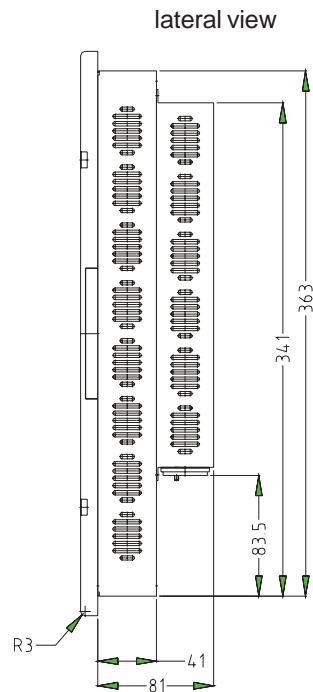
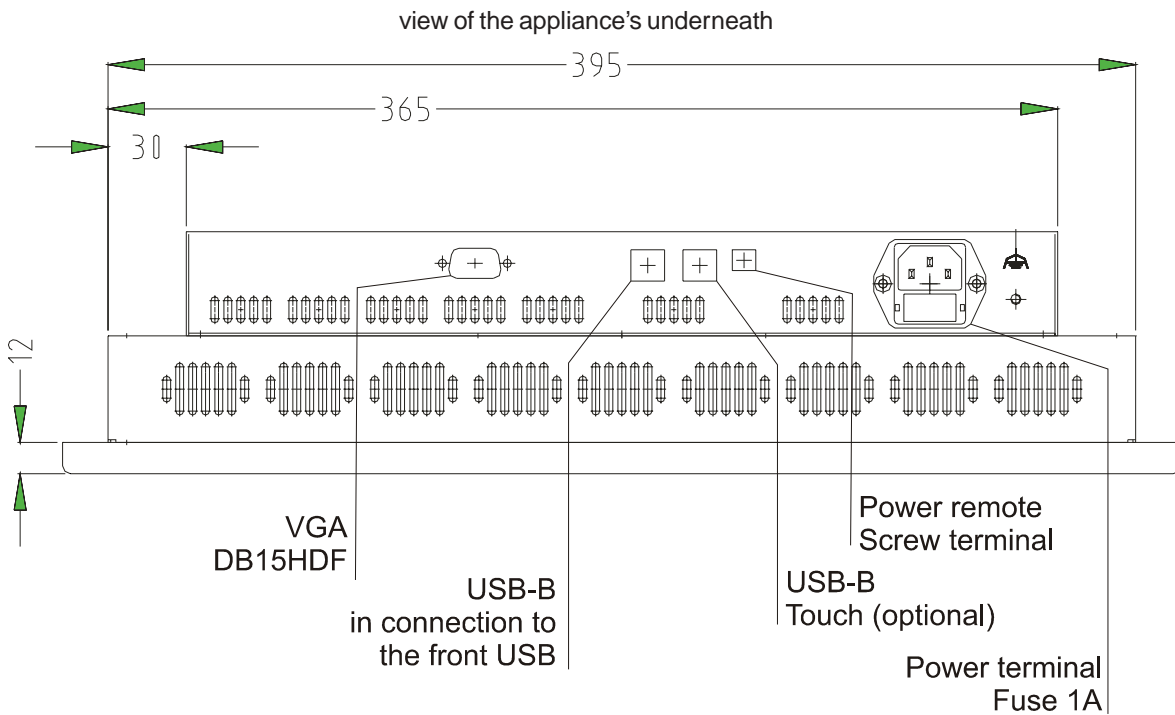

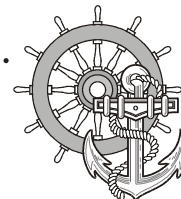

## 5 Technical data

### 5.1.5 MT 219 Nautic

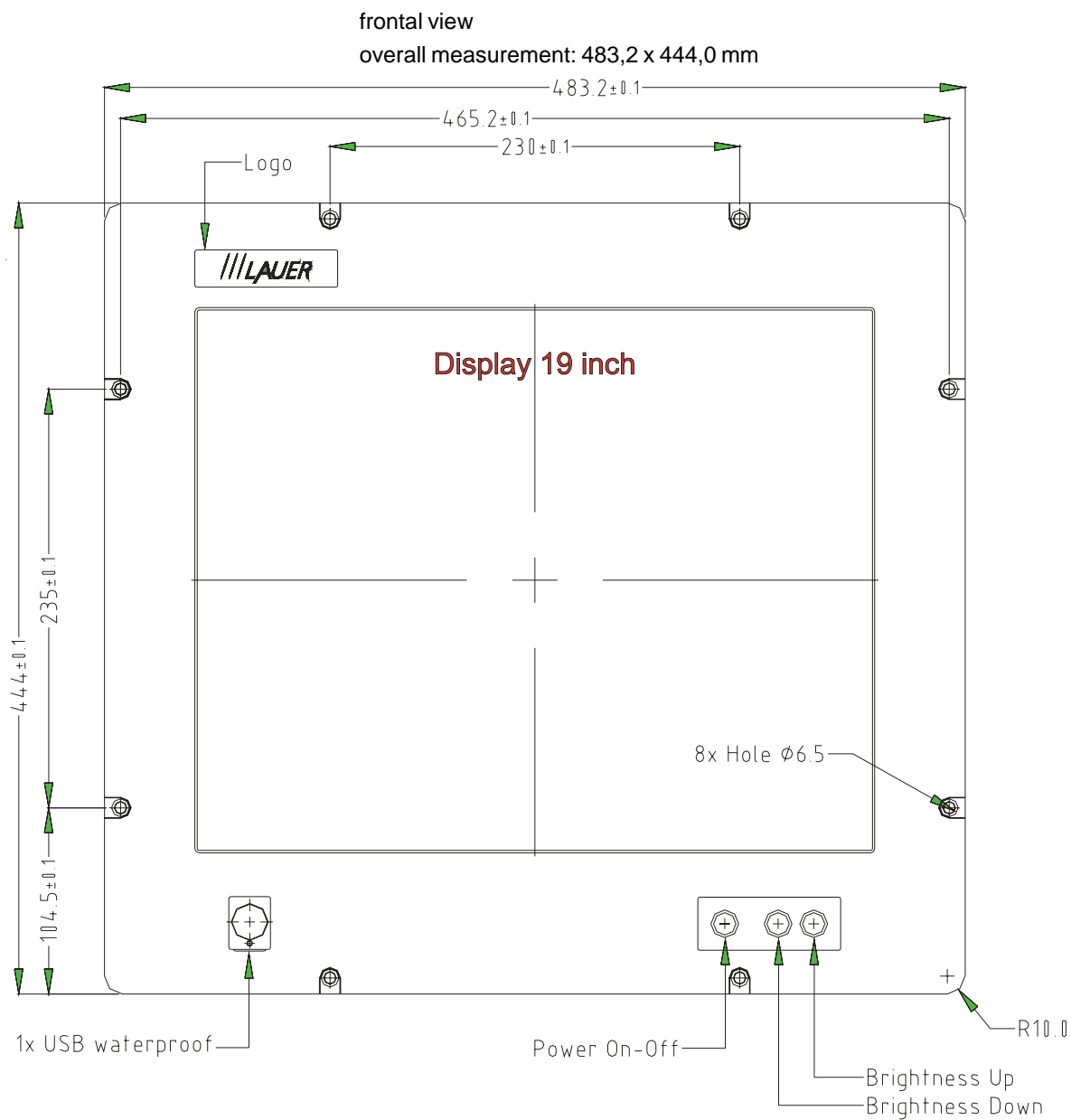

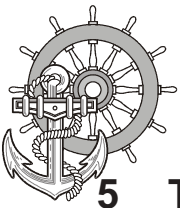

## 5 Technical data

Front panel assembly aperture  
Aperture size: 438,0 x 416,0 mm

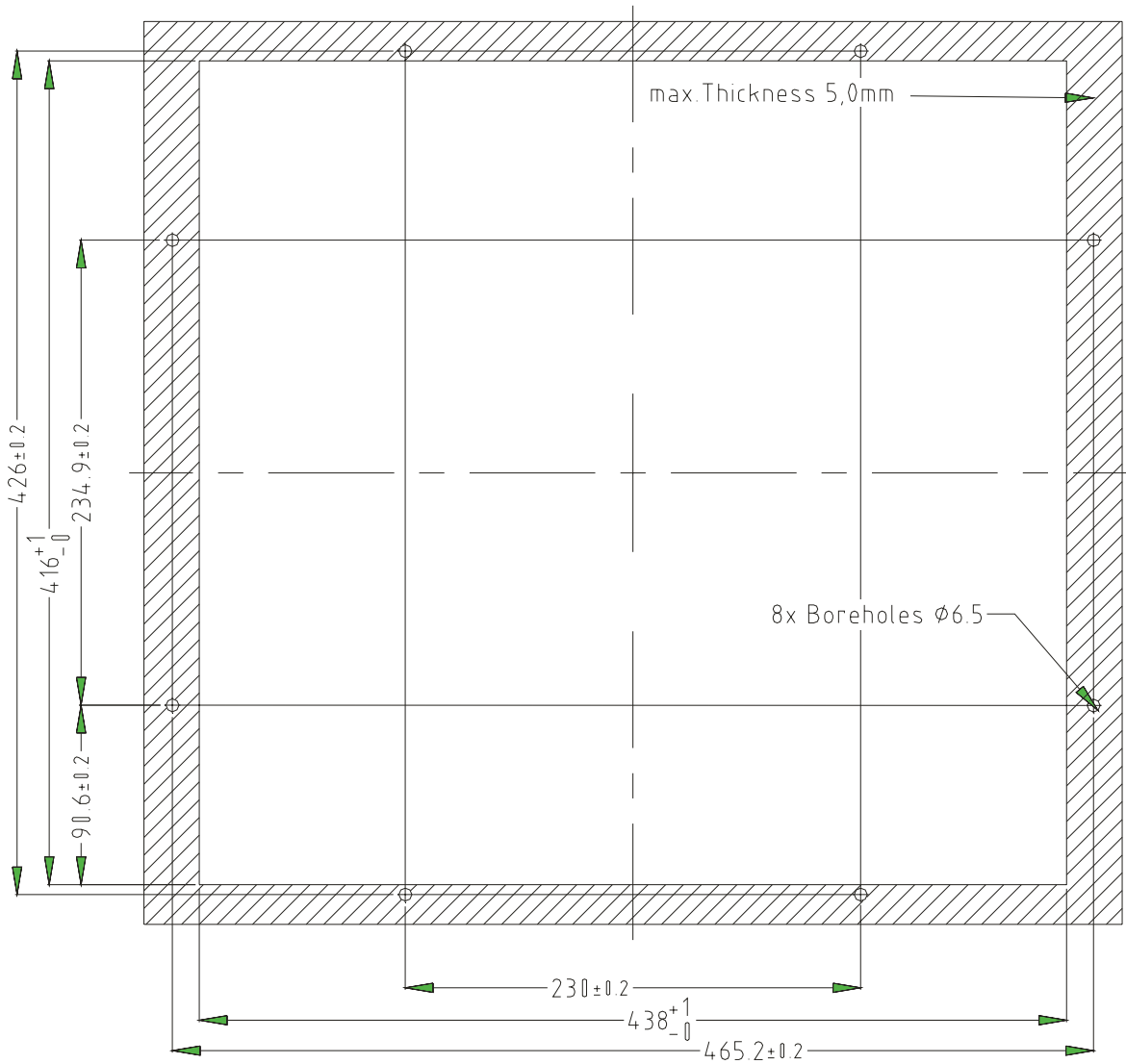

Fixing with 4 off M8 x 25.screws. Max. 5 mm thick mounting frame

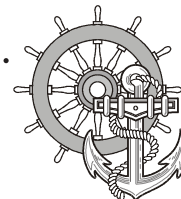

## 5 Technical data

24V-Monitor

view of the appliance's underneath

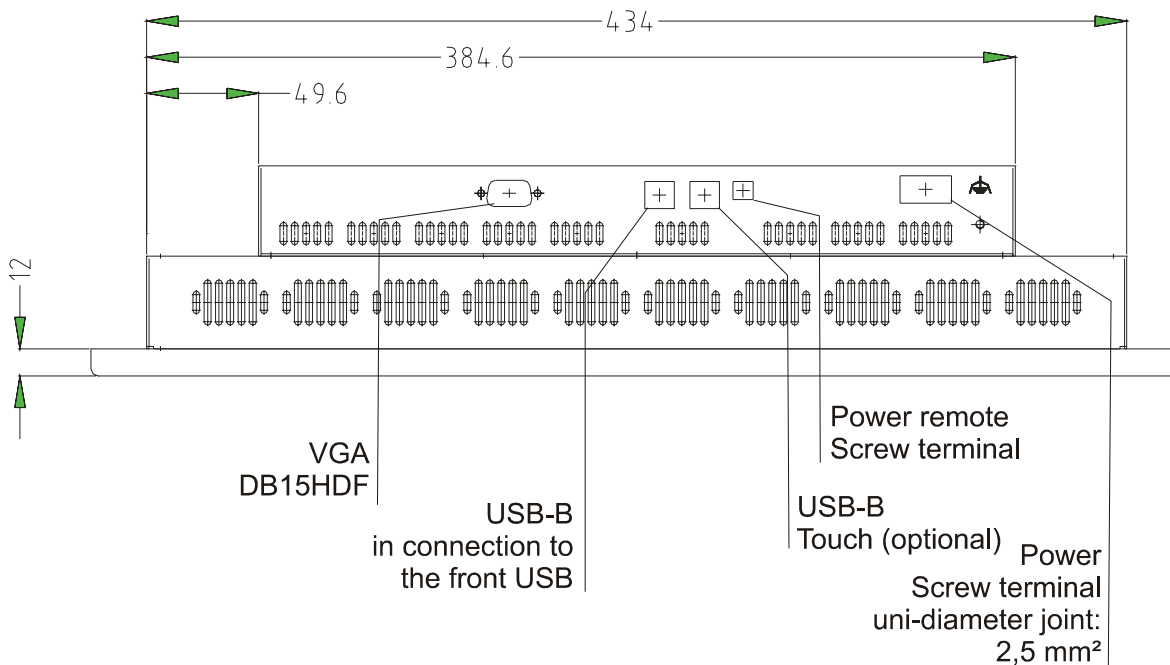

lateral view

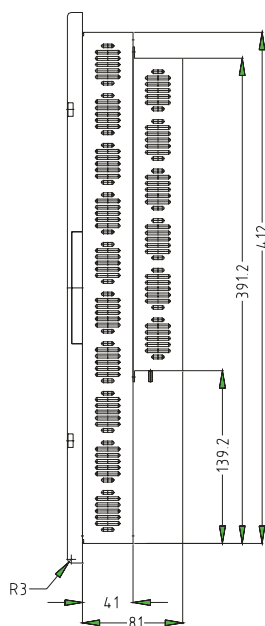

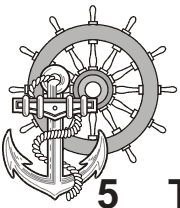

## 5 Technical data

230V-Monitor

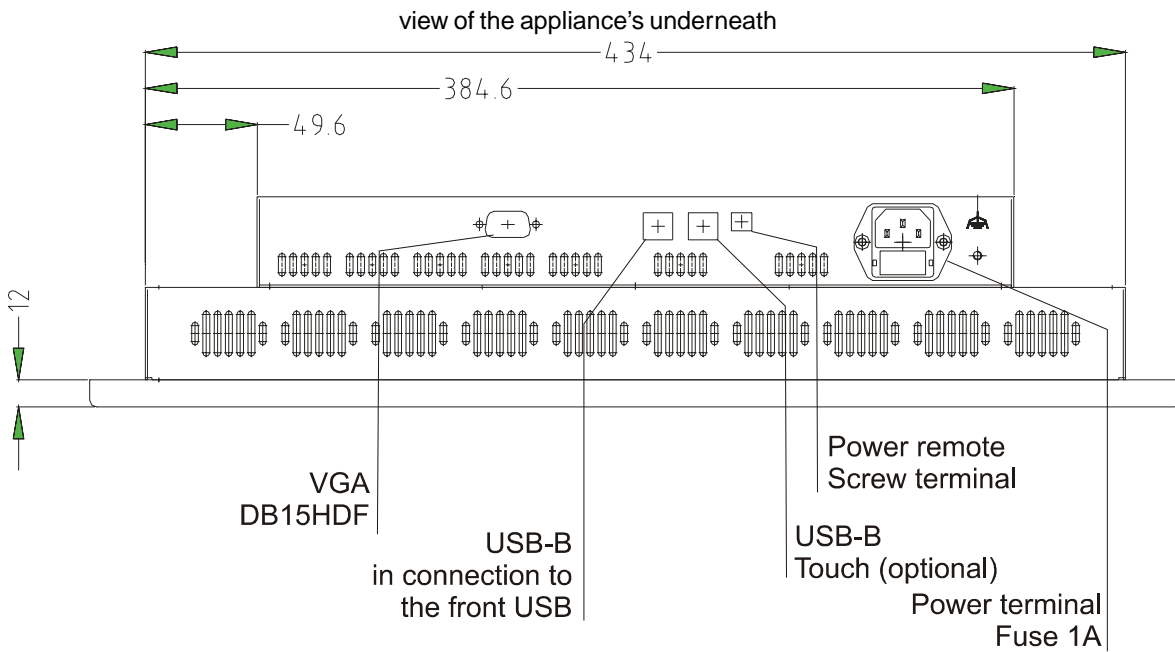

lateral view

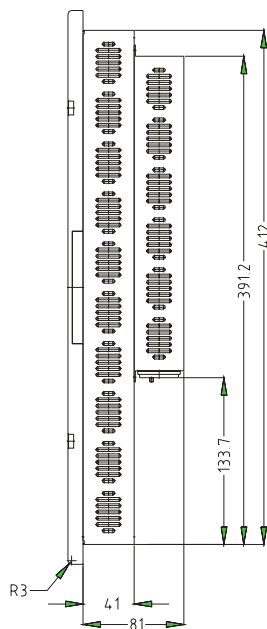

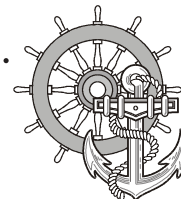

## 5 Technical data

### 5.1.6 MT 221 Nautic

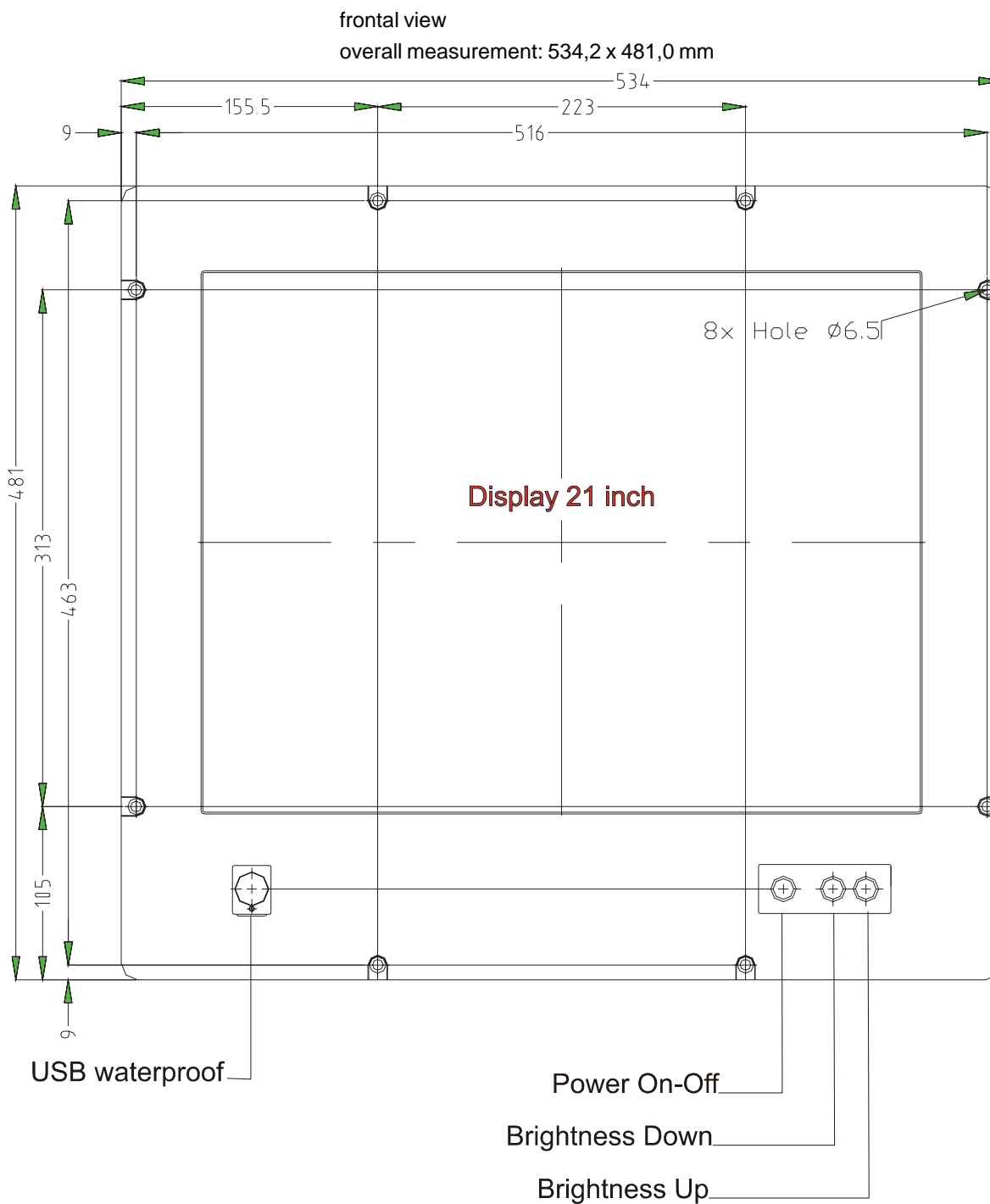

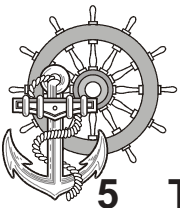

## 5 Technical data

Front panel assembly aperture  
Aperture size: 500,0 x 443,0 mm

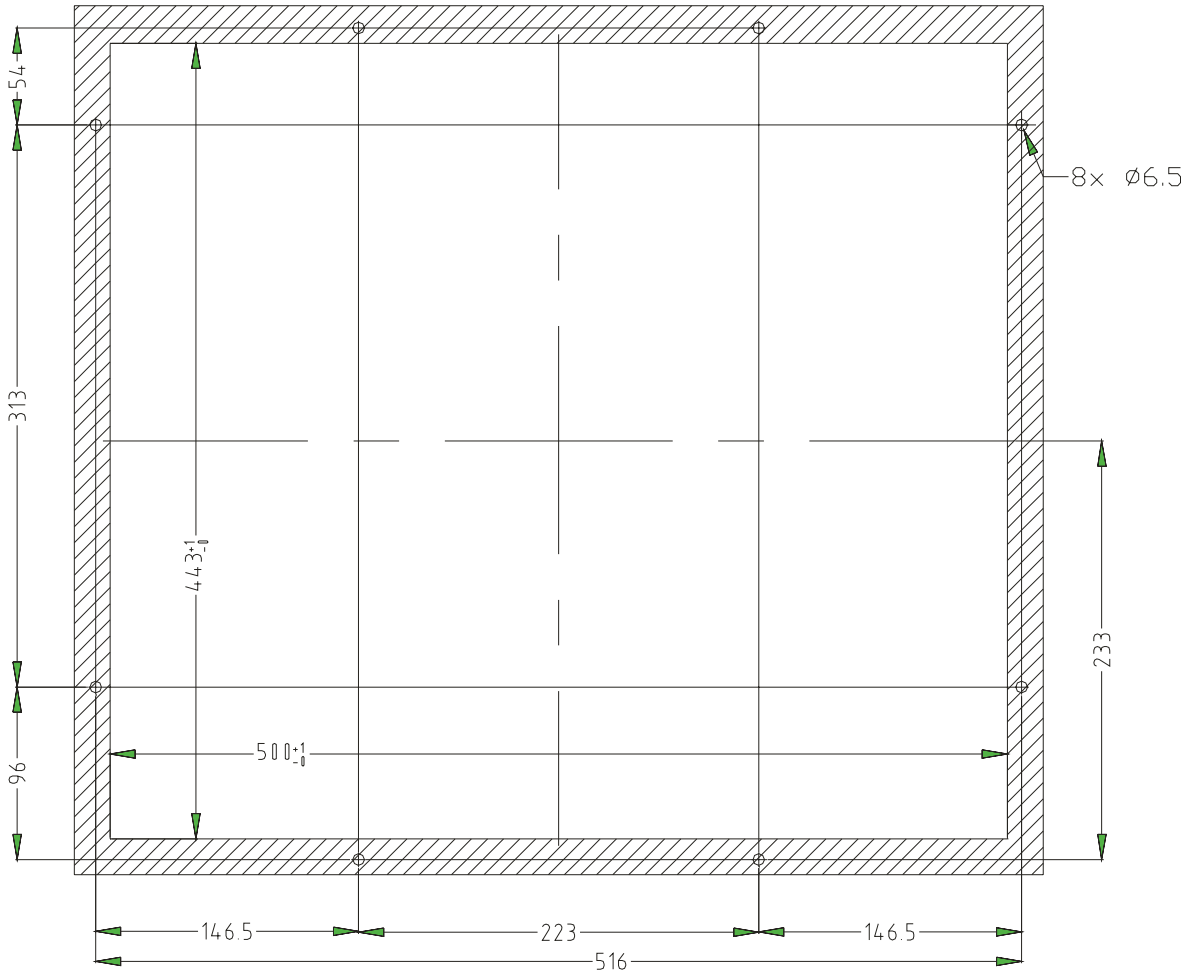

Fixing with 8 off M6 x 25.screws. Max. 5 mm thick mounting frame



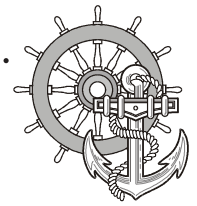

## 5 Technical data

24V-Monitor

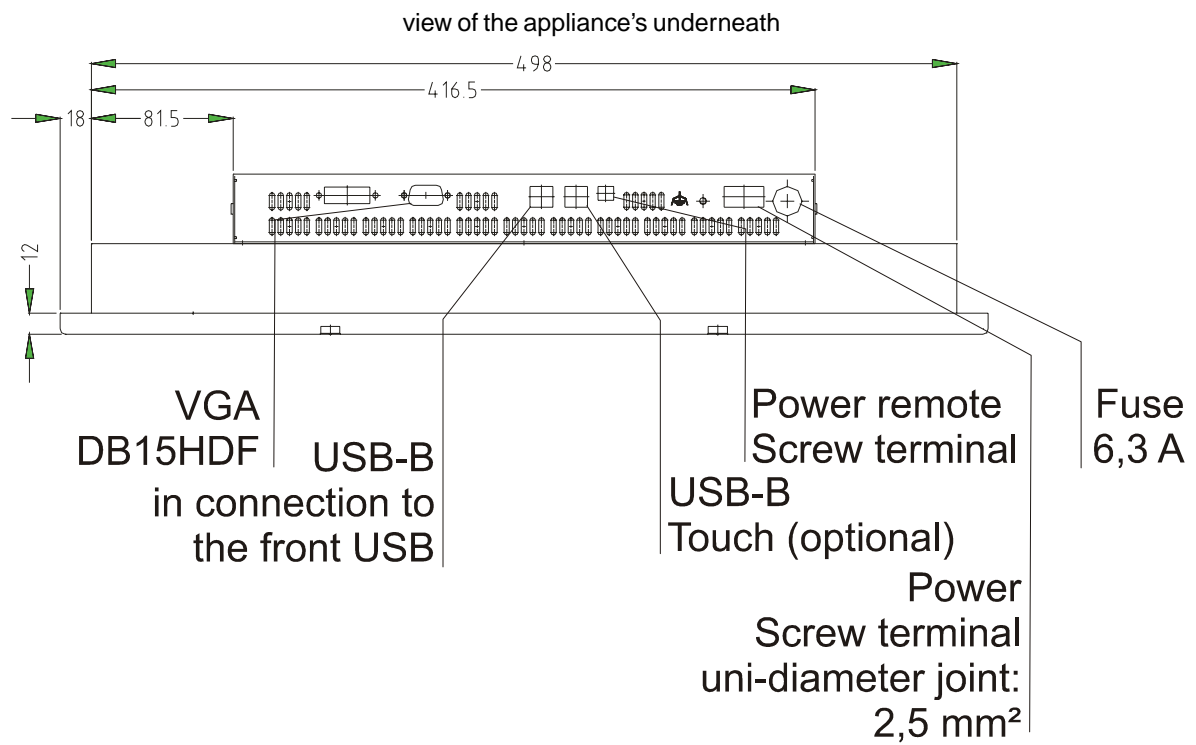

Appliance's rear view

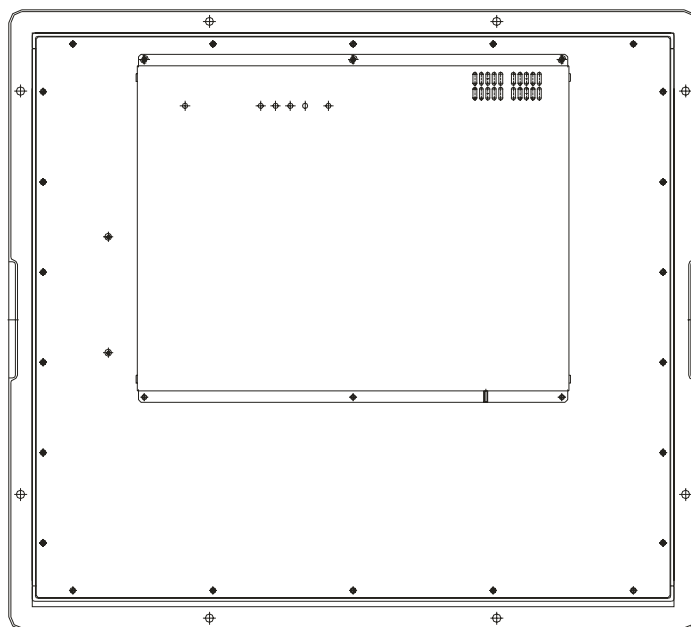

lateral view

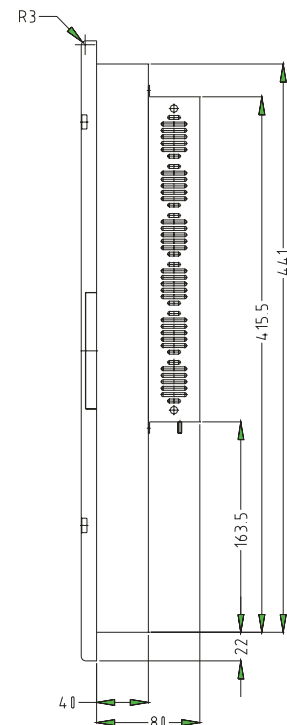

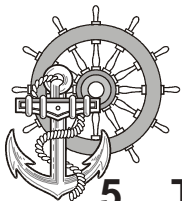

## 5 Technical data

230V-Monitor

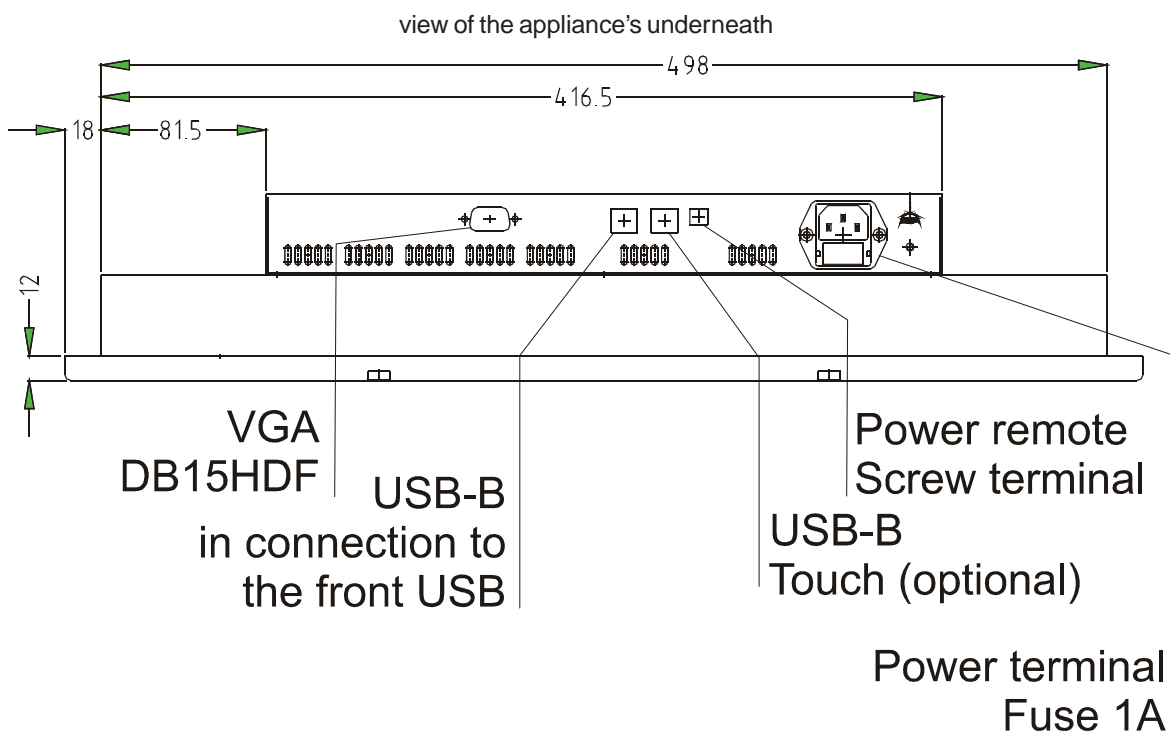

Appliance's rear view

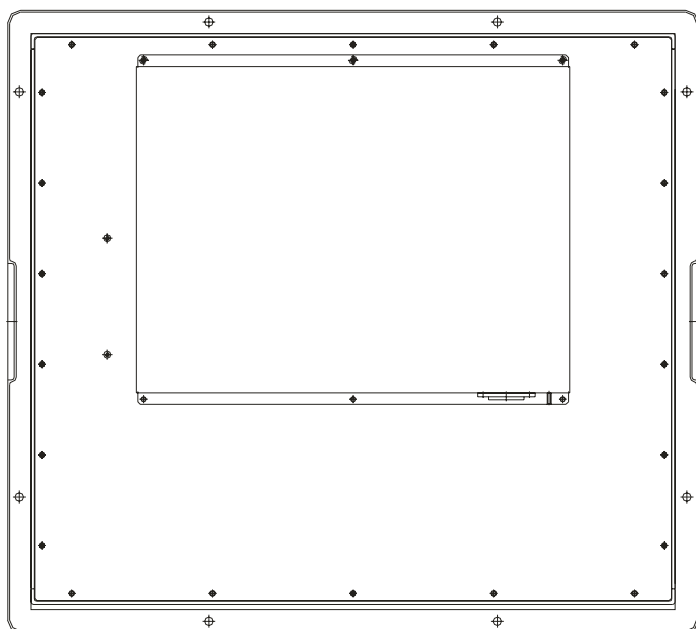

lateral view

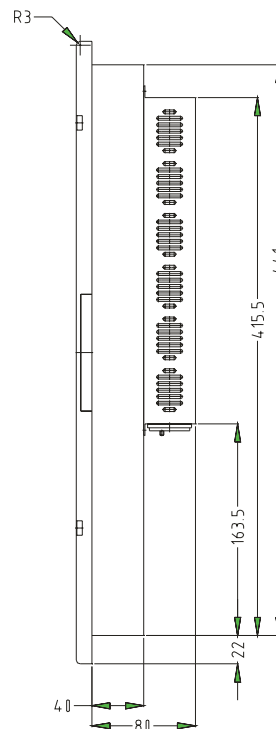

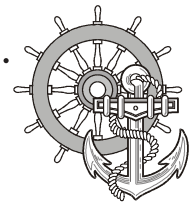

## 5 Technical data

### 5.1.7 EPC PM Box Nautic

24V

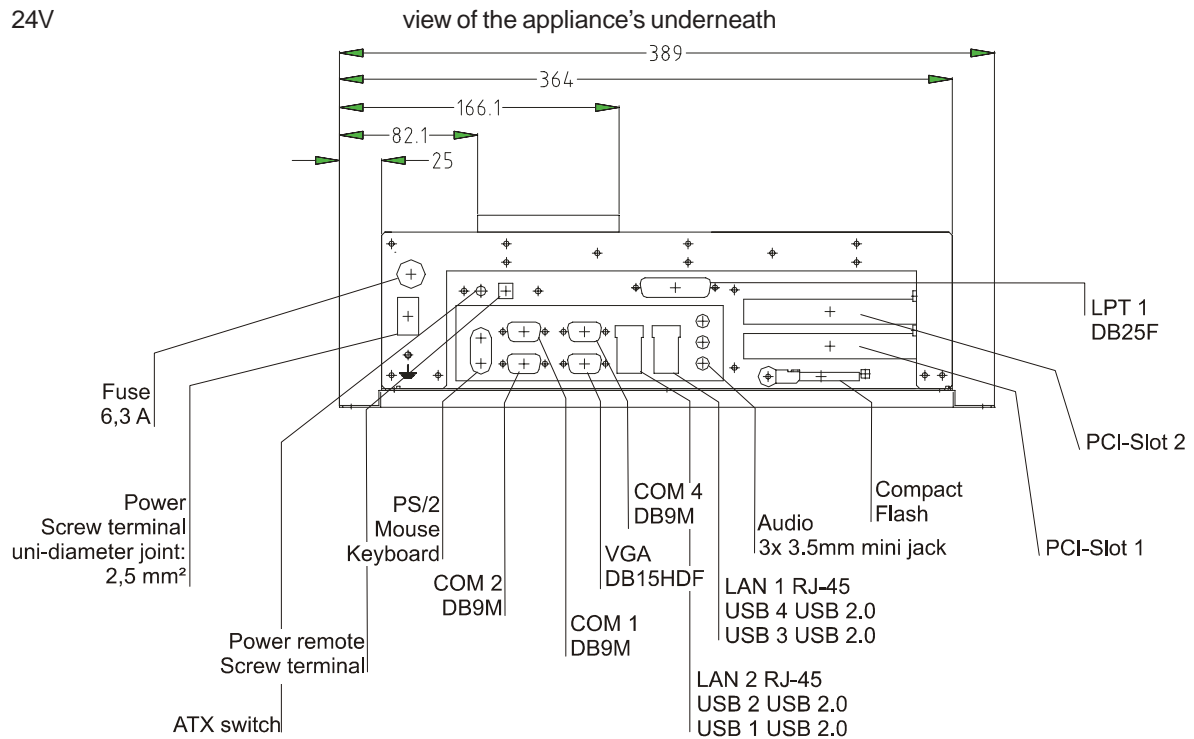

230V

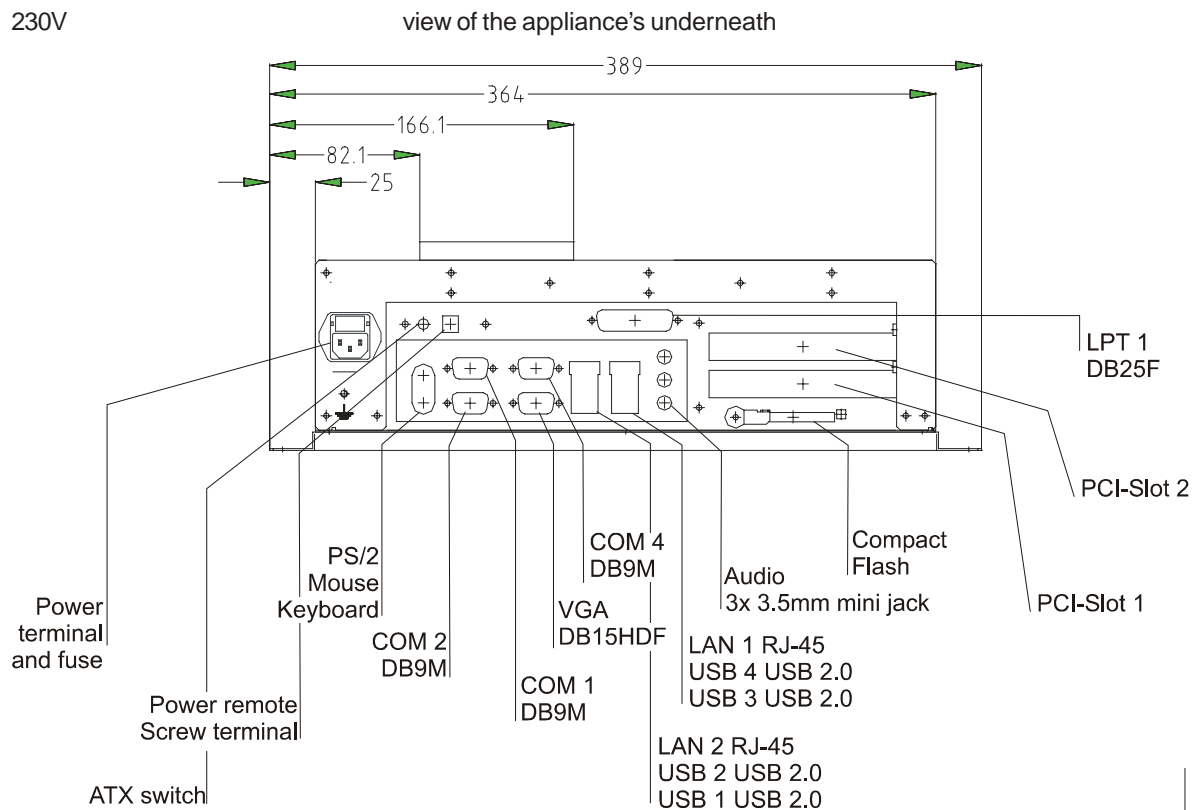

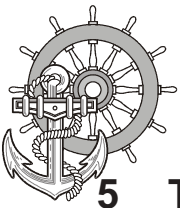

## 5 Technical data

Rear view of the appliance

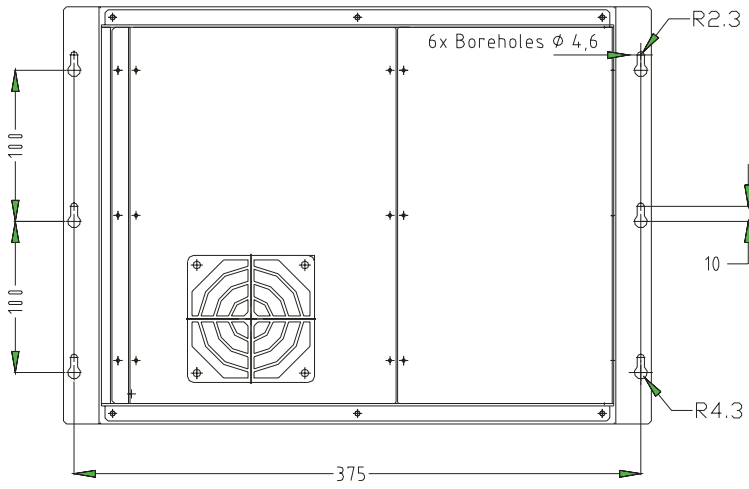

lateral view

