



Industrial Flat Panel
PC Monitor
User's Guide

 **AUTOMATIONDIRECT**.com

VICPAS
HMI Parts Center



Industrial Flat Panel PC Monitor USER'S GUIDE

Manual Number: ATM-USER



Atlas Industrial Monitor

⚡ WARNING ⚡

Thank you for purchasing automation equipment from **Automationdirect.com**[®], doing business as, **AutomationDirect**. We want your new automation equipment to operate safely. Anyone who installs or uses this equipment should read this publication (and any other relevant publications) before installing or operating the equipment.

To minimize the risk of potential safety problems, you should follow all applicable local and national codes that regulate the installation and operation of your equipment. These codes vary from area to area and usually change with time. It is your responsibility to determine which codes should be followed, and to verify that the equipment, installation, and operation is in compliance with the latest revision of these codes.

At a minimum, you should follow all applicable sections of the National Fire Code, National Electrical Code, and the codes of the National Electrical Manufacturer's Association (NEMA). There may be local regulatory or government offices that can also help determine which codes and standards are necessary for safe installation and operation.

Equipment damage or serious injury to personnel can result from the failure to follow all applicable codes and standards. We do not guarantee the products described in this publication are suitable for your particular application, nor do we assume any responsibility for your product design, installation, or operation.

Our products are not fault-tolerant and are not designed, manufactured or intended for use or resale as on-line control equipment in hazardous environments requiring fail-safe performance, such as in the operation of nuclear facilities, aircraft navigation or communication systems, air traffic control, direct life support machines, or weapons systems, in which the failure of the product could lead directly to death, personal injury, or severe physical or environmental damage ("High Risk Activities"). **AutomationDirect** specifically disclaims any expressed or implied warranty of fitness for High Risk Activities.

For additional warranty and safety information, see the Terms and Conditions section of our catalog. If you have any questions concerning the installation or operation of this equipment, or if you need additional information, please call us at 770-844-4200.

This publication is based on information that was available at the time it was printed. At **AutomationDirect** we constantly strive to improve our products and services, so we reserve the right to make changes to the products and/or publications at any time without notice and without any obligation. This publication may also discuss features that may not be available in certain revisions of the product.

Trademarks

This publication may contain references to products produced and/or offered by other companies. The product and company names may be trademarked and are the sole property of their respective owners. **AutomationDirect** disclaims any proprietary interest in the marks and names of others.

Copyright 2022, **Automationdirect.com**[®] Incorporated
All Rights Reserved

No part of this manual shall be copied, reproduced, or transmitted in any way without the prior, written consent of **Automationdirect.com**[®] Incorporated. **AutomationDirect** retains the exclusive rights to all information included in this document.

⚡ ADVERTENCIA ⚡

Gracias por comprar equipo de automatización de **Automationdirect.com**[®]. Deseamos que su nuevo equipo de automatización opere de manera segura. Cualquier persona que instale o use este equipo debe leer esta publicación (y cualquier otra publicación pertinente) antes de instalar u operar el equipo.

Para reducir al mínimo el riesgo debido a problemas de seguridad, debe seguir todos los códigos de seguridad locales o nacionales aplicables que regulan la instalación y operación de su equipo. Estos códigos varían de área en área y usualmente cambian con el tiempo. Es su responsabilidad determinar cuales códigos deben ser seguidos y verificar que el equipo, instalación y operación estén en cumplimiento con la revisión más reciente de estos códigos.

Como mínimo, debe seguir las secciones aplicables del Código Nacional de Incendio, Código Nacional Eléctrico, y los códigos de (NEMA) la Asociación Nacional de Fabricantes Eléctricos de USA. Puede haber oficinas de normas locales o del gobierno que pueden ayudar a determinar cuales códigos y normas son necesarios para una instalación y operación segura.

Si no se siguen todos los códigos y normas aplicables, puede resultar en daños al equipo o lesiones serias a personas. No garantizamos los productos descritos en esta publicación para ser adecuados para su aplicación en particular, ni asumimos ninguna responsabilidad por el diseño de su producto, la instalación u operación.

Nuestros productos no son tolerantes a fallas y no han sido diseñados, fabricados o intencionados para uso o reventa como equipo de control en línea en ambientes peligrosos que requieren una ejecución sin fallas, tales como operación en instalaciones nucleares, sistemas de navegación aérea, o de comunicación, control de tráfico aéreo, máquinas de soporte de vida o sistemas de armamentos en las cuales la falla del producto puede resultar directamente en muerte, heridas personales, o daños físicos o ambientales severos (“Actividades de Alto Riesgo”). **Automationdirect.com** específicamente rechaza cualquier garantía ya sea expresada o implicada para actividades de alto riesgo.

Para información adicional acerca de garantía e información de seguridad, vea la sección de Términos y Condiciones de nuestro catálogo. Si tiene alguna pregunta sobre instalación u operación de este equipo, o si necesita información adicional, por favor llámenos al número 770-844-4200 en Estados Unidos. Esta publicación está basada en la información disponible al momento de impresión. En **Automationdirect.com** nos esforzamos constantemente para mejorar nuestros productos y servicios, así que nos reservamos el derecho de hacer cambios al producto y/o a las publicaciones en cualquier momento sin notificación y sin ninguna obligación. Esta publicación también puede discutir características que no estén disponibles en ciertas revisiones del producto.

Marcas Registradas

Esta publicación puede contener referencias a productos producidos y/u ofrecidos por otras compañías. Los nombres de las compañías y productos pueden tener marcas registradas y son propiedad única de sus respectivos dueños. **Automationdirect.com**, renuncia cualquier interés propietario en las marcas y nombres de otros.

PROPIEDAD LITERARIA 2022, AUTOMATIONDIRECT.COM[®] INCORPORATED
Todos los derechos reservados

No se permite copiar, reproducir, o transmitir de ninguna forma ninguna parte de este manual sin previo consentimiento por escrito de **Automationdirect.com[®] Incorporated**. **Automationdirect.com** retiene los derechos exclusivos a toda la información incluida en este documento. Los usuarios de este equipo pueden copiar este documento solamente para instalar, configurar y mantener el equipo correspondiente. También las instituciones de enseñanza pueden usar este manual para propósitos educativos.

⚡ AVERTISSEMENT ⚡

Nous vous remercions d'avoir acheté l'équipement d'automatisation de **AutomationDirect.com®**, en faisant des affaires comme, **AutomationDirect**. Nous tenons à ce que votre nouvel équipement d'automatisation fonctionne en toute sécurité. Toute personne qui installe ou utilise cet équipement doit lire la présente publication (et toutes les autres publications pertinentes) avant de l'installer ou de l'utiliser.

Afin de réduire au minimum le risque d'éventuels problèmes de sécurité, vous devez respecter tous les codes locaux et nationaux applicables régissant l'installation et le fonctionnement de votre équipement. Ces codes diffèrent d'une région à l'autre et, habituellement, évoluent au fil du temps. Il vous incombe de déterminer les codes à respecter et de vous assurer que l'équipement, l'installation et le fonctionnement sont conformes aux exigences de la version la plus récente de ces codes.

Vous devez, à tout le moins, respecter toutes les sections applicables du Code national de prévention des incendies, du Code national de l'électricité et des codes de la National Electrical Manufacturer's Association (NEMA). Des organismes de réglementation ou des services gouvernementaux locaux peuvent également vous aider à déterminer les codes ainsi que les normes à respecter pour assurer une installation et un fonctionnement sûrs.

L'omission de respecter la totalité des codes et des normes applicables peut entraîner des dommages à l'équipement ou causer de graves blessures au personnel. Nous ne garantissons pas que les produits décrits dans cette publication conviennent à votre application particulière et nous n'assumons aucune responsabilité à l'égard de la conception, de l'installation ou du fonctionnement de votre produit.

Nos produits ne sont pas insensibles aux défaillances et ne sont ni conçus ni fabriqués pour l'utilisation ou la revente en tant qu'équipement de commande en ligne dans des environnements dangereux nécessitant une sécurité absolue, par exemple, l'exploitation d'installations nucléaires, les systèmes de navigation aérienne ou de communication, le contrôle de la circulation aérienne, les équipements de survie ou les systèmes d'armes, pour lesquels la défaillance du produit peut provoquer la mort, des blessures corporelles ou de graves dommages matériels ou environnementaux («activités à risque élevé»). La société **AutomationDirect** nie toute garantie expresse ou implicite d'aptitude à l'emploi en ce qui a trait aux activités à risque élevé.

Pour des renseignements additionnels touchant la garantie et la sécurité, veuillez consulter la section Modalités et conditions de notre documentation. Si vous avez des questions au sujet de l'installation ou du fonctionnement de cet équipement, ou encore si vous avez besoin de renseignements supplémentaires, n'hésitez pas à nous téléphoner au 770-844-4200.

Cette publication s'appuie sur l'information qui était disponible au moment de l'impression. À la société **AutomationDirect**, nous nous efforçons constamment d'améliorer nos produits et services. C'est pourquoi nous nous réservons le droit d'apporter des modifications aux produits ou aux publications en tout temps, sans préavis ni quelque obligation que ce soit. La présente publication peut aussi porter sur des caractéristiques susceptibles de ne pas être offertes dans certaines versions révisées du produit.

Marques de commerce

La présente publication peut contenir des références à des produits fabriqués ou offerts par d'autres entreprises. Les désignations des produits et des entreprises peuvent être des marques de commerce et appartiennent exclusivement à leurs propriétaires respectifs. **AutomationDirect** nie tout intérêt dans les autres marques et désignations.

Copyright 2022, Automationdirect.com® Incorporated
Tous droits réservés

Nulle partie de ce manuel ne doit être copiée, reproduite ou transmise de quelque façon que ce soit sans le consentement préalable écrit de la société **Automationdirect.com® Incorporated**. **AutomationDirect** conserve les droits exclusifs à l'égard de tous les renseignements contenus dans le présent document.



Industrial Flat Panel PC Monitor

USER'S GUIDE



Please include the User's Guide Number and the User's Guide Issue, both shown below, when communicating with Technical Support regarding this publication.

Guide Number: ATM-USER
Issue: 2nd Edition, Rev. J
Issue Date: 08/22

Publication History		
Issue	Date	Description of Changes
1st Edition	06/07	Original issue
Rev. A	07/07	Minor corrections
Rev. B	07/07	Warning message added to Display Power button and minor corrections.
2nd Edition	09/08	Combined individual manuals. Added UL hazardous locations notes and warnings. Minor corrections
Rev. A	08/09	Revised UL file numbers from E191072 to E157382 and E313546 to E200031.
Rev. B	08/10	Added wire information and specifications.
Rev. C	08/10	Minor corrections
Rev. D	03/11	Added Windows 7 driver information
Rev. E	10/12	UL required revisions for UL1604 to ANSI/ISA 12.12.01-2012 conversion
Rev. F	04/14	Added multilingual warnings
Rev. G	10/18	Revised software requirements, minor revisions
Rev. H	01/20	Removed CE and RoHS approvals
Rev. J	08/22	Revised "in the box" information

TABLE OF CONTENTS



Chapter 1: Introduction

Introduction.....	1-2
Features.....	1-2
Supported PC Video Modes.....	1-3
Specifications.....	1-4
Front and Side Views of Monitors	1-6
ATM1500/ATM1500T	1-6
ATM1700/ATM1700T	1-7
ATM1900/ATM1900T	1-8

Chapter 2: Installation of Monitor

Installation of Monitor	2-2
Cutout Pattern for Atlas Monitors	2-2
Mounting Clip Installation	2-3
Connecting Power	2-4
Optional Protective Cover Installation.....	2-6
Connection of Video and Touch Screen Cables	2-7
Turning on the Computer and Monitor	2-8
Selection of PC Video Settings.....	2-8
Installing the Touch Screen Driver Software.....	2-8

Chapter 3: Monitor OSD and Settings

On Screen Display (OSD) Controls	3-2
Button and LED Functions.....	3-3
OSD Menus and Settings	3-4
MAIN MENU	3-4
BRIGHTNESS/CONTRAST	3-4
COLOR.....	3-7
POSITION.....	3-8
SETUP.....	3-10
OSD Message Displays	3-13
OUT OF FREQUENCY	3-13
NO SIGNAL.....	3-13
POWER SAVER MODE.....	3-14
PROCESSING AUTO CONFIGURATION	3-14

Appendix: Hardware Connections

Video Input Pin Assignment.....	A-2
VGA Pin Assignment.....	A-3
Touch Screen Pin Assignment.....	A-4
Serial RS-232	A-4
USB	A-4

INTRODUCTION



CHAPTER 1

In this Chapter...

Introduction.....	1-2
Features.....	1-2
Supported PC Video Modes.....	1-3
Specifications.....	1-4
Front and Side Views of Monitors	1-6
ATM1500/ATM1500T	1-6
ATM1700/ATM1700T	1-7
ATM1900/ATM1900T	1-8

Introduction

Atlas industrial monitors are high performance color TFT flat panel monitors specifically designed for harsh industrial environments including Class I Division 2, Class II Division 2 and Class 3 hazardous locations. Each monitor accepts standard analog VGA or digital DVI inputs and can display all VESA video modes up to 1280 x 1024 at 75Hz with 16 million colors. An optional 5-wire analog touch screen is available that offers both RS-232 and USB interface capability. The monitor is housed in a heavy duty steel chassis with a powder coated machined aluminum bezel. The monitor is certified to NEMA 4/4X/12 standards and is UL/CUL listed. Panel mounting is simplified using convenient mounting clips instead of conventional studs. All monitors are shipped with a power input wiring receptacle, VGA cable, touch screen cable (if equipped), mounting hardware and Quick Installation Guide. This user's guide can be downloaded from the Documentation area of the AutomationDirect.com website.

Features

- UL 508 and ANSI/ISA 12.12.01-2012 listed for Hazardous Locations: Class I, Division 2, Groups A, B, C, D; Class II, Division 2, Groups F and G and Class III hazardous locations when mounted in a NEMA Type 1, 4, 4X or 12 enclosure
- NEMA 4/4X/12 front bezel
- 2-Year warranty
- Integral 100 -240 VAC power supply
- Simplified installation with no studs
- Thin design - Less than 3" behind bezel
- Accepts analog 15-pin Video input, digital input DVI-D
- VESA compliant - all modes up to SXGA, 75Hz
- Optional 5-wire resistive touch screen with both RS-232 and USB interface

Supported PC Video Modes

Mode	Dot Clock (MHz)	Horizontal Freq (KHZ)	Vertical Freq (Hz)	H Sync Polarity	V Sync Polarity
640 x 350 @ 70Hz	25.144	31.430	70.000	P	N
640 x 400 @ 70Hz	28.287	31.430	70.000	N	P
720 x 400 @ 70Hz	28.287	31.430	70.000	N	P
640 x 480 @ 60Hz	25.175	31.469	59.940	N	N
640 x 480 @ 72Hz	31.500	37.861	72.809	N	N
640 x 480 @ 75Hz	31.500	37.500	75.000	N	N
800 x 600 @ 56Hz	36.000	35.156	56.250	P	P
800 x 600 @ 60Hz	40.000	37.879	60.317	P	P
800 x 600 @ 72Hz	50.000	48.077	72.188	P	P
800 x 600 @ 75Hz	49.500	46.875	75.000	P	P
*1024 x 768 @ 60Hz	65.000	48.363	60.005	N	N
*1024 x 768 @ 70Hz	75.000	56.476	70.070	N	P
*1024 x 768 @ 75Hz	78.750	60.023	75.030	P	P
**1280 x 1024 @ 60Hz	108.000	63.981	60.020	P	P
**1280 x 1024 @ 75Hz	135.000	79.976	75.035	P	P

Note: *These PC display modes produce the best image quality on the ATM1500/ATM1500T.
 **These PC display modes produce the best image quality on the ATM1700/ATM1700T and ATM1900/ATM1900T.

Specifications

1

Part Number	ATM1500/ATM1500T	ATM1700/ATM1700T	ATM1900/ATM1900T
Specification			
Display:			
Display Size	8.98" x 11.97"	10.64" x 13.30"	11.85" x 14.82"
Active Area H x W	(228.1mm x 304.0mm)	(270.3mm x 337.8mm)	(301.0mm x 376.4mm)
Native Resolution	XGA, 1024 x 768	SXGA, 1280 x 1024	SXGA, 1280 x 1024
VESA Modes Supported	Up to 1280 x 1024 @75Hz		
Displayable Colors	16M		
Brightness, Typical	250 Nit	300 Nit	270 Nit
Contrast Ratio, Typical	800:1	1000:1	2000:1
Horizontal/Vertical View Angle, CR>5, Typical	150°/145°	170°/170°	178°/178°
Backlight Life	50,000 hrs, Minimum		
Display Input Signal	Analog 15-Pin D-Sub, DVI-D		
Touch Screen (Optional - ATM1500T, ATM1700T and ATM1900T):			
Touch Screen Technology	5- Wire Analog Resistive		
Interface	USB 1.1 and Serial RS-232		
Resolution	4096 x 4096		
Positional Accuracy - Maximum Error	0.18" (4.6 mm)		0.19" (4.8 mm)
Positional Accuracy - Standard Deviation of Error	<.08" (<2.0 mm)		
Expected Life	>35,000,000 Activations		
Physical:			
Overall Monitor Dimensions H x W x D	12.80" x 15.80" x 2.65" (325.1 x 401.3 x 67.3)	14.48" x 17.14" x 2.85" (367.8 x 435.4 x 72.4)	15.70" x 18.66" x 2.95" (398.8 x 474.0 x 74.9)
Cutout Dimensions - H x W	12.00" x 15.00" (304.8mm x 381.0mm)	13.70" x 16.35" (348.0mm x 415.3mm)	14.90" x 17.75" (378.5mm x 450.9mm)
Weight	14.0 lbs (6.4 kg)	18.5 lbs (8.4 kg)	21 lbs (9.5 kg)
Shipping Weight	19 lbs (8.6 kg)	23.5 lbs (10.7 kg)	26 lbs (11.8 kg)
Electrical:			
AC Input Voltage	100 - 240 VAC, 50/60 Hz		
AC Input Current	0.5 A Maximum	1 A Maximum	
Input Power	≤ 25W	≤ 30W	≤ 35W

Specifications continued on next page.

Specifications cont'd

Part Number	ATM1500/ATM1500T	ATM1700/ATM1700T	ATM1900/ATM1900T
Specification			
Environmental:			
Operating Temperature	0 to 50 °C (32 to 122 °F)		
Storage Temperature	-20 to 60 °C (-4 to 140 °F)		
Operating and Storage Humidity	20% to 80% RH, noncondensing		
Operating Shock	15g peak acceleration, 11msec		
Operating Vibration 5-2000 Hz	0.006" peak to peak, 1g max		
Operating Altitude	Sea level - 10,000 feet		
Storage Altitude	Sea level - 40,000 feet		
Agency:			
Front Panel NEMA Rating	NEMA 4/4X/12, IP65		
FCC	47 CFR, Part 15, Class A		
EU Compliance	EN 55022: Class A, EN 61000-3-2: Class A, EN 61000-3-3, EN 61000-6-2, IEC 60950-1		
Safety Agency Approvals	UL 508 Listed (file #E157382), ANSI/ISA 12.12.01-2012 Listed* (file #E200031), cUL Listed CSA C22.2, #142, CSA C22.2, #143*		
* Suitable for use in Class I, Division 2, Groups A, B, C and D, Class II, Division 2, Groups F and G, Class III Hazardous Locations or Non-Hazardous locations only.			
For use on a flat surface of a type 1, 4, 4X or 12 enclosure with provisions for Class I Division 2 wiring methods			
Temperature Code: T5			



NOTE: Suitable for use in Class 1, Division 2, Groups A, B, C and D hazardous locations, or nonhazardous locations only.



WARNING – EXPLOSION HAZARD – Substitution of any components may impair suitability for Class 1, Division 2.



WARNING – EXPLOSION HAZARD – Do not disconnect equipment while the circuit is live unless the area is known to be free of ignitable concentrations.



WARNING – EXPLOSION HAZARD – Do not disconnect the USB ports unless the power has been switched off and the area is known to be non-hazardous.

Front and Side Views of Monitors

1

ATM1500/ATM1500T

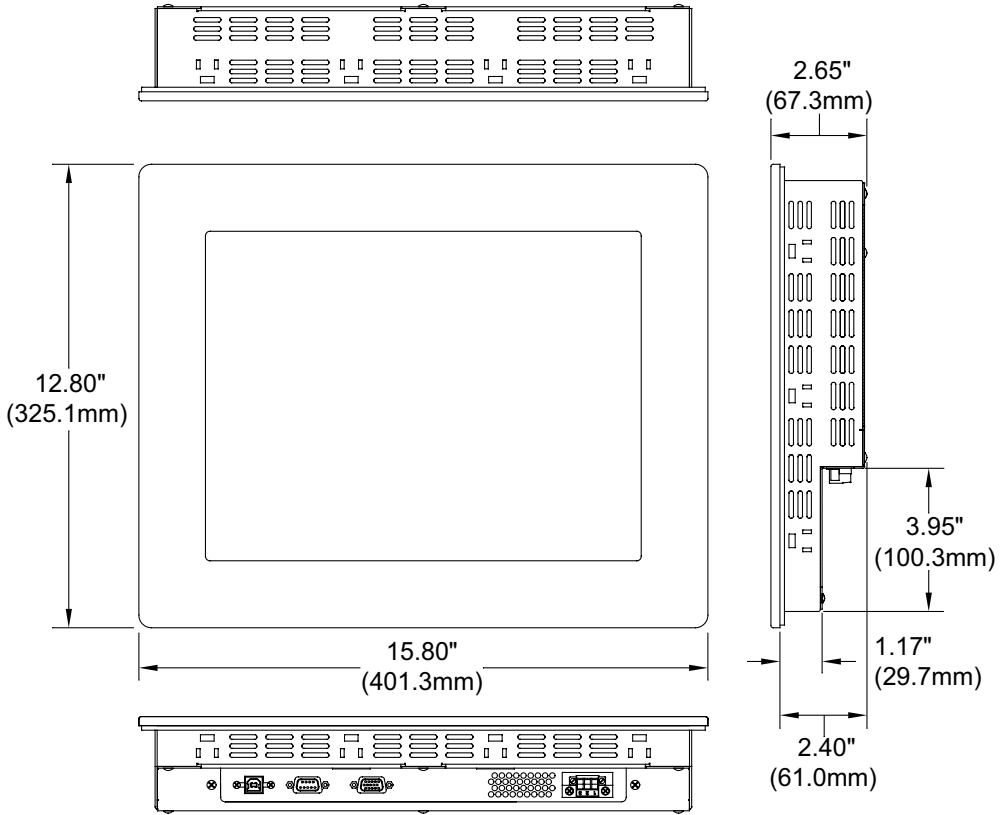

Front and Side Views of Monitors cont'd

ATM1700/ATM1700T

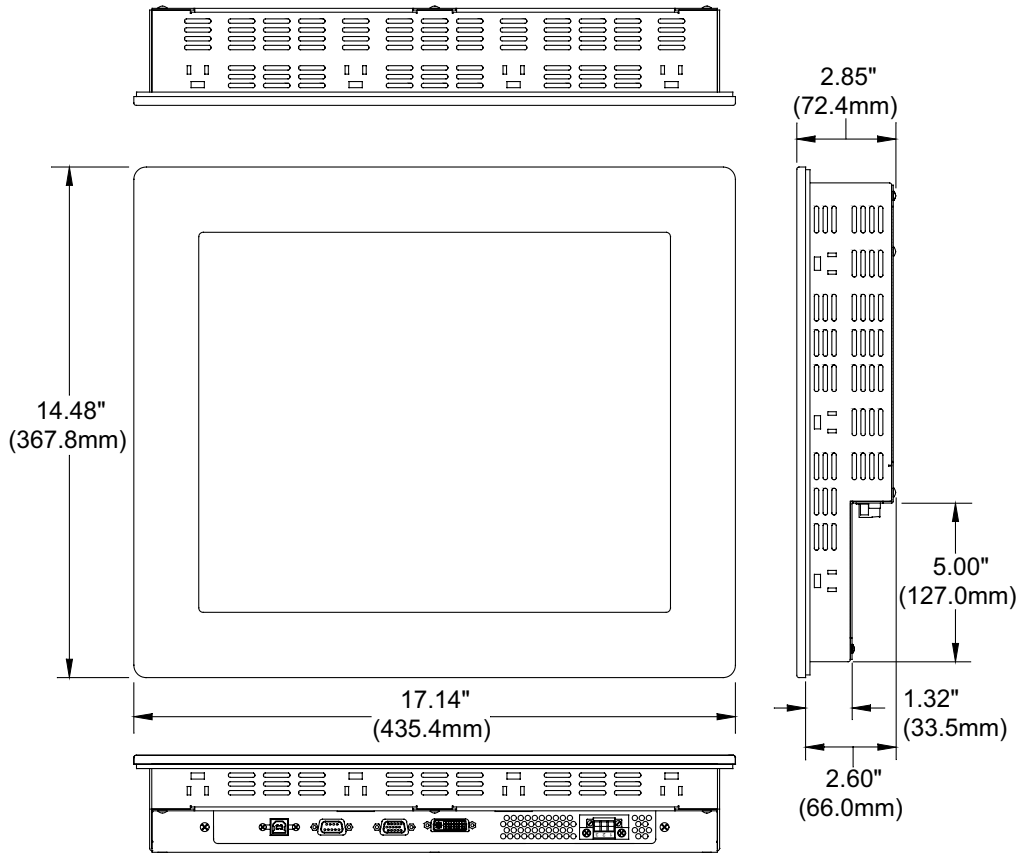

Front and Side Views of Monitors cont'd

1

ATM1900/ATM1900T

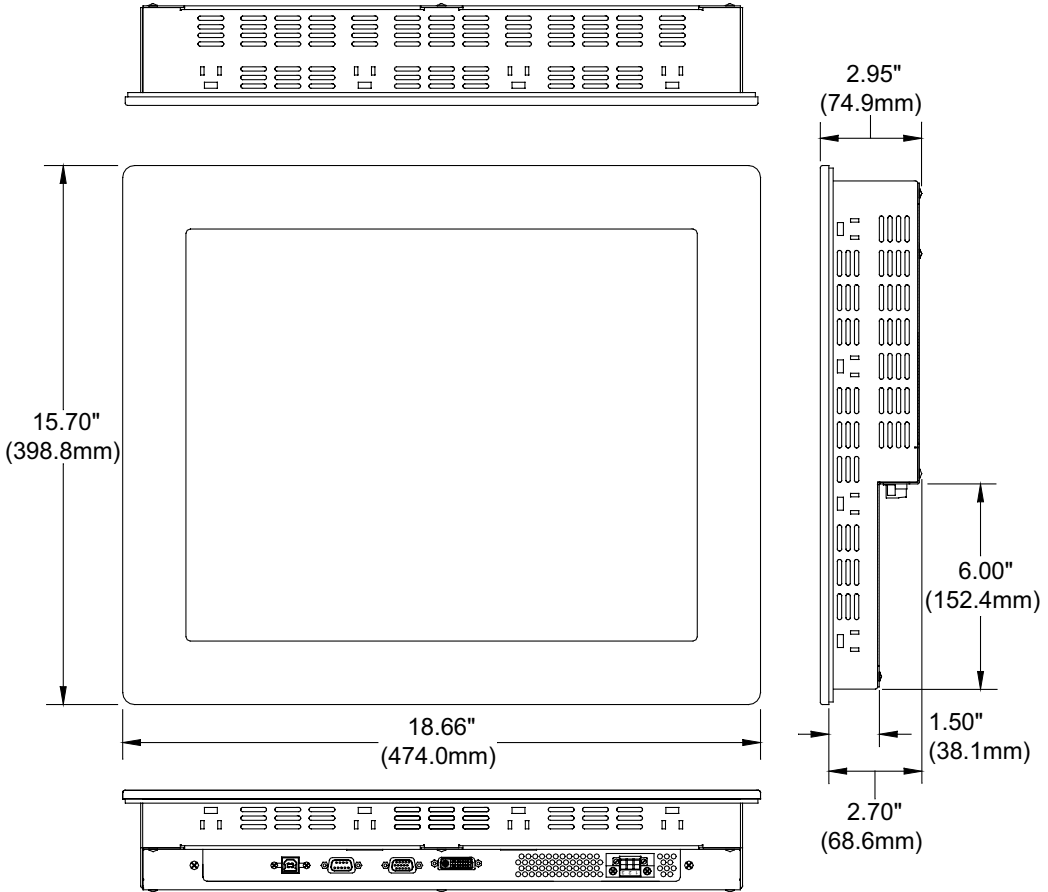

INSTALLATION OF MONITOR



CHAPTER 2

In this Chapter...

Installation of Monitor	2-2
Cutout Pattern for Atlas Monitors	2-2
Mounting Clip Installation	2-3
Connecting Power	2-4
Optional Protective Cover Installation.....	2-6
Connection of Video and Touch Screen Cables	2-7
Turning on the Computer and Monitor	2-8
Selection of PC Video Settings.....	2-8
Installing the Touch Screen Driver Software.....	2-8

Installation of Monitor

2

This monitor is intended to be mounted in and used where NEMA 1, 4, 4X and NEMA 12 type enclosures are employed. Enclosures made of heavier gauge metal work better because they won't deform or bend as easily when the monitor's sealing gasket is compressed. The monitor meets NEMA 4/12 sealing specifications when properly installed in an approved NEMA enclosure constructed from 14-gauge or heavier steel. The monitor uses "U"-shaped clips and a special gasket to achieve the proper seal.

When selecting an enclosure remember to allow adequate space around the rear of the monitor for good air flow. Do not block air flow from below or above the monitor. If possible mount the monitor in a vertical orientation. The monitor is designed to work in environments up to 50 degrees Centigrade surrounding air temperature inside the enclosure. Remember to account for heat dissipated from other equipment that may be inside the same enclosure.

To install the monitor, make a cutout (according to the diagram below) in one of the walls of your NEMA enclosure. Enclosures made of heavier gauge metal work better in that they won't deform or bend as easily when the monitor's sealing gasket is compressed. Next hold the monitor in place while you install the mounting clips. Tighten the clips to the point where the back of the monitor's front bezel just begins to contact the front of the NEMA enclosure. The use of an adjustable torque driver is recommended. The screws should be tightened to 8 inch-pounds. Tighten the clips in a cross pattern to develop an even pressure on the sealing gasket. **DO NOT OVERTIGHTEN AS DAMAGE CAN RESULT IN THE MONITOR CAUSING LOSS OF SEALING INTEGRITY.**



WARNING – Damage can occur by applying excessive torque to the mounting clips.

Cutout Pattern for Atlas Monitors

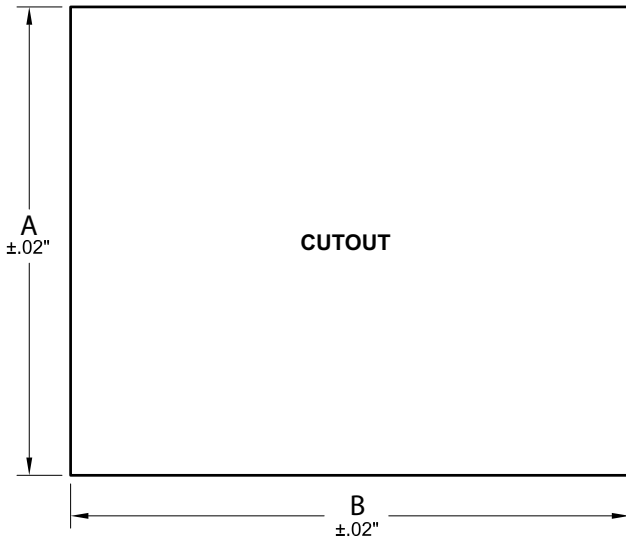

Dimensions		
Model	A	B
ATM1500/ATM1500T	12.00" (304.8 mm)	15.00" (381.0 mm)
ATM1700/ATM1700T	13.70" (348.0 mm)	16.35" (415.3 mm)
ATM1900/ATM1900T	14.90" (378.5 mm)	17.75" (450.9 mm)

Mounting Clip Installation

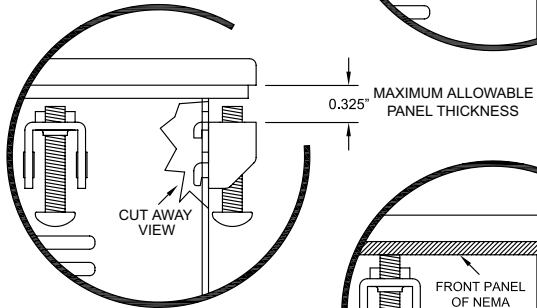
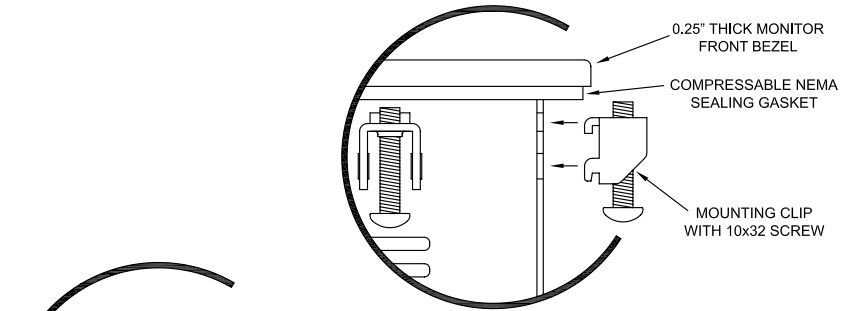

NOTE – When installing the mounting clips, tighten the screws to 8-10 in-lbs (.9 - 1.1 N-m) max. Overtightening the screws will result in a compressed NEMA seal and may cause touch screen breakage.

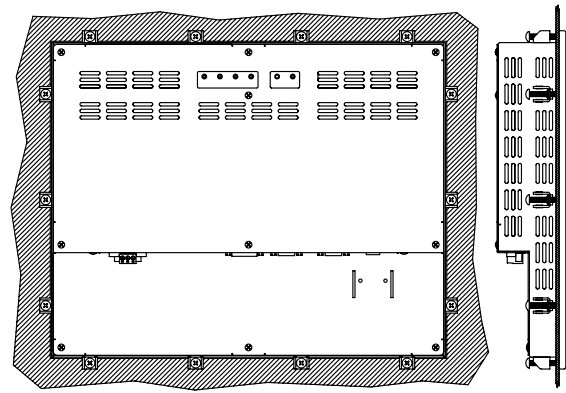
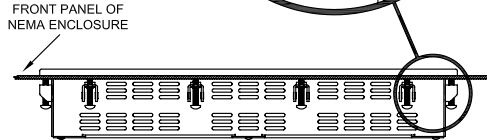
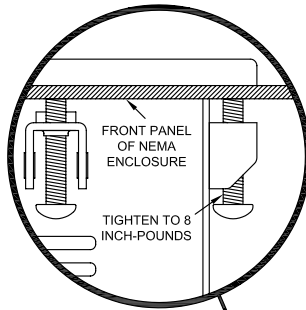

REAR VIEW OF PANEL MOUNTED MONITOR

Connecting Power

The Atlas monitor is powered from 100-240 VAC, 50/60 Hz.

2 Because the Atlas monitor is listed for Hazardous Location use, (ANSI/ISA 12.12.01-2012 Class I Division 2, groups A, B, C, & D; Class II Division 2, groups F & G and Class III, Temperature Code T5), it has no power switch for switching off supplied power. Please read the functional description of the DISPLAY POWER button on page 3-3. Consideration should be given to the installation of an appropriately rated external power switch if the application requires powering off the Atlas monitor.

Power is connected to the Atlas monitor through a removable Phoenix Contact plug (ADC P.N. ATM-AC-CON or Phoenix Contact P.N. 1777992) that allows for screw termination of field wiring. **When field wiring to these terminals, the use of 18 AWG or greater (12 AWG maximum) copper wire with 60 °C or 60/75 °C wire insulation and the terminal tightening torque of 7.0 lb-in (0.79 Nm) is required.** The terminal screws are shown in the Top View in the following diagram. Connect the field wiring according to the appropriate table below. Strip the wire insulation back on each conductor 6.5 mm (0.26 in) and make sure that the remaining wire is twisted together, not frayed, and clean. If an outer jacket over each conductor is utilized then strip the outer jacket back an additional 19.0 mm (0.75 in) as shown in the next figure. When installing the conductors take care that there are not any stray strands of wire that can contact an adjoining connection. Tinning of each lead can be utilized to prevent frays if desired. Optionally the included protective cover can be utilized to prevent electrical shocks when handling the power connector and provide strain relief for each conductor connection (see the following section for installation instructions). After the connections are made, make sure the plug retention screws (the two screws shown in the “Front View”) are securely tightened. This will prevent the plug from pulling out. The use of these screws is mandatory when the unit is utilized in applications requiring hazardous locations approvals.

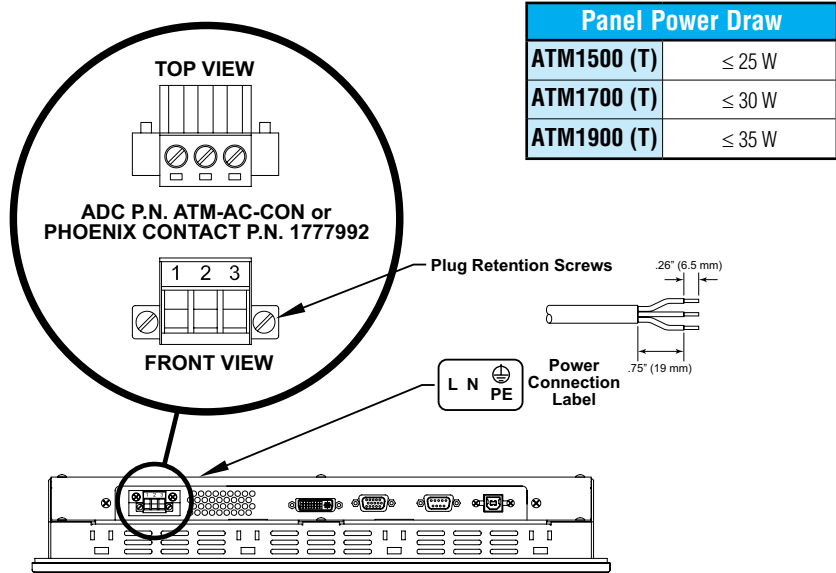

Panel Power Draw	
ATM1500 (T)	≤ 25 W
ATM1700 (T)	≤ 30 W
ATM1900 (T)	≤ 35 W

100 VAC - 240 VAC INPUT (1.0 Amps Min)		
	PIN No.	Definition
1	1	AC Line Input
2	2	AC Neutral Return
3	3	Protective Earth Ground

Required Wire Specification	
Wire Size	18 - 12 AWG (0.8 - 3.3 mm ²)
Wire Material and Temperature	60 °C or 60 / 75 °C Copper
Tightening Torque	7.0 lb-in (0.79 Nm)



WARNING – EXPLOSION HAZARD – Do not disconnect equipment while the circuit is live unless the area is known to be free of ignitable concentrations.



WARNING – EXPLOSION HAZARD – Do not disconnect equipment unless the power has been switched off or the area is known to be non-hazardous. USB connections must be secured with included retention bracket.

Optional Protective Cover Installation

2

Step 1: Gather the parts of the protective cover; top shell, bottom shell, label insert, and wire tie. The picture shows wire tie (top), label insert (right), bottom shell (left), and top shell (lower right).



Step 2: Insert your pre-wired connector (with the screws facing up) into the bottom shell. (See manual for cable wiring instructions).

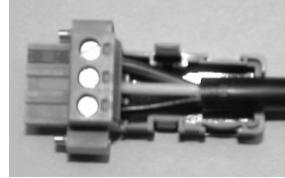

Step 3: Insert the wire tie from the bottom shell, loop around the cable and come back out of the opposite hole in the bottom shell.

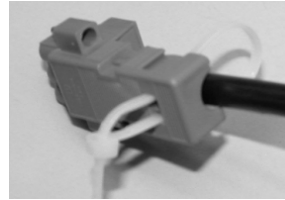

Step 4: Tighten the wire tie around the cable and the bottom shell.

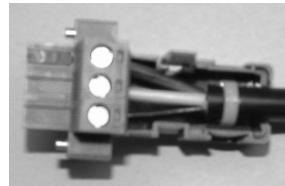

Step 5: Seat the top shell onto the bottom as shown. Insert label strip (if desired) in slot on top shell and bottom shell.

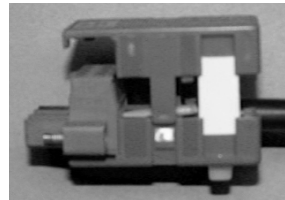

Step 6: Snap the top and bottom shells together.

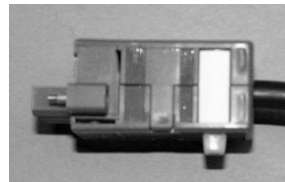

Connection of Video and Touch Screen Cables

Connect either a 15-pin VGA or DVI cable and either an RS-232 or USB cable if the monitor is equipped with a touch screen. All communication cables should include a chassis ground shield. Hazardous location, Division 2, requires that all cables have adequate strain relief. For this reason, tighten all connector thumb screws securely. If a USB cable is being used, install the provided USB retention bracket. Insert the USB connector through the square cutout in the base of the bracket and pull the cable and body of the connector back through the round hole in the bracket flange. Now insert the bracket into the two slots on the rear of the monitor and slide it forward so the connector is fully inserted in the mating bulkhead connector. Install and tighten two 4-40 x .25" Philips screws.

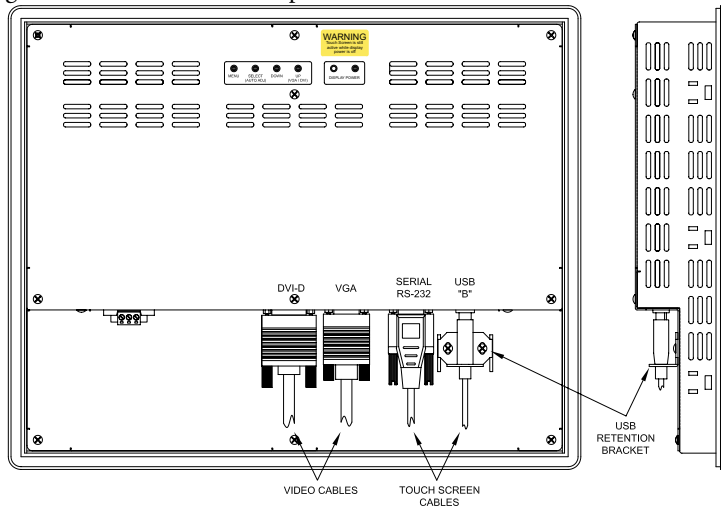

NOTE – When using the USB touchscreen connection, the use of the USB retention bracket is required for hazardous locations and highly recommended for nonhazardous locations.



NOTE – To prevent inadvertent disconnection of video and / or serial touchscreen cables assure that the thumbscrews are sufficiently tight.



WARNING - EXPLOSION HAZARD - Do not connect or disconnect the USB ports unless the power has been switched off or the area is known to be non-hazardous.

AVERTISSEMENT - RISQUE D'EXPLOSION - Ne pas brancher ou débrancher le ports USB à moins que l'alimentation á été coupée ou si la zone n'est pas dangereuse.

ADVERTENCIA - PELIGRO DE EXPLOSIÓN - No conecte o desconecte los puertos USB a menos que la computadora se encuentre apagada o el área se considere no peligrosa.

WARNUNG - EXPLOSIONSGEFAHR - USB-Ports nur anschließen oder trennen, wenn keine spannung anliegt oder der Bereich nicht explosionsgefährdet ist.

Turning on the Computer and Monitor

With power applied to the monitor and all cables connected you may power up the computer and press the DISPLAY POWER button on the rear of the monitor. The POWER LED will switch from off to green. The monitor will perform an automatic self configuration and begin displaying an image. If no image appears, it may be because the monitor has the wrong video input selected. Press the UP button on the rear of the monitor to change between VGA and DVI-D inputs. If the computer is subsequently powered off, the monitor will remain on and display the NO SIGNAL error message (page 3-13) indefinitely. The POWER LED remains green. The touch screen remains active during this time. When the computer is powered on again, the NO SIGNAL message disappears and normal image display resumes.

Selection of PC Video Settings

Although the Atlas monitor can display several different video modes, the optimum display image performance occurs when the PC's video settings match the native resolution of the Atlas monitor's LCD. Recommended video modes are...

- ATM1500/ATM1500T - 1024 x 768, refresh rate 60, 70 or 75 Hz
- ATM1700/ATM1700T - 1280 x 1024, refresh rate 60 or 75 Hz
- ATM1900/ATM1900T - 1280 x 1024, refresh rate 60 or 75 Hz

This can be done using Window's control panel or by right clicking on the desktop and choosing "Properties". This will bring up the "Display Properties" menu. From this menu, select the "Setting" tab and choose the recommended video mode for the Screen resolution. From the Settings menu, choose "Advanced" and then click on the "Monitor" tab to set the Screen refresh rate to 60 Hz.

Installing the Touch Screen Driver Software

The calibration of the touch screen occurs by a calibration utility that installs as part of the touch screen driver installation process.

Drivers for Windows® operating systems are located on the Product page on the AutomationDirect.com website under Support Resources.

MONITOR OSD AND SETTINGS



CHAPTER 3

In this Chapter...

On Screen Display (OSD) Controls	3-2
Button and LED Functions.....	3-3
OSD Menus and Settings	3-4
MAIN MENU	3-4
BRIGHTNESS/CONTRAST	3-4
COLOR.....	3-7
POSITION.....	3-8
SETUP.....	3-10
OSD Message Displays	3-13
OUT OF FREQUENCY	3-13
NO SIGNAL.....	3-13
POWER SAVER MODE.....	3-14
PROCESSING AUTO CONFIGURATION	3-14

On Screen Display (OSD) Controls

The OSD controls are used for making adjustments to the monitor's settings and are located on the back of the monitor. They consist of a single LED and five pushbuttons whose functions are described in the tables continued on the next page.

3

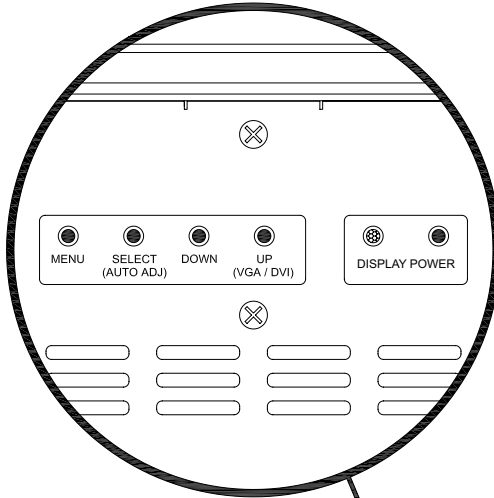

WARNING
Touch Screen is still active while display power is off

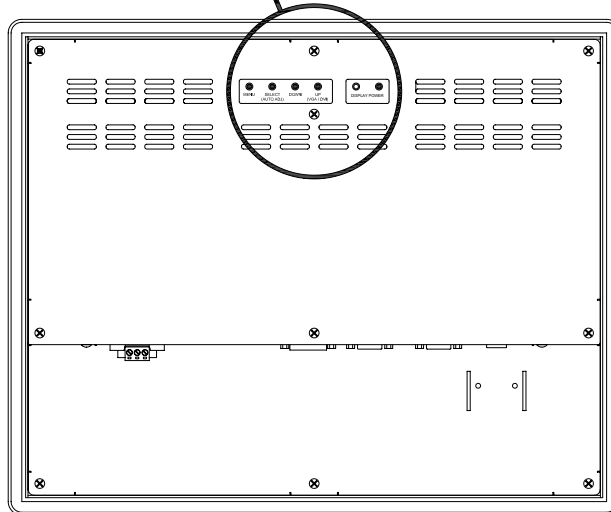

Button and LED Functions

BUTTON	FUNCTION
DISPLAY POWER	Pressing this button once wakes the monitor up. Pressing the DISPLAY POWER button again turns off the backlight inverter and puts the monitor in a reduced power state but the touch screen remains active. It is important to note that this switch does not disconnect power from the monitor. Power is always supplied to the internal AC/DC power supply, which in turn continually supplies power to the internal monitor electronics and the optional touch screen controller.
MENU	Pressing this button causes the main OSD menu to be displayed. Pressing it again will cause the Main OSD menu to disappear. If the button is not pressed a second time, the main OSD menu will disappear after the set timeout period.
SELECT (AUTO ADJ)	When the OSD main menu is displayed, pressing this button selects one of five sub-menus. Within a sub-menu, this button selects and deselects menu choices. HOT KEY: When the OSD is not displayed, pressing this button will initiate an automatic configuration and cause the "Processing Auto Configuration" message to be displayed.
DOWN	Within the main OSD menu and sub-menus, this button acts as an down cursor key, moving the highlighted item for selection to move downward to the next highlighted item for selection. When an item has been selected from a sub-menu, pressing this key decreases its value.
UP (VGA / DVI)	Within the main OSD menu and sub-menus, this button acts as an up cursor key, moving the highlighted item for selection to move upward to the next highlighted item for selection. When an item has been selected from a sub-menu, pressing this key increases its value. HOT KEY: When the OSD main menu is not displayed, pressing this button causes the monitor to switch between VGA (PC) and DVI (Digital) video inputs.

LED	FUNCTION
Not Lit	Power off mode.
Green	Monitor is on and receiving a normal video signal.
Amber	Monitor is on but in DPMS (Display Power Management Signaling) mode because it is not receiving a normal incoming video signal.



WARNING – Touch screen is still active while display power is off.

ATTENTION – L'écran tactile est toujours actif, même quand l'afficheur n'est pas alimenté.

ADVERTENCIA – La pantalla táctil sigue activa aún cuando el display esté apagado.

WARNUNG – Touch screen ist immer noch aktiv, während die anzeigefläche ausgeschaltet ist.

OSD Menus and Settings

MAIN MENU

The following section describes the monitor's OSD menus and settings. With the monitor powered up and receiving a normal video signal, pressing the MENU button once will cause the following screen to appear:

3

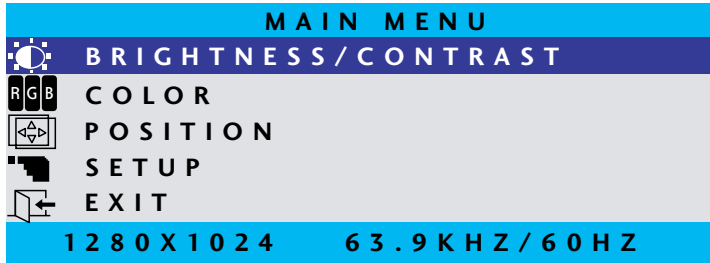

Pressing MENU again will turn this screen off. Alternatively it will turn off after a time out period that is set in the SET UP sub-menu. Finally it can be turned off by pressing the DOWN button to move the blue highlighted band down to the EXIT sub-menu and pressing the SELECT button.

The bottom line on this screen displays the incoming video horizontal and vertical resolution and refresh rates.

BRIGTHNESS/CONTRAST

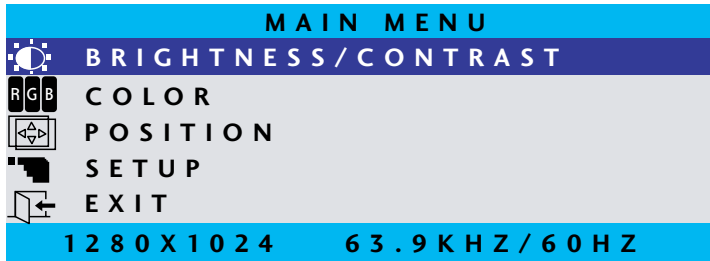

BRIGHTNESS

With BRIGHTNESS/CONTRAST highlighted on the MAIN MENU pressing SELECT will cause the following screen to be displayed:

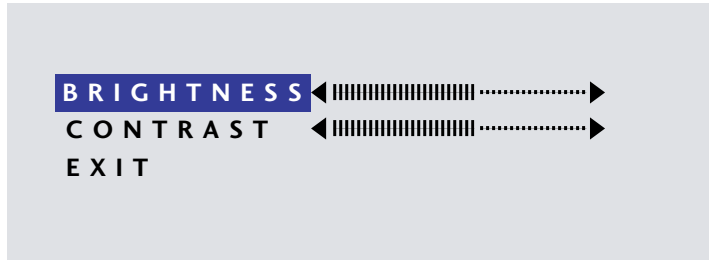

3

Pressing the SELECT button will cause the following screen to be displayed:



Pressing the UP and DOWN buttons will adjust the brightness accordingly. Pressing the SELECT button again will deselect this function causing the following screen to appear:

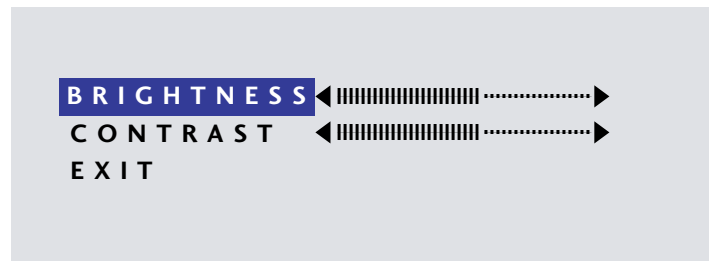

CONTRAST

Pressing the DOWN button once and the SELECT button once will cause the following screen to appear:



Pressing the UP and DOWN buttons will adjust the contrast accordingly. Pressing the SELECT button again will deselect this function. Press the DOWN button to highlight EXIT and then press SELECT to return to the MAIN MENU.

COLOR

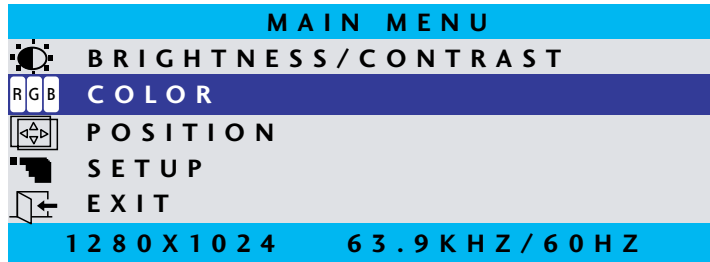

With COLOR highlighted on the MAIN MENU pressing SELECT will cause the following screen to be displayed:

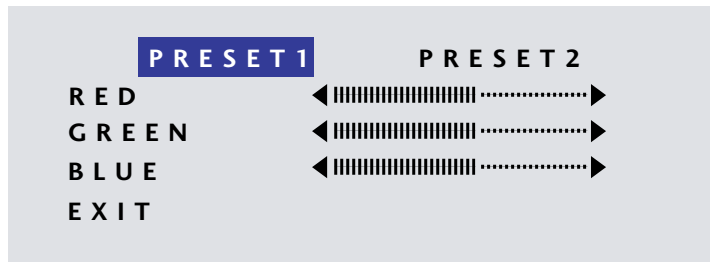

PRESET1 and PRESET2 are preset color balances. PRESET1 produces a bluer screen while PRESET2 produces a more aqua screen. Use the UP and DOWN buttons to highlight PRESET1 or PRESET2 and press SELECT to make your selection and return to the MAIN MENU. If you highlight RED GREEN or BLUE and press select, the following screen appears:

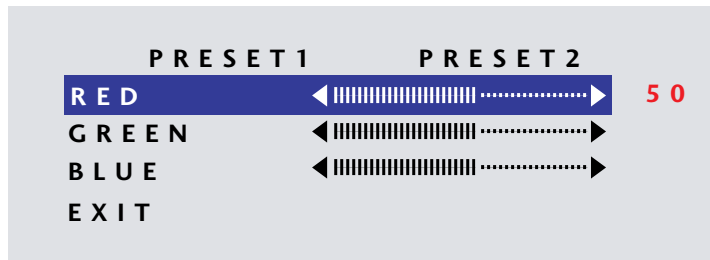

Pressing the UP and DOWN buttons causes the setting to change from the default of 50 to a value between 0 and 100. Pressing SELECT again saves the setting and deselects the menu item. Highlighting EXIT and pressing SELECT will return to the MAIN MENU.

POSITION

3

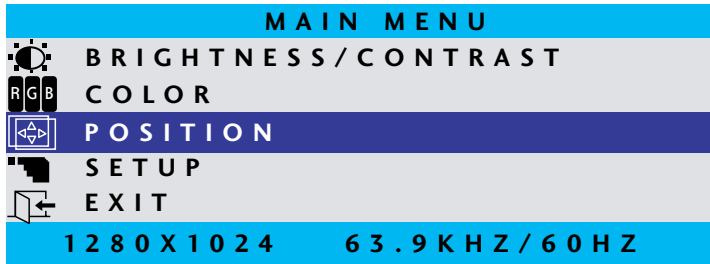

With POSITION highlighted on the MAIN MENU, pressing SELECT will cause the following screen to be displayed:

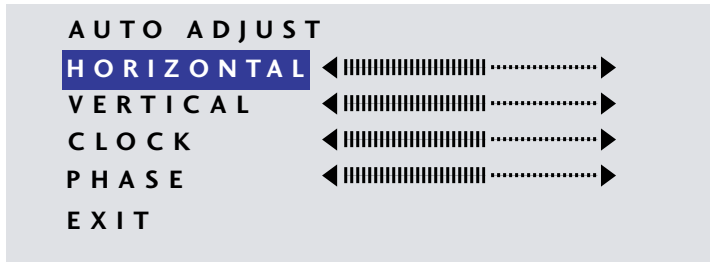

AUTO ADJUST

Highlighting AUTO ADJUST and pressing SELECT will initiate an automatic configuration and cause the “Processing Auto Configuration” message to be displayed.

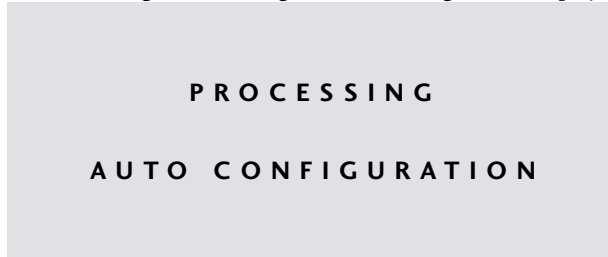

During the auto configuration process, the monitor automatically centers the screen horizontally and vertically, sets the clock and optimizes the phase. After the process is complete, the screen is cleared of the OSD menu.

HORIZONTAL

With HORIZONTAL highlighted on the POSITION menu, pressing SELECT will cause the following screen to be displayed:

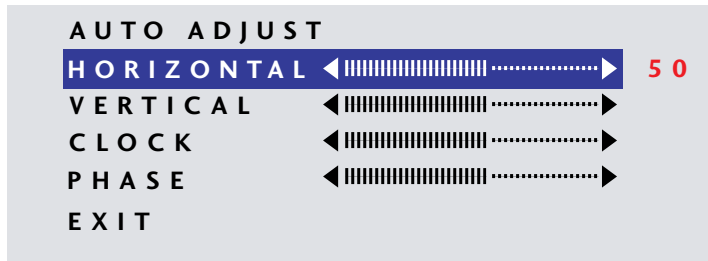

Pressing the UP button causes the screen to move to the right while pressing the DOWN button causes the screen to move to the left. A setting number in the range of 0 to 100 is displayed. Pressing SELECT again will deselect the HORIZONTAL menu option and the setting will be saved.

VERTICAL

With VERTICAL highlighted on the POSITION menu, pressing SELECT will display the VERTICAL adjustment menu. Pressing UP will cause the screen to move upward and pressing DOWN will cause the screen to move downward. A setting number in the range of 0 to 100 is displayed. Pressing SELECT again will deselect the VERTICAL adjustment menu and the setting will be saved.

CLOCK

With CLOCK highlighted on the POSITION menu, pressing SELECT will display the CLOCK adjustment menu. Pressing UP increases the CLOCK and causes the screen to increase in width. Pressing the DOWN button causes the CLOCK to decrease and the screen to reduce in width. A setting number in the range of 0 to 100 is displayed. Pressing SELECT again will deselect the CLOCK adjustment menu and the setting will be saved. Adjustment of this setting is normally not needed as it is automatically set to its optimum setting each time the monitor is turned on or when AUTO ADJUSTMENT is selected.

PHASE

With PHASE highlighted on the POSITION menu, pressing SELECT will display the PHASE adjustment menu. Pressing UP increases the PHASE. Pressing the DOWN button causes the PHASE to decrease. A setting number in the range of 0 to 100 is displayed. Pressing SELECT again will deselect the PHASE adjustment menu and the setting will be saved. Adjustment of this setting is normally not needed as it is automatically set to its optimum setting each time the monitor is turned on or when AUTO ADJUSTMENT is selected.

SETUP

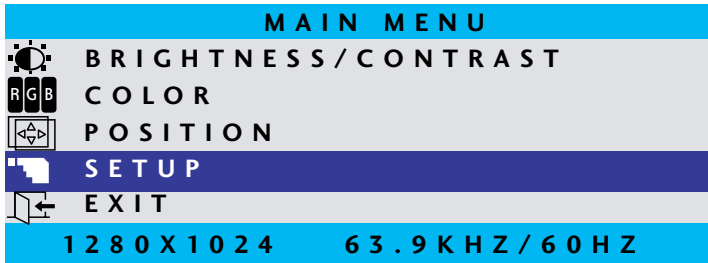

OSD POSITION

With **SETUP** highlighted on the **MAIN MENU** pressing **SELECT** will cause the following screen to be displayed:

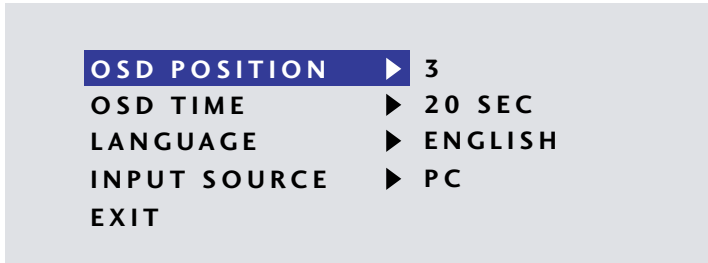

With the **OSD POSITION** highlighted on the **SETUP** menu, pressing **SELECT** will cause the following screen to be displayed:

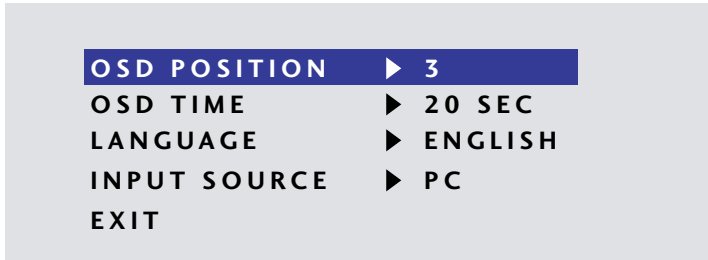

The default position of the OSD menu is 3 which is in the center of the screen. Pressing the **UP** or **DOWN** buttons will cause the OSD to move in the pattern below:

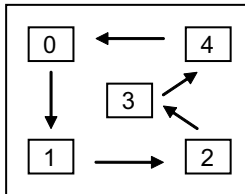

Pressing **SELECT** again will deselect the **OSD POSITION** adjustment menu and the setting will be saved.

OSD TIME

With OSD TIME highlighted on the SETUP menu, pressing SELECT will cause the following screen to be displayed:

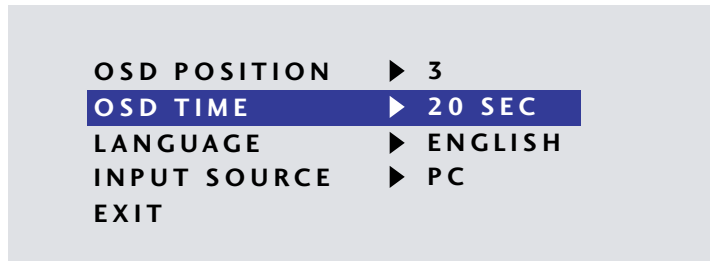

Pressing the UP and DOWN buttons will allow adjustment of the OSD time out setting in the range from 5 to 60 seconds. Pressing SELECT again will deselect the OSD TIME menu and save the current setting.

LANGUAGE

With LANGUAGE highlighted on the SETUP menu, pressing SELECT will cause the following screen to be displayed:

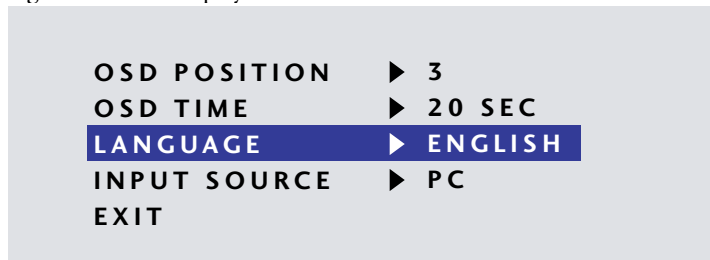

Pressing the UP and DOWN buttons allows the following LANGUAGE choices:

- ENGLISH
- FRANCAIS
- DEUTSCHE
- ITALIANO
- ESPANOL

Pressing SELECT will deselect the LANGUAGE option menu and save the current selection.

INPUT SOURCE

With INPUT POSITION highlighted on the SETUP menu, pressing SELECT will cause the following screen to be displayed:



3

OSD POSITION	▶	3
OSD TIME	▶	20 SEC
LANGUAGE	▶	ENGLISH
INPUT SOURCE	▶	PC
EXIT		

Pressing the UP and DOWN buttons switches between PC (the 15-pin analog VGA input connector) and DIGITAL (the DVI-D input connector) Pressing SELECT will deselect the INPUT SOURCE option menu and save the current selection.

OSD Message Displays

OUT OF FREQUENCY

The following OSD message will appear if the horizontal or vertical refresh rate of the incoming video signal is outside the range of the monitor.

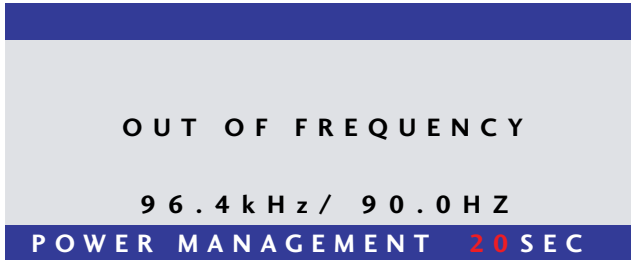

NO SIGNAL

When the monitor is first turned on it performs a set of self diagnostics. If no incoming video signal is detected immediately following self diagnostics, the following message will appear. This message will remain displayed indefinitely until a valid signal is detected. The LED remains green. The “PC” NO SIGNAL message indicates the monitor is setup to receive incoming video through the 15-pin analog VGA input connector.

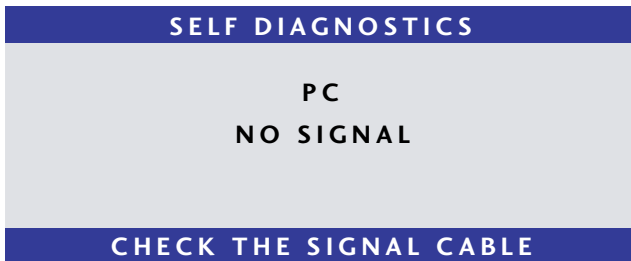

The “DIGITAL” NO SIGNAL message indicates the monitor is setup to receive incoming video through the DVI-D input connector.



POWER SAVER MODE

The following message appears when the monitor is on but in DPMS (Display Power Management Signaling) mode. This occurs after a valid incoming video signal is no longer present or when the PC has signaled the monitor to enter the POWER SAVER MODE. The message is displayed for 5 seconds and then removed. The LED remains amber. The “PC” POWER SAVER MODE message indicates the monitor is setup to receive incoming video through the 15-pin analog VGA input connector.

3



The “DIGITAL” POWER SAVER MODE message indicates the monitor is setup to receive incoming video through the DVI-D input connector.



PROCESSING AUTO CONFIGURATION

The following message appears when the monitor is performing an automatic self configuration. An auto configuration can be initiated by pressing the SELECT button with no OSD screen being displayed or by selecting the AUTO ADJUST option from the POSITION OSD menu.



HARDWARE CONNECTIONS



In this Appendix...

Video Input Pin Assignment.....	A-2
VGA Pin Assignment.....	A-3
Touch Screen Pin Assignment.....	A-4
Serial RS-232	A-4
USB	A-4

Video Input Pin Assignment

DVI-D

Pin No.	Name	Description
1	TMDS DATA2-	TMDS DATA2 Differential Negative Signal
2	TMDS DATA2+	TMDS DATA2 Differential Positive Signal
3	TMDS DATA2 Shield	Shield for TMDS Channel #2
4	N.C.	No Connection
5	N.C.	No Connection
6	DDC Clock	The Data Line for the DDC Interface
7	DDC Data	The Clock Line for the DDC Interface
8	N.C.	No Connection
9	TMDS DATA1-	TMDS DATA1 Differential Negative Signal
10	TMDS DATA1+	TMDS DATA1 Differential Positive Signal
11	TMDS DATA1 Shield	Shield for TMDS Channel #1
12	N.C.	No Connection
13	N.C.	No Connection
14	+5V Power	+5 Volt signal for EDID
15	GND (+5V Return)	Ground for +5 Volt Power
16	HPD	Hot Plug Detect
17	TMDS DATA0-	TMDS DATA0 Differential Negative Signal
18	TMDS DATA0+	TMDS DATA0 Differential Positive Signal
19	TMDS DATA0 Shield	Shield for TMDS Channel #0
20	N.C.	No Connection
21	N.C.	No Connection
22	TMDS CLOCK Shield	Shield for TMDS Clock Differential Pair
23	TMDS CLOCK+	TMDS CLOCK Differential Positive Signal
24	TMDS CLOCK-	TMDS CLOCK Differential Negative Signal

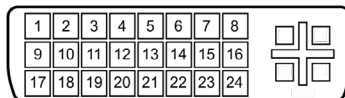

VGA Pin Assignment

Analog 15-Pin D-Sub

Pin No.	Name	Description
1	Red	Red Analog Data
2	Green	Green Analog Data
3	Blue	Blue Analog Data
4	GND	Ground
5	GND	Ground
6	GND	Ground
7	GND	Ground
8	GND	Ground
9	N.C.	No Connection
10	GND	Ground
11	GND	Ground
12	DSDA	DDC Serial Data
13	HSYNC	Horizontal Sync
14	VSYNC	Vertical Sync
15	DSCL	DDC Serial Clock

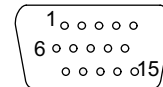

Touch Screen Pin Assignment

Serial RS-232

Pin No.	Name	Description
1	DCD	Data Carrier Detect
2	RX	Receive Data
3	TX	Transmit Data
4	DTR	Data Terminal Ready
5	GND	Ground
6	DSR	Data Set Ready
7	RTS	Request To Send
8	CTS	Clear To Send
9	RI	Ring Indicator

Baud Rate	9600
Data Size	8 Bits
Stop Bits	1 Bit
Parity	No Parity (Only)
Handshaking	Hardware CTS/RTS

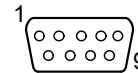

USB

Pin No.	Name	Description
1	VBUS	+5V Power
2	USB_D-	USB Data -
3	USB_D+	USB Data +
4	GND	Ground

USB-B CONNECTOR ON
REAR OF MONITOR

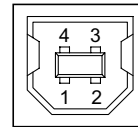

Note: The touch controller receives its power from the monitor's internal power supply - not through the USB connector.

