

RPA455 / RPA455x / RPA455xx

Smart Paint Scales

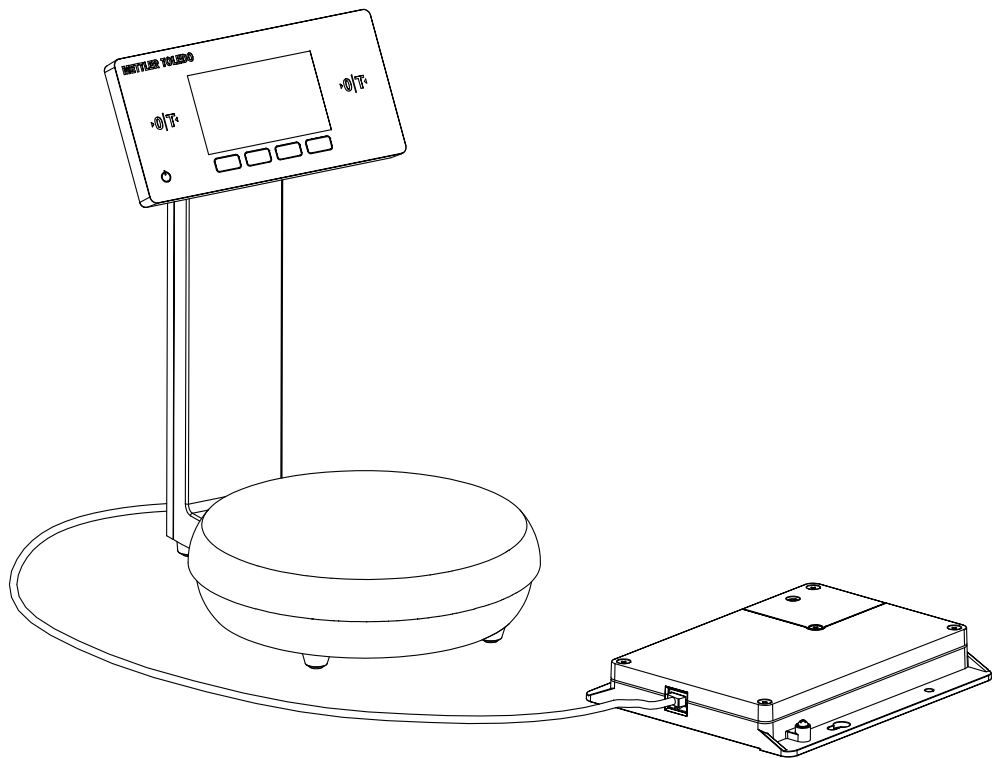

METTLER TOLEDO

METTLER TOLEDO Service

Congratulations on choosing the quality and precision of METTLER TOLEDO. Proper use of your new equipment according to this User manual and regular calibration and maintenance by our factory-trained service team ensures dependable and accurate operation, protecting your investment. Contact us about a service agreement tailored to your needs and budget. Further information is available at www.mt.com/service.

There are several important ways to ensure you maximize the performance of your investment:

- 1. Register your product:** We invite you to register your product at www.mt.com/productregistration so we can contact you about enhancements, updates and important notifications concerning your product.
- 2. Contact METTLER TOLEDO for service:** The value of a measurement is proportional to its accuracy – an out of specification scale can diminish quality, reduce profits and increase liability. Timely service from METTLER TOLEDO will ensure accuracy and optimize uptime and equipment life.
 - a. Installation, Configuration, Integration and Training:** Our service representatives are factory-trained, weighing equipment experts. We make certain that your weighing equipment is ready for production in a cost effective and timely fashion and that personnel are trained for success.
 - b. Initial Calibration Documentation:** The installation environment and application requirements are unique for every industrial scale so performance must be tested and certified. Our calibration services and certificates document accuracy to ensure production quality and provide a quality system record of performance.
 - c. Periodic Calibration Maintenance:** A Calibration Service Agreement provides on-going confidence in your weighing process and documentation of compliance with requirements. We offer a variety of service plans that are scheduled to meet your needs and designed to fit your budget.
 - d. GWP® Verification:** A risk-based approach for managing weighing equipment allows for control and improvement of the entire measuring process, which ensures reproducible product quality and minimizes process costs. GWP (Good Weighing Practice), the science-based standard for efficient life-cycle management of weighing equipment, gives clear answers about how to specify, calibrate and ensure accuracy of weighing equipment, independent of make or brand.

© METTLER TOLEDO 2019

No part of this manual may be reproduced or transmitted in any form or by any means, electronic or mechanical, including photocopying and recording, for any purpose without the express written permission of METTLER TOLEDO.

U.S. Government Restricted Rights: This documentation is furnished with Restricted Rights.

Copyright 2019 METTLER TOLEDO. This documentation contains proprietary information of METTLER TOLEDO. It may not be copied in whole or in part without the express written consent of METTLER TOLEDO.

METTLER TOLEDO reserves the right to make refinements or changes to the product or manual without notice.

COPYRIGHT

METTLER TOLEDO® is a registered trademark of Mettler-Toledo, LLC. All other brand or product names are trademarks or registered trademarks of their respective companies.

METTLER TOLEDO RESERVES THE RIGHT TO MAKE REFINEMENTS OR CHANGES WITHOUT NOTICE.

FCC Notice

This device complies with Part 15 of the FCC Rules and the Radio Interference Requirements of the Canadian Department of Communications. Operation is subject to the following conditions: (1) this device may not cause harmful interference, and (2) this device must accept any interference received, including interference that may cause undesired operation.







This equipment has been tested and found to comply with the limits for a Class A digital device, pursuant to Part 15 of FCC Rules. These limits are designed to provide reasonable protection against harmful interference when the equipment is operated in a commercial environment. This equipment generates, uses, and can radiate radio frequency energy and, if not installed and used in accordance with the instruction manual, may cause harmful interference to radio communications. Operation of this equipment in a residential area is likely to cause harmful interference in which case the user will be required to correct the interference at his or her expense.

RoHS Compliance Statement.



- In 2006, the European Union (EU) Directive on the Restriction of the use of certain Hazardous Substances (RoHS, 2002/95/EU) went into effect. In 2011, the EU RoHS Directive was recast (2011/65/EU) and went into effect January 3, 2013. The Directive is to restrict the use of cadmium, hexavalent chromium, lead, mercury and certain halogenated flame retardants (PBBs and PBDEs) in electronic products. In 2015, EU RoHS was amended (2015/863/EU) to restrict four phthalates (DEHP, BBP, DBP, DIBP) by July 22, 2019.
- Based on these inquiries and other procedures, METTLER TOLEDO fulfills its requirements of RoHS and that our products fully comply with the above mentioned Directive.





Safety Instructions

- Read this manual carefully before operating or servicing the scale.
- Strictly observe this manual and save it for future use.

	⚠ WARNING
	Only permit qualified personnel to make checks, tests and adjustments to be carried out with power on. Failing to observe these precautions can result in bodily harm.
	⚠ WARNING
	Always disconnect the scale from the USB power & data barrier before installing, servicing, cleaning or performing maintenance.
	⚠ WARNING
	Check the cable of the AC adapter and USB power & data barrier regularly. The scale must not be used when the cable is damaged.
	⚠ CAUTION
	Treat the scale carefully. Knocks to the weighing platter or overloading it excessively will damage the scale.
	⚠ CAUTION
	Only use recommended accessories and peripherals.
	⚠ CAUTION
	Do not open the scale. The warranty is void if this stipulation is ignored. The scale may only be opened by authorized personnel.

Cautionary Notes Regarding Installation

	⚠ WARNING
	Do not operate the scale if its housing, USB power & data barrier, AC adapter including all connections are damaged. Disconnect the damaged device from the power.
	⚠ CAUTION
	The device must only be used indoor. Avoid generating static electricity on glass and plastic parts. Only clean the devices as stipulated in the cleaning instructions, and disconnect the devices from the power before cleaning.

	<p style="text-align: center;">⚠ CAUTION</p> <p>Do not touch the surface of the touch screen with sharp, pointed, rough, or hard objects. Take care of the glass panel, in case it is damaged, disconnect the device from the power immediately.</p>
	<p style="text-align: center;">⚠ CAUTION</p> <p>Lay the cables where they will not be damaged by any sharp edges or pose any risk of causing someone to trip.</p>
	<p style="text-align: center;">⚠ CAUTION</p> <p>The device meets IP40 protection rating requirements. Please handle this device according to its IP protection rating and properly secure the environment where the device operates.</p>
	<p style="text-align: center;">⚠ CAUTION</p> <p>Only use accessories supplied by METTLER TOLEDO. Make sure that the voltage rating printed on the AC adapter is identical to your local mains voltage. It is essential to comply with national regulations regarding grounding connections.</p>
	<p style="text-align: center;">⚠ CAUTION</p> <p>Do not expose the device to extreme temperatures, aggressive chemical vapors, shocks, moisture, vibrations, or strong electromagnetic fields. Chemicals must be kept away from cables, plastic covers, and other corrosion prone components.</p>

RPA455 / RPA455x / RPA455xx User Manual Change Notice

Date (MM/DD/YYYY)	Changes	Revision
11/12/2019	Official Launch	A

Table of Contents

Safety Instructions	4
RPA455 / RPA455x / RPA455xx User Manual Change Notice	6
1 Introduction	9
1.1 About This Manual	9
1.2 Intended Use	9
1.2.1 Application Areas	9
1.2.2 Ambient Conditions	9
1.3 Product Overview	9
1.3.1 Scale.....	9
1.3.1.1 Overview	10
1.3.1.2 Touch Panel.....	11
1.3.1.3 Main Screen.....	11
1.3.2 USB Power & Data Barrier.....	13
1.3.2.1 Overview	13
2 Installation	14
2.1 Unpacking and Inspection	14
2.2 Selecting the Location.....	14
2.3 Scale Configurations.....	14
2.4 Installing RPA455 in Non-hazardous Area	15
2.5 Installing RPA455x in Hazardous Area Zone 1/ Division 1	15
2.6 Installing RPA455xx in Hazardous Area Zone 2.....	16
2.7 Levelling	17
2.8 Warming Up.....	17
3 Operation	18
3.1 Switching On or Off	18
3.2 Zeroing / Taring the Scale.....	18
3.3 Applications	18
3.3.1 Factor Weighing	19
3.3.1.1 Setting Factors.....	19
3.3.2 Mixing without Formula	20
3.3.3 Mixing with Formula.....	22
3.3.3.1 Checking Formula Information.....	22
3.3.3.2 Setting Target Amount.....	23
3.3.3.3 Mixing with a Formula.....	24
3.3.4 Managing Formulas	27
3.3.4.1 Adding a Formula	27
3.3.4.2 Deleting a Formula	28
3.3.4.3 Editing a Formula	29
4 Setup and Configuration	30
4.1 Menu Setting Structure Overview	30
4.2 Scale Setting.....	32

4.2.1	Scale Settings	32
4.2.1.1	Approval	32
4.2.1.2	PowerMem	32
4.3	Calibration	33
4.4	Terminal	34
4.4.1	Terminal Settings	34
4.4.1.1	Soft Keys	34
4.5	Communication	35
4.5.1	Communication Settings	35
4.5.1.1	Network	35
4.6	Maintenance	38
4.6.1	Maintenance Settings	38
4.6.1.1	Scale Lock	38
4.6.1.2	Password	39
5	Maintenance and Service	40
5.1	Cleaning	40
5.2	Maintenance	40
5.3	Storage	40
5.4	Disposal	40
6	Advanced Trouble-Shootings	42
7	Spare Parts	43
7.1	Accessories	43
7.2	Spare Parts	44
8	Repair	45
8.1	Replacing the Display Column or the Weighing Platform	45
Appendix		46
B)	Technical Data	46
C)	Dimensions	47
	Dimensions for Standard Scale Configuration	47
	Dimensions for Wall-Mount Configuration	47
	Dimensions for Scale Base-Only Configuration	48
	Dimensions of USB Power & Data Barrier	48
D)	Control Drawings	49
E)	Label Drawings	53
F)	GEO Code Values	54

1 Introduction

1.1 About This Manual

This manual contains information about installing, operating and maintaining the scale, as well as all requirements necessary for safe use of the system. For more information about this product, please visit www.mt.com/ind-paint-mixing-scale.

This manual applies to the following smart paint scales:

- RPA455
- RPA455x
- RPA455xx

1.2 Intended Use

Use RPA455, RPA455x or RPA455xx for weighing only. Any other type of use and operation beyond the limits of technical specifications without written consent from Mettler-Toledo is considered as not intended.

1.2.1 Application Areas

- RPA455 is for use in non-hazardous areas.
- RPA455x is for use in hazardous areas classified as
 - EN / IEC: Zone 1
 - North America: Division 1 / Zone 1
- RPA455xx is for use in hazardous areas classified as
 - EN / IEC: Zone 2

1.2.2 Ambient Conditions

The environment where this scale is operated should meet the following requirements:

- Indoor environment.
- Temperatures and humidity:
 - 0°C to 40°C (32°F to 104°F) at 10% to 85% relative humidity non-condensing
 - 0°C to 35°C (32°F to 95°F) at 10% to 85% relative humidity non-condensing (for metrological approved models)

1.3 Product Overview

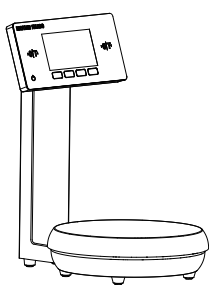

1.3.1 Scale

RPA455, RPA455x and RPA455xx are a series of smart paint scales designed for the automotive refinish market and respond to the request for high-value and high cost-performance refinish solutions with the following features:

- Modular design: The scale base, display and display column are independently

designed, which gives customers more options when designing their refinish solution:

- Standard scale configuration with a scale base and a display installed on a display column;
- Wall-mount configuration with a scale base and a display installed on a wall-mount bracket;
- Scale base-only configuration to merge into their existing refinish solution.
- 4.3 inch colored TFT display: Offers wider visual angle and high contrast and enhances user experience with intuitive GUI operation.
- Touch panel with two Zero/Tare buttons: Ergonomic design allows either right-handed or left-handed scale operation.
- RJ45 interface: Provides both power and communication capabilities through one cable.
- Digital load cell: mature digital load cell technology by Mettler Toledo guarantees uncompromised weighing performance and stability even after years of use.

1.3.1.1 Overview

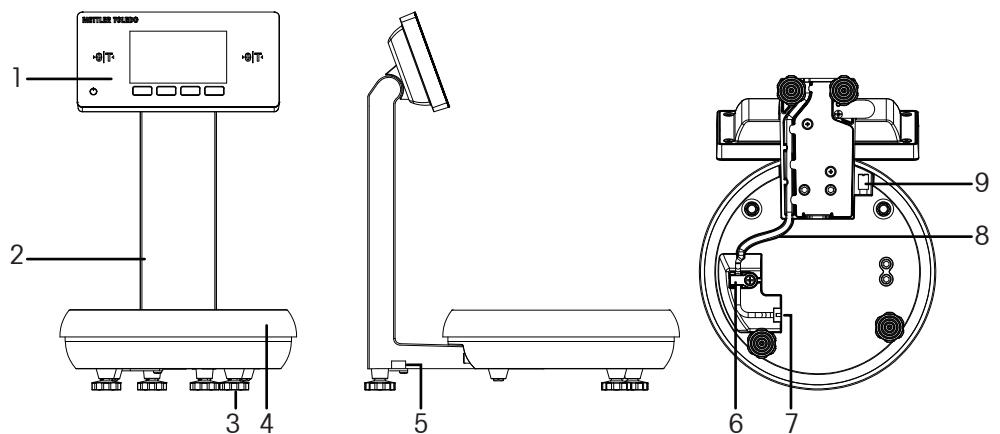

No.	Description
1	Touch panel
2	Display column (optional, not available on base-only and wall-mount configurations)
3	Feet (adjustable on metrologically approved scales)
4	Weighing platter
5	Levelling bubble (only available on metrologically approved scales)
6	Cable clamp
7	RJ45 connector
8	Cable
9	Grounding bolt (only available on RPA455x, RPA455xx scales)

1.3.1.2 Touch Panel







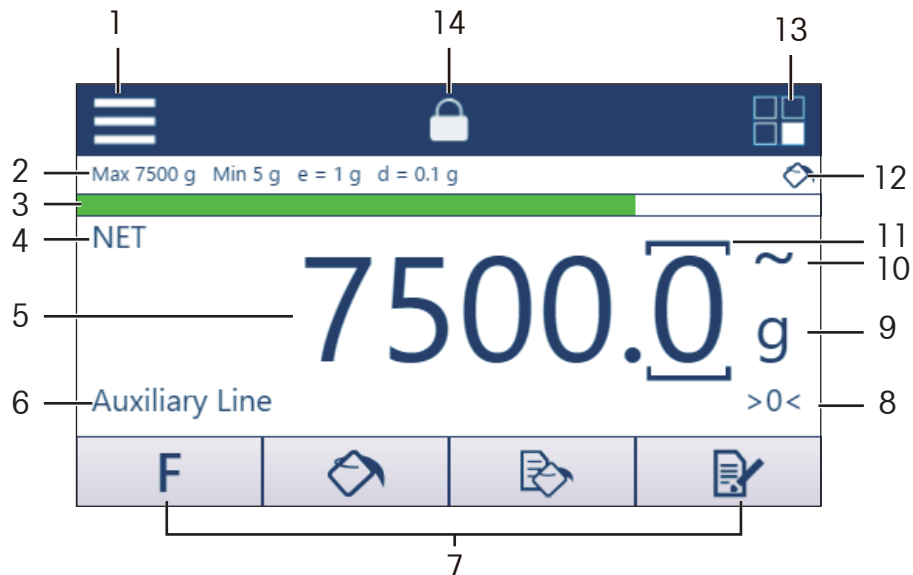



No.	Description
1	Power button: Press and hold the button to power on or off the scale.
2	Zero/Tare button: Press the button to zero or tare.
3	Function keys: Have identical functions as the soft keys shown in each screen.

1.3.1.3 Main Screen



No.	Description
1	Menu setting button
2	Metrological data <ul style="list-style-type: none"> • Max: Maximum capacity • Min: Minimum capacity • e: Approved resolution • d: Display resolution

No.	Description
3	<p>Progress bargraph (only available in Mixing with Formula mode)</p> <ul style="list-style-type: none"> • Yellow (): The target weight is not achieved. • Green (): The target weight is achieved. • Red (): The target weight is exceeded.
4	Net value indicator
5	Weight value
6	Auxiliary line: Shows operation instructions.
7	<p>Function keys</p> <ul style="list-style-type: none"> • F (Factor Value Setting): Allows the user to weigh a paint mix 0.1 up to 7 times the formula of a fixed weight. •  (Mixing without Formula): For paint mixing when there's no locally saved formula in the scale nor remote formula received from a PC. •  (Mixing with Formula): For paint mixing based on formulas stored in the scale. •  (Formula Management): Allows the user to add, delete, or edit formulas and ingredients. •  (BBA242 Mode): Switches the scale to BBA242 mode. For operation instructions in this mode, refer to BBA242 user manual.
8	Zero indicator
9	Unit indicator
10	Motion indicator: Zero or tare the scale only when the motion indicator disappears (i.e. when the scale is stable).
11	Brackets: Only appears in metrologically approved scales where e does not equal to d.
12	<p>Status indicators</p> <ul style="list-style-type: none"> •  : Mixing without Formula mode. •  : Mixing with Formula mode.
13	Quick enter into application
14	Display lock

1.3.2 USB Power & Data Barrier

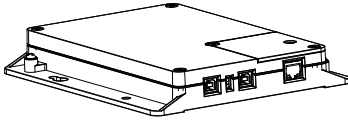

APS455x / APS455xx USB power & data barrier is an associated intrinsically safe power supply with standard USB and upgradable Ethernet communication functions, and is intended to be used in environment meeting following requirements:

- Indoor environment, IP40 in accordance with EN 60529 / IEC 60529.
- Temperatures ranging from 0°C to 40°C (32°F to 104°F).
- 10% to 90% relative humidity non-condensing.

1.3.2.1 Overview

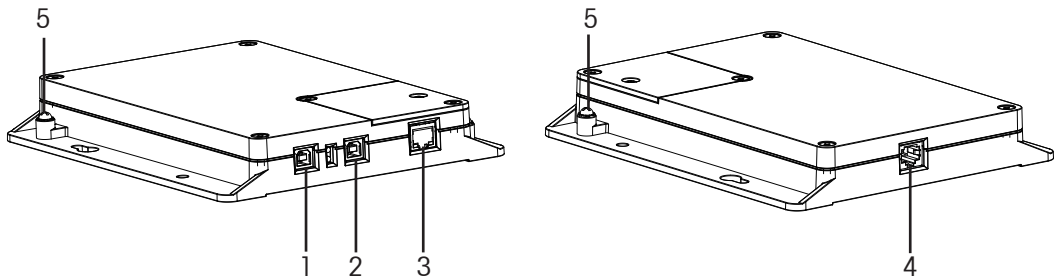

No.	Description
1	USB/Power connector: USB type B for power input and communication. Connect this to a PC.
2	Power input: USB type B for power input only. Connect this to the power adaptor supplied.
3	RJ45 connector: Optional. For Ethernet connection.
4	RJ45 connector: For intrinsic safety power output and communication. Connect this to the scale.
5	Grounding bolt: Choose one of the them to ground the USB power & data barrier.

2 Installation

2.1 Unpacking and Inspection

Check the contents and inspect the supply immediately upon delivery. If the shipping container is damaged upon arrival, check the contents for damage and, if necessary, submit a damage claim to the transport agency. If the container is not damaged, remove the device from the protective packaging; note how it was packaged and check all components for damage.

If the device must be shipped again, the original packaging should be reused. The device must be correctly packed to ensure safe transportation. Unplug all cables before transporting.

2.2 Selecting the Location

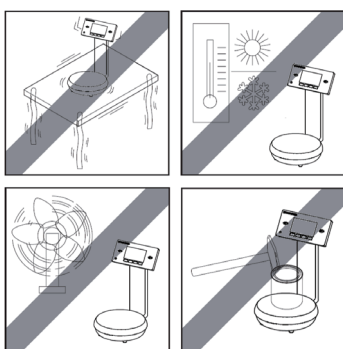

For accurate weighing results, care must be taken to select the optimal location for the scale!

- Place the scale on a stable surface which is free of vibrations and as horizontal as possible.
- Avoid excessively fluctuating temperatures and direct sunlight. Ensure correct environment conditions.
- Avoid drafts (for example, from fans or air conditioner).
- Never use a hammer to close paint cans on the weighing platter.



NOTE:

Condensation from humidity can form on the surfaces of a cold device when it is brought into a substantially warmer area.

Disconnect the device from power and allow it to acclimatize for approximately 2 hours before reconnecting it to the power.

2.3 Scale Configurations

RPA455, RPA455x and RPA455xx support standard, wall-mount, and base-only configurations to meet different installation requirements in customer site. For dimensions of each configuration, please go to "C) Dimensions" on Page 47.

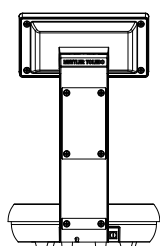

Standard Configuration

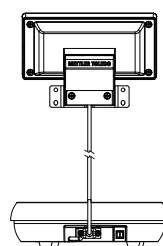

Wall-mount Configuration



Base-only Configuration

2.4 Installing RPA455 in Non-hazardous Area

RPA455 is designed for use in safe areas. Choose one of the following two wiring solutions to install RPA455.

Solution 1: Wiring for power input only

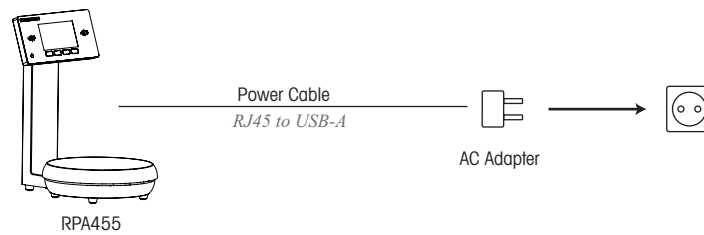

Solution 2: Wiring for power input and RS232 communications

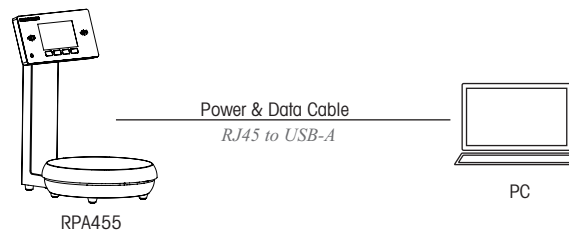

2.5 Installing RPA455x in Hazardous Area Zone 1/ Division 1

RPA455x is designed for use in hazardous area Zone 1 / Division 1. Choose one of the following two wiring solutions to install RPA455x.

Please note that both RPA455x and APS455x must be grounded.

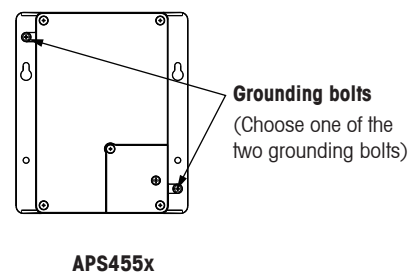
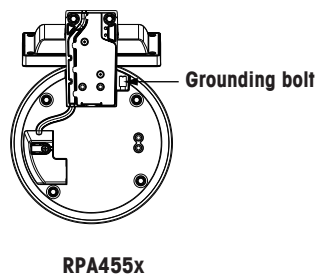

Solution 1: Wiring for power input and RS232 communications through APS455x

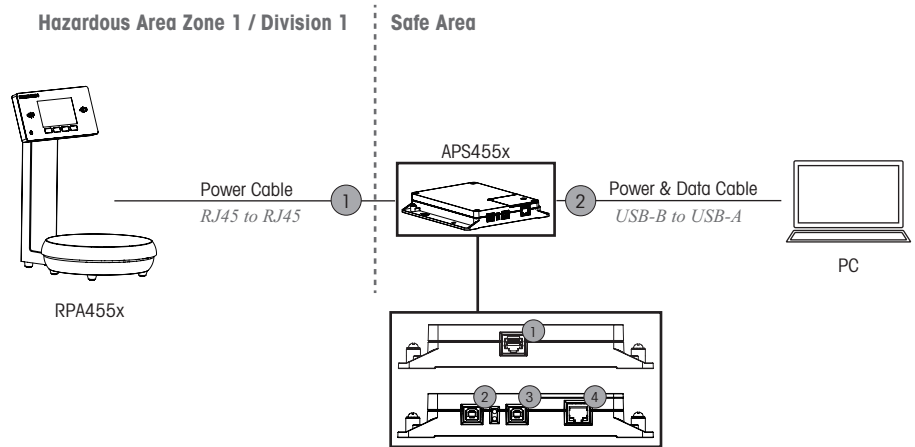

Solution 2: Wiring for power input and Ethernet communications through APS455x and AC adapter

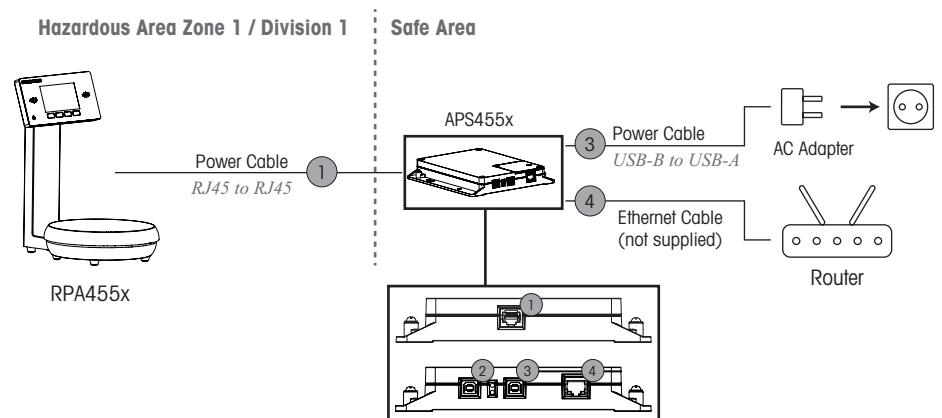

2.6 Installing RPA455xx in Hazardous Area Zone 2

RPA455xx is designed for use in hazardous area Zone 2. Choose one of the following two wiring solutions to install RPA455xx.

Solution 1: Wiring for power input and RS232 communications

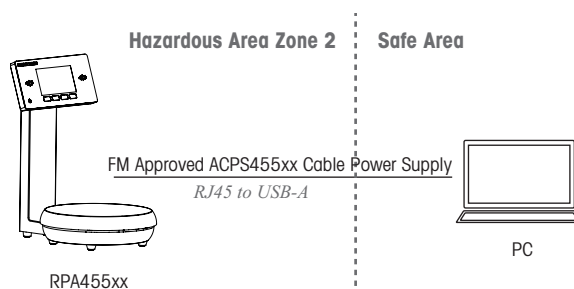

Solution 2: Wiring for power input and Ethernet communications through APS455xx and AC adapter

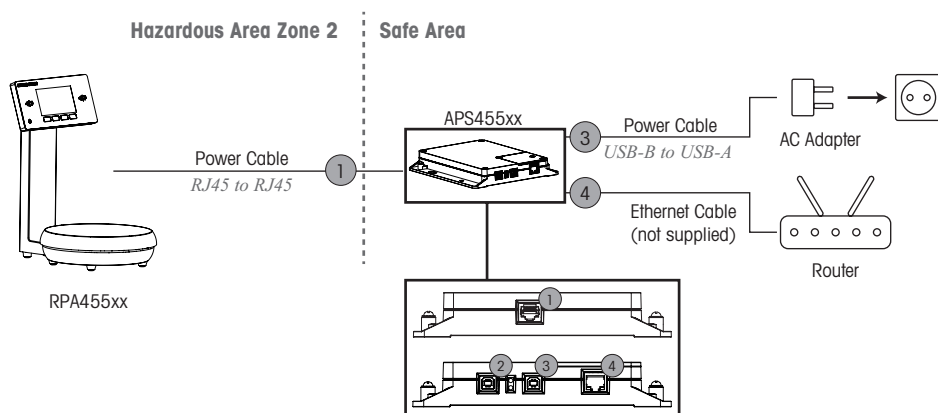

2.7 Levelling

The scale should be perfectly horizontal to ensure consistent, reproducible weighing results. Relevel the scale each time its location is changed.

Please note that all metrologically approved scales are providing a levelling bubble.

→ Turn the adjustable feet until the level bubble is within the ring marking.

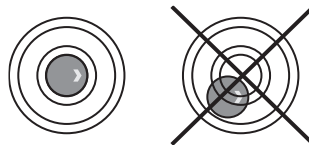

2.8 Warming Up



→ Warm up the scale for at least 30 minutes after initial connection to the USB power & data barrier.

▲ Doing so allows the scale to reach the required operating temperature and, consequently, deliver accurate weighing results.

3 Operation

3.1 Switching On or Off

Switching On

- Press and hold the Power button  until the display lights go on. As soon as the weight display appears, the scale is ready for operation.

Switching Off

- Press and hold the Power button  until the display lights go out.

3.2 Zeroing / Taring the Scale

1. Place an empty container on the scale.
2. Press any of the two Zero/Tare buttons  to zero or tare the scale. The zero weight value appears.



NOTE:

The two Zero/Tare buttons  have the identical zero and tare function and allow either right-handed or left-handed scale operation.

3.3 Applications

There are four application buttons on the main screen, from where you can quickly start factor weighing, mixing without a formula, mixing with a formula, or managing formulas.



Alternatively, you may press  in the main screen to enter into applications.



3.3.1 Factor Weighing

Factor weighing **F** allows you to weigh a paint mix 0.1 up to 7 times the formula of a fixed weight and save the effort of recalculation.

The following example shows how factor weighing works:

Example



The weight value on the display is 1000 g. The factor is set to 0.2. Then the actual weight is 200 g.

$$\begin{array}{r} 1000 \text{ g} \\ \times 0.2 \\ \hline \text{Actual weight: } 200 \text{ g} \end{array}$$

3.3.1.1 Setting Factors

There are two ways to set the factor value, either in the main screen or in the Factor Value Setting screen.

Setting factors in the main screen

→ Press **F** to toggle between the factor values of 0.2, 0.5, 0.75, 1.5, 2.0, 3.0, 4.0, 5.0.



TIPS:

- When the factor is set to a value other than 1, pressing and holding **F** resets the factor to 1.
- When the factor is 1, pressing and holding **F** navigates the display to the Factor Value Setting.

Setting factors in the Factor Value Setting screen

1. Press Factor Value Setting in the Application screen.



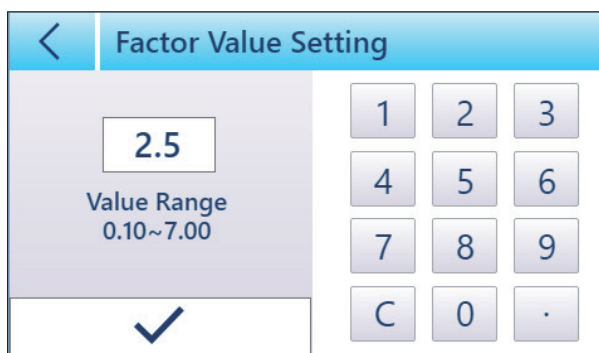

2. Set the desired factor in the Factor Value Setting screen, then press ✓ to confirm.



3.3.2 Mixing without Formula

Mixing without Formula  is useful when there's no locally saved formula in the scale nor remote formula received from a PC.



There are two ways to enter into the Mixing without Formula mode:

- Press  in the main screen. Or
- Press  Mixing without Formula in the Application screen.

Then the Mixing without Formula screen appears.



To mix without a formula, do as follows:

1. Press **F** to select a factor value, if necessary. See "3.3.1.1 Setting Factors" on Page 19 for more information about factor setting.
2. Place an container on the scale, press  to tare, then press  to start.

- Fill the container with the first ingredient.



NOTE:

The Factor Setting button is disabled (greyed out) during the process of mixing.

- Press or to confirm the weight and get ready for the next ingredient.

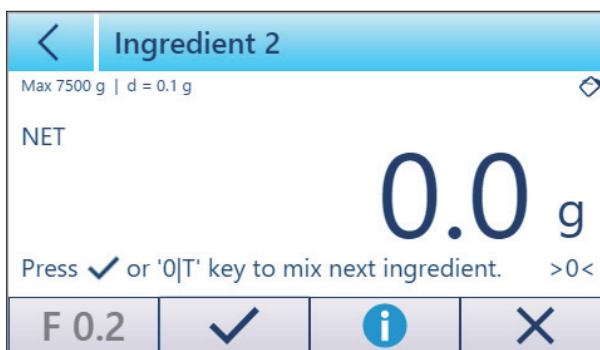

- Repeat Step 3-4 to fill and weigh the rest ingredients.
- To check for mixing information, press . Then the screen navigates to the Mixing Information screen. Use the scroll bar or the / to see all the ingredients. Use to go back and continue mixing.



- To adjust weight of any ingredient, select the ingredient in the Mixing Information screen, then press . Fill the container with the ingredient selected till its target weight, then press or to confirm. Repeat this step until all ingredients meet their target weight.



8. When weighing and mixing is done, press . Then press in the following dialog.

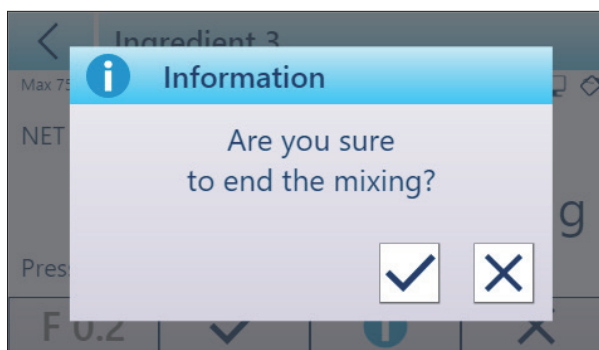

3.3.3 Mixing with Formula

Mixing with Formula allows you to mix based on formulas stored in the scale.

There are two ways to enter into the Mixing with Formula mode:

- Press in the main screen. Or
- Press Mixing with Formula in the Application screen.

Then the Select Formula screen appears.



3.3.3.1 Checking Formula Information

1. Select the target formula in the Select Formula screen.
2. Press . Then the display navigates to the Formula Information screen where ingredients of the selected formula are shown.

Formula: MT00000005 Mettler Toledo Special Formula 05			
Code	Name	Wt. (g)	Tol. (g)
2000	White	383.8	5.0
2001	Wine Red	365.2	5.0
2002	Black	308.0	5.0
2003	Earth Yellow	26.4	1.0

3.3.3.2 Setting Target Amount

Setting target amount in the Target Amount screen

1. Select the target formula in the Select Formula screen.

Select Formula	
Formula Code	Formula Color Name
MT00000000	Mettler Toledo Special Formula 00
MT00000001	Mettler Toledo Special Formula 01
MT00000005	Mettler Toledo Special Formula 05
MT00000003	Mettler Toledo Special Formula 03



× 1.00

2. Press the Target Amount button , or press and hold the Times button × 1.00, then the display navigates to the Target Amount screen.

Target Amount													
0.10	<table border="1"> <tr><td>1</td><td>2</td><td>3</td></tr> <tr><td>4</td><td>5</td><td>6</td></tr> <tr><td>7</td><td>8</td><td>9</td></tr> <tr><td>C</td><td>0</td><td>.</td></tr> </table>	1	2	3	4	5	6	7	8	9	C	0	.
1	2	3											
4	5	6											
7	8	9											
C	0	.											
Value Range 0.10~7.00													
													

3. Set the target amount volume, then press  to confirm.
4. Then the display returns to the Select Formula screen. The target amount value changes accordingly.

Select Formula	
Formula Code	Formula Color Name
MT00000000	Mettler Toledo Special Formula 00
MT00000001	Mettler Toledo Special Formula 01
MT00000005	Mettler Toledo Special Formula 05
MT00000003	Mettler Toledo Special Formula 03



× 0.10

Setting target amount through the Times button

1. Select the target formula in the Select Formula screen.



2. Press the Times button $\times 1.00$ to toggle between target amount values of $\times 0.20$, $\times 0.50$, $\times 0.75$, $\times 1.50$, $\times 2.00$, $\times 3.00$, $\times 4.00$, $\times 5.00$.



3.3.3.3 Mixing with a Formula

To mix with a formula, do as follows:

1. Select the target formula in the Select Formula screen, then press \checkmark to confirm.



2. Place a container on the scale, press $\text{O}|\text{T}$ to tare, then press \blacktriangleright to start.



3. Fill the container with the ingredient shown.

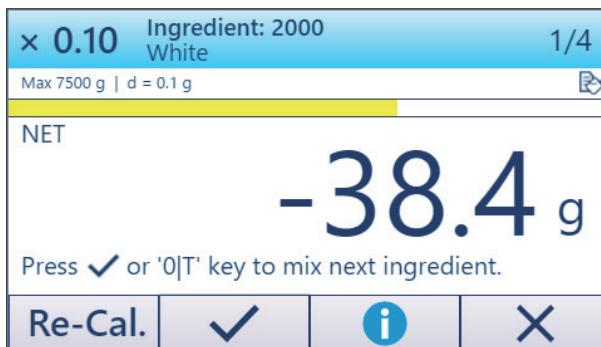

NOTE:

1 / 4 indicates progress of the paint mixing.



4. When the progress bargraph turns green, stop filling and press ✓ to confirm the weight and get ready for the next ingredient.

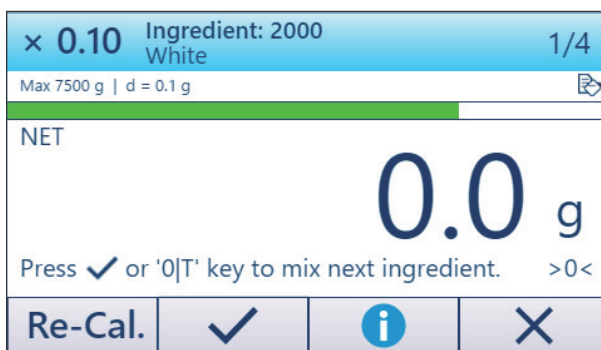

5. Repeat Step 3 -4 to fill and weigh the rest ingredients.

6. After weighing the last ingredient, press ✓, then the following screen appears. The actual weight / mix weight of each ingredient is highlighted.

Formula: MT0000005 Mettler Toledo Special Formula 05			
Code	Name	Recipe Wt. (g)	Mix Wt. (g)
2000	White	38.4	38.4
2001	Wine Red	36.5	36.5
2002	Black	30.8	30.8
2003	Earth Yellow	2.6	2.6

Recalculate ✕

7. Press ✕ to end mixing.

Recalculating when an ingredient outweighs its target weight

If there's any ingredient outweighs its target weight (i.e. ingredient weight is highlighted in red), use the Recalculation button **Re-cal./Recalculate** to recalculate the weight of the entire formula and each ingredient.

You may recalculate during or after the mixing process.

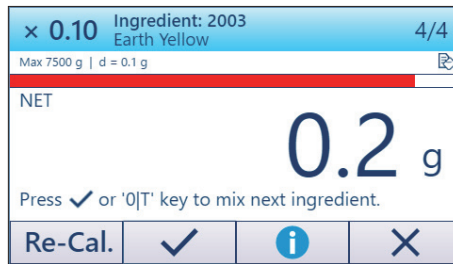

During mixing

Formula: MT00000005 Mettler Toledo Special Formula 05			
Code	Name	Recipe Wt. (g)	Mix Wt. (g)
2000	White	38.4	38.4
2001	Wine Red	36.5	36.5
2002	Black	30.8	30.8
2003	Earth Yellow	2.6	2.8

Buttons: Recalculate, X

After mixing

To recalculate, do as follows:

1. Press **Re-cal./Recalculate** during or after mixing.
2. The display navigates to the first ingredient. Target amount on the upper left corner changes after recalculation.

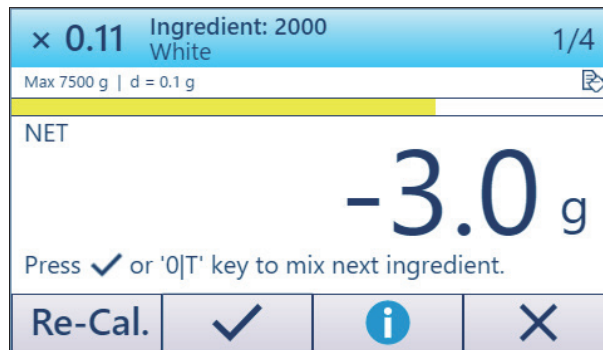

NOTE:

Target amount on the upper left corner changes after recalculation.

3. Fill the ingredient till the progress bargraph turns green. Then press ✓ to confirm the weight and get ready for the next ingredient.

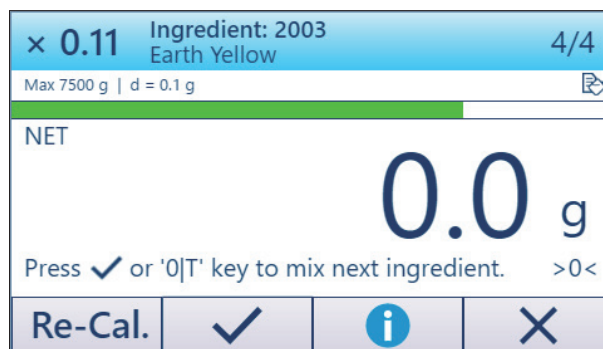

4. Do not fill if any ingredient has already reached its target weight (i.e the process bargraph shows green). Simply press ✓ to confirm and skip to the next ingredient.
5. When each ingredient reaches the recalculated weight, press X to end mixing.

Formula: MT00000005 Mettler Toledo Special Formula 05			
Code	Name	Recipe Wt. (g)	Mix Wt. (g)
2000	White	41.4	41.4
2001	Wine Red	39.3	39.3
2002	Black	33.2	33.2
2003	Earth Yellow	2.8	2.8

Recalculate
✕

3.3.4 Managing Formulas

Formula Management screen allows you to add, delete or edit formulas and ingredients.

Formula Management	
Formula Code	Formula Color Name
MT00000000	Mettler Toledo Special Formula 00
MT00000001	Mettler Toledo Special Formula 01
MT00000002	Mettler Toledo Special Formula 02
MT00000003	Mettler Toledo Special Formula 03

+
🗑️
✎
➤

3.3.4.1 Adding a Formula

1. Press **+** in the Formula Management screen. Then a new blank entry appears.

Formula Management	
Formula Code	Formula Color Name
MT00000000	Mettler Toledo Special Formula 00
MT00000001	Mettler Toledo Special Formula 01
MT00000002	Mettler Toledo Special Formula 02

+
🗑️
✎
➤

2. Press **✎** to edit the formula code.
3. Select the formula color name entry, then press **✎** to edit the formula name.



Formula Management	
Formula Code	Formula Color Name
MT00000000	Mettler Toledo Special Formula 00
MT00000001	Mettler Toledo Special Formula 01
MT00000005	Mettler Toledo Special Formula 05
MT00000002	Mettler Toledo Special Formula 02

+
🗑️
✎
➤



4. Select either the formula code or the formula color name, then press **➤** to add

ingredients in the following screen.

Formula: MT00000005 Mettler Toledo Special Formula 05			
Code	Name	Wt. (g)	Tol. (g)
Total		0.0	

5. Press , then a new blank entry appears.
6. Press  to edit the ingredient code.
7. Repeat so to edit ingredient name, weight and tolerance.
8. Repeat step 5-7 to add more ingredients.



Formula: MT00000005 Mettler Toledo Special Formula 05			
Code	Name	Wt. (g)	Tol. (g)
2000	White	383.8	5.0
2001	Wine Red	365.2	5.0
2002	Black	308.0	5.0
2003	Earth Yellow	26.4	1.0

9. Use  to continue adding new ingredient, use  to delete any ingredient or  to edit any ingredient.

3.3.4.2 Deleting a Formula

1. Press either the formula code or formula color name to select a formula.

Formula Management	
Formula Code	Formula Color Name
MT00000000	Mettler Toledo Special Formula 00
MT00000001	Mettler Toledo Special Formula 01
MT00000005	Mettler Toledo Special Formula 05
MT00000002	Mettler Toledo Special Formula 02

2. Press .
3. Press  in the following dialog.

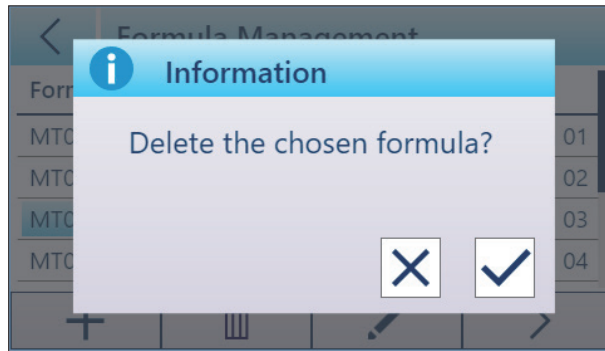

3.3.4.3 Editing a Formula

→ Select the formula entry, then press to edit.

Formula Management	
Formula Code	Formula Color Name
MT00000000	Mettler Toledo Special Formula 00
MT00000001	Mettler Toledo Special Formula 01
MT00000005	Mettler Toledo Special Formula 05
MT00000002	Mettler Toledo Special Formula 02

Editing Formula Ingredients

1. In the Formula Management screen, select either the formula code or the formula color name, then press . The display navigates to the following screen which shows all ingredients in the formula.

Formula: MT00000005 Mettler Toledo Special Formula 05			
Code	Name	Wt. (g)	Tol. (g)
2000	White	383.8	5.0
2001	Wine Red	365.2	5.0
2002	Black	308.0	5.0
2003	Earth Yellow	26.4	1.0

2. Press to select the entry, then press to edit.

Formula: MT00000005 Mettler Toledo Special Formula 05			
Code	Name	Wt. (g)	Tol. (g)
2000	White	383.8	5.0
2001	Wine Red	365.2	5.0
2002	Black	308.0	5.0
2003	Earth Yellow	26.4	1.0

4 Setup and Configuration

Menu Setting include Scale, Calibration, Terminal, Communication and Maintenance blocks, and allow you to configure the scale, the terminal display, communication parameters, calibrate the scale, and protect the display and formula, etc.

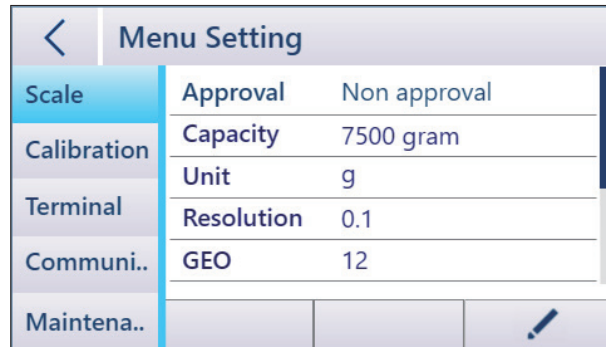

Menu Setting		
Scale	Approval	Non approval
Calibration	Capacity	7500 gram
	Unit	g
Terminal	Resolution	0.1
Communi..	GEO	12
Maintena..		

Entering Menu Setting

→ In the main screen, press , then the display navigates to the Menu Setting screen shown above.

Exiting Menu Setting

→ In the Menu Setting screen, press  on the upper left corner, then the following screen appears.

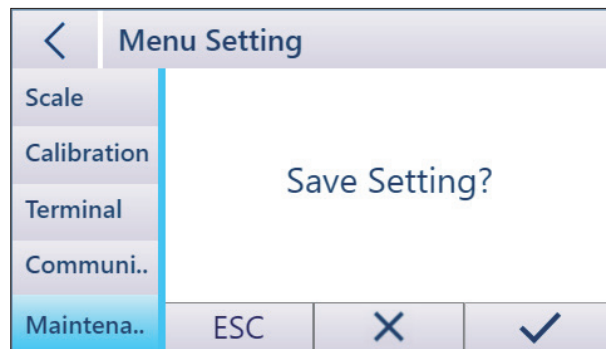

→ Press **ESC** to continue editing menu settings.

→ Press **X** to discard menu changes and return to the main screen.

→ Press **✓** to save menu setting changes and return to the main screen.

4.1 Menu Setting Structure Overview

Factory settings are printed in **bold** in the following overview.

Level 1	Level 2	Level 3	Level 4
Scale	Approval	Non approval , OIML	
	Capacity	7.5 kg	
	Unit	kg, oz, g , P ¹⁾	
	Resolution	0.05 g, 0.1 g	
	GEO	0... 12 ...30	
	AZM ²⁾	On, Off	
	Filter	Low, Middle , High	
	PowerMem	On, Off	
	Reset	Yes, No	
Terminal	Language	English , French, German, Portuguese, Spanish	
	Auto Power Off	5 minutes, 10 minutes, 20 minutes, 30 minutes, Off	
	Brightness	1... 5 ...10	
	Soffkey	Factor Setting, Mixing without Formula, Mixing with Formula, Formula Management , BBA242 Mode	
	Reset	Yes, No	
Calibration	2kg, 3kg, 4kg, 5kg, 6kg, 7kg		
Communication	Mode	Auto SIR , SICS	
	RS232	Baud	600, 1200, 2400, 4800, 9600 , 19200, 38400, 57600
		DataBits	7, 8
		Parity	Even, Odd, None
		Stop	1, 2
	Network ³⁾	DHCP	On, Off
	Reset	Yes, No	
Maintenance	Serial Number		
	Scale ID		
	Software Version	AD Board	
		Display	
	Scale Lock	Display	Off , On
		Formula Edit	Off , On
	Password		
Display Test	Off , On		

1) P=1/32 oz

2) AZM refers to **Automatic Zero Mode**.

3) Only available when the scale is equipped with Ethernet module. For configuration instructions, refer to the user manual.

4.2 Scale Setting

4.2.1 Scale Settings

4.2.1.1 Approval

→ In the Menu Setting screen, select **Scale** > **Approval**, then the following screen appears.

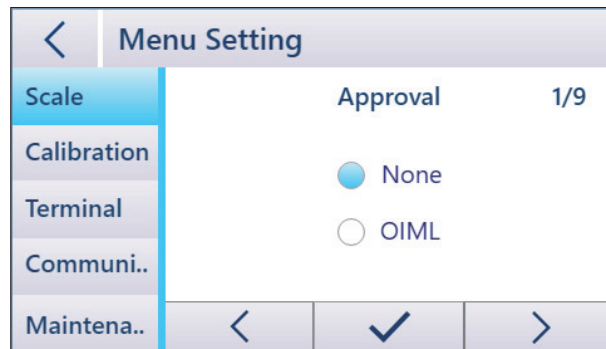

→ Press to select the target value. The selected value then has a prefix of a blue dot .

→ Press  to confirm the changes.

When Approval is set to "OIML", the following parameters or menu blocks change accordingly:

- In Scale, Unit will be set to "g".
- In Scale, Resolution will be set to "0.1".
- The Factor setting in the main screen will be disabled.
- The weight value will include a pair of brackets as shown in the left.

0.0

4.2.1.2 PowerMem

→ In the Menu Setting screen, select **Scale** > **PowerMem**, then the following screen appears.

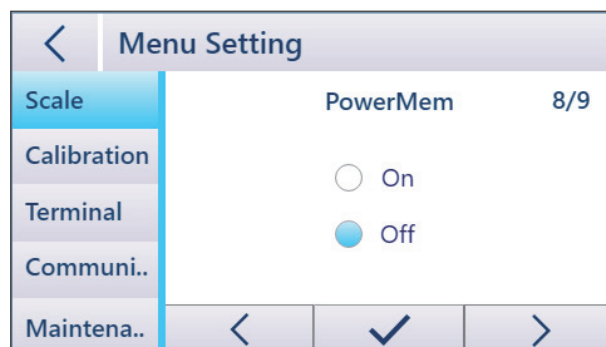

→ Press to select PowerMem as "On" or "Off". The selected value then has a prefix of a blue dot .

→ Press  to confirm the changes.

When PowerMem is set to "On", each time you start the scale, the display will show the

last weight value displayed.

4.3 Calibration

→ In the Menu Setting screen, select **Calibration**, then the following screen appears.

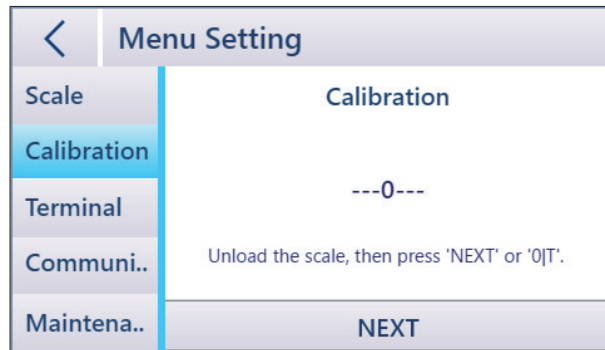

NOTE:

Before calibrating ensure that the scale is on a stable surface free of vibrations.

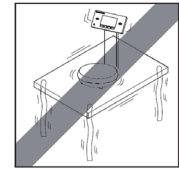

1. Unload the scale, then press "Next" on the screen or $\triangleright 0|T \blacktriangleleft$.
2. If the scale is in motion, wait till it gets stable. Then press "Next" on the screen or $\triangleright 0|T \blacktriangleleft$ again.
3. Then the following screen appears. Select the weight value (options: 2kg, 3kg, 4kg, 5kg, 6kg, 7kg) that corresponds to the weight you are going to load onto the scale.

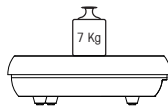
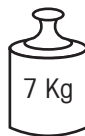

4. Place the weight onto the scale platter, then press \checkmark or $\triangleright 0|T \blacktriangleleft$.
5. When calibration is successful, the following screen appears. Press \checkmark , then the scale will reboot automatically.

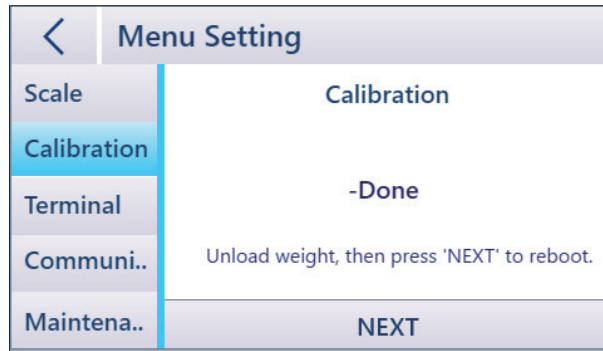

NOTE:

- For information about calibrating a metrologically approved scale, please contact Mettler-Toledo Service.

4.4 Terminal

4.4.1 Terminal Settings

4.4.1.1 Soft Keys

→ In the Menu Setting screen, select **Terminal** > **Soft Keys**, then the following screen appears.

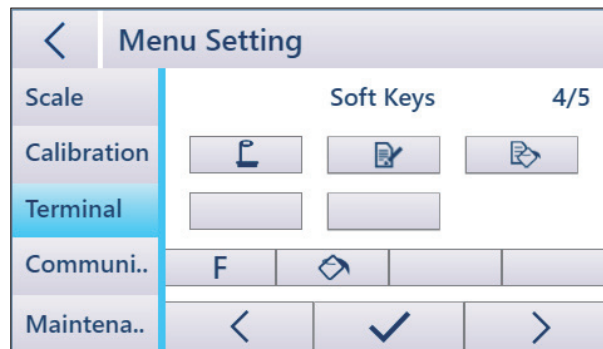

1. In the four soft keys, press the soft key which requires editing.
2. From the five function icons, select the one which will be controlled through the soft key chosen.
3. Repeat so to assign a function to each soft key.
4. Press ✓ to confirm the changes.

4.5 Communication

4.5.1 Communication Settings

4.5.1.1 Network

Network is available when the scale is equipped with a USB power & data barrier which includes an Ethernet module.

→ In the Menu Setting screen, select **Communication** > **Network**, then the following screen appears.

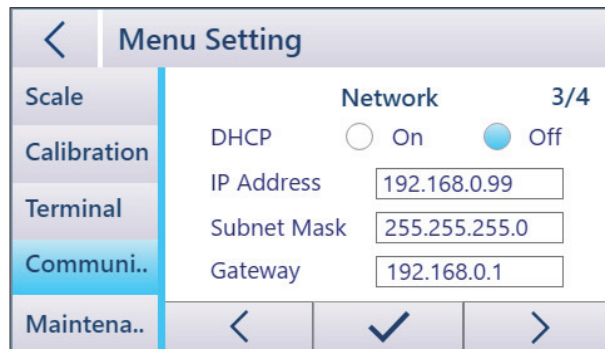



→ Press to select DHCP as "On" or "Off". The selected value then has a prefix of a blue dot .

→ Press the textfield, then define IP Address, Subnet Mask, and Gateway (only configurable when DHCP is "Off".)

→ Press  to confirm the changes.

Connecting to a Network with DHCP

If the IP address on a network is assigned by a DHCP (Dynamic Host Configuration Protocol) server, do as follows to assign an IP address to the scale:

1. In the Network screen, select DHCP as "On".
2. Press  to confirm, then press  on the upper left corner to save the change.
3. Then the scale is automatically assigned an IP address by the DHCP server.

Connecting to a Network with a Fixed IP Address

To connect the scale to a network with fixed IP addressed, do as follows:

1. Open the Network and Sharing Center (Start > Control Panel > Network and Internet > Network and Sharing Center) on your Windows PC.

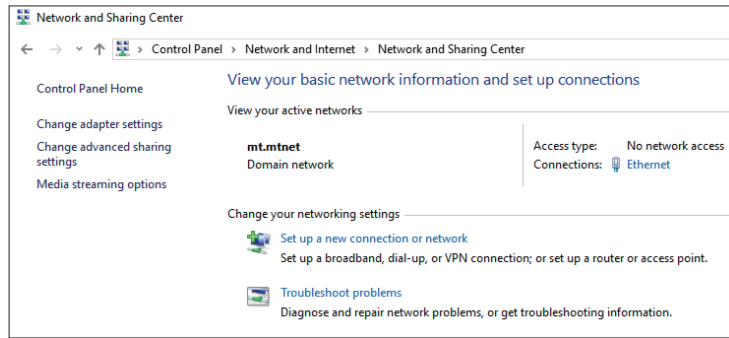

2. Click "Ethernet" connection in Network and Sharing Center window.
3. Click "Properties" in Ethernet Status window.

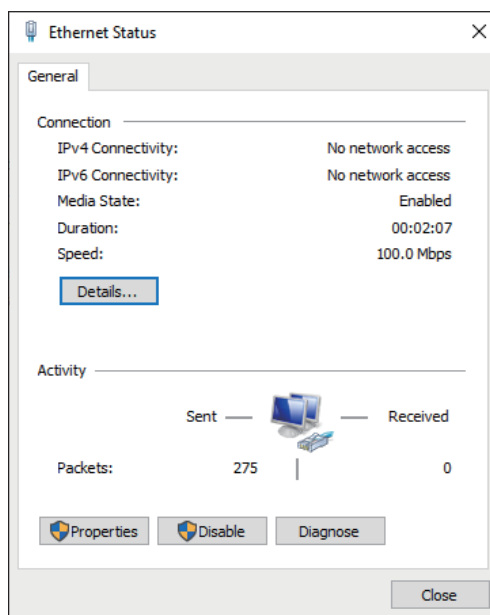

4. Select "Internet Protocol Version 4 (TCP/IPv4)" in Ethernet Properties window.

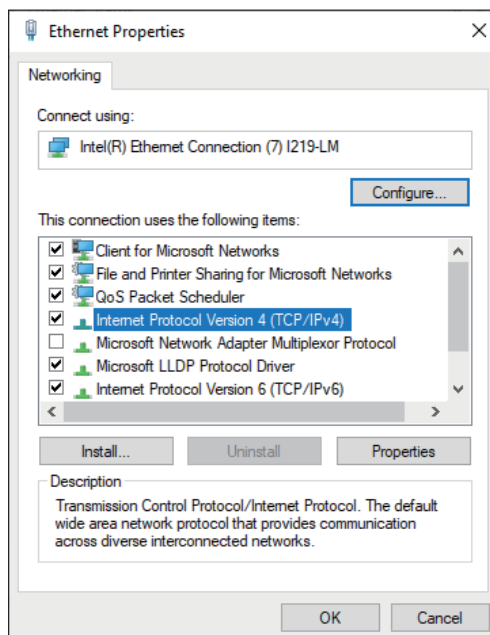

5. Select "Use the following IP address", enter the IP address of the network connection, then click "OK" to confirm.

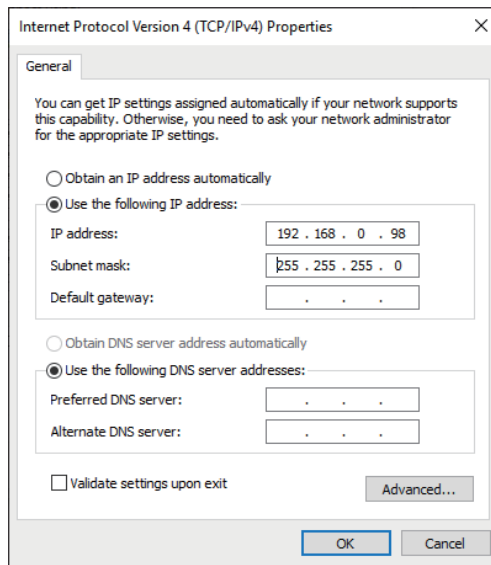

6. Click "OK" to close the following window.
7. In the Network (Menu Setting > Communication > Network), select DHCP as "Off".

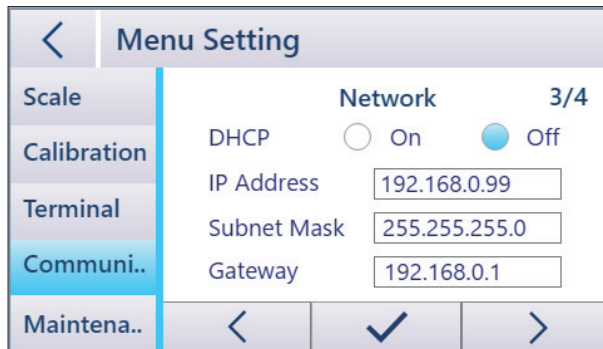

8. Enter an IP address for the scale, then press ✓ to confirm, then press < on the upper left corner to save the changes. To test the network connection, continue with step 9.



NOTE:

- The IP address assigned for the scale should be in the same network segment as the Windows PC.

9. To check whether the network connection is successful, do as follows:
 - a) Enter "cmd" in the input area of the start menu of your PC.

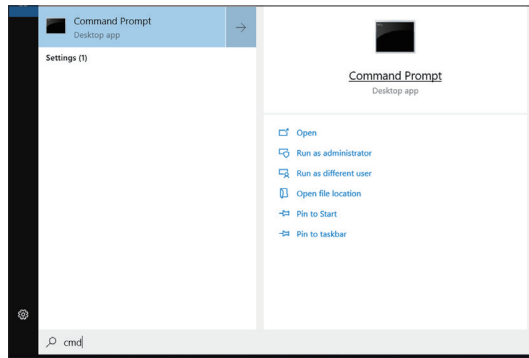

- b) Enter "ping" in the Command Prompt followed by a space and the IP address of the scale, then confirm with "Enter".
- c) When the network connection is successful, the Command Prompt should receive replies from the scale, as shown below. If not, contact your network administrator.

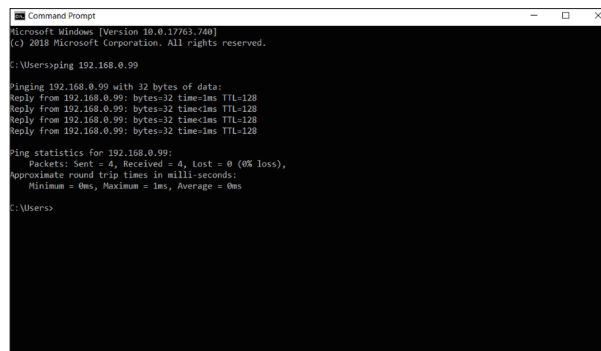

4.6 Maintenance

4.6.1 Maintenance Settings

4.6.1.1 Scale Lock

- In the Menu Setting screen, select **Maintenance** > **Scale Lock**, then the following screen appears.

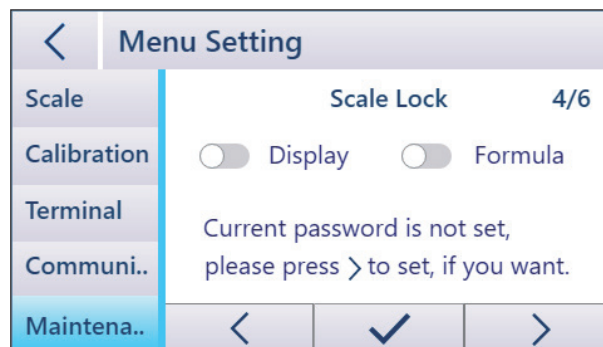

1. Slide the dots to set on or off the display lock and/or formula edit lock. A blue dot means the display or formula will be locked.

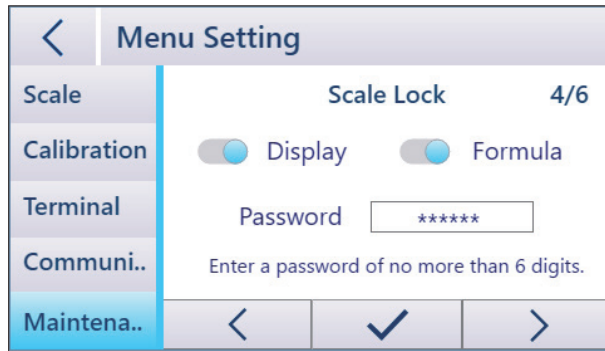

2. Set the password in the textfield.
3. Press ✓ to confirm the changes.

4.6.1.2 Password

→ In the Menu Setting screen, select **Maintenance** > **Password**, then the following screen appears, where you can change the password.

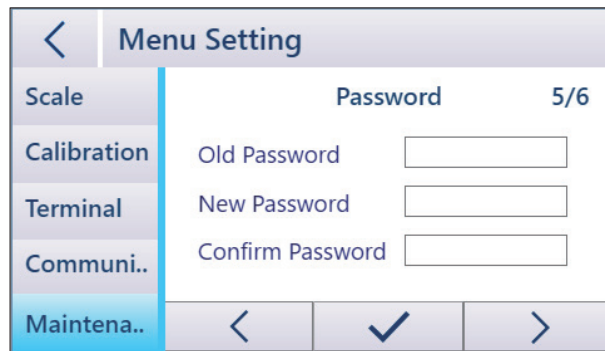

5 Maintenance and Service

5.1 Cleaning



Electrical hazard from voltage and current!

- ▲ Before cleaning the scale and/or the USB power & data barrier, disconnect all devices from power.
- ▲ Do not open the scale and/or the USB power & data barrier. No user-serviceable parts inside.

Before cleaning the scale, the USB power & data barrier and the AC adapter, disconnect all devices from the power supply and unplug all cables from the USB power & data barrier.

→ Remove dirt and foreign substances from the scale, the USB power & data barrier, and the AC adapter with a soft brush or cloth.

→ Take off the scale platter and remove dirt and foreign substances which may have collected underneath it. Do not use any hard objects to do so. Do not open the weighing platform.



→ If the dirt persists, use a cloth slightly soaked with a mild cleaning agent.

→ Do not use cleaning agents that contain solvents or abrasive ingredients to clean the mains socket, data interface, labels and all other plastic parts.

5.2 Maintenance

Have an authorized METTLER TOLEDO service representative inspect and calibrate the floor scale periodically. If the scale is used for legal-for-trade purposes, consult the local weights and measures authorities for minimum inspection requirements. Contact your local authorized METTLER TOLEDO service representative for information about periodic inspection and calibration service.

Safety inspections of the AC adapter and its connections must be performed periodically by a qualified electrician.

5.3 Storage

If the device is not used for a long time, disconnect all connections, clean the device and store it in an environment meeting the requirements: -10°C~60°C, at relative humidity of 5% to 95% non-condensing.

5.4 Disposal



In conformance with the European Directive 2002/96/EC on Waste Electrical and Electronic Equipment (WEEE) this device may not be disposed of in domestic waste. This also

applies to countries outside the EU, per their specific requirements.



Please dispose of this product in accordance with local regulations at the collecting point specified for electrical and electronic equipment.

If you have any questions, please contact the responsible authority or the distributor from which you purchased this device.

Should this device be passed on to other parties (for private or professional use), the content of this regulation must also be related.

Thank you for your contribution to environmental protection.

6 Advanced Trouble-Shootings

Error Symptom	Possible Cause	Remedy
Dark display	• Brightness too low	→ Set brightness higher
	• No power connection to the scale	→ Check all cables and connections
	• Brief fault	→ Switch device off and on again
Unstable weight reading	• Location with vibrations	→ Avoid vibration or change location
	• Drift	→ Avoid drift
	• Contact between platter/formula container and surroundings	→ Avoid contact between platter/formula container and surroundings
	• Incorrect filter setting	→ Change filter setting
	• Low voltage	→ Connect the scale to appropriate power supply
Incorrect weight reading	• Incorrect zeroing	→ Unload scale, set to zero and repeat weighing operation
	• Incorrect tare value	→ Clear tare
	• Contact between platter and/or formula container and surroundings	→ Avoid contact between platter and/or formula container and surroundings
	• Platter not on the scale	→ Place the platter on the scale
	• Underload	→ Set to zero by pressing the Zero/Tare button  . Re-power the scale, if necessary.
	• Overload	→ Unload scale → Reduce preload
Scale is not communicating by serial	• No driver installed	→ Download the driver at www.mt.com/ind-paint-mixing-scale , and install it
	• Unmatched settings between scale and PC	→ Reconfigure to match the settings
	• Power-only scale model	→ Contact your METTLER TOLEDO distributor

7 Spare Parts

7.1 Accessories

	Accessories	Order Number
	Protective covers	
	Protective cover for display (pack of 10)	30470150
	Protective cover for column (pack of 10)	30470151
	Protective cover for platter (pack of 10)	30470152
	Power Supply	
	USB Power adapter PSAL05R-050QL6	30098591
	AC-adapter plug (EU, BR)	46001774
	AC-adapter plug (AU)	46001775
	AC-adapter plug (US, CN)	46001776
	AC-adapter plug (UK)	46001777
	Cables	
	Cable Power & Data USB-A to RJ45, 3m	30570958
	Cable Power w/o Data USB-A to RJ45, 3m	30570792
	ACPS455xx, Cable Power & Data USB-A to RJ45, 10m	30570793
	ACPS455xx, Cable Power & Data USB-A to RJ45, 3m	30570794
	Cable USB-A to USB-B, 3m	64057361
	Cable Power w/o Data RJ45 to RJ45, 10m	30570795
	Cable Power w/o Data RJ45 to RJ45, 20m	30570796
	Weighing Platter	
	Weighing platter RPA455	30570797

7.2 Spare Parts

Spart Part		Order Number
1	USB Power & Data Barrier	
	USB Power & Data Barrier APS455x	30542760
	USB Power & Data Barrier APS455xx	30542762
2	Ethernet Kit	
	Ethernet Kit APS455	30542775
3	Base Unit	
	Base Unit RPA455	30542776
	Base Unit RPA455x	30542777
4	Display Column	
	Display w/column RPA455	30542779
	Display w/column RPA455x	30542780
5	Wall-Mount	
	Display Kit Wall mount RPA455x/xx	30542774

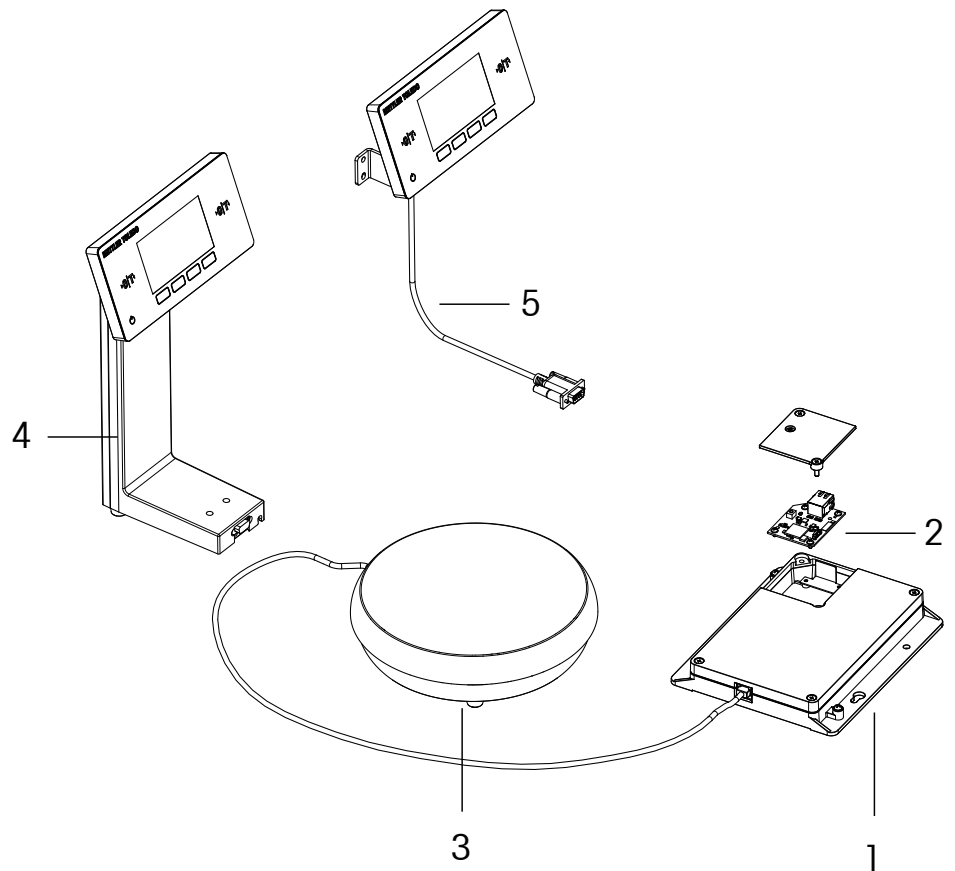

8 Repair

8.1 Replacing the Display Column or the Weighing Platform

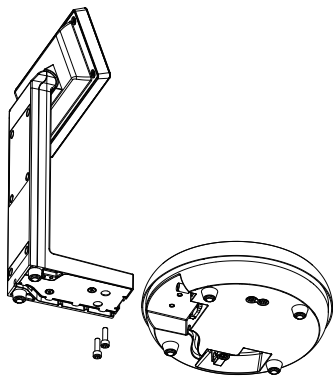

1. Disconnect the scale from power supply.
2. Undo the hex socket screws (x2) on the bottom of the display column, then separate the display column from the weighing platform.
3. Replace either the display column or the weighing platform, as required.
4. Reassemble the modules, then fix the display column to the weighing platform with the hex socket screws.
5. Reconnect the scale to power, then power on. The scale should work properly.

Appendix

B) Technical Data

Specifications	Non metrological-approved models	Metrological approved models
Capacity	7500 g / 999.95 g	Min. 5 g, Max. 7500 g
Verification interval e	Not applicable	1 g
Readability	0.1 g / 0.05 g	0.1 g
Weighing units	g, kg, oz, P (1 P = 1/32 oz)	g
Ambient operation conditions	For indoor use only, 0°C - 40°C / 32°F - 104°F, at relative humidity of 10% to 85% non-condensing	For indoor use only, 0°C - 35°C / 32°F - 95°F, at relative humidity of 10% to 85% non-condensing
Internal application	<ul style="list-style-type: none"> • Calculation by Factor • Mixing without Formula • Mixing with Formula • Recalculation (over-pour correction) • Formula Management • BBA242 Mode 	<ul style="list-style-type: none"> • Mixing without Formula • Mixing with Formula • Recalculation (over-pour correction) • Formula Management • BBA242 Mode
Stabilization time	Less than 1 second	
Tare range	-7500 g	
Switch-on zero range	± 750 g	
Weighing platter	Φ234 mm	
Display / Keyboard	Colorful TFT LCD Capacitive Touch Screen	
Language	English, Chinese, German, French, Spanish, Portuguese	
IP protection	IP40 in accordance with EN 60529/IEC 60529	
Interface connection	USB and Ethernet optional (APS455x / APS455xx) or USB (ACPS455xx Cable Power Supply)	
Power supply	USB 2.0 or higher, or AC adapter PSAI05R-050QL6	
Input voltage Power consumption	5 VDC 5 W	
Storage and shipping	-10°C - 60°C, at relative humidity of 5% to 95% non-condensing	
Overvoltage category	II	
Pollution degree	II	
Weight (net / gross)	5.4 kg / 6.5 kg (with a 20-meter power cable and a USB power & data barrier)	

C) Dimensions

Dimensions for Standard Scale Configuration

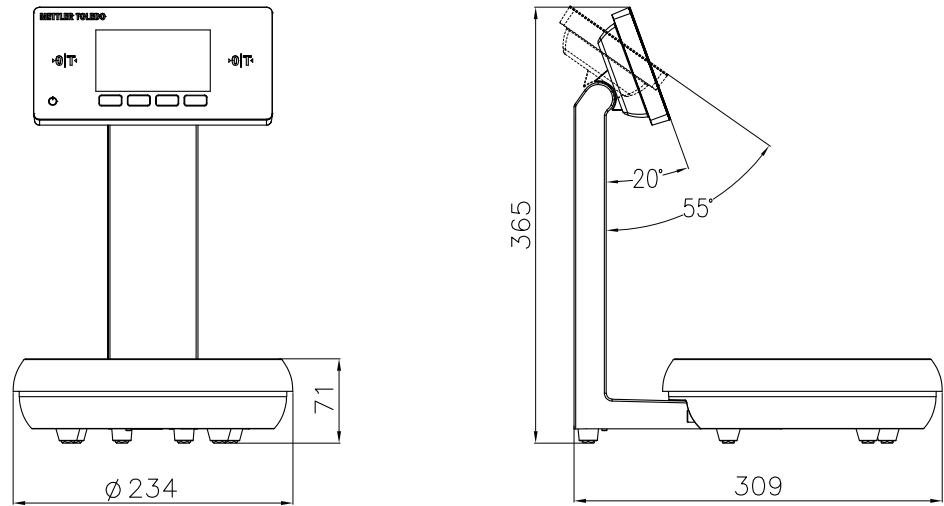

Dimensions for Wall-Mount Configuration

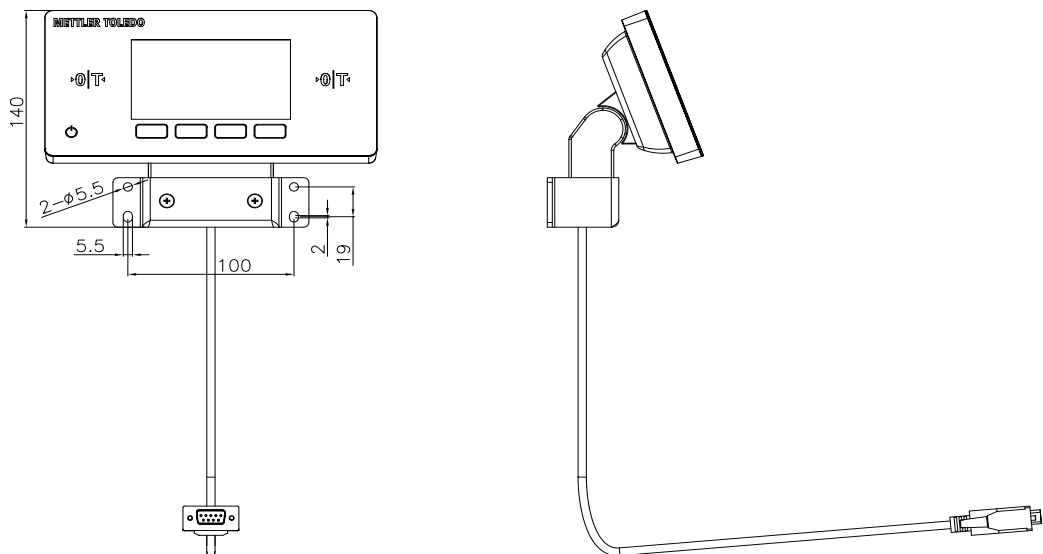

Dimensions for Scale Base-Only Configuration

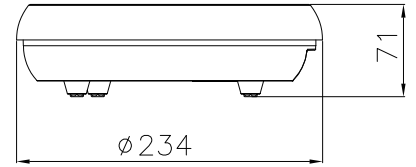
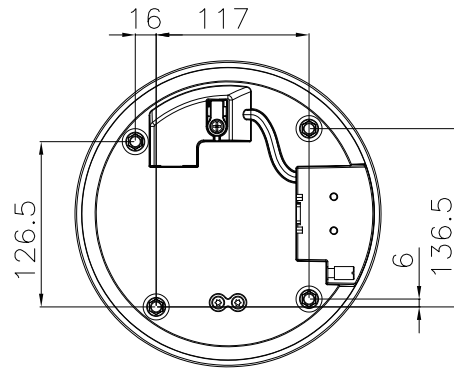

Dimensions of USB Power & Data Barrier

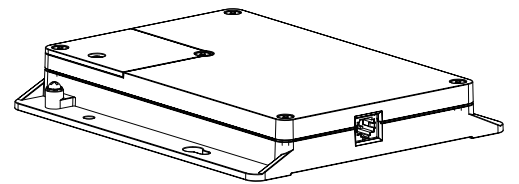
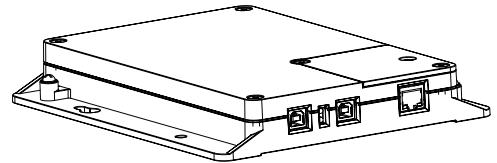
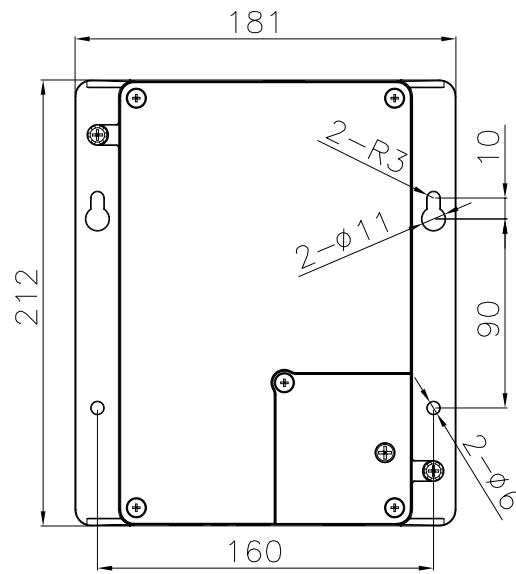
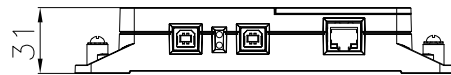

D) Control Drawings

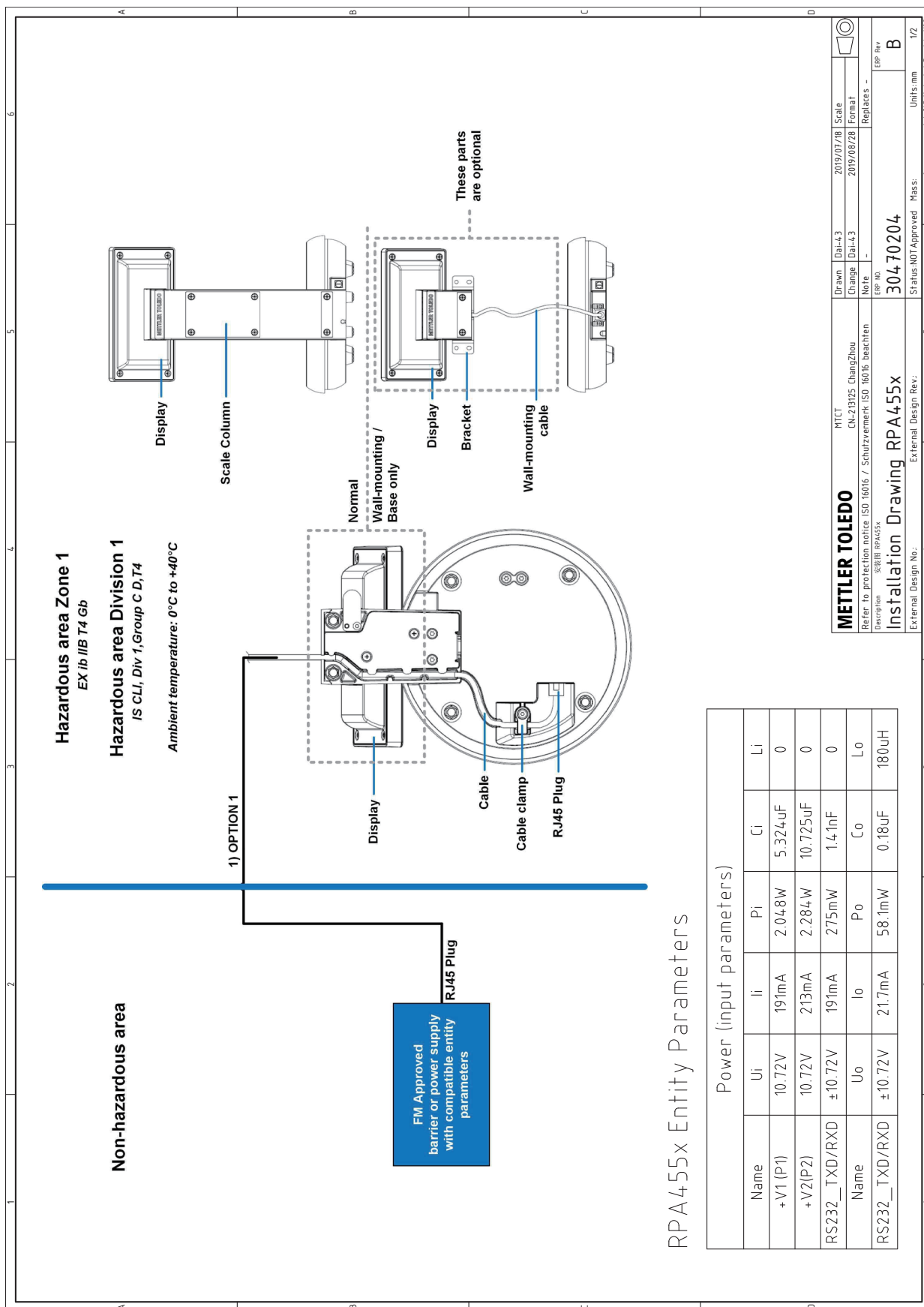

RPA455x Entity Parameters

These safety instructions apply to the installation, operation, maintenance and repair of the equipment.

1. OPTION 1. Only the Mettler-Toledo intrinsically safe cable 304.70188 (20 Meters) or 304.70195 (10 Meters) shall be used for connection to the intrinsically safe outputs of the associated apparatus.
2. The enclosure contains aluminum and is considered to present a potential risk of ignition by impact or friction. Care must be taken during installation and use to prevent impact or friction.
3. Parts of the enclosure are constructed of plastic. The risk of electrostatic discharge shall be minimized at installation, following the direction given in the instruction manual.
4. The Paint Mixing Scale does not withstand a 500Vrms dielectric strength test between the circuits and the earth ground. This must be taken into account during installation.
5. No revision to drawing without prior FM Approval.
6. The Associated Apparatus must be FM Approved.
7. Control equipment connected to Associated Apparatus must not use or generate more than 250 Vrms or Vdc.
8. Associated apparatus manufacturer's installation drawing must be followed when installing this equipment.
9. The Entity Concept allows interconnection of intrinsically safe apparatus with associated apparatus when the following is true:
 $V_{max} \text{ or } U_i \geq V_{oc}, V_f \text{ or } U_o;$
 $I_{max} \text{ or } I_i \geq I_{sc}, I_f \text{ or } I_o;$
 $P_{max} \text{ or } P_i \geq P_o;$
 $C_a \geq C_i + C_{cable};$
 $L_a \geq L_i + L_{cable}.$
10. Resistance between Intrinsically Safe Ground and earth ground must be less than 1.0 Ohm.
11. Installation should be in accordance with ANSI/ISA RP12.06.01 "Installation of Intrinsically Safe Systems for Hazardous (Classified) Locations" and the National Electrical Code (ANSI/NFPA 70), or in accordance with European Standards EN 60079-14 (Explosive atmospheres – Part 14: Electrical installations design, selection and erection), or in accordance with the Canadian Electrical Code, Section 18.
12. WARNING – Substitution of components may impair Intrinsic Safety.
13. WARNING – To prevent ignition of flammable or combustible atmospheres, disconnect power before servicing.
14. WARNING – Potential Electrostatic Charging Hazard – The enclosure is constructed from plastic. To prevent the risk of electrostatic sparking the plastic surface should only be cleaned only with a damp cloth.
15. WARNING – The apparatus enclosure contains aluminum and is considered to constitute a potential risk of ignition by impact or friction. Care must be taken into account during installation and use to prevent impact or friction.

METTLER TOLEDO		MTCT	Drawn	Dai-43	2019/07/28	Scale
Refer to protection notice ISO 16016 / Schutzwertmerk ISO 16016 beachten		CN-21325 ChangZhou	Change	Dai-43	2019/08/28	Format
Description: %RIRI RPA455x			Note	-		Replaces -
Installation Drawing RPA455x			ERP No.	304.70204		ERP Rev
External Design No.:		External Design Rev.:	Status:	NOT Approved	Pass:	Units: mm
						2/2
						AutoCAD Mechanical Template V02

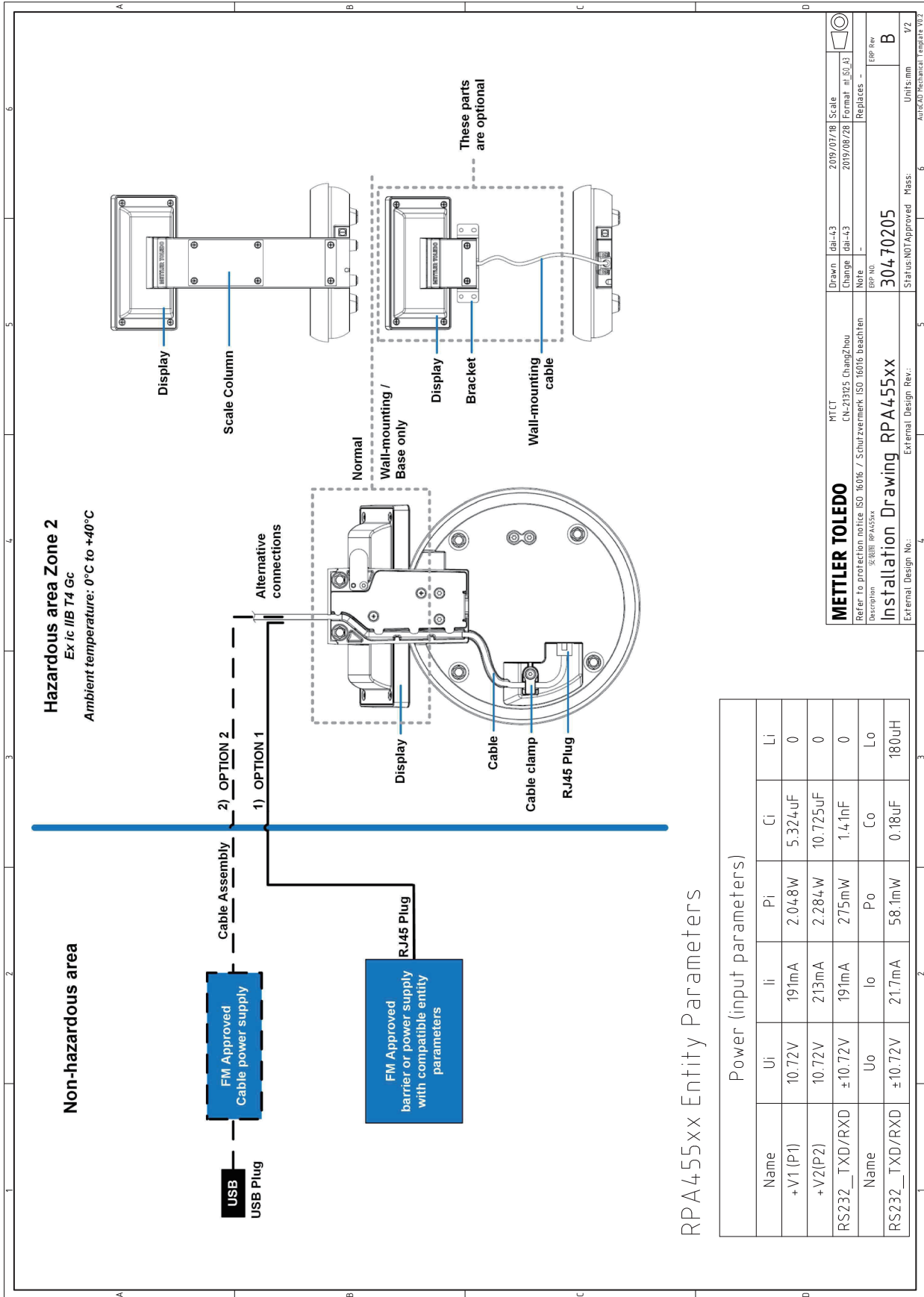

RPA455xx Entity Parameters

Power (input parameters)						
Name	Ui	Ii	Pi	Ci	Li	
+V1 (P1)	10.72V	191mA	2.048W	5.324µF	0	
+V2(P2)	10.72V	213mA	2.284W	10.725µF	0	
RS232_TXD/RXD	±10.72V	191mA	275mW	1.41nF	0	
Name	Uo	Io	Po	Co	Lo	
RS232_TXD/RXD	±10.72V	21.7mA	58.1mW	0.18µF	180µH	



These safety instructions apply to the installation, operation, maintenance and repair of the equipment.



1. OPTION 1: Only the Mettler-Toledo intrinsically safe cable 304 70188 (20 Meters) or 304 70195 (10 Meters) shall be used for connection to the intrinsically safe outputs of the associated apparatus.
2. OPTION 2: Only the Mettler-Toledo intrinsically safe cable power supply 304 70193 (10 Meters) or 304 70194 (3 Meters) shall be used for connection.
3. The enclosure contains aluminum and is considered to present a potential risk of ignition by impact or friction. Care must be taken during installation and use to prevent impact or friction.
4. Parts of the enclosure are constructed of plastic. The risk of electrostatic discharge shall be minimized at installation, following the direction given in the instruction manual.
5. The Paint Mixing Scale does not withstand a 500Vrms dielectric strength test between the circuits and the earth ground. This must be taken into account during installation.
6. No revision to drawing without prior FM Approval.
7. The Associated Apparatus must be FM Approved.
8. Control equipment connected to Associated Apparatus must not use or generate more than 250 Vrms or Vdc.
9. Associated apparatus manufacturer's installation drawing must be followed when installing this equipment.
10. The Entity Concept allows interconnection of intrinsically safe apparatus with associated apparatus when the following is true:
 - V_{max} or $U_i \geq V_{oc}$, V_f or U_o ;
 - I_{max} or $I_i \geq I_{sc}$, I_f or I_o ;
 - P_{max} or $P_i \geq P_o$;
 - $Ca \geq Ci + Ccable$;
 - $La \geq Li + Lcable$.
11. Resistance between Intrinsically Safe Ground and earth ground must be less than 1.0 Ohm.
12. Installation should be in accordance with ANSI/ISA RP12.06.01 "Installation of Intrinsically Safe Systems for Hazardous (Classified) Locations" and the National Electrical Code (ANSI/NFPA 70), or in accordance with European Standards EN 60079-14 (Explosive atmospheres - Part 14: Electrical installations design, selection and erection), or in accordance with the Canadian Electrical Code, Section 18.
13. WARNING - Substitution of components may impair Intrinsic Safety.
14. WARNING - To prevent ignition of flammable or combustible atmospheres, disconnect power before servicing.
15. WARNING - Potential Electrostatic Charging Hazard - The enclosure is constructed from plastic. To prevent the risk of electrostatic sparking the plastic surface should only be cleaned only with a damp cloth.
16. WARNING - The apparatus enclosure contains aluminum and is considered to constitute a potential risk of ignition by impact or friction. Care must be taken into account during installation and use to prevent impact or friction.



METTLER TOLEDO		Drawn	Idm-43	2019/07/18	Scale	
Refer to protection notice ISO 16016 / Schutzvermerk ISO 16016 beachten		Change	Idm-43	2019/08/28	Format	m_ISU_A1
Description RPA455xx		Note			Replaces	-
Installation Drawing RPA455xx		ERP No.	304 70205			
External Design No.:		External Design Rev.:				
		Status:	NOT Approved	Mass:		Units: mm
						2/2
						Automatic Mechanical Template V01.2

E) Label Drawings



For Base-only and Wall-Mount Configuration

<p>RPA455xx Max 7500 g d=0.1 g 0°C ≤ Ta ≤ +40°C INT. SAFE Ex ic IIB T4 Gc</p>	<p>FM19ATEX0193X IECEX FMG 19.0030X</p>		
<p>For cautions, warnings and installation refer to the drawing 30470205.</p>			

<p>RPA455x Max 7500 g d=0.1 g 0°C ≤ Ta ≤ +40°C INT. SAFE</p>		<p>IS CL I, Div 1, GP C, D T4 CL I, Zone 1, AEx / Ex ib IIB T4 Gb FM19US0153X FM19CA0082X</p>	
<p>For cautions, warnings and installation refer to the drawing 30470204.</p>		<p>Ex ib IIB T4 Gb FM19ATEX0192X IECEX FMG 19.0030X</p>	

<p>MODEL RPA CODE: mmmmmmmmmmmmmmmmm 5 VDC 1 A Temperature: dddddd</p>	<p>METTLER TOLEDO S/N SSSSSSSSSS Barcode</p>	
<p>cccccccccccccccccccc eeeeeeeeeeeeeeeeeeee</p>	<p>Mettler-Toledo GmbH Im Langacher 44 CH-8606 Greifensee Switzerland</p>	<p>xxxxx  Made in China</p>
		<p>www.mt.com</p>

For Standard Configuration

<p>MODEL RPA CODE: mmmmmmmmmmmmmmmmm 5 VDC 1 A Temperature: dddddd</p>	<p>METTLER TOLEDO S/N SSSSSSSSSS Barcode</p>	
<p>cccccccccccccccccccc eeeeeeeeeeeeeeeeeeee</p>	<p>Mettler-Toledo GmbH Im Langacher 44 CH-8606 Greifensee Switzerland</p>	<p>xxxxx  Made in China</p>
		<p>www.mt.com</p>

<p>RPA455x Max 7500 g d=0.1 g 0°C ≤ Ta ≤ +40°C INT. SAFE</p>	
 	<p>Ex ib IIB T4 Gb FM19ATEX0192X IECEX FMG 19.0030X</p>
	<p>IS CL I, Div 1, GP C, D T4 CL I, Zone 1, AEx / Ex ib IIB T4 Gb FM19US0153X FM19CA0082X</p>
<p>WARNINGS</p> <p>Substitution of components may impair Intrinsic Safety. To prevent ignition of flammable or combustible atmospheres, disconnect power before servicing.</p> <p>Electrostatic Charging Hazard - The enclosure is constructed from plastic. To prevent the risk of electrostatic sparking the plastic surface should only be cleaned with a damp cloth.</p> <p>The apparatus enclosure contains aluminum and is considered to constitute a potential risk of ignition by impact or friction. Care must be taken into account during installation and use to prevent impact or friction.</p> <p>For additional cautions, warnings and installation refer to the drawing 30470204.</p>	

<p>RPA455xx Max 7500 g d=0.1 g 0°C ≤ Ta ≤ +40°C INT. SAFE Ex ic IIB T4 Gc</p>	<p>FM19ATEX0193X IECEX FMG 19.0030X</p>
	
<p>WARNINGS</p> <p>Substitution of components may impair Intrinsic Safety. To prevent ignition of flammable or combustible atmospheres, disconnect power before servicing.</p> <p>Electrostatic Charging Hazard - The enclosure is constructed from plastic. To prevent the risk of electrostatic sparking the plastic surface should only be cleaned with a damp cloth.</p> <p>The apparatus enclosure contains aluminum and is considered to constitute a potential risk of ignition by impact or friction. Care must be taken into account during installation and use to prevent impact or friction.</p> <p>For additional cautions, warnings and installation refer to the drawing 30470205.</p>	

F) GEO Code Values

Northern or southern latitude in degrees and minutes	Height above sea level in meters										
	0	325	650	975	1300	1625	1950	2275	2600	2925	3250
	325	650	975	1300	1625	1950	2275	2600	2925	3250	3575
	Height above sea level in feet										
0	1060	2130	3200	4260	5330	6400	7460	8530	9600	10660	
1060	2130	3200	4260	5330	6400	7460	8530	9600	10660	11730	
0° 0' – 5° 46'	5	4	4	3	3	2	2	1	1	0	0
5° 46' – 9° 52'	5	5	4	4	3	3	2	2	1	1	0
9° 52' – 12° 44'	6	5	5	4	4	3	3	2	2	1	1
12° 44' – 15° 6'	6	6	5	5	4	4	3	3	2	2	1
15° 6' – 17° 10'	7	6	6	5	5	4	4	3	3	2	2
17° 10' – 19° 2'	7	7	6	6	5	5	4	4	3	3	2
19° 2' – 20° 45'	8	7	7	6	6	5	5	4	4	3	3
20° 45' – 22° 22'	8	8	7	7	6	6	5	5	4	4	3
22° 22' – 23° 54'	9	8	8	7	7	6	6	5	5	4	4
23° 54' – 25° 21'	9	9	8	8	7	7	6	6	5	5	4
25° 21' – 26° 45'	10	9	9	8	8	7	7	6	6	5	5
26° 45' – 28° 6'	10	10	9	9	8	8	7	7	6	6	5
28° 6' – 29° 25'	11	10	10	9	9	8	8	7	7	6	6
29° 25' – 30° 41'	11	11	10	10	9	9	8	8	7	7	6
30° 41' – 31° 56'	12	11	11	10	10	9	9	8	8	7	7
31° 56' – 33° 9'	12	12	11	11	10	10	9	9	8	8	7
33° 9' – 34° 21'	13	12	12	11	11	10	10	9	9	8	8
34° 21' – 35° 31'	13	13	12	12	11	11	10	10	9	9	8
35° 31' – 36° 41'	14	13	13	12	12	11	11	10	10	9	9
36° 41' – 37° 50'	14	14	13	13	12	12	11	11	10	10	9
37° 50' – 38° 58'	15	14	14	13	13	12	12	11	11	10	10
38° 58' – 40° 5'	15	15	14	14	13	13	12	12	11	11	10
40° 5' – 41° 12'	16	15	15	14	14	13	13	12	12	11	11
41° 12' – 42° 19'	16	16	15	15	14	14	13	13	12	12	11
42° 19' – 43° 26'	17	16	16	15	15	14	14	13	13	12	12
43° 26' – 44° 32'	17	17	16	16	15	15	14	14	13	13	12
44° 32' – 45° 38'	18	17	17	16	16	15	15	14	14	13	13
45° 38' – 46° 45'	18	18	17	17	16	16	15	15	14	14	13
46° 45' – 47° 51'	19	18	18	17	17	16	16	15	15	14	14
47° 51' – 48° 58'	19	19	18	18	17	17	16	16	15	15	14
48° 58' – 50° 6'	20	19	19	18	18	17	17	16	16	15	15
50° 6' – 51° 13'	20	20	19	19	18	18	17	17	16	16	15
51° 13' – 52° 22'	21	20	20	19	19	18	18	17	17	16	16
52° 22' – 53° 31'	21	21	20	20	19	19	18	18	17	17	16
53° 31' – 54° 41'	22	21	21	20	20	19	19	18	18	17	17
54° 41' – 55° 52'	22	22	21	21	20	20	19	19	18	18	17
55° 52' – 57° 4'	23	22	22	21	21	20	20	19	19	18	18
57° 4' – 58° 17'	23	23	22	22	21	21	20	20	19	19	18
58° 17' – 59° 32'	24	23	23	22	22	21	21	20	20	19	19
59° 32' – 60° 49'	24	24	23	23	22	22	21	21	20	20	19
60° 49' – 62° 9'	25	24	24	23	23	22	22	21	21	20	20
62° 9' – 63° 30'	25	25	24	24	23	23	22	22	21	21	20
63° 30' – 64° 55'	26	25	25	24	24	23	23	22	22	21	21
64° 55' – 66° 24'	26	26	25	25	24	24	23	23	22	22	21
66° 24' – 67° 57'	27	26	26	25	25	24	24	23	23	22	22
67° 57' – 69° 35'	27	27	26	26	25	25	24	24	23	23	22
69° 35' – 71° 21'	28	27	27	26	26	25	25	24	24	23	23

Northern or southern latitude in degrees and minutes	Height above sea level in meters										
	0	325	650	975	1300	1625	1950	2275	2600	2925	3250
	325	650	975	1300	1625	1950	2275	2600	2925	3250	3575
	Height above sea level in feet										
	0	1060	2130	3200	4260	5330	6400	7460	8530	9600	10660
1060	2130	3200	4260	5330	6400	7460	8530	9600	10660	11730	
71° 21' – 73° 16'	28	28	27	27	26	26	25	25	24	24	23
73° 16' – 75° 24'	29	28	28	27	27	26	26	25	25	24	24
75° 24' – 77° 52'	29	29	28	28	27	27	26	26	25	25	24
77° 52' – 80° 56'	30	29	29	28	28	27	27	26	26	25	25
80° 56' – 85° 45'	30	30	29	29	28	28	27	27	26	26	25
85° 45' – 90° 00'	31	30	30	29	29	28	28	27	27	26	26

www.mt.com

For more information

METTLER-TOLEDO (Changzhou) Measurement Technology Ltd.

Add.: #111, West Taihu Road, XinBei District, Changzhou, Jiangsu, PRC.

Tel. +86 519 86642040

Fax +86 519 86641991

www.mt.com

Subject to technical changes

© 11/2019 Mettler-Toledo Group

Document No. 30470210 A

