

Quick Guide

IND360



METTLER TOLEDO

English

IND360 Quick Guide

Table of Contents

1.	Safety Instructions	2
	Intended Use	2
	Documentation	2
	Safety Warnings.....	2
2.	Specifications and Operator Interface	3
	Specifications	3
	DIN Rail Version Interface Features	4
	Operator Interface, Front and Top	4
	Display Features	5
	Front Panel and Display Features, Panel-Mount and Harsh Environment Versions	5
	Pushbutton Functions, All Versions.....	5
3.	Operating Instructions	6
	Weights and Measures Approved Mode	6
	Web Browser Access to IND360 DIN Rail Mount Model.....	7
	On-Screen Menus.....	8
	Menu Navigation	8
	Data Entry, DIN Rail Mount Version	8
	Accessing and Exiting the Softkeys, Harsh Environment and Panel-Mount Versions	9
	Accessing and Exiting the Operator Menu.....	9
4.	Basic Functions	10
	Zero	10
	Tare	10
	Tare Operation	10
	Clear Tare	10
	ePrint	11
5.	Diagnostics and Maintenance	11
	Common Errors	11
	Cleaning the Indicator	11

1. Safety Instructions

Intended Use

The IND360 Automation Indicator is used for weighing. Use it exclusively for this purpose. Any other type of use and operation beyond the limits of technical specifications without written consent from Mettler-Toledo, LLC is considered as not intended.

It is essential for the buyer to closely observe the installation information, product and system manuals, operating instructions and other documentation and specifications. MT's warranty and any liability are expressly excluded for damages caused by non-compliance with the applicable manuals.

Do not use the Indicator in any environment or category other than those specified under **Specifications**.

Documentation

For further details on system configuration and operation, visit www.mt.com/ind-ind360-downloads. For product compliance information, visit <http://glo.mt.com/global/en/home/search/compliance.html>.

Safety Warnings

DOWNLOAD and READ the Installation Guide BEFORE operating or servicing this equipment and FOLLOW all instructions carefully.

 WARNINGS
FOR CONTINUED PROTECTION AGAINST SHOCK HAZARD CONNECT TO PROPERLY GROUNDED OUTLET ONLY. DO NOT REMOVE THE GROUND PRONG.
THE IND360 IS INTENDED TO BE USED FOR PROCESS CONTROL AND IS NOT APPROVED AS A SAFETY COMPONENT. WHEN USED AS A COMPONENT PART OF A SYSTEM, ANY SAFETY CIRCUITS MUST BE INDEPENDENT OF THE IND360 AND REMOVE POWER FROM THE IND360 OUTPUTS IN THE EVENT OF AN EMERGENCY STOP OR EMERGENCY POWER DOWN.
NOT ALL VERSIONS OF THE IND360 ARE DESIGNED FOR USE IN HAZARDOUS (EXPLOSIVE) AREAS. REFER TO THE DATA PLATE OF THE IND360 TO DETERMINE IF A SPECIFIC DEVICE IS APPROVED FOR USE IN AN AREA CLASSIFIED AS HAZARDOUS BECAUSE OF COMBUSTIBLE OR EXPLOSIVE ATMOSPHERES.
THE IND360 IS NOT INTRINSICALLY SAFE! DO NOT USE IN HAZARDOUS AREAS CLASSIFIED AS DIVISION 1, ZONE 0, ZONE 20, ZONE 1 OR ZONE 21 BECAUSE OF COMBUSTIBLE OR EXPLOSIVE ATMOSPHERES. FAILURE TO COMPLY WITH THIS WARNING COULD RESULT IN BODILY HARM AND/OR PROPERTY DAMAGE.
DO NOT ACTIVATE POWER OVER ETHERNET (PoE) ON ETHERNET SWITCHES ON THE IND360 NETWORK. ACTIVATING PoE MAY RESULT IN DAMAGE TO THE IND360.
WHEN THIS EQUIPMENT IS INCLUDED AS A COMPONENT PART OF A SYSTEM, THE RESULTING DESIGN MUST BE REVIEWED BY QUALIFIED PERSONNEL WHO ARE FAMILIAR WITH THE CONSTRUCTION AND OPERATION OF ALL COMPONENTS IN THE SYSTEM AND THE POTENTIAL HAZARDS INVOLVED. FAILURE TO OBSERVE THIS PRECAUTION COULD RESULT IN BODILY HARM AND/OR PROPERTY DAMAGE.
DO NOT INSTALL, DISCONNECT OR PERFORM ANY SERVICE ON THIS EQUIPMENT BEFORE POWER HAS BEEN SWITCHED OFF AND THE AREA HAS BEEN SECURED AS NON-HAZARDOUS BY PERSONNEL AUTHORIZED TO DO SO BY THE RESPONSIBLE PERSON ON-SITE.
ONLY THE COMPONENTS SPECIFIED IN THE IND360 DOCUMENTATION CAN BE USED IN THIS INDICATOR. ALL EQUIPMENT MUST BE INSTALLED IN ACCORDANCE WITH THE INSTALLATION INSTRUCTIONS DETAILED IN THE INSTALLATION MANUAL. INCORRECT OR SUBSTITUTE COMPONENTS AND/OR DEVIATION FROM THESE INSTRUCTIONS CAN IMPAIR THE SAFETY OF THE INDICATOR AND COULD RESULT IN BODILY HARM AND/OR PROPERTY DAMAGE.
BEFORE CONNECTING/DISCONNECTING ANY INTERNAL ELECTRONIC COMPONENTS OR INTERCONNECTING WIRING BETWEEN ELECTRONIC EQUIPMENT ALWAYS REMOVE POWER AND WAIT AT LEAST THIRTY (30) SECONDS BEFORE ANY CONNECTIONS OR DISCONNECTIONS ARE MADE. FAILURE TO OBSERVE THESE PRECAUTIONS COULD RESULT IN DAMAGE TO OR DESTRUCTION OF THE EQUIPMENT AND/OR BODILY HARM.
ONLY PERMIT QUALIFIED PERSONNEL TO SERVICE THE INDICATOR. EXERCISE CARE WHEN MAKING CHECKS, TESTS AND ADJUSTMENTS THAT MUST BE MADE WITH POWER ON. FAILING TO OBSERVE THESE PRECAUTIONS CAN RESULT IN BODILY HARM AND/OR PROPERTY DAMAGE.

2. Specifications and Operator Interface

Specifications

Enclosure Types	DIN Rail mount, ABS plastic with automatic grounding springs at the rear side of the enclosure, the unit also includes a green plastic locking clip.
	Panel-mount stainless steel front panel with a frame which is compatible to the IND331 mounting dimensions. The panel is structured such that the electronics may be mounted with the display or may be remotely mounted on a DIN (Omega) rail.
	Harsh environment desk/wall/column-mount type 304L stainless steel enclosure with Versa 100 mounting holes in the rear of the enclosure using. Mounting brackets are exactly the same as the Model IND570.
Dimensions (w × h × d)	DIN-Rail mount: 40 x 135 x 100 / 1.6 x 5.1 x 3.9
	Panel Mount: 175 x 94 x 16 / 6.9 x 3.7 x 0.6
	Harsh Environment: 275 x 85 x 200 / 10.8 x 3.3 x 7.9
Shipping Weight	DIN-Rail mount: 0.5 / 1.1
	Panel Mount: 1.7 / 3.7
	Harsh Environment: 3.6 / 7.9
Environmental Protection	DIN-Rail mount: IP20 type 1
	Panel-mount panel display: IP65
	IND360 Harsh Environment model: IP66 and IP69K.
Operating Environment	-10° to 50° C (14° to 122° F) at 10% to 90% relative humidity, non-condensing
Legal for Trade	-10° to 40° C (14° to 104° F) at 10% to 90% relative humidity, non-condensing
Hazardous Areas	Zone 2/22, Division 2. Details see datasheet.
AC Input Power (Harsh and panel-mount models)	Operates at 100–240 VAC, 49–61 Hz
	Peak current at startup: 750 mA
DC Input Power	Operates at 20-28 VDC ¹⁾ ; 12W ²⁾ ¹⁾ Power supply short circuit protection time shall be equal or longer than 100ms. ²⁾ 18W, when 5 ... 8 POWERCELLS are connected
Scale Types	Analog load cells: up to 8x350 Ω or 20x1000 Ω; 1~4mV/V <i>or</i> APW (Automated Precision Weighing) module and high-precision platforms that include Advanced Setup Mode <i>or</i> Up to 8 POWERCELL load cells.
Analog Load Cell Excitation Voltage	5 VDC
Automation interface Update Rate	IND360 analog: 960 Hz IND360 POWERCELL: 100Hz for 1~4 LCs; 50 for 4~8 LCs IND360 Precision: 92 Hz
Display	DIN Rail mount version: 1.04" green OLED Panel mount version: 4.3" color TFT Harsh version: 4.3" color TFT
Keypad	DIN Rail mount version: 4 keys (Up, Down, Left, Enter); 0.9 mm thick polyester overlay (PET) with 0.178mm thick polycarbonate display lens
	Panel mount and harsh version: 5 keys (Up, Down, Left, Right, Enter); 0.9 mm thick polyester overlay (PET) with 0.178mm thick polycarbonate display lens
Communication	Standard Interfaces
	Ethernet Port: Ethernet TCP/IP interface for service setup (web interface) and basic control from PC
	Industrial Ethernet Port for PROFINET, EtherNet/IP, EtherCAT, CC-Link IE Field Basic and Modbus TCP, which also support Media Ring Profile (PROFINET) and Device Level Ring (EtherNet/IP)
	Interface for PROFIBUS DP communication Interface for Modbus RTU communication
	Optional Analog and Digital IOs (none or one of the following) 4~20mA / 0~10V Analog Output 4~20mA / 0~10V Analog Output, 3 Discrete Inputs, 4 Discrete outputs, Solid State 5 Discrete Inputs, 8 Discrete Outputs, Solid State

<p>Approvals</p>	<p>Weights and Measures IND360 Analog and IND360 POWERCELL®: Europe: Class III, T11060 TC11949 USA: Class III / III L n max. 10,000 CC No. 21-002 Canada: Class III / IIIHD n max. 10,000 AM-6161 China: Class III n max. 10,000 IND360</p> <p>Precision: Europe: II T11060, TC11949 USA: Class II / III / III L n max. 100,000 / 10,000 CC No. 21-002 Canada: Class II / III / IIIHD n max. 100,000 / 10,000 AM-6161</p> <p>Product Safety UL, cUL, CE, FCC, CB</p> <p>Hazardous Zone 2/22, Division 2. Details see datasheet.</p>
-------------------------	--

DIN Rail Version Interface Features

Operator Interface, Front and Top

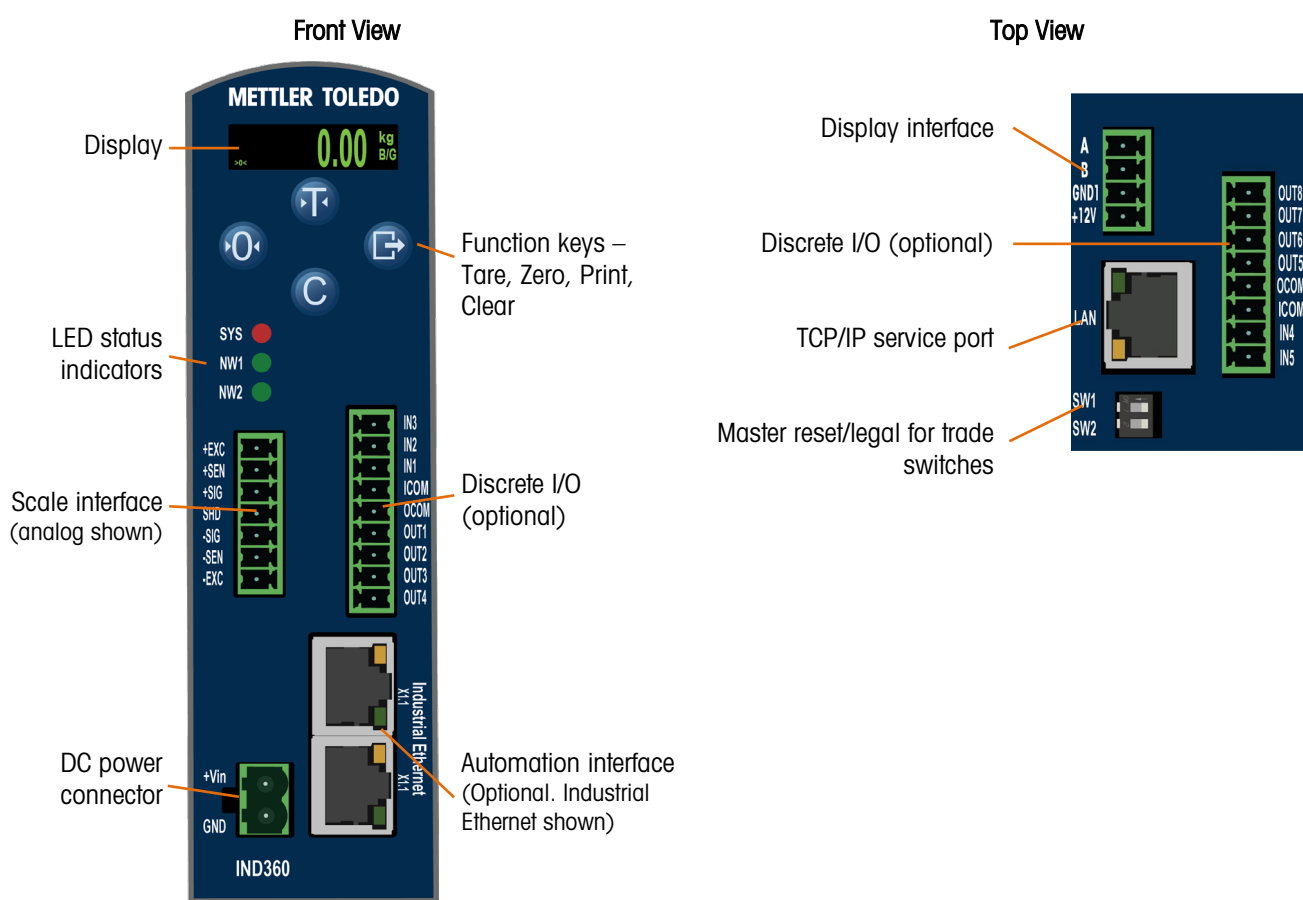

Display Features

Center of Zero



Weight display



Motion



Tare/Net



Units



Gross



Front Panel and Display Features, Panel-Mount and Harsh Environment Versions

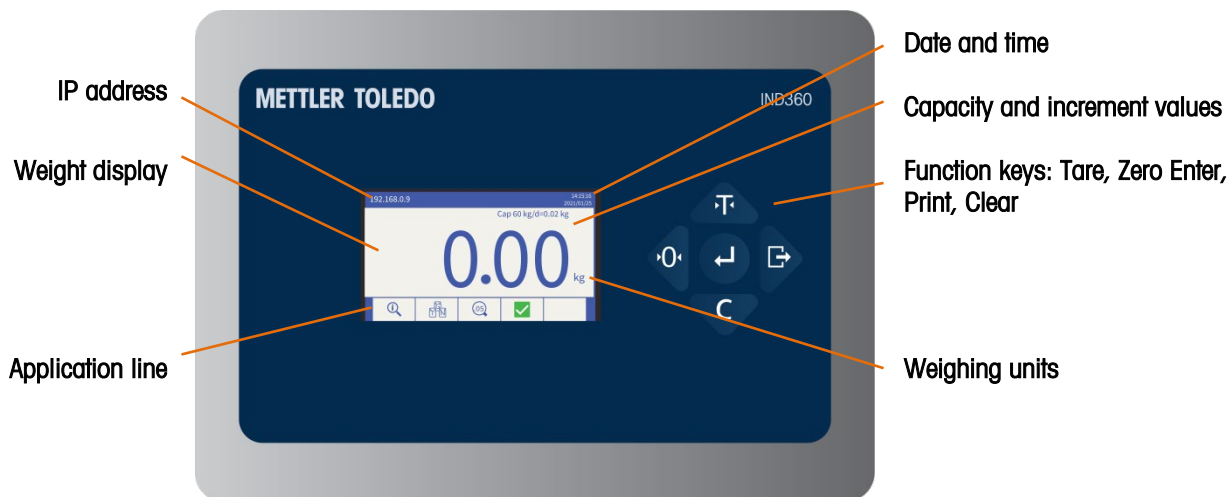

Pushbutton Functions, All Versions

Scale Function Keys, Weighing Mode	DIN	Panel/Harsh	Scale Function Keys, Menu and Data Entry Modes
When a container is on the scale, memorize tare value and display a net zero weight			Scroll up in a menu display
Capture a new gross zero reference point			Scroll left in a menu display
Clear the current tare value; the display will revert to the gross weight value			Scroll down in a menu display
Transmits data from the indicator; long press enters Operator Menu [For details on the ePrint function, reference the User's Guide]			Confirms an entry and/or moves to the next item in a menu display or to next lower menu level Moves cursor to the right
Select softkey [Panel and harsh environment versions only]			Move to next lower menu level; select data entry field; confirm value entry.

Operator Menu Icons [Accessible only if indicator is not in Approved Mode]

	Information Recall	Access system information
	Error Message	Display current error messages (e.g. Scale underload)
	Enhanced Resolution	Display weight value with additional decimal place
	Scale Setup	Set capacity and increment; calibrate zero and span; configure filter; reset calibration values
	Application	Enable/disable embedded Application
	Terminal	Display indicator settings, such as serial number
	Communication	Enable/disable web server, PC applications, and ePrint
	Maintenance	Access indicator maintenance functions

3. Operating Instructions

Weights and Measures Approved Mode

When the indicator is used in metrologically-approved applications, it is sealed with a paper or wire seal. Do not tamper with the seal.

Two DIP switches, 1 and 2, are accessible on the top of the IND360, and inside the IND360 Harsh Environment model's enclosure. The table below shows the location of the DIP switches and summarizes their functions.

			Switch 1	Switch 2	Function
Panel and DIN Rail Mount Enclosures			Standard (Automation) Mode		
			OFF	OFF	Normal operation
			OFF	ON	Master reset of all data during indicator power-up
Harsh Environment Enclosure			Approved Mode (for sales to public)		
			ON	OFF	Legal-for-trade mode; calibration data protected
			ON	ON	Reset of all except calibration (adjustment) data during indicator power-up

Web Browser Access to IND360 DIN Rail Mount Model

The IND360 can be configured and controlled directly from its front panel interface, or via a web browser interface. The interface is also a diagnostic tool for service purposes. For web browser access:

- IND360: **Web Server** must be **Enabled** in **Access Security** menu.
- PC, IND360: physically connected to the same network
- PC, IND360: IP addresses configured correctly:

PC: Windows **Control Panel | Network and Internet | Connections**

IND360: Default – **192.168.0.8**

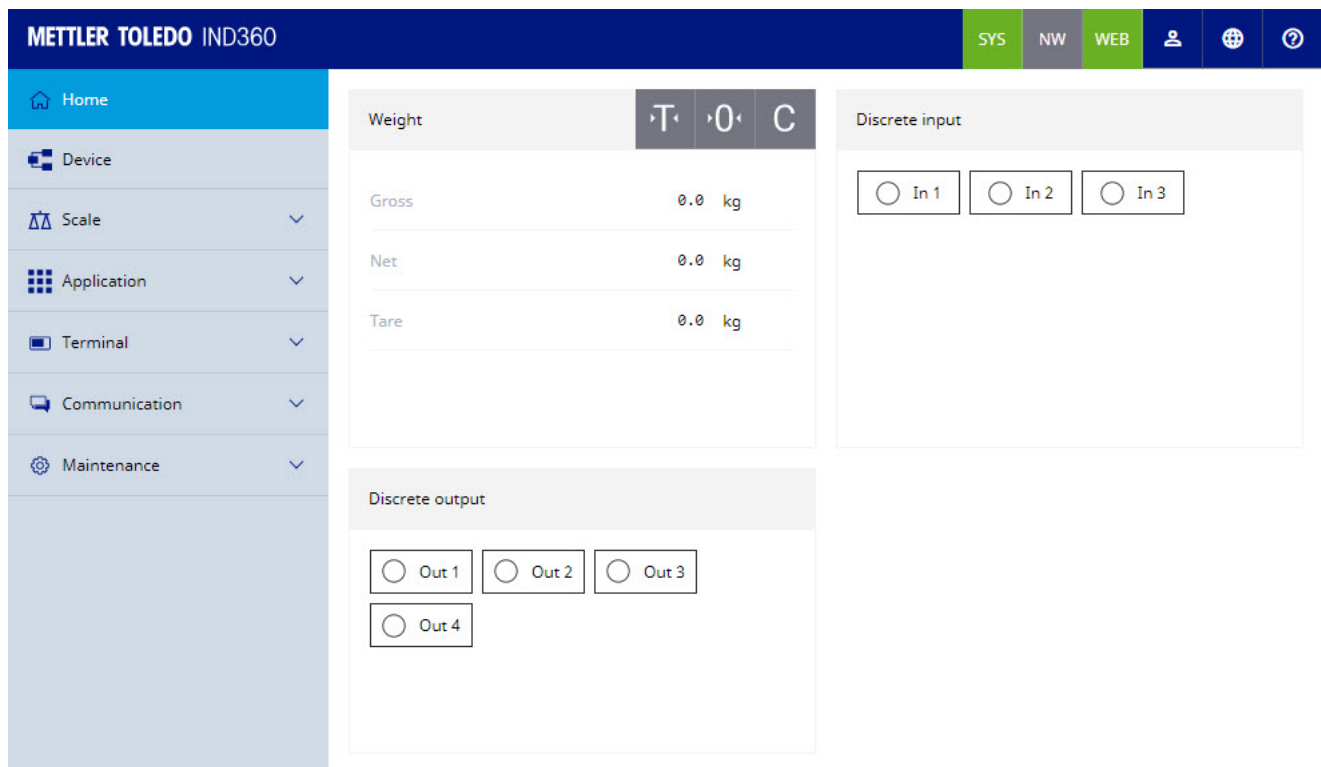

On-Screen Menus

Menu Navigation

Within the Operator Menu, the Scale Function Keys work as follows:



Data Entry, DIN Rail Mount Version

When an on-screen item requires data entry, the Scale Function Keys work as follows:

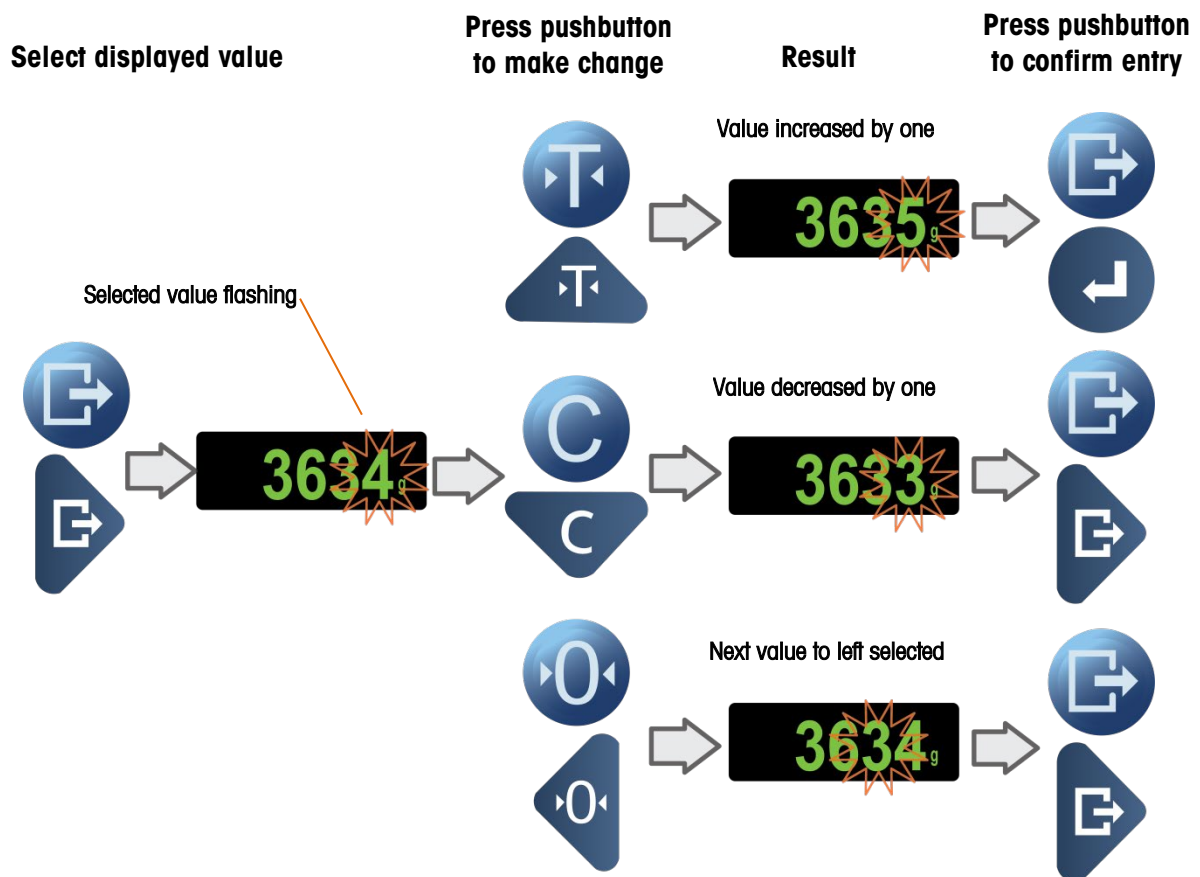

Accessing and Exiting the Softkeys, Harsh Environment and Panel-Mount Versions

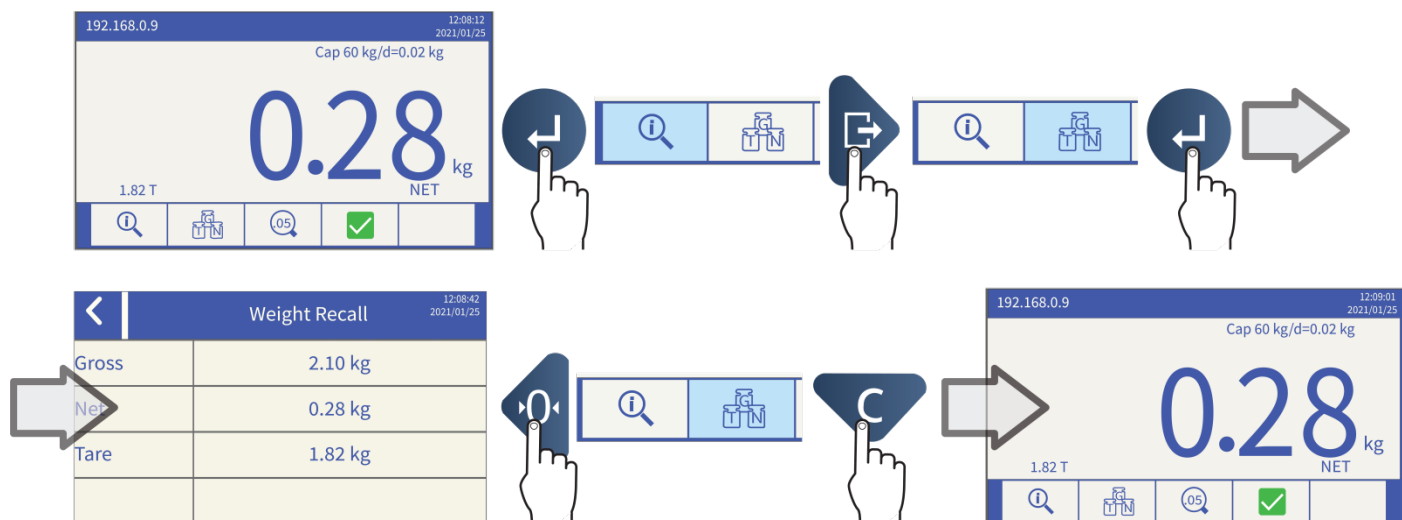

Accessing and Exiting the Operator Menu

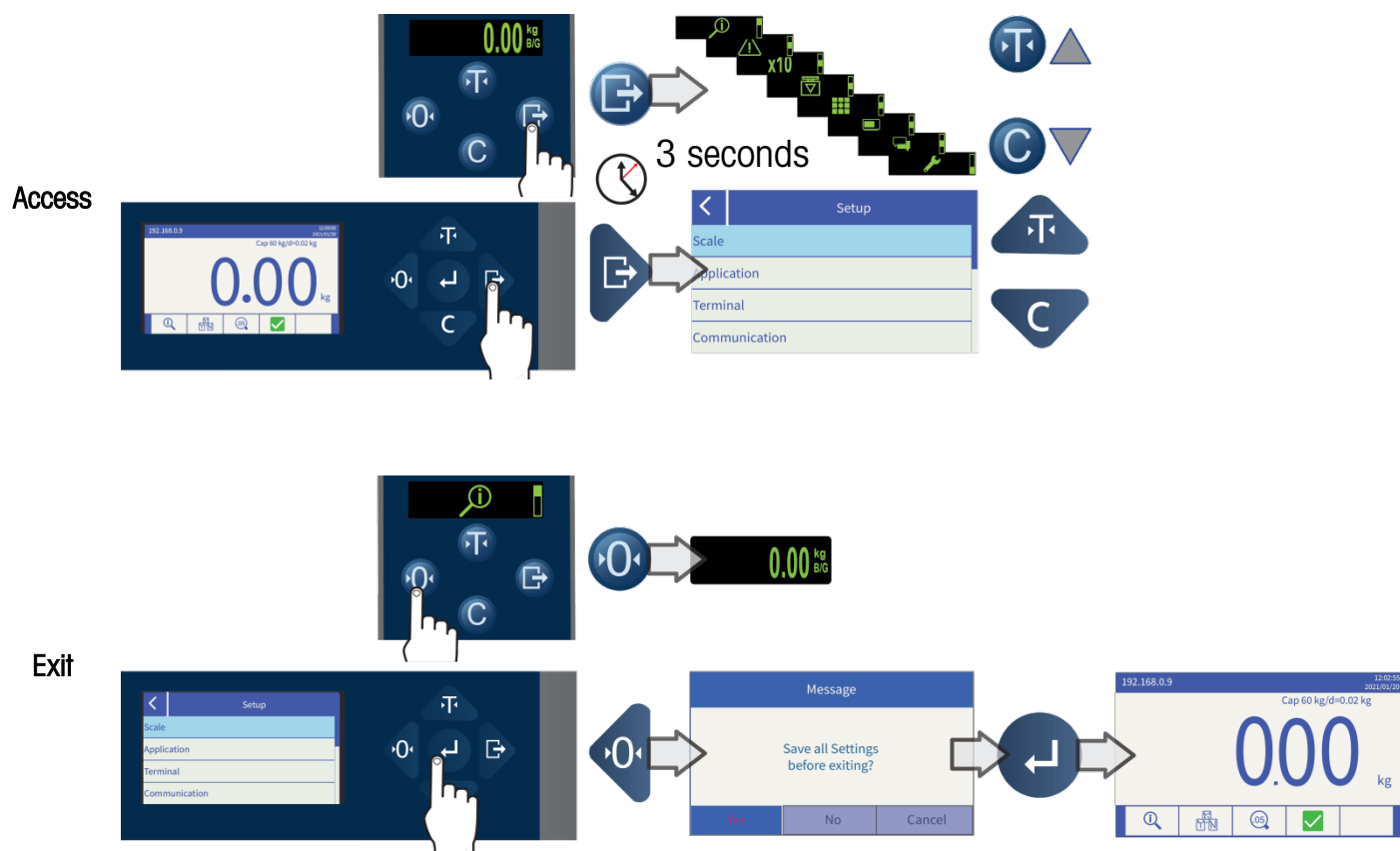

4. Basic Functions

Zero

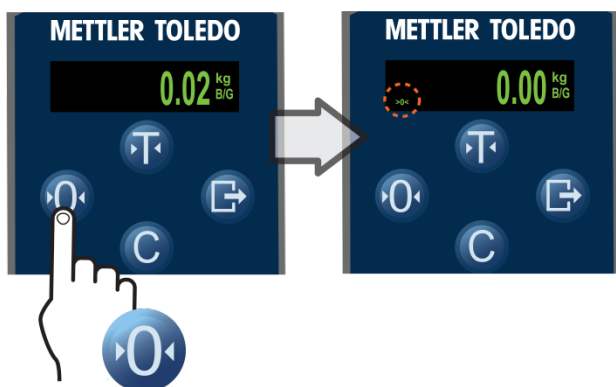
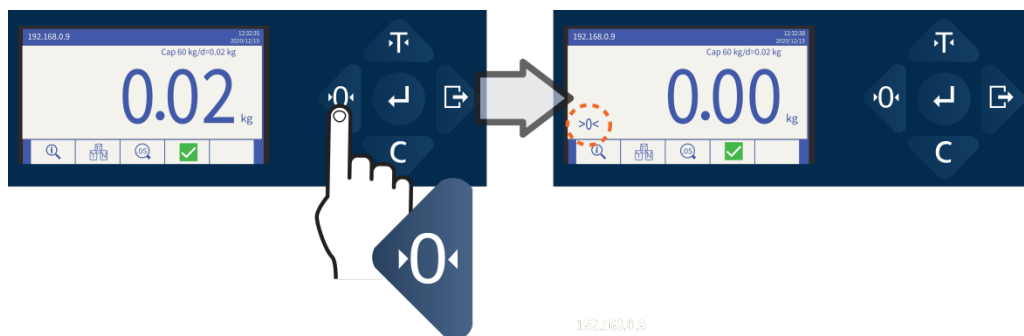

Tare

Tare Operation

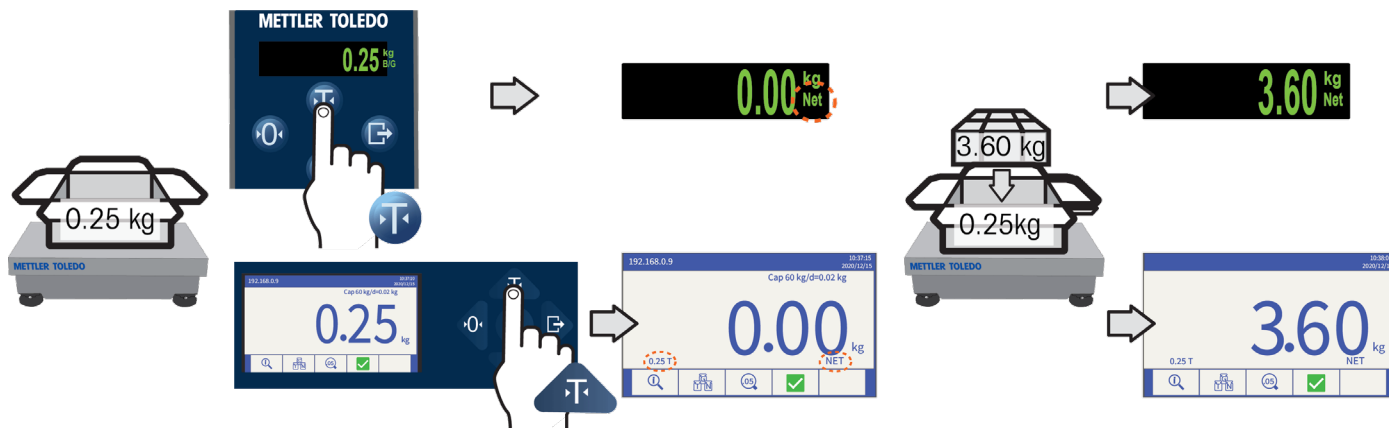

Clear Tare

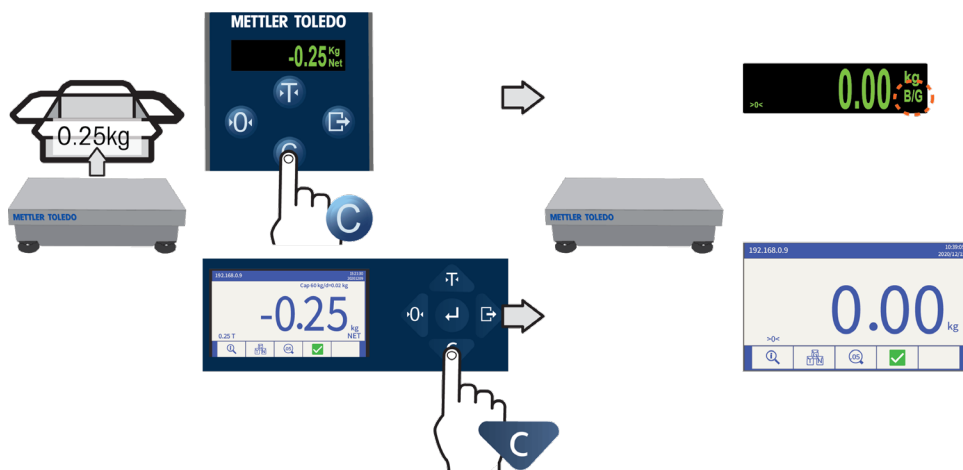



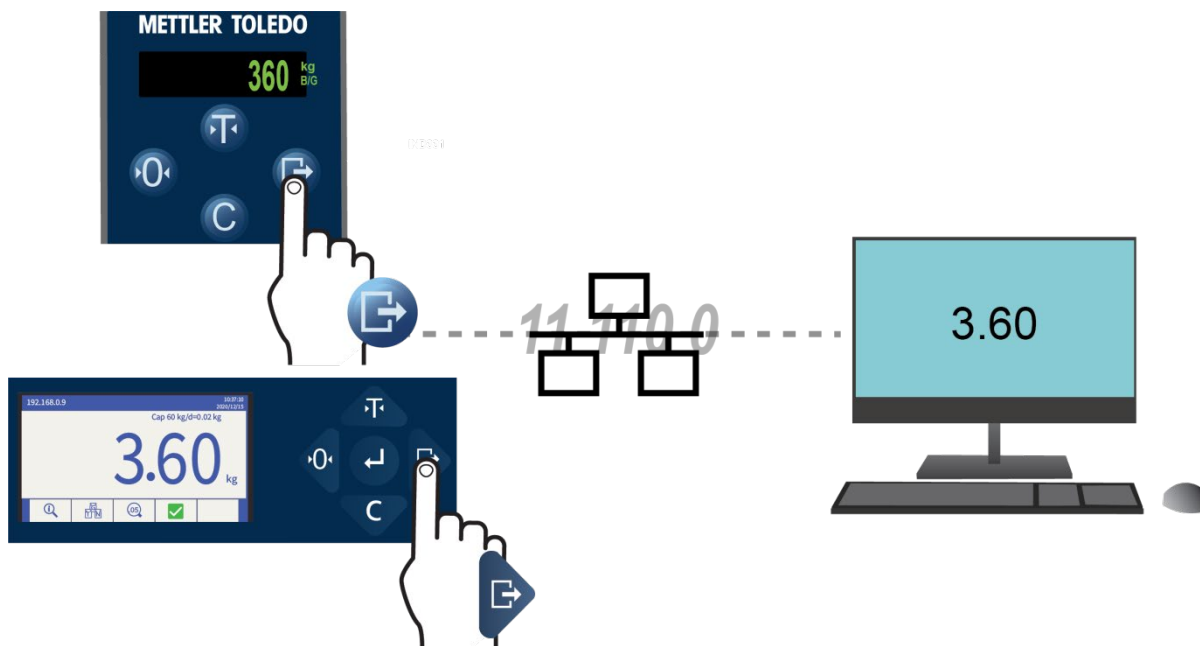

ePrint



5. Diagnostics and Maintenance

Common Errors

Overcapacity	Indicator cannot execute commands because the weight on the scale is over the adjusted (calibrated) capacity. The weight display shows blanked condition: 
Undercapacity	Indicator cannot execute commands because the weight is under the current captured zero. The weight display will show an under zero condition: 
Motion	If motion is detected when a command is received, the IND360 will wait for a no-motion condition. If a stable (no motion) weight condition is reached, the command is executed. If a no-motion state cannot be reached, the command is aborted and a "Scale In Motion" error displays.
Failure to Zero	If pushbutton zero is enabled and the operator presses the ZERO scale function key, these common errors may occur: <ul style="list-style-type: none"> Zero Failed-Range: Gross weight outside the programmed zero range Zero Failed-Net Mode: zero failed because scale is in net mode Scale In Motion: zero failed due to motion on scale If EEE is shown on display, the indicator has not captured a zero reference at power-up
Failure to Print	When an operator attempts to use the print function, these common errors could occur: <ul style="list-style-type: none">  ePrint improperly configured  Scale In Motion: print failed due to motion on scale
Function Disabled	Error occurs if an operator attempts to access a disabled function.
Access Denied. User Not Authorized	Occurs if an operator attempts to access an unauthorized function.

Cleaning the Indicator

Use a soft, clean cloth and mild glass cleaner. Do not spray cleaner directly onto Indicator. **Do not use** industrial solvents such as acetone.

www.mt.com/ind-IND360

For more information

Mettler-Toledo
Im Langacher 44
8606 Greifensee
Switzerland

Phone 800 438 4511

© 2021 Mettler-Toledo, LLC
30654686, 04/2022