

# ICS685 / ICS689

## Weighing systems

ICS685

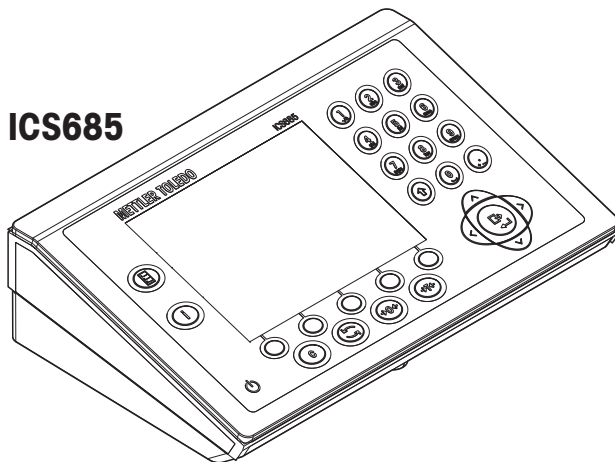

ICS689

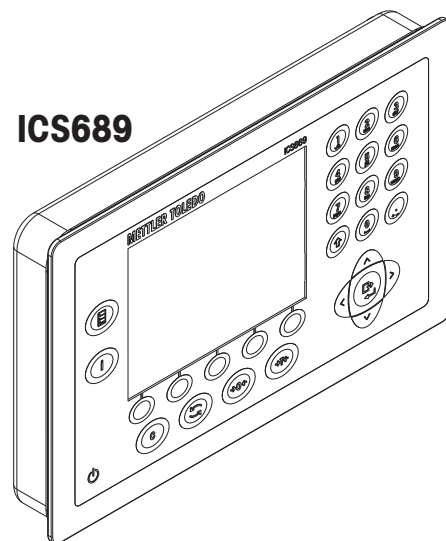

METTLER TOLEDO



# METTLER TOLEDO Service

Congratulations on choosing the quality and precision of METTLER TOLEDO. Proper use of your new equipment according to this Manual and regular calibration and maintenance by our factory-trained service team ensures dependable and accurate operation, protecting your investment. Contact us about a service agreement tailored to your needs and budget. Further information is available at [www.mt.com/service](http://www.mt.com/service)

There are several important ways to ensure you maximize the performance of your investment:

- 1 **Register your product:** We invite you to register your product at [www.mt.com/productregistration](http://www.mt.com/productregistration) so we can contact you about enhancements, updates and important notifications concerning your product.
- 2 **Contact METTLER TOLEDO for service:** The value of a measurement is proportional to its accuracy – an out of specification scale can diminish quality, reduce profits and increase liability. Timely service from METTLER TOLEDO will ensure accuracy and optimize uptime and equipment life.
  - ⇒ **Installation, Configuration, Integration and Training:** Our service representatives are factory-trained, weighing equipment experts. We make certain that your weighing equipment is ready for production in a cost effective and timely fashion and that personnel are trained for success.
  - ⇒ **Initial Calibration Documentation:** The installation environment and application requirements are unique for every industrial scale so performance must be tested and certified. Our calibration services and certificates document accuracy to ensure production quality and provide a quality system record of performance.
  - ⇒ **Periodic Calibration Maintenance:** A Calibration Service Agreement provides on-going confidence in your weighing process and documentation of compliance with requirements. We offer a variety of service plans that are scheduled to meet your needs and designed to fit your budget.



# Table of Contents

<b>1</b>	<b>Introduction</b>	<b>7</b>
1.1	Safety instructions	7
1.2	Presentation	8
1.3	Application overview	21
1.4	Commissioning	25
<b>2</b>	<b>Operation</b>	<b>29</b>
2.1	Switching on/off	29
2.2	Login/Logout	29
2.3	Straight weighing	29
2.4	Switching units	30
2.5	Zeroing / Zero point correction	30
2.6	Weighing with tare	30
2.7	Displaying information	33
2.8	Printing results	33
2.9	Average (dynamic) weighing	34
2.10	Working with identifications	35
2.11	Working in a higher resolution	35
2.12	Switching scales	36
2.13	Working with a prompt	36
2.14	Memory log files	43
2.15	Cleaning	45
2.16	Verification test	46
<b>3</b>	<b>Counting</b>	<b>47</b>
3.1	Counting parts into a container	47
3.2	Counting parts out of a container	47
3.3	Determining the parts in a full container	48
3.4	Counting with a known average piece weight	48
3.5	Changing reference quantity	48
3.6	Counting with reference weight check	49
3.7	Reference optimization	50
3.8	Counting with automatic reference determination	50
3.9	Counting with custom unit	51
3.10	Counting with reference and bulk scale	52
<b>4</b>	<b>Over/Under Checkweighing and Filling</b>	<b>53</b>
4.1	Overview	53
4.2	Specifying target values for Over/Under Checkweighing or Filling	54
4.3	Specifying target number of pieces for Over/Under Checkcounting	54
4.4	Over/Under Checkweighing or Checkcounting procedure	55
4.5	Filling procedure	55
4.6	Over/Under Checkweighing / Filling during subtractive weighing (Take away)	56
4.7	Over/Under Checkweighing / Filling with "Quick start"	56
4.8	Over/Under Checkweighing to zero / Filling to zero	57
4.9	Leaving Over/Under Checkweighing / Filling	57
<b>5</b>	<b>Classifying</b>	<b>58</b>
5.1	Overview	58
5.2	Specifying class definition values	58
5.3	Classifying procedure	59
5.4	Classifying during subtractive weighing	59
5.5	Automatic printout of Classifying results	60
5.6	Terminating Classifying	60

<b>6</b>	<b>Totalization</b>	<b>61</b>
6.1	Starting totalization	61
6.2	Totalizing manually	61
6.3	Automatic totalizing	63
6.4	Totalizing to a target	64
6.5	Totalizing with leaving the totalized items on the scale	64
6.6	Statistical evaluation of the sum	65
6.7	Terminating totalizing	66
<b>7</b>	<b>Settings in the menu</b>	<b>67</b>
7.1	Menu overview	67
7.2	Operating the menu	67
7.3	Scale menu block	70
7.4	Application menu block	80
7.5	Terminal menu block	96
7.6	Communication menu block	102
7.7	Maintenance menu block	113
<b>8</b>	<b>Quick Select menu</b>	<b>115</b>
8.1	Quick Select menu overview	115
8.2	Entering main menu	115
8.3	Logout	115
8.4	Database	116
8.5	Calling up memory log file	121
8.6	Statistics	121
8.7	Performing routine test	121
8.8	Performing corner load test	122
8.9	Calling up routine test / corner load test log files	123
8.10	Calling up calibration log file	124
<b>9</b>	<b>Event and error messages</b>	<b>125</b>
9.1	Error conditions	125
9.2	Errors and warnings	126
9.3	Smart weighing counter / spanner icon	128
9.4	Service information	128
<b>10</b>	<b>Technical data and accessories</b>	<b>129</b>
10.1	Devices for dry environment	129
10.2	Devices for wet environment	136
10.3	General technical data	145
<b>11</b>	<b>Appendix</b>	<b>146</b>
11.1	Metrological information	146
11.2	Table of Geo Code values	146
11.3	Disposal	147
11.4	Protocol printouts	148
	<b>Index</b>	<b>149</b>

# 1 Introduction

## 1.1 Safety instructions

### General

- Do not use the device in a hazardous environment. Special devices are available in our range of products for hazardous environments.
- The safety of the device cannot be ensured if it is not operated in accordance with these operating instructions.
- Only authorized personnel may open the device.

### Devices with protection level IP5x or IP65

Devices with protection level IP54 or IP65 are protected against dust and splashing of water respectively dust-tight and protected from water jets according to EN 60529. They are suitable for use in dusty environments and brief contact with liquids.

- Ensure that the device is dried off after coming into contact with liquid.
- Do not use the device in environments with a risk of corrosion.
- Do not flood the device or submerge it in liquid.

### Devices with built-in power supply unit

- Ensure that the power socket outlet for the device is earthed and easily accessible, so that it can be de-energized rapidly in emergencies.
- Ensure that the supply voltage at the installation site lies within the range of 100 V to 240 V.
- Ensure that there is a space of at least 3 cm (1.25") at the rear in order to prevent the power cable from being bent too strongly.
- Check the power cable regularly for damage. If it is damaged, immediately disconnect the device from the power supply unit.

### Devices with built-in storage battery

- Only use storage batteries from the manufacturer.
- Do not use the battery charger in humid or dusty rooms or below 0 °C (32 °F) ambient temperature.
- After the storage battery has been charged, the cover cap of the charging socket on the device must be closed.

### Compact scales / Terminal and platform combinations

- Avoid falling and shock loads as well as any impact from the side.
- The maximum static safe load must never be exceeded. Observe the operation limits, see technical data of the connected weighing platform.

## 1.2 Presentation

### 1.2.1 Type overview

**ICS685 / ICS689** weighing terminals vary in the following:

	<b>ICS685</b>	<b>ICS689</b>
<b>Numeric</b> keypad	X	X
<b>Color</b> display	X	X
Environment	dry	wet
Available as <b>compact scale</b>	X	–
Available as <b>terminal and platform combination</b>	X	X

### Default equipment

#### ICS685 / ICS689 weighing terminals

Each weighing terminal offers the following interfaces:

- 1 serial interface RS232 (in Europe: 2 x RS232)
- 1 scale interface, analog or digital

#### ICS685k-.../f compact scales

The compact scales offer the following interfaces:

- 1 serial interface RS232 (in Europe: 2 x RS232)
- 1 scale interface SICSpro

### Optional equipment

Two additional interfaces are possible, either communication interfaces or scale interfaces.

<b>Optional interface</b>	<b>COM1</b>	<b>COM2</b>	<b>COM3</b>	<b>SCL2</b>	<b>SCL1</b>
RS232	Default	X	X	X	–
RS422/RS485	–	X	X	X	–
USB Device	–	X	X	–	–
USB Host	–	X	–	X	–
Ethernet	–	–	X	–	–
WLAN	–	–	X	–	–
Digital I/O	–	X	–	–	–
Analog scale	–	–	–	X	X
SICSpro scale	–	X	X	X	X
IDNet scale	–	–	–	X	X

- RS232 usable as data interface or SICS scale
- RS422/RS485 usable as data interface or scale interface SICSpro
- SCL2 can be equipped with a scale interface or a communication interface (COM4)



## 1.2.2 Display

To meet your special requirements, different display layouts are available in the menu under `Terminal` -> `Device` -> `Display layout`.

### Straight weighing display – Default layout

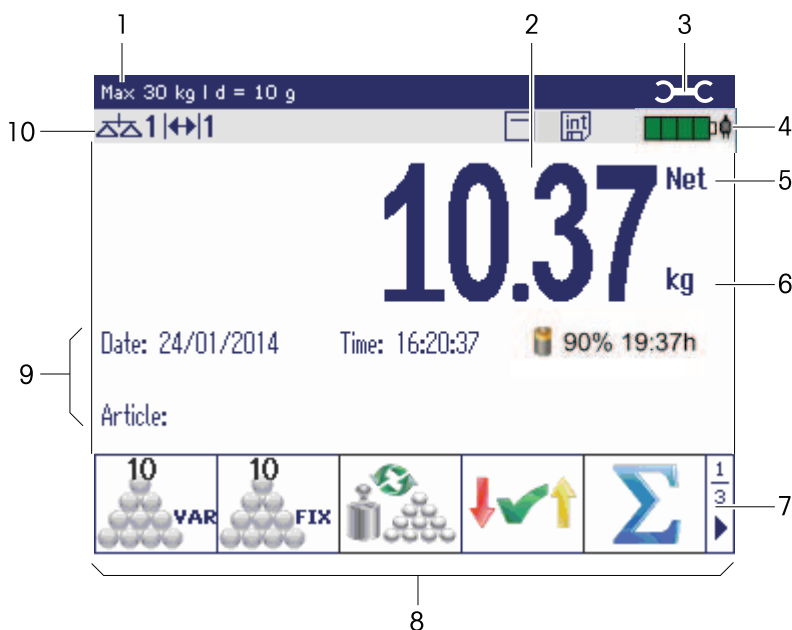

- |           |   |   |
|-----------|---|---|
| <b>1</b>  | Metrological data   | For details see following table                                 |
| <b>2</b>  | Weight value with star, sign and stability monitor  | For details see following table                                 |
| <b>3</b>  | Spanner icon: service needed  | For details see event and error messages                        |
| <b>4</b>  | Battery symbol  |   |
| <b>5</b>  | Net/Gross   |   |
| <b>6</b>  | Unit  |   |
| <b>7</b>  | Indication of the soft key page (1/4) and navigation hint:<br>use cursor keys < or > for scrolling soft key pages |   |
| <b>8</b>  | Soft keys (factory setting, page 1)   |   |
| <b>9</b>  | Auxiliary data line<br>3 lines can be defined in the menu, specific to the weighing application                   | The contents is defined in the menu; here: Date & Time, Article |
| <b>10</b> | Symbol and info line  | For details see following table                                 |

### Straight weighing display – 3-line mode

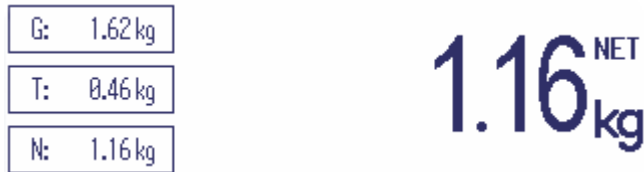

- You can switch display layouts with the soft key  or select the display layout in the Terminal menu.
- The selected display layout is active for all applications.

### Straight weighing display – Bargraph

In the auxiliary lines a graphic display of the scale capacity can be activated.

**Prerequisite:** In the Application menu Bargraph is activated for one of the auxiliary lines.



The bargraph indicates roughly which part of the scale capacity is already occupied and what capacity is still available.

In the example above, approximately 3/4 of the scale capacity is occupied, although the applied net weight isn't really high. The reason therefore could be a high tare weight.

### 1.2.3 Display in Over/Under Checkweighing mode

In Over/Under Checkweighing mode (see Over/Under Checkweighing or Checkcounting procedure [► 55]) the display uses colors to indicate the checkweighing status. Three different layouts can be selected in the menu or via soft key.



#### Default layout

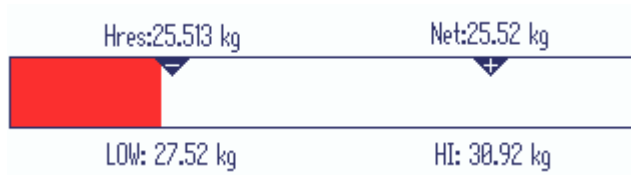

Instead of the weight display a bargraph is displayed indicating target values. The example shows the default color for a sample below the lower tolerance.

#### 3-line mode



Tolerances and target weight are displayed in 3 lines.

The example shows the default color for a sample above the upper tolerance.

#### Color mode



The example shows the default color for a good sample.

- i** • You can switch display layouts with the soft key  or select the display layout in the `Terminal` menu.
- The selected display layout is active for all applications.

## 1.2.4 Display in Filling mode

In Filling mode (see Filling procedure [▶ 55]), instead of the weight display, a bargraph and colors indicate the filling status.

### Too low



As long as the weight is below the tolerance, a red bar is displayed.

### Good

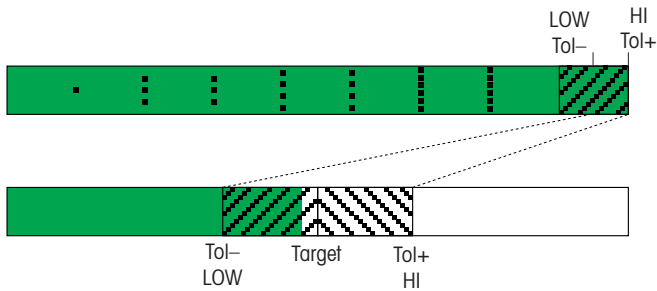

When the weight approaches the good range, a second bar is displayed, in which the tolerance range is spread. This is an aid to exactly fill in the target weight.

### Too high

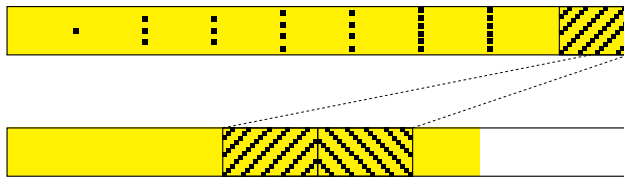

When the weight exceeds the tolerance range, the color changes to yellow.



- You can switch display layouts with the soft key  or select the display layout in the Terminal menu.
- The selected display layout is active for all applications.

## Metrological data line

**i** The metrological data is stored in the weighing platform. The weighing terminal only serves as indicator.

In the metrological data line the following information is displayed:

Symbol	Information	Remark
	Accuracy classes	Displayed only if the scale is approved according to the Weights and Measures guidelines
<b>W1</b> , <b>W2</b> , <b>W3</b>	Weighing range information	For multi range devices only and if the scale is approved according to the Weights and Measures guidelines
<b>Max</b> , <b>cap</b>	Maximum capacity	<b>cap</b> for NTEP only
<b>Min</b>	Minimum capacity	Displayed only if the scale is approved according to the OIML Weights and Measures guidelines
<b>e =</b>	Approved resolution	Displayed only if the scale is approved (OIML)
<b>d =</b>	Display resolution	Please note for approved scales: <b>OIML</b> : Displayed only if d is different from e <b>NTEP</b> : Always displayed
<b>Approved scale</b>	Approved weighing device	Metrology display disabled for SICS scales, e.g., BBK422. Weights and Measures data must be indicated on a label near the weight display.















## Weight value

The weight value can be marked with the following symbols:

Symbol	Information	Remark
<b>*</b>	Calculated weight value	For example for average weighing results
<b>—</b>	Sign	For negative weight values
<b>○</b>	Stability monitor	For unstable weight values
<b>1.234<sub>3</sub> kg</b>	Non-approved last digit with e>d	For approved scales only The example shows the weight value for a scale with e=1g and d=0.1g. The last, smaller digit is not approved.



## Symbols and info line

In the symbols and info line the following information can be displayed:

Symbol	Information	Remark
	Scale number	Displayed only if 2 or more scales are connected
<->	Weighing range	For multi range or multi interval scales only
	Weight below minimum weight	MinWeigh must be activated in the menu
	Average weighing	Average must be activated in the menu
	Automatic taring	Auto Tare must be activated in the menu
	Automatic clearing of the tare weight	A-Clear Tare must be activated in the menu
↓0	Over/Under checkweighing to zero	To zero must be assigned to a soft key in the menu
>0<	Center of zero indication	Availability depending on local Weights and Measures regulations
	Automatic APW (average piece weight) optimization	APW optimization must be set to Auto
	Totalization	Totalization active
<b>Fact</b>	Fact needs to be done	Fact = Fully automatic calibration test. When Fact is displayed: Ensure that the weighing platform is empty and wait until the calibration test is done automatically. For <b>ICS685k-.../f</b> compact scales only.
	Statistics	Statistics active
	Internal database	Internal database active
	External database active	Article information is stored externally. The internal database is inactive.
	WLAN connected	–
	WLAN disconnected	–
	LAN connected	–
	Temperature check	For <b>ICS685k-.../f</b> compact scales only

## 1.2.5 Keyboard













### Function keys

Key	Name	Function in the operating mode	Function in the menu
	Power	<ul style="list-style-type: none"> <li>Switching on and off</li> <li>Cancelling editing</li> </ul>	<ul style="list-style-type: none"> <li>Cancelling editing</li> <li>Exiting menu</li> </ul>
<b>C</b>	Clear	<ul style="list-style-type: none"> <li>Clearing tare</li> <li>Leaving info page</li> <li>Leaving application</li> </ul>	<ul style="list-style-type: none"> <li>Clearing value</li> <li>Clearing digit</li> </ul>
	Switch	<ul style="list-style-type: none"> <li>Switching over weight unit</li> </ul>	<ul style="list-style-type: none"> <li>Re-editing</li> <li>Switching over from numerics to upper/lower case letters</li> </ul>
<b>→0←</b>	Zero	<ul style="list-style-type: none"> <li>Setting scale to zero</li> <li>Clearing tare</li> </ul>	—
<b>→T←</b>	Tare	<ul style="list-style-type: none"> <li>Taring scale</li> <li>Clearing previous tare</li> </ul>	—
<b>i</b>	Info	<ul style="list-style-type: none"> <li>Activating info screen</li> <li>Proceeding to the next info line / info page</li> <li>Freezing and releasing startup screen</li> </ul>	—
	Transfer	<ul style="list-style-type: none"> <li>Transferring data to a printer or computer</li> </ul>	<ul style="list-style-type: none"> <li>Confirming entry/selection</li> </ul>
<	Cursor key	<ul style="list-style-type: none"> <li>Navigating</li> </ul>	<ul style="list-style-type: none"> <li>Leaving menu item</li> <li>Back to the next higher menu level</li> </ul>
>	Cursor key	<ul style="list-style-type: none"> <li>Navigating</li> </ul>	<ul style="list-style-type: none"> <li>Entering menu item</li> </ul>
^ / v	Cursor keys	<ul style="list-style-type: none"> <li>Navigating</li> </ul>	<ul style="list-style-type: none"> <li>Navigating up/down</li> </ul>

## Soft keys

To meet your specific application requirements, **ICS685 / ICS689** offer 16 soft keys which can be configured in the `Terminal` menu. The soft keys are divided into four lines (pages).

### Factory setting ICS685

<b>Page 1</b>					
	Reference n var here: 10 pieces	Reference n fixed here: 10 pieces	Weight/count	Over/Under Checkweighing	Totalizing
<b>Page 2</b>					
	Higher resolution	Filling	Database	Memory <sup>1)</sup>	Logout <sup>2)</sup>
<b>Page 3</b>					
	Display layout	Switching scale <sup>3)</sup>			
<b>Page 4</b>	Page 4 is free for customer configuration. When scrolling further after the last page, page 1 is displayed again.				



## Factory setting ICS689

### Page 1



Over/Under  
Checkweighing



Database



Filling



Memory <sup>1)</sup>

### Page 2



Higher resolution



Totalizing



Classifying



Logout <sup>2)</sup>

### Page 3



Display layout



Switching scale <sup>3)</sup>



Reference n var  
here: 10 pieces



Reference n fixed  
here: 10 pieces



APW (average  
piece weight)

**Page 4** Page 4 is free for customer configuration.  
When scrolling further after the last page, page 1 is displayed again.

<sup>1)</sup> The Memory soft key is not available if Memory mode is set to Off.

<sup>2)</sup> The Logout soft key is available only if user management is active.

<sup>3)</sup> The Switching scale soft key is available only if more than 1 scale is connected.

























### Operating soft keys

- Press the key below the desired function.

### Changing soft key line

- Press the cursor keys < or > to switch from line to line.

### Soft key options

Symbol	Menu setting	Function	Symbol	Menu setting	Function
	Zero	Zeroing		APW	Enter the average piece weight
	Tare	Taring		APW optimization	Reference weight optimization, only if activated in the menu and if a reference weight is determined
	Alibi memory	Calling up the optional alibi memory		Totalizing	Get sum of several weighings
	Switch scale	Switching between the connected scales		Over/Under Checkweighing	Enter Over/Under Checkweighing parameters
	x10 display	Show the weight value with 10 times higher resolution		Filling	Enter filling parameters
	Transfer	Data transfer to a printer or computer		Classifying	Enter class parameters
	Average weighing	Start average weighing		Weight/count	Switch between weight display and display of pieces
	ID1	Enter identifications. In the menu, another designation can be assigned to the keys.		Save as article	Save the current article parameters in the database
	ID2			Database	Show database
	ID3		Custom input	Recall article	Recall parameters from the database
Custom input	Prompt 1, Prompt 2, Prompt 3	Start a workflow. In the menu, another designation can be assigned to the keys.		Logout	Logout from the terminal
	Ref n var	Determine the average piece weight, freely adjustable		Display layout	Switch between default weight display and 3-line mode
	Ref n fix	Determine the average piece weight, fixed reference sizes		Temperature check	Check device temperature (only for <b>ICS685k-.../f</b> and if activated in the menu)
	Cons. number	Enter start value for printout with consecutive number			

## 1.2.6 Alphanumeric input





When an alphanumeric input is requested, one of the following symbols is displayed in the right top edge of the display:

**123**  for numeric input and special characters









**ABC**  for input in upper case letters

**abc**  for input in lower case letters



- To activate the cursor in a text field, press .
- To switch between numerics and upper/lower case letters press  (Shift).
- Text entries work like, e.g., on a mobile phone. Up to four characters are assigned to the keys of the numeric keyboard.
- Entries must be confirmed with  or soft key .

### Example: Enter "ICS6x5"

- 1 Make sure that **ABC**  is displayed.
- 2 To enter letter "I" press key **4** three times.
- 3 To enter letter "C" press key **2** three times.
- 4 To enter letter "S" press key **7** four times.
- 5 Press  (Shift) twice to change to numerics **123** .
- 6 Enter number 6.
- 7 Press  (Shift) twice to change to lower case letters **abc** .
- 8 To enter letter "x" press key 9 twice.
- 9 Press  (Shift) to change to numerics **123** .
- 10 Enter number 5.
- 11 Confirm entry with .

## 1.2.7 Barcode input



To make inputs easier, a barcode scanner can be connected.

Depending on the menu settings, the barcode scanner can be used either for a fixed or a free entry.

### Fixed barcode entry

- Communication -> COMx -> Mode is set to External input.
- Communication -> COMx -> External input -> Destinaton is set to e.g., ID1.
- To enter the selected data, e.g., ID1, just read the barcode.  
⇒ The barcode entry is automatically recognized, e.g., as ID1.

### Free barcode entry

- Communication -> COMx -> Mode is set to External input.
- Communication -> COMx -> External input -> Destinaton is set to e.g., Off.
- Read the barcode and press the desired hard or soft key, e.g.,  or .
- ⇒ The barcode entry is recognized, e.g., as tare preset or ID1.

## 1.2.8 Connections

### ICS685 weighing terminal for dry environments

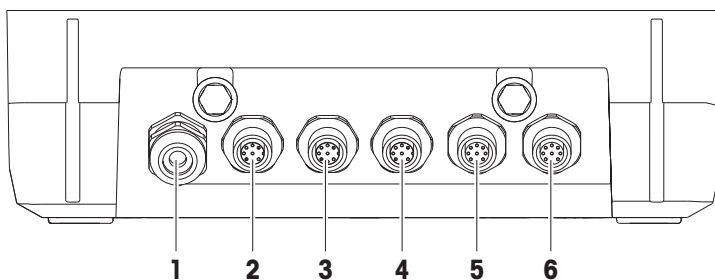

- |   |  |
|---|--|
| <b>1</b> AC power supply or battery charging                                      | <b>2</b> Standard interface COM1 (RS232)   |
| <b>3</b> Optional interface COM2  | <b>4</b> Optional interface COM3 incl. digital scale interface SICSprou and SICS scale |
| <b>5</b> Optional weighing platform connection SCALE 2 or optional data interface | <b>6</b> Weighing platform connection SCALE1   |

### ICS689 weighing terminal for wet environments

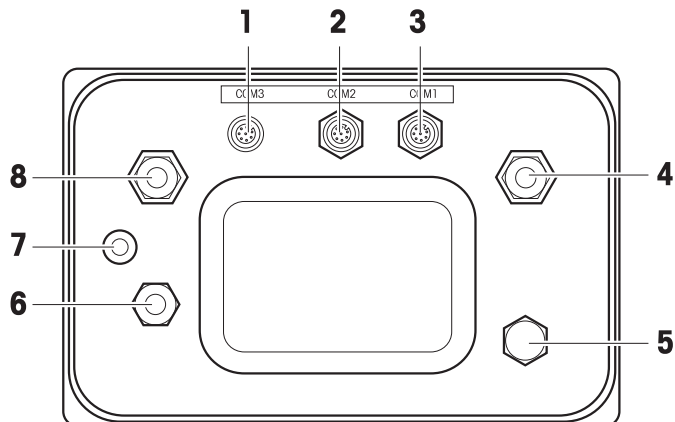

- |  |  |
|--|--|
| <b>1</b> Optional interface COM2                               | <b>2</b> Optional interface COM3                       |
| <b>3</b> Standard interface COM1 (RS232) Pressure compensation | <b>4</b> Weighing platform connection SCALE 1          |
| <b>5</b> Pressure compensation                                 | <b>6</b> AC power supply or battery charging           |
| <b>7</b> Verification securing seal                            | <b>8</b> Optional weighing platform connection SCALE 2 |

## ICS689a-.../c

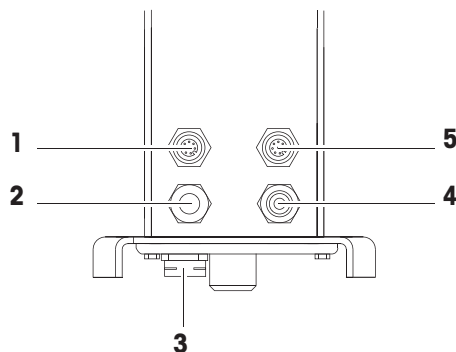

- |   |  |
|---|--|
| <p><b>1</b> Optional interface COM2</p> <p><b>3</b> Pressure compensation</p> <p><b>5</b> Standard interface COM1 (RS232)</p> | <p><b>2</b> Weighing platform connection</p> <p><b>4</b> AC power supply or battery charging</p> |
|---|--|

The verification securing seal is applied directly on the weighing terminal.

## 1.3 Application overview

### 1.3.1 Weighing applications

**ICS685 / ICS689** weighing terminals offer various weighing applications for your special tasks.

- Straight weighing – just load a weight and read the result
  - Average weighing (dynamic weighing) for weighing restless samples, e.g., animals
  - Counting
    - Counting of discrete samples like screws, sheet, ...
    - Measuring of non-discrete samples like lengths, areas, volumes, ...
  - Over/Under Checkweighing and Filling
    - Over/Under Checkweighing of different samples of a kind
    - Filling in liquids or poudery products to a target quantity
  - Classifying
  - Totalizing – also for Counting and Over/Under Checkweighing or Filling results
- i**
- For each application, the contents of the auxiliary lines in the display and the printout can be configured individually.
  - Counting, Over/Under Checkweighing or Filling and Totalizing can be combined.

## 1.3.2 Advanced features

### Overview

**ICS685 / ICS689** weighing terminals offer some advanced features to make operation easier, safer and traceable:

- User management
- Prompting
- Database
- Statistics (as part of the totalizing function)
- Routine test and Routine test log
- Corner load test and Corner load log
- Calibration log file
- Memory (Alibi memory or transaction memory)

### User management

The user management of the **ICS685 / ICS689** allows you to manage up to 20 users by:

- User name and User ID
- User profile (operator or supervisor)
- User language
- User password
- User specific keys



- When user management is activated, any access to the terminal is protected by password.
- User management can be configured in the menu under `Terminal -> User management`.
- Login/logout with user management is described in "Login/Logout [▶ 29]".

### Prompting

The device offers 6 predefined prompts for frequently used workflows. In addition, up to 3 customer specific workflows can be defined to guide the operator.



- Prompts can be configured in the menu under `Application -> Prompting`.
- Operation with prompts is described in Prompt overview [▶ 36] and following.

## Database

The device offers an internal database of up to 5,000 data records for frequently used weighing goods. Each record may contain the following data:

- Article information data
- Weight values
- Piece counting parameters
- Checkweighing parameters
- Filling parameters
- Totalization parameters



- Editing the database is described in Creating a new article [► 118] and following.
- Once application parameters are entered they can be stored in the database as well.
- To edit the database comfortably on your computer, the optional DatablCS software is available ([www.mt.com/ind-databics](http://www.mt.com/ind-databics)). When using DatablCS, up to 30,000 data records are available.

## Statistics

The device offers statistical evaluation of your weighing series.

The following statistical values may be determined:

- Standard deviation
- Standard deviation (good)
- Mean value
- Mean value (good)
- Max. value
- Min. value
- Median
- % ratio per class
- # per class



- To evaluate statistics comfortably on your computer, the optional DatablCS software is available ([www.mt.com/ind-databics](http://www.mt.com/ind-databics)).

## Routine test / Cornerload test

For optimum weighing results the device supports routine calibration and routine cornerload tests. The test results are stored in the corresponding log files.

You can configure routine tests by:

- Interval (days)
- External test
- Internal test (for **ICS685k-.../f** only)

For the external tests you can specify the following:

- Test weight (value)
- Weight name (to make sure you always use the same weight)
- Tolerance



- The routine test and cornerload test can be configured separately for each connected scale in the menu under `Maintenance -> Scale test`.
- Performing the tests and viewing/printing/transferring the log files is described in "Performing routine test [▶ 121]" and following.

## Calibration log file

All calibration results are stored in the calibration log file.

How to view/print/transfer the calibration log file is described in "Calling up calibration log file [▶ 124]".



## 1.4 Commissioning

### 1.4.1 Selecting the location

The correct location is crucial for the accuracy of the weighing results.

- 1 Select a stable, vibration-free and, if possible, a horizontal location for the weighing platform.
  - ⇒ The ground must be able to safely bear the weight of the fully loaded weighing platform.
- 2 Observe the following environmental conditions:
  - ⇒ No direct sunlight
  - ⇒ No strong drafts
  - ⇒ No excessive temperature fluctuations

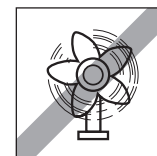
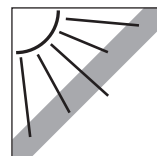
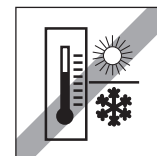
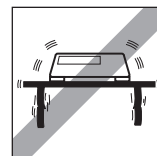

### 1.4.2 Levelling

#### Levelling of weighing platforms

Only weighing platforms that have been levelled precisely horizontally, provide accurate weighing results. Weights and Measures approved weighing platforms have a level bubble to simplify levelling.

- Turn the adjustable feet of the weighing platform until the level bubble's air bubble is inside the inner circle.

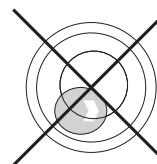
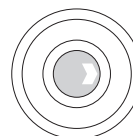

#### Levelling of compact scales ICS685-.../f

On compact scales levelling can be done in an easier way.

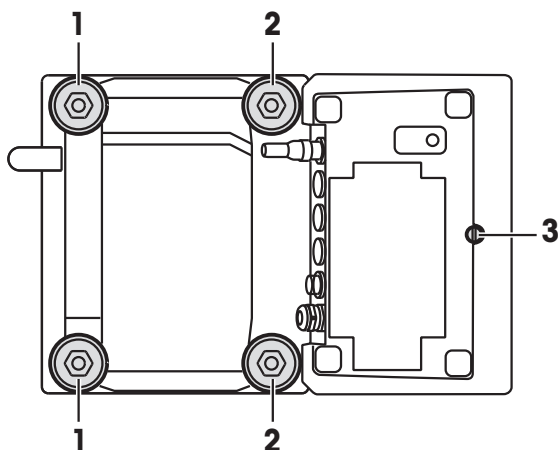

- 1 Turn the compact scale upside down.
- 2 Screw in the 2 adjustable feet (2) on the terminal side of the weighing platform.
- 3 Turn over the compact scale to its normal position.
- 4 Level the compact scale by turning the other 2 adjustable feet (1) of the weighing platform until the level bubble is inside the inner circle.
- 5 Screw out the feet (2) of the weighing platform until they have contact with the table.

**i** The adjustable foot (3) of the weighing terminal is screwed out for 7 mm at the factory and needs not be adjusted for levelling.

### 1.4.3 Weighing platform connection

#### Analog weighing platforms

- Call the METTLER TOLEDO service technician to connect an analog weighing platform to the **ICS685g / ICS689g** weighing terminal.

#### Weighing platforms with digital scale interface

- Connect the weighing platform connector to the **ICS685i / ICS689i** or **ICS685s / ICS689s** weighing terminal.



- If you have ordered an approved weighing system consisting of an **ICS685s** weighing terminal and an approved PBD555 weighing platform, the approval was done in the factory (not for the US market).
- You can disconnect the weighing platform from the **ICS685s / ICS689s** or **ICS685i / ICS689i** weighing terminal of an approved weighing system without violating the approval. If another weighing platform is connected to the weighing terminal, the system is not approved. If the weighing platform of the approved system is connected again, the approval is valid again.
- If you have ordered an approved weighing system consisting of an **ICS685s / ICS689s** weighing terminal and an approved PBK/PFK weighing platform, the approval was done in the factory (not for the US market).
- If you have connected a non-approved weighing platform and want to have the system approved, call the **METTLER TOLEDO** service technician.

### 1.4.4 Power supply connection



#### ⚠ CAUTION

##### Risk of electric shock!

- a) Before connecting the power supply, check whether the voltage value printed on the label corresponds to your local system voltage.
  - b) Do not, under any circumstances, connect the device if the voltage value on the label deviates from the local system voltage.
  - c) Make sure the weighing platform has reached room temperature before switching on the power supply.
- 
- Plug the power plug into the power socket.
  - ⇒ After it has been connected, the device runs a self-test. The device is ready to operate when zero appears on the display.

## 1.4.5 Handling the storage battery

### Battery symbol

The battery symbol shows the current charging status of the storage battery.



- One segment corresponds with approx. 25 % capacity.
- If the symbol flashes, the storage battery has to be charged.
- During charging the segments are "running" until the battery is fully charged and all segments light up continuously.

Note the following when operating a device with a built-in storage battery:

- Before the first operation charge the storage battery for at least 3 hours.
- The operating life depends on the intensity of use, the configuration, and the connected scale. For details concerning **ICS685**, see "Operating life with battery [▶ 132]", or concerning **ICS689**, see "Operating life with battery [▶ 138]".
- The charging time of the storage battery amounts to 4 to 5 hours. The storage battery is protected against overcharging.
- The storage battery has a service life of 500 to 1,000 charging/discharging cycles.



#### ⚠ CAUTION

**Charging the storage battery below 0° C (32 °F) or above 40 °C (104 °F) is prevented by the charging electronics!**

- Make sure that the temperature is within the range of 0 °C to 40 °C (32 °F to 104 °F) to charge the storage battery.



#### ⚠ CAUTION

**Danger of soiling because the charger for the storage battery is not protected according to IP69K!**

- Do not charge the device in humid or dusty rooms.
- After the storage battery has been charged, close the cover cap of the charging socket on the device.

### Recommended use of the storage battery

The characteristics mentioned above are only valid if the following recommendations are observed:

- Change the battery as soon as the warning message "Low battery" appears and the battery symbol starts flashing. When the message appears, you still have enough time (at least 10 minutes), to complete your current task.
- For optimum battery performance, operate the device with built-in storage battery at an ambient temperature range of 10 °C to 30 °C (50 °F to 86 °F). This also applies to discharging the battery.

### Changing battery (ICS685 only)

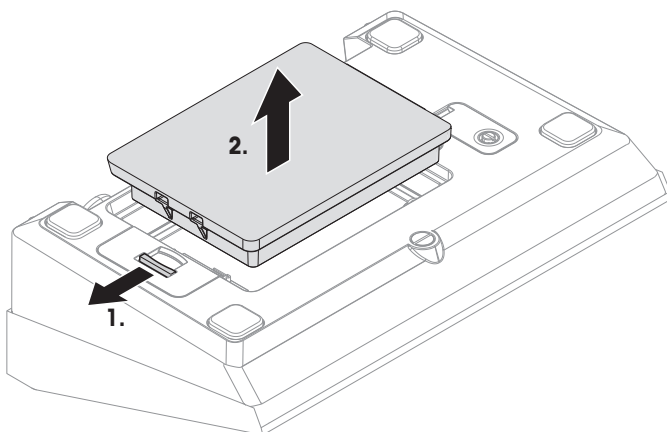

- 1 Unlock the battery by moving the slider away from the battery and remove the discharged battery.
- 2 Insert the fully charged battery and secure it by moving the slider towards the battery.



With optional IP65 protection, the battery is not accessible from the outside. Please call the **METTLER TOLEDO** service technician.

### 1.4.6 Use in hygienically sensitive areas

**ICS689** weighing terminals are easy to clean and are designed to be used in the food industry.

#### **ICS689 features**

- Protection degree IP68/69k
- Terminal housing and load plate made of stainless steel
- No open threads
- No screws with recesses
- Keypad made of PET with a smooth surface
- Reduced horizontal surfaces
- Continuous welding seams

## 2 Operation

### 2.1 Switching on/off

#### Switching on

- Press .
  - ⇒ For a few seconds the device shows a start-up screen with device name, software version, serial number of the weighing terminal and the Geo Code value.



- You can freeze the start-up screen by pressing .
- When you start a compact scale, the metrology line shows whether it is approved or not. If you have ordered an approved weighing system, approval has been done in the factory already (not for the US market).
- With **ICS685k-.../f** compact scales ensure that the device is at room temperature before switching on. **To ensure accurate weighing results, wait 15 minutes after switching on before starting weighing operation.**

#### Switching off

- Press .
  - ⇒ Before the display goes out, **-OFF-** appears briefly.



#### Resetting

- Press and hold  for approx. 5 seconds.
  - ⇒ The device is switched off.



### 2.2 Login/Logout

When user management is activated in the `Terminal` menu, a login/logout procedure is required. The login screen is displayed after switching on or logging out.

#### Login

- 1 Select your name using the cursor keys  $\wedge$  /  $\vee$  and confirm with soft key. 
- 2 Enter your password and confirm with soft key. 
- ⇒ The weight display appears.

#### Logout

- 1 Press soft key. 
  - ⇒ A safety prompt is displayed.
- 2 Press soft key. 
  - ⇒ The login screen is displayed, the current user is logged out.



Always log out when leaving the terminal in order to prevent unauthorized persons from working on it.

### 2.3 Straight weighing

- 1 Place weighing sample on the scale.
- 2 Wait until the stability monitor  disappears.
- 3 Read the weighing result.

## 2.4 Switching units

If an additional second weight unit is configured in the menu, it is possible to switch back and forth between the two weight units.

- Press .
- ⇒ The weight value is displayed in the second unit.



- Possible units are g, kg, oz, lb, lb-oz, t and PCS in piece counting.
- When in the menu `Scale -> Display unit & Resolution -> Unit roll` is set to `On`, the weight value can be displayed in all available weight units by repeatedly pressing .

## 2.5 Zeroing / Zero point correction

Zeroing corrects the influence of slight changes on the load plate or minor deviations from the zero point.

### Manual

- 1 Unload scale.
- 2 Press **→0←**.
- ⇒ Zero appears in the display.

### Automatic

In case of non-approved scales, the automatic zero point correction can be deactivated in the menu or the zero range can be changed. Approved scales are set fixed at 0.5 d per second.



- The zero function is only available within a limited weighing range.
- After zeroing the scale, the whole weighing range is still available.

## 2.6 Weighing with tare

### 2.6.1 Taring

- Place the empty container on the scale and press **→T←**.
- ⇒ The zero display and the symbol **NET** appear.
- ⇒ The tare weight remains stored until it is cleared.

### 2.6.2 Clearing the tare

- Press **C**.
- ⇒ The symbol **NET** goes out, the gross weight appears in the display.



If the symbol  is displayed, i.e., the tare function `Auto clear tare` is activated in the `Scale` menu, the tare weight is automatically cleared as soon as the scale is unloaded.

### 2.6.3 Automatic clearing the tare

A tare weight is automatically cleared when the scale is unloaded.

#### Prerequisite

The symbol  is displayed, i.e., the tare function `Auto clear tare` is activated in the `Scale` menu.



The tare weight must be heavier than 9 scale divisions.

## 2.6.4 Automatic taring

If you place a weight on an empty scale, the scale tares automatically and the symbol **NET** is displayed.

### Prerequisite

The symbol **T** is displayed, i.e., the tare function `Auto tare` is activated in the `Scale` menu.



The weight to be tared automatically, e.g., packaging material, must be heavier than 9 scale divisions.

## 2.6.5 Chain tare

With this function it is possible to tare several times if, e.g., cardboard is placed between individual layers in a container.

- The tare function `Chain tare` is activated in the `Scale` menu.

1 Place the first container or packaging material on the scale and press **→T←**.

⇒ The packaging weight is automatically saved as the tare weight, the zero display and the symbol **NET** appear.

2 Load the sample and read/print out the result.

3 Place the second container or packaging material on the scale and press **→T←** again.

⇒ The total weight on the scale is saved as the new tare weight. The zero display appears.

4 Load the sample in the second container and read/print the result.

5 Repeat steps 3 and 4 for other containers.

## 2.6.6 Tare preset

For established container weights enter the tare weight numerically or via barcode / SICS command. Thus, you do not have to tare the empty container.



The entered tare weight is valid until a new tare weight is entered or the tare weight is cleared.

### Tare preset with numeric entry

- 1 Enter the known tare weight and press **→T←** to confirm.
  - ⇒ The weight display shows the negative tare weight and the symbol **NET** appears.
- 2 Place the full container on the weighing platform.
  - ⇒ The net weight is displayed.

### Tare preset with barcode entry

- For barcode use, `Tare preset` is selected as destination for external input in the menu under `Communication -> COMx -> External input -> Destination`.
- 1 Enter the known tare weight via barcode.
    - ⇒ The weight display shows the negative tare weight and the symbol **NET** appears.
  - 2 Place the full container on the weighing platform.
    - ⇒ The net weight is displayed.

### Tare preset with SICS command from a connected computer

- 1 Enter the known tare weight on the computer using the SICS command `TA_Value_Unit`.
  - ⇒ The weight display shows the negative tare weight and the symbol **NET** appears.
- 2 Place the full container on the weighing platform.
  - ⇒ The net weight is displayed.



## 2.7 Displaying information

Up to 9 different items can be configured in the menu for the **i** key. Depending on the configuration in the menu under `Terminal -> Device -> Keyboard -> Info key`, the following data can be assigned in any order, e.g.,

- Date & Time
- Weight values
- Identifications
- Article information
- Application parameters
- Device information
- User data
- Serial numbers and software versions
- Network information

On the second and third info page, system and contact information can be displayed.

- 1 Press **i**.  
⇒ The (first) info page is displayed.
- 2 Press **i** again.  
⇒ The next info screen is displayed.
- 3 To leave the info screens, press **C**.

**i** An info screen is displayed until **i** is pressed again or until **C** is pressed.

## 2.8 Printing results

If a printer or computer is connected, weighing results and other information can be printed out or transferred to a computer.

- Press .  
⇒ The defined data is printed out or transferred to the computer.

- i**
  - The printout content can be defined in the menu under `Communication -> COMx -> Define Templates`. The template has to be assigned to the printout in the `Application menu`.
  - If in the `Application menu` `Memory mode` is set to `Alibi` or `Transaction`, the weighing result is stored in the memory when pressing .

### Printing without pressing a key (clever print)

- In the menu `Application -> Clever print -> Activate` is set to `On`.
  - To initiate the next printout, the weight must drop below the set threshold.
- 1 Put the weighing sample on the load plate.  
⇒ When a stable weight value is reached, the result is printed automatically.
  - 2 Remove the weighing sample from the load plate and load the next weighing sample.  
⇒ When the weight value has dropped below the set threshold, the next stable weight value is printed automatically.

## Printout with consecutive number

The device offers the possibility to number the weighings on the printout.

- In the selected template `Consecutive number` is assigned to a line.
- To define a start value, a soft key must be defined as `Consecutive number (#)` in the menu under `Terminal -> Device -> Keyboard -> Soft keys`.

```
Date      11/04/2014
Time      17:17:39
Gross     0.815 kg
Cons. no  10
```

- 1 To enter a start value for the consecutive number, press the soft key `#`

- 2 Enter the desired start number and confirm with `↵`.

⇒ The weighing results are printed out with a consecutive number, beginning at the entered start number.



- If no start value is entered, the consecutive number will start with 1.
- The consecutive number can be displayed in the auxiliary lines as well (`Application -> ... -> Auxiliary lines -> Consecutive number`)

## 2.9 Average (dynamic) weighing

With the average weighing function, it is possible to weigh moving weighing samples such as animals. If this function is activated, `🐾` is displayed in the info line. With average weighing, the scale calculates the mean value from weighing operations within a certain time interval.

### Start via soft key (factory setting)

- Weighing sample heavier than 9 scale divisions.
- 1 Place the weighing sample on the scale.
  - 2 Press the soft key `🐾` to start average weighing.
    - ⇒ During average weighing, stars appear in the display, and the average result will be displayed with the symbol `*`.
  - 3 Unload the scale to begin a new average weighing operation.





### With automatic start

- `Application -> Average -> Mode -> Auto` is selected in the menu.
  - Weighing sample heavier than 9 scale divisions.
- 1 Place the weighing sample on the scale.
    - ⇒ Average weighing starts automatically.
    - ⇒ During average weighing, stars appear in the display, and the average result will be displayed with the symbol `*`.
  - 2 Unload the scale to start a new average weighing operation.

## 2.10 Working with identifications

Weighing series can be assigned with 3 identification numbers ID1, ID2 and ID3 with up to 40 numeric characters that are also printed out in the protocols. If, for example, a customer number and a batch number are assigned, it can be clearly seen in the protocol which batch was weighed for which customer.

### Direct entry

- At least one of the soft keys ID1, ID2 or ID3 is activated in the menu under Terminal -> Device -> Keyboard -> Soft keys.
  - To display the identification in the auxiliary lines, ID1, ID2 or ID3 must be activated in the menu under Application -> ... -> Auxiliary lines for each application.
- 1 Press the desired soft key , , .
    - ⇒ The ID entered last is displayed.
  - 2 Enter the ID and confirm with .
    - ⇒ The entered ID is assigned to the following weighings until the ID is changed.

### Barcode use (for one identification only)

- ID1, ID2 or ID3 is selected as destination for external input in the menu under Communication - COMx -> External input -> Destination.
  - To display the identification in the auxiliary line, ID1, ID2 or ID3 has to be activated in the menu under Application -> ... -> Auxiliary lines for each application.
- Scan the ID.
    - ⇒ The ID is assigned to the following weighings until a new ID is scanned.

### Using SICS command set (up to three identifications)

- To display the identification in the auxiliary line, ID1, ID2 or ID3 has to be activated in the menu under Application -> ... -> Auxiliary lines for each application.
- Send the ID command (I12, I13 or I14) from a PC.
    - ⇒ The ID is assigned to the following weighings until a new ID is sent.

 In the Terminal menu a designation can be given to the identification keys ID1, ID2 and ID3 which is displayed as soft key. So you clearly see which information is asked, e.g., Batch instead of ID2.

## 2.11 Working in a higher resolution

The weight value can be displayed in a higher resolution continuously or when called.

- Soft key x10 Display is activated in the Terminal menu.
- Press soft key .
    - ⇒ The weight value is displayed in at least 10x higher resolution and is marked with the symbol **\***.
    - ⇒ The higher resolution is displayed for 3 seconds.

 With non-approved weighing platforms, the weight value in a higher resolution can permanently be displayed in the Auxiliary line.

## 2.12 Switching scales

- At least two scales are connected to the weighing terminal.
- The soft key `Switch scale` is activated in the `Terminal` menu.
- Press the soft key  to switch to the next scale.
  - ⇒ The current active scale is displayed in the symbol and info line on the top edge of the display. In the soft key symbol, the number has changed.

## 2.13 Working with a prompt

### 2.13.1 Prompt overview

The device offers prompts for frequently used workflows. You can select either from the six predefined prompts or create your own prompt. The weighing terminal will then lead you from step to step.

In the `Application` menu the following prompts can be activated:

- `Tare/Sample` – counting with first taring and then determining the average piece weight
- `Sample/Tare` – counting with first determining the average piece weight and then taring
- `Hands free` – counting without pressing any key
- `Multi tare` – taring several containers with the same tare weight
- `Additive tare` – adding different tare values
- `Take away` – checkweighing out of a container



- During prompting, no other soft keys are available.
- To start a prompt, at least one of the soft keys `Prompt 1`, `Prompt 2`, `Prompt 3` must be activated in the `Terminal` menu.
- In the `Application` menu, these soft keys can be denominated according to your specific task.

### 2.13.2 Tare/Sample

This prompt will guide you through piece counting with first taring and then determining the average piece weight.



- 1 Check the current reference size which is indicated on the soft key  (Ref N var).
- 2 If necessary, change the reference size, see Counting section.
- 3 Press the prompt soft key.
  - ⇒ In the soft key line the instructions for the first step are displayed.
- 4 Load the tare weight and confirm with the indicated soft key.
  - ⇒ In the soft key line the instructions for the next step are displayed.
- 5 Load the reference parts and confirm with the indicated soft key.
  - ⇒ The display unit changes to PCS and the soft key line changes.
- 6 Load the weighing samples and read the number of pieces.
- 7 To restart counting with a new reference, press the indicated soft key.
  - ⇒ **Cleared** is displayed briefly before the first prompt is displayed again.
- 8 Repeat steps 4 to 7 for other references.
- 9 To leave piece counting, press **C**.
  - ⇒ **Cleared** is displayed briefly.



If a printer is connected, each individual result can be printed out by pressing .

### 2.13.3 Sample/Tare

This prompt will guide you through piece counting with first determining the average piece weight and then taring.

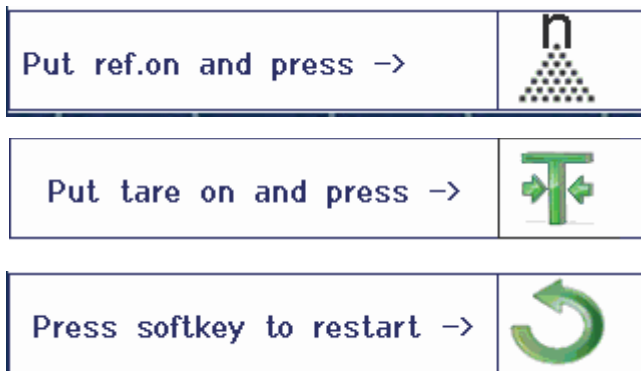

- 1 Check the current reference size which is indicated on the soft key  (Ref n var).
- 2 If necessary, change the reference size, see Counting section.
- 3 Press the prompt soft key.
  - ⇒ In the soft key line the instructions for the first step are displayed.
- 4 Load the reference parts and confirm with the indicated soft key.
  - ⇒ The display unit changes to PCS and the soft key line changes.
- 5 Load the tare weight and confirm with the indicated soft key.
  - ⇒ In the soft key line the instructions for the next step are displayed.
- 6 Load the weighing samples and read the number of pieces.
- 7 To restart counting with a new reference, press the indicated soft key.
  - ⇒ **Cleared** is displayed briefly before the first prompt is displayed again.
- 8 Repeat steps 4 to 7 for other references.
- 9 To leave piece counting, press **C**.
  - ⇒ **Cleared** is displayed briefly.



If a printer is connected, each individual result can be printed out by pressing .

## 2.13.4 Hands free

This prompt will guide you through piece counting without pressing a key.

Put weight on and wait for auto tare

Load wt. and wait for  
autom. APW determination

Press softkey to restart →



- 1 Press the prompt soft key.
  - ⇒ In the soft key line the instructions for the first step are displayed.
- 2 Load the tare weight.
  - ⇒ When the weight is stable, an automatic taring is carried out.
  - ⇒ In the soft key line the instructions for the next step are displayed.
- 3 Load the indicated number of reference parts.
  - ⇒ The average piece weight is determined automatically.
  - ⇒ The weight unit changes to PCS and the soft key line changes.
- 4 Load the weighing samples and read the number of pieces.

### Restarting piece counting



- To restart counting with a new reference, press the indicated soft key.
  - ⇒ **Cleared** is displayed briefly before the first prompt is displayed again.

### Leaving piece counting

- To leave piece counting, press **C**.
  - ⇒ **Cleared** is displayed briefly.

### 2.13.5 Multi tare

This prompt will guide you through taring a bundle of containers with the same known tare weight.

- 1 Press the prompt soft key.
  - ⇒ The number of containers (n) is highlighted.
- 2 Enter the number of containers and confirm entry with the soft key .
- 3 Enter the known tare weight of a single container and confirm entry with the soft key .
- 4 Weigh the bundle.
  - ⇒ The net weight of the bundle is displayed without extra taring.
- 5 To leave prompting, press **C**.
  - ⇒ **Cleared** is displayed briefly.





Multi tare definition	
Enter number of containers:	123 
n:	0
Enter value for each container:	
PT:	0 kg





### 2.13.6 Additive tare

This prompt will guide you through taring e.g., a pallet with containers on it with known tare weights.

- 1 Press the prompt soft key.  
⇒ A table for tare weights is displayed.
- 2 Enter the tare weights and confirm each tare weight with .  
⇒ Each confirmation creates a new tare record.
- 3 When all tare weights are entered, press soft key  to finish the entry.  
⇒ The total of all tare weights is displayed as pretare value indicated with PT.
- 4 Weigh the pallets.  
⇒ The net weight of the pallet is displayed without extra taring.
- 5 To leave prompting, press .  
⇒ **Cleared** is displayed briefly.

Additive tare		
#	Tare	Unit name
1	0.55	kg
2	1.20	kg
3	3.50	kg
4	0.85	kg

#### Soft key functions

(Soft) key	Meaning
^ / v	selecting a tare weight
	editing an existing tare weight
	creating a new tare weight
	deleting the selected tare weight
<b>C</b>	deleting all tare weights



### 2.13.7 Take away

This prompt will guide you through weighing the same items into a container or weighing out of a container without pressing a key between the actions.



- 1 Press the prompt soft key.
    - ⇒ The screen to enter target values is displayed.
  - 2 Enter target values as described in the Checkweighing section.
    - For weighing in, enter a positive target value. For weighing, out enter a negative target value.
    - ⇒ **New target set!** is displayed briefly.
  - 3 For weighing in, place the empty container on the scale.
    - For weighing out, place the full container on the scale.
  - 4 Press →**T**← to tare the container.
  - 5 For weighing in, place the checkweighing material into the container.
    - For weighing out, remove the checkweighing material from the container.
    - ⇒ If the applied/removed weight or the applied/removed amount is within the tolerance values, taring is carried out automatically.
    - The next item can be weighed in/removed.
  - 6 To leave prompting, press **C**.
    - ⇒ **Cleared** is displayed briefly.
- i**
- When using an item which is too light or too heavy, taring must be carried out automatically.
  - Select the `Auto print` feature to generate an automatic printout when the weight is within or outside of tolerances.

## 2.14 Memory log files

### 2.14.1 Calling up memory log file





 Only weighing results confirmed with  are stored in the memory log file.

#### Overview

- Memory mode is set to Alibi or Transaction under Application -> Memory.
- Press the soft key  or select Memory in the Quick Select menu with the cursor keys  $\wedge$  /  $\vee$  and confirm with .
  - ⇒ The Alibi records of the last weighing operations are displayed.

MEMORY					
#	Date & Time	Gross	Tare	Net	
000027	14/09/11 11:38:13	50.00 kg	60.00 kg	-9.20 kg	
000028	14/09/11 11:50:50	15.00 kg	0.00 kg	15.00 kg	
000029	14/09/11 11:58:16	15.00 kg	0.00 kg	15.00 kg	
000030	14/09/11 11:58:54	30.00 kg	0.00 kg	30.00 kg	
000031	14/09/11 13:30:43	0.00 kg	0.00 kg	0.00 kg	
000032	14/09/11 13:32:42	60.00 kg	0.00 kg	60.00 kg	
000033	14/09/11 13:33:57	60.00 kg	0.00 kg	60.00 kg	
000034	14/09/11 13:53:52	0.00 kg	0.00 kg	0.00 kg	
000035	14/09/11 14:14:33	60.00 kg	0.00 kg	60.00 kg	
000036	14/09/11 14:48:54	60.00 kg	0.00 kg	60.00 kg	

#### Soft key functions

Soft key	Meaning
	Cancelling
	Searching the Alibi memory
	Viewing selected Alibi record in detail
	Printing Alibi records
	To the last Alibi record

 Searching is possible by all data fields, except the Custom field.

## 2.14.2 Searching and printing memory records

For searching a memory record the device offers 3 search fields with individual search criterions each, e.g., data, weight values, article info. For each search field the desired range can be specified.

- 1 In the alibi overview press the soft key.  
⇒ The search window opens.
- 2 Select item for **Search field 1**.
- 3 Use the cursor key  $\nabla$  to proceed to the corresponding **From** field.
- 4 Enter the start value for the search field.
- 5 Use the cursor key  $\nabla$  to proceed to the corresponding **To** field.
- 6 Enter the end value for the search field.
- 7 Use the cursor key  $\nabla$  to proceed to the next search field.
- 8 Repeat steps 2 to 7 for **Search field 2** and **Search field 3**, if desired.
- 9 Start the search with the soft key.  
⇒ The matching alibi records are displayed.
- 10 To print the search result, press the soft key.

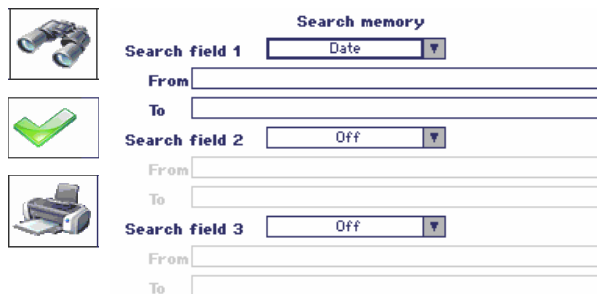

**Search memory**

**Search field 1**  ▾

**From**

**To**

**Search field 2**  ▾

**From**

**To**

**Search field 3**  ▾

**From**

**To**

## 2.14.3 Memory backup with USB Host

If a USB Host interface is installed you are able to download your memory data to a USB stick. The data is stored as .csv file which can easily be opened in Microsoft Excel for any kind of analysis.

- 1 In the alibi overview press the soft key .
- 2 Enter the search parameters as described in Searching and printing memory records [▶ 44].
- 3 Make sure that a USB stick is connected to the USB Host interface.
- 4 Press the soft key (**USB**).  
⇒ A window opens to edit the backup file.
- 5 Enter the file name and delimiter ( , or ; or :).
- 6 Press the soft key (**USB**) again.  
⇒ The memory data is downloaded to the USB stick.  
⇒ **Backup is in progress xx%** is displayed.
- 7 When the backup is finished, disconnect the USB stick and copy the data to your PC.

## 2.15 Cleaning



### **⚠ WARNING**

#### **Risk of electric shock**

- a) Before cleaning, unplug the power plug in order to disconnect the terminal from the power supply.
- b) Cover open connectors with protective caps.

#### **Cleaning of the ICS685 (dry environments)**

- Clean the optional protective cover separately. The protective cover is dishwasher-safe.
- Take off the load plate and remove any dirt and foreign substances which may have collected underneath. Do not use any hard objects to prevent scratching the surface.
- Do not disassemble the weighing device.
- Remove any remaining detergent with a wet cloth.
- Observe all existing regulations on cleaning intervals and permissible cleaning agents.
- In case of a windshield, we recommend to clean it with a glass cleaner each day of usage in order to prolong the durability.

#### **Cleaning of the ICS689 (wet environments)**

These devices are designed to be used in a wet environment. Depending on the environment and the cleaning procedures, we suggest appropriate weighing platforms with different types of load cells. The following table provides a detailed overview of recommended environments and suitable cleaning procedures.

	<b>Terminal</b>	<b>Weighing platform</b>
	<b>ICS689</b>	<b>Hermetically sealed stainless steel load cell</b>
IP rating	IP68/IP69k	IP68/IP69k
<b>Environment</b>		
Short time wet (30 min / day)	x	x
Part time wet (120 min/day)	x	x
Permanently wet	x	x
<b>Cleaning procedure</b>		
Wet wipe down	x	x
Light hose down < 5 l/min, 20 kPa	x	x
Light wash down < 12.5 l/min, 30 kPa	x	x
Heavy wash down, high pressure water and steam jet up to 10000 kPa	x	x
<b>Cleaning detergents</b>		
Mild detergents	x	x
Other detergents in accordance with the manufacturer's specifications and instructions	x	x

- Clean the optional protective cover separately. The protective cover is dishwasher-safe.
- Replace the protective cover regularly.
- Take off the load plate and remove any dirt and foreign substances which may have collected underneath. Do not use any hard objects to prevent scratching the surface.
- Do not disassemble the weighing device.
- Remove any remaining detergent by rinsing with clear water.
- To prolong the lifetime of the load cell, dry it with a soft lint-free cloth immediately after cleaning.
- Observe all existing regulations on cleaning intervals and permissible cleaning agents.

### **Cleaning of other weighing platforms not described in this user manual**

- Make sure to observe the cleaning instructions for the connected weighing platform. The weighing platform may not be designed for the environments and cleaning procedures described above!

## **2.16 Verification test**

The weighing instrument is verified if:

- the accuracy class is displayed in the metrological line,
- the approval readability is shown with "e = readability",
- it bears an official verification mark, e.g., the green M sticker (OIML),
- the validity is not expired.

The weighing instrument is also verified if:

- the metrological line shows "Approved scale",
- labels with the metrological data are placed near the weight display,
- the securing seal is not tampered with,
- it bears an official verification mark, e.g., the green M sticker (OIML),
- the validity is not expired.

**i** The period of validity is country-specific. It is in the responsibility of the owner to renew verification in due time.





### **Strain gauge weighing platforms**

Strain gauge weighing platforms use a Geo Code to compensate gravitational influence. The manufacturer of the weighing instrument uses a defined Geo Code value for verification.



- 1 Check if the Geo Code in the instrument corresponds with the Geo Code value defined for your location.
  - ⇒ The Geo Code value is displayed when you switch on the instrument.
  - ⇒ The Geo Code value for your location is shown in the Appendix.
- 2 Call the **METTLER TOLEDO** service technician if the Geo Code values do not match.

## 3 Counting





### 3.1 Counting parts into a container

- The soft keys *Ref N var* () and/or *Ref N fix* () are activated in the menu under *Terminal -> Device -> Keyboard -> Soft keys* (if not shown by default).
- 1 Place the empty container on the scale and press **→T←**.  
⇒ The container is tared, the zero display and the symbol **NET** appear.
  - 2 Place the number of reference parts on the scale as indicated on the soft key  or  and press the corresponding soft key.  
⇒ The scale determines the average piece weight and then shows the number of reference pieces.
  - 3 Add more parts to the container until the required number of pieces is reached.
  - 4 When piece counting is completed, press **C** to clear the reference.  
⇒ The scale is ready for the next weighing or counting operation.







- The average piece weight remains saved until **C** is pressed or a new average piece weight is determined.
- With  or soft key  (Weight count) you can switch between the number of pieces and the weighing units preset.
- The average piece weight (APW), for example, the weight of an individual reference unit, can be displayed on the info page or in the auxiliary line.
- If *Auto clear APW* is set to *On* in the menu under *Application -> Counting*, the average piece weight is automatically cleared after each counting operation.
- The achieved counting accuracy can be displayed in the auxiliary lines under *Application -> Counting -> Auxiliary lines*.

### 3.2 Counting parts out of a container



- The soft keys *Ref N var* () and/or *Ref N fix* () are activated in the menu under *Terminal -> Device -> Keyboard -> Soft keys* (if not shown by default).
- 1 Place the full container on the scale and press **→T←**.  
⇒ The container is tared, the zero display and the symbol **NET** appear.
  - 2 Remove the number of reference parts out of the container as indicated on the soft key  or  and press the corresponding soft key.  
⇒ The scale determines the average piece weight and then shows the number of reference pieces removed, together with a minus sign.
  - 3 Remove more parts out of the container until the required number of pieces is reached.
  - 4 When piece counting is completed, press **C** to clear the reference.  
⇒ The scale is ready for the next weighing or counting operation.

### 3.3 Determining the parts in a full container

When you know the tare weight of the container, the number of parts in the container can be determined.

- The soft keys Ref N var (  ) and/or Ref N fix (  ) are activated in the menu under Terminal -> Device -> Keyboard -> Soft keys (if not shown by default).
- 1 Place the number of reference parts on the scale as indicated on the soft key  or  and press the corresponding soft key.
    - ⇒ The scale determines the average piece weight and then shows the number of reference pieces.
  - 2 Enter or scan with a barcode reader the known tare weight and press →T← to confirm.
    - ⇒ The weight display shows the negative tare weight and the symbol **NET** appears.
  - 3 Place the full container on the weighing platform.
    - ⇒ The number of pieces in the container is displayed.



### 3.4 Counting with a known average piece weight

- The soft key APW (Average Piece Weight,  ) is activated in the menu under Terminal -> Device -> Keyboard -> Soft keys (if not shown by default).
- Enter the known average piece weight and press the soft key  .
  - ⇒ The scale changes the unit to PCS.

The rest of the counting procedure is as described in Counting parts into a container [▶ 47].

### 3.5 Changing reference quantity

#### 3.5.1 Free reference quantity



- The soft key Ref N var (  ) is activated in the menu under Terminal -> Device -> Keyboard -> Soft keys.
  - In the Application -> Counting menu, Fixed ref. size is set to Off.
- 1 Place any number of reference parts on the scale.
  - 2 Enter the number of reference parts and press the soft key  .
    - ⇒ The scale determines the average piece weight and then shows the number of pieces. In the soft key  the new number of reference parts is indicated.

The rest of the counting procedure is as described in Counting parts into a container [▶ 47].



### 3.5.2 Selecting reference quantity out of a set



With soft key  the following set of reference quantities is available: 5, 10, 20, 50, 100.

- The soft key Ref N fix () is activated in the menu under Terminal -> Device -> Keyboard -> Soft keys.
  - 1 Place the desired number of reference parts (5, 10, 20, 50, 100) on the scale.
  - 2 Press and hold the soft key  until the soft key line changes.
  - 3 Press the soft key for the desired number of reference parts.
    - ⇒ The scale determines the average piece weight and then shows the number of pieces.
    - ⇒ In the soft key  the new number of reference parts is indicated.

The rest of the counting procedure is as described in Counting parts into a container [▶ 47].

### 3.6 Counting with reference weight check

The reference weight check ensures that the reference weight is high enough to lead to a good counting result.

- At least one of the soft keys Ref N var () , Ref N fix () or APW () is activated in the menu under Terminal -> Device -> Keyboard -> Soft keys.
- Ref. weight check is set to On under Application -> Counting.
  - 1 Determine the average piece weight as described in "Counting parts into a container [▶ 47]"
    - ⇒ If the average piece weight is not sufficient, **Add x PCS** appears.
  - 2 Add the displayed number of pieces.
    - ⇒ The average piece weight is determined again with the larger reference quantity.





The rest of the counting procedure is as described in "Counting parts into a container [▶ 47]".

**i** The tolerance for the reference weight check can be modified in the menu under Application -> Counting -> Ref. weight -> Ref. weight check.

## 3.7 Reference optimization

### 3.7.1 Automatic reference optimization





The greater the reference quantity, the more accurately the scale determines the number of pieces.

- The soft keys **Ref N var** () and/or **Ref N fix** () are activated in the menu under **Terminal -> Device -> Keyboard -> Soft keys**.
  - In the **Application -> Counting** menu, APW optimization is set to **Auto**, the symbol  appears in the display.
- 1 Place the indicated number of reference parts on the scale and press the soft key  or .
  - 2 Place additional reference parts on the scale. The maximum for the additional reference parts cannot be larger than the original sample.
    - ⇒ The scale automatically optimizes the average piece weight with the larger number of reference parts.

The rest of the counting procedure is as described in **Counting parts into a container** [▶ 47].

### 3.7.2 Manual reference optimization

The greater the reference quantity, the more accurately the scale determines the number of pieces.



- The soft keys **Ref N var** () and/or **Ref N fix** () are activated in the menu under **Terminal -> Device -> Keyboard -> Soft keys**.
  - In the **Application -> Counting** menu, APW optimization is set to **Soft key**.
  - In the **Terminal -> Device -> Keyboard -> Soft keys** menu, the soft key **APW optimization** is activated.
- 1 Place the indicated number of reference parts on the scale and press the soft key  or .
  - 2 Place additional reference parts on the scale and press soft key .
    - ⇒ The scale automatically optimizes the average piece weight with the larger number of reference parts.

The rest of the counting procedure is as described in **Counting parts into a container** [▶ 47].

## 3.8 Counting with automatic reference determination

- In the **Application -> Counting** menu, **Autosampling** is set to **On**.
- Place the indicated number of reference parts on the scale.
  - ⇒ The scale automatically determines the average piece weight and then shows the quantity.

The rest of the counting procedure is as described in **Counting parts into a container** [▶ 47].

-  Pressing the soft key  (**Ref n VAR**) or  (**Ref n FIX**), the last average piece weight is cleared and the current weight is set as the new reference weight.

### 3.9 Counting with custom unit

The device offers the option to derive other physical variables from the weight of the sample, e.g., length, area, volume.



Unit and format of the physical variable can be defined in the `Application -> Counting` menu.

#### Prerequisite

In the `Application -> Counting` menu the following settings are made:

- `Unit type` is set to `Custom unit`
- For `Unit name` the desired unit is entered, e.g., m, qm, l, \$, Euro
- For `Unit format` the desired resolution is entered, e.g., 0.02 to count coins of 2 Cents and show the result in Euro

#### Weighing reference quantity

- Place the indicated reference quantity on the scale and press soft key  (Ref n FIX) or  (Ref n VAR).  
⇒ The scale determines the reference weight and then shows value and unit of the physical variable.

The rest of the measuring procedure is as described earlier.

#### Entering the known weight of the unit

- Enter the known weight of the unit and press soft key .  
⇒ The scale determines the reference weight and then shows value and unit of the physical variable.

The rest of the measuring procedure is as described earlier.

## 3.10 Counting with reference and bulk scale





### 3.10.1 Weighing systems with two or more scales

ICS685 / ICS689 can handle a weighing system with up to 4 scales.

There are two possibilities for counting with a scale system:



- Counting with **reference scale** and **bulk scale**:  
e.g., a high precision scale for determining the reference and a floor scale for counting large quantities.
- Counting with **auxiliary scales**:  
e.g., a high precision scale for counting small parts and a floor scale for counting bigger parts.

### 3.10.2 Counting with reference and bulk scale

- At least one of the soft keys Ref N var () , Ref N fix () or APW () is activated under Terminal -> Device -> Keyboard -> Soft keys.
  - In the Application -> Counting -> Counting system menu, one scale is configured as Reference scale for determining the average piece weight and the other scale is configured as Bulk scale for counting large numbers of pieces.
- 1 Place the indicated number of reference parts on the **reference scale** and press the soft key  or .  
⇒ After determining the average piece weight the scale is automatically switched to the bulk scale.
  - 2 Place the empty container on the bulk scale and press →T←.  
⇒ The container is tared and the zero display appears.
  - 3 Add the parts to the container until the required number of pieces is reached.

 Depending on the setting for Total count under Application -> Counting -> Counting system, the bulk scale will show either the number of pieces on the bulk scale only or the sum of pieces on both reference and bulk scale.

### 3.10.3 Counting with auxiliary scales

- At least one of the soft keys Ref N var () , Ref N fix () or APW () is activated in the menu under Terminal -> Device -> Keyboard -> Soft keys.
  - In the Application -> Counting -> Counting system menu, at least one scale of the system is configured as Auxiliary scale.
  - In the Terminal -> Device -> Keyboard -> Soft keys menu, the soft key Switch scale is activated.
- 1 Make sure that the selected scale is suitable for the product to be counted.
  - 2 Carry out counting as described in Counting parts into a container [▶ 47].

 When changing the product to be counted, always check which of the auxiliary scales is the most suitable. If necessary, change the scale.

## 4 Over/Under Checkweighing and Filling

### 4.1 Overview

The devices offer Over/Under Checkweighing and Filling functions. The respective settings in the menu are described in the `Application` menu section.

The correspondingly colored background lighting allows rapid detection of the status "too light" (factory setting: red), "good" (factory setting: green) and "too heavy" (factory setting: yellow). The colors can be modified in the menu.

#### Over/Under Checkweighing

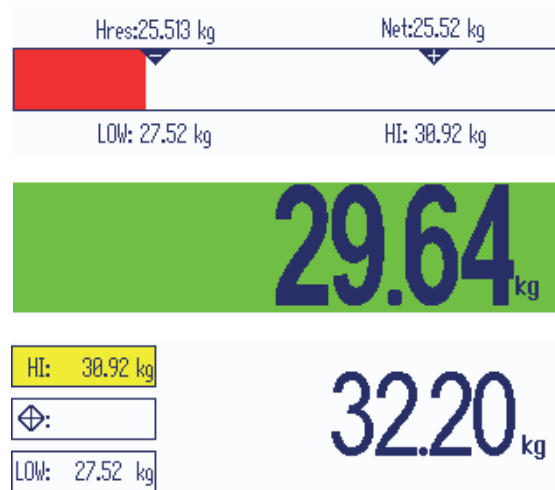

#### Filling

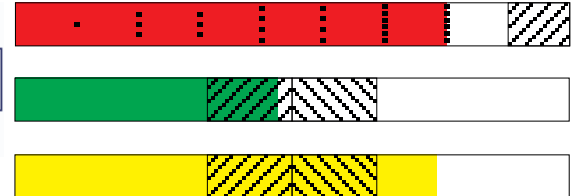





#### Tolerance types

Different entries are required at the beginning of Over/Under Checkweighing / Checkcounting / Filling, depending on the tolerance type setting.

- Absolute** A low and a high weight value must be entered. These weights and all weights within this range are treated as being within tolerance.
- Relative** Target weight (Target) as well as lower tolerance (Tol-) and upper tolerance (Tol+) have to be specified. The tolerances are displayed as relative deviations from the target weight.
- Percent** Target weight (Target) as well as lower tolerance (Tol-) and upper tolerance (Tol+) have to be specified. At Over/Under Checkweighing / Filling the weight value is represented as a percentage of the target weight. The target weight value is 100 % or 0 % at Over/Under Checkweighing to zero.

## 4.2 Specifying target values for Over/Under Checkweighing or Filling







The following section describes the course of Over/Under Checkweighing / Filling in the factory setting.

- 1 Press the soft key  for Over/Under Checkweighing or the soft key  for Filling.
  - ⇒ The current Over/Under Checkweighing / Filling parameters are displayed.
- 2 Check the tolerance type: Press the soft key  to change the tolerance type and the cursor key  to proceed to the first weight.
  - ⇒ With a tolerance type selected in the menu, this step does not appear.
- 3 Load the requested weight or enter the weight value and confirm with the soft key .
  - ⇒ The next weight is highlighted.
- 4 Repeat step 3 until **New target set** is displayed.
  - ⇒ The colored Over/Under Checkweighing / Filling display appears, the scale is ready for Over/Under Checkweighing or Filling.



- If tolerance default values have been set in the menu, only the target has to be specified with tolerance types "Relative" and "Percent".
- The upper tolerance value has to be greater than or equal to the lower one (High  $\geq$  Low) or, respectively, the target weight has to be greater than or equal to the lower tolerance value and smaller than or equal to the upper tolerance (Tol+  $\geq$  Target  $\geq$  Tol-).

## 4.3 Specifying target number of pieces for Over/Under Checkcounting

- The soft key **Over/Under** () is activated in the menu under **Terminal** -> **Device** -> **Keyboard** -> **Soft keys** (if not shown by default).
  - At least one of the counting soft keys **Ref N VAR** () , **Ref N FIX** () or **APW** () is activated in the **Terminal** menu.
- 1 To determine the average piece weight, apply the indicated number of reference parts as indicated on the soft key  or  and press the corresponding soft key.
    - ⇒ The number of reference parts is displayed.
  - 2 To determine the target number of pieces, proceed as described in the previous section.
    - ⇒ The display unit is PCS.



- For alternate procedures to determine the average piece weight, refer to the Counting section.
- When using the unit PCS, the tolerance type Percent is not available.
- Once the target values are specified, the Over/Under Checkcounting procedures are the same as the Over/Under Checkweighing procedures.

## 4.4 Over/Under Checkweighing or Checkcounting procedure

The devices facilitate Over/Under Checkweighing and Checkcounting through differently colored background lighting for the status "too light" (factory setting: red), "good" (factory setting: green) and "too heavy" (factory setting: yellow).

- 1 Specify the target values as described in the previous sections.
- 2 Place the Over/Under Checkweighing or Checkcounting material on the scale.
  - ⇒ Depending on the applied weight, the color of the background lighting changes. Weight information is displayed in accordance with the display setting and the Over/Under Checkweighing settings.

### Tolerance type "Absolute"



### Tolerance type "Relative"



### Tolerance type "Percent"



## 4.5 Filling procedure

The devices facilitate Filling through differently colored background lighting for the status "too light" (factory setting: red), "good" (factory setting: green) and "too heavy" (factory setting: yellow).

- 1 Specify the target values as described in the previous sections.
  - 2 Place the empty container on the scale and press **→T←**.
    - ⇒ The container is tared and the zero display appears.
  - 3 Fill in the weighing goods.
    - ⇒ Depending on the applied weight, the color of the background lighting changes. Weight information is displayed in accordance with the display setting and the Filling settings.
- As long as the weight is below the tolerance, a red bar is displayed.
  - When the weight approaches the good range, a second bar is displayed in which the tolerance range is spread. This is an aid to exactly fill in the target weight.
  - When the weight exceeds the tolerance range, the color changes to yellow.

### Too low



### Good

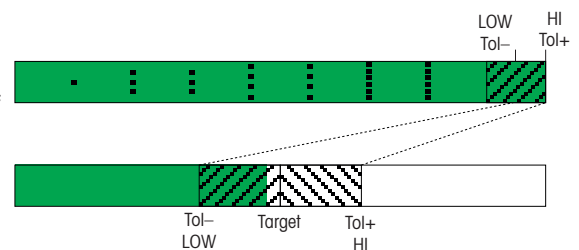

### Too high

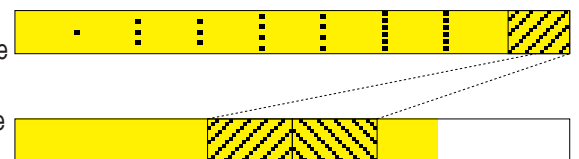

## 4.6 Over/Under Checkweighing / Filling during subtractive weighing (Take away)

Assistance through the colored background and the graphical weighing aid is also possible during subtractive weighing and subtractive counting.

- 1 Specify target values as described in the previous sections.
  - ⇒ The target value is indicated with a negative sign.
- 2 Place a full container on the weighing platform and tare it.
- 3 Remove as much from the weighing sample as required for the display to change to the status "good" (factory setting = green).
- 4 Tare the unit again.
  - ⇒ The scale is ready for the next removal.

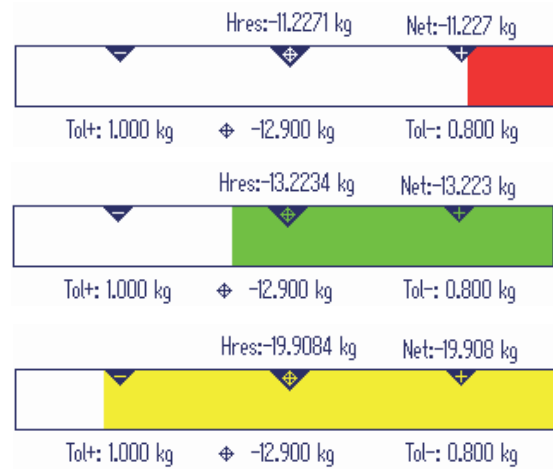

## 4.7 Over/Under Checkweighing / Filling with "Quick start"

If default values for the tolerances are used with tolerance types "Relative" or "Percent", Over/Under Checkweighing / Filling can be started by pressing just one key.

- The setting On is selected in the menu under Application -> Over/Under/Filling -> Default Values.
- Tolerance values are defined under Application -> Over/Under/Filling -> Default Values.
- The selected tolerance type matches the entered default values.
- Place the target weight or target amount on the scale and press the soft key for Over/Under Checkweighing or for Filling.
  - ⇒ The applied weight or the applied amount is stored as the target weight or target amount respectively. The display changes to the status "good" (factory setting = green). Over/Under Checkweighing / Filling is activated.



## 4.8 Over/Under Checkweighing to zero / Filling to zero

The weight value or the number of pieces can also be represented as the difference to the target weight.

- For Over/Under Checkweighing to zero / Filling to zero, tolerance types **Relative** or **Percent** are selected.
  - For Checkcounting to zero, tolerance type **Relative** is selected.
  - Display layout `Color mode` or `3-line mode` is selected in the `Terminal` menu.
- 1 Specify the target values as described in the previous sections.
  - 2 Press the soft key .
    - ⇒ The target is displayed with a minus sign.
  - 3 Place the Over/Under Checkweighing material on the scale.
    - ⇒ Depending on the applied weight or the applied amount the color of the background lighting changes.
    - ⇒ The display value is displayed in accordance with the tolerance type setting.
    - ⇒ The target value is 0 (kg or PCS) or 0.00 %.

\*  -2.00 kg

\*  0.01 kg

\*  0.99 kg

### Terminating Over/Under Checkweighing to zero / Filling to zero



- Press soft key  again.
  - ⇒ The symbol ↓0 in the info line disappears, the net weight is displayed.

## 4.9 Leaving Over/Under Checkweighing / Filling

### With clearing the Over/Under Checkweighing / Filling parameters

- Press **C**.
  - ⇒ **Cleared** appears in the display.
  - ⇒ The target values are cleared and the straight weighing display appears.
  - ⇒ The device operates in straight weighing mode.

### With keeping the Over/Under checkweighing / Filling parameters

- 1 Press the soft key .
  - ⇒ The straight weighing display appears, the Over/Under Checkweighing parameters are kept.
  - ⇒ The device operates in straight weighing mode.
- 2 To reactivate the Over/Under Checkweighing / Filling parameters, press the soft key  or .
  - ⇒ The most recently entered Over/Under Checkweighing / Filling parameters are displayed.

## 5 Classifying

### 5.1 Overview

The device offers Classifying functions with up to 12 weight classes. To make operation easier, an individual color is assigned to each weight class. The respective settings in the menu are described in the `Application` menu section.

Classifying cannot be combined with other applications like Counting, Over/Under Checkweighing/Filling or Totalizing.

#### Class definition

Each weight class is specified by its start value. The end value is automatically set 1 digit below the start value of the next class. Only for the last (highest) weight class an end value has to be specified.

The correspondingly colored background lighting allows rapid detection of the classes. The colors can be modified in the menu.

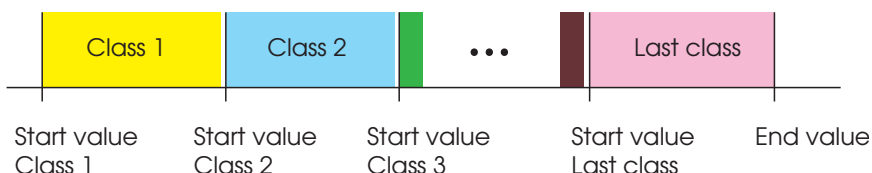

### 5.2 Specifying class definition values

- The Classifying soft key is activated in the `Terminal` menu.

1 Press the soft key .

⇒ A table to specify the class definitions is displayed.

2 Press the soft key  and enter the end value.

3 Confirm end value with .

⇒ The class definition table is displayed.

4 Press the soft key  and enter the start value of Class 1.

5 Confirm start value of Class 1 with .

⇒ The class definition table is displayed.

6 Repeat steps 4 and 5 until you have entered the start values of all your desired classes.

7 Confirm the class definition with .

⇒ The classifying display is active.

Classifying Definition		
Name	Item	Unit name
Class1	10	kg
Class2	20	kg
Class3	30	kg
Class4	40	kg
End Value	50.000000	kg



- If you do not specify the end value, the maximum capacity of the scale is used as end value.
- With `Class name` set to `Custom` in the `Application` menu, you are prompted to enter the class name prior to the value.
- Weighing in class limits is possible as well. Instead of entering the weight value, put the corresponding weight on the platform and confirm with .

### 5.3 Classifying procedure

- Class definition values specified as described in the previous section.
- Place the classifying material on the scale.

**i** When loading a database record with stored tare weight make sure to always use the same container as specified in the record.

#### Display for Classifying

With the default color setting and Class name set to Custom the following is displayed:



- i**
- The displays shown above are examples:
    - The class names are set when specifying the class definition.
    - The class colors are set in the menu.
  - The arrows indicate that there is a weight class below or above the current class.
  - To indicate the class info as shown in the examples, the item `Class info` must be selected for an auxiliary line, see `Application -> Classifying -> Auxiliary lines` menu.
  - If the weight is outside the range of the defined classes, **No class** is displayed.

### 5.4 Classifying during subtractive weighing

Assistance through the colored background is also possible during subtractive weighing.

#### Procedure

- 1 Specify class definition values as described in the previous sections.
  - ⇒ The class definition values must be entered with a negative sign.
- 2 Place a full container on the weighing platform and tare it.
- 3 Remove an item and read the result.
- 4 Tare the unit again.
  - ⇒ The scale is ready for the next removal.



## 5.5 Automatic printout of Classifying results

With Class print set to On in the Application -> Classifying menu, weighing results within the defined classed are printed out automatically together with the corresponding class information.



Class	Lobster grade D
Date	08/04/2015
Time	08:18:23
Gross	1.06 kg
Class info	5 (1.00 kg - 1.49 kg)

## 5.6 Terminating Classifying

### With clearing the Classifying parameters

- Press **C**.
  - ⇒ **Cleared** appears in the display.
  - ⇒ The class limits are cleared and the straight weighing display appears.
  - ⇒ The device operates in straight weighing mode.

### With keeping the Classifying parameters

- 1 Press the soft key .
  - ⇒ The straight weighing display appears, the class limits parameters are kept.
  - ⇒ The device operates in straight weighing mode.
- 2 To reactivate the Classifying parameters, press the soft key .
  - ⇒ The most recently entered Classifying parameters are displayed.

## 6 Totalization

### 6.1 Starting totalization

- Press the soft key .
- ⇒ The following soft keys for totalizing are displayed.

#### Page 1



Leave totalizing  
without clearing  
the sum



Add item to the  
sum

-

-



Add item to the  
negative sum

#### Page 2



Clear totalization  
memory



Statistics



Define totalizing  
target







Save totalizing  
target to the  
database



Undo totalization

### 6.2 Totalizing manually





#### Totalizing

- 1 Load the first sample and press the soft key .
  - ⇒ Total Net, Total Gross and number of items are displayed.
  - ⇒ If configured in the `Application` menu, the lot print for the first sample is issued.
- 2 Unload the scale.
- 3 Load the next sample and press the soft key  again.
  - ⇒ The totals are updated.
  - ⇒ If configured in the `Application` menu, the lot print for the next sample is issued.
- 4 Unload the scale.
- 5 Repeat steps 3 and 4 for further items.
- 6 To clear the totalization memory, press the soft key .
  - ⇒ A safety prompt is displayed.
- 7 Press the soft key  to clear the total.
  - or -
  - Press the soft key  to continue totalizing.



- Piece counting results and Over/Under Checkweighing results can be totalized the same way, but they cannot be mixed up in one totalizing action.
- When totalizing Checkweighing/Filling results which are too high or too low, a safety prompt is displayed.
- You can configure the auxiliary lines according to your totalization tasks under `Application` -> ... -> `Auxiliary lines`, e.g. Lot no. or Target.

### Totalizing in subtractive weighing

- 1 Load the full container and press →**T**←.  
⇒ The full container is tared.
- 2 Remove the first portion from the container and press the soft key   
⇒ The removed total is displayed.  
⇒ If configured in the `Application` menu, the lot print for the first sample is issued.
- 3 Press →**T**←.
- 4 Remove the next portion and press the soft key  again.  
⇒ The total is updated.  
⇒ If configured in the `Application` menu, the lot print for the next sample is issued.
- 5 Repeat steps 3 and 4 for further portions.
- 6 Press the soft key  to clear the total.  
– or –  
Press the soft key  to continue totalizing.



- Piece counting results and Over/Under Checkweighing results can be totalized the same way, but they cannot be mixed up in one totalizing action.
- When totalizing Checkweighing/Filling results which are too high or too low, a safety prompt is displayed.
- You can configure the auxiliary lines according to your totalization tasks under `Application`  
-> ... -> `Auxiliary lines`.

## 6.3 Automatic totalizing

The automatic mode facilitates the totalizing process. After putting the load on the scale, the weight value is added automatically.

- Auto+ or Auto- is selected under `Application -> Totalizing -> Mode`.

1 Load the first sample.

⇒ The total is displayed in the auxiliary lines.

⇒ If configured in the `Application` menu, the lot print for the first sample is issued.

2 Unload the scale.

3 Load the next sample.

⇒ The total is updated.

⇒ If configured in the `Application` menu, the lot print for the next sample is issued.

4 Unload the scale.

5 Repeat steps 3 and 4 for further items.

6 To clear the totalization memory, press the soft key .

⇒ A safety prompt is displayed.

7 Press the soft key  to clear the total

– or –

Press the soft key  to continue totalizing.





- Piece counting results, Over/Under Checkweighing results, Filling results and Classifying results can be totalized the same way.
- To avoid weighing a sample twice, the `Zero return` function can be enabled under `Application -> Totalizing`. A stable zero must be reached between two samples.





## 6.4 Totalizing to a target

The totalizing target can be defined as gross weight, net weight, number of items or number of pieces.

### Entering target values

- 1 Press the soft key .
  - ⇒ A window opens to specify the target.
- 2 Select the target type: Gross, Net or Lot (N).
- 3 Enter the target and confirm with the soft key .
  - ⇒ The message **New target set** appears briefly and then the weight display is shown.

### Totalizing to a target manually

- 1 Load the first item and press the soft key .
  - ⇒ The weight is added to the sum.
  - ⇒ If configured in the `Application` menu, the lot print for the first sample is issued.
- 2 Remove the item from the weighing platform.
- 3 Load the next item and press the soft key .
  - ⇒ If configured in the `Application` menu, the lot print for the next sample is issued.
- 4 Repeat steps 2 and 3 until **Totalization target exceeded** is displayed.
- 5 Confirm the message with the soft key .
- 6 To clear the totalization memory, press the soft key .
  - ⇒ The scale is ready for the next totalizing procedure.





- Target format PCS is available only if the current unit is PCS.
- The totalization target remains stored until a new target is set.
- Checkweighing, Filling or Classifying results can be totalized the same way.
- When in the `Application` menu `Clear at target` is set to `On`, the totalization memory is automatically cleared when the target is reached.
- When in the `Application` menu `Tare after sum` is set to `On`, you can leave the previous weighing good on the load plate.

## 6.5 Totalizing with leaving the totalized items on the scale

When in the `Application` menu `Tare after sum` is set to `On`, the totalized items can remain on the scale. With this setting it is not necessary to press the tare button after every weighing.



## 6.6 Statistical evaluation of the sum

- For statistical evaluation of the sum, statistics must first be activated.
  - 1 Press the soft key .
    - ⇒ **Activate statistics?** is displayed.
  - 2 Press the soft key .
    - ⇒ From now on all weighings are included in a statistical evaluation.



### Displaying statistics

- Press the soft key .
    - ⇒ The statistics of all totalized items since the last clearing of statistics is displayed.
- i**
- In the menu under *Application* -> *Statistics* you can configure which statistical information will be displayed.
  - Statistics can be called up from the Quick Select menu as well.



### Printing statistics

- Press the soft key .
  - ⇒ The statistics of all totalized items since the last clearing of statistics is printed or transferred to a computer.

### Deleting statistics

- 1 Press the soft key .
  - ⇒ A safety prompt is displayed.
- 2 Press the soft key  to delete the statistics.
  - ⇒ The statistic is cleared.

### Deactivating statistics

- 1 Press the soft key .
  - ⇒ A safety prompt is displayed.
- 2 Press the soft key  to deactivate statistics.
  - ⇒ From now on there is no statistical evaluation of the weighings.

## 6.7 Terminating totalizing

### Terminating totalizing with clearing the total



- Press **C**.
  - ⇒ The total is cleared and the straight weighing display appears.
  - ⇒ The device operates in straight weighing mode.

### Printouts

If configured in the Application menu, the following printouts are printed when clearing the total:

- Final printout with the totals
- Summary printout with the totals and all individual items, see printout example in the Appendix.

### Terminating totalizing with keeping the total

- Press the soft key .
  - ⇒ The straight weighing appears, the total is kept.
  - ⇒ The device operates in straight weighing mode.
- To continue totalizing, press the soft key .
  - ⇒ The last total is displayed.

## 7 Settings in the menu

### 7.1 Menu overview

In the menu, settings can be changed and functions can be activated. This enables adaptation to individual weighing requirements.

The menu consists of the following 5 main blocks containing various submenus on several levels which are described in the following sections.



- Scale
- Application
- Terminal
- Communication
- Maintenance

### 7.2 Operating the menu



#### 7.2.1 Calling up the menu and entering the password

The menu differentiates between 2 operating levels: Operator and Supervisor. The Supervisor level can be protected by a password. When the device is delivered, both levels are accessible without a password.

##### Operator menu

- 1 Press .
  - ⇒ The Quick Select menu opens, `Menu` is highlighted.
- 2 Press .
  - ⇒ `Enter code` is displayed.
- 3 Press  again (no password required).
  - ⇒ The menu item `Terminal` is displayed. Only parts of the submenu `Device` are accessible.

##### Supervisor menu



- 1 Press .
  - ⇒ The Quick Select menu opens, `Menu` is highlighted.
- 2 Press .
  - ⇒ `Enter code` is displayed.
- 3 Enter the password.
  - ⇒ The first menu item `Scale` is highlighted.



- When the device is first delivered, the supervisor password is set to 000. Set your individual password in the `Terminal` menu.
- If a password is not entered within a few seconds, the scale returns to the weighing mode.
- If a password has been issued for supervisor access to the menu and you have forgotten it, please contact the **METTLER TOLEDO** service.

##### Calling up the menu when user management is active

If user management is active, password entry is required when logging in.

- 1 Press .
  - ⇒ The Quick Select menu opens, `Menu` is highlighted.
- 2 Press .
  - ⇒ The menu start screen is displayed, depending on the user profile.

## 7.2.2 Display in the menu

### Menu tree

The menu tree is displayed like the file system in the Windows Explorer.

For navigating the menu tree use the cursor keys.



- ^ / Navigating up or down the menu tree
- ∨
- > Navigating to a deeper level of the menu tree until the selection window is displayed
- < Navigating to a higher level of the menu and closing submenus

```





+ Scale
+ Application
- Terminal
  - Device
    . Region
    . Sleep & Backlight
    . Serial number
  + Display
  - Keyboard
    . Hard keys
    . Soft keys
  + Info key
    . Beeper
    . External keyboard
  
```

### Selection window

For navigating the selection windows use the following keys:

- ^ / Navigating up or down the menu items
- ∨ Navigating up or down the settings of a menu item
-  Opening the menu item  
Confirming the setting of a menu item
- < Navigating to a higher level of the menu and closing submenus
-  Leaving the selection window

### Exiting the menu

- Press .
  - ⇒ **Save settings?** is displayed.
- Press the soft key .
  - ⇒ The menu changes are saved and the terminal returns to the weighing mode.
- or
- For further menu settings, press the soft key .
- or
- To discard changes and return to the weighing mode, press the soft key .

## 7.2.3 Selecting and setting parameters in the menu



### Example: Setting the chain tare function

- 1 Use cursor key > to enter the `Scale` menu.
- 2 Use cursor key > to enter the `Scale 1` menu.  
⇒ The first submenu `Identification` is highlighted.
- 3 Use cursor key √ to select (highlight) the `Tare` menu.
- 4 Use cursor key > to enter the `Tare` menu.  
⇒ The selection window is displayed.

```

- Scale
  - Scale 1
    . Identification
    . Linearization & Calibration
    . Display unit & Resolution
    . Zero
    . Tare
    . Restart
    . Filter
    . MinWeigh
    . Reset
+ Application
+ Terminal
+ Communication
  
```

The selection window shows the menu items with their current settings.

- 1 Use cursor key √ to select `Chain tare`.
- 2 Press  to open a popup menu with the `Chain tare` menu.
- 3 Use cursor keys ^ / √ > to select the desired setting.
- 4 Press  to confirm the setting.
- 5 Press the soft key < to leave the selection window and return to the menu tree.

Tare		Scale 1
<b>Auto tare</b>	<input type="text" value="Off"/>	
Auto tare threshold	<input type="text" value="5"/> d	
<b>Auto clear tare</b>	<input type="text" value="Off"/>	
Clear threshold weight	<input type="text" value="5"/> d	
<b>Chain tare</b>	<input type="text" value="On"/>	
Pushbutton tare	<input type="text" value="On"/>	



- Menu items in light gray are not available for the current setting or profile.
- Should the settings of a menu not be displayed on one page, (e.g., all the soft keys), use cursor key √ to proceed to further items.

## 7.3 Scale menu block

### 7.3.1 Scale menu overview

The `Scale` menu depends on the connected load cell which is indicated on the type label.

Type	Load cell	Scale menu
<b>ICS685g / ICS689g</b>	Analog	Analog scale menu [▶ 71]
<b>ICS685i / ICS689i</b>	IDNet	IDNet scale menu block [▶ 77]
<b>ICS685s / ICS689s</b>	SICSpro	Analog scale menu [▶ 71]
<b>ICS685k-.../f</b>	MonoBloc®	Analog scale menu [▶ 71]



- When entering the `Scale` menu block, an overview of the connected scales is displayed.
- After selecting a scale, the `Scale` menu is available.
- If the selected scale is a SICS scale, no further settings are available.

## 7.3.2 Scale menu block (Analog / SICSpro)







### Overview

Factory settings are printed in **bold** in the following overview.









Level 1	Level 2	Level 3	Level 4
Identification	Serial no. scale, Scale model, Scale location, Scale ID		
Linearization & Calibration	Linearization	3 point, <b>5 point</b>	
	Last calibration		
	Start up FACT (for <b>ICS685k-.../f</b> compact scales only)	<b>On</b> , Off	
	Auto print calib.	<b>On</b> , Off	
	Perform linearization		
	Perform calibration		
Disp. unit & res.	Display unit 1	g, <b>kg</b> , oz, lb, lb-oz, t	
	Display unit 2	<b>g</b> , kg, oz, lb, lb-oz, t	
	Disp. resolution		
	Unit roll	On, <b>Off</b>	
Zero	AZM	Off, <b>0.5d</b> , 1d, 2d, 5d, 10d	
Tare	Auto tare	On, <b>Off</b>	
	Chain tare	<b>On</b> , Off	
	Auto clear tare	On, <b>Off</b>	
Restart	On, Off		
Filter	Vibration	Low, <b>Medium</b> , High	
	Process	<b>Universal</b> , Dosing, Absolute	
	Stability	Fast, <b>Standard</b> , Precise	
MinWeigh	MinWeigh	On, <b>Off</b>	
	Display color	White, Yellow, <b>Red</b> , Green, Blue, Violet, Dark blue, Grey	
FACT (for <b>ICS685k-.../f</b> compact scales only)	Temperature	Off, 1K, 2K, 3K	
	Time	Time 1, Time 2, Time 3	
	Days	Monday ... Sunday	<b>Off</b> , On
Reset	Perform reset?		

### Description

Identification	Displaying/setting scale identification data
Serial no. scale	Displaying the serial number of the weighing platform
Scale model	Displaying the scale type, e.g., PBD555 Available for <b>METTLER TOLEDO</b> scales only
Scale location	Entering the scale location, e.g., floor and room
Scale ID	Entering the scale identification, e.g., inventory number
Notes	<ul style="list-style-type: none"> <li>Scale location and Scale ID can be displayed in the auxiliary or info lines or printed out.</li> <li>Scale location and Scale ID can consist of up to 40 alphanumeric characters.</li> </ul>

Linearization & Calibration	Linearization and calibration																		
Linearization	Select linearization method: 3 point or 5 point																		
Last calibration	Shows the date of the last calibration.																		
Start up FACT	When set to On, an internal calibration is performed every time the scale is switched on. It is recommended not to disable this setting if the scale will be moved to other locations.																		
Autoprint calib.	When set to On, a protocol is printed out automatically for each calibration process.																		
 <p>Perform linearization</p>	<ol style="list-style-type: none"> <li>1 Ensure that the weighing platform is empty.</li> <li>2 Press the soft key . <ul style="list-style-type: none"> <li>⇒ <b>Preload</b> is blinking.</li> </ul> </li> <li>3 If applicable, apply preload and confirm with . <ul style="list-style-type: none"> <li>⇒ <b>xx kg</b> is blinking.</li> </ul> </li> <li>4 Apply the displayed weight and confirm with . <ul style="list-style-type: none"> <li>⇒ The next linearization weight is blinking.</li> </ul> </li> <li>5 Repeat step 4 until the Calibration log screen is displayed.</li> <li>6 Press the soft key  to leave linearization. <ul style="list-style-type: none"> <li>– or –</li> <li>⇒ Press the soft key  to edit the linearization log (entering user name, weight name and comment).</li> </ul> </li> </ol> <div style="text-align: center; margin-top: 20px;"> <h3 style="color: blue;">Calibration passed</h3> <table border="1" style="background-color: #00FF00; width: 100%; border-collapse: collapse;"> <tbody> <tr> <td style="text-align: right;">Rec.No</td> <td>002</td> </tr> <tr> <td style="text-align: right;">Date</td> <td>12/11/2014</td> </tr> <tr> <td style="text-align: right;">Time</td> <td>13:02:23</td> </tr> <tr> <td style="text-align: right;">SNo. Scale</td> <td></td> </tr> <tr> <td style="text-align: right;">Scale Fw</td> <td>2.1.0</td> </tr> <tr> <td style="text-align: right;">Technician</td> <td>ABC</td> </tr> <tr> <td style="text-align: right;">Test weight</td> <td>0.060 kg</td> </tr> <tr> <td style="text-align: right;">Weight name</td> <td></td> </tr> <tr> <td style="text-align: right;">Comments</td> <td></td> </tr> </tbody> </table> </div>	Rec.No	002	Date	12/11/2014	Time	13:02:23	SNo. Scale		Scale Fw	2.1.0	Technician	ABC	Test weight	0.060 kg	Weight name		Comments	
Rec.No	002																		
Date	12/11/2014																		
Time	13:02:23																		
SNo. Scale																			
Scale Fw	2.1.0																		
Technician	ABC																		
Test weight	0.060 kg																		
Weight name																			
Comments																			



Linearization & Calibration	Linearization and calibration																		
<div data-bbox="347 165 497 266" style="border: 1px solid black; padding: 5px; text-align: center;">  </div> <p data-bbox="347 283 544 310">Perform calibration</p>	<p data-bbox="687 165 1417 257"><b>Important:</b> With <b>ICS685k-.../f</b> weighing terminals make sure that the scale has been switched on at least 15 minutes before performing linearization/calibration.</p> <ol data-bbox="687 278 1433 832" style="list-style-type: none"> <li>1 Unload scale.</li> <li>2 Press the soft key . <ul style="list-style-type: none"> <li>⇒ <b>Preload</b> is blinking.</li> </ul> </li> <li>3 If applicable, apply preload and confirm with . <ul style="list-style-type: none"> <li>⇒ <b>xx kg</b> is blinking.</li> <li>⇒ If necessary, the displayed calibration weight value can be changed using the displayed arrow soft keys.</li> </ul> </li> <li>4 Apply the displayed calibration weight and confirm with . <ul style="list-style-type: none"> <li>⇒ The Calibration log screen is displayed.</li> </ul> </li> <li>5 Press the soft key  to leave calibration</li> <li>6 Press the soft key  to leave linearization. <ul style="list-style-type: none"> <li>– or –</li> <li>⇒ Press the soft key  to edit the linearization log (entering user name, weight name and comment).</li> </ul> </li> </ol> <div data-bbox="687 846 1469 1264" style="background-color: #00ff00; padding: 10px; text-align: center;"> <h3 style="margin: 0;">Calibration passed</h3> <table style="margin: 0 auto; border-collapse: collapse;"> <tr><td style="padding: 2px;">Rec.No</td><td style="padding: 2px;">002</td></tr> <tr><td style="padding: 2px;">Date</td><td style="padding: 2px;">12/11/2014</td></tr> <tr><td style="padding: 2px;">Time</td><td style="padding: 2px;">13:02:23</td></tr> <tr><td style="padding: 2px;">SNo. Scale</td><td style="padding: 2px;"></td></tr> <tr><td style="padding: 2px;">Scale Fw</td><td style="padding: 2px;">2.1.0</td></tr> <tr><td style="padding: 2px;">Technician</td><td style="padding: 2px; background-color: #333; color: white;">ABC</td></tr> <tr><td style="padding: 2px;">Test weight</td><td style="padding: 2px;">0.060 kg</td></tr> <tr><td style="padding: 2px;">Weight name</td><td style="padding: 2px;"></td></tr> <tr><td style="padding: 2px;">Comments</td><td style="padding: 2px;"></td></tr> </table> </div>	Rec.No	002	Date	12/11/2014	Time	13:02:23	SNo. Scale		Scale Fw	2.1.0	Technician	ABC	Test weight	0.060 kg	Weight name		Comments	
Rec.No	002																		
Date	12/11/2014																		
Time	13:02:23																		
SNo. Scale																			
Scale Fw	2.1.0																		
Technician	ABC																		
Test weight	0.060 kg																		
Weight name																			
Comments																			
<p data-bbox="347 1283 405 1310">Notes</p>	<ul style="list-style-type: none"> <li>In order to achieve a particularly high precision, calibrate under full load.</li> <li>The calibration process can be aborted using .</li> <li>This menu item is not available for verified scales.</li> </ul>																		

Disp. unit & res.	Display units and resolution
Display unit 1	Selecting weighing unit 1
Display unit 2	Selecting weighing unit 2, different from unit 1
Display resolution	Selecting readability (resolution). The possible settings depend on the connected scale. When set to <i>Off</i> , only the default resolution of the weighing platform is available.
Unit roll	When set to <i>On</i> , the weight value can be displayed in all available units with  .
Notes	<ul style="list-style-type: none"> <li>In case of verified scales, individual sub-items of the <i>Display/Units &amp; Resolution</i> menu item may not be available or only to a limited extent, depending on the respective country.</li> <li>On dual-range/dual interval scales, resolutions marked with <b> &lt;-&gt;  1/2</b> are divided into 2 weighing ranges/intervals, e.g., 2 x 3000 d.</li> <li>On triple-range/multi interval scales, resolutions marked with <b> &lt;-&gt;  1/2/3</b> are divided into 3 weighing ranges/intervals, e.g., 3 x 3000 d.</li> </ul>

Zero	Automatic zero setting
<b>AZM</b>	<b>Automatic Zero Maintenance</b>
On/Off	Switching automatic zero maintenance on/off.
Off; 0.5 d; 1 d; 2 d; 5 d; 10 d	Selecting zeroing range in digits per second.
Note	On verified scales, this menu item does not appear.



Tare	Tare function
Auto tare	Switching on/off automatic taring <i>Auto tare = On</i> : When a load is placed on the scale and the gross weight exceeds 9 d, the weight is tared automatically.
Chain tare	Switching on/off chain tare <i>Chain tare = On</i> : It is possible to tare several times if, e.g., cardboard is placed between individual layers in a container.
Auto clear tare	Switching on/off automatic clearing of the tare weight <i>Auto clear tare = On</i> : When the load is removed and the weight drops below 9 d, the tare weight is cleared automatically.

Restart	Automatic saving of zero point and tare value
Restart	When set to <i>On</i> , the last zero point and the tare value are saved. After switching off/on or after a power interruption, the device continues to work with the saved zero point and tare value.

Filter	Filter settings
<b>Vibration</b>	<b>Adaptation to ambient conditions</b>
Low	Very steady and stable environment. The scale works very rapidly, but is very sensitive to external influences.
Medium	Normal environment. The scale operates at medium speed.
High	Unstable environment. The scale works more slowly, but is less sensitive to external influences.
<b>Process</b>	<b>Adaptation to the weighing process</b>
Universal	Universal setting for all weighing samples and normal weighing goods.
Dosing	Dispensing liquid or powdery weighing samples (only for certain weighing platforms, e.g., PBK9-series / PFK9-series).
Absolute	For solid bodies under extreme conditions, e.g., strong vibrations.
<b>Stability</b>	<b>Adjusting the stability detector</b>
	The slower the scale works, the greater the reproducibility of the weighing results.
Fast	The scale operates very fast.
Standard	The scale operates at medium speed.
Precise	The scale operates with the greatest possible reproducibility.

MinWeigh	MinWeigh function
MinWeigh	Switching MinWeigh function on/off When set to $\text{On}$ and if the weight on the scale drops below the stored minimum weight,  will appear in the symbols and info line and the display color will change.
Display color	Setting the display color for weight values below the stored minimum weight.
Note	Before you can use this function, the <b>METTLER TOLEDO</b> service technician has to determine and enter a minimum weight value.

FACT	Fully automatic calibration test (for ICS685k-.../f compact scales only)
<b>Temperature</b>	<b>Setting the temperature difference for automatic adjustment.</b>
Off	Switching off automatic adjustment in case of a temperature difference.
1K, 2K, 3K	Automatic adjustment in case of the selected temperature change.
<b>Time</b>	<b>Setting up to 3 times per day for automatic adjustment.</b>
Time 1, Time 2, Time 3	Entering the times for the automatic adjustment (hours, minutes in 24 h format). To deactivate Time 2 and Time 3, set them to 00:00:00.
<b>Days</b>	<b>Setting the days of the week for automatic adjustment.</b>
Monday ... Sunday	On all days which are set to $\text{On}$ , the automatic adjustment will be performed.
Note	FACT is executed under the following conditions: <ul style="list-style-type: none"> <li>No key has been pressed for 3 minutes.</li> <li>– or –</li> <li>The displayed weight value is smaller than 30 d and stable.</li> </ul>

Reset	Resetting the scale settings to factory settings
Perform reset?	<p>- Confirm with  to reset the scale menu settings.</p> <p><b>For ICS685k-.../f compact scales only</b></p> <ol style="list-style-type: none"> <li>1 Press <b>Reset</b> for 5 seconds. ⇒ <b>Reset User Calibration</b> is displayed.</li> <li>2 Confirm with  to reset the user calibration.</li> </ol>

### 7.3.3 IDNet scale menu block

#### Overview

Level 1	Level 2	Level 3
Display unit & Resolution	Display unit 2	<b>g</b> , kg, oz, lb, †
	Unit roll	On, <b>Off</b>
Zero	AZM	Off, <b>0.5d</b> , 1d, 2d, 5d, 10d
Tare	Auto tare	On, <b>Off</b>
	Auto clear tare	On, <b>Off</b> , 9 d
	Chain tare	<b>On</b> , Off
Restart	On, <b>Off</b>	
Filter	Vibration	Stable, <b>Normal</b> , Unstable
	Process	Finefill, <b>Universal</b> , Absolute
	Stability	ASD = 0, 1, <b>2</b> , 3, 4, 5
Update	The possible settings depend on the connected scale	
MinWeigh	Function	On, <b>Off</b>
	MinWeigh value	
	Display color	White, Yellow, <b>Red</b> , Green, Blue, Violet, Dark blue, Grey
Reset	Perform reset?	

#### Description

Identification	Displaying/setting scale identification data
Serial no. scale	Displaying the serial number of the weighing platform
Scale model	Displaying the scale type, e.g., PBD555 Available for <b>METTLER TOLEDO</b> scales only
Scale location	Entering the scale location, e.g., floor and room
Scale ID	Entering the scale identification, e.g., inventory number
Notes	<ul style="list-style-type: none"> <li>Scale location and Scale ID can be displayed in the auxiliary or info lines or printed out.</li> <li>Scale location and Scale ID can consist of up to 24 alphanumeric characters.</li> </ul>

Display unit & Resolution	Setting the weighing units
Unit 2	Selecting weighing unit 2, different from unit 1.
Unit roll	When set to <b>On</b> , the weight value can be displayed in all available units with  .
Notes	<ul style="list-style-type: none"> <li>In case of verified scales, individual sub-items of the <code>Display unit &amp; Resolution</code> menu item may not be available or only to a limited extent, depending on the respective country.</li> <li>On dual-range/dual interval scales, resolutions marked with <b>!&lt;-&gt;  1/2</b> are divided up into 2 weighing ranges/intervals, e.g., 2 x 3000 d.</li> <li>On triple-range/multi interval scales, resolutions marked with <b>!&lt;-&gt;  1/2/3</b> are divided up into 3 weighing ranges/intervals, e.g., 3 x 3000 d.</li> </ul>



<b>Zero</b>	<b>Automatic zero setting</b>
<b>AZM</b>	<b>Automatic Zero Maintenance</b>
On/Off	Switching automatic zero maintenance on/off.
0.5d, 1d, 2d, 5d, 10d	Selecting the threshold for automatic zero setting.
Notes	<ul style="list-style-type: none"> <li>• On verified scales, this menu item does not appear.</li> <li>• The effective range of the zero update mode can only be set by the <b>METTLER TOLEDO</b> service technician.</li> </ul>

<b>Tare</b>	<b>Tare function</b>
<b>Auto tare</b>	Switching on/off automatic taring.
On	When a load is placed on the scale and the gross weight exceeds 9 d, the weight is tared automatically.
Off	No automatic taring.
<b>Auto clear tare</b>	Configuring the automatic clearing of the tare weight.
On	The tare weight is automatically cleared if the gross weight is 0 or below zero.
Off	No automatic clearing of the tare weight.
9 d	The tare weight is automatically cleared if the gross weight is within +/- 9 display steps.
<b>Chain tare</b>	Switching on/off chain tare.
On	It is possible to tare several times if, e.g., cardboard is placed between individual layers in a container.
Off	Taring is only possible once.

<b>Restart</b>	<b>Automatic saving of zero point and tare value</b>
Restart	When set to <b>On</b> , the last zero point and the tare value are saved. After switching off/on or after a power interruption, the device continues to work with the saved zero point and tare value.

Filter	Filter settings
<b>Vibration</b>	<b>Adaptation to ambient conditions</b>
Low	Very steady and stable environment. The scale works very rapidly, but is very sensitive to external influences.
Medium	Normal environment. The scale operates at medium speed.
High	Unstable environment. The scale works more slowly, but is insensitive to external influences.
<b>Process</b>	<b>Adaptation to the weighing process</b>
Dosing	Dispensing of liquid or powdered weighing samples manually.
Universal	Universal setting for all weighing samples and normal weighing goods.
Absolute	No adaptation, to perform automated filling processes, e.g., with PLC.
<b>Stability</b>	<b>Adjusting the stability detector</b>
	The slower the scale works, the greater the reproducibility of the weighing results.
ASD = 0	Stability detector switched off. Only possible for non-verified scales.
ASD = 1	Rapid display, good reproducibility
...	...
ASD = 4	Slow display, excellent reproducibility

Update	Setting the display speed of the weight display
xx UPS	Selecting the number of updates per second (UPS).
Notes	<ul style="list-style-type: none"> <li>This menu is only displayed if the Update function is supported by the connected scale.</li> <li>The possible settings depend on the connected scale.</li> </ul>

MinWeigh	MinWeigh function
MinWeigh	Switching MinWeigh function on/off When set to  and if the weight on the scale drops below the stored minimum weight,  will appear in the symbols and info line and the display color will change.
Display color	Setting the display color for weight values below the stored minimum weight.
Note	Before you can use this function, the <b>METTLER TOLEDO</b> service technician has to determine and enter a minimum weight value.

Reset	Resetting the scale settings to factory settings
Perform reset?	- Confirm resetting with  .

## 7.4 Application menu block

### 7.4.1 Application menu overview

The Application menu block consists of the following main subblocks, which are described in detail below.

- Straight weighing
- Average weighing
- Clever print
- Counting
- Over/Under Checkweighing, Filling
- Classifying
- Totalizing
- Identification
- Statistics
- Memory
- Article database
- Prompting

Factory settings are printed in **bold** in the following overviews.



## 7.4.2 Application → Straight weighing

### Overview

Level 1	Level 2	Level 3
Auxiliary lines	Auxiliary line 1 ... Auxiliary line 3	Not used, Date & time (for battery devices incl. remaining capacity in % and in hours), Gross, Net, Tare, High resolution (for non-approved scales only), ID1, ID2, ID3, Bargraph, Temperature (for <b>ICS685k-.../f</b> only), Consecutive number, Active scale model, Terminal location, APW, Reference count, Quantity, Custom unit factor, CntAccuracy, Target, Tolerance +, Tolerance -, Deviation, Article, Article description, Article info 1, Article info 2, Article info 3, Total net, Total gross, Total PCS, Total target, Lot, User name, User ID, Class info.
Printout	COM1 ... COM4	Off, <b>Standard</b> , Template 1 ... Template 20

### Description

Auxiliary lines	Selecting contents of the auxiliary lines in the straight weighing application
Auxiliary line 1	Factory setting: Date & Time
Auxiliary line 2	Factory setting: Bargraph
Auxiliary line 3	Factory setting: Article

Printout	Defining printer and template in the straight weighing application
<b>COM1 ... COM4</b>	Selecting the COM port for the desired printer E.g., COM1 for printout to a PC and the optional COM2 for printout on an office (ASCII) printer
Off	No printout on this COM port
Standard	Printout with the standard template on the selected printer
Template 1 ... Template 10	Assigning a customer template to the selected printer
Notes	<ul style="list-style-type: none"> <li>• Templates 1 ... 10 can be defined under <code>Communication -&gt; Define templates</code>.</li> <li>• This menu item is only available if a COM port is set to Print mode.</li> <li>• There are 10 more templates available (Template 10 ... Template 20). Please ask your <b>METTLER TOLEDO</b> service technician to configure these templates or create them by yourself using the DatablCS software (<a href="http://www.mt.com/ind-datablcs">www.mt.com/ind-datablcs</a>), if desired.</li> </ul>

### 7.4.3 Application → Average weighing

Mode	Selecting mode for determining the average weight for an unstable load (dynamic weighing)
Soft key	Calculating average weight with manual start of the weighing cycle via soft key 
Auto	Calculating average weight with automatic start of the weighing cycle

Timer	Selecting the period of time over which the average weight is calculated
	With a longer timer setting the reproducibility of the average weighing result is better Factory setting: 4 seconds Possible settings: 0 ... 99 seconds

Auxiliary lines	Selecting mode for determining the average weight for an unstable load (dynamic weighing)
Auxiliary line 1	Factory setting: High resolution
Auxiliary line 2	Factory setting: Bargraph
Auxiliary line 3	Factory setting: Article

Printout	Defining printer and template in the average weighing application
	See Application → Straight weighing

### 7.4.4 Application → Clever print

Clever print	Settings for printing without pressing a key
Activate	When set to <input type="radio"/> On, the result is automatically printed when the weight between two weighings has dropped below the threshold.
Threshold	Enter threshold for unloading the scale between two weighings. Possible settings: 0.0 kg ... max. capacity Factory setting: 0.0 kg

## 7.4.5 Application → Counting

### Overview

Level 1	Level 2	Level 3
Unit & Reference	Unit type	<b>Piece counting</b> , Custom unit
	Unit name	
	Unit format	
	Reference size	
	Fixed reference size	<b>Off</b> , On
	Reference weight check	<b>Off</b> , On, 1 % ... 30 %
	Display color < Minimum ref. weight	<b>Red</b> , Green, Blue, Violet, Dark blue, Grey, White, Yellow
Average piece / unit weight	APW optimization	<b>Off</b> , Auto, soft key
	Autosampling	On, <b>Off</b>
	Auto clear APW	On, <b>Off</b>
	Counting accuracy	%, PCS/Custom unit
Counting system	Scale 1 ... Scale 4	Bulk, Reference, Aux., Off
	Total count	<b>Bulk</b> , Bulk + Ref.
Auxiliary lines	see Application → Straight weighing	
Printout		

## Description

<b>Unit &amp; Reference</b>	<b>Monitoring the minimum reference weight</b>
<b>Unit type</b>	<b>Selecting the unit for counting pieces or measuring, e.g., lengths or volumes</b>
Piece counting	Unit type for counting pieces. The result is an integer number.
Custom unit	Unit type for measuring in a user-defined unit, e.g., lengths, areas or liquid volumes. The result is a decimal number.
<b>Unit name</b>	<b>Entering a name for the Custom unit with max. 5 characters, e.g, "Screws", "m", "ml"</b>
<b>Unit format</b> Y.YYY	<b>Setting the resolution of the counting result with unit type Custom unit</b>
<b>Reference size</b>	<b>Defining a default reference size, e.g., 12 PCS</b> The reference size is displayed in the soft key  .
<b>Fixed reference size</b>	<b>Selecting the type of reference size</b>
Off	Variable reference size, i.e., any number of parts can be used as reference size
On	Determining the average piece weigh is only possible with the default reference size
<b>Reference weight check</b>	<b>Monitoring the minimum reference weight</b>
Off	No monitoring of the minimum reference weight
On	Monitoring the minimum reference weight. When the reference weight drops below the set tolerance value, the display color changes and a message is displayed which asks you to add more reference parts.
1 %, 2 %, ... 30 %	Setting the process tolerance for the reference weight check. The higher the process tolerance, the smaller the required minimum reference weight. Only displayed if Reference weight check is set to On.
Display color < Tolerance ref. weight	Selecting the display color for reference weights below the tolerance value set for the reference weight check

<b>Average piece / unit weight</b>	<b>Advanced settings for counting</b>
<b>APW optimization</b>	<b>Optimization of the average piece weight</b>
Off	No optimization of the average piece weight
Auto	Automatic optimization of the average piece weight
Soft key	Manual optimization of the average piece weight with soft key  .
<b>Autosampling</b>	<b>Automatic determination of the average piece weight</b>
On	After taring, the average piece weight is determined with the next weight placed on the scale and the displayed reference size
Off	No automatic determination of the average piece weight
<b>Auto clear APW</b>	<b>Automatic clearing of the average piece weight</b>
On	When the load is taken off the scale after a counting operation, the average piece weight is automatically cleared. The next counting operation will begin with determining the average piece weight again.
Off	The average piece weight must be cleared manually with <b>C</b> .

Average piece / unit weight	Advanced settings for counting
<b>Counting accuracy</b>	<b>Selecting the unit for displaying the counting accuracy in an auxiliary line</b> In addition, the item <code>Counting accuracy</code> must be activated for an auxiliary line under <code>Application -&gt; Counting -&gt; Auxiliary lines</code> . In the displayed counting accuracy the standard deviation of the parts is not included.
%	Display of the counting accuracy in %
PCS/Custom unit	Display of the counting accuracy in PCS/Custom unit

Counting system	Configuring a system of several scales for counting
<b>Scale 1 ... Scale 4</b>	<b>Selecting the scale to assign a function in the counting system.</b> Only the connected scales are displayed.
Bulk	The selected scale serves as bulk scale to count/measure quantities. Another scale of the system must be set to <code>Reference</code> .
Reference	The selected scale serves as reference scale to determine the average piece/unit weight. Another scale of the system must be set to <code>Bulk</code> .
Aux.	The selected scale can be used for determining the average piece/unit weight as well as for counting/measuring.
Off	The selected scale is not part of a counting system.
<b>Total count</b>	<b>Selecting the displayed number of pieces on the bulk scale</b>
Bulk	Only the pieces on the bulk scale are displayed.
Bulk + Ref.	The pieces both on the bulk scale and on the reference scale are displayed on the bulk scale.

Auxiliary lines	Selecting contents of the auxiliary lines in the straight weighing application
Auxiliary line 1	Factory setting: High resolution
Auxiliary line 2	Factory setting: Bargraph
Auxiliary line 3	Factory setting: Article
Possible contents of the auxiliary lines	See <code>Application -&gt; Straight weighing</code>

Printout	Defining printer and template in the counting application
	See <code>Application -&gt; Straight weighing</code> .

## 7.4.6 Application → Over/Under

### Overview

Level 1	Level 2	Level 3
Default values	Initial tolerance type	<b>Off</b> , Absolute, Relative, Percent
	Act. def. values	<b>Off</b> , On
	Rel. weight	Tol–, Tol+
	Per. weight	Tol–, Tol+
	Rel. pieces	Tol–, Tol+
Output	Thresh % of Tol–	0 ... <b>12</b> ... 100 %
	Beeper	<b>Off</b> , Within Tolerances, Outside Tolerances, Stable result
	Beeper mode	Stable result, Tolerance border
	Autoprint	<b>Off</b> , Within Tolerances, Outside Tolerances, Stable result
Display mode & Colors	Stealth mode	On, Off
	Good range	White, Yellow, Red, Green, Blue, Violet, Dark blue, Grey (not for <b>ICS685</b> )
	Under range	
	Over range	
	Below threshold	
Auxiliary lines	See Application → Straight weighing	
Printout		

### Description

Default values	Storing default tolerance values
Initial tolerance type	<p>Selecting default tolerance type</p> <p><b>Off</b>: No tolerance type predefined. It can be set individually when entering Over/Under Checkweighing parameters.</p> <p><b>Absolute</b>: A low and a high weight value must be entered. These weights and all weights within this range are treated as being within tolerance.</p> <p><b>Relative</b>: The target weight has to be entered as an absolute weight, upper and lower tolerances as deviations in weight from the target weight.</p> <p><b>Percent</b>: The target weight has to be entered as an absolute weight, upper and lower tolerances as deviations in percent from the target weight. This setting is not available for counting.</p>
Act. def. values	Activating/deactivating usage of default tolerance values.
Rel. weight	Entering the default values for Tolerance – and Tolerance +.
Per. weight	Entering the default percentages for Tolerance – and Tolerance +.
Rel. pcs	Entering the default values for Tolerance – and Tolerance + in pieces or in a defined custom unit.
Note	When always using the same tolerances for Over/Under Checkweighing, store these tolerances to avoid entering tolerances all the time.

Output	Setting output options
<b>Threshold as % of Tol-</b>	<p><b>Threshold to determine at which weight the status of Tol- is indicated.</b></p> <p>To avoid Tol- being active at zero or a very low weight, you can define the "Threshold as % of Tol-".</p> <p>When Threshold as % of Tol- is reached, the colored display will change from the "Below threshold" color to the "Tolerance -" color.</p> <p>This feature can be used to show the "Tolerance -" color close to the target or as additional setpoint for I/O control.</p> <p>This setpoint is available on the optional digital I/O interface as well.</p> <p><b>Example:</b> Target = 1000 g, Tol- = 100 g            Threshold = x % * (Target - (Tol-))            Threshold = 12 % * (1000 g - 100 g) = 12 % * 900 g = 108 g            In the example, the Tol- color is displayed for weights from 108 g up to 900 g.</p>
<b>Beeper</b>	<b>Setting the beeper for Over/Under Checkweighing</b>
Off	No beeper
Within tolerances	A short beep will sound when a weight value within the tolerance values is reached
Outside tolerances	A short beep will sound when a weight value outside the tolerance values is reached
Stable result	A short beep will sound when a stable result is reached
<b>Beeper mode</b>	<b>Defining how the beeper will act</b>
Stable result	Beeping only when a stable weight value within the selected range is recognized
Tolerance border	Beeping on every entering or leaving of the good range
<b>Autoprint</b>	<b>Setting the automatic printout</b>
Off	No automatic printout
Within tolerances	Automatic printout when a stable weight value within the tolerance values is reached
Outside tolerances	Automatic printout when a stable weight value outside the tolerance values is reached
Stable result	Automatic printout when a stable result is reached
Note	For the automatic printout, the communication port at which the printer is connected, must be configured as follows: COMx -> Mode -> Print (and not Auto Print!)

<b>Display mode &amp; colors</b>	<b>Setting the weight display in the Over/Under Checkweighing application</b>
Stealth mode	This menu item is not available for approved scales. When set to $On$ , there is no weight display, only the (colored) display for "too light", "good" and "too heavy".
Good range	Selecting the color to indicate a weight value within tolerances Factory setting: green
Under range	Selecting the color to indicate a weight value below "Tolerance -" Factory setting: red
Over range	Selecting the color to indicate a weight value above "Tolerance +" Factory setting: yellow
Below threshold	Selecting the color to indicate a weight value below "Threshold as % of Tol-" Factory setting: white

<b>Auxiliary lines</b>	<b>Selecting contents of the auxiliary lines in the straight weighing application</b>
Auxiliary line 1	Factory setting: Not used
Auxiliary line 2	Factory setting: Not used
Auxiliary line 3	Factory setting: Article

<b>Printout</b>	<b>Defining printer and template in the Over/Under Checkweighing application</b>
	See Application -> Straight weighing



## 7.4.7 Application → Classifying

### Overview

Level 1	Level 2	Level 3
Class name	<b>Default</b> , Customized	
Class print	<b>Off</b> , On	
Display mode	<b>Continuous</b> , Stable	
Stealth mode	<b>Off</b> , On	
Color	Out of class, Class 1 ... Class 12	White, Yellow, Light blue, Dark blue, Light red, Dark red, Orange, Violet, Light green, Dark green, Pink, Light grey, Dark grey
Auxiliary lines	See Application → Straight weighing	
Printout		

### Description

<b>Classifying</b>	<b>Setting classifying parameters</b>
<b>Class name</b>	<b>Naming of the classes</b>
Default	When entering class identification values, only the weight values have to be entered. The class names are Class 1 to Class 12.
Custom	When entering class identification values, the class names can be entered, too.
<b>Class print</b>	<b>Printout with class information</b>
Off	No class information on the printout
On	Printout with class information
<b>Display mode</b>	<b>Setting the class display</b>
Continuous	Continuous class display
Stable	Class display when a stable weight value is reached
<b>Stealth mode</b>	<b>Hiding the weight display</b>
Off	Colored display for the classes with weight value
On	Only colored display for the classes, without weight value. Not available, if the scale is approved.
<b>Color</b>	<b>Setting the colors for the classes</b>
Out of class	Factory setting: White
Class 1 ... Class 12	In the factory setting, Class 1 ... Class 12 are displayed in the following order: Yellow, Light blue, Dark blue, Light red, Dark red, Orange, Violet, Light green, Dark green, Pink, Light grey, Dark grey

## 7.4.8 Application → Totalizing

### Overview

Level 1	Level 2	Level 3	Level 4
Mode	Mode	<b>Manual</b> , Auto +, Auto –	
	Zero return	<b>Off</b> , On	
	Tare after sum	<b>Off</b> , On	
	Clear at target	<b>Off</b> , On	
Auxiliary lines	See "Straight weighing"		
Printout	Lot print	COM1 ... COM4	Off, Standard, Template 1 ... Template 20
	Final print		
	Summary print		

### Description

Mode	Configuring totalizing
<b>Mode</b>	<b>Selecting the totalizing mode</b>
Manual	Items must be totalized manually with the soft key
Auto +	Stable weight values will be totalized automatically
Auto –	Automatic totalization of stable weight values in subtractive weighing
<b>Zero return</b>	<b>Reaching a stable zero point between two items</b>
On	The scale must be unloaded before totalization of the next item is possible
Off	No load removal requested between two items
<b>Tare after sum</b>	<b>Leaving the totalized items on the scale</b>
On	The weight is automatically tared after each totalizing process
Off	No automatic taring after totalizing
<b>Clear at target</b>	<b>Clearing of the sum when the target (lot numer) is reached</b> For this function, at least one communication port must be configured as "Printer".
On	Automatic clearing of the sum when the target is reached
Off	The sum has to be cleared manually

Printout	Defining printer and template in the totalizing application
<b>Lot print</b>	<b>Printout for each individual totalizing action</b>
<b>Final print</b>	<b>Printout of the total at the end of totalizing (by pressing <b>C</b> or deleting the memory)</b>
<b>Summary print</b>	<b>Additional printout of the individual items</b>
COM1 ... COM4	Selecting the printer interface for the selected printout
Off	No automatic printout
Standard	Automatic printout using the standard template which is predefined in the factory
Template 1 ... Template 10	Automatic printout using the selected template

### 7.4.9 Application → Identification

ID1, ID2, ID3	Labelling the identification soft keys
Soft key description	Entering a soft key label for the identification soft keys with max. 5 characters. E.g., soft keys "User, "Art.No.", "Lot" instead of ID1, ID2, ID3
Printout description	Entering a description of the identification for printout with max. 40 characters. E.g., "User name", "Article number", "Lot number" on the printout instead of ID1, ID2, ID3

### 7.4.10 Application → Statistics

Statistics	Selecting statistical information to be displayed or printed
Standard dev	Standard deviation of a weighing series
Std. dev. good	Standard deviation of all samples within tolerances of a weighing series
Mean value	Mean value of a weighing series
Mean value good	Mean value of all samples within tolerances of a weighing series
Max. value	Maximum weight value of a weighing series
Min. value	Minimum weight value of a weighing series
Median	Weight value separating the higher half of a weighing series from the lower half
% ratio per class	Percentage of good, high and low items in a weighing series
# per class	Number of good, high or low items in a weighing series
Note	In the factory setting all items are activated

## 7.4.11 Application → Memory

### Overview

Level 1	Level 2	Level 3
Memory mode	Mode	<b>Alibi</b> , Transaction, Off
	Field 1 ... Field 12	<b>Off</b> , Date & time, Net, Tare, SNo Scale, Terminal location, Article, Article description, ID1, ID2, ID34, APW, Quantity, SNo Terminal, Temperature (for <b>ICS685k-.../f</b> only), Gross, User name, User ID, Unit name, Article Info 1, Article Info 2, Article Info 3, Reference count, Counting accuracy, n, Weight position
Memory backup	File name	
	Delimiter	, ;

### Description

Memory mode	Configuring a system of several scales for counting
<b>Mode</b>	<b>Configuring memory mode</b>
Off	No memory of weighing results
Alibi	Alibi memory active. All transferred weighing results are stored in the terminal. The information required by law is stored in fields 1 to 4. These fields cannot be changed. Additional information is selectable for the fields 5 to 12.
Transactiion	Transaction memory active. All transferred weighing results are stored in the terminal. The information to be stored in the fields 1 to 12 is freely selectable.
<b>Field 1 ... Field 12</b>	<b>Selecting information to be stored in the corresponding fields</b>

Memory backup	Download of the complete memory to a USB stick as a .csv file
File name	Enter the file name of the memory backup
Delimiter	Select the delimiter in the memory .csv file
Note	This menu item is only available if a USB Host interface is installed

### 7.4.12 Application → Database

Database access mode	Specifying database
Internal DB	Internal database, database maintenance via the <b>ICS685 / ICS689</b> terminal
External DB	External database, database maintenance via the DatabICS software (www.mt.com/ind-databics)
COM → COM1 ... COM4	Selecting terminal port of the external database
IP address	Entering IP address of the server of the external database
Port	Entering port of the database on the external server

Database backup	Download of the complete database to a USB stick as a .csv file
File name	Enter the file name of the database backup
Delimiter	Select the delimiter in the database .csv file
Note	This menu item is only available if a USB Host interface is installed.

Database restore	Restore/load the database from a USB stick
File name	Select the file name of the database and press  . The database is uploaded to the terminal
Note	This menu item is only available if a USB Host interface is installed.

### 7.4.13 Application → Prompting

#### Overview





Level 1	Level 2	Level 3	Level 4	Level 5
Prompt 1	Mode	<b>Disabled</b> , Soft key		
...	Soft key description			
Prompt 3	Apps	Off, Tare/Sample, Sample/Tare, Handsfree counting, Multi tare, Additive tare, Take away, Custom prompt 1 ... Custom prompt 3		
Custom prompts	Custom prompt 1	Name		
	...	Step 1	Prompt text	
	Custom prompt 3	...	Prompt function	Text, Tare, Clear tare, Auto tare, Preset tare, Print, Auto print, Auto switch scale 1 ... 4, Reference, Auto reference, APW, Auto APW clear, ID1, ID2, ID3, Recall article
		Step 15		

## Description

<b>Prompt 1 ... Prompt 3</b>	<b>Configuring user guidance</b>
<b>Mode</b>	<b>Configuring start of the prompting</b>
Disabled	No prompting
Soft key	Start by a soft key
<b>Soft key description</b>	<b>Entering a description for the prompting soft key with max. 5 characters</b> E.g., "Count", "Check", "Class" when there are specific user guidances for these applications. This menu item is only available if <code>Soft key</code> is activated.
<b>Apps</b>	<b>Selecting the workflow which shall be supported by the prompt</b>
Tare/Sample	Reference determination: First tare, then add reference parts
Sample/Tare	Reference determination: First weigh reference parts, then tare
Handsfree	Counting without a keystroke
Multi tare	Taring of several containers with the same tare weight
Additive tare	Adding the known tare weight of different containers
Take away	Over/Under Checkweighing out of a container without pressing a key
Custom prompt 1 ... Custom prompt 3	Selecting from custom workflows

<b>Custom prompts</b>	<b>Configuring your own workflows with up to 15 steps</b>
<b>Custom prompt 1</b> ... <b>Custom prompt 3</b>	<b>Selecting the number of the custom prompt (workflow)</b>
Name	Entering the name of your custom prompt (workflow), max. 24 characters
Step 1 ... Step 15	Selecting the step in the workflow
• Prompt text	Entering the text to be displayed with the selected step, max. 30 characters
• Prompt function	Selecting function for the step
Note	Before you can start the prompt via soft key you have to assign the prompt to a specific soft key in the <code>Terminal</code> menu under <code>Device</code> -> <code>Keyboard</code> -> <code>Soft keys</code>

**Example: creating a new prompt for counting parts in a full container**

Step	Text	Function	Displayed soft key	Note
1	Put 10 samples on the scale and press key	Reference		Confirm action with the indicated soft key
2	Place the full container on the scale	Text		Confirm action with the indicated soft key
3	Enter tare weight	Preset tare		Press the indicated soft key and enter tare weight
4	Read the result	Text		Confirm with the indicated soft key
5	Print	Print		Confirm with the indicated soft key

**7.4.14 Application → Reset**

Reset	Resetting the application settings to factory settings
Perform reset?	- Confirm resetting with  .

## 7.5 Terminal menu block

### 7.5.1 Terminal menu overview

The `Terminal` menu block consists of the following main subblocks, which are described in detail in the following.

- Device
- Access
- User management
- Reset

Factory settings are printed in **bold** in the following overview.

### 7.5.2 Terminal → Device

#### Overview

Level 1	Level 2	Level 3	Level 4	Level 5
Region	Language	<b>English</b> , US-english, Deutsch, Français, Italiano, Español, Chinese, ...		
	Date format	MM/DD/YY, MM/DD/YYYY, MMM/DD/YYYY, DD/MM/YY, DD/MMM/YYYY, YY/MM/DD, YYYY/MMM/DD, YYYY/MM/DD, <b>DD/MM/YYYY</b>		
	Set date	Set year		
		Set month		
		Set day		
	Time format	24:MM, 12:MM tt, <b>24:MM:SS</b> , 12:MM:SS tt		
	Set time	Set hour		
Set minutes				
Daylight saving	<b>0</b> , 1			
Energy save	Backlight	<b>On</b> , 5 seconds, 10 seconds, 15 seconds, 30 seconds		
	Power off	<b>Off</b> , 1 minute, 3 minutes, 5 minutes, 15 minutes, 30 minutes		
Identi- fication	Terminal location			
	Terminal ID			
Display	Display layout	<b>Default</b> , 3-lines mode, Color mode		
	Contrast	1 ... <b>5</b> ... 10		
	Brightness	1 ... 10		
	Weight hold	<b>0 s</b> ... 10 s		
	Default color	<b>White</b> , Yellow, Red, Green, Blue, Violet, Dark blue, Grey		



Level 1	Level 2	Level 3	Level 4	Level 5	
Keyboard	Hard keys	Power, Clear, Switch, Info, Transfer, Numeric keys, Navigation, Quick select, Info	On, Off		
	Soft key	Soft key 1-1 ... Soft key 4-5	Not used, Zero, Tare, Alibi memory, Switch scale, x10 display, Transfer, Average weighing, ID1, ID2, ID3, Prompt 1, Prompt 2, Prompt 3, Reference N VAR, Reference N FIX, APW, APW optimization, Totalizing, Checkweighing, Filling, Weight/Count, Save as article, Temperature check (for <b>ICS685k-.../f</b> only), Database, Recall article, Logout, Display layout, Consecutive No., Classifying		
	Info key	Page 1	Item 1 ... Item 9	Not used, Date & Time, Highres and net, Gross, Tare, Temperature (for <b>ICS685k-.../f</b> only), Terminal ID, Terminal location, Terminal model, SNo. Terminal, Terminal FW, SNo. Scale, Scale FW, Record number, ID1, ID2, ID3, APW, Quantity, Total gross, Total net, Total PCS, Lot, Deviation, Target, Tolerance-, Tolerance+, MinWeigh, Article, Article description, Article info 1, Article info 2, Article info 3, User name, User ID, IP address, Subnet mask, Gateway, USB version, Consecutive No., Class no.	
			Page 2 & 3	Info page 2	Off, System info, Contact info
				Info page 3	Off, System info, Contact info
		Beeper	<b>On</b> , Off		
		External keyboard			
Message time	1 s, <b>2 s</b> , ... 6 s				
Battery	Charge strategy	<b>Full</b> , Preservation			
Timeout	Mode	<b>Off</b> , Rental, Rental info			
	Password				
	Set date	Set year, Set month, Set day			
	Rental image	<b>Default</b> , Customer, Text only			
	Text 1, Text 2				





## Description

Region	Country specific settings
<b>Language</b>	<b>Selecting the language of the operator interface.</b> We will expand the available languages continuously.
<b>Date format</b>	<b>Selecting the date format.</b>
<b>Set date</b>	<b>Entering the date in the selected format.</b>
Set month	Entering the month in the selected format.
Set day	Entering the day in the selected format.
<b>Time format</b>	<b>Selecting the time format.</b>
<b>Set time</b>	<b>Entering the time in the selected format.</b>
Set hour	Entering the hour in the selected format.
Set minutes	Entering the minutes.
<b>Daylight saving</b>	<b>Setting daylight saving time</b>
0	Deactivating daylight saving time
+1	Activating daylight saving time

Energy save (Operator access)	Setting the energy saving mode
<b>Backlight</b>	Settings for switching off the backlighting
On	Backlight always on
5 seconds ... 30 seconds	Selecting the time period after which the device switches off display and backlighting when not in use and gross weight is 0. Display and backlighting are switched on again by pressing a key or if the weight changes.
<b>Power off</b>	Settings for switching off the device
Off	No energy saving mode
1 minute ... 30 minutes	Selecting the time period after which the device switches off when not in use and gross weight is 0. After this, it must be switched on again using  .

Identification	Setting terminal identification data
Terminal location	Entering the terminal location, e.g., floor and room
Terminal ID	Entering the terminal identification, e.g., inventory number
Notes	<ul style="list-style-type: none"> <li>Terminal location and terminal identification can be displayed in the auxiliary or info lines or printed out.</li> <li>Terminal location and terminal identification can consist of up to 12 characters (0 ... 9 and decimal point).</li> </ul>

Display	Setting the display according to your specific task
Display Layout	Selecting the presentation of the weight value.
Contrast (Operator access)	Setting the contrast of the display. This menu item is accessible with Operator access rights.
Brightness (Operator access)	Setting the brightness of the display. This menu item is accessible with Operator access rights.
Weight hold	Setting how long (in seconds) the weighing result is frozen in the display after the transfer key  has been pressed or auto print was generated.
Default color	Setting the default color of the display background.

Keyboard	Setting the keyboard according to your specific task
<b>Hard keys</b>	<b>Locking/unlocking keys</b> Possible keys: Power (  ), Clear ( <b>C</b> ), Switch / Toggle (  ), Info ( <b>i</b> ), Transfer (  ), Numeric keys, Navigation, Quick Select (  ) <b>Note:</b> The Quick Select key can be protected by a password.
<b>Soft keys</b>	<b>Assigning a function to the selected key</b>
Soft key 1-1 ... Soft key 4-5	1 Select the soft key number. 2 Assign function. <b>Note:</b> If <code>Recall article</code> is selected as function, an additional window opens to enter the corresponding soft key description (max. 4 characters) and to select the article from the database.
<b>Info key</b>	<b>Configuring the items to be displayed using the info key ( <b>i</b> )</b>
Page 1	On the first page of the info key up to 9 information items on the weighing process can be configured. 1 Select item number. 2 Assign information.
Page 2, Page 3	On pages 2 and 3 system and contact information will be displayed. In case of a problem, here you will find your contact data and the system information the service technician will ask for. System information is set by the manufacturer, contact information can be entered directly.
<b>Beeper</b>	<b>When set to On, each keystroke will be confirmed by a short beep.</b>
<b>External keyboard</b>	<b>Selecting the layout of an external keyboard which is connected via USB interface</b> This menu item is only available if an external keyboard is connected. We will expand the available keyboards continuously.

Message time	Setting how long a message is displayed
1, 2, 3, 4, 5, 6	Setting how long a message is displayed in seconds

Battery	Battery settings
<b>Charge strategy</b>	<b>Setting the charging strategy.</b>
Full	The battery will always be fully charged.
Preservation	Charging to prevent total discharge.

<b>Time out</b>	<b>Setting the behaviour when no action takes place on the terminal</b>
<b>Mode</b>	<b>Setting the time out mode.</b>
Off	No time out setting.
Rental	The scale can only be used until a set date, e.g., when the scale is rented for a special event like a fair or a market. After the expiration date a message is displayed: <b>Rental expired</b> and the scale can no longer be used.
Rental info	When the set date has passed, a message is displayed: <b>Rental expired</b> . By pressing the key <b>C</b> , the message is cleared and the scale can be used as before.
<b>Set date</b>	<b>Entering the expiration date.</b>
Set year	Entering the year of the expiration date.
Set month	Entering the month of the expiration date.
Set day	Entering the day of the expiration date.

### 7.5.3 Terminal -> Access

<b>Supervisor</b>	<b>Password for Supervisor menu access</b>
Password	Enter password for Supervisor menu access.
Retype password	Repeat the password entry.
Note	The password can consist of up to 4 characters.



### 7.5.4 Terminal -> User management

#### Overview









Level 1	Level 2	Level 3	Level 4	
User 1 ... User 20	Profile – User x	User name		
		User ID		
		Profile	<b>Operator</b> , supervisor	
		Language	<b>English</b> , Deutsch, Français, Italiano, Español, Chinese, ...	
		Password		
	Activate user		<b>On</b> , Off	
	Hard keys – User x	Power, Clear, Switch, transfer, Tare, Numeric keys, Navigation, Quick Select, Info, Zero		<b>On</b> , Off
		Soft keys – User x	Soft key 1-1 ... Soft key 4-5	Not used, Zero, Tare, Alibi memory, Switch scale, x10 display, Transfer, Average weighing, ID1, ID2, ID3, Prompt 1, Prompt 2, Prompt 3, Reference N VAR, Reference N FIX, APW, APW optimization, Totalizing, Checkweighing, Filling, Weight/Count, Save as article, Temperature check (for <b>ICS685k-.../f</b> only), Database, Recall article, Logout, Display layout, Consecutive no.

## Description

When opening the User management menu block, the following overview is displayed:

- 1 Use the cursor keys  $\wedge$  /  $\vee$  to select a user.
- 2 Use the soft key  to edit the selected user.  
⇒ The user profile is displayed in detail.
- 3 Use the soft keys  /  to proceed to the pages "Hard keys – User x" and "Soft keys – User x"

User management – Overview			
User name	User ID	Profile	Active
USER1	1	Operator	Off
USER2	2	Supervisor	Off
User3	3	Operator	Off
User4	4	Operator	Off
User 5		Operator	Off
User 6		Operator	Off
User 7		Operator	Off
User 8		Operator	Off
User 9		Operator	Off
User 10		Operator	Off

User 1 ... User 20	Configuring up to 20 users
<b>Profile user</b>	<b>Configuring user profiles</b>
User name	Enter User name, max. 10 characters
User ID	Enter a User ID, e.g., personnel number, max. 4 characters
Profile	Assigning access rights: Operator, Supervisor
Language	Assigning the individual user language
Password	Setting a password and confirming password
Activate user	When set to On, the selected user can log on to the device
<b>Hard keys user</b>	<b>User-specific locking/unlocking of keys</b>
	Possible keys: Power (  ) , Clear (  ) , Switch (  ) , Transfer (  ) , Tare (  ) , Numeric keys, Navigation, Quick Select (  ) , Info (  ) , Zero (  )
<b>Soft keys user</b>	<b>Setting the user-specific soft key functions</b>
Soft key 1-1	1 Select soft key number.
...	2 Assign function.
Soft key 4-5	The corresponding soft key symbols are shown in the Introduction chapter.

### 7.5.5 Terminal → Reset

Reset	Resetting the terminal settings to factory settings
Perform reset?	- Confirm resetting with  .

## 7.6 Communication menu block

### 7.6.1 General

**i** For detailed information on interface protocols and commands refer to the SICS Reference manual.

The `Communication` menu block consists of the following subblocks:

- **Overview** Showing the interfaces installed.
- **COM1** Parameter settings for the standard RS232 interface COM1.
- **COM2** Parameter settings for the optional second interface COM2.
- **COM3 / COM4** Parameter settings for the optional interfaces COM3 / COM4.
- **Define templates** Defining templates to be assigned to the application-specific printouts.

The interfaces identify themselves. Therefore only those menu settings appear which are relevant for the individual interface. If no optional interface is installed, the COM3 / COM4 menu will not appear.

#### Interface overview

The following is displayed when calling up `Communication -> Overview`:

Overview		
<b>COM 1</b>	RS232	Print
<b>COM 2</b>	RS232	Dialog
<b>COM 3</b>	RS232	Dialog
<b>COM 4</b>	n.a.	n.a

## 7.6.2 Overview of the communication menu blocks

### Possible settings

		COM1 / COM2 (default)	COM2 (optional / COM3 / COM4					
		RS232	RS232	RS422 / RS485	Ethernet (COM3 only)	WLAN (COM3 only)	USB Device	USB Host
Mode	Print Auto print Instant print Continuous (Dialog)*	X	X	X	X	X	X	–
	Dialog*	Factory setting						
	External input	X	X	X	X	X	X	X
	Toledo cont.-weight Toledo cont.-count SICS scale X scale Digitol B Digitol G	X	X	X	X	X	X	–
	Second display	X	X	X	X	X	–	–
	SICSpro scale	–	–	X	–	–	–	–
	ARM100	–	–	X	–	–	–	–
	Printer	X	X	X	X	X	X	–
External input	X	X	X	X	X	X	X	
Parameter	Baud (factory setting)	9600	9600	9600	–	–	–	–
	Parity (factory setting)	8 none	8 none	8 none	–	–	–	–
	Handshake	X	X	X	–	–	–	–
	Checksum**	X	X	X	X	X	–	–
	STX**	X	X	X	X	X	–	–
	RS Type Net Address Load resistor	–	–	X	–	–	–	–
	DHCP IP address Subnet mask Gateway	–	–	–	X	X	–	–
TCP settings	–	–	–	X	X	–	–	
Wireless settings	–	–	–	–	X	–	–	

\* for more information see SICS Reference manual

\*\* only available for Toledo cont. modes

### RS232 menu block

Level 1	Level 2	Level 3	Level 4
Mode	Print, Auto print, Instant print, <b>Dialog</b> , Continuous (Dialog), External input, Toledo Cont.-weight, Toledo Cont.-count, Second display, SICS scale, X scale		
	Digitol B, Digitol G	Net Gross Tare	On, <b>Off</b>
Printer	Type	<b>ASCII printer</b> , Values only	
	ASCII Format	Line format	<b>Multiple</b> , Single, Fixed
		Line length	1 ... <b>24</b> ... 100
		Separator (for line format Single only)	. , ; - _ / \ Space
		Add line feed	<b>0</b> ... 9
External input	Preamble length		
	Data length		
	Postamble length		
	Termination character	CR, LF, EOT, ...	
	Destination	Off, Tare preset, ID1, ID2, ID3, APW, Article, Target	
Parameter	Baud	300, 600, ... <b>9600</b> , ... 115200 baud	
	Parity	7 none, 8 none, 7 odd, 8 odd, 7 even, 8 even	
	Handshake	Off, Xon – Xoff	
	Checksum	Off, On	
Reset RS232	Perform Reset?		

### RS422 / RS485 menu block

Level 1	Level 2	Level 3
Mode	Print, Auto print, Instant print, <b>Dialog</b> , Continuous (Dialog), External input, Toledo Cont.-weight, Toledo Cont.-count, Second display, SICS scale, X scale, SICSpro scale, ARM100	
Printer	see RS232	
External input		
Parameter	Baud	300, 600, ... 9600, ... 115200 baud
	Parity	7 none, <b>8 none</b> , 7 odd, 8 odd, 7 even, 8 even
	Handshake	<b>Off</b> , Xon – Xoff
	RS-Type	<b>RS422</b> , RS485
	Net address	<b>0</b> ... 31
	Checksum	<b>Off</b> , On
	Load resistor	<b>Off</b> , On
Reset RS4xx	Perform Reset ?	



### Ethernet menu block

Level 1	Level 2	Level 3
Mode	see RS232	
Printer		
External input		
Parameter	DHCP	Off, On
	Local IP	
	Subnet mask	
	Gateway	
	Checksum	Off, On
TCP Mode	TCP Mode	Server, Client, FreeWeigh
	Local Port	4305
	Remote IP	
	Remote port	
	Connect timeout	
	Disconnect timeout	
Reset Ethernet	Perform Reset?	

### WLAN menu block

Level 1	Level 2	Level 3
Mode	see RS232	
Printer		
External input		
Parameter	see Ethernet	
TCP mode	see Ethernet	
Wireless setting	SSID	
	Encryption	Off, WEP, WPA
	WEP settings	64 Bit, 128 Bit
	WEP key	Key 1, Key 2, Key 3, Key 4
	WPA settings	WPA-TKIP, WPA2-AES
	Password	
Status	Display the current status, e.g., connection status, signal strength	
Reset WLAN	Perform Reset?	

**i** A license file (RADIUS file) can be implemented via the DatabICS software ([mt.com/ind-databics](http://mt.com/ind-databics)).

### USB Host menu block

Level 1	Level 2	Level 3
USB version		
Keyboard / Barcode Reader	Preamble length	
	Data length	
	Postamble length	
	Termination char.	
	Destination	
USB settings	Alibi on the fly	On, Off



### USB Device menu block

Level 1	Level 2	Level 3	Level 4
Mode	Continuous (Dialog), <b>Dialog</b> , External input, Toledo Cont.-weight, Toledo Cont.-count, Print, Auto print, Instant print		
	Digitol B, Digitol G	Net, Gross, Tare	On, <b>Off</b>
Printer	see RS232		
Parameter	Checksum	<b>Off</b> , On	
Reset USB	Perform Reset?		



The driver for USB Device is available on the CD delivered with the weighing terminal.

### 7.6.3 Description of the communication menu blocks

Mode	Operating mode of the serial interface
<b>Print</b>	Manual data output to the printer with 
<b>Auto print</b>	Automatic output of stable results to the printer (e.g., for series weighing operations)
<b>Instant print</b>	Manual data output of the current weight value (either stable or not) to the printer with 
<b>Dialog</b>	Bi-directional communication via MT-SICS commands, control of the device via PC
<b>Continuous (Dialog)</b>	Ongoing output of all weight values via the interface
<b>External input</b>	Input other than via terminal keypad. What the input is used for is defined in the <code>Destination</code> menu block.
<b>Toledo Cont.-weight</b>	TOLEDO Continuous mode
<b>Toledo Cont.-count</b>	TOLEDO Continuous mode with counting results
<b>Second display</b>	On the selected interface port, a second display is connected.
<b>SICSpro scale</b>	On the selected interface port, a SICSpro scale is connected.
<b>SICS scale</b>	On the selected interface port, a SICS scale is connected.
<b>X scale</b>	On the selected interface port, an X scale is connected.
<b>Digitol B</b> <b>Digitol G</b>	Digitol compatible format. The gross weight is identified by "B". Digitol compatible format. The gross weight is identified by "G".
Net, Gross, Tare	Selecting the weight values to be transferred.
<b>ARM100</b>	On the selected interface port an ARM100 input/output module is connected.
Notes	Printing conditions for <code>Auto print</code> : <ul style="list-style-type: none"> <li>• The weight must be heavier than 9 display increments.</li> <li>• A weight change of at least 9 display increments is required to initiate the next printout.</li> </ul>

Printer		Configuring printer and formats for the protocol printout
<b>Type</b>	ASCII printer	If <code>Values only</code> is selected, the transmitted data does not include the name of the variable, e.g., <code>date</code> , <code>gross</code> , <code>ID1</code> , but the value and, if appropriate, the unit, as a separate line. This allows the label printer to fill its template with the required data.
	Values only	
<b>ASCII format</b>	<b>Line format</b>	<b>Selecting line format</b> (for ASCII printers only)
	Multiple	Multiple lines
	Single	Single lines
	Fixed	Fixed (records output in single lines; every record includes the number of characters that was defined under <code>Line length</code> )
	<b>Line length</b>	<b>Setting line length</b> This item is only displayed for the line formats <code>Multiple</code> and <code>Fixed</code> .
	<b>Separator</b>	<b>Selecting the separator</b> This item is only displayed for the line format <code>Single</code> .
<b>Add line feed</b>	<b>Adding line feeds</b>	





External input		Configuring input via barcode reader
Preamble length	The barcode may contain additional data before the relevant data (preamble) and behind (postamble).	
Data length		
Postamble length		
Termination char.	- Enter the number of characters of preamble, (relevant) data and postamble.	
Termination char.	Selecting the termination character which is used by the connected barcode scanner	
Destination	Selecting the item to be entered via barcode scanner	

USB Host		Configuring the USB Host interface
<b>USB version</b>	<b>Show the implemented USB version</b>	
<b>Keyboard / Barcode reader</b>	<b>Configure the external input via keyboard or barcode</b>	
Preamble length	The barcode may contain additional data before the relevant data (preamble) and behind (postamble).	
Data length		
Postamble length		
Termination char.	- Enter the number of characters of preamble, (relevant) data and postamble.	
Termination char.	Selecting the termination character which is used by the connected barcode scanner	
Destination	Selecting the item to be entered via barcode scanner	
<b>USB settings</b>	<b>Configuring an external alibi memory</b>	
Alibi on the fly	When set to <code>On</code> and a USB stick is inserted, the records are stored on the USB stick as well.	

## Connecting an USB keyboard

- To connect an external keyboard via USB Host, the COM port has to be defined as `External input` with the termination character LF.
- If a function is assigned to the external input as well, e.g., "Load article", use the Enter key to confirm the external input.

The function keys of the USB keyboard correspond to the following keys on the weighing terminal:

F1		F8	Displayed soft key 4
F2		F9	Displayed soft key 5 (right)
F3		ESC	 in the menu
F4		Back	Delete text character by character
F5	Displayed soft key 1 (left)	Enter	In straight weighing: print As external input: confirm
F6	Displayed soft key 2	Cursor keys	Cursor keys
F7	Displayed soft key 3		

Parameter	Communication parameters
Baud	Selecting baud rate
Parity	Selecting parity
Handshake	Selecting handshake
Checksum	Activating/deactivating checksum byte
STX	Activating/deactivating STX If STX is set to <code>On</code> , the STX signal (0x02) is sent at the beginning of each output string that is sent via the interface.
RS Type	Selecting type of the optional RS422/RS485 interface: either RS422 or RS485
Net Address	Assigning network address
Load resistor	To avoid reflections on a network, we recommend to make a defined termination. For this purpose, the load resistor within the terminal can be used. When set to <code>On</code> , a resistor of approx. 100 Ohm between the signal lines is enabled.
DHCP	If DHCP is set to <code>On</code> , the device will receive the IP address automatically. Then IP address, Subnet mask and Gateway are read-only fields.
Local IP	Displaying/entering the local IP address
Subnet mask	Displaying/entering subnet mask
Gateway	Displaying/entering gateway address
Note	Not all parameters are available on all serial interfaces. Refer to the overviews of the interfaces to check which parameters are available.

<b>TCP Mode</b>	<b>Transmission control protocol settings</b>
<b>TCP Mode</b>	<b>Configuring TCP mode</b>
Server	Weighing terminal acting as server E.g., to execute SICS commands from a PC. To do so, the weighing terminal must be configured as Server and the PC must be configured as Client.
Client	Weighing terminal acting as client E.g., to print to a PC or printer. To do so, the weighing terminal must be configured as Client and the PC must be configured as Server.
FreeWeigh	To connect as SICS scale to freeweigh.net
<b>Local Port</b>	<b>Displaying/entering the local port</b>
<b>Remote IP</b>	<b>Displaying/entering the remote IP address</b>
<b>Remote Port</b>	<b>Displaying/entering the remote port</b>
<b>Connect timeout</b>	<b>Setting timeout for connecting</b>
<b>Disconnect timeout</b>	<b>Setting timeout for disconnecting</b>

## 7.6.4 Digital I/Os menu block

Level 1	Level 2	Level 3
Input	Input pin 1 ... Input pin 4	Off, Zero, Tare, Transfer, Switch, Clear, Info, Target, Soffkey 1-1 ... 4-5, Total +, Total -, Switch scale
Output	Ready, Stable, Tare, Zero, < Min weigh, >= Min weigh, Underload, Overload, Star, <= Setpoint 1, > Setpoint 1, <= Setpoint 2, > Setpoint 2, SP.Tolerance-, < Tolerance-, Good range, Target, > Tolerance+, Class 1 ... Class 12, End value, Out of class, < Tot. Lot N, = Tot. Lot N, < Threshold as % of Tol-	<b>Off</b> , Output pin 1 ... Output pin 4
Setpoints	Setpoint 1, Setpoint 2	
Output mode	Continuous, Stable	

### Configuring inputs

- 1 Select an input pin.
- 2 Assign an input signal to the selected input pin.

### Configuring outputs

- 1 Select an output signal.
- 2 Assign an output pin.

### Configuring setpoints

- Enter values for the setpoints.

### Setting output mode

Continuous	Digital outputs are updated continuously
Stable	Digital outputs are updated only when the weight is stable

## 7.6.5 Define templates menu block

Level 1	Level 2	Level 3
Template 1	Line 1	Not used, Header *, Date, Time, Gross, Net, Tare, High resolution, ID1, ID2, ID3, Terminal ID, Terminal location, SNo Terminal, SNo Scale, Star line, New line, Form feed, Target, Tolerance -, Tolerance +, Tolerance type, Deviation, Weight position, APW, Reference count, Quantity, Article, Article description, Article info 1, Article info 2, Article info 3, Record number, Lot, User name, User ID, Consecutive number
...	...	
Template 10	Line 30	

\* The content of these items has to be entered via SICS command.

### Configuring templates

- 1 Select a template.
- 2 Select a line.
- 3 Assign an item.



There are 10 more templates available (Template 11 ... Template 20). Please ask your **METTLER TOLEDO** service technician to configure these templates or create them by yourself using the DatabICS software ([www.mt.com/ind-databics](http://www.mt.com/ind-databics)), if desired.







## 7.7 Maintenance menu block



### 7.7.1 Overview

Level 1	Level 2	Level 3	Level 4
Scale test	Scale 1 ... Scale 4	Routine test	Days
			External test weight
			Weight name
			Tolerance
		Corner load test	Days
			External test weight
			Weight name
			Tolerance
Keyboard test	Perform test?		
Display test	Perform test?		
Tool communication	Port		
	Baudrate		
	Start		
Print menu settings			
Temperature check	Mode	Off, On	
	Temperature	Maximum, Minimum	
Reset all	Perform reset?		

### 7.7.2 Description

Scale test	Testing the selected scale
<b>Routine test</b> <b>Cornerload test</b>	<b>Configuring routine test or cornerload test</b>
Days	Enter test interval. 0 days means no test functionality.
Test weight	Enter the test weight value
Tolerance	Enter the tolerance value
Weight name	Enter the test weight name
	Start routine test with internal/external test weight. For details refer to the Quick Select section.
	Start cornerload test. For details refer to the Quick Select section.
	Delete routine test / cornerload test log file

<b>Keyboard test</b>	<b>Testing the keyboard</b>
Perform test?	<ol style="list-style-type: none"> <li>1 Press  to start the keyboard test.</li> <li>2 Press the keys in the displayed order. <ul style="list-style-type: none"> <li>⇒ If the key works, the device switches to the next key.</li> <li>⇒ The keyboard test is terminated by pressing .</li> </ul> </li> </ol>

<b>Display test</b>	<b>Testing the display</b>
Perform test?	<ol style="list-style-type: none"> <li>1 Press  to start the display test. <ul style="list-style-type: none"> <li>⇒ A checkerboard pattern is displayed.</li> </ul> </li> <li>2 Press any key to invert the checkerboard pattern.</li> <li>3 Press any key to show the colored display.</li> <li>4 Repeat pressing a key until <b>Completed</b> is displayed.</li> <li>5 Press  to leave the display test.</li> </ol>
Note	The display is working properly if all fields are displayed without missing pixels.

<b>Print menu settings</b>	<b>Printout of a list of all menu settings</b>
Print menu settings	<ul style="list-style-type: none"> <li>- Press .</li> <li>⇒ The menu settings are printed out.</li> </ul>

<b>Temperature check</b>	<b>Checking the load cell temperature</b>
Mode	Activating/deactivating the temperature check
Temperature	Setting the admissible maximum and minimum temperature

<b>Tool communication</b>	<b>Testing the communication</b>
Port	Selecting the COM port to be tested
Baudrate	Setting the baudrate for testing
Start	Starting tool communication test

<b>Reset all</b>	<b>Reset all settings to factory setting</b>
Perform reset?	- Reset all settings to factory settings with  .

## 8 Quick Select menu



### 8.1 Quick Select menu overview

The Quick Select menu offers access to logout, routine test and several log files, depending on your configuration.

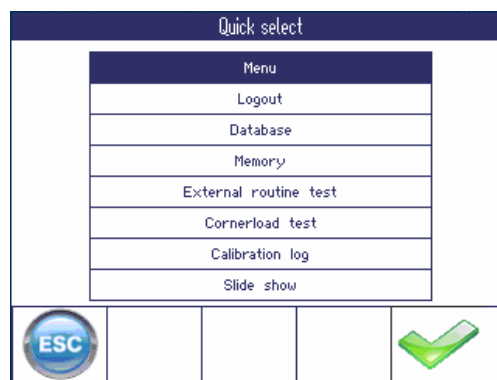
- Press .
  - ⇒ The Quick Select menu is displayed.
  - ⇒ The example shows the Quick Select menu with most of the configuration items.



### 8.2 Entering main menu

- In weighing mode press  and then .
  - ⇒ When working with user management, the menu tree is displayed without password entry.
  - ⇒ When working without user management, password entry is required first.

### 8.3 Logout

#### Prerequisite

User management is activated under `Terminal -> User Management`.

- 
  - Logout is described in the Operation chapter.
  - Always log out when leaving the terminal in order to prevent unauthorized persons from working on it.

## 8.4 Database

### 8.4.1 Internal versus external database

**ICS685 / ICS689** offer an internal database for up to 15,000 articles. Handling of the internal database is described below.

To administer the database externally, the optional computer program DatablCS is available ([www.mt.com/ind-datablcs](http://www.mt.com/ind-datablcs)).

#### DatablCS features



- Administration of article data
- Export/import of databases via .csv file
- Export of the Alibi/Transaction memory via .csv file
- Up to 25 devices can be connected at the same time via Ethernet and/or WLAN

#### DatablCS use cases

- |  |   |
|--|---|
| <b>One central database for several scales</b> | <ul style="list-style-type: none"> <li>• Menu setting: Database access mode = External DB</li> <li>• DatablCS acts as host</li> <li>• The article to work with has to be downloaded from the host to the device</li> <li>• The article information cannot be changed on the device</li> </ul> |
| <b>Managing several databases on a PC</b>      | <ul style="list-style-type: none"> <li>• Each device is working with its own internal database</li> <li>• The internal databases can be backedup and restored via DatablCS</li> </ul>   |

### 8.4.2 (Internal) Database overview

When calling up the database in the Quick Select menu, the following overview is displayed:

- To scroll through the database table use the cursor keys.
- To switch soft key pages use the  /  soft keys.

Database		
Article	Description	Article info 1
-B	J	J
123123	ABCABC	
5		
A		
ANEKBU		
*****		
*****		

The following soft keys are available for editing the database:

**Page 1**



Leave the database, cancel editing



New record



Edit the selected article

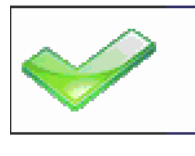

Load the selected article



Show next soft key page

**Page 2**



Delete article



Copy article



Show previous soft key page



Show next soft key page

**Page 3**



Search for an article



Print article



Show previous soft key page

### 8.4.3 Creating a new article

The database is organized in the following 6 pages:

Page 1/6: Article info

Page 2/6: Tare

Page 3/6: Counting

Page 4/6: Checkweighing

Page 5/6: Classifying

Page 6/6: Totalizing



- Use the and to scroll through the pages of an article.
- To store application specific data, the corresponding page must be activated.
- When Counting or Totalizing is activated, an additional page is displayed.

- 1 Press soft key to create a new data record.  
⇒ Page 1/7 – Article is displayed.
- 2 Enter article name and additional article information, if appropriate
- 3 Press the soft key to proceed to the next page.
- 4 Enter the corresponding information, if appropriate.

**Edit article** ABC

Article database: Page 1/7 – Article

G: 0.00 kg    T: 0.00 kg    N: 0.00 kg

Article	
Description	
Article info 1	
Article info 2	
Article info 3	

- 1 To enter application data (Counting, Checkweighing/ Filling, Classifying), set the right upper field **Activate** to On.  
⇒ When **Save article to database?** is displayed, the data record is complete.
- 2 Save the article to the database with the soft key .  
⇒ **Record stored** is displayed briefly and the article overview is displayed.

**Edit article**

Article database: Page 3/7 – Counting / APW    Active  On

G: 1.923 kg    T: 9.029 kg    N: -7.1

Unit type



Off  
 On

## 8.4.4 Editing an existing article / copying an article



### Viewing article

- To view the complete database record, use the cursor keys < or >.

### Calling up article

- Existing article**
- 1 Use the cursor keys  $\wedge$  /  $\vee$  .
  - 2 Press the soft key  to open the selected article.
- Copy article**
- 1 Use the cursor keys  $\wedge$  /  $\vee$  .
  - 2 Press the soft key  to copy the selected article.
  - 3 Edit the copied article.

### Editing the article

- 1 Enter the article data. Confirm each entry with the soft key  and use the cursor key  $\vee$  to proceed to the next field.
- 2 Press the soft key  to proceed to the next page.
- 3 Repeat steps 1 and 2 for the next pages.
- 4 To enter application data (Counting, Checkweighing, Filling, Classifying, Totalizing), set the right upper field Activate to On.
  - ⇒ When **Save article to database?** is displayed, the data record is complete.
- 5 Save the article to the database with the soft key .
  - ⇒ **Record stored** is displayed briefly and the article overview is displayed.



## 8.4.5 Searching and loading an article

### Viewing article







For searching an article, the device offers 3 search fields with individual search criterions.

#### Search fields

- Article
- Article description
- Article info 1 ... Article info 3
- Tare value



#### Criteria

- == (equal)
- < (smaller)
- <= (smaller or equal)
- > (bigger)
- >= (bigger or equal)
- != (unequal)

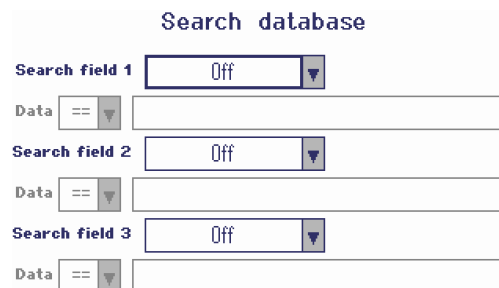
- 1 In the article overview press the soft key .  
⇒ the following search window opens.
- 2 Select item for **Search field 1**.
- 3 Use cursor key  to proceed to the corresponding **Data** field.
- 4 Select the search criterion in the **Data** field.
- 5 Use cursor key  to proceed to the field for entering the search data.
- 6 Enter search data, e.g., an article name.
- 7 Repeat steps 2 to 6 for **Search field 2** and **Search field 3**, if desired.
- 8 Start the search with the soft key .  
⇒ The database table with the matching article(s) is displayed.
- 9 If applicable, use the cursor keys  or  to select the article.
- 10 Load the article with the soft key .  
⇒ Record loaded is displayed briefly.  
⇒ Those applications are active which were set to On in the `Activate` field.



## 8.4.6 Deleting an article

- 1 Select the article to be deleted as described in the previous section.
- 2 Switch to soft key page 2.
- 3 Press the soft key  to delete the selected article.  
⇒ A safety prompt is displayed.
- 4 Press the soft key  to delete the article.

## 8.4.7 Database download/upload

 To download/upload the database from/to an USB stick refer to the menu Application → Database [▶ 93].



## 8.5 Calling up memory log file

Calling up a memory log file is described in the Operation section.

## 8.6 Statistics

Statistics is described in the Totalizing section.

## 8.7 Performing routine test

By performing a routine test you can check the calibration of your scale regularly.

### Prerequisite

Routine test parameters are set under `Maintenance -> Scale test`.

**i** If an interval for the routine test is defined (Days > 0), the device automatically asks you to perform the test.

### Routine test with external weight

- 1 Unload the scale.
- 2 Select `External Routine Test` in the Quick Select menu with the cursor keys `↓ / ↑` and confirm with `↵`.  
⇒ You are asked to put the indicated weight on the platform.
- 3 When the required weight is put on the platform, press `↵`.  
⇒ The routine test is carried out and the test protocol is displayed for a short time.
- 4 To leave the routine test press `↵`.

Routine test passed	
Rec.No	0001
Date & Time	12/11/2014 13:15:29
SNo. Scale	
Scale location	
Scale identification	
User name	ABC
Test weight	15.000 kg
Weight name	A
Tolerance	0.100 kg
Result	15.000 kg

### Routine test with internal weight

Routine test with internal weight is available for **ICS685k-.../f** compact scales only.

- 1 Unload the scale.
- 2 Select `Routine Test` in the Quick Select menu with the cursor keys `↓ / ↑` and confirm with `↵`.  
⇒ The routine test is carried out with the internal calibration weight and a test protocol is displayed for a short time.

**i**

- The results of the routine test are stored in the routine test log file.
- If the determined weight is not within the tolerance, the test protocol is in red. Call the **METTLER TOLEDO** service technician.

## 8.8 Performing corner load test

The corner load test gives additional information on the behaviour of your scale.

### Prerequisite

Corner load test parameters are set under `Maintenance -> Scale test`.

**i** If an interval for the corner load test is defined (Days > 0), the device automatically asks you to perform the test.

- 1 Unload the scale.
- 2 Select `Corner load test` in the Quick Select menu with the cursor keys `▼ / ▲` and confirm with `↵`.
  - ⇒ You are asked to put the indicated weight on the indicated corner of the platform.
- 3 When the required weight is put on the platform, press `↵`.
  - ⇒ The corner load test is carried out for the first corner.
  - ⇒ You are asked to put the indicated weight on the next indicated corner of the platform.
- 4 Repeat step 3 until all corners are tested and the following test protocol is displayed for a short time:

**External test will be performed**

**Put weight in the green section**

Test weight	15.000	kg
Weight name	A	

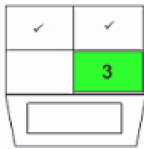

**Corner load test passed**

Rec.No	0001	Date & Time	12/11/2014 13:16:45
User name	ABC	SNo. Scale	
Scale location	Scale identification		
Test weight	15.000	Tolerance	0.100 kg
Weight name	0.100 kgA		
Corner 1	15.000	Deviation	0.000 kg
Corner 2	15.000	Deviation	0.000 kg
Corner 3	15.000	Deviation	0.000 kg
Corner 4	15.000	Deviation	0.000 kg

## 8.9 Calling up routine test / corner load test log files

### Prerequisite

Routine test and/or corner load test parameters are set under Maintenance -> Scale test.

### Viewing test log file

- 1 Select Routine Test Log or Corner load test log in the Quick Select menu with the cursor keys  $\downarrow$  /  $\uparrow$  and confirm with  $\rightarrow$ .  
 ⇒ The routine test / corner load test protocol of the last test is displayed.
- 2 To view other test protocols use the cursor keys  $\downarrow$  /  $\uparrow$ .

Routine test passed	
0001	Record number 0009
0002	Date 24/02/15
0003	Time 14:48:51
0004	User name USER1
0005	Test weight 15.000 kg
0006	Weight name
0007	Tolerance 1.500 kg
0008	Result 15.000 kg
0009	Deviation -0.000 kg

### Printing test log file

- 1 When a routine / corner load test record is displayed, press the soft key .
- 2 In the next screen select either Print current record to print a single record or Print whole memory to print all records.
- 3 Confirm selection with  $\rightarrow$ .  
 ⇒ The routine test log record(s) is(are) printed.

### Deleting routine test / corner load test log file

- i** Deleting routine test / corner load test log files is carried out in the menu under Maintenance -> ... -> Routine test / Corner load test.

## 8.10 Calling up calibration log file

### Prerequisite



Calibration procedures are stored in the calibration log file.

### Viewing calibration log file

- 1 Select `Calibration Log` in the Quick Select menu with the cursor keys `↓ / ↑` and confirm with .
  - ⇒ The calibration protocol of the last calibration is displayed.
- 2 To view other test protocols use the cursor keys `↓ / ↑`.

Calibration passed		
001	Rec.No	002
002	Date	22/03/15
	Time	11:55:45
	SNo. scale	
	User name	USER1
	Test weight	35.00kg
	Weight name	WEIGHT1

### Printing calibration records

- 1 When a calibration record is displayed, press the soft key .
- 2 In the next screen select either `Print selected record` to print a single record or `Print whole memory` to print all records.
- 3 Confirm selection with .
  - ⇒ The calibration record(s) is(are) printed.

## 9 Event and error messages

### 9.1 Error conditions

Error	Cause	Remedy
Display dark	• Backlighting set too dark	- Set backlighting brighter.
	• No power supply	- Check power supply.
	• Unit switched off	- Switch on unit.
	• Power supply cable not plugged in	- Plug in power supply cable.
	• Brief fault	- Switch device off and on again.
Weight display unstable	• Unstable installation location	- Adjust vibration adapter.
	• Draft	- Avoid draft.
	• Unstable weighing sample	- Dynamic weighing.
	• Contact between weighing pan and/or weighing sample and surrounding	- Remedy contact.
	• Power supply fault	- Check power supply
Incorrect weight display	• Incorrect zeroing	- Unload scale, set to zero and repeat weighing operation.
	• Incorrect tare value	- Clear tare.
	• Contact between weighing pan and/or weighing sample and surroundings	- Remedy contact.
	• Weighing platform tilted	- Level weighing platform.
[ ]	• Load plate not on the scale	- Place load plate on the scale.
[ ]	• Weighing range not reached	- Set to zero.
	• Weighing range exceeded	- Unload scale. - Reduce preload.
— — — — —	• Result not yet stable	- If necessary, adjust vibration adapter.
<b>Attention: Approval invalid</b> alternating with metrological data	• Approval was tampered with	- Call <b>METTLER TOLEDO</b> service technician.

## 9.2 Errors and warnings

### Error messages

Error messages contain the following information:

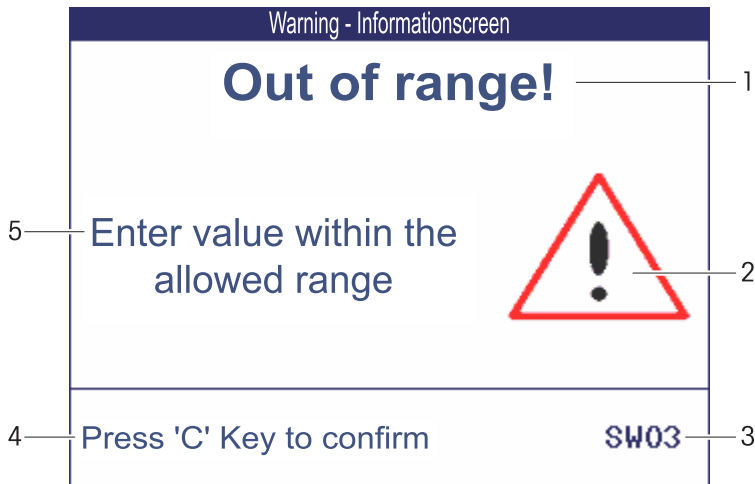

- 1 Error message
- 2 Warning symbol
- 3 Message identifier
- 4 How to clear the message
- 5 Remedy

### Warnings

Warnings are displayed briefly and then disappear automatically.



- 1 Warning message
- 2 Warning symbol
- 3 Warning identifier

## Information

Information is displayed briefly and then disappears automatically.

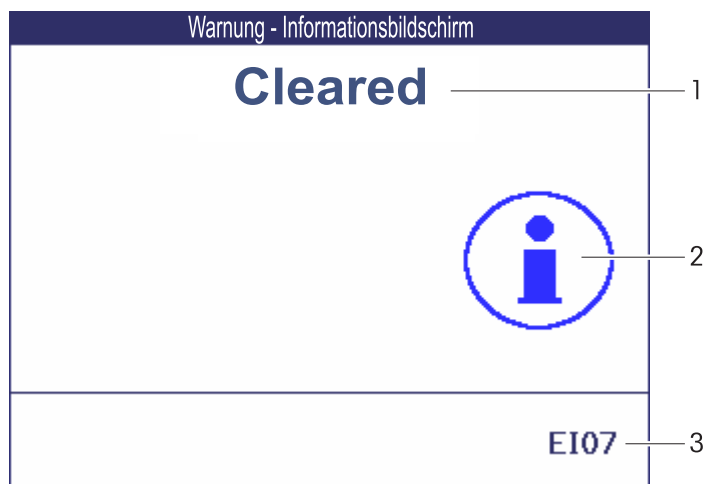

- 1** Info message
- 2** Info symbol
- 3** Info identifier

### 9.3 Smart weighing counter / spanner icon

This weighing instrument features several control functions to monitor the condition of the device.

The **METTLER TOLEDO** service technician can setup and enable these functions.

This helps the user and the **METTLER TOLEDO** service technician to determine how the device is treated and what measures are needed to keep it in a good shape.

If the control functions triggers an alert, a message is shown.

You can confirm the message and continue to work with the weighing instrument. The spanner icon  lights up.

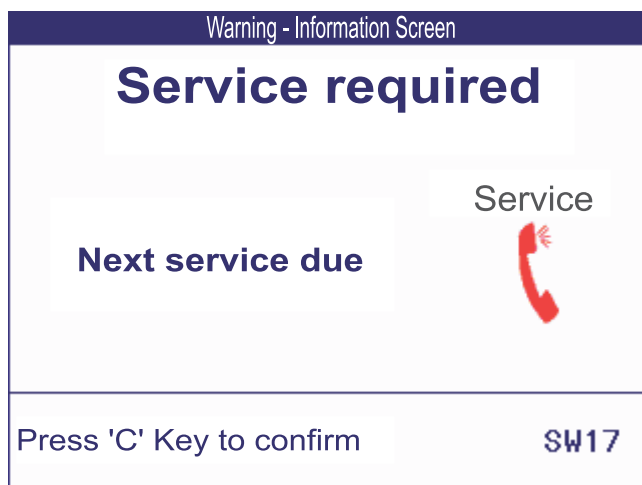

In case of an alert we strongly recommend calling the **METTLER TOLEDO** service technician

- to replace parts which are at the end of lifetime,
- to correct wrong settings,
- to educate operators about proper handling,
- to perform routine service work,
- to reset the alert.

The control functions monitor the following conditions:

- number of weighings
- number of overloads
- maximum weight
- zero commands and zero failures
- battery charging cycles
- power-on time
- date for the next service inspection

### 9.4 Service information

In case you need the **METTLER TOLEDO** service technician, you can read the necessary system and contact information from the device.



- 1 Press **i** twice.  
⇒ System information data are displayed.
- 2 Press **i** again  
⇒ Your contact data are displayed.



## 10 Technical data and accessories

### 10.1 Devices for dry environment

#### 10.1.1 Technical data for weighing terminals for dry environments

ICS685 weighing terminals		
Housing	Aluminium diecast	
Display	LCD liquid crystal graphical display, with back lighting	
Keyboard	Tactile-touch membrane keypad (PET) Scratch-resistant labelling	
Protection type	With power supply connection	IP65
	With built-in storage battery	IP65
	With exchangeable battery	IP5x
	Weighing platform	IP5x / IP65 (option, not for 0.6XS)
Net weight	Weighing terminal	2.0 kg / 4.4 lb
Power supply connection	Direct connection to power supply (supply voltage fluctuation not exceeding $\pm 10\%$ of the rated voltage)	
	Rated voltage	100 ... 240 V AC / 50 ... 60 Hz / 300 mA
	Power cord	approx. 2.5 m / 8.2 ft
Battery operation	Supply of device	12 V  / 2.5 A
	Up to 22 hours of operation possible	
9-28 VDC power supply	Rated voltage	9 ... 28 V  / max. 2.5 A
	Power cord	approx. 5 m / 16 ft, open ends
Battery charger	Ambient conditions	0 ... 40 °C / 32 ... 104 °F, dry environment
Ambient conditions	Application	indoor use only
	Altitude	up to 2,000 m
	Temperature range Class III	-10 ... 40 °C / 14 ... 104 °F
	Temperature range Class II with PBK785 with PBK9-series / PFK9-series	10 ... 30 °C / 50 ... 86 °F 0 ... 40 °C / 32 ... 104 °F
	Overvoltage category	II
	Pollution degree	2
	Humidity	Max. rel. humidity 85 % for temperatures up to 40 °C / 104 °F
W & M approvals	OIML Class II, III, IIII NTEP Class II, III	
Interfaces		
Optional equipment	3 additional optional interfaces possible	
Scale interfaces	up to 4 (incl. SICS scale via RS232, SICSpro scale via RS422/RS485) max. 2 analog scales max. 2 IDNet scales (except F cell, AWU cell, GD16, GD17, Pik)	

## 10.1.2 Technical data for compact scales for dry environments



- The size of the weighing platform (0.6XS, 3XS, 6XS, 3SM, 6SM, 15LA, 35LA) is indicated at the end of the product name, e.g., **ICS685s-3XS/f**.
- Other combinations of weighing range and readability can be adjusted by the **METTLER TOLEDO** service technician on site.
- The table below indicates the factory settings of weighing range and readability.

### Weighing ranges and readability ICS685s-.../f compact scales

- Approved resolution 1 x 6,000 e (OIML, NTEP)
- Non-approved resolutions up to 60,000 d

ICS685s-.../f	3SM	6SM	15LA	35LA
<b>Capacity</b>	3 kg	6 kg	15 kg	35 kg
	6 lb	12 lb	30 lb	60 lb
<b>Readability</b>				
Standard resolution: 6,000 d	0.5 g	1 g	2 g	5 g
	0.001 lb	0.002 lb	0.005 lb	0.01 lb
Optional resolution: 30,000 d	0.1 g	0.2 g	0.5 g	1 g
	0.0002 lb	0.0005 lb	0.001 lb	0.002 lb
Optional resolution: 60,000 d	0.05 g	0.1 g	0.2 g	0.5 g
	0.0001 lb	0.0002 lb	0.0005 lb	0.001 lb
Approved resolution: 6,000 e	0.5 g	1 g	2 g	5 g
	0.001 lb	0.002 lb	0.005 lb	0.01 lb
<b>Repeatability (sd)</b>	0.05 g	0.1 g	0.2 g	0.5 g
	0.0001 lb	0.0002 lb	0.0005 lb	0.001 lb
<b>Linearity</b>	0.1 g	0.2 g	0.5 g	1 g
	0.0002 lb	0.0005 lb	0.001 lb	0.002 lb
<b>Weight</b>	5.5 kg	5.5 kg	7.7 kg	7.7 kg
	12.1 lb	12.1 lb	17.0 lb	17.0 lb

### Weighing ranges and readability ICS685k-.../f and ICS685k-.../DR/f compact scales

- Approved resolution up to 61,000 e (OIML, NTEP)
- Non-approved resolutions up to 610,000 d
- FACT function (Fully Automatic Calibration Technology) calibrates the scale according to temperature changes thus increasing weighing accuracy

ICS685k-.../f	0.6XS	3XS	6XS	6SM	15LA	35LA
<b>Capacity</b>	0.61 kg	3.1 kg	6.1 kg	6.1 kg	15.1 kg	35.1 kg
	1.2 lb	6 lb	12 lb	12 lb	30 lb	60 lb
<b>Readability</b>						
Standard resolution	0.001 g	0.01 g	0.01 g	0.1 g	0.1 g	0.1 g
	0.000002 lb	0.00002 lb	0.00002 lb	0.0002 lb	0.0002 lb	0.0002 lb
Approved resolution	0.01 g	0.1 g	0.1 g	1 g	1 g	1 g
	0.00002 lb	0.0002 lb	0.0002 lb	0.002 lb	0.002 lb	0.002 lb
<b>Repeatability (sd)</b>	0.001 g	0.01 g	0.01 g	0.1 g	0.1 g	0.1 g
	0.000002 lb	0.00002 lb	0.00002 lb	0.0002 lb	0.0002 lb	0.0002 lb
<b>Linearity</b>	0.002 g	0.02 g	0.02 g	0.2 g	0.2 g	0.2 g
	0.000005 lb	0.00005 lb	0.0005 lb	0.0005 lb	0.0005 lb	0.0005 lb
<b>Weight</b>	6.3 kg	5.7 kg	5.7 kg	5.7 kg	9.0 kg	9.0 kg
	13.4 lb	12.6 lb	12.6 lb	12.6 lb	19.8 lb	19.8 lb

ICS685k-.../DR/f	0.6XS	3XS	6XS	6SM	15LA	35LA
<b>Capacity</b>	0.12 kg / 0.61 kg	0.6 kg / 3.1 kg	1.2 kg / 6.1 kg	1.2 kg / 6.1 kg	3 kg / 15.1 kg	3 kg / 15.1 kg
<b>Readability</b>						
Standard resolution	0.001 g / 0.01 g	0.01 g / 0.1 g	0.01 g / 0.1 g	0.1 g / 1g	0.1 g / 1g	0.1 g / 1g
Approved resolution	0.01 g	0.1 g	0.1 g	1 g	1 g	1 g

### Max. mechanical preload without losing capacity

ICS685	3SM	6SM	15LA	35LA
<b>Preload</b>	1.25 kg	3.25 kg	3.32 kg	13.32 kg
	2.76 lb	7.17 lb	7.32 lb	29.37 lb

ICS685	0.6XS	3XS	6XS	6SM	15LA	35LA
<b>Preload</b>	–	1.73 kg	0.73 kg	2.25 kg	20.32 kg	0.32 kg
	–	3.81 lb	1.61 lb	4.96 lb	44.80 lb	0.71 lb

### 10.1.3 Operating life with battery

The operating life during battery operation varies depending on the intensity of use, the configuration and the connected scale.

The following approximate values apply with standard RS232 interface and the brightness set to 5.

Weighing platform	Weighing terminal type	Conditions	Duration
Strain gauge weighing platform	ICS685g	WLAN, continuous operation	16 h
		USB host, continuous operation	16 h
MonoBloc® weighing platform	ICS685k	WLAN, continuous operation	10 h
		USB host, continuous operation	10 h

### 10.1.4 Dimensional drawings for devices for dry environments

#### ICS685 weighing terminal

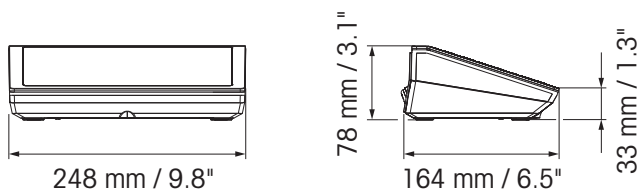

#### ICS685 compact scale with XS or SM weighing platform

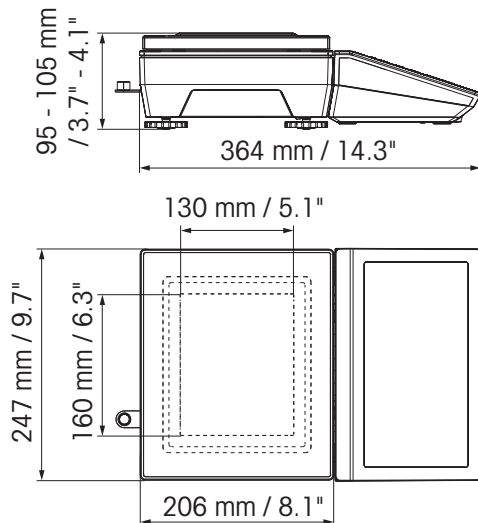

**ICS685 compact scale with XS weighing platform and windshield**

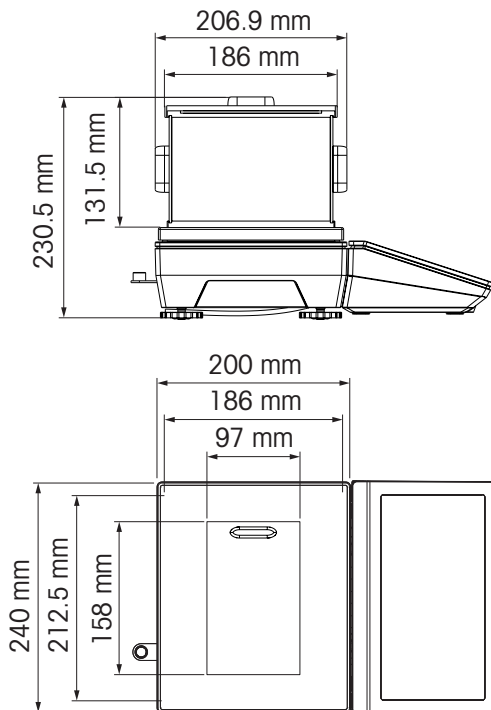

**ICS685 compact scale with LA weighing platform**

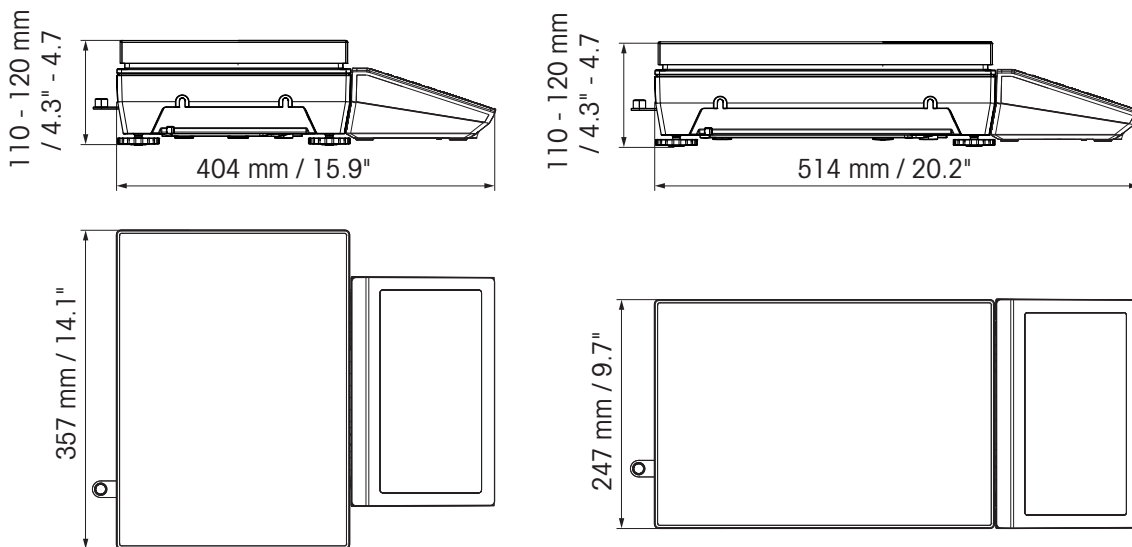



### 10.1.5 Accessories for dry environments

Accessories for ICS685	Order no.
Printer RS-P25/01 (for Europe only)	11 124 300
Printer RS-P26/01 (for Europe only)	11 124 304
Printer RS-P28/01 (for Europe only)	11 124 301
Printer APR510 Direct thermal Label Printer, 203 dpi	64 090 256
Printer APR510 Thermal Transfer Label Printer, 203 dpi	64 090 257
Printer APR510 Direct thermal Label Printer, 300 dpi	64 090 258
Printer APR510 Thermal Transfer Label Printer, 300 dpi	64 090 259
Printer APR710 Direct thermal Label Printer, 203 dpi	64 688 858
Printer APR710 Thermal Transfer Label Printer, 203 dpi	64 688 859
Printer APR710 Direct thermal Label Printer, 300 dpi	64 688 861
Protective cover for the weighing terminal, set of 5 pieces	30 032 638
Auxiliary display AD-RS-M7 (requiring cable 22 023 506)	12 122 381
Charging station for Battery pack (lithium ion)	30 093 236
Battery pack (lithium ion, IP54)	30 093 237
Windshield for ...XS weighing platforms	72 262 929
Wall bracket	30 032 637
Support for wheeled bench stand	22 023 460
Column for PBA655, PBD655 and ICS4_5 / ICS685 compact scales (requires wall bracket 30 032 637)	
Height 330 mm / 1.3 ft	72 198 699
Height 660 mm / 2.6 ft	72 198 700
Floor stand, height 1000 mm / 3.3 ft	
Painted steel	22 023 451
Stainless steel	22 023 503
Relaybox 4, for Digital I/O	22 011 967
Power supply for Relaybox 4	00 505 544

<b>Cables and plugs for ICS685</b>	<b>Order no.</b>
<b>Cables</b>	
Cable M12 USB Female Type A, USB Host	
0.2 m / 0.7 ft	22 017 604
3 m / 10 ft	22 017 608
Cable M12 USB Male Type A, USB device, 3 m / 10 ft	22 018 967
Cable M12 RS232 Female Sub D 9 pin (crossed; used for PC)	22 017 601
Cable M12 RS232 Male Sub D 9 pin (not crossed; used for SICS scale)	22 017 602
Cable M12 RS422/485, open ends	22 017 603
Cable M12 Digital I/O, open ends	22 018 969
Cable M12 Ethernet RJ45	
5 m / 16 ft	22 017 610
20 m / 66 ft	22 017 614
Cable for auxiliary display AD-RS-M7	22 023 506
RS232 extension 0.5 m / 1.6 ft, incl. 5 V and 12 V	30 035 358
RS232 SICS (cross, M12 plug male / M12 male) 3 m	22 023 528
RS422/485 extension kit	22 023 698
SICSpro extension (M12 male / M12 female)	
3 m / 10 ft	22 023 696
10 m / 32 ft	30 024 759
SICSpro extension (M12 male / open end) 5 m / 16 ft	30 024 768
Cable for GA46	
0.4 m / 1.4 ft	22 018 978
2.5 m / 8 ft	22 018 979
<b>Plugs</b>	
RS232 Counter plug (8 pin; for compact scales, extension 30 035 358 required)	22 022 056
Ethernet Counter plug (4 pin, D; not for compact scales)	22 022 058
USB Device Counter plug (4 pin, A; not for compact scales)	22 022 059

## 10.2 Devices for wet environment

### 10.2.1 Technical data for weighing terminals for wet environments

ICS689 weighing terminals		
Housing	Stainless steel 1.4301 or AISI 304	
Display	LCD liquid crystal graphical display, with back lighting	
Keyboard	Tactile-touch membrane keypad (PET) Scratch-resistant labelling	
Protection type	Terminal	IP68/IP69k
	Standard weighing platform	IP65
	Weighing platform with option potted stainless steel load cell	IP65/IP67
	Weighing platform with option hermetically sealed stainless steel load cell	IP68/IP69k
Net weight	Weighing terminal	2.0 kg / 4.4 lb
	<b>ICS689g.../c</b>	3.2 kg / 7.1 lb + weight of the weighing platform
Power supply connection	Direct connection to power supply (supply voltage fluctuation not exceeding $\pm 10\%$ of the rated voltage)	
	Rated voltage	100 ... 240 V AC 50 ... 60 Hz 300 mA
Battery operation	Supply of device	12 V  / 2.5 A
	Up to 22 hours of operation possible	
9-28 VDC power supply	Rated voltage	9 ... 28 V  / max. 2.5 A
	Power cord	approx. 5 m / 16 ft, open ends
Battery charger	Ambient conditions	0 ... 40 °C / 32 ... 104 °F dry environment
Ambient conditions	Application	indoor use only
	Altitude	up to 2,000 m
	Temperature range Class III	-10 ... 40 °C / 14 ... 104 °F
	Temperature range Class II	0 ... 40 °C / 32 ... 104 °F
	Overvoltage category	II
	Pollution degree	2
	Humidity	Max. rel. humidity 80 % for temperatures up to 40 °C / 104 °F
W & M approvals	OIML Class II, III, IIII NTEP Class II, III	
Interfaces		
Optional equipment	3 additional optional interfaces possible	
Scale interfaces	up to 4 (incl. SICS scale via RS232, SICSpro scale via RS422/RS485) max. 2 analog scales max. 2 IDNet scales (except F cell, AWU cell, GD16, GD17, Pik)	



## 10.2.2 Technical data for terminal and platform combinations for wet environments



- The size of the weighing platform (A, BB, B, BC, CC, QA, QB, QC) is indicated at the end of the product name, e.g., **ICS689g-QA6**.
- Other combinations of weighing range and readability can be adjusted by the **METTLER TOLEDO** service technician on site.
- The table below indicates the factory settings of weighing range and readability.

### Weighing ranges and readability

Model	A3	A6 / QA6	A15 / QB15	BB30 / B30 / QB30
Weighing range	1.5 kg / 3 kg	3 kg / 6 kg	6 kg / 15 kg	15 kg / 30 kg
	2.5 lb / 5 lb	5 lb / 10 lb	10 lb / 25 lb	25 lb / 50 lb
Readability	0.5 g / 1 g	1 g / 2 g	2 g / 5 g	5g / 10 g
	0.0005 lb / 0.001 lb	0.001 lb / 0.002 lb	0.002 lb / 0.005 lb	0.005 lb / 0.01 lb

Model	BB60 / B60 / BC60 / CC60 / QB60 / QC60	B150 / BC150 / CC150 / QC150	BC300 / CC300	CC600
Weighing range	30 kg / 60 kg kg	60 kg / 150 kg kg	150 kg / 300 kg	300 kg / 600 kg
	50 lb / 100 lb	100 lb / 250 lb	250 lb / 500 lb	500 lb / 1000 lb
Readability	10 g / 20 g	20 g / 50 g	50 g / 100 g	100 g / 200 g
	0.01 lb / 0.02 lb	0.02 lb / 0.05 lb	0.05 lb / 0.1 lb	0.1 lb / 0.2 lb

### Operation limits – maximum static safe load

Model	a – center load	b – side load	c – corner load	
<b>A</b>	30 kg	20 kg	10 kg	
	60 lb	40 lb	20 lb	
<b>BB</b>	100 kg	70 kg	35 kg	
	200 lb	140 lb	70 lb	
<b>B</b>	200 kg	140 kg	75 kg	
	400 lb	280 lb	150 lb	
<b>BC</b>	400 kg	300 kg	150 kg	
	800 lb	600 lb	300 lb	
<b>CC</b>	700 kg	400 kg	200 kg	
	1400 lb	800 lb	400 lb	
<b>QA</b>	15 kg	10 kg	5 kg	
	30 lb	20 lb	10 lb	
<b>QB</b>	100 kg	70 kg	35 kg	
	200 lb	140 lb	70 lb	
<b>QC</b>	200 kg	140 kg	75 kg	
	400 lb	280 lb	150 lb	

### Weights, approximate values

Model	Weight	Model	Weight
<b>A</b>	5.2 kg	<b>CC</b>	35.0 kg
	11.5 lb		77.2 lb
<b>BB</b>	7.4 kg	<b>QA</b>	4.1 kg
	16.3 lb		9.0 lb
<b>B</b>	12.7 kg	<b>QB</b>	7.8 kg
	28.0 lb		17.2 lb
<b>BC</b>	26.5 kg	<b>QC</b>	13.1 kg
	58.4 lb		28.9 lb

### Length of load cell cable for ICS689g-.../t

Weighing range	Length in m	Length in ft
up to 30 kg / 50 lb	1.5	5
60 kg / 100 lb and higher	2.5	8

### 10.2.3 Operating life with battery

The operating life during battery operation varies depending on the intensity of use, the configuration and the connected scale.

The following approximate values apply with standard RS232 interface and the brightness set to 5.

Weighing platform	Conditions	Duration
With 1 strain gauge load cell, e.g., <b>ICS689g-A15...</b>	Continuous operation	25 h
With 4 strain gauge load cells, e.g., a floor scale	Continuous operation	22 h
With PBK98_/PFK98_	Continuous operation	14 h

## 10.2.4 Dimensional drawings for devices for wet environments

### ICS689 weighing terminal

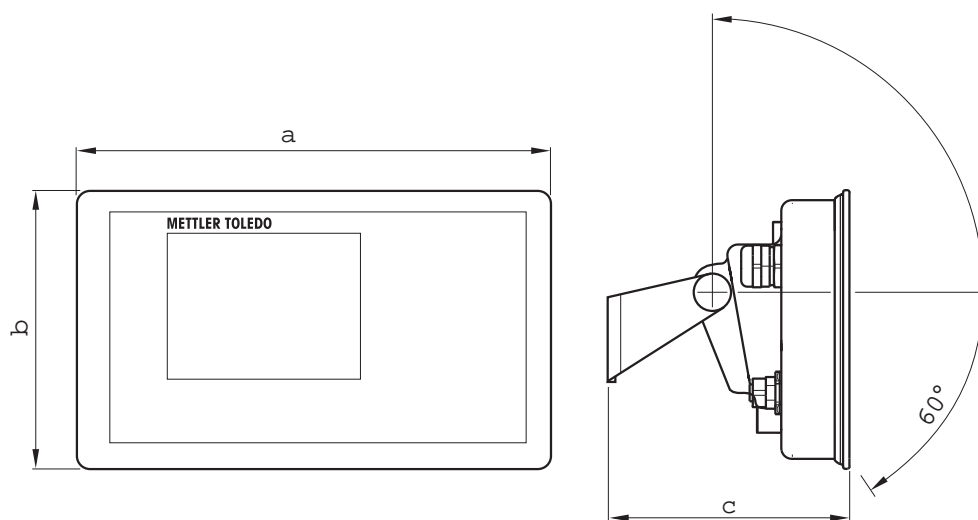

Dimension	[mm]	["]
<b>a</b>	260	10.24
<b>b</b>	170	6.70
<b>c</b>	114	4.49

## Weighing platforms for ICS689 terminal and platform combinations

Front view

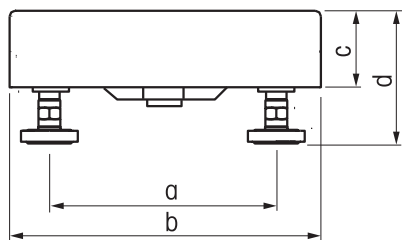

Side view

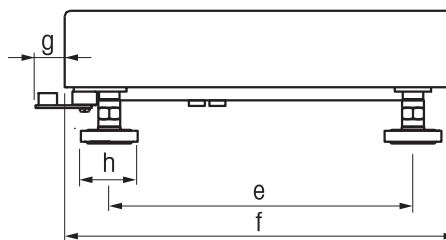

Dim.	A		BB		B		BC	
	[mm]	["]	[mm]	["]	[mm]	["]	[mm]	["]
<b>a</b>	175	6.89	235	9.25	335	13.19	435	17.13
<b>b</b>	240	9.45	300	11.81	400	15.75	500	19.69
<b>c</b>	56	2.20	57	2.24	57	2.24	70	2.76
<b>d</b>	95	3.74	97	3.82	100	3.94	108	4.25
<b>e</b>	235	9.25	335	13.81	435	17.13	587	23.11
<b>f</b>	300	11.81	400	15.75	500	19.69	650	25.59
<b>g</b>	22	0.87	16	0.59	15	0.59	15	0.59
<b>h</b>	Circle diameter: 30 mm / 1.18 " ; diagonal: 34 mm / 1.34 "							

Dim.	CC		QA		QB		QC	
	[mm]	["]	[mm]	["]	[mm]	["]	[mm]	["]
<b>a</b>	503	19.80	170	6.69	233	9.17	392	15.43
<b>b</b>	600	23.62	229	9.02	305	12.01	457	17.99
<b>c</b>	79	3.11	56	2.20	57	2.24	60	2.36
<b>d</b>	130	5.12	95	3.74	108	4.25	100	3.94
<b>e</b>	724	28.50	170	6.69	245	9.65	397	15.63
<b>f</b>	800	31.50	229	9.02	305	12.01	457	17.99
<b>g</b>	21	0.83	22	0.87	15	0.59	15	0.59
<b>h</b>	Circle diameter: 30 mm / 1.18 " ; diagonal: 34 mm / 1.34 "							

ICS689g-.../f terminal and platform combination

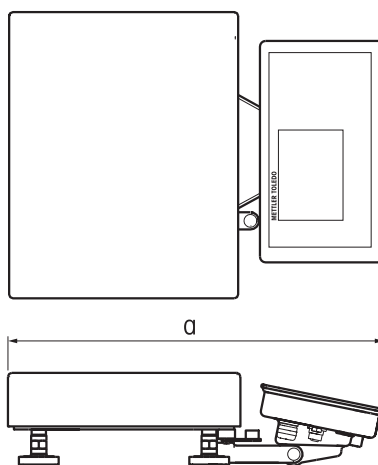

	A		BB		B		BC	
Dim.	[mm]	["]	[mm]	["]	[mm]	["]	[mm]	["]
<b>a</b>	418	16.46	485	19.09	581	22.87	681	26.81

	CC		QA		QB		QC	
Dim.	[mm]	["]	[mm]	["]	[mm]	["]	[mm]	["]
<b>a</b>	772	30.39	407	16.02	489	19.25	640	25.10

### ICS689g-.../c terminal and platform combination

The size of the weighing platform (A, BB, B, BC, CC, QA, QB, QC) is indicated at the end of the product name, e.g., **ICS689a-QA6**.

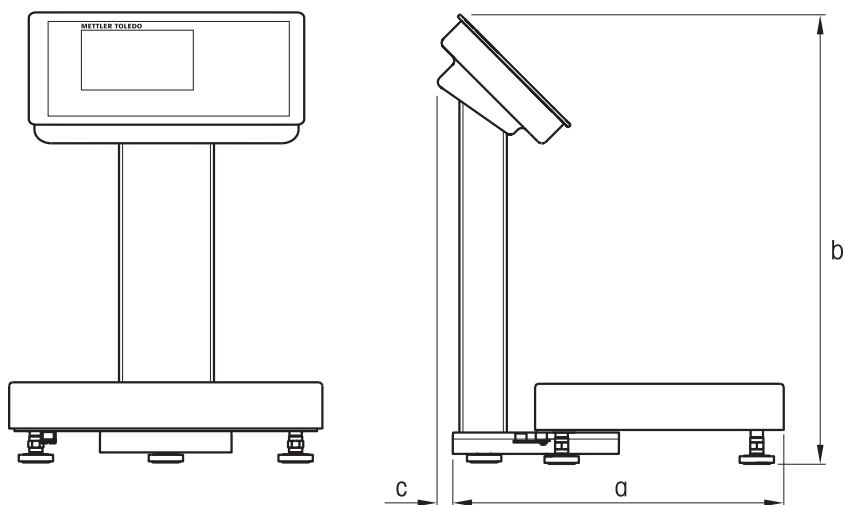

Dim.	A		BB		B		BC	
	[mm]	["]	[mm]	["]	[mm]	["]	[mm]	["]
<b>a</b>	337	13.27	404	15.91	500	19.69	600	23.62
<b>b</b>	412 mm / 16.22 "							
<b>c</b>	34 mm / 1.34 "							

Dim.	CC		QA		QB		QC	
	[mm]	["]	[mm]	["]	[mm]	["]	[mm]	["]
<b>a</b>	691	27.2	326	12.83	408	16.06	559	22.01
<b>b</b>	412 mm / 16.22 "							
<b>c</b>	34 mm / 1.34 "							

## 10.2.5 Accessories for wet environments

Accessories for ICS689	Order no.
GA46 printer, RS232, incl. 8-pin M12 plug cable 2.5 m / 8.2 ft cable 0.4 m / 1.3 ft	22 019 925 22 019 926
<b>I/O accessories</b>	
Relaybox 4, for Digital I/O	22 011 967
Power supply for Relaybox 4	00 505 544
<b>Mechanical parts</b>	
Protective cover for terminals <b>ICS689</b> , set of 3 pieces	22 021 109
Stand <b>ICS689</b> , for .../t version or terminal with PBA226, PBA426, PBA429 Height 120 mm / 0.4 ft Height 330 mm / 1.1 ft Height 660 mm / 2.2 ft Height 900 mm / 3.0 ft	72 219 393 72 198 702 72 198 703 72 198 704
Stand <b>ICS689</b> for PBK, PFK, MA, MD and DB Platforms, height 330 mm / 1.1 ft	22 014 836
Bench stand <b>ICS689</b> for scale bench 00 503 632 or 00 504 854, height 500 mm / 1.6 ft	22 014 835
Floor stand <b>ICS689</b> , height 1000 mm / 3.3 ft	22 014 834
Standbase for floor stand	22 011 982
Wall bracket <b>ICS689</b> , inclinable and swivelling	22 014 833
Desk mounting plate, for terminal and .../t version only	22 021 111

Cables and plugs for ICS689	Order no.
<b>Cables</b>	
RS232 cable for SICS scale, 8 pin M12 <-> 9 pin sub D plug, 3 m / 10 ft	22 021 088
RS232 cable for PC, 8 pin M12 <-> 9 pin sub D receptacle, 3 m / 10 ft	22 021 087
RS232 extension 0.5 m / 1.6 ft, incl. 5 V and 12 V	30 035 358
RS422/RS485 cable, 6 pin M12 <-> open ends, 3 m / 10 ft	22 021 089
Ethernet cable, 4 pin M12 coding D <-> RJ45	
5 m / 16.4 ft	22 021 090
20 m / 65.6 ft	22 021 091
USB cable, connection to PC, 4 pin M12 coding A <-> USB series A plug, 3 m / 10 ft	22 021 088
Cable to connect Digital I/O option with relay box, 12 pin M12 <-> open ends, 10 m / 32.8 ft	22 021 093
USB Device cable, 3 m / 10 ft	22 021 092
USB Host cable, M12 USB female type A	
0.2 m / 0.7 ft	30 093 252
3 m / 10 ft	30 093 253
<b>Plugs</b>	
RS232 counter plug, 8 pin M12 (for .../f versions extension 30 035 358 required)	22 021 105
Ethernet counter plug, 4 pin, coding D, M12 (not for .../f versions)	22 021 107
USB Device counter plug, 4 pin, coding A, M12 (not for .../f versions)	22 021 108
<b>Adapters</b>	
Use already installed cables/plugs with our new <b>ICS689</b> M12 plug	
RS232 adapter, 8 pin M12 plug <-> 8 pin Binder receptacle, 0.2 m / 0.7 ft	22 021 094
RS422/485 extension kit	22 023 698
RS485 adapter, 6 pin M12 plug <-> 6 pin Binder receptacle, 0.2 m / 0.7 ft	22 021 095
Ethernet adapter, 4 pin coding D M12 plug <-> 16 pin Binder receptacle, 0.2 m / 0.7 ft	22 021 096
USB Device adapter, 4 pin coding A M12 plug <-> 16 pin Binder receptacle, 0.2 m / 0.7 ft	22 021 097
Digital I/O adapter, 12 pin M12 plug <-> 19 pin Binder receptacle, 0.2 m / 0.7 ft	22 021 098



## 10.3 General technical data

### 10.3.1 Applications

- Weighing
- Piece counting
- Over/Under Checkweighing
- Filling
- Classifying
- Totalizing
- Prompting
- Average weighing
- Internal database with up to 5000 records
- Alibi log file
- Routine test function
- Calibration log file
- User management

### 10.3.2 Analog scale interface

Impedance	≥ 87.5 Ohm, e.g., 1 x 350 Ohm or 4 x 350 Ohm
Excitation	3.3 V DC
Sensitivity	2 to 3 mV/V
Max. resolution	7,500 e (OIML) 300,000 d (non approvable)
Min. verification interval	0.264 μV/e

### 10.3.3 Assignment of the interface connections

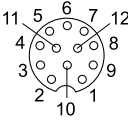
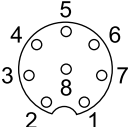
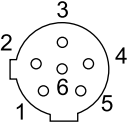
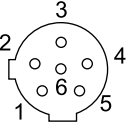
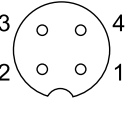
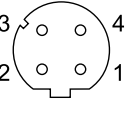
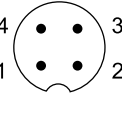
	Digital I/O	RS232	RS422	RS485	USB Device USB Host	Ethernet	Power
<b>Socket</b>							
<b>Pin 1</b>	In 0	CTS	TxD	T/RxD	+5 V *	TD+	+12 V *
<b>Pin 2</b>	In 1	TxD	TxD-	T/RxD-	D-	RD+	+12 V *
<b>Pin 3</b>	In 2	RTS	RxD	-	GND	TD-	GND
<b>Pin 4</b>	In 3	RxD	+12 V *	+12 V *	D+	RD-	GND
<b>Pin 5</b>	In_GND	+12 V *	GND	GND			
<b>Pin 6</b>	Out 0	+5 V *	RxD-	-			
<b>Pin 7</b>	Out 1	-					
<b>Pin 8</b>	Out 2	GND					
<b>Pin 9</b>	Out 3						
<b>Pin 10</b>	Out_GND						
<b>Pin 11</b>	+12 V *						
<b>Pin 12</b>	GND						

\* max. 0.5 A

## 11 Appendix

### 11.1 Metrological information

Scales that have been factory-calibrated have a label indicating this on the packaging.



Scales with a green M on the type plate are ready for operation.

Scales that are calibrated in two stages have a label indicating this on the packaging.



These scales have only been calibrated in a first stage (declaration of conformity in accordance with EN 45501-8.2). The second stage of the calibration must be done on-site by authorized service personnel. Please contact your local representative.

**i** Medium accuracy scales that are used in commerce where certified calibration is required must be calibrated and certified.

Observe the respective measurement data guidelines in your country.

### 11.2 Table of Geo Code values

For weighing instruments verified at the manufacturer's, the Geo Code value indicates the country or geographical zone for which the instrument is verified. The Geo Code value set in the instrument (e.g. "Geo 18") appears briefly after switching on.

Table "Geo Code values 3000e" shows the Geo Code values for European countries.

Table "Geo Code values 6000e/7500e" shows the Geo Code values for different gravitation zones.

#### Geo Code values 3000 e, OIML Class III (European Countries)

Country	Geographical latitude	Geo Code	Country	Geographical latitude	Geo Code
Austria	46°22' – 49°01'	18	Liechtenstein	47°03' – 47°14'	18
Belgium	49°30' – 51°30'	21	Lithuania	53°54' – 56°24'	22
Bulgaria	41°41' – 44°13'	16	Luxemburg	49°27' – 50°11'	20
Croatia	42°24' – 46°32'	18	Netherlands	50°46' – 53°32'	21
Czechia	48°34' – 51°03'	20	Norway	57°57' – 64°00'	24*
Denmark	54°34' – 57°45'	23		64°00' – 71°11'	26
Estonia	57°30' – 59°40'	24	Poland	49°00' – 54°30'	21
Finland	59°48' – 64°00'	25*	Portugal	36°58' – 42°10'	15
	64°00' – 70°05'	26	Romania	43°37' – 48°15'	18
France	41°20' – 45°00'	17	Slovakia	47°44' – 49°46'	19
	45°00' – 51°00'	19*	Slovenia	45°26' – 46°35'	18
Germany	47°00' – 55°00'	20	Spain	36°00' – 43°47'	15
Greece	34°48' – 41°45'	15	Sweden	55°20' – 62°00'	24*
Hungary	45°45' – 48°35'	19		62°00' – 69°04'	26
Iceland	63°17' – 67°09'	26	Switzerland	45°49' – 47°49'	18
Ireland	51°05' – 55°05'	22	Turkey	35°51' – 42°06'	16
Italy	35°47' – 47°05'	17	United Kingdom	49°00' – 55°00'	21*
Latvia	55°30' – 58°04'	23		55°00' – 62°00'	23

\* factory setting

**Geo Code values 6000 e / 75000 e, OIML Class III (Altitude < 1000 m)**

Geographical latitude	Geo Code	Geographical latitude	Geo Code
00°00' – 12°44'	18	43°26' – 47°51'	18
05°46' – 17°10'	21	45°38' – 50°06'	22
12°44' – 20°45'	16	47°51' – 52°22'	20
17°10' – 23°54'	18	50°06' – 54°41'	21
20°45' – 26°45'	20	52°22' – 57°04'	24*, 26
23°54' – 29°25'	23	54°41' – 59°32'	21
26°45' – 31°56'	24	57°04' – 62°09'	15
29°25' – 34°21'	25*, 26	59°32' – 64°55'	18
31°56' – 36°41'	17, 19*	62°09' – 67°57'	19
34°21' – 38°58'	20	64°55' – 71°21'	18
36°41' – 41°12'	15	67°57' – 75°24'	15
38°58' – 43°26'	19	71°21' – 80°56'	24*, 26
41°12' – 45°38'	26	75°24' – 90°00'	18

\* factory setting

### 11.3 Disposal

In accordance with the requirements of European Directive 2002/96 EC on Waste Electrical and Electronic Equipment (WEEE), this device may not be disposed of with domestic refuse. This also applies for countries outside the EU in accordance with their respective national regulations.



- Please dispose of this product in accordance with local regulations for the separate collection of waste electrical and electronic equipment.

Should you have any questions, please contact the corresponding authorities or the dealer from whom this device was purchased.

If this device is passed on (for example for further private or commercial/industrial use), this regulation is also to be passed on.

Many thanks for your contribution to the protection of the environment.

#### Battery disposal

Batteries contain heavy metals and therefore cannot be disposed of in the normal refuse.

- Observe local regulations on the disposal of materials that are hazardous to the environment.

## 11.4 Protocol printouts

Examples of what can be adjusted (GA46 printouts, in English)

Printout with header and identification data

```

METTLER TOLEDO
Tel. +49 7431 140
Germany
www.mt.com
Date          27/04/2015
Time          21:50:48
ID1           Company ABC
ID2           67195 Town
Net           0.57 kg
Tare          0.82 kg
Gross         1.39 kg
    
```

Over/Under Checkweighing default printout

```

Position      <Tolerance
METTLER TOLEDO
Tel. +49 7431 140
Germany
www.mt.com
Date          08/01/2015
Time          00:02:53
ID1           Company ABC
ID2           67195 Town
Gross         2.090 kg

Target        90 PCS
Tol -         1 PCS
Tol +         1 PCS
Tol.Type      Relative
Dev.          -3 PCS
    
```

Piece counting

```

Date          08/01/2015
Time          00:06:31
Net           0.700 kg
Quantity      29 PCS
APW           23.96766 g
    
```

Over/Under Checkweighing minimum printout

```

Position      >Tolerance
Net           0.925 kg
    
```

Classifying – standard printout

Class Lobster Grade A

```

METTLER TOLEDO
Tel. +49 7431 140
Germany
    
```

```

Date          16/05/2015
Time          16:07:23
Customer      Company ABC
City          12345 Town
Net           0.44 kg
Tare          0.35 kg
Gross         0.79 kg
    
```

```

Class info    1
              (0.10 kg - 0.99 kg)
    
```

Classifying – minimum printout

```

Class          Grade A
Class info     2
              (1.00 kg - Max)
Net           1.21 kg
    
```

## Index

### A

Accessories	
for dry environment	134
for wet environment	143
Application	
Clever print	82
Average weighing	
Operation	34
Settings	82

### C

Calibration	73
Calibration log file	124
Classifying	
Class definition	58
Display	59
Procedure	59
Settings	89
Cleaning	
in dry environment	45
in wet environment	45
Clever print	33, 82
Connections	
Power supply	26
Weighing platform	26
Corner load test	122
Counting	
APW optimization	85
Auto clear APW	84
Autosampling	84
Bulk scale	85
Counting accuracy	85
Counting system	85
Procedure	47
Reference scale	85
Total count	85
Custom unit	84

### D

Database	
Internal	117
Quick Select menu	116
Settings	93
Digital I/Os	111
Dimensional drawings	
Devices for dry environment	132
Devices for wet environment	139
Display	
3-line mode	10
Metrological data line	13
Settings	99
Symbols and info line	14
Units	74, 77
Update	79
Weight value	13
Dynamic weighing	
Operation	34
Settings	82

### E

Energy save	98
Error conditions	125
Error messages	126
External input	
Entry	35
Settings	108

### F

FACT	
Settings	75
Symbol	14
Filling	
Procedure	55
Quickstart	56
Subtractive weighing	56
Target values	54
To zero	57
Tolerance type	53
Filter	75, 79

<b>G</b>		<b>M</b>	
Geo code		Maintenance	113
Display	29	Memory	
Values	146	Backup	92
<b>H</b>		Mode	92
High resolution	35	Menu	
Hygienically sensitive areas	28	Analog scale	71
<b>I</b>		Application	81
Identification	91	Communication	102
Identifications		Display	68
Scale data	71, 77	IDNet Scale	77
Terminal data	98	Maintenance	113
Weighing data	35	Operation	67
Info key		Operator menu	67
Displaying information	33	Scale	70
Settings	99	Supervisor menu	67
Information	127	Metrological data line	13
Interfaces		Metrological information	146
Pin assignment	145	MinWeigh	
<b>K</b>		Settings	75, 79
Keyboard		Symbol	14
Function keys	15	<b>O</b>	
Settings	99	Over/Under Checkcounting	
Soft keys	16	Target values	54
<b>L</b>		Over/Under Checkweighing	
Levelling	25	Display	88
Linearization	73	Output	87
Location	25	Procedure	55
Login	29	Quick start	56
Logout	29, 115	Subtractive weighing	56
		Target values	54
		To zero	57
		Tolerance type	53
		<b>P</b>	
		Printing	33
		Clever print	33
		Printout configuration	81
		Prompt	
		Additive tare	41
		Hands free	39
		Multi tare	40
		Sample/Tare	38
		Take away	42
		Tare/Sample	37
		Protocol printouts	148

## Q

Quick Select menu	115
-------------------	-----

## R

Reset	
Application	95
Reset all	114
Scale	76, 79
Terminal	101
Resolution	74
Restart	74, 78
Routine test	121

## S

Safety instructions	7
Service information	128
Smart weighing counter	128
Spanner icon	9, 128
Statistics	65, 91
Storage battery	27
Straight weighing	29, 81
Supervisor menu access	100
Switching on/off	29
Switching scales	36
Switching units	30

## T

Taring	
Automatic	31
Automatic clearing the tare	30
Chain tare	31
Clearing the tare	30
Manual	30
Settings	74, 78
Tare preset	32
Technical data	
Compact scales	130
Terminal and platform combinations	137
Weighing terminals for dry environment	129
Weighing terminals for wet environment	136
Templates	
Assigning	81
Defining	112
Testing	
Communication	114
Display	114
Keyboard	114
Scale	113
Totalization	61, 90

## U

User management	100
-----------------	-----

## V

Verification test	46
-------------------	----

## W

Warning	126
---------	-----

## Z

Zeroing	
Automatic	30
Manual	30
Settings	74, 78







**GWP®**

Good Weighing Practice™

GWP® is the global weighing standard, ensuring consistent accuracy of weighing processes, applicable to all equipment from any manufacturer. It helps to:

- Choose the appropriate balance or scale
- Calibrate and operate your weighing equipment with security
- Comply with quality and compliance standards in laboratory and manufacturing

▶ [www.mt.com/GWP](http://www.mt.com/GWP)

**www.mt.com**

Further information

**Mettler-Toledo (Albstadt) GmbH**

D-72458 Albstadt

Tel. +49 7431-14 0

Fax +49 7431-14 232

[www.mt.com](http://www.mt.com)

Subject to technical changes.

© Mettler-Toledo (Albstadt) GmbH 04/2015

30243688B en



\* 3 0 2 4 3 6 8 8 \*