

APL3600T – 12.1” Touch-Panel PC

Available with WinGP





8 GB Bootable CompactFlash® Card



16-128GB Solid State Drive

12.1-inch TFT Color LCD Touch-Panel Computer

APL3600T

12.1" -inch

CPU: Intel® Celeron® M 1.86GHz or Intel® Core™ Duo 2.0GHz

DC 24V

AC100/240V

SVGA

12.1" -inch













Features:

- 12.1" (SVGA 800 x 600) TFT touch-panel computer
 - Intel® Core™ Duo 2.0GHz or Intel® Celeron® M 1.86GHz CPU
 - 250 GB Hard Drive, Solid State Drive or bootable Compact Flash
 - DVD-RW standard
 - Reliability, Availability, Serviceability (RAS) Remote Health Monitor
 - Data protection – RAID1 hard disk option
 - RoHS directive-conforming
- IP65f, NEMA 4/4x/12 Rated
 - UL 1604, Class I, Div 2, Groups A, B, C, D
 - SSD (Solid State Drive) for Reliability and faster data access
- #### Open HMI WinGP Option
- Use PC as on-demand touch-screen HMI
 - Allows third-party applications to run concurrently
 - SPC, vision, SCADA, MRP
 - Expands PC hardware and data connectivity options

Performance Specifications

	Performance	Standard
Base Model	APL3600-TA-CD2G APL3600-TD-CD2G	APL3600-TA-CM18 APL3600-TD-CM18
CPU	Intel® Core™ Duo 2.0GHz	Intel® Celeron® M 1.8GHz
Supported OS	Windows® XP Pro / XP ML	Windows® XP Pro / XP ML
Standard Memory	1GB/ 2GB/ 4GB	
Maximum Memory	4GB (DIMM socket x 2)	
Graphics Display Resolution	SVGA (800 x 600 pixels)	
Video Memory	Max 64MB (UMA type)	
Display Type and Size	TFT Color LCD (12.1-inch)	
Display Colors	262,144 Colors	
Display Area	W248.0mm [9.76 in.] x H186.5mm [7.34in.]	
Touch Screen	Resistive Film (Analog) Touch Screen, 1024 x 1024	
Serial	COM1: RS-232C, D-sub 9 pin (plug) (RI/+5V switchable, RS-422/RS-485 switchable) COM2: RS-232C, D-sub 9 pin (plug) (RI/+5V switchable) COM3: RS-232C, D-sub 9 pin (plug) COM4: RS-232C, D-sub 9 pin (plug)	
LAN	Rear 2 ports. RJ-45 type modular jack connector (8 pins). LAN1: auto change to 10BASE-T/100BASE-TX/1000BASE-T LAN2: auto change to 10BASE-T/100BASE-TX	
USB	USB 2.0-compatible rear 4 ports, front 1 port. Disable/enable selectable	
Sound	Speaker out (3.5mm mini-pin jack connector)	
RAS (Remote Health Monitor)	Rear RAS connector 9-pin socket	
Disk	250 GB hard drive, 16-128 GB Solid State Drive. SATA interface. IDE interface: Master: 8 GB CF card I/F. Slave: DVD-RW 1 slot	
PCI	PCI x 2 or PCI x 4; first 2 slots are:174.63 [6.88 in.] x 106.68 [4.20 in.] mm; Slots 3 and 4 are: 250 [9.84 in.] x 106.68 [4.20 in.] mm	

General Specifications

Input Voltage	AC100 / 240V (Rated voltage AC85 to 264V; 50/60Hz)	DC24V (Rated voltage DC19.2 to 28.8V)
Power Consumption	145VA or less	145W or less
Allowable Voltage Drop	1 cycle or less (Voltage drop interval must be 1s or more.)*1	5ms or less
Voltage Endurance	AC1500V 20mA for 1 minute (between charging and FG terminals)	AC1000V 20mA for 1 minute (between charging and FG terminals)
Insulation Resistance	DC500V 10MΩ(min.) (between charging and FG terminals)	
Certifications	UL 508; CSA-C22.2 No. 142-M1987; CE Marking EN61000-6-2, EN55011 Class A, EN60950-1 (Only AC model), 47 CFR Part 15 Class A, UL 1604, Class I, Div 2, Groups A, B, C, D	
Temperature	0 to 50°C (32 to 122°F) without HDD; 5 to 50°C (41 to 122°F) with HDD; Storage Temperature: -20 to +60°C (-4 to 140°F)	
Humidity - Ambient/Storage	10 to 90% RH [Not condensing, wet bulb temperature: 39°C (122°F) or less; with HDD: 29°C (84.2°F) or less].	
Corrosive Gas	Free of corrosive gases	
Noise Immunity	Noise Voltage: 1500Vp-p, Pulse Duration: 50ns, 500ns, 1µs Rise Time: 1ns (via noise simulator)	Noise Voltage: 1000Vp-p, Pulse Duration: 1µs Rise Time: 1ns (via noise simulator)
Cooling Method	Forced air cooling by system fan and CPU fan	
Electrostatic Discharge Immunity	6kV (complies with EN 61000-4-2 Level 3)	
Vibration Resistance	IEC61131-2 compliant, With HDD: 10 to 57Hz half-amplitude 0.075mm, 57 to 150Hz constant-accelerated velocity 9.8m/s ² . X, Y, Z directions for 10 cycle (100 minute) Without HDD: 5 to 9Hz half-amplitude 3.5mm, 9 to 150Hz constant-accelerated velocity 9.8m/s ² . X, Y, Z directions for 10 cycle (100 minute)	
Shock during operation	EN/IEC 60068-2-2 compliant, 147m/Sec, 11msec (Approx. 15G), 3 shocks to 3 direction/ axis	
Rating	Equivalent to IP65f, NEMA 4/4x/12 (only when not using front USB)*2	
Weight With DVD-RW	2 slots: Approx. 9.45kg [20.8lb] 4 slots: Approx. 10.45kg [23.0lb]	
External Dimensions With DVD-RW	2 slots: W338mm [13.31in.] x H286mm [11.26in.] x D203mm [7.98in.] 4 slots: W338mm [13.31in.] x H286mm [11.26in.] x D255mm [10.03in.]	
Warranty	Two-year standard (maximum 4 years)	

APL3600T - External Dimensions

Dimensions shown with installation fasteners attached

APL3600T (2-slot)

Unit: mm [in]

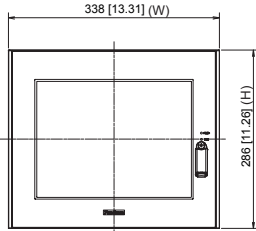

Front

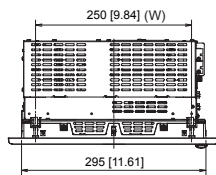

Top

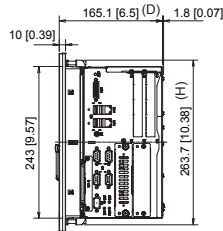

Side

APL3600T (4-slot)

Unit: mm [in]

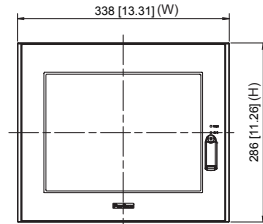

Front

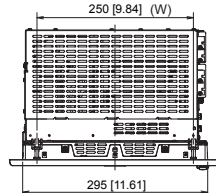

Top

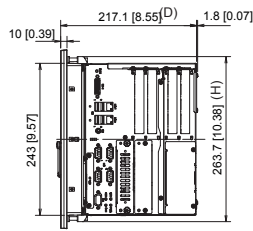

Side

Units are shown without DVD; add 37.5mm [1.47"] to the depth (D).

APL3600T - Cutout Dimensions

Unit: mm [in]

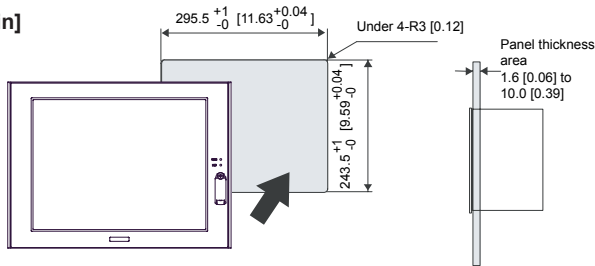

* Compatible with Xycom 4612T

Optional Items

Product Name		Part Number
DIMM Memory Module	512 MB	CA7-DDR2-512MB
	1 GB	CA7-DDR2-1GB
	2 GB	CA7-DDR2-2GB
HDD Unit *1	250 GB	APL3000-HD250
CF Card*1	512MB	CA3-CFCALL/512MB-01
	1GB	CA6-CFCALL/1GB-01
	2GB	CA8-CFCALL/2GB-01
	8GB	144766
RAID Kit		RAID-KIT-01
USB Front Cable	1m	CA5-USBEXT-01
USB Cable	5m	FP-US00
RS-232C Cable	5m	FP61V-IS00-O
DVI-D Cable	5m	FP-DV01-50
Analog RGB Cable *2	4.5m	FP-CV02-45
RGB Converter Cable	5m	CA7-CBLCVRGB-01
DVI-D/RGB Branch Cable	15cm	CA7-CBLCVDVI-D/RGB-01
External Floppy		9000-USBF
Backlight (2 pieces/set for 1 unit)		CA3-BLU12-01
Installation Fasteners		CA3-ATFALL-01
Screen Protection Sheets (5-sheet set)		CA7-DFS12-01

*1 Not installed with operating system. *2 When using the DVI-D/RGB branch cable.

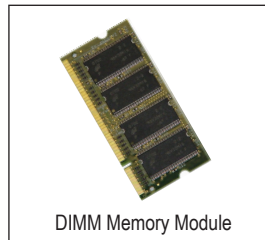
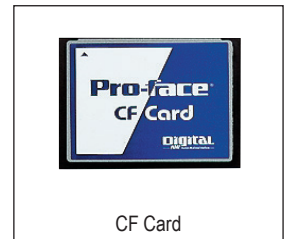

Caution: Before operating any of these products, please be sure to read all related manuals thoroughly.

- All product names used in this document are trademarks or registered trademarks of their respective companies.
- All information contained in this document is subject to change without notice.

APL3000 Cutout Compatibility

If you have :	This will fit the same cutout :	Notes:
4612T, 3612T, 3510(T), 3512T, 3310T, 3410T, 9460(T), 9462(T), 9410T, 9412T, 3412T, 3312T	APL3600T	
4612KPM(T), 3612KPM(T) 3510KP(T), 3512KP(T), 9460KP, 9462KP, 9410KP(T), 3410KP(T), 3310KP(T), 9412KP(T), 3412KP(T), 3312KP(T)	APL3600K	*1
4615T, 3615T	APL3700T	
4715T, 3715T, 3515(T), 3535T, 9465(T)	APL3700T + Adapter plate	Adapter plate : 145053
4715KPM(T), 4615KPM(T), 3615KPM(T), 3715KPM(T), 3515KPM(T), 3512KPM(T), 3535KPM(T), 9465KPM(T)	APL3700K	

*1 When you Migrate from 3612KPM(T)/4612KPM(T) to APL3600K requires removing attachment plate screwed on APL. More details see APL3000 series Hardware Manual. (The original cutout size with spacers is to keep compatibilities with PL3700, FP3710, AGP3750 and PS3710/11)

Ordering Information

APL3600-T - - - - - **-M-** - - - -

Power supply _____
A..... AC 100-240V
D..... DC 24V

CPU _____
CM18..... CeleronM440 1.86GHz
CD2G..... CoreDuo 2.0GHz

Expansion slots _____
2P..... PCI x 2 slots
4P..... PCI x 4 slots

Memory (DRAM) _____
1G..... 1GB
2G..... 2GB
4G..... 4GB

Operating System _____
(RAID and secondary Storage option is not supported with SSD option)
XM250..... 250GB HDD w/XP ML
XPC08..... 8GB CF w/XP Pro*
XM16S..... 16GB SSD w/XP ML
XM16SA... 16GB SSD w/XP ML
XM32SA... 32GB SSD w/XP ML
XM64SA... 64GB SSD w/XP ML
XM128SA.. 128GB SSD w/XP ML

Secondary Storage _____
Blank..... No Secondary Storage
NO250..... 250GB HDD
NO16SA.... 16GB SSD
NO32SA.... 32GB SSD
NO64SA.... 64GB SSD
NO128SA... 128GB SSD

RAID _____
Blank..... No RAID options
R..... RAID

Open HMI (WinGP) _____
Blank..... No Open HMI software included
WG..... WinGP installed

*The languages included with this version of Windows XP Pro are English, French, Spanish, Brazilian Portuguese, Japanese, Simplified and Traditional Chinese.

APL3600K – 12.1" Keypad/Mouse/Touch-Panel PC



Operation



12.1-inch TFT Color LCD
Touch-Panel Computer
With Keypad and Mouse

APL3600K



12.1-inch

CPU: Intel® Celeron® M 1.86GHz or Intel® Core™ Duo 2.0GHz



Features:

- 12.1" (SVGA 800 x 600) TFT touch-panel computer with keypad, mouse
- Intel® Core™ Duo 2.0GHz or Intel® Celeron® M 1.86GHz CPU
- 250 GB Hard Drive, Solid State Drive or bootable Compact Flash
- DVD-RW standard
- Reliability, Availability, Serviceability (RAS) Remote Health Monitor
- SSD (Solid State Drive) for Reliability and faster data access

- Data protection – RAID1 hard disk option
- RoHS directive-conforming
- IP65f, NEMA 4/4x/12 Rated
- UL 1604, Class I, Div 2, Groups A, B, C, D

Open HMI WinGP Option

- Use PC as on-demand touch-screen HMI
- Allows third-party applications to run concurrently
 - SPC, vision, SCADA, MRP
- Expands PC hardware and data connectivity options

Performance Specifications

	Performance	Standard
Base Model	APL3600-KA-CD2G APL3600-KD-CD2G	APL3600-KA-CM18 APL3600-KD-CM18
CPU	Intel® Core® Duo 2.0GHz	Intel® Celeron® M 1.8GHz
Supported OS	Windows® XP Pro / XP ML	Windows® XP Pro / XP ML
Standard Memory	1GB/ 2GB/ 4GB	
Maximum Memory	4GB (SO-DIMM socket x 2)	
Graphics Display Resolution	SVGA (800 x 600 pixels)	
Video Memory	Max 64MB (UMA type)	
Display Type and Size	TFT Color LCD (12.1-inch)	
Display Colors	262,144 Colors	
Display Area	W248.0mm [9.76 in.] x H186.5mm [7.34in.]	
Touch Screen	Resistive Film (Analog) Touch Screen, 1024 x 1024	
Serial	COM1: RS-232C, D-sub 9 pin (plug) (R/+5V switchable, RS-422/RS-485 switchable) COM2: RS-232C, D-sub 9 pin (plug) (R/+5V switchable) COM3: RS-232C, D-sub 9 pin (plug) COM4: RS-232C, D-sub 9 pin (plug)	
LAN	Rear 2 ports, RJ-45 type modular jack connector (8 pins). LAN1: auto change to 10BASE-T/100BASE-TX/1000BASE-T LAN2: auto change to 10BASE-T/100BASE-TX	
USB	USB 2.0-compatible rear 4 ports, front 1 port. Disable/enable selectable	
Sound	Speaker out (3.5mm mini-pin jack connector)	
RAS (Remote Health Monitor)	Rear RAS connector - D-sub 9-pin (socket)	
Disk	250 GB hard drive, 80-160 GB Solid State Drive. SATA interface. IDE interface: Master: 8 GB CF card I/F. Slave: DVD-RW 1 slot	
PCI	PCI x 2 or PCI x 4; first 2 slots are: 174.63 [6.88 in.] x 106.68 [4.20 in.] mm; Slots 3 and 4 are: 250 [9.84 in.] x 106.68 [4.20 in.] mm	

General Specifications

Input Voltage	AC100 / 240V (Rated voltage AC85 to 264V; 50/60Hz)	DC24V (Rated voltage DC19.2 to 28.8V)
Power Consumption	145VA or less	145W or less
Allowable Voltage Drop	1 cycle or less (Voltage drop interval must be 1s or more.)*1	5ms or less
Voltage Endurance	AC1500V 20mA for 1 minute (between charging and FG terminals)	AC1000V 20mA for 1 minute (between charging and FG terminals)
Insulation Resistance	DC500V 10MΩ(min.) (between charging and FG terminals)	
Certifications	UL 508; CSA-C22.2 No. 142-M1987; CE Marking EN61000-6-2, EN55011 Class A, EN60950-1 (Only AC Model) UL 1604, Class I, Div 2, Groups A, B, C, D	
Temperature	0 to 50°C (32 to 122°F) without HDD; 5 to 50°C (41 to 122°F) with HDD; Storage Temperature: -20 to +60°C (-4 to 140°F)	
Humidity - Ambient/Storage	10 to 90% RH [Not condensing, wet bulb temperature: 39°C (122°F) or less; with HDD: 29°C (84.2°F) or less].	
Corrosive Gas	Free of corrosive gases	
Noise Immunity	Noise Voltage: 1500Vp-p, Pulse Duration: 50ns, 500ns, 1s Rise Time: 1µs (via noise simulator)	Noise Voltage: 1000Vp-p, Pulse Duration: 1µs Rise Time: 1ns (via noise simulator)
Cooling Method	Forced air cooling by system fan and CPU fan	
Electrostatic Discharge Immunity	6kV (complies with EN 61000-4-2 Level 3)	
Vibration Resistance	IEC61131-2 compliant, With HDD: 10 to 57Hz half-amplitude 0.075mm, 57 to 150Hz constant-accelerated velocity 9.8m/s ² . X, Y, Z directions for 10 cycle (100 minute) Without HDD: 5 to 9Hz half-amplitude 3.5mm, 9 to 150Hz constant-accelerated velocity 9.8m/s ² . X, Y, Z directions for 10 cycle (100 minute)	
Shock during operation	EN/IEC 60068-2-2 compliant, 147m/Sec, 11msec (Approx. 15G), 3 shocks to 3 direction/ axis	
Rating	Equivalent to IP65f, NEMA 4/4x/12 rated (only when not using front USB)*2	
Weight With DVD-RW	2 slots: Approx. 12.45kg [27.4lb] 4 slots: Approx. 13.45kg [29.6lb]	
External Dimensions With DVD-RW	2 slots: W 425mm [16.73in.] x H 325mm [12.80in.] x D 203mm [7.98in.] 4 slots: W 425mm [16.73in.] x H 325mm [12.80in.] x D 255mm [10.03in.]	
Warranty	Two-year standard (maximum 4 years)	

*1 Depending on the combined total of the expansion slot power supply and external load power values, the allowable voltage drop may be 20ms or less.

*2 Meets IP65f testing requirements. Operation is not, however, guaranteed in every environment.

APL3600K - External Dimensions

Dimensions shown with installation fasteners attached

APL3600K (2-slot)

Unit: mm [in]

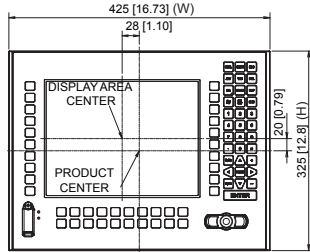

Front

APL3600K (4-slot)

Unit: mm [in]

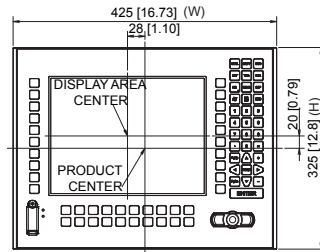

Front

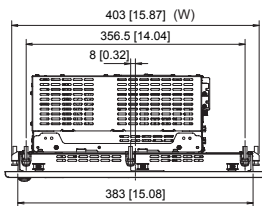

Top

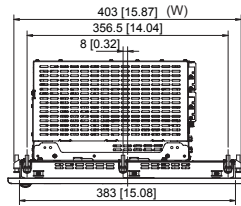

Top

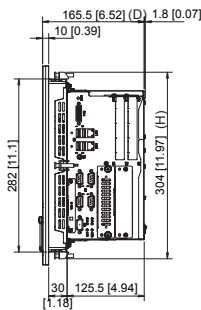

Side

Units are shown without DVD; add 37.5mm [1.47"] to the depth (D).

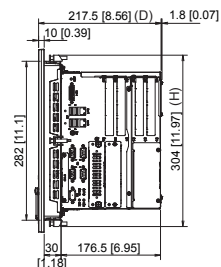

Side

APL3600K - Cutout Dimensions

Unit: mm [in]

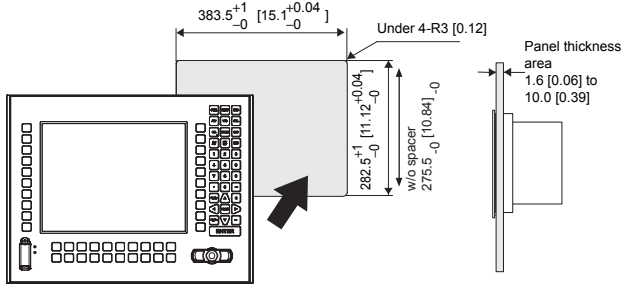

* To be compatible with Xycom 4612KPM(T) need to detach spacers

Optional Items

Product Name		Part Number
DIMM Memory Module	512 MB	CA7-DDR2-512MB
	1 GB	CA7-DDR2-1GB
	2GB	CA7-DDR2-2GB
HDD Unit *1	250 GB	APL3000-HD250
CF Card*1	512MB	CA3-CFCALL/512MB-01
	1GB	CA6-CFCALL/1GB-01
	2GB	CA8-CFCALL/2GB-01
	8GB	144766
RAID-Kit		RAID-KIT-01
USB Front Cable	1m	CA5-USBEXT-01
USB Cable	5m	FP-US00
RS-232C Cable	5m	FP61V-IS00-0
DVI-D Cable	5m	FP-DV01-50
Analog RGB Cable *2	4.5m	FP-CV02-45
RGB Converter Cable	5m	CA7-CBLCVRGB-01
DVI-D/RGB Branch Cable	15cm	CA7-CBLCVDVI-D/RGB-01
External Floppy		9000-USBF
Backlight (2 pieces/set for 1 unit)		CA3-BLU12-01
Installation Fasteners		CA3-ATFALL-01
Screen Protection Sheets (5-sheet set)		CA3-DFS15-01

*1 Not installed with operating system.

*2 When using the DVI-D/RGB branch cable.

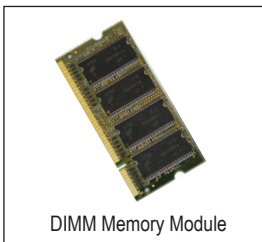
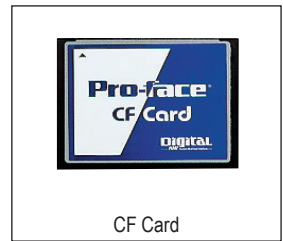
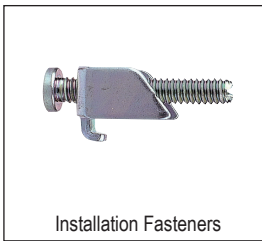

Caution: Before operating any of these products, please be sure to read all related manuals thoroughly.

- All product names used in this document are trademarks or registered trademarks of their respective companies.
- All information contained in this document is subject to change without notice.

APL3000 Cutout Compatibility

If you have :	This will fit the same cutout :	Notes:
4612T, 3612T, 3510(T), 3512T, 3310T, 3410T, 9460(T), 9462(T), 9410T, 9412T, 3412T, 3312T	APL3600T	
4612KPM(T), 3612KPM(T) 3510KP(T), 3512KP(T), 9460KP, 9462KP, 9410KP(T), 3410KP(T), 3310KP(T), 9412KP(T), 3412KP(T), 3312KP(T)	APL3600K	*1
4615T, 3615T	APL3700T	
4715T, 3715T, 3515(T), 3535T, 9465(T)	APL3700T + Adapter plate	Adapter plate : 145053
4715KPM(T), 4615KPM(T), 3615KPM(T), 3715KPM(T), 3515KPM(T), 3512KPM(T), 3535KPM(T), 9465KPM(T)	APL3700K	

*1 When you Migrate from 3612KPM(T)/4612KPM(T) to APL3600K requires removing attachment plate screwed on APL. More details see APL3000 series Hardware Manual. (The original cutout size with spacers is to keep compatibilities with PL3700, FP3710, AGP3750 and PS3710/11)

Ordering Information

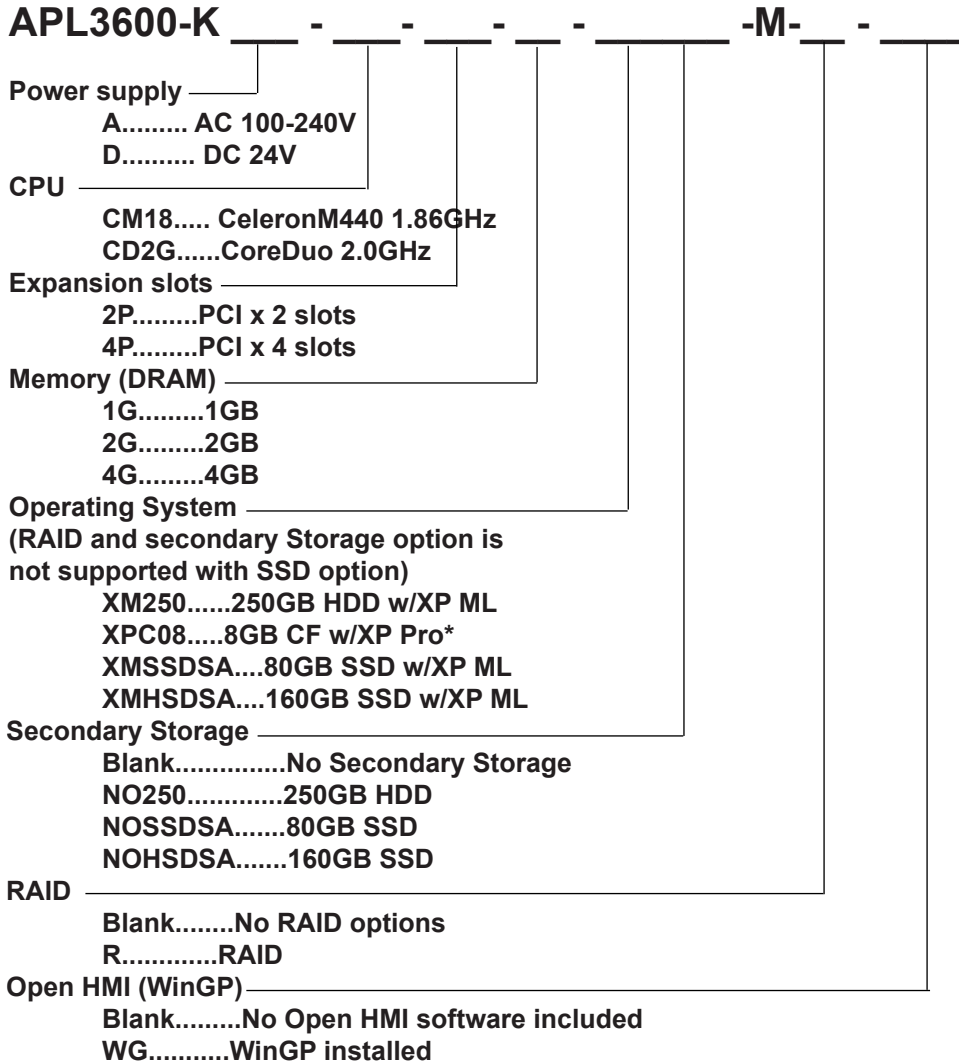

*The languages included with this version of Windows XP Pro are English, French, Spanish, Brazilian Portuguese, Japanese, Simplified and Traditional Chinese.

Pro-face America
Phone: 734.477.0060
Fax: 734.864.7347
www.profaceamerica.com

Customer Service Hotline: 800.289.9266

For more information
ACCESS www.profaceamerica.com

Pro-face
for the best interface