

USER GUIDE

XCN-2050™ Display

Version 1.075
Revision D
December 2014

Corporate Office

Trimble Navigation Limited
935 Stewart Drive
Sunnyvale, CA 94085
USA
www.trimble.com

Heavy Highway business area

10368 Westmoor Drive
Westminster, Colorado 80021
USA
800-361-1249 (toll free in USA)
+1-937-245-5154 Phone
+1-937-233-9441 Fax
www.trimble.com
Email: trimble_support@trimble.com

Copyright and Trademarks

© 2014 Trimble Navigation Limited. All rights reserved.
Trimble, the Globe & Triangle logo, EZ-Boom, EZ-Pilot, EZ-Steer, FarmWorks Software, OmniSTAR and Tru Count Air Clutch are trademarks of Trimble Navigation Limited, registered in the United States and in other countries.
AutoBase, Autopilot, AutoSense, CenterPoint, Connected Farm, Field-IQ, LiquiBlock, RangePoint, RTX, VRS, VRS Now, TMX-2050 and Zephyr are trademarks of Trimble Navigation Limited.
For STL support, the software uses the Moscow Center for SPARC Technology adaptation of the SGI Standard Template Library. Copyright © 1994 Hewlett-Packard Company, Copyright © 1996, 97 Silicon Graphics Computer Systems, Inc., Copyright © 1997 Moscow Center for SPARC Technology.
Portions Copyright © 2009 Nokia Corporation and/or its subsidiary(-ies). Portions Copyright © 2003, Bitstream Inc.
All other trademarks are the property of their respective owners.

Release Notice

This is the December 2014 release (Revision D) of the XCN-2050 display documentation. It applies to version 1.075 of the display software.

Legal Notices

The following limited warranties give you specific legal rights. You may have others, which vary from state/jurisdiction to state/jurisdiction.

Product Limited Warranty

Trimble warrants that this Trimble product and its internal components (the "Product") shall be free from defects in materials and workmanship and will substantially conform to Trimble's applicable published specifications for the Product for a period of one (1) year, starting from the earlier of (i) the date of installation, or (ii) six (6) months from the date of original Product shipment from Trimble. This warranty applies only to the Product if installed by Trimble or a dealer authorized by Trimble to perform Product installation services.

Software Components

All Product software components (sometimes hereinafter also referred to as "Software") are licensed solely for use as an integral part of the Product and are not sold. Any software accompanied by a separate end user license agreement ("EULA") shall be governed by the terms, conditions, restrictions and limited warranty terms of such EULA notwithstanding the preceding paragraph.
During the limited warranty period you will be entitled to receive such Fixes to the Product software that Trimble releases and makes commercially available and for which it does not charge separately, subject to the procedures for delivery to purchasers of Trimble products generally. If you have purchased the Product from an authorized Trimble dealer rather than from Trimble directly, Trimble may, at its option, forward the software Fix to the Trimble dealer for final distribution to you. Minor Updates, Major Upgrades, new products, or substantially new software releases, as identified by Trimble, are expressly excluded from this update process and limited warranty. Receipt of software Fixes or other enhancements shall not serve to extend the limited warranty period.
For purposes of this warranty the following definitions shall apply: (1) "Fix(es)" means an error correction or other update created to fix a previous software version that does not substantially conform to its Trimble specifications; (2) "Minor Update" occurs when enhancements

are made to current features in a software program; and (3) "Major Upgrade" occurs when significant new features are added to software, or when a new product containing new features replaces the further development of a current product line. Trimble reserves the right to determine, in its sole discretion, what constitutes a Fix, Minor Update, or Major Upgrade.

Gson components licensed under the Apache 2.0 License. The source is available from <http://code.google.com/p/google-gson/>. Google MVEL components licensed under the Apache 2.0 License. The source is available from <http://code.google.com/p/mvel.codehouse.org>. Google Guava components listed under the Apache 2.0 License. The source is available from <http://code.google.com/p/guava-libraries>. MapQuest content licensed under the Open Data Commons Database License (DbCL). The source is available from <http://developer.mapquest.com>.
APACHE LICENSE (Version 2.0, January 2004)

<http://www.apache.org/licenses/>
TERMS AND CONDITIONS FOR USE,
REPRODUCTION, AND DISTRIBUTION

1. Definitions

"License" shall mean the terms and conditions for use, reproduction, and distribution as defined by Sections 1 through Section 9 of this document.

"Licensor" shall mean the copyright owner or entity authorized by the copyright owner that is granting the License.

"Legal Entity" shall mean the union of the acting entity and all other entities that control, are controlled by, or are under common control with that entity. For the purposes of this definition, "control" means (i) the power, direct or indirect, to cause the direction or management of such entity, whether by contract or otherwise, or (ii) ownership of fifty percent (50%) or more of the outstanding shares, or (iii) beneficial ownership of such entity.

"You" (or "Your") shall mean an individual or Legal Entity exercising permissions granted by this License.

"Source" form shall mean the preferred form for making modifications, including but not limited to software source code, documentation source, and configuration files.

"Object" form shall mean any form resulting from mechanical transformation or translation of a Source form, including but not limited to compiled object code, generated documentation, and conversions to other media types.

"Work" shall mean the work of authorship, whether in Source or Object form, made available under the License, as indicated by a copyright notice that is included in or attached to the work (an example is provided in the Appendix below).

"Derivative Works" shall mean any work, whether in Source or Object form, that is based on (or derived from) the Work and for which the editorial revisions, annotations, elaborations, or other modifications represent, as a whole, an original work of authorship. For the purposes of this License, Derivative Works shall not include works that remain separable from, or merely link (or bind by name) to the interfaces of, the Work and Derivative Works thereof.

"Contribution" shall mean any work of authorship, including the original version of the Work and any modifications or additions to that Work or Derivative Works thereof, that is intentionally submitted to Licensor for inclusion in the Work by the copyright owner or by an individual or Legal Entity authorized to submit on behalf of the copyright owner. For the purposes of this definition, "submitted" means any form of electronic, verbal, or written communication sent to the Licensor or its representatives, including but not limited to communication on electronic mailing lists, source code control systems, and issue tracking systems that are managed by, or on behalf of, the Licensor for the purpose of discussing and improving the Work, but excluding communication that is conspicuously marked or otherwise designated in writing by the copyright owner as "Not a Contribution."

"Contributor" shall mean Licensor and any individual or Legal Entity on behalf of whom a Contribution has been received by Licensor and subsequently incorporated within the Work.

2. Grant of Copyright License. Subject to the terms and conditions of this License, each Contributor hereby grants to You a perpetual, worldwide, non-exclusive, no-charge, royalty-free, irrevocable copyright license to reproduce, prepare Derivative Works of, publicly display, publicly perform, sublicense, and distribute the Work and such Derivative Works in Source or Object form.

3. Grant of Patent License. Subject to the terms and conditions of this License, each Contributor hereby grants to You a perpetual, worldwide, non-exclusive, no-charge, royalty-free, irrevocable (except as stated in this section) patent license to make, have made, use, offer to sell, sell, import, and otherwise transfer the Work, where such license applies only to those patent claims licensable by such Contributor that are necessarily

infringed by their Contribution(s) alone or by combination of their Contribution(s) with the Work to which such Contribution(s) was submitted. If You institute patent litigation against any entity (including a cross-claim or counterclaim in a lawsuit) alleging that the Work or a Contribution incorporated within the Work constitutes direct or contributory patent infringement, then any patent licenses granted to You under this License for that Work shall terminate as of the date such litigation is filed.

4. Redistribution. You may reproduce and distribute copies of the Work or Derivative Works thereof in any medium, with or without modifications, and in Source or Object form, provided that You meet the following conditions:

You must give any other recipients of the Work or Derivative Works a copy of this License; and

You must cause any modified files to carry prominent notices stating that You changed the files; and

You must retain, in the Source form of any Derivative Works that You distribute, all copyright, patent, trademark, and attribution notices from the Source form of the Work, excluding those notices that do not pertain to any part of the Derivative Works; and

If the Work includes a "NOTICE" text file as part of its distribution, then any Derivative Works that You distribute must include a readable copy of the attribution notices contained within such NOTICE file, excluding those notices that do not pertain to any part of the Derivative Works, in at least one of the following places: within a NOTICE text file distributed as part of the Derivative Works; within the Source form or documentation, if provided along with the Derivative Works; or, within a display generated by the Derivative Works, if and wherever such third-party notices normally appear. The contents of the NOTICE file are for informational purposes only and do not modify the License. You may add Your own attribution notices within Derivative Works that You distribute, alongside or as an addendum to the NOTICE text from the Work, provided that such additional attribution notices cannot be construed as modifying the License.

You may add Your own copyright statement to Your modifications and may provide additional or different license terms and conditions for use, reproduction, or distribution of Your modifications, or for any such Derivative Works as a whole, provided Your use, reproduction, and distribution of the Work otherwise complies with the conditions stated in this License.

5. Submission of Contributions. Unless You explicitly state otherwise, any Contribution intentionally submitted for inclusion in the Work by You to the Licensor shall be under the terms and conditions of this License, without any additional terms or conditions. Notwithstanding the above, nothing herein shall supersede or modify the terms of any separate license agreement you may have executed with Licensor regarding such Contributions.

6. Trademarks. This License does not grant permission to use the trade names, trademarks, service marks, or product names of the Licensor, except as required for reasonable and customary use in describing the origin of the Work and reproducing the content of the NOTICE file.

7. Disclaimer of Warranty. Unless required by applicable law or agreed to in writing, Licensor provides the Work (and each Contributor provides its Contributions) on an "AS IS" BASIS, WITHOUT WARRANTIES OR CONDITIONS OF ANY KIND, either express or implied, including, without limitation, any warranties or conditions of TITLE, NON-INFRINGEMENT, MERCHANTABILITY, or FITNESS FOR A PARTICULAR PURPOSE. You are solely responsible for determining the appropriateness of using or redistributing the Work and assume any risks associated with Your exercise of permissions under this License.

8. Limitation of Liability. In no event and under no legal theory, whether in tort (including negligence), contract, or otherwise, unless required by applicable law (such as deliberate and grossly negligent acts) or agreed to in writing, shall any Contributor be liable to You for damages, including any direct, indirect, special, incidental, or consequential damages of any character arising as a result of this License or out of the use or inability to use the Work (including but not limited to damages for loss of goodwill, work stoppage, computer failure or malfunction, or any and all other commercial damages or losses), even if such Contributor has been advised of the possibility of such damages.

LWGL LICENSE

ODC DATABASE CONTENTS LICENSE

SGI FREE SOFTWARE LICENSE B (Version 2.0, Sept. 18, 2008)

Copyright © 2013 Silicon Graphics, Inc. All Rights Reserved.

Permission is hereby granted, free of charge, to any person obtaining a copy of this software and associated documentation files (the "Software"), to deal in the Software without restriction, including without limitation the rights to use, copy, modify, merge, publish, distribute,

sublicense, and/or sell copies of the Software, and to permit persons to whom the Software is furnished to do so, subject to the following conditions:

The above copyright notice including the dates of first publication and either this permission notice or a reference to <http://oss.sgi.com/projects/FreeB/> shall be included in all copies or substantial portions of the Software.

THE SOFTWARE IS PROVIDED "AS IS", WITHOUT WARRANTY OF ANY KIND, EXPRESS OR IMPLIED, INCLUDING BUT NOT LIMITED TO THE WARRANTIES OF MERCHANTABILITY, FITNESS FOR A PARTICULAR PURPOSE AND NONINFRINGEMENT. IN NO EVENT SHALL SILICON GRAPHICS, INC. BE LIABLE FOR ANY CLAIM, DAMAGES OR OTHER LIABILITY, WHETHER IN AN ACTION OF CONTRACT, TORT OR OTHERWISE, ARISING FROM, OUT OF OR IN CONNECTION WITH THE SOFTWARE OR THE USE OR OTHER DEALINGS IN THE SOFTWARE. Except as contained in this notice, the name of Silicon Graphics, Inc. shall not be used in advertising or otherwise to promote the sale, use or other dealings in this Software without prior written authorization from Silicon Graphics, Inc.

MAPQUEST PLATFORM TERMS OF USE (Last Updated: November 1, 2011)

Community Edition License Agreement

INTRODUCTION. MapQuest has been helping people find places and get maps and directions for over 40 years. We make the MapQuest APIs, our Open Services (as described at <http://open.mapquestapi.com/>), Community Accounts and other developer services (in short, the "MapQuest Services"), along with the maps, driving directions and other content delivered through the MapQuest Services (the "MapQuest Content"), available without charge to encourage developers to use these services and content in developing their applications and websites. We want you to be creative and build awesome applications and websites that thrill your users. All we ask is that you comply with the terms that are included in these Terms of Use.

We will provide the developer community at-large with support in various forms, such as forums, blog posts or FAQs. Since we're providing the MapQuest Services for free, we don't provide individual technical support or warranties for the Community Services, but if you want to receive technical support and warranties, we have a product for you. Please check out our MapQuest Platform Services Enterprise Edition and learn more about the services we will provide for reasonable fees.

If you choose to use any of the MapQuest Services or if you set up a Community Account, you are agreeing to abide by these Terms of Use and are forming an agreement between yourself and MapQuest, Inc. ("MapQuest"). If you do not want to abide by these Terms of Use, then don't use the MapQuest Services.

LICENSES FROM MAPQUEST TO YOU.

2.1. MapQuest Services License. MapQuest grants you a non-exclusive, non-assignable, non-sublicensable, revocable limited license to use the MapQuest Services during the Term of these Terms of Use as provided by MapQuest in the manner permitted in these Terms of Use.

2.2. MapQuest Content License. MapQuest grants you a non-exclusive, non-assignable, non-sublicensable, revocable limited license access, use, publicly perform and publicly display the MapQuest Content as the MapQuest Content is provided through the MapQuest Services and in the manner permitted by these Terms of Use.

GENERAL RESTRICTIONS, ADDITIONAL LEGAL NOTICE, RESERVATION OF RIGHTS.

3.1. Restrictions. Except as expressly authorized by MapQuest, You must not:

decompile, disassemble, reverse engineer, or otherwise attempt to derive any source code from the MapQuest Services or MapQuest Content, other than the Open Services;

interfere or disrupt MapQuest servers or networks, or disobey any network access or security requirements, policies, procedures or regulations of MapQuest (including the enabling of any viruses, Trojan horses, trap doors, back doors, worms, time bombs, cancelbots, adware, spyware or other computer programming routines designed or intended to damage, detrimentally interfere with, surreptitiously intercept or expropriate any system, data or personal information);

use the MapQuest Services as a means to engage in conduct that reflects poorly upon, disparages or devalues MapQuest's reputation or goodwill, as determined in MapQuest's sole discretion;

use the MapQuest Services, other than the Open Services, in conjunction with any commercial application not publicly available without charge (other than mobile applications for which users pay a fee to download/install the application). If your application does not fit this

criteria and you would like to discuss additional options for using the MapQuest Services please contact info@mapquest.com; use the MapQuest Services, other than the Open Services, to process or generate data for any third party (other than for end users as expressly permitted hereunder);

use the MapQuest Services with any content or product that falsely expresses or implies that such content or product is sponsored or endorsed by MapQuest;

use the MapQuest Services in conjunction with a site or application which contains or displays adult content or promotes illegal activities, gambling, or the sale of tobacco or alcohol to persons under twenty-one (21) years of age;

3.2. Additional Legal Requirements. In addition to the restrictions set forth in Section 3.1, your use of the MapQuest Services and MapQuest Content is subject to the Additional Legal Requirements which are incorporated and made a part of these Terms of Use. Please read the Additional Legal Requirements carefully as they include usage limits and additional restrictions that may impact your plans for development.

3.3. Reservation of Rights. MapQuest reserves all rights not expressly granted in these Terms of Use and you may not use the MapQuest Services or MapQuest Content in any manner not expressly authorized in these Terms of Use.

LICENSE FROM YOU TO MAPQUEST. If you upload any data, feedback, ideas, suggestions, content, points of interest (including any points of interest that include Trademarks) or other material to MapQuest (collectively "Your Content"), you hereby grant MapQuest a perpetual, worldwide, non-exclusive, royalty-free license to access, archive, reproduce, publicly display, translate, modify the format or the display of, distribute, transmit, stream, cache, overlay, seam, perform, sublicense, and otherwise use Your Content with or without attribution and without financial obligation, in whole or in part, via any method for any purpose. MapQuest makes no assertion of ownership over Your Content, and you retain all intellectual property rights to Your Content, subject to the license you grant to MapQuest above.

MODIFICATIONS TO THESE TERMS OF USE AND THE SERVICES.

MapQuest reserves the right to change or modify these Terms of Use, the MapQuest Services and/or the MapQuest Content. Please check these Terms of Use, including the Additional Legal Requirements periodically for changes. Your continued use of the MapQuest Services or MapQuest Content following the posting of any changes to the Terms of Use constitutes acceptance of those changes.

TERMINATION. MapQuest may terminate these Terms of Use and/or the provision of the MapQuest Services or MapQuest Content at any time, for any reason, with or without notice.

PRIVACY POLICY AND END USER TERMS.

7.1. Privacy Policy. MapQuest's collection and use of personally identifiable information is governed by the AOL Network Privacy Policy, available at http://about.aol.com/aolnetwork/aol_pp.

7.2. End User Terms. End users shall only be entitled to use the MapQuest Services and MapQuest Content if they accept the then current end user Terms of Use located at <http://info.mapquest.com/terms-of-use/>. MapQuest reserves the right to amend and/or replace these terms and the form and manner of presentation. You must provide a hypertext link at the bottom of each page in your website or application where the MapQuest Services or MapQuest Content can be viewed or accessed, or within the terms of use of your application or website, to the end user terms of use.

ACCESS AND USAGE DATA.

8.1. Credentials. MapQuest, at its discretion, may require you to create an account and obtain an access key and other related credentials (collectively "Credentials") to use the MapQuest Services or certain aspects of the MapQuest Services. You are responsible for maintaining the confidentiality of your Credentials and for any usage or abuse of the MapQuest Services or MapQuest Content by anyone using your Credentials.

8.2. Usage Data. MapQuest's servers record information when you visit MapQuest websites or when applications and/or Credentials call or invoke the MapQuest Services. This information may include, without limitation, the URL, IP address, browser type, Credential and access times and dates. MapQuest may use this information to promote, operate, and improve MapQuest services, products and properties.

PROPRIETARY RIGHTS. You acknowledge and agree the MapQuest Services and MapQuest Content are works for purposes of copyright law, and embody valuable, confidential, trade secret information of MapQuest, the development of which required the expenditure of substantial time and money. As between MapQuest and You, MapQuest retains exclusive ownership of any and all rights, title and interest (including all intellectual property rights) in the MapQuest

Services and MapQuest Content, and you shall not acquire any rights, express or implied, in the foregoing by virtue of these Terms of Use other than otherwise expressly set forth. For purposes of these Terms of Use, the term "Trademarks" means all trademarks, trade names, service marks, logos, domain names, along with any other distinctive brand features of MapQuest or its suppliers. All use by You of Trademarks shall inure to the benefit of MapQuest. Further, You shall not (a) display a Trademark as the most prominent element on any page of Your website, application or paper map; (b) display a Trademark in a manner that is misleading, defamatory, infringing, libelous, disparaging, obscene or otherwise objectionable to MapQuest as determined by MapQuest in its sole discretion; or (c) remove, distort or alter any element of a Trademark.

DISCLAIMER OF WARRANTIES. THE MAPQUEST SERVICES AND MAPQUEST CONTENT ARE PROVIDED ON AN "AS IS" AND "AS AVAILABLE" BASIS. MAPQUEST DISCLAIMS ANY AND ALL WARRANTIES, WHETHER EXPRESS OR IMPLIED, INCLUDING BUT NOT LIMITED TO ANY WARRANTIES OF MERCHANTABILITY, FITNESS FOR A PARTICULAR PURPOSE, ACCURACY OR NON-INFRINGEMENT. MAPQUEST DOES NOT REPRESENT OR WARRANT THAT THE MAPQUEST SERVICES OR CONTENT, OR ANY PORTION THEREOF, IS OR WILL BE FREE OF DEFECTS OR ERRORS (OR THAT ANY SUCH DEFECTS OR ERRORS WILL BE CORRECTED), VIRUS FREE, ABLE TO OPERATE ON AN UNINTERRUPTED BASIS, MEET YOUR REQUIREMENTS, OR CAPABLE OF BEING INTEGRATED INTO OR WITH YOUR COMPUTER SYSTEM, APPLICATIONS OR NETWORK. FURTHER, MAPQUEST DOES NOT WARRANT OR MAKE ANY REPRESENTATIONS REGARDING THE USE OR THE RESULTS OF THE USE OF THE MAPQUEST SERVICES, OR ANY PORTION THEREOF, IN TERMS OF ITS CORRECTNESS, ACCURACY, QUALITY, RELIABILITY, OR OTHERWISE. THIS DISCLAIMER CONSTITUTES AN ESSENTIAL PART OF THESE TERMS OF USE. IF THIS EXCLUSION IS HELD UNENFORCEABLE, THEN ALL EXPRESS AND IMPLIED WARRANTIES SHALL BE LIMITED IN DURATION TO A PERIOD OF FIFTEEN (15) DAYS AFTER THE EFFECTIVE DATE, AND NO WARRANTIES SHALL APPLY AFTER THAT PERIOD.

LIMITATION ON LIABILITY. NEITHER MAPQUEST NOR ITS AFFILIATES NOR ANY OF THEIR SUPPLIERS SHALL BE LIABLE TO YOU OR ANY OTHER THIRD PARTY FOR ANY DIRECT, INDIRECT, SPECIAL, INCIDENTAL OR CONSEQUENTIAL DAMAGES OF ANY NATURE ARISING OUT OF THE POSSESSION OF, ACCESS TO, USE OF, OR INABILITY TO ACCESS OR USE THE MAPQUEST SERVICES OR MAPQUEST CONTENT, OR ANY PORTION, INCLUDING, WITHOUT LIMITATION, LOST PROFITS, DATA LOSS, COST OF PROCUREMENT FOR SUBSTITUTE GOODS, OR COMPUTER FAILURE OR MALFUNCTION, EVEN IF MAPQUEST HAS BEEN ADVISED OF THE POSSIBILITY OF SUCH DAMAGES, AND REGARDLESS OF WHETHER THE CLAIM OR LIABILITY IS BASED UPON ANY CONTRACT, TORT, BREACH OF WARRANTY OR OTHER LEGAL OR EQUITABLE THEORY. IN NO EVENT SHALL MAPQUEST'S TOTAL AGGREGATE LIABILITY UNDER THESE TERMS OF USE EXCEED THE LESSER OF (A) THE TOTAL AMOUNT OF FEES PAID BY YOU TO MAPQUEST UNDER THESE TERMS OF USE FOR THE TWELVE (12) MONTHS PRECEDING THE DATE OF THE EVENT GIVING RISE TO SUCH CLAIM; OR (B) FIVE HUNDRED DOLLARS (\$500).

YOU EXPRESSLY ACKNOWLEDGE AND AGREE THAT THE PARTICIPATION IN AND USE OF THE MAPQUEST SERVICES AND MAPQUEST CONTENT IS DONE AT YOUR OWN RISK AND THAT YOU ARE SOLELY RESPONSIBLE AND LIABLE FOR ANY DAMAGE SUSTAINED TO YOUR COMPUTER SYSTEM, NETWORK OR DATA RESULTING FROM SUCH PARTICIPATION OR USE.

SOME JURISDICTIONS DO NOT ALLOW THE EXCLUSION OF CERTAIN WARRANTIES OR THE LIMITATION OR EXCLUSION OF LIABILITY FOR INCIDENTAL OR CONSEQUENTIAL DAMAGES.

INDEMNITY. You agree to indemnify, defend and hold MapQuest and its affiliates, and each of their officers, directors, employees, agents, co-branders or other partners (as well as each of their suppliers), successors and permitted assigns ("Indemnified Parties") harmless from and against any third party claim or action, including any liability, cost, losses, damages, expenses, and attorney's fees, arising from or in any way related to Your access, use or participation in the MapQuest Services (including claims related to Your Content and any use of the MapQuest Services with software, data, content, systems, or other technology not provided by MapQuest), any violation of these Terms of Use, or any alleged infringement of a patent, copyright, trademark, trade secret, or other intellectual property right. MapQuest shall use good faith efforts to provide you with prompt notice of any such claim or action; provided however, you agree that, upon MapQuest's written request, MapQuest shall control the defense or settlement of any such claim or action and you shall provide reasonable cooperation to MapQuest. You may not

settle an indemnifiable claim without obtain MapQuest's prior written consent.

EXPORT RESTRICTIONS. You agree to comply with all export and import laws and restrictions and regulations of the United States or any foreign agency or authority, and not to export or re-export MapQuest Services or any direct product thereof in violation of any such restrictions, laws or regulations, or without all necessary approvals.

NOTICES AND TRANSACTING ELECTRONICALLY. You understand and agree that MapQuest is an online service and that you are transacting with MapQuest electronically. MapQuest shall provide electronic notices by posting them on this website and/or by sending an email to any account associated with your Credentials.

GENERAL PROVISIONS.

15.1. Entire Agreement. These Terms of Use constitute the entire agreement between MapQuest and You with respect to the subject matter of these Terms of Use, and supersedes all prior agreements, understandings and communications between MapQuest and You with respect to such subject matter. No modification or amendment to these Terms of Use shall be effective unless in writing by MapQuest.

15.2. Choice of Law; Jurisdiction. These Terms of Use are made under and shall be governed by and construed in accordance with the laws of the Commonwealth of Virginia (except for its conflicts of laws principles) and specifically excluding f the United Nations Convention on Contracts for the International Sale of Goods. MapQuest and You expressly agree that exclusive jurisdiction for any claim or dispute relating to or arising out of these Terms of Use resides in the state courts in Loudoun County, Virginia and the federal courts of the Eastern District of Virginia (Alexandria Division) and further agree and expressly consent to the exercise of personal jurisdiction in such state and federal courts of Virginia in connection with any such dispute.

15.3. Severability; Waiver. If any provision in these Terms of Use should be held illegal or unenforceable by a court having jurisdiction, such provision shall be modified to the extent necessary to render it enforceable without losing its intent, or severed from these Terms of Use if no such modification is possible, and other provisions of these Terms of Use shall remain in full force and effect. A waiver by either MapQuest or You (as applicable) of any term or condition of these Terms of Use or any breach thereof, in any one instance, shall not waive such term or condition or any subsequent breach thereof.

15.4. Public Statements. You acknowledge and agree that MapQuest may make any public statements regarding the existence of these Terms of Use or the relationship described herein, without Your consent.

15.5. Survival. Any term or condition of these Terms of Use that by its nature would logically survive termination or expiration of these Terms of Use, including but not limited to protections of proprietary rights, indemnifications, and limitations of liability, shall survive such termination or expiration.

15.6. Independent Contractors. The parties to these Terms of Use are independent contractors. Neither party is an agent, representative or partner of the other party. Neither party shall have any right, power or authority to enter into any agreement for or on behalf of, or incur any obligation or liability of, or otherwise to bind, the other party.

15.7. Equitable Remedies. You acknowledge and agree that monetary damages may be insufficient to compensate MapQuest for an actual or anticipated breach of these Terms of Use by you. You agree that in such circumstances MapQuest shall be entitled to seek equitable remedies (including preliminary and permanent injunctions), in addition to any other remedies available to MapQuest at law or hereunder.

15.8. Statute of Limitations. You agree that regardless of any statute or law to the contrary, any claim or cause of action arising out of or related to use of the MapQuest Services or these Terms of Use must be filed by you within one (1) year after such claim or cause of action arose or be forever barred.

15.9. Consent to Further Contacts. You agree that MapQuest may contact You with respect to these Terms of Use, any other MapQuest products and services, and in relation to any marketing related-purposes.

ODC Open Database License (ODbL)

The Open Database License (ODbL) is a license agreement intended to allow users to freely share, modify, and use this Database while maintaining this same freedom for others. Many databases are covered by copyright, and therefore this document licenses these rights. Some jurisdictions, mainly in the European Union, have specific rights that cover databases, and so the ODbL addresses these rights, too. Finally, the ODbL is also an agreement in contract for users of this Database to act in certain ways in return for accessing this Database.

Databases can contain a wide variety of types of content (images, audiovisual material, and sounds all in the same database, for example),

and so the ODbL only governs the rights over the Database, and not the contents of the Database individually. Licensors should use the ODbL together with another license for the contents, if the contents have a single set of rights that uniformly covers all of the contents. If the contents have multiple sets of different rights, Licensors should describe what rights govern what contents together in the individual record or in some other way that clarifies what rights apply.

Sometimes the contents of a database, or the database itself, can be covered by other rights not addressed here (such as private contracts, trade mark over the name, or privacy rights / data protection rights over information in the contents), and so you are advised that you may have to consult other documents or clear other rights before doing activities not covered by this License.

The Licensor (as defined below) and You (as defined below) agree as follows:

1.0 Definitions of Capitalised Words

"Collective Database" – Means this Database in unmodified form as part of a collection of independent databases in themselves that together are assembled into a collective whole. A work that constitutes a Collective Database will not be considered a Derivative Database.

"Convey" – As a verb, means Using the Database, a Derivative Database, or the Database as part of a Collective Database in any way that enables a Person to make or receive copies of the Database or a Derivative Database. Conveying does not include interaction with a user through a computer network, or creating and Using a Produced Work, where no transfer of a copy of the Database or a Derivative Database occurs.

"Contents" – The contents of this Database, which includes the information, independent works, or other material collected into the Database. For example, the contents of the Database could be factual data or works such as images, audiovisual material, text, or sounds.

"Database" – A collection of material (the Contents) arranged in a systematic or methodical way and individually accessible by electronic or other means offered under the terms of this License.

"Database Directive" – Means Directive 96/9/EC of the European Parliament and of the Council of 11 March 1996 on the legal protection of databases, as amended or succeeded.

"Database Right" – Means rights resulting from the Chapter III ("suigeneris") rights in the Database Directive (as amended and as transposed by member states), which includes the Extraction and Re-utilisation of the whole or a Substantial part of the Contents, as well as any similar rights available in the relevant jurisdiction under Section 10.4.

"Derivative Database" – Means a database based upon the Database, and includes any translation, adaptation, arrangement, modification, or any other alteration of the Database or of a Substantial part of the Contents. This includes, but is not limited to, Extracting or Re-utilising the whole or a Substantial part of the Contents in a new Database.

"Extraction" – Means the permanent or temporary transfer of all or a Substantial part of the Contents to another medium by any means or in any form.

"License" – Means this license agreement and is both a license of rights such as copyright and Database Rights and an agreement in contract.

"Licensor" – Means the Person that offers the Database under the terms of this License.

"Person" – Means a natural or legal person or a body of persons corporate or incorporate.

"Produced Work" – a work (such as an image, audiovisual material, text, or sounds) resulting from using the whole or a Substantial part of the Contents (via a search or other query) from this Database, a Derivative Database, or this Database as part of a Collective Database.

"Publicly" – means to Persons other than You or under Your control by either more than 50% ownership or by the power to direct their activities (such as contracting with an independent consultant).

"Re-utilisation" – means any form of making available to the public all or a Substantial part of the Contents by the distribution of copies, by renting, by online or other forms of transmission.

"Substantial" – Means substantial in terms of quantity or quality or a combination of both. The repeated and systematic Extraction or Re-utilisation of insubstantial parts of the Contents may amount to the Extraction or Re-utilisation of a Substantial part of the Contents.

"Use" – As a verb, means doing any act that is restricted by copyrightor Database Rights whether in the original medium or any other; and includes without limitation distributing, copying, publicly performing, publicly displaying, and preparing derivative works of the Database, as well as modifying the Database as may be technically necessary to use it in a different mode or format.

"You" – Means a Person exercising rights under this License who has not previously violated the terms of this License with respect to the Database, or who has received express permission from the Licensor to exercise rights under this License despite a previous violation. Words in the singular include the plural and vice versa.

2.0 What this License covers

2.1. Legal effect of this document. This License is:

- a. A license of applicable copyright and neighbouring rights;
- b. A license of the Database Right; and
- c. An agreement in contract between You and the Licensor.

2.2 Legal rights covered. This License covers the legal rights in the Database, including:

- a. Copyright. Any copyright or neighbouring rights in the Database. The copyright licensed includes any individual elements of the Database, but does not cover the copyright over the Contents independent of this Database. See Section 2.4 for details. Copyright law varies between jurisdictions, but is likely to cover: the Database model or schema, which is the structure, arrangement, and organization of the Database, and can also include the Database tables and table indexes; the data entry and output sheets; and the Field names of Contents stored in the Database;
- b. Database Rights. Database Rights only extend to the Extraction and Re-utilisation of the whole or a Substantial part of the Contents. Database Rights can apply even when there is no copyright over the Database. Database Rights can also apply when the Contents are removed from the Database and are elected and arranged in a way that would not infringe any applicable copyright; and
- c. Contract. This is an agreement between You and the Licensor for access to the Database. In return you agree to certain conditions of use on this access as outlined in this License.

2.3 Rights not covered.

- a. This License does not apply to computer programs used in the making or operation of the Database;
- b. This License does not cover any patents over the Contents or the Database; and
- c. This License does not cover any trademarks associated with the Database.

2.4 Relationship to Contents in the Database. The individual items of the Contents contained in this Database may be covered by other rights, including copyright, patent, data protection, privacy, or personality rights, and this License does not cover any rights (other than Database Rights or in contract) in individual Contents contained in the Database. For example, if used on a Database of images (the Contents), this License would not apply to copyright over individual images, which could have their own separate licenses, or one single license covering all of the rights over the images.

3.0 Rights granted

3.1 Subject to the terms and conditions of this License, the Licensor grants to You a worldwide, royalty-free, non-exclusive, terminable (but only under Section 9) license to Use the Database for the duration of any applicable copyright and Database Rights. These rights explicitly include commercial use, and do not exclude any field of endeavour. To the extent possible in the relevant jurisdiction, these rights may be exercised in all media and formats whether now known or created in the future. The rights granted cover, for example:

- a. Extraction and Re-utilisation of the whole or a Substantial part of the Contents;
- b. Creation of Derivative Databases;
- c. Creation of Collective Databases;
- d. Creation of temporary or permanent reproductions by any means and in any form, in whole or in part, including of any Derivative Databases or as a part of Collective Databases; and
- e. Distribution, communication, display, lending, making available, or performance to the public by any means and in any form, in whole or in part, including of any Derivative Database or as a part of Collective Databases.

3.2 Compulsory license schemes. For the avoidance of doubt:

- a. Non-waivable compulsory license schemes. In those jurisdictions in which the right to collect royalties through any statutory or compulsory licensing scheme cannot be waived, the Licensor reserves the exclusive right to collect such royalties for any exercise by You of the rights granted under this License;
- b. Waivable compulsory license schemes. In those jurisdictions in which the right to collect royalties through any statutory or compulsory licensing scheme can be waived, the Licensor waives the exclusive right to collect such royalties for any exercise by You of the rights granted under this License; and,
- c. Voluntary license schemes. The Licensor waives the right to collect royalties, whether individually or, in the event that the Licensor is a

member of a collecting society that administers voluntary licensing schemes, via that society, from any exercise by You of the rights granted under this License.

3.3 The right to release the Database under different terms, or to stop distributing or making available the Database, is reserved. Note that this Database may be multiple-licensed, and so You may have the choice of using alternative licenses for this Database. Subject to Section 10.4, all other rights not expressly granted by Licensor are reserved.

4.0 Conditions of Use

4.1 The rights granted in Section 3 above are expressly made subject to Your complying with the following conditions of use. These are important conditions of this License, and if You fail to follow them, You will be in material breach of its terms.

4.2 Notices. If You Publicly Convey this Database, any Derivative Database, or the Database as part of a Collective Database, then You must:

- a. Do so only under the terms of this License or another license permitted under Section 4.4;
 - b. Include a copy of this License (or, as applicable, a license permitted under Section 4.4) or its Uniform Resource Identifier (URI) with the Database or Derivative Database, including both in the Database or Derivative Database and in any relevant documentation; and
 - c. Keep intact any copyright or Database Right notices and notices that refer to this License.
- d. If it is not possible to put the required notices in a particular file due to its structure, then You must include the notices in a location (such as a relevant directory) where users would be likely to look for it.

4.3 Notice for using output (Contents). Creating and Using a Produced Work does not require the notice in Section 4.2. However, if you Publicly Use a Produced Work, You must include a notice associated with the Produced Work reasonably calculated to make any Person that uses, views, accesses, interacts with, or is otherwise exposed to the Produced Work aware that Content was obtained from the Database, Derivative Database, or the Database as part of a Collective Database, and that it is available under this License.

a. Example notice. The following text will satisfy notice under Section 4.3: Contains information from DATABASE NAME, which is made available here under the Open Database License (ODbL). DATABASE NAME should be replaced with the name of the Database and a hyperlink to the URI of the Database. "Open Database License" should contain a hyperlink to the URI of the text of this License. If hyperlinks are not possible, You should include the plain text of the required URI's with the above notice.

4.4 Share alike.

a. Any Derivative Database that You Publicly Use must be only under the terms of:

- i. This License;
- ii. A later version of this License similar in spirit to this License; or
- iii. A compatible license.

If You license the Derivative Database under one of the licenses mentioned in (iii), You must comply with the terms of that license.

b. For the avoidance of doubt, Extraction or Re-utilisation of the whole or a Substantial part of the Contents into a new database is a Derivative Database and must comply with Section 4.4.

c. Derivative Databases and Produced Works. A Derivative Database is Publicly Used and so must comply with Section 4.4. if a Produced Work created from the Derivative Database is Publicly Used.

d. Share Alike and additional Contents. For the avoidance of doubt, You must not add Contents to Derivative Databases under Section 4.4 that are incompatible with the rights granted under this License.

e. Compatible licenses. Licensors may authorise a proxy to determine compatible licenses under Section 4.4 a iii. If they do so, the authorised proxy's public statement of acceptance of a compatible license grants You permission to use the compatible license.

4.5 Limits of Share Alike. The requirements of Section 4.4 do not apply in the following:

- a. For the avoidance of doubt, You are not required to license Collective Databases under this License if You incorporate this Database or a Derivative Database in the collection, but this License still applies to this Database or a Derivative Database as a part of the Collective Database;
- b. Using this Database, a Derivative Database, or this Database as part of a Collective Database to create a Produced Work does not create a Derivative Database for purposes of Section 4.4; and
- c. Use of a Derivative Database internally within an organisation is not to the public and therefore does not fall under the requirements of Section 4.4.

4.6 Access to Derivative Databases. If You Publicly Use a Derivative Database or a Produced Work from a Derivative Database,

You must also offer to recipients of the Derivative Database or Produced Work a copy in a machine readable form of:

- a. The entire Derivative Database; or
 - b. A file containing all of the alterations made to the Database or the method of making the alterations to the Database (such as an algorithm), including any additional Contents, that make up all the differences between the Database and the Derivative Database. The Derivative Database (under a.) or alteration file (under b.) must be available at no more than a reasonable production cost for physical distributions and free of charge if distributed over the internet.
- 4.7 Technological measures and additional terms
- a. This License does not allow You to impose (except subject to Section 4.7 b.) any terms or any technological measures on the Database, a Derivative Database, or the whole or a Substantial part of the Contents that alter or restrict the terms of this License, or any rights granted under it, or have the effect or intent of restricting the ability of any person to exercise those rights.
 - b. Parallel distribution. You may impose terms or technological measures on the Database, a Derivative Database, or the whole or a Substantial part of the Contents (a "Restricted Database") in contravention of Section 4.74 a. only if You also make a copy of the Database or a Derivative Database available to the recipient of the Restricted Database:
 - i. That is available without additional fee;
 - ii. That is available in a medium that does not alter or restrict the terms of this License, or any rights granted under it, or have the effect or intent of restricting the ability of any person to exercise those rights (an "Unrestricted Database"); and
 - iii. The Unrestricted Database is at least as accessible to the recipient as a practical matter as the Restricted Database.
 - c. For the avoidance of doubt, You may place this Database or a Derivative Database in an authenticated environment, behind a password, or within a similar access control scheme provided that You do not alter or restrict the terms of this License or any rights granted under it or have the effect or intent of restricting the ability of any person to exercise those rights.

4.8 Licensing of others. You may not sublicense the Database. Each time You communicate the Database, the whole or Substantial part of the Contents, or any Derivative Database to anyone else in any way, the Licensor offers to the recipient a license to the Database on the same terms and conditions as this License. You are not responsible for enforcing compliance by third parties with this License, but You may enforce any rights that You have over a Derivative Database. You are solely responsible for any modifications of a Derivative Database made by You or another Person at Your direction. You may not impose any further restrictions on the exercise of the rights granted or affirmed under this License.

5.0 Moral rights

5.1 Moral rights. This section covers moral rights, including any rights to be identified as the author of the Database or to object to treatment that would otherwise prejudice the author's honour and reputation, or any other derogatory treatment:

- a. For jurisdictions allowing waiver of moral rights, Licensor waives all moral rights that Licensor may have in the Database to the fullest extent possible by the law of the relevant jurisdiction under Section 10.4;
- b. If waiver of moral rights under Section 5.1 a in the relevant jurisdiction is not possible, Licensor agrees not to assert any moral rights over the Database and waives all claims in moral rights to the fullest extent possible by the law of the relevant jurisdiction under Section 10.4; and
- c. For jurisdictions not allowing waiver or an agreement not to assert moral rights under Section 5.1 a and b, the author may retain their moral rights over certain aspects of the Database. Please note that some jurisdictions do not allow for the waiver of moral rights, and so moral rights may still subsist over the Database in some jurisdictions.

6.0 Fair dealing, Database exceptions, and other rights not affected

6.1 This License does not affect any rights that You or anyone else may independently have under any applicable law to make any use of this Database, including without limitation:

- a. Exceptions to the Database Right including: Extraction of Contents from non-electronic Databases for private purposes, Extraction for purposes of illustration for teaching or scientific research, and Extraction or Re-utilisation for public security or an administrative or judicial procedure.
 - b. Fair dealing, fair use, or any other legally recognised limitation or exception to infringement of copyright or other applicable laws.
- 6.2 This License does not affect any rights of lawful users to Extract and Re-utilise insubstantial parts of the Contents, evaluated quantitatively or qualitatively, for any purposes whatsoever, including creating a

Derivative Database (subject to other rights over the Contents, see Section 2.4). The repeated and systematic Extraction or Re-utilisation of insubstantial parts of the Contents may however amount to the Extraction or Re-utilisation of a Substantial part of the Contents.

7.0 Warranties and Disclaimer

7.1 The Database is licensed by the Licensor "as is" and without any warranty of any kind, either express, implied, or arising by statute, custom, course of dealing, or trade usage. Licensor specifically disclaims any and all implied warranties or conditions of title, non-infringement, accuracy or completeness, the presence or absence of errors, fitness for a particular purpose, merchantability, or otherwise.

Some jurisdictions do not allow the exclusion of implied warranties, so this exclusion may not apply to You.

8.0 Limitation of liability

8.1 Subject to any liability that may not be excluded or limited by law, the Licensor is not liable for, and expressly excludes, all liability for loss or damage however and whenever caused to anyone by any use under this License, whether by You or by anyone else, and whether caused by any fault on the part of the Licensor or not. This exclusion of liability includes, but is not limited to, any special, incidental, consequential, punitive, or exemplary damages such as loss of revenue, data, anticipated profits, and lost business. This exclusion applies even if the Licensor has been advised of the possibility of such damages.

8.2 If liability may not be excluded by law, it is limited to actual and direct financial loss to the extent it is caused by proved negligence on the part of the Licensor.

9.0 Termination of Your rights under this License

9.1 Any breach by You of the terms and conditions of this License automatically terminates this License with immediate effect and without notice to You. For the avoidance of doubt, Persons who have received the Database, the whole or a Substantial part of the Contents, Derivative Databases, or the Database as part of a Collective Database from You under this License will not have their licenses terminated provided their use is in full compliance with this License or a license granted under Section 4.8 of this License. Sections 1, 2, 7, 8, 9 and 10 will survive any termination of this License.

9.2 If You are not in breach of the terms of this License, the Licensor will not terminate Your rights under it.

9.3 Unless terminated under Section 9.1, this License is granted to You for the duration of applicable rights in the Database.

9.4 Reinstatement of rights. If you cease any breach of the terms and conditions of this License, then your full rights under this License will be reinstated:

- a. Provisionally and subject to permanent termination until the 60th day after cessation of breach;
- b. Permanently on the 60th day after cessation of breach unless otherwise reasonably notified by the Licensor; or
- c. Permanently if reasonably notified by the Licensor of the violation, this is the first time You have received notice of violation of this License from the Licensor, and You cure the violation prior to 30 days after your receipt of the notice.

Persons subject to permanent termination of rights are not eligible to be a recipient and receive a license under Section 4.8.

9.5 Notwithstanding the above, Licensor reserves the right to release the Database under different license terms or to stop distributing or making available the Database. Releasing the Database under different license terms or stopping the distribution of the Database will not withdraw this License (or any other license that has been, or is required to be, granted under the terms of this License), and this License will continue in full force and effect unless terminated as stated above.

10.0 General

10.1 If any provision of this License is held to be invalid or unenforceable, that must not affect the validity or enforceability of the remainder of the terms and conditions of this License and each remaining provision of this License shall be valid and enforced to the fullest extent permitted by law.

10.2 This License is the entire agreement between the parties with respect to the rights granted here over the Database. It replaces any earlier understandings, agreements or representations with respect to the Database.

10.3 If You are in breach of the terms of this License, You will not be entitled to rely on the terms of this License or to complain of any breach by the Licensor.

10.4 Choice of law. This License takes effect in and will be governed by the laws of the relevant jurisdiction in which the License terms are sought to be enforced. If the standard suite of rights granted under applicable copyright law and Database Rights in the relevant jurisdiction includes additional rights not granted under this License, these additional

rights are granted in this License in order to meet the terms of this License.

Warranty Remedies

Trimble's sole liability and your exclusive remedy under the warranties set forth above shall be, at Trimble's option, to repair or replace any Product that fails to conform to such warranty ("Nonconforming Product"), and/or issue a cash refund up to the purchase price paid by you for any such Nonconforming Product, excluding costs of installation, upon your return of the Nonconforming Product to Trimble in accordance with Trimble's product return procedures than in effect. Such remedy may include reimbursement of the cost of repairs for damage to third-party equipment onto which the Product is installed, if such damage is found to be directly caused by the Product as reasonably determined by Trimble following a root cause analysis.

Warranty Exclusions and Disclaimer

These warranties shall be applied only in the event and to the extent that (a) the Products and Software are properly and correctly installed, configured, interfaced, maintained, stored, and operated in accordance with Trimble's relevant operator's manual and specifications, and; (b) the Products and Software are not modified or misused. The preceding warranties shall not apply to, and Trimble shall not be responsible for defects or performance problems resulting from (i) the combination or utilization of the Product or Software with hardware or software products, information, data, systems, interfaces or devices not made, supplied or specified by Trimble; (ii) the operation of the Product or Software under any specification other than, or in addition to, Trimble's standard specifications for its products; (iii) the unauthorized, installation, modification, or use of the Product or Software; (iv) damage caused by accident, lightning or other electrical discharge, fresh or salt water immersion or spray (outside of Product specifications); or (v) normal wear and tear on consumable parts (e.g., batteries). Trimble does not warrant or guarantee the results obtained through the use of the Product or that software components will operate error free.

THE WARRANTIES ABOVE STATE TRIMBLE'S ENTIRE LIABILITY, AND YOUR EXCLUSIVE REMEDIES, RELATING TO THE PRODUCTS AND SOFTWARE. EXCEPT AS OTHERWISE EXPRESSLY PROVIDED HEREIN, THE PRODUCTS, SOFTWARE, AND ACCOMPANYING DOCUMENTATION AND MATERIALS ARE PROVIDED "AS IS" AND WITHOUT EXPRESS OR IMPLIED WARRANTY OF ANY KIND BY EITHER TRIMBLE NAVIGATION LIMITED OR ANYONE WHO HAS BEEN INVOLVED IN ITS CREATION, PRODUCTION, INSTALLATION, OR DISTRIBUTION INCLUDING, BUT NOT LIMITED TO, THE IMPLIED WARRANTIES OF MERCHANTABILITY AND FITNESS FOR A PARTICULAR PURPOSE, TITLE, AND NON-INFRINGEMENT. THE STATED EXPRESS WARRANTIES ARE IN LIEU OF ALL OBLIGATIONS OR LIABILITIES ON THE PART OF TRIMBLE ARISING OUT OF, OR IN CONNECTION WITH, ANY PRODUCTS OR SOFTWARE. BECAUSE SOME STATES AND JURISDICTIONS DO NOT ALLOW LIMITATIONS ON DURATION OR THE EXCLUSION OF AN IMPLIED WARRANTY, THE ABOVE LIMITATION MAY NOT APPLY OR FULLY APPLY TO YOU.

NOTICE REGARDING PRODUCTS EQUIPPED WITH TECHNOLOGY CAPABLE OF TRACKING SATELLITE SIGNALS FROM SATELLITE BASED AUGMENTATION SYSTEMS (SBAS) (WAAS/EGNOS, AND MSAS), OMNISTAR, GPS, MODERNIZED GPS OR GLONASS SATELLITES, OR FROM IALA BEACON SOURCES: TRIMBLE IS NOT RESPONSIBLE FOR THE OPERATION OR FAILURE OF OPERATION OF ANY SATELLITE BASED POSITIONING SYSTEM OR THE AVAILABILITY OF ANY SATELLITE BASED POSITIONING SIGNALS.

Limitation or Liability

TRIMBLE'S ENTIRE LIABILITY UNDER ANY PROVISION HEREIN SHALL BE LIMITED TO THE AMOUNT PAID BY YOU FOR THE PRODUCT OR SOFTWARE LICENSE. TO THE MAXIMUM EXTENT PERMITTED BY APPLICABLE LAW, IN NO EVENT SHALL TRIMBLE OR ITS SUPPLIERS BE LIABLE FOR ANY INDIRECT, SPECIAL, INCIDENTAL OR CONSEQUENTIAL DAMAGES WHATSOEVER UNDER ANY CIRCUMSTANCE OR LEGAL THEORY RELATING IN ANY WAY TO THE PRODUCTS, SOFTWARE AND ACCOMPANYING DOCUMENTATION AND MATERIALS, (INCLUDING, WITHOUT LIMITATION, DAMAGES FOR LOSS OF BUSINESS PROFITS, BUSINESS INTERRUPTION, LOSS OF BUSINESS INFORMATION, OR ANY OTHER PECUNIARY LOSS), REGARDLESS WHETHER TRIMBLE HAS BEEN ADVISED OF THE POSSIBILITY OF ANY SUCH LOSS AND REGARDLESS OF THE COURSE OF DEALING WHICH DEVELOPS OR HAS DEVELOPED BETWEEN YOU AND TRIMBLE. BECAUSE SOME STATES AND JURISDICTIONS DO NOT ALLOW THE EXCLUSION OR LIMITATION OF

LIABILITY FOR CONSEQUENTIAL OR INCIDENTAL DAMAGES, THE ABOVE LIMITATION MAY NOT APPLY OR FULLY APPLY TO YOU. **PLEASE NOTE: THE ABOVE TRIMBLE LIMITED WARRANTY PROVISIONS WILL NOT APPLY TO PRODUCTS PURCHASED IN THOSE JURISDICTIONS (E.G., MEMBER STATES OF THE EUROPEAN ECONOMIC AREA) IN WHICH PRODUCT WARRANTIES ARE THE RESPONSIBILITY OF THE LOCAL DEALER FROM WHOM THE PRODUCTS ARE ACQUIRED. IN SUCH A CASE, PLEASE CONTACT YOUR TRIMBLE DEALER FOR APPLICABLE WARRANTY INFORMATION.**

Official Language

THE OFFICIAL LANGUAGE OF THESE TERMS AND CONDITIONS IS ENGLISH. IN THE EVENT OF A CONFLICT BETWEEN ENGLISH AND OTHER LANGUAGE VERSIONS, THE ENGLISH LANGUAGE SHALL CONTROL.

Registration

To receive information regarding updates and new products, please contact your local dealer or visit the Trimble website at www.trimble.com/register. Upon registration you may select the newsletter, upgrade or new product information you desire.

Notices

This equipment has been tested and found to comply with the limits for a Class A digital device, pursuant to Part 15 of the FCC rules. These limits are designed to provide reasonable protection against harmful interference when the equipment is operated in a commercial environment. This equipment generates, uses, and can radiate radio frequency energy and, if not installed and used in accordance with the instruction manual, may cause harmful interference to radio communications. Operation of this equipment in a residential area is likely to cause harmful interference, in which case the user will be required to correct the interference at his own expense. Properly shielded and grounded cables and connectors must be used in order to meet FCC emission limits. TRIMBLE is not responsible for any radio or television interference caused by using other than recommended cables and connectors or by unauthorized changes or modifications to this equipment. Unauthorized changes or modifications could void the user's authority to operate the equipment. This device complies with Part 15 of the FCC rules. Operation is subject to the following two conditions: (1) this device may not cause harmful interference, and (2) this device must accept any interference received, including interference that may cause undesired operation. Responsible Party:

Trimble Navigation
935 Stewart Drive
Sunnyvale CA 94085
Telephone: 1-408 481 8000

Canada

This Class A digital apparatus complies with Canadian ICES-003. Cet appareil numérique de la classe A est conforme à la norme NMB-003 du Canada.

This apparatus complies with Canadian RSS-GEN. Cet appareil est conforme à la norme CNR-GEN du Canada.

Europe

This product has been tested and found to comply with the requirements for a Class A device pursuant to European Council Directive 2006/42/EC and 1999/5/EC, thereby satisfying the requirements for CE Marking and sale within the European Economic Area (EEA). Contains a radio module. These requirements are designed to provide reasonable protection against harmful interference when the equipment is operated in a residential or commercial environment.



Australia and New Zealand

This product conforms with the regulatory requirements of the Australian Communications and Media Authority (ACMA) EMC framework, thus satisfying the requirements for C-Tick Marking and sale within Australia and New Zealand.



Waste Electrical and Electronic Equipment (WEEE)

For product recycling instructions and more information, please go to www.trimble.com/ev.shtml.





Recycling in Europe: To recycle Trimble WEEE (Waste Electrical and Electronic Equipment, products that run on electrical power.), Call +31 497 53 24 30, and ask for the "WEEE Associate". Or, mail a request for recycling instructions to:

Trimble Europe BV
c/o Menlo Worldwide Logistics
Meerheide 45
5521 DZ Eersel, NL

Safety Information

Always follow the instructions that accompany a Warning or Caution. The information it provides is intended to minimize the risk of personal injury and/or damage to property. In particular, observe safety instructions that are presented in the following format:

 **WARNING** - This alert warns of a potential hazard which, if not avoided, could result in severe injury or even death.

 **CAUTION** - This alert warns of a potential hazard or unsafe practice which, if not avoided, could result in injury or property damage or irretrievable data loss.

Note – *An absence of specific alerts does not mean that there are no safety risks involved.*

Warnings

Auto guidance

 **WARNING** – Auto guidance systems cannot avoid items in the field such as obstacles. Make sure you are adequately trained to operate the auto guidance system.

 **WARNING** – Many large and sudden changes in satellite geometry caused by blocked satellites can cause significant position shifts. If operating under these conditions, auto-guidance systems can react abruptly. To avoid possible personal injury or damage to property under these conditions, disable the auto-guidance system and take manual control of the vehicle until conditions have cleared.

Calibration

 **WARNING** – Incorrect adjustment of *Manual Override Sensitivity* could cause this critical safety feature to fail, resulting in personal injury or damage to the vehicle. Do not to choose a setting that is either too sensitive or not sensitive enough. It is vital to avoid setting the sensitivity so low that the system will not detect any steering wheel motion.

 **WARNING** – During the Deadzone calibration, the system moves the vehicle's steering wheel. To avoid injury, be prepared for sudden vehicle movement.

 **WARNING** – During flow calibration, the machine will become operational. Take all necessary precautions to ensure user safety. Failure to do so may result in serious injury or death.

 **WARNING** – Material will be dispensed during calibration. Make sure that the implement is safe to operate.

Display



-
-  **WARNING** – When the temperature of the display case reaches 65° C (149 ° F) the display shows the following: WARNING! HOT SURFACE, DO NOT TOUCH. The display will dim the screen until the temperature returns to normal. Use caution when touching the display when this warning is visible.
-

Implement master switch



-
-  **WARNING** – When the implement is down and the master switch is in the On position, the machine is fully operational. Take all necessary precautions to ensure user safety. Failure to do so could result in injury or death.
-

Cautions

Calibration

-
-  **CAUTION** – Obstacles in the field can cause collisions, which may injure you and damage the vehicle. If an obstacle in the field makes it unsafe to continue the Automated Deadzone calibration, stop the vehicle and turn the steering wheel to disengage the system.
- 1) Wait until the display prompts you that the phase is ready to begin.
 - 2) Look at the screen to determine whether the next phase will require a left or right turn.
 - 3) Reposition the vehicle so that the turn will use the space that you have available.
 - 4) Tap the button to begin the next phase.
-
-  **CAUTION** – The wheels can move abruptly during the Steering Proportional Gain procedure while the Autopilot system tests the hydraulic response to its steering commands. To avoid injury, be prepared for vehicle movement.
-





Display

-
-  **CAUTION** – If you leave the display powered on after shutting off the vehicle's ignition, the display power can drain the battery.
-
-  **CAUTION** – Do not press on the screen with a sharp item, such as a pencil. You may damage the surface of the screen.
-
-  **CAUTION** – Do not apply glass cleaner directly to the touchscreen.
-



GNSS interference

-
-  **CAUTION** – The GNSS antenna may experience interference if you operate the vehicle within 100 m (300 ft) of any power line, radar dish, or cell phone tower.
-



Installation

-
-  **CAUTION** – Do not mount the DCM-300 modem in direct sunlight or in areas of high heat. This will cause degraded performance.
-
-  **CAUTION** – Do not attempt to power the display without the TM-200 Module.
-
-  **CAUTION** – If the vehicle has a master electrical disconnect, make sure the power cable ground connections are not directly attached to the battery terminal. Attach the ground connections of the power cable to the chassis side of the main disconnect so that it is as close as possible to the battery, but still gets disconnected when the master disconnect is turned off. Failure to connect the power cable ground will cause damage to the display.
-
-  **CAUTION** – Make sure the vehicle power is off when you are connecting system components.
-
-  **CAUTION** – Wireless, cellular, radio and GNSS signals can interfere with each other. For best performance, mount antennas at least 1 meter away from each other.
-

Vehicle setup

-
-  **CAUTION** – If you select a *Vehicle Profile* that is not suitable for your vehicle, you may experience degraded system performance.
-
-  **CAUTION** – If you delete a vehicle, all information about the vehicle will be erased.
-

USB socket

-
-  **CAUTION** – Do not remove the USB drive from the socket while the display is writing to or from the drive. This will corrupt the data.
-
-  **CAUTION** – Do not use a USB drive in each USB socket at the same time. If you are attempting to upgrade firmware using a USB drive and another USB drive is already in one of the sockets, the firmware upgrade will fail.
-

Data Sheet

- [XCN-2050](#)
- [TM-200 Module](#)
- [AG-815 integrated radio](#)

XCN-2050 display

Technical	
Power	27 volts, 3.5 amps (supplied by the TM-200 Module)
	<div style="border: 1px solid black; padding: 5px;">  CAUTION – Do not attempt to power the display without the TM-200 Module. </div>
Processor	1 GHz quad core
Storage	Primary embedded memory - 32 GByte
Mechanical	
Dimensions	312 mm x 214 mm x 45 mm (plus connectors) (1 ft 8/32 in x 8 1/4 in x 1 49/64 in)
Weight	2.5 kg (5.5 lb)
Mount	4 M6 screws on 75 mm centers (3 inch). VESA MIS-D 75.
Housing	
Material	Magnesium
Environmental Rating	IP55
Temperature	
Operation	0 °C to 65 °C (32 °F to 149 °F)
Storage	-40 °C to 85 °C (-40 °F to 185 °F)
LCD display	
Size	307 mm (1 ft 3/32 in)
Touch screen	Capacitive touch
Resolution	1280 x 800

Front-facing camera

Type	Low light level, color
Resolution	1.3 M pixels

Connections

USB	USB side (side of display), USB rear (back of display)
Ethernet	RJ45 connector. Power input for XCN-2050 display only.

TM-200 Module**Technical**

Power	9 to 16 volts, 25 amps
Storage	64 megabytes (Flash)

Mechanical

Dimensions	209 mm x 184 mm x 57 mm (plus connectors) (8 15/64 in x 7 1/4 in x 2 1/4 in)
Weight	2.54 kg (5.6 lb)
Mount	4 M6 (or #12) screws on 165 mm centers (6.5 inch).

Housing

Material	Aluminum
Environmental Rating	IP55

Temperature

Operation	-40 °C to 65 °C (-40 °F to 149 °F)
Storage	-40 °C to 85 °C (-40 °F to 185 °F)

GNSS

Internal 220 channel GNSS receiver, L1 / L2 / GLONASS capable

Connections	
Power (14-pin Ampseal connector)	Power input CAN 2x Digital In / Out 12 volt power output (non-regulated, fused) Ignition Sense
I / O (12-pin DEUTSCH connector)	CAN RS232 Digital In Digital Out Video In (640 x 480 resolution) NTSC & PAL 12 volt power output
Display Ethernet (White 8-pin Ampseal connector)	Display power 28 volt, 2 amp output Display Ethernet Communications Video Out Ignition Sense
Secondary Ethernet (Black 8-pin Ampseal connector)	Ethernet Communications 12 volt power output Video In
GPS / GNSS (TNC connector)	GPS / GNSS antenna 5 volt

AG-815 integrated radio

Technical	
Power	Via TM-200 module
Mechanical	
Dimensions	144 mm x 81 mm x 52.5 mm (plus connectors) (5 43/64 in x 3 3/16 in x 2 1/16in)

Mechanical

Weight	0.55 kg (1.22 lb)
Mount	The AG-815 module attaches directly to the TM-200 module with four M3 x 16 mm (5/8 in) screws

Housing

Material	Aluminum
Environmental rating	IP55

Temperature

Operation	-40 °C to 65 °C (-40 °F to 149 °F)
Storage	-40 °C to 85 °C (-40 °F to 185 °F)

GNSS

Internal 220 channel GNSS receiver, L1/L2/GLONASS capable

Radio options	450 MHz radio	900 MHz radio
Range	13 km (8 miles); varies with terrain and operating conditions	13 km (8 miles); varies with terrain and operating conditions
Frequency range	430 to 450 MHz, 450 to 470 MHz (region-dependent)	902 to 928 MHz
Networks	20 user-selectable networks	40 user-selectable networks
Wireless data rates	128 Kbps	128 Kbps
Modes	Rover (receive only)	Rover (receive only)

Connections

Radio (TNC connector)	Radio antenna
-----------------------	---------------

Contents

Safety Information	10
Warnings	10
Auto guidance	10
Calibration	10
Display	11
Implement master switch	11
Cautions	11
Calibration	11
Display	11
GNSS interference	12
Installation	12
Vehicle setup	12
USB socket	12
Data Sheet	13
XCN-2050 display	13
TM-200 Module	14
AG-815 integrated radio	15
1 Introduction	31
XCN-2050 display overview	32
Hardware	32
Compatibility	32
About this guide	33
Availability of optional features	33
Your comments	33
Additional Trimble resources	33
Technical assistance	33
Purchase and activation process	34
Purchase in the store	34
Assign a service to the display in the store	34
Assign a license to the display in the reseller portal	35
Deliver services and licenses to the display in the reseller portal	36
Purchase / Activation Flow Diagram	37
Troubleshooting activation	38
I am logged into the store and cannot find the sales order number/service/license.	38
I am logged into the reseller portal and cannot find the licenses and services that I want to activate.	38
I ordered a new license/service, but I got all my QR codes again as well as the QR code for the new license/service.	38
2 Display basics	39

Powering on or off	40
Automatic power on	40
Manual power on	40
Automatic power off	40
Manual power off	40
Getting help	41
Help from the web	41
Touch screen basics	41
Interactive controls	41
Cleaning the touch screen	44
Common controls	44
Lists	44
Menu lists	44
Selection lists	45
On / Off buttons	45
Adjusters	46
Example: Slider bars	46
Example: Increase/decrease adjusters	46
Setup panels	46
On-screen keyboard	47
On-screen number pad	48
Main views	49
Home screen	49
Run screen	49
Field Manager	49
Connected Farm Dashboard	50
Display bar	51
Emergency button	51
Left-side navigation	51
Right-side icons and notification list	51
GNSS notification button	52
Main menu	53
Home screen	54
Field management buttons - left side	54
Setup buttons - right side	55
Run screen	56
Field operation buttons - left side	57
Feature operation buttons - right side	59
Field Manager	61
Access Field Manager	61
Field overview buttons	62
Guidance pattern buttons	62
Boundary buttons	63
Landmark buttons	64

Task history buttons	65
Prescriptions Manager	66
Connected Farm Dashboard	66
Data transfer	67
USB upgrades	67
USB data transfer	68
USB VDB transfer	69
Office Sync data transfer	69
From CFX-750 display or FmX integrated display to XCN-2050 display	70
From XCN-2050 display to CFX-750 display or FmX integrated display	70
From XCN-2050 display to CFX-750 display or FmX integrated display	71
From XCN-2050 display to Farm Works	71
From XCN-2050 display to XCN-2050 display	73
USB socket	74
Insert a USB drive	75
Remove USB Drive	75
Screen shots	75
3 Display settings	77
Display settings	78
Languages and units settings	78
Access	78
Date and time settings	78
Access	79
Users and passwords	79
Add a user	79
Take a photo of a user	79
Access	80
Firmware upgrades - wireless	80
Settings for wireless upgrades	80
Check for updates	81
Feature unlocks	81
Manual code entry	82
QR code scan	82
Check for unlocks	82
Display settings	82
Access	82
Mapping settings	83
Patterns settings	83
Curve Features	83
Headlands	84
Boundaries	84
Access	84
Steering and guidance settings	85

Access	85
ISOBUS settings	87
Task Controller	87
Virtual Terminal	87
Access	87
Wi-Fi settings	87
Access	88
Modem services settings	88
Access	88
Modem settings	88
Network settings	89
Network (CDMA)	89
Network (GSM)	89
Office Sync settings	90
Remote Assistant settings	90
Access	90
Restore defaults	91
Admin User Options	91
Restricted User Options	91
Access	91
System information	92
Access	92
4 Installation	93
Components	94
XCN-2050 display	95
Front view	95
Rear view	96
TM-200 Module	97
DCM-300 modem	98
AG-815 integrated radio	99
Installation overview	100
Install the display and mount	100
Installation and GNSS set up	102
Connect the AG-815 radio to the TM-200 Module	103
Connect the display and TM-200 Module	104
Master disconnect	105
Regular after-market installation	107
Connection for existing OEM harness	109
Connect the DCM-300 modem	111
Connect the AG-25 GNSS antenna	111
Connect additional components	113
5 Connectivity	115

GNSS receiver settings	116
SBAS corrections	118
RangePoint RTX corrections	119
OmniSTAR G2/HP/GR corrections setup	120
CenterPoint RTX setup	121
CenterPoint RTX setup	122
Modem corrections	123
Satellite corrections	124
Standard convergence	125
Fast convergence	125
VRS corrections	126
RTK corrections	127
CAN message settings	130
DCM-300 modem initial setup	130
Office Sync setup	130
Requirements	131
Settings	131
Connectivity concepts	133
GNSS and drift	133
xFill technology	133
Automatic guidance systems	133
Accuracy	134
Dependence on satellite	134
Dependence on base station position	134
Base station survey	135
Base station survey with AutoBase™	135
VRS base station	136
Base station, survey unknown	136
Estimating base station errors	136
When not to use xFill technology	137
VRS	137
Network solution	137
6 Vehicles	139
Vehicle setup	140
Overview of setup	140
Add a vehicle	140
Delete a vehicle	142
Edit a vehicle	143
Save a vehicle	143
Save a complete vehicle profile	144
Save an incomplete vehicle profile	144
Vehicle summary	144
Select a vehicle	145

Manual guidance setup	145
Autopilot system setup	146
Guidance system settings for Autopilot system	146
Controller settings for Autopilot system	147
Sensor settings for Autopilot system	148
Vehicle measurements for Autopilot system	149
OnSwath	151
Autopilot system calibration	152
Calibration for non-tracked vehicles	152
Manual override sensitivity calibration	153
Steering sensor calibration	154
Automated steering deadzone calibration	156
Pre-calibration steps	156
Calibration steps	157
Automated Deadzone error messages	158
Calibration steps	158
Automated Deadzone error messages	159
Proportional steering gain	160
Pre-calibration steps	161
Calibration steps	161
Roll correction calibration	162
Pre-calibration steps	162
Calibration steps	162
Line acquisition	165
Engage aggressiveness	166
EZ-Pilot system setup	167
Guidance selection for the EZ-Pilot system	167
Controller settings for EZ-Pilot system	167
Steering speed settings for EZ-Pilot system	168
Vehicle measurements for EZ-Pilot system	169
EZ-Pilot system calibrations	170
Roll correction for EZ-Pilot system	170
Angle per turn calibration for EZ-Pilot system	171
Online aggressiveness calibration for EZ-Pilot system	171
Line acquisition calibration for EZ-Pilot system	172
EZ-Steer system setup	173
Guidance selection for EZ-Steer system	173
Controller settings for EZ-Steer system	173
Steering and speed settings for EZ-Steer system	173
Vehicle measurements for EZ-Steer system	175
EZ-Steer system calibrations	176
Roll correction for EZ-Steer system	176
Angle per turn calibration for EZ-Steer system	176

7	Fields	179
	Field Basics	180
	Boundaries	180
	Guidance lines and patterns	180
	Landmarks	181
	Tasks, activities and coverage	181
	Add a field	181
	Select a field	182
	Select a field through the map	182
	Select a field from the list	182
	Enter a field (Run screen)	183
	Choose a field to enter	183
	Currently selected field	183
	Field not currently selected	183
	Run screen	184
	Edit a field (Field Manager)	184
8	Implements	187
	Implement setup	188
	Add an implement	188
	Save an implement	188
	Save complete implement settings	188
	Save incomplete implement settings	188
	Select an implement	189
	Edit an implement	189
	Delete an implement	189
	ISOBUS for implements	191
	Task Controller setup	191
	Implement setup for Task Controller	191
	Equipment setup	195
	Application control	196
	Prior to setup	196
	Channel setup	196
	Setup diagram	196
	Add a control channel	197
	Section control	198
	Modules	199
	Width	200
	Latencies	200
	Overlaps	201
	Rate control	202
	Valve/Drive	203
	Width	204

Adjustments	204
Calibrate application control drives	205
Virtual tank/bin	206
Adjustments	207
Summary	207
Modify a control channel	208
Remove a control channel	208
Boom height control	210
Boom height control setup	210
Sensor location	211
Operation settings	212
Calibrate boom height control	215
Boom height calibration steps	215
Boom height manual control test	216
Inputs	219
Add a sensor	219
Type of sensor	219
Location of sensor	219
Alarms	220
SIM	220
Inputs / Sensors calibration	221
Review implement summary	222
Prescriptions	223
Importing prescriptions	223
Exporting prescriptions	223
9 Materials	225
Managing materials	226
Material list	226
Anhydrous	226
Granular fertilizer	226
Liquid	226
Granular seed	226
Row crop seed	227
Add a material	227
Edit a material	229
Delete a material	229
Assign a material to a channel	229
Calibrate material flow	230
Pre-calibration steps	230
Calibration steps	230
10 Operations	233

Preparing for operation	234
Choose a field to enter	234
Currently selected field	234
Field not currently selected	234
Run screen	235
Fields and guidance	235
Tasks	235
Layers	236
Adjustments during operation	236
Automatic transfer of data	236
Tasks	238
Data stored in each task	238
Create a task	238
Add a task (Run screen)	239
Review existing tasks (Field Manager)	239
Review existing tasks (Field Manager)	239
Edit a task (Field Manager)	240
Coverage logging	241
Manual coverage logging	241
Automatic logging with engage	241
Editing layers	241
Vehicle operation	242
Vehicle position	242
Engage status with auto guidance	242
Steering adjustments	244
Guidance adjustments	244
Guidance patterns	246
Guidance creation buttons	246
Boundary creation (Run screen)	248
Boundary editing (Field Manager)	249
Boundary activation/deactivation (Field Manager)	250
AB guidance line creation (Run screen)	251
A+ guidance line creation (Run screen)	252
Curved line creation (Run screen)	252
Headland and infill pattern creation (Run screen)	253
Infill pattern shift	254
Change the infill pattern	256
Pivot pattern creation (Run screen)	258
Guidance pattern editing (Field Manager)	259
Pattern activation/deactivation (Field Manager)	259
Guidance pattern adjustment (Run screen)	260
Guidance pattern shifting (Field Manager)	261
Landmarks	263
Landmark buttons	263

Landmark point creation (Run screen)	264
Landmark line creation (Run screen)	264
Landmark area creation (Run screen)	265
Landmark editing (Field Manager)	265
Layers	267
View coverage layers	267
Edit a coverage layer	268
Field-IQ system operations	270
Field-IQ system Master Switch Box	270
Field-IQ 12-section switch box	271
Relation to master switch box	271
LED status indicators	272
Section control	273
Buttons and indicators	273
Rate control adjustments	274
Boom height control operation	276
Buttons and indicators	276
Boom height adjustments	278
Prescriptions	280
Assign a prescription	280
Use a prescription	281
ISOBUS	282
Task Controller operation	282
On-screen Task Controller switch	283
Virtual Terminal operation	284
Delete previous data	285
On-screen widgets	286
Access widgets	286
Minimize/maximize, resize	286
Move a widget	286
Remove a widget	287
Area status	287
ISOBUS Task Controller widget	288
Position status	289
On-screen lightbar for auto guidance	289
Position	289
Compass	290
Digital compass	290
Swath number	290
Speed status	290
Virtual Terminal widget	290
Alerts and warnings	292
End of row warning	292
Tight turn warning	292

11 Diagnostics / troubleshooting	293
Diagnostics	294
XCN-2050 display	295
The display does not turn on.	295
The display is not responsive.	295
The map is not visible on the Home screen.	295
Autopilot system diagnostics	296
Steering performance for Autopilot system	296
Sensor performance for Autopilot system	297
NMEA messages	298
Boom Height Diagnostics	300
Sensors	300
Boom Status	300
Valve Module	300
Boom Control Status	300
Manual Control	301
DCM-300 modem status	302
EZ-Pilot system diagnostics	303
Steering performance for EZ-Pilot system	303
Sensor performance for EZ-Pilot system	304
DCM-300 modem diagnostics	305
Network Status	305
Device Info	305
Cellular	305
WiFi Network	306
EZ-Steer system diagnostics	307
Steering performance for EZ-Steer system	307
Messages and fault codes	308
Disengaged warning messages	308
System faults	309
Field-IQ diagnostics	311
Operations	311
Adjustments	311
Rate Control	312
Overlaps	312
Latencies	313
Hardware	313
Sensor	313
GNSS and xFill technology status	315
xFill technology status	315
Safety feature	315
xFill technology status buttons	316
GNSS diagnostics	317

Solution Information	317
Skyplot	317
Troubleshooting	318
Poor accuracy (multipath)	319
Intermittent loss of lock on satellite	319
Loss of initialization	319
Not tracking RTK corrections	320
Poor signal / not receiving a clear signal	320
The receiver is not tracking any satellites.	321
Office Sync Diagnostics	321
ISOBUS diagnostics	323
Device tab	323
Recording and saving CAN logs	323
System diagnostics	324
System performance	324
Display	324
Devices	324
Remote Assistant	325
Remote Assistant status	325
TM-200 Module diagnostics	326
LED 1	326
LED 2	326
LED 3	326
LED 3 and 4 combination	326
LED 4	327
12 Glossary	329
	330
A	330
B	330
C	330
D	331
E	332
F	332
G	332
H	333
I	333
L	333
M	334
N	334
P	334
R	335
S	335
T	336

V	336
W	336

Introduction

In this chapter:

XCN-2050 display overview	32
About this guide	33
Purchase and activation process	34
Troubleshooting activation	38

The XCN-2050™ display is an in-cab touch screen display that provides affordable guidance, steering and precision agriculture functionality.

XCN-2050 display overview

The XCN-2050 display is an easy-to-use advanced field management system which consists of both software and hardware.

Hardware

The display's hardware consists of a 30 cm (12") touch-sensitive, color LCD screen.

Compatibility

XCN-2050 display is compatible with the following automated guidance and steering:

- Trimble Autopilot™ automated steering system
- Trimble EZ-Steer® assisted steering system
- Trimble EZ-Pilot® steering system

XCN-2050 display can use an array of additional products to maximize efficiency, including:

- Creating fields and guidance patterns
- Using guidance patterns for automatic guidance systems
- Logging coverage data
- Output of information for analysis in office-based software (for example Farm Works Software® solutions)
- Field-IQ™ Boom Height Control and Spraying
- Variable rate control

About this guide

This manual describes how to install, configure, troubleshoot and use the XCN-2050 display .

Availability of optional features

All available functions are covered in this manual, however, you may not see all of them on your display. The XCN-2050 display includes many optional features. Only the features you have unlocked will be available to you on the display.

Your comments

Your feedback about the supporting documentation helps us to improve it with each revision. Email your comments to ReaderFeedback@trimble.com.

Additional Trimble resources

Sources of related information include the following:

- **Product manuals and other publications** - Access various publications (including product manuals, release notes and quick reference guides) about Trimble products at http://www.trimble.com/Support/Support_AZ.aspx.
- **Trimble training courses** - Consider a training course to help you use the XCN-2050 display to its fullest potential. For more information, go to http://www.trimble.com/Support/Index_Training.aspx.

Technical assistance

If you cannot find the information you need in the product documentation, contact your local reseller.

Alternatively:

1. Go to http://www.trimble.com/support/index_support.aspx.
2. Select the type of support applicable to you.

If you need to contact Trimble technical support:

1. Go to <http://www.trimble.com/global-services/support.aspx>.
2. Click Request Technical Support and login to complete a support request.

Purchase and activation process

To "activate" the XCN-2050 display, after you purchase the display, services and any licenses, you:

- Assign services to the display
- Assign licenses to the display
- Deliver services and licenses to the display

Purchase in the store

Use the login you received from Trimble to log in to the **store** and purchase:

- The XCN-2050 display system
- Licenses (such as Base to High Accuracy positioning)
- Services (such as Office Sync)

Assign a service to the display in the store

1. After you receive the display, find the serial number on the back of the display and make a note of it. Log into the **store** and click the Service Activation tab.



Service Activation

Here you can view and activate services purchased. Activate services by entering the Serial # and customer email address. Then click 'Activate'. Activated services and licenses can be managed at the Reseller Admin Site.

Filter by: Order Number For value: Search Clear

If a confirmation message is required, please specify an email address.

Email ID: Activate

Search Results

Date	Order #	P.O.#	Line #	Part #	Service Description	Year Reference	Serial #
05-MAY-2014	1150675	05052014	1.1	81214-L7	Service, PDK, Office Sync, 12 months	enter text	5149591716
05-MAY-2014	1150675	05052014	1.1	81214-L7	Service, PDK, Office Sync, 12 months	enter text	5457582117
06-DEC-2013	1148395	081262013	2.1	96550-01	TH9-2050/XCN-2050 Base Firmware Activation	enter text	enter text
06-DEC-2013	1148395	081262013	1.1	96550-01	TH9-2050/XCN-2050 Base Firmware Activation	enter text	enter text
06-DEC-2013	1148395	081262013	4.1	96550-01	TH9-2050/XCN-2050 Base Firmware Activation	enter text	5350505704
06-DEC-2013	1148395	081262013	1.1	96550-01	TH9-2050/XCN-2050 Base Firmware Activation	enter text	5350505757
27-NOV-2013	1139373	TH911272013	2.1	96550-01	TH9-2050/XCN-2050 Base Firmware Activation	enter text	5350505775
27-NOV-2013	1139373	TH911272013	2.1	96550-01	TH9-2050/XCN-2050 Base Firmware Activation	enter text	5349505279
27-NOV-2013	1139373	TH911272013	2.1	96550-01	TH9-2050/XCN-2050 Base Firmware Activation	enter text	5349505188
25-SEP-2013	1135377	FW9252013	1.1	83450-06	Remote Assistant - Reseller 12 Months	enter text	enter text

If a confirmation message is required, please specify an email address.

Email ID: Activate

- Find the sales order number of the service you have ordered (for example, the base firmware for the XCN-2050 display).
- Enter the serial number of the display in the Serial Number column.
- Enter the email address of the customer who will be receiving the service. This email address must be associated with an active Connected Farm account.
- Click the **Activate** button. This causes the service (such as the base firmware) to be assigned to the display.

Assign a license to the display in the reseller portal

- Log in to the **reseller portal**.
- At the Activations tab, go to the Available Licenses list. These are the licenses that have not yet been assigned to a display.

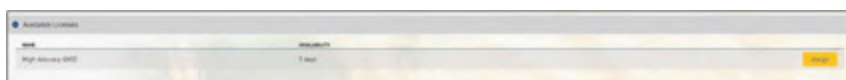

- Find the license you want to assign and click the **Assign** button. A list of display serial numbers opens.
- Select the display serial number that you want to assign the license to and click **Assign**.

Deliver services and licenses to the display in the reseller portal

1. If you are not already logged in, log in to the **reseller portal**.
2. At the Activations tab, find the reseller reference number or customer name (depending on how the customer account was set up) and click it. This expands to show the display serial numbers this customer has.
3. Click the display serial number you want. This expands to show all services and licenses assigned to this display.



SELECT PACKAGE	ENTITLED DATE	ENTITLED BY	
5350505775			Deliver
Base Firmware Activation	2010-01-01	13868 days	
Base Warranty	2014-01-01	750 days	

4. Click **Deliver**. A popup displays.



Deliver Device Entitlements

Selected Device
5350505775

Select Delivery

Download

Email

Cancel Deliver

5. In the popup, choose to either deliver the services/licenses through:
 - Download to a computer. Then you can copy the file to a USB drive and transfer it to the XCN-2050 display.
 - Email containing QR codes to the customer email you enter. The customer can then scan the QR codes into the XCN-2050 display.



Note – Be sure to inform your customers that the email will send all QR codes - existing ones and new ones - in the emails. They only need to scan QR codes for newly purchased services/licenses.

Purchase / Activation Flow Diagram

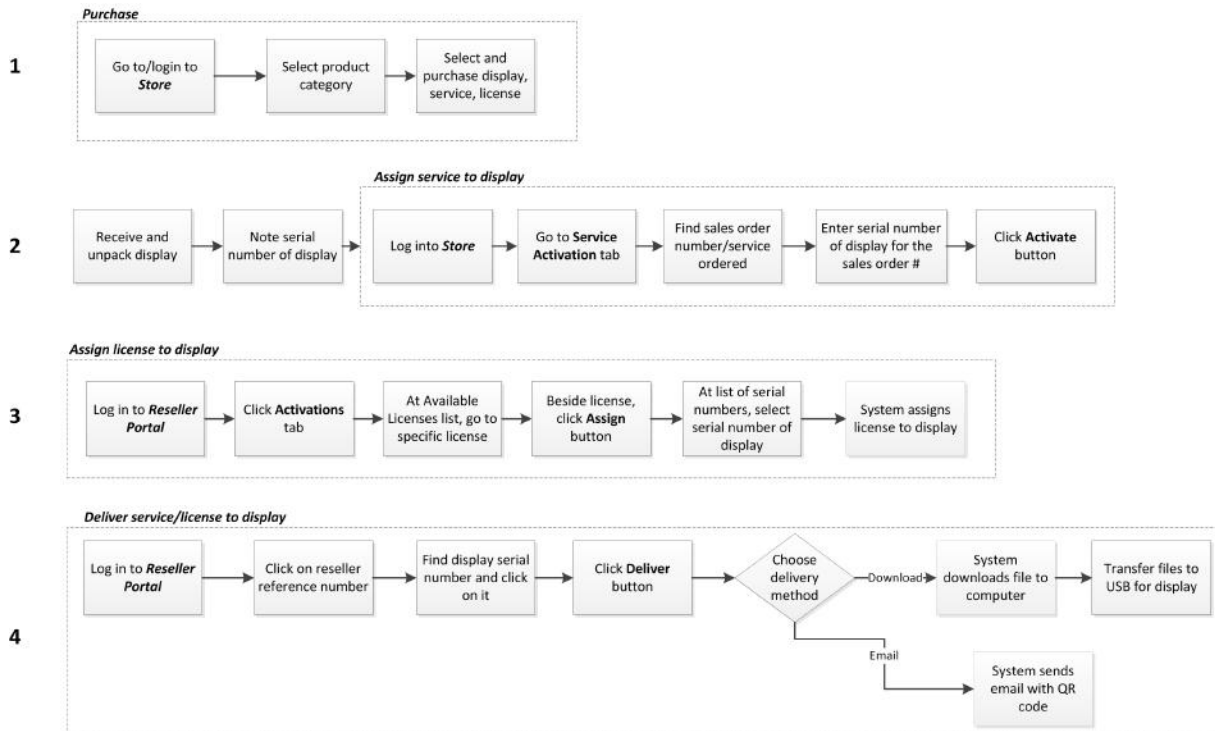

Troubleshooting activation

I am logged into the store and cannot find the sales order number/service/license.

When an item is purchased from the store, it is linked to the login of the person who placed the order. If another person in your company placed the order and you cannot see it, contact technical support and ask them to associate the appropriate logins with your company. Then those employees in your company can see all the orders placed, regardless of who placed the order.

I am logged into the reseller portal and cannot find the licenses and services that I want to activate.

You will not be able to see licenses or services in the reseller portal if your current login:

- Was not the login used to purchase the license and/or service
- Is not linked to the login used to purchase the license and/or service

To have appropriate logins linked, contact technical support.

I ordered a new license/service, but I got all my QR codes again as well as the QR code for the new license/service.

When you receive an email with a QR code for a new license or service, the system sends all the codes related to your display. You only need to scan the QR code for the license/service that has **not** been activated yet.

Display basics

In this chapter:

Powering on or off	40
Getting help	41
Touch screen basics	41
Common controls	44
Main views	49
Display bar	51
GNSS notification button	52
Main menu	53
Home screen	54
Run screen	56
Field Manager	61
Prescriptions Manager	66
Connected Farm Dashboard	66
Data transfer	67
USB socket	74
Screen shots	75

The XCN-2050 display is a touch screen that responds to common touch screen interactions. The **Home** and **Run** screens as well as the Field Manager are covered in this chapter.

Powering on or off

Note – The display must be correctly installed **before** powering on. For more information, see [Installation overview, 100](#) and [XCN-2050 Display Cabling Guide](#).

Automatic power on

If the display is connected to the ignition source, power on the vehicle. The TM-200 Module sends power to the display when the vehicle powers on.

Manual power on

To turn on the display manually, hold the power button down briefly (about half a second). For a photo of the rear view showing the power button, see [XCN-2050 display, 95](#).

The display powers on, and after a short pause the **Home** screen displays.

Automatic power off

If the display is connected to the ignition source, when you switch the ignition off, a shutdown/reboot dialog displays. If you do nothing the display shuts off in 60 seconds. If you choose not to shutdown the display, it will remain powered on indefinitely.



CAUTION – If you leave the display powered on after shutting off the vehicle's ignition, the display power can drain the battery.

Manual power off

To manually turn the power off, hold the power down button for one to two seconds. See the steps below.



1. Turn off the display manually by holding the power button down for about two seconds.
2. Choose one of the following options:
 - Shutdown: Powers down the display
 - Reboot: Restarts the display
 - Cancel: Cancels the power off process

Note – Sometimes after you press the power button and tap **Shutdown**, the display does not immediately turn off. This is because the display is saving settings. The display will power off after all settings are saved.

If these steps do not cause the power to go off, you can force a shut down of the display by holding the power button for 5 seconds.

Getting help

You can access helpful information about each screen and about the entire XCN-2050 display.

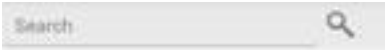
To access...	Tap...	Explanation
Help about a screen		Tap the question mark button. The User Guide displays at the appropriate section.
Help from the menu	 to launch the menu.	At the menu, tap  . The User Guide displays with navigation on the left-hand side.
Search	Search box 	In the search box, you can enter: <ul style="list-style-type: none"> • One or more words. The search results will list information that contain that one or more of the words or variations of them, with the most relevant at the top. • An exact phrase with quotation marks (for example, "add a field"). The search results will list only the information that contain the exact phrase inside the quotation marks.

Help from the web

To obtain the User Guide from the web, go to http://www.trimble.com/Support/Support_AZ.aspx.

Touch screen basics

If you are unfamiliar with using a touch screen, this section contains the basics of using a touch screen and how to clean it.

Interactive controls

Use your fingers to interact with buttons, maps, lists and selectors.

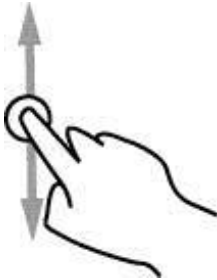

CAUTION – Do not press on the screen with a sharp item, such as a pencil. You may damage the surface of the screen.

Item	Action	Explanation
Buttons and selectors	Tapping 	<p><i>Tap</i> means to touch a point on the screen and then remove your finger from the screen.</p> <p>A <i>tap</i> is a single touch. You do not move your finger while touching the screen. You tap buttons, items in lists, points on a range, and so on.</p>
Lists	Scrolling 	<p>When a list has more items than fit on a screen or in a box, you can move the list to see all items by scrolling up, down, or side to side. To scroll:</p> <ol style="list-style-type: none">1. Touch anywhere in the list and hold your finger on the screen.2. Move your finger in the direction that you want to move the list - left, right, up or down.3. Remove your finger when you are satisfied with the position of the list. <p>For examples of lists, see Lists, 44.</p>

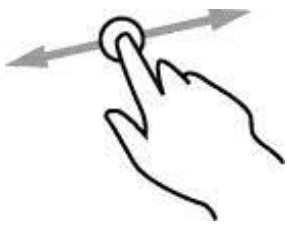
Item	Action	Explanation
Home and Run screens, Field Manager	Zooming in and out 	<p>You can enlarge the view to see more detail (zoom in) or reduce the view to see less detail but more area (zoom out). To zoom in:</p> <ol style="list-style-type: none"> 1. Touch the screen where you want to see more detail with your thumb and a finger close together (or you can use two fingertips). 2. Move your fingers apart while still touching the screen. 3. Remove your fingers from the screen when you are satisfied with the zoom level. <p>To zoom out:</p> <ol style="list-style-type: none"> 1. Touch the screen where you want to reduce the level of detail with your thumb and a finger an inch or more apart (or you can use two fingertips) 2. Move your fingers together while still touching the screen. 3. Remove your fingers from the screen when you are satisfied with the zoom level.
On the Home screen	Panning 	<p>Panning in a map on the Run screen moves the map left or right.</p> <p>Panning means you can shift the view to show information that is not in view on the screen.</p> <ol style="list-style-type: none"> 1. Touch anywhere on the screen with your finger and hold it on the screen. 2. Move your finger in the direction that you want to move the map. 3. Remove your finger when you are satisfied with the position of the map.

Cleaning the touch screen

 **CAUTION** – Do not press on the screen with a sharp item, such as a pencil. You may damage the surface of the screen.

Use the following supplies to clean the touch screen of the display:

- Ammonia-free glass cleaner
- Soft, lint-free cotton cloth
- 50% isopropyl alcohol

 **CAUTION** – Do not apply glass cleaner directly to the touchscreen.

1. Apply a small amount of ammonia-free glass cleaner to the cloth.
2. Gently rub the touchscreen with the cloth.
3. To remove stains or smudges, use a cotton cloth dampened with 50% isopropyl alcohol.



Tip – Clean the touch screen while it is powered down. It is easier to see dirt and fingerprints when the touch screen is dark.

Common controls

Common controls provide a way for you to:

- Complete settings and configuration with [Setup panels, 46](#)
- Enter information using an [On-screen keyboard, 47](#) and [On-screen number pad, 48](#)
- Work with [Lists, 44](#)
- Turn an option on or off with [On / Off buttons, 45](#)
- Choose values within a range using [Adjusters, 46](#)

Lists

Lists vary depending on their function.

Menu lists

Menu lists contain a list of items that lead to additional information or areas.

- Tap a list item to reveal additional information or choices to the right of the menu.
- Some lists have expand/collapse capabilities. Tap the up or down arrow to expand and collapse sections.

Tap a list item to reveal additional information or choices to the right of the menu.



Some lists have expand/collapse capabilities. Tap the up or down arrow to expand and collapse sections.



Selection lists

Some lists contain items for you to select. If the list is longer than what is in your view, a scroll bar displays to the right of list items. You can use this to scroll up and down the list. After you tap your selection on the list, the list closes.

On / Off buttons

On/off buttons enable you to turn items on and off.

The red X indicates this item is turned off. Tap to turn the item on.



The green check mark indicates this item is turned on. Tap to turn the item off.



Adjusters

With adjusters, you can select a value from an available range.

Example: Slider bars

The pointer (rectangular button on the slider bar) indicates the value.



To use the slider bar, you can:

- Change the value by increments - Tap on the plus/minus signs at each end of the slider bar, in the direction that you want to move the pointer.
- Move to a value:
 - a. Touch the pointer on the slider bar.
 - b. Move the pointer toward the minus or plus sign.
 - c. Remove your finger when you are satisfied with the position of the pointer.
- Enter an exact number - If the screen also has a button showing the value, tap it. Then use the on-screen number pad to enter the number.

Example: Increase/decrease adjusters



Adjusters with plus and minus buttons enable you to increase or decrease the number by tapping the plus/minus buttons. You can also tap on the number and enter the number using the on-screen keyboard/number pad.



Setup panels



Panels display so that you can setup or configure items. Panels include a set of controls specifically for that setup or configuration.





Button	Explanation
Next	Tap to go to the next section. (Displayed within the setup panel.)
Back	Tap to go to the previous section. (Displayed within the settings panel.)
Sections of setup	Tap various buttons at the top of the panel to go to section out of sequence after initial setup.
	Within the setup panel at the Summary section, tap to save the settings you currently entered and end the setup process.
	Tap Home on the display bar at the bottom of the screen to exit the setup process without saving any currently entered settings. (See Display bar, 51.)

On-screen keyboard





The on-screen keyboard displays when you tap a field for entering information. You can enter text or numbers.

To:	Tap...
Enter number(s)	The number on the on-screen keyboard
Enter letter(s)	The letter on the on-screen keyboard
Delete letters or numbers	
Remove all the letters or numbers you have entered	 and hold down

To:	Tap...
Cause the keyboard to no longer display	 

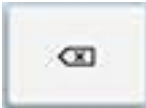
On-screen number pad

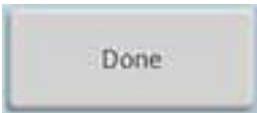
The on-screen number pad displays when you tap a field for entering a number.

To:	Tap...
Enter a number	The number
Delete number(s)	
Remove all the numbers you have entered	 and hold down
Cause the keyboard to no longer display	 

Main views

The XCN-2050 display has different screens for your work.

Home screen

The [Home screen, 54](#) is primarily for setting up, including:

- Adding fields
- Creating, setting up and calibrating vehicles, implements and materials



Run screen

At the [Run screen, 56](#), you:

- Perform field activities
- Create guidance mapping elements (boundaries, guidance patterns, and landmarks)
- Make adjustments to steering guidance, and rate and section control
- Log coverage



Field Manager

At the Field Manager™ ([Field Manager, 61](#)), you:

- Activate the guidance mapping elements you want to follow
- Edit and refine guidance mapping elements

- Associate fields to clients and farms
- Continue a task or begin a new task



Connected Farm Dashboard

The [Connected Farm Dashboard, 66](#) allows you access your fields and data with an Internet connection (including wireless). (Requires subscriptions and DCM-300 modem.)



Display bar



CAUTION – Do not press on the screen with a sharp item, such as a pencil. You may damage the surface of the screen.

The display bar is always displayed at the bottom of the screen on the XCN-2050 display.



Emergency button



In the middle of the bar, the Emergency button is displayed at all times. To cancel all functions controlled by the display, tap .

Note – Tapping this button does not turn the vehicle off. It only cancels display-controlled functions such as automatic steering systems.

Left-side navigation

The left side of the bar contains navigation buttons.

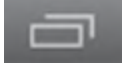

Navigation Button	Tap to...
	Return to the previous screen.
	Go to the Home screen.
	View your most recent views and go to the one of your choice.

Right-side icons and notification list

The right side of the bar contains icons to indicate status, display the time of day, and features being used.



Tap on the right side of the bar to access a list that slides up containing notifications. To close this list, tap anywhere on the screen other than the list.





Tap specific buttons in the notification list to immediately access:

- The main menu
- Details about the status of GNSS, xFill technology, satellites and cellular connection
- Other status items

Also see [GNSS notification button, 52](#).







GNSS notification button

A GNSS notification button displays on the display bar to indicate the status of your GNSS connection. When you tap the button, the system takes you to the Diagnostics screen for any troubleshooting you want to do.

Notification Button	Indicates...
 Green	GNSS connection is normal.
 Yellow	GNSS connection is converging.
 Red	No GNSS connection is available.

Main menu

Tap  on the **Home** and **Run** screens and on the notification list to access the main menu. A panel of buttons displays that you can tap to access the following areas.

Button	Tap to...
	Display the Diagnostics screen. See Diagnostics, 294 .
	Open the display settings screen. See System information, 92 .
	Display the User Guide. See Getting help, 41 .
	Display the Data Transfer panel. See Data transfer, 67 .
	Open the Remote Assistant. See Remote Assistant, 325 .
	Open the Virtual Terminal to set up ISO-certified equipment for Task Controller. This button does not display on the main menu unless you have turned on Virtual Terminal in Settings (see ISOBUS settings, 87). See Equipment setup, 195 .

Home screen



CAUTION – Do not press on the screen with a sharp item, such as a pencil. You may damage the surface of the screen.

When you turn on the XCN-2050 display, the **Home** screen displays, showing a background of one of the following:

- With a functioning DCM-300 modem and a GNSS/GPS fix: A satellite image of the area.
- Without a functioning DCM-300 modem: A blank screen.

At the **Home** screen, you can complete tasks for setup and for managing fields, including:







- Set up and select vehicles, implements and materials
- Set up GNSS
- View the Connected Farm dashboard
- Create fields
- Enter the Field Manager to edit and refine fields and guidance boundaries and patterns
- Enter the **Run** screen to perform field activities

Buttons on the **Home** screen include:

- [Field management buttons - left side, 54](#) on the left side of the screen
- [Setup buttons - right side, 55](#) on the right side of the screen





Field management buttons - left side

Buttons on the left side of the **Home** screen are for field management.

Button	Tap to...
Hide 	Hide field operation buttons on the left side of the screen.
Show 	Show field operation buttons on the left side of the screen
Add field 	Add a new field. See Add a field, 181 .
List fields 	Show a list of existing fields. Tap the name of the field to select it. Tap again to hide the list of fields. See Select a field, 182 .
Field Manager 	Open Field Manager for the selected field. See Field Manager, 61 .
Connected Farm 	Open the Connected Farm™ dashboard. (Requires a connected DCM-300 modem.) See Connected Farm Dashboard, 66 .
Enter Field 	Begin field activities by entering the Run screen. (You must select a vehicle, implement, and field first.) The Run screen displays, where you can perform field activities, including: <ul style="list-style-type: none"> • Engage guidance • Log coverage for current operations • Create boundaries, guidance patterns, landmarks, and so on See Run screen, 56 .

Setup buttons - right side

Buttons on the right side of the **Home** screen are primarily for setup.

Button	Tap to...
Menu 	Access the main menu. See Main menu, 53 .
GNSS 	Set up GNSS. See GNSS receiver settings, 116 .
Vehicle 	Add, edit or select a vehicle, as well as set up and calibrate an assisted guidance system such as the Autopilot, EZ-Pilot, or EZ-Steer system. See Add a vehicle, 140 .
Implement 	Add, edit or select an implement. Set up and calibrate features for implements such as: <ul style="list-style-type: none"> • The Field-IQ system Rate and Section Control • The Field-IQ system Boom Height Control • Implement lift switches and sensors See Implement setup, 188 .
Material 	Add, edit, and select materials. See Managing materials, 226 .

Run screen

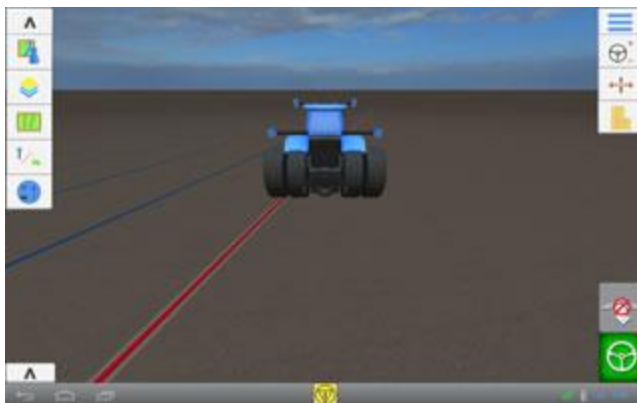



CAUTION – Do not press on the screen with a sharp item, such as a pencil. You may damage the surface of the screen.

The **Run** screen enables you to perform field operations such as:

- Creating guidance boundaries and patterns
- Accessing Field Manager to edit and refine guidance boundaries and patterns
- Using auto guidance (with Autopilot, EZ-Pilot or EZ-Steer)
- Controlling sections automatically or manually (with Field-IQ)
- Controlling rate application for liquids (with Field-IQ)
- Controlling boom height automatically (with Field-IQ)
- Planting and nutrient pest management (in a future release)
- Harvesting (in a future release)
- Monitoring seeding (in a future release)
- Row guidance and implement control (in a future release)
- Water management (in a future release)

Before you can enter the **Run** screen to perform field activities, you must:

- Select a vehicle (see [Select a vehicle, 145](#))
- Select an implement (see [Select an implement, 189](#))
- Select a field (see [Select a field, 182](#))
- Have a GNSS connection (see [GNSS receiver settings, 116](#))





For more information on selecting a vehicle, field and implement, see [Preparing for operation, 234](#).



Buttons on the **Run** screen include:

- [Field operation buttons - left side, 57](#) on the left side of the screen
- [Feature operation buttons - right side, 59](#) on the right side of the screen

Field operation buttons - left side

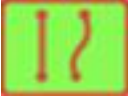

Buttons for field operation enable you to create guidance and landmark elements, view map layers, show or hide status widgets and access Field Manager.







Button	Tap to...
Hide 	Hide field operation buttons on the left side of the screen.
Show 	Show field operation buttons on the left side of the screen.
Field Manager 	Open Field Manager for the selected field. See Field Manager, 61 .
Layers 	View various map layers. Layers represent activities that have occurred. For example, a layer can show the coverage completed so far or the speed traveled over an area. See Layers, 267 .
Guidance Lines and Patterns 	Open the guidance buttons to create: <ul style="list-style-type: none"> • Boundaries See Boundary creation (Run screen), 248. • Guidance lines. See: <ul style="list-style-type: none"> • A+ guidance line creation (Run screen), 252 • AB guidance line creation (Run screen), 251 • Curved line creation (Run screen), 252 • Pivot patterns See Pivot pattern creation (Run screen), 258. • Headlands See Headland and infill pattern creation (Run screen), 253. Also see Pattern activation/deactivation (Field Manager), 259 .

Button	Tap to...
Landmarks 	View options to create: <ul style="list-style-type: none"> • Line See Landmark line creation (Run screen), 264. • Areas See Landmark area creation (Run screen), 265. • Points See Landmark point creation (Run screen), 264.
Prescriptions 	Open the Prescriptions Manager. See: <ul style="list-style-type: none"> • Prescriptions Manager, 66 • Prescriptions, 223 • Assign a prescription, 280
Widgets 	Open the widget menu to add individual widgets, add all widgets or remove all widgets. See On-screen widgets, 286.

Feature operation buttons - right side

Using feature operation buttons, you can make adjustments to various features while performing field activities. With the exception of the **Menu** button, these buttons are specific to applications and depend on which features you are using.

Button	Tap to...
Menu 	Access the main menu. See Main menu, 53.
Adjust Steering 	View options: <ul style="list-style-type: none"> • Adjust vehicle aggressiveness • Enable or disable autosteering See Steering and guidance settings, 85.

Button	Tap to...
Adjust Guidance 	View options to adjust: <ul style="list-style-type: none"> • Nudge • Re-mark • Implement Draft Correction See Guidance pattern adjustment (Run screen), 260 .
Adjust Rate Control 	View options to adjust: <ul style="list-style-type: none"> • Actual and Target Rate • Status of Rate Channel • Sensor Status See Rate control adjustments, 274 .
Adjust Boom Height 	View options to adjust the boom height: <ul style="list-style-type: none"> • Target Height • System Aggressiveness • Ground or Canopy • Sensors See Boom height adjustments, 278 .
Logging 	Begin logging your field activity, such as coverage. See and Mapping settings, 83 .
Engage Auto Guidance 	Engage your auto guidance system. See Vehicle operation, 242 .
Engage Boom Height 	Engage your boom height system. See Boom height control operation, 276 .

Field Manager

At the Field Manager, you edit and refine elements in and associated with each field.





The Field Manager shows information directly associated with the field you have selected and enables you to perform functions listed in the following table.

Note – Add and select a field before entering Field Manager. See [Add a field, 181](#) and [Select a field, 182](#).



Section	Functions Available
Field Overview See Field overview buttons, 62 .	<ul style="list-style-type: none"> Rename the field, client and farm. Delete the field. See Edit a field (Field Manager), 184 .
Guidance Patterns See Guidance pattern buttons, 62 .	<ul style="list-style-type: none"> Activate or deactivate lines and patterns. Shift a line. Adjust the radius of a pattern. Resize a shape (other than pivot shape). See Guidance patterns, 246 .
Boundaries See Boundary buttons, 63 .	<ul style="list-style-type: none"> Activate or deactivate a boundary. Resize a boundary. Rename a boundary. See Boundary editing (Field Manager), 249 .
Landmarks See Landmark buttons, 64 .	<ul style="list-style-type: none"> Edit, delete or rename a landmark. Change the category that a landmark is assigned to. See Landmark editing (Field Manager), 265.
Task History See Task history buttons, 65 .	<ul style="list-style-type: none"> Start a new task. Rename a task. See Tasks, 238.

Access Field Manager



You can access the Field Manager from either the **Home** or **Run** screen.







- At the **Home** screen, select a field (see [Select a field, 182](#)). Tap .
- At the **Run** screen, tap . The Field Manager opens the field you are currently in.

Field overview buttons

Button or Entry Box	Tap to...
	Exit Field Manager.
	Delete an item
Field name	Edit the field name.
Client name	Enter the name of the client (optional).
Farm name	Enter the name of the farm (optional).





Guidance pattern buttons

Button or Entry Box	Tap to...
<p>Deactivate</p>  <p>(Black)</p>	<p>Deactivate a line.</p> <p>For more information, see Pattern activation/deactivation (Field Manager), 259.</p>
<p>Activate</p>  <p>(Red)</p>	<p>Activate a line.</p> <p>See Pattern activation/deactivation (Field Manager), 259.</p>



Button or Entry Box	Tap to...
 <p>(Black)</p>	<p>Deactivate Shape Deactivate a pattern (headland, boundary, pivot). See Pattern activation/deactivation (Field Manager), 259.</p>
 <p>(Red)</p>	<p>Activate Shape Activate a pattern (headland, boundary, pivot). For more information, see Pattern activation/deactivation (Field Manager), 259.</p>
	<p>Adjust the radius of a pivot shape. For more information, see Guidance pattern editing (Field Manager), 259.</p>
	<p>Resize a shape other than a pivot shape. See Guidance pattern editing (Field Manager), 259.</p>
	<p>Shift a line. See Guidance pattern editing (Field Manager), 259.</p>
	<p>Delete a selected line or pattern.</p>
<p>Name of Pattern</p>	<p>Change the name of the line or pattern.</p>

Boundary buttons

Button or Entry Box	Tap to...
 <p>(Black)</p>	<p>Deactivate Shape Deactivate a pattern (headland, boundary, pivot). See Pattern activation/deactivation (Field Manager), 259.</p>

Button or Entry Box	Tap to...
<p>Activate Shape</p>  <p>(Red)</p>	<p>Activate a pattern (headland, boundary, pivot). See Pattern activation/deactivation (Field Manager), 259.</p>
	<p>Adjust the radius of a pivot shape. For more information, see Guidance pattern editing (Field Manager), 259.</p>
	<p>Resize a shape other than a pivot shape. See Guidance pattern editing (Field Manager), 259.</p>
	<p>Shift a line. See Guidance pattern editing (Field Manager), 259.</p>
	<p>Delete a selected boundary.</p>
<p>Boundary Name</p>	<p>Change the name of the highlighted boundary.</p>

Landmark buttons

Button or Entry Box	Tap to...
<p>Category</p> 	<p>Assign a category to a landmark point, line or area. For more information, see Pattern activation/deactivation (Field Manager), 259.</p>
<p>Convert</p> 	<p>Convert a selected:</p> <ul style="list-style-type: none"> • Productive area to a non-productive one • Non-productive area to a productive one <p>See Pattern activation/deactivation (Field Manager), 259.</p>

Button or Entry Box Tap to...

Delete a selected landmark.

Landmark Name Change the name of the highlighted landmark.

Task history buttons**Button or Entry Box** Tap to...**Continue Task**

Continue the task you have selected in the list on the right-hand side.

See [Tasks, 238](#).



Start New Task Begin a new task.

Task Name Change the name of the highlighted task.

Prescriptions Manager

At the Prescriptions Manager, you assign a prescription to a channel and determine additional settings related to the prescription. You can access the Prescriptions Manager from the **Run** screen,

tap . The Prescriptions Manager displays.

Item	Tap to...
Enabled Channels list	Select the channel you want to assign a prescription to.
Prescription File Name	Show a list of prescription files associated with the field you have selected.
Column Name	Show the columns that are a part of the prescription file.
Column Units	Show the unit type you will be using for the prescription.
Lead Time	Enter the lead time before the application begins.
When Outside Prescription	Choose what happens when you are outside of the prescription boundary. Close (default), Default Rate or Last Rate.
Finish	Let the system know your entries are complete.
Next	Go to the next settings for prescription assignment.
Back	Go to the previous settings for prescription assignment.
	Save your settings and exit the Prescriptions Manager.
	Remove any edits to the settings and exit the Prescription Manager.

Connected Farm Dashboard

The Connected Farm dashboard enables you to access your fields from a wired connection, or wireless Internet connection using a DCM-300 modem.



Feature	Description	Requirements and Restrictions
Rainfall	Check rainfall totals for a location for the past 24 hours without the use of physical rain gauges. Updates every 10 minutes.	Requires subscription to RainWave.
Weather	<ul style="list-style-type: none"> Add a single or multiple locations to view current temperature, wind speed, wind direction, humidity, and chance of precipitation. View the weather forecast for each location. Set up a Doppler radar map to show upcoming weather patterns. 	Doppler radar map available in the United States and Canada only
Commodities	<ul style="list-style-type: none"> Create your own commodity list and rearrange it to your preference. View the previous day's closing price for each commodity. 	US only



Data transfer

You can transfer data:

- Using a USB drive
- Wirelessly with Office Sync
- To another display

USB upgrades

To upgrade firmware with a USB drive, follow the next steps.

1. Turn off the display manually by holding the power button down for about two seconds.
2. Tap **Shutdown**. The display powers off and saves a backup of the database.
3. Power on the display by holding down the power button briefly (about one half of a second).
4. Insert the USB drive into one of the USB sockets on the display.
5. Tap  on the **Home** or **Run** screen.
6. Tap .
7. The display notifies you that an upgrade is available.
8. Choose the version you want to upgrade to.
9. Tap the checkmark to continue the firmware upgrade.



USB data transfer

The following steps explain how to transfer your data from a XCN-2050 display to a USB drive.

Note – Make sure your USB drive has the AgGPS folder on the root.

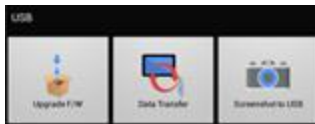
1. Insert the USB drive into one of the USB sockets on the display.
2. Tap  on the **Home** or **Run** screen, or on the notification list. (For instructions on how to display the notification list, see [Display bar, 51.](#)) The USB menu displays:



3. Tap . The Data Transfer panel displays.
4. To expand an item on either list, tap a category name.
5. To select all files in a category, tap the box beside the category name. A check mark displays.
6. To deselect all files in a category, tap the box beside the name.
7. To select an individual file, tap the box beside the file name.
8. Tap  to move the item to the USB drive.
9. To delete an item, tap the box next to the item in either list and tap .

Note – You cannot delete an item that is actively selected or currently being transferred.

For information on: See also:

USB socket

[USB socket, 74](#)

USB VDB transfer

When you transfer data, saved vehicles do not include the vehicle configuration file (.vdb) for Autopilot. To transfer this configuration data:

1. Connect a laptop that has AP Toolbox software to the serial port of the Nav Controller II that contains the vehicle config file you want.
2. Using AP Toolbox, save the config (.cfg) file to the laptop.
3. Transfer the saved config file from the laptop to a USB drive in the folder AgData/Profiles.
4. Insert the USB drive containing the config file in the USB socket of the XCN-2050 display.

Office Sync data transfer

With a DCM-300 modem, and a subscription to Office Sync, information can wirelessly transfer from the display to the office or Connected Farm, including wireless upgrades. This requires:

- A Connected Farm account
- Unlock for Office Sync
- DCM-300 modem
- A data plan or access to WiFi

As part of Office Sync setup, you decide:

- How often you want the display to check the server for data transfer
- How often data is sent from the display to the office
- Whether to send the data automatically or after you have confirmed to send data



When Office Sync is transferring data,  displays in the display bar.

For information on: See:

Settings for Office Sync [Modem services settings, 88](#)

Diagnostics [Data transfer, 67](#)



From CFX-750 display or FmX integrated display to XCN-2050 display

To move files from the CFX-750 display or FmX integrated display to the XCN-2050 display, follow the steps below.

Note – Make sure your USB drive has the AgGPS folder on the root.

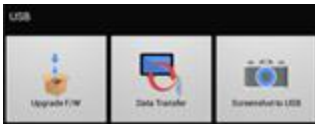
1. Insert the USB drive into the CFX-750 display or FmX integrated display.
If files were created on the CFX-750 display, change the file extension from .CFG to .cfg before transferring them to the XCN-2050 display.
2. Transfer the files from the display to the USB drive.
3. Remove the USB drive from the CFX-750 display or FmX integrated display.
4. Insert the USB drive into one of the USB sockets on the XCN-2050 display.
(See [USB socket, 74](#).)
5. Tap  on the **Home** or **Run** screen, or on the notification list launched from the display bar. The USB menu displays.



6. Tap . The Data Transfer panel displays.
Note – Whether you are transferring data from the CFX-750 display or FmX integrated display, the item in the USB list will show the data as FmX integrated display data.
7. Tap an item to expand it on the USB list.
8. Tap the item(s) you want to transfer.
9. Tap  to move the item(s) to the internal list.
10. To delete an item, tap the item in either list and tap .

From XCN-2050 display to CFX-750 display or FmX integrated display

To transfer from XCN-2050 display to the CFX-750 display or FmX integrated display using USB or Office Sync, the same steps as the previous examples apply, except: All data transferred from the XCN-2050 display must be "decoded" by Farm Works software before it can be used by these legacy displays.

Data can then be transferred by USB drive from the desktop (using Farm Works) to the CFX-750 display or FmX integrated display.

Note – Make sure your USB drive has the AgGPS folder on the root.

From XCN-2050 display to CFX-750 display or FmX integrated display

To transfer from XCN-2050 display to the CFX-750 display or FmX integrated display using USB or Office Sync, the same steps as the previous examples apply, except: All data transferred from the XCN-2050 display must be "decoded" by Farm Works software before it can be used by these legacy displays.

Data can then be transferred by USB drive from the desktop (using Farm Works) to the CFX-750 display or FmX integrated display.

Note – Make sure your USB drive has the AgGPS folder on the root.

From XCN-2050 display to Farm Works

To transfer files from the XCN-2050 display to Farm Works, follow the steps below.

Note – Make sure your USB drive has the AgGPS folder on the root.

1. If you are transferring using a USB drive, insert the drive into your computer and open Farm Works. If you have transferred the data using Office Sync, open Farm Works.
2. Open the **Read Job Data** dialog by clicking either of these:

-  (Read Job Data icon)
- File menu and select **Read Job Data** from the menu

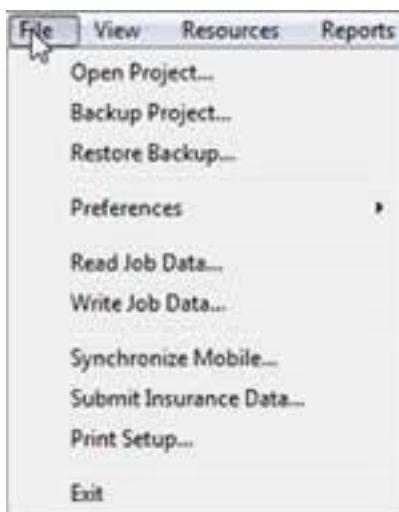

The system displays the **Read Job Data** window.

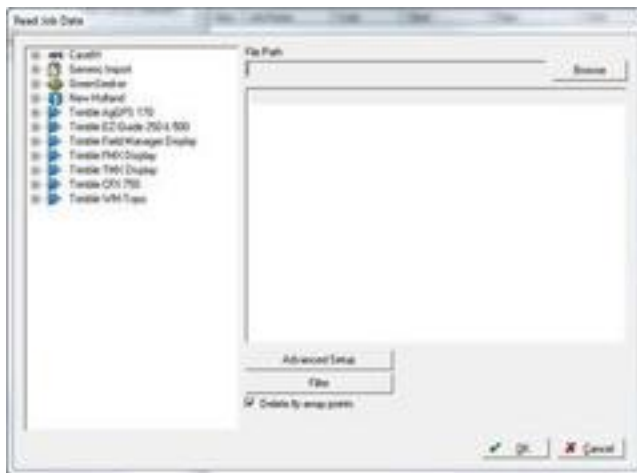

3. In the left column of the **Read Job Data** window, click + next to **Trimble TMX Display**.
4. Under **Trimble TMX Display**, select where the data is stored that you want to transfer.
 - For data transferred into Farm Works using a USB drive, select **All Data - Memory Drive**.



- For data transferred into Farm Works using Office Sync, select **All Data - Folder**.
5. Under **File Path**, click **Browse** to find the drive or folder where the data is located. After this is complete, your data will be listed in the right-hand column.

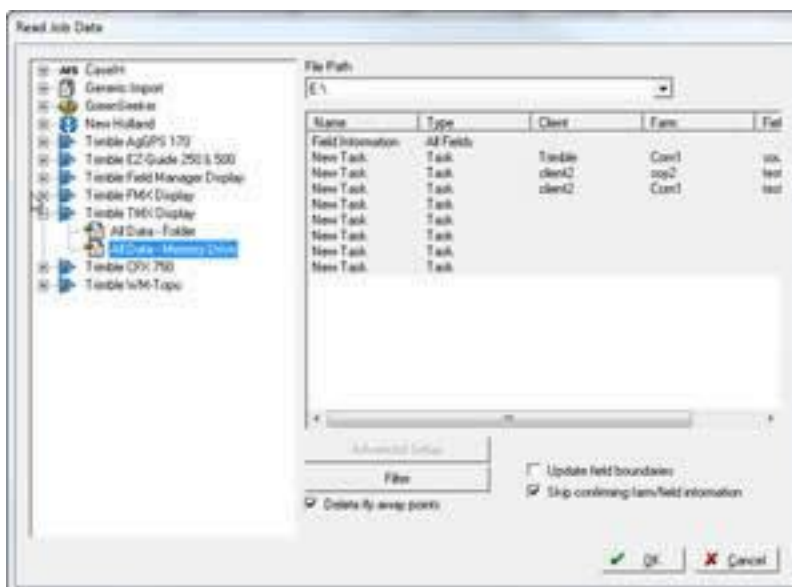



Note – If you wish to filter the files before transfer, see the online help for Farm Works for filtering instructions

6. In the left-hand column, select the job(s) to import.
7. Click **OK**. The import progress shows as files are importing. After import is complete, the system **Linker** window displays.

The left-hand column titled **Operation Resources** shows the files created on the XCN-2050 display. The right-hand column titled **Desktop Resources** shows files currently in Farm Works.

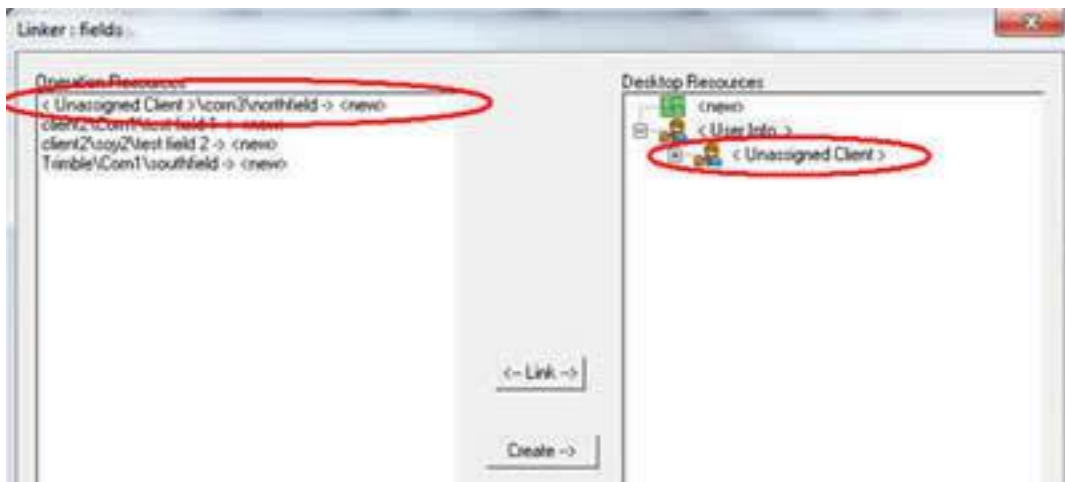
8. Select an item from the **Operation Resources** list.
 - a. If there is no counterpart to the item you selected in the **Desktop Resources** list, click the checkbox **Show Retired**. The system displays any additional files that were marked as **Retired**. If there is still no counterpart to this item in the **Desktop Resources** list, click . The system creates a new container on the desktop for the item and links it.



- b. If there is a counterpart to this item in the **Desktop Resources** list, highlight the item and click . The information is now moved to that location on the desktop.
9. After all items have been linked or created, click **OK**. All files are stored in Farm Works at the correct location.

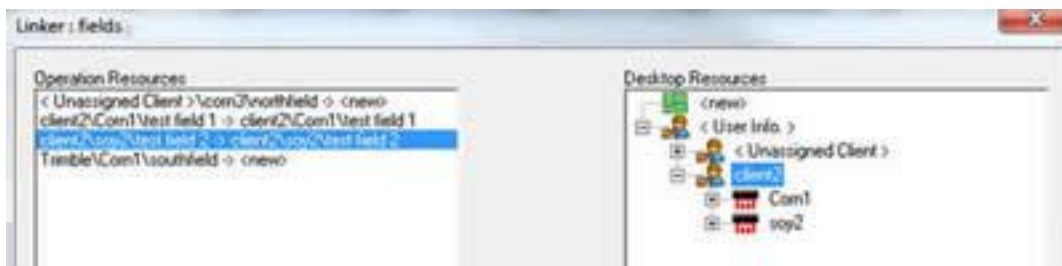

From XCN-2050 display to XCN-2050 display

From XCN-2050 display to the office or another XCN-2050 display, use the following table:

Type of transfer (without Farm Works)	Instructions
USB	To transfer data through a USB drive, see From XCN-2050 display to XCN-2050 display, 73 in this section.
Wireless (Office Sync)	To transfer data using Office Sync: <ul style="list-style-type: none"> • Ensure you meet the requirements for transferring using Office Sync. See From XCN-2050 display to XCN-2050 display, 73 in this section. • Set up Office Sync. See Modem services settings, 88.

USB socket





The display has two USB sockets: one on the side of the display and one on the back of the XCN-2050 display. (See [XCN-2050 display, 95](#) for photo showing the locations of the two USB sockets.)

You can use a USB drive to transfer data to and from your XCN-2050 display.

 **CAUTION** – Do not use a USB drive in each USB socket at the same time. If you are attempting to upgrade firmware using a USB drive and another USB drive is already in one of the sockets, the firmware upgrade will fail.

The display senses when a USB drive is inserted into either the side or rear socket, and shows the  icon on the display bar.

To use the USB drive:

1. Tap the bottom right corner of the display bar.
2. When the notification list displays, tap . The USB menu displays.
3. At the USB menu, you can:
 - Tap  to display the data transfer panel. See [Data transfer, 67](#).)
 - Tap  to take a screen shot and store it on the USB drive. See [Screen shots, 75](#).
 - Tap  to upgrade firmware from the USB drive. See [Firmware upgrades - wireless, 80](#).

Insert a USB drive

1. Move the display so you that can see the USB socket on the side or back of the display.
2. Pull the rubber cover off the USB socket.
3. Insert the USB drive into the USB socket. On the display bar, a USB icon is displayed.

Remove USB Drive



CAUTION – Do not remove the USB drive from the socket while the display is writing to or from the drive. This will corrupt the data.

1. Move the display so you that can see the USB socket.
2. Make sure the LED light of the USB drive is not blinking (indicating data transfer is occurring).
3. Pull the USB drive out of the USB socket.
4. Press the rubber cover back onto the USB socket.

Screen shots

Occasionally, you may want to save an image of the touch screen, for example to provide information for troubleshooting purposes. When you take a screen shot, the display saves a .jpg file to a *Pictures* folder on the USB drive.

To take a screen shot:

1. Insert a USB drive in one of the USB ports on the display. (See [USB socket, 74.](#)) The display bar will show a USB icon.
2. Tap the right side of the bar at the bottom of the display. The notification list slides up.
3. Tap . The USB menu displays.

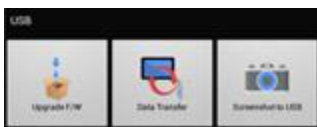

4. Tap  to take a capture of the screen.
5. The display stores your screen shot on the USB drive.



CAUTION – Do not remove the USB drive from the socket while the display is writing to or from the drive. This will corrupt the data.

Display settings

In this chapter:

Display settings	78
Languages and units settings	78
Date and time settings	78
Users and passwords	79
Firmware upgrades - wireless	80
Feature unlocks	81
Display settings	82
Mapping settings	83
Patterns settings	83
Steering and guidance settings	85
ISOBUS settings	87
Wi-Fi settings	87
Modem services settings	88
Remote Assistant settings	90
Restore defaults	91
System information	92

At the Settings panel, you can customize settings and add user profiles.

Display settings

At the XCN-2050 display, you can customize and set up many options, including but not limited to:

- Changing the language and units of measure and set the time zone
- Setting preferences for:
 - Steering and guidance
 - The point at which to begin mapping and logging
- Creating, editing and deleting user profiles
- Viewing modem settings and resetting them
- Setting up Office Sync

Languages and units settings



At this settings page, you can set:

- The language shown on the display
- The type of units of measure shown on the display
- Whether the password entry is always obscured or delayed from being obscured

Setting	Tap to view or choose...
Languages	The language for the display. Scroll the list and tap the language you want on the XCN-2050 display.
Display Units	The type of units you want on the display: English or Metric
Number Format	Either commas or periods.

Access

To access the Language and Units settings:

1. Tap .
2. Tap .
3. Tap **Language and Units**.



Date and time settings

The display automatically obtains time and date from the GNSS receiver in the TM-200 Module.

Setting	Tap to...
Select time zone	Choose time zone. Scroll the list of time zones and tap the time zone that applies to you. You must set the time zone. The system does not automatically set this.
Use 24-hour format	Turn on or off.
Select date format	Choose the date format you want to see on the display. Options are: MM/dd/YYYY, dd/MM, YYYY/MM/dd.

Access

To access the Date and Time setup:

1. Tap .
2. Tap .
3. Tap **Date and Time**.

Users and passwords

Setting	Tap to...
Add User	Add a user
(Existing user name)	Edit the user profile

Add a user

1. Tap **Add User**.
2. Enter the Operator ID.
3. Enter and confirm the user's password.
4. Tap **Create User**.



Take a photo of a user

You can capture a photo of the user, which will display:

- Next to the user's information in the Users and passwords section of Settings
 - On the display bar when the user is logged in
1. At the Users and passwords section, Tap the user icon on the right of the user information.
 2. The camera activates and displays a frame on the screen. Make sure the user's face is contained within this frame.
 3. To capture the photo, tap **Capture**. The photo displays on the lower right. You can continue to tap **Capture** until you are satisfied with the photo.
 4. When you are ready to save the photo, tap **Done**.

Access

To access the Users and Passwords settings:

1. Tap .
2. Tap .
3. Tap **Users and Passwords**.

Firmware upgrades - wireless

For upgrading firmware using a USB drive, see [Data transfer, 67](#).



To upgrade the firmware wirelessly for the XCN-2050 display, you can use one of the methods in this section.

Note – *Wireless upgrades require a DCM-300 modem, a subscription to Office Sync and a data plan or access to WiFi.*

For information on:	See:
Upgrading through USB	Data transfer, 67
WiFi settings	Wi-Fi settings, 87

Settings for wireless upgrades



You can control how the display checks for upgrades and when to wirelessly download them.

1. Tap .
2. Tap .

3. Tap **Firmware Upgrades**.
4. Tap **Settings**.



Setting	Explanation
Auto check for new upgrades	If you activate this, the system will automatically check for new upgrades.
Auto download new upgrades when available	This choice is only available if you have chosen to have the system automatically check for new upgrades. The system will install the updates as they are available.
Auto install firmware on power down	This choice is only available if you have chosen to have the system automatically check for new upgrades. The system will install the updates before the display powers off.
Only download via WiFi	This choice is only available if you have chosen to have the system automatically check for new upgrades. The system will download the updates only through a WiFi connection.
Show support beta releases in list	The system includes beta releases available for you to download.

Check for updates

1. Tap .
2. Tap .
3. Tap **Firmware Upgrades**.
4. Tap **Check for Updates**. The system checks for updates and begins the upgrade process immediately unless you have altered when the upgrade occurs in Settings.

Feature unlocks

For some optional features, you must enter the unlock password. If you do not have an unlock password, contact your local reseller.

1. Tap .
2. Tap .
3. Tap **Feature Unlocks**. You can unlock features by manually entering the code, having the display read the QR code of the unlock, or checking for unlocks.

At the bottom of the screen, the list of currently locked features displays.

Manual code entry

1. Tap the Code text box and enter the code.
2. If the system accepts the code, tap **Accept**.
3. If the system rejects the code, you can try again or contact your reseller for help.

QR code scan

1. Tap **Read QR**.
2. Hold your code image in front of the camera for it to be read.
3. If the system accepts the code, Tap **Accept**.
4. If the system rejects the code, you can try again or contact your reseller for help.

Check for unlocks

1. Tap **Check for Unlocks**.
2. The request will be sent for the display to check for any available service or licenses. It may take several minutes for the unlocks to be processed.

Display settings

These are basic settings for the display.

Setting	Tap to...
Manually Change Brightness	Adjust brightness of the XCN-2050 display's backlight.
Volume	Adjust the volume of the sound.
Touch Screen Sounds	Turn on or off sounds associated with using the display.

Access

To access the Display settings:

1. Tap .
2. Tap .
3. Tap **Display**.

Mapping settings

These settings control guidance mapping features available on the **Run** screen.

Setting	Tap to view or change...
Map Background Selection	The ground color for the Run screen. Options are: <ul style="list-style-type: none"> • Color: Brown, green or grey • Color with texture • Color with gridlines
Map Color Scheme	Day or night mode.
Map Orientation	Which point of view displays on the Run screen when following the position of the vehicle. Orientation options: North Up or Vehicle Up.
Record Coverage When Engaged	The system can switch on coverage when auto guidance is engaged, and switch off coverage when it is not engaged. Option for this setting is on or off.

To access the Mapping settings:

1. Tap .
2. Tap .
3. Tap **Mapping**.

Patterns settings

At pattern settings, you can:

- Activate the auto close feature to use when you create boundaries and headlands
- Activate smoothing for curves and turn radius when traveling on guidance lines
- Customize the tight turn warning angle and look-ahead time

Curve Features

Setting	Tap to view or change...
Curve Smoothing	The feature on or off. When curve smoothing is on, the system smooths out the guidance curve, making it wider.

Setting	Tap to view or change...
Smooth Turn Radius	The size of the circle that the system will guide to. The larger the circle (degrees), the wider the turn.
Tight Turn Warning Angle	The number of degrees that will trigger a warning about a tight turning angle. See Tight turn warning, 292 .
Tight Turn Look Ahead Time	The number of seconds before you approach a tight turn angle that the warning will show on the display. See Tight turn warning, 292 .

Headlands

Setting	Tap to view or change...
Auto Close	Automatically closes the beginning and end point when you create boundaries and headlands. See Headland and infill pattern creation (Run screen), 253 .
Auto Close Distance	The distance between your beginning point and ending point for a headland. See Headland and infill pattern creation (Run screen), 253 .

Boundaries

Setting	Tap to view or change....
Auto Close	Automatically closes the beginning and end point when you create boundaries. See Boundary creation (Run screen), 248 .
Auto Close Distance	The distance between your beginning point and ending point for a boundary.

Access

To access the Patterns settings:

1. Tap .
2. Tap .
3. Tap **Patterns**.



Steering and guidance settings

The following settings enable you to customize controls related to steering and guidance.

Setting	Tap to view or change...
Operator Timeout	The amount of time before the display disengages auto guidance and stop applications when there is no response to a shutdown message.
Nudge Increment	The increment used to nudge the guidance system with each tap. You can incrementally nudge a pattern in a perpendicular direction relative to the pattern. Nudging a pattern helps adjust for satellite drift. See Guidance pattern adjustment (Run screen), 260 and GNSS and xFill technology status, 315 .
Implement Draft Increment	The increment used to nudge the implement to the current guidance line. See Guidance pattern adjustment (Run screen), 260 .
Aggressiveness Increment	The increment used to change aggressiveness. See Steering adjustments, 244 .
Autosteering Lockout	Whether the feature is on or off. When lockout is on, the display does not offer an option to use auto guidance.
Re-mark Reset with Import	Remove all re-mark entrees on with an import. See Guidance pattern adjustment (Run screen), 260 .
End of Row Distance	Distance for the end of row warning to display. See End of row warning, 292 .
NMEA from Autopilot Diagnostics Port	On: NMEA messages can be sent from the Nav Controller II Off: No messages are sent See NMEA messages, 298 .

Access

To access the Steering and Guidance settings:

1. Tap .
2. Tap .
3. Tap **Steering/Guidance**.

ISOBUS settings

Task Controller

To use Task Controller when using ISO-certified equipment, tap  to activate this feature.

Note – This feature is optional and requires an unlock.

For information on:	See:
Task Controller implement setup	Implement setup for Task Controller, 191
Setting up equipment for task controller	Equipment setup, 195
Using Task Controller	Task Controller operation, 282 and ISOBUS Task Controller widget, 288

Virtual Terminal

To use Virtual Terminal when using ISO-certified equipment, tap  to activate this feature.

For information on:	See:
Using Virtual Terminal	Virtual Terminal operation, 284 and Virtual Terminal widget, 290

Access

To access the ISOBUS settings:

1. Tap .
2. Tap .
3. Tap **ISOBUS Settings**.

Wi-Fi settings

With a DCM-300 modem and additional subscription services, WiFi enables you to transfer data wirelessly from vehicle to office. You can use WiFi in addition to or instead of the cellular network.

At Wi-Fi network settings, turn on Wi-Fi.

At Available Networks, tap **Refresh** to scan for additional networks you can connect to.

For content on:	See:
Diagnostics	DCM-300 modem diagnostics, 305
Modem status	DCM-300 modem status, 302

Access

To access settings for WiFi:

1. Tap .
2. Tap .
3. Tap **WiFi**.



Modem services settings

Modem settings include:

- [Modem settings, 88](#)
- [Network settings, 89](#)
- [Office Sync settings, 90](#)

Access

To access Modem Services:

1. Tap .
2. Tap .
3. Tap **Modem services**.

Modem settings

Setting	Tap to view or change...
Device Name	The serial number of the DCM-300 modem.

Network settings

Network (CDMA)

Setting	Tap to...
CDMA Reset	Reset the network connection. This will reset the connection between the modem and the service provider, and will remove all existing settings.

The following additional settings that are read only and are automatically completed with the DCM-300 modem connects to the network:

- Mobile Directory Name (MDN)
- Electronic Serial Number (ESN)
- Mobile Identification Number (MIN)
- Preferred Roaming List (PRL)

For content on:	See:
Diagnostics	Office Sync Diagnostics, 321
Data transfer with Office Sync	Data transfer, 67

Network (GSM)

Setting	Tap to...
APN	View the access point name.
SIM PIN	The PIN for the SIM.
Advanced	Launch a popup to enter the GSM Username and GSM Password.

The following additional settings that are read only and are automatically completed with the DCM-300 modem connects to the network:

- IMEI: International Mobile Equipment Identity
- SIM ICCID: IMS Charging Identifier
- SIM Status: Status of SIM



Office Sync settings

Setting	Tap to...
Office Sync	Turn the feature on or off.
Check Server	Select how often you want the display to check the server to send data to the office.
Send Data	Select how often data is sent from the display to the office.
Auto-send without prompt	Turn the feature on or off. When on, the display will send data to the office without first asking for your confirmation. If this feature is on, data will be sent without notifying you. This can result in large files being transferred or the transfer of data you do not want transferred.

For information on:	See:
Initial setup	DCM-300 modem initial setup, 130
Diagnostics	Office Sync Diagnostics, 321
Data transfer with Office Sync	Office Sync data transfer, 69

Remote Assistant settings



The Remote Assistant feature enables a support person to view your display as you are viewing it. To set up Remote Assistant:

1. Tap **Enroll**.
2. At the Enroll screen, tap  in the display bar.
3. At the Status screen, tap  in the display bar.

For information on:	See:
Diagnostics	Remote Assistant, 325

Access

To access Remote Assistant:

1. Tap .
2. Tap .
3. Tap **Remote Assistant**.

Restore defaults

During troubleshooting, you may be asked by Support to perform a reset.

Admin User Options



Setting	Tap to...
Restore Default user Preferences	Restore the default preferences for the user currently logged in.
Restore Preferences to Factory Defaults	Restore the display to default factory settings. Erases all custom settings for all user accounts.
Factory Reset	Erase all user accounts, system and application data, coverage, configurations, feature unlocks, minor firmware updates and downloaded applications. <i>Note – Only perform a factory reset on the advice of technical support.</i>

Restricted User Options

Setting	Tap to...
Restore Default user Preferences	Restores the default user preferences.

Access

To access Restore Defaults:



1. Tap .
2. Tap .
3. Tap **Restore Defaults**.

System information

Information	Tap to view...
Software Information	The list of software packets for diagnostics.
Current User Information	System information on the user currently logged in. See Users and passwords, 79 .
Current Preference Information	The current settings of the user that is currently logged in.
Device Information	Technical information about the display.

Access

To access the System settings:

1. Tap .
2. Tap .
3. Tap **System**.

Installation

In this chapter:

Components	94
Installation overview	100
Installation and GNSS set up	102

Installation includes the display mount and XCN-2050 display, the TM-200 Module, and other components as they apply to your system configuration.

Components

The following components are part of a recommended setup for the XCN-2050 display:

- [XCN-2050 display, 95](#)
- Display mount: To mount the XCN-2050 display
- [TM-200 Module, 97](#): To enable quick disconnection and reconnection of the XCN-2050 display. The TM-200 module contains a built-in GNSS receiver.
- [AG-815 integrated radio, 99](#): For RTK correction services
- [DCM-300 modem, 98](#): Provides access to correction services, wireless data transfer and cellular/WiFi signals where applicable

XCN-2050 display

 **CAUTION** – Do not press on the screen with a sharp item, such as a pencil. You may damage the surface of the screen.

Front view

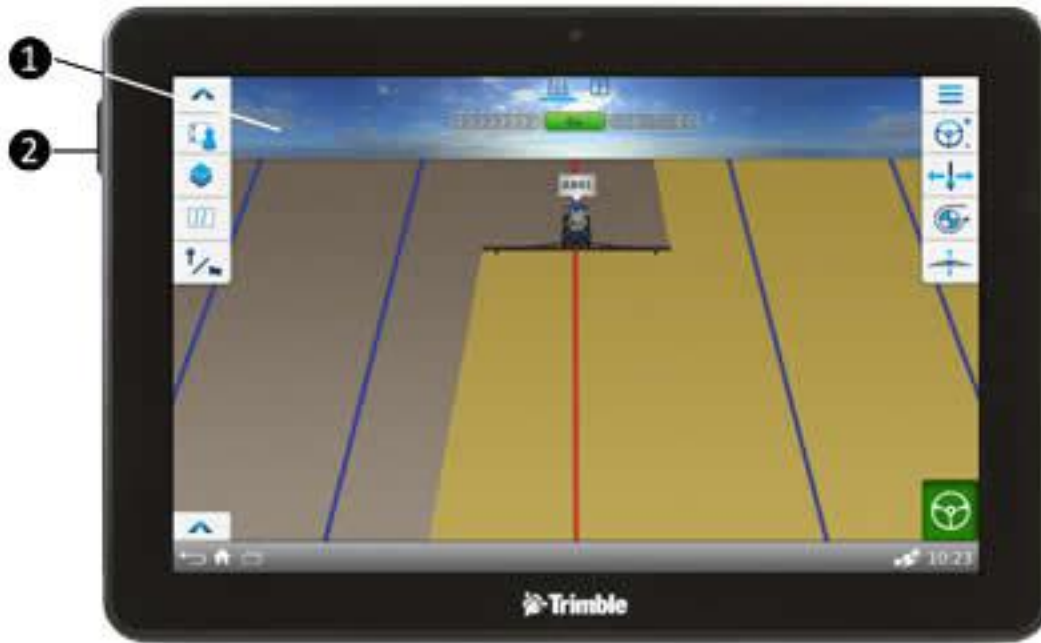

Item	Description
1	12" touch-sensitive screen
2	Port: USB (side with cover). Socket for USB drive to transferring data to and from the XCN-2050 display. See Data transfer, 67 and USB socket, 74 .

Rear view





Item	Name	Explanation
1	Power button	Powers the XCN-2050 display on or off
2	Labels with part number and serial number	N/A
3	Port: DVI / HDMI	For future capability
4	Jack: TM-200 Module (RJ45)	Socket for connecting to the TM-200 Module
		
5	Cable brackets	Holds Trimble Ethernet cables to prevent cable strain
6	Interior bolts	Location for mounting Field IQ switch box
7	Jack: CAN (RJ11)	For future capability
8	Port: USB (rear) with cover	Socket for USB drive to transferring data to and from the XCN-2050 display

Item	Name	Explanation
9	Speakers	For use if you have sound activated on the XCN-2050 display. See Display settings, 82 .
10	Port: USB (side) with cover	Socket for USB drive to transferring data to and from the XCN-2050 display. See Data transfer, 67 and USB socket, 74 .
11	Interior bolts in mounting plateplate	Receives screws for Zirkona display mount
12	Ambient light sensor	Senses lower ambient light and activates the backlight on the display.

TM-200 Module

The TM-200 Module is a hub for connectivity and high-performance GNSS positioning. It connects to the XCN-2050 display with a single cable. All remaining components connect to the TM-200 Module. This enables you to quickly disconnect and reconnect the XCN-2050 display as needed.



Item	Name	Explanation
1	14 pin AMPSEAL connector	Socket for power and inputs (Port B)
2	12 pin DEUTSCH connector	Socket for inputs (Port A)
3	AG-25 GNSS antenna connector	Socket for connecting to the AG-25 GNSS antenna
		
4	8 pin AMPSEAL connector	Socket for Ethernet cable to connect to DCM-300 modem.
		
5	8 pin AMPSEAL connector	Socket for connecting to the XCN-2050 display
		
6	Screws and end cover plate	Unscrew and remove end cover plate to expose the AG-815 radio expansion slot.
7	10 amp fuse	Protect components from power surges
8	Radio expansion slot	Socket for AG-815 integrated radio connector. (See AG-815 integrated radio, 99.)

DCM-300 modem

The DCM-300 modem is available in two models for use on Global System for Mobile Communications (GSM) cellular networks, such as AT&T, or Code Division Multiple Access (CDMA) cellular networks, such as Verizon.

The DCM-300 modem enables you to use:

- Correction services CenterPoint RTX™ and CenterPoint VRS™ as well as third-party network RTK corrections
- Data transfer for Office Sync / Connected Farm [Office Sync setup, 130](#)
- Cellular data plans (USA only)
- Global GSM cellular networks
- WiFi signals as applicable

For information on: See:

Connecting the modem [Connect the DCM-300 modem, 111](#)

Modem status [DCM-300 modem status, 302](#)

AG-815 integrated radio

The AG-815 integrated radio provides access to radio networks for real-time, high-precision CenterPoint™ RTK applications. The AG-815 is available in both the 450 MHz and 900 MHz versions.



Item	Name	Explanation
1	Radio blade connector	Connection to TM-200 Module. See TM-200 Module, 97 , number 8.
2	Antenna connector	Radio antenna connector
3	Antenna connector	Optional GNSS connector for future use

Installation overview

The display mount attaches to a rail in the cab of the vehicle. The XCN-2050 display connects to the display mount.

The TM-200 Module connects to the display with a single cable.

Additional components to install depend on your connection and correction services, and the features you are using.

CAUTION – Make sure the vehicle power is off when you are connecting system components.

Install the display and mount

Use the mounting hardware supplied in the display kit to mount the display in the vehicle cab.

CAUTION – Make sure the vehicle power is off when you are connecting system components.

Before completing installation steps, select a position in the cab where the bar mount (4) can be attached to a rail. Hold the display in the selected location and make sure that it is:

- Easy to see, but does not block the driver's view
- Within the driver's reach so that the USB drive is easy to remove and replace
- Does not interfere with the driver getting in or out of the cab, or any other activities

1. Use the provided bolts to attach the bar mount (4) to a rail in the cab.



2. Use the supplied screws to firmly attach the mounting plate (1) to the back of the XCN-2050 display.
3. Turn the tightening arm (3) to loosen the Zirkona mount (2).
4. Adjust the XCN-2050 display until it is positioned where you want it. Turn the tightening arm (3) the other direction to tighten the Zirkona mount (2).

Item	Description
1	Mounting plate
2	Zirkona mount
3	Tightening arm
4	Bar mount



Installation and GNSS set up

1. Install the equipment required for the type of correction service you will be using.

Correction type	Install...
Autonomous	GNSS antenna
CenterPoint RTK	Ag-815 Radio antenna GNSS antenna
CenterPoint RTX Satellite	GNSS antenna
CenterPoint RTX Modem	DCM-300 modem Cellular antenna GNSS antenna
OmniSTAR G2/HP	GNSS antenna
RangePoint RTX	GNSS antenna
SBAS	GNSS antenna
VRS	DCM-300 modem Cellular antenna GNSS antenna

2. Set up at least one vehicle. See [Vehicle setup, 140](#).
You will not be able to receive a normal GNSS signal until you set up a vehicle.
3. Set up GNSS. See [GNSS receiver settings, 116](#)

Connect the AG-815 radio to the TM-200 Module

The AG-815 integrated radio connects directly to the TM-200 Module.



CAUTION – Make sure the vehicle power is off when you are connecting system components.

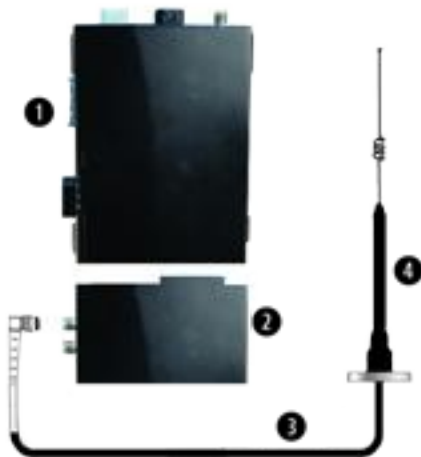

Item	Description
1	TM-200 Module
2	AG-815 integrated radio
3	Radio antenna cable
4	Radio antenna

1. Use a T10 Torx screwdriver to remove the screws (1) and face plate from the TM-200 Module.



2. Insert the AG-815 radio's blade connector (2) into the radio expansion slot of the TM-200 Module.
3. Use the long screws provided with the AG-815 radio to fasten the radio to the TM-200 Module.

The following image shows the AG-815 radio attached to the TM-200 Module.



Connect the display and TM-200 Module

The TM-200 Module connects to the antenna, auto-steering and other systems, such as the Field-IQ system's Rate and Section Control. Before installation, make sure the TM-200 Module is out of the way but accessible, and close enough to connect to the display with the supplied display cable.

CAUTION – Make sure the vehicle power is off when you are connecting system components.

CAUTION – If the vehicle has a master electrical disconnect, make sure the power cable ground connections are not directly attached to the battery terminal. Attach the ground connections of the power cable to the chassis side of the main disconnect so that it is as close as possible to the battery, but still gets disconnected when the master disconnect is turned off. Failure to connect the power cable ground will cause damage to the display.

1. Make sure you have connected the AG-815 integrated radio to the TM-200 Module. See [Connect the AG-815 radio to the TM-200 Module, 103](#).
2. Use the display cable to connect the TM-200 Module to the XCN-2050 display.

CAUTION – Do not attempt to power the display without the TM-200 Module.

Connector
icon:





Ensure the cable is fastened into the cable clip next to the port on the rear of the display.

This prevents the cable from being removed from the port and reduce stress on the cable.



3. To connect the AG-25 GNSS antenna to the TM-200 Module, see [Connect the AG-25 GNSS antenna , 111](#).
4. Insert the TM-200 Module power and I/O cable into Port B of the TM-200 Module. Port icon:

B  12V  , 25A

Master disconnect

1. Before proceeding further with the installation, make sure you know whether the vehicle has a master disconnect.
2. If the vehicle has a master electrical disconnect, make sure that the power cable ground connections are **not** directly attached to the battery terminal, shown as the negative pole in the graphic below.
3. Attach the ground connections of the power cable to the chassis side of the main disconnect so that it is as close as possible to the battery but still gets disconnected when the master disconnect is turned off.

Note – *If a Master disconnect is installed on either the positive or ground path of the battery, the ring terminals of the Trimble power cable should always be connected behind the master disconnect device.*

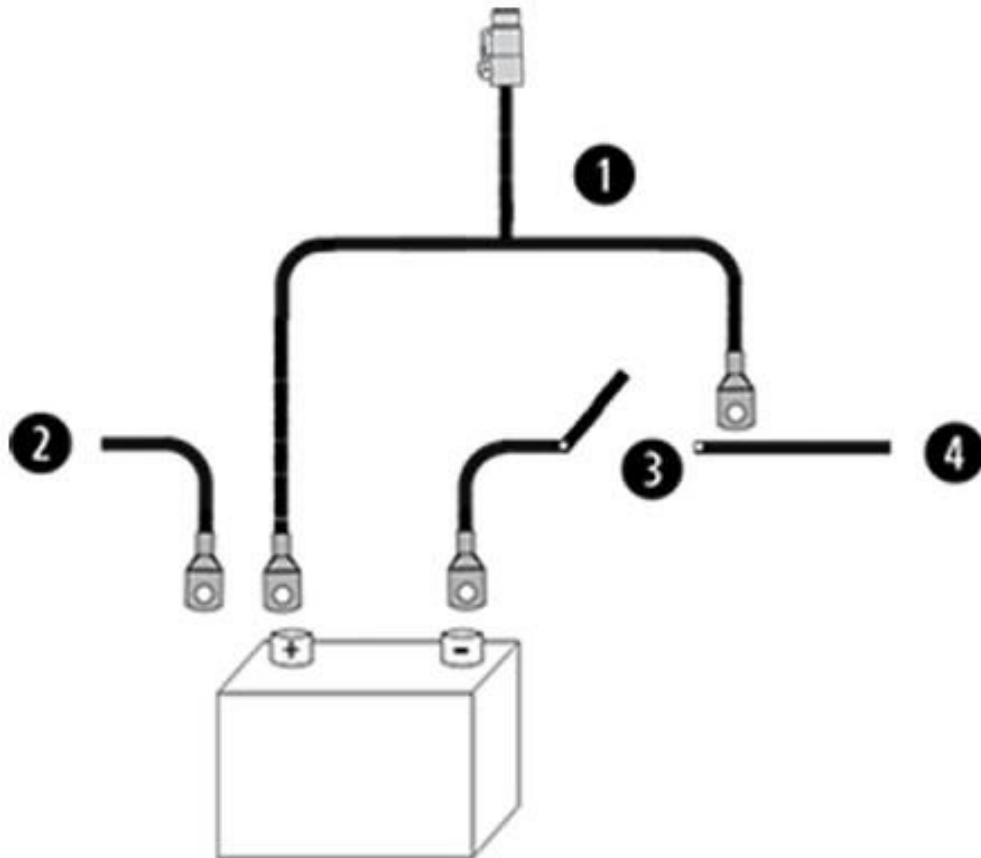

Item	Description
1	Trimble power cable
2	To tractor +ve
3	Master electrical disconnect
4	To tractor -ve



CAUTION – Make sure the vehicle power is off when you are connecting system components.

7. For vehicles without an OEM connection, see [Regular after-market installation, 107](#).
8. For vehicles with an OEM connection, see [Connection for existing OEM harness, 109](#).

Regular after-market installation



Tip – Proper connection depends on your configuration. Reference the XCN-2050 Display Cabling Guide for appropriate information.

The following graphic shows how to connect the XCN-2050 display and TM-200 Module to a vehicle that does not have an OEM connection. See the *XCN-2050 display Cabling Guide* for connection instructions on specific configurations.



CAUTION – If the vehicle has a master electrical disconnect, make sure the power cable ground connections are not directly attached to the battery terminal. Attach the ground connections of the power cable to the chassis side of the main disconnect so that it is as close as possible to the battery, but still gets disconnected when the master disconnect is turned off. Failure to connect the power cable ground will cause damage to the display.



CAUTION – Make sure the vehicle power is off when you are connecting system components.

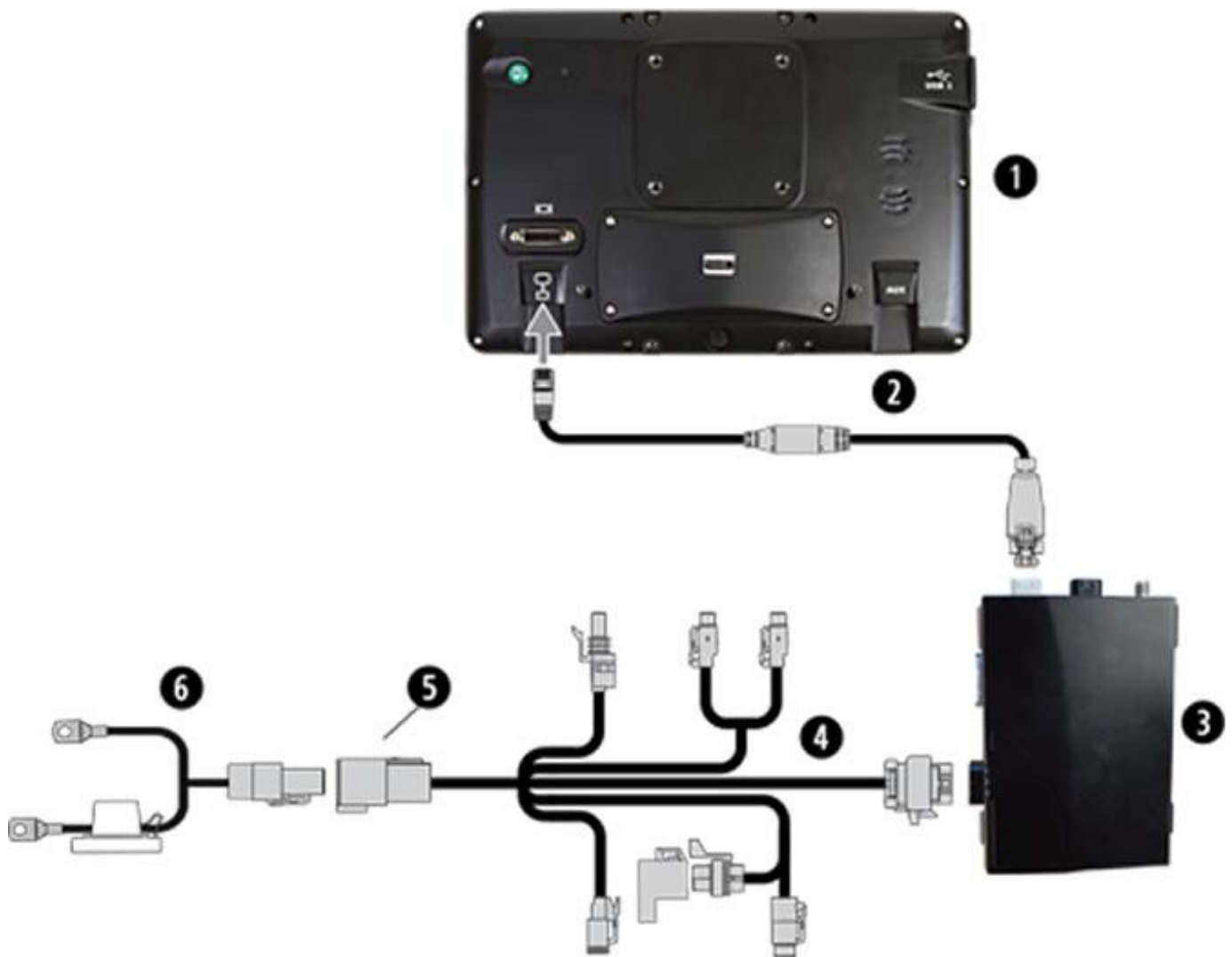

Item	Description	Part Number
1	XCN-2050 display	96700-00
2	TM-200 Module to display cable	93843
3	TM-200 Module	95060-00
4	TM-200 Module power and I/O cable connected to port B	92676

Item	Description	Part Number
5	R3 connector of power and I/O cable	
6	TM-200 Module battery cable	92905

Connection for existing OEM harness



Tip – Proper connection depends on your configuration. Reference the XCN-2050 Display Cabling Guide for appropriate information.

The following graphic shows how to connect the XCN-2050 display and TM-200 Module to a vehicle with an OEM connection. See the *XCN-2050 display Cabling Guide* for connection instructions on specific configurations.



CAUTION – If the vehicle has a master electrical disconnect, make sure the power cable ground connections are not directly attached to the battery terminal. Attach the ground connections of the power cable to the chassis side of the main disconnect so that it is as close as possible to the battery, but still gets disconnected when the master disconnect is turned off. Failure to connect the power cable ground will cause damage to the display.



CAUTION – Make sure the vehicle power is off when you are connecting system components.

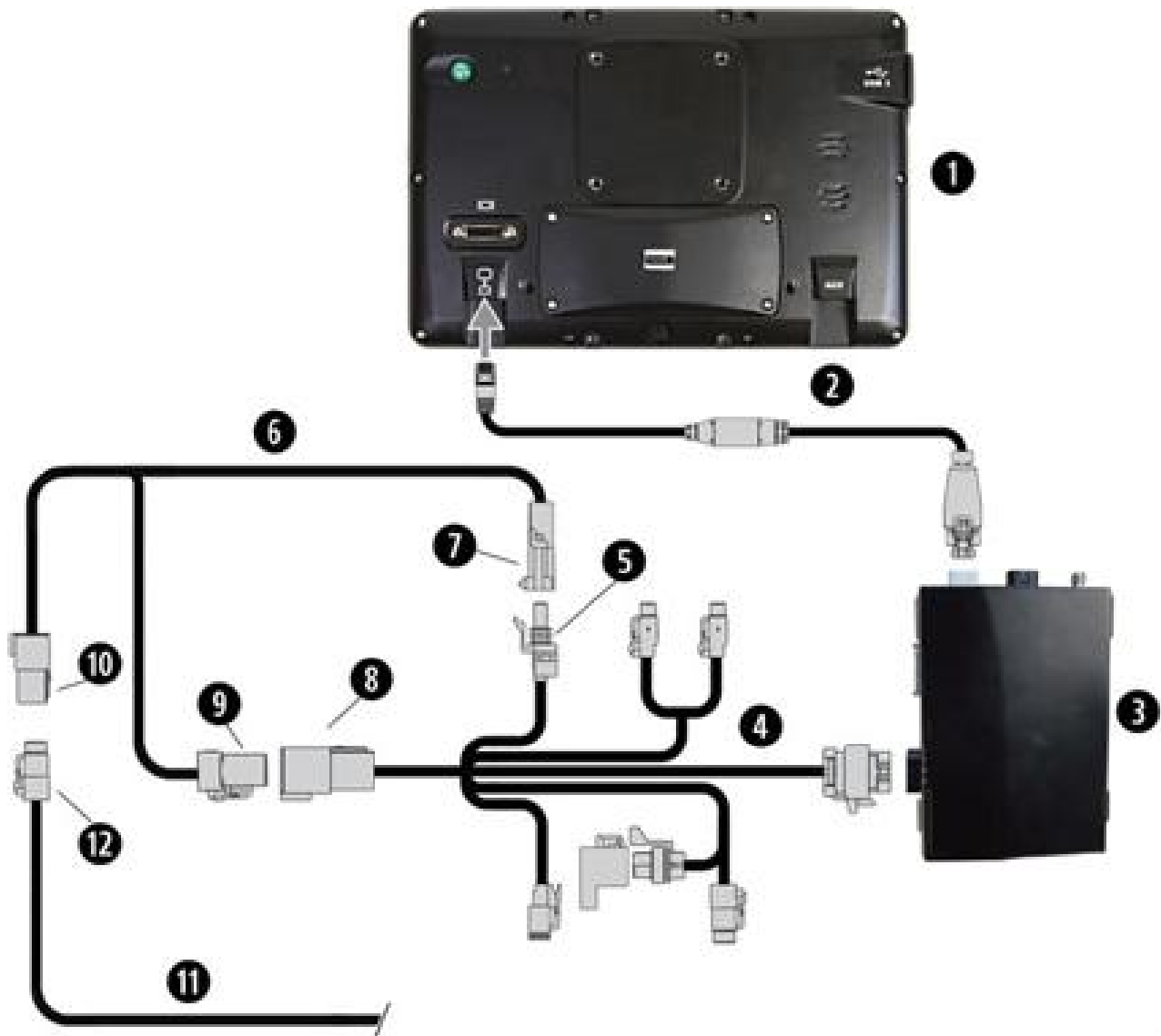

Item	Description	Part Number
1	XCN-2050 display	96700-00
2	TM-200 Module to display cable	93843
3	TM-200 Module	95060-00
4	TM-200 Module power and I/O cable connected to port B	92676
5	R1 connector	N/A
6	Power adapter cable	95918

Item	Description	Part Number
7	P2 connector of power adapter cable	
8	R3 connector	
9	P1 connector	
10	R1 connector	
11	OEM harness	
12	4-pin DTP connector	

Connect the DCM-300 modem

Use the hardware supplied with the DCM-300 modem for installation.



CAUTION – Make sure the vehicle power is off when you are connecting system components.



CAUTION – Do not mount the DCM-300 modem in direct sunlight or in areas of high heat. This will cause degraded performance.



Tip – Proper connection depends on your configuration. Reference the XCN-2050 Display Cabling Guide for appropriate information.

1. Mount the modem inside the cab of the vehicle, in a shaded area with good ventilation. Mount the cellular antenna on the outside of the vehicle. If you are using Vehicle Sync or Office Sync to exchange data remotely, mount the WiFi antenna on the outside of the vehicle.
2. Use the DCM-300 modem to TM-200 Module cable to connect the DCM-300 modem to the Ethernet port on the TM-200 Module. The connector icon for the port on the TM-200 Module is:

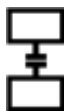

3. Continue with installation using the specific steps of the XCN-2050 Display Cabling Guide.

Connect the AG-25 GNSS antenna

The GNSS antenna is required for the GNSS receiver in the TM-200 Module to receive GPS / GNSS corrections.



CAUTION – Make sure the vehicle power is off when you are connecting system components.



Item	Description
1	TM-200 Module
2	AG-25 GNSS antenna
3	AG-25 antenna to TM-200 Module cable

The AG-25 GNSS antenna has integrated magnets for easy installation. To attach the antenna to a non-metal surface, use the mounting plate.

Note – If you are using the AG-25 GNSS antenna with a steering system, see the installation instructions for the steering system to determine the proper location for mounting the antenna.

1. Connect the antenna cable (3) to the AG-25 GNSS antenna (1).



2. Place the antenna on the roof of the vehicle, at the front and centered from left to right.
3. On the mounting plate, remove the protective covers from the adhesive strips.
4. Attach the mounting plate to the vehicle roof with the adhesive strips.
5. Place the antenna on top of the mounting plate.
6. Route the other end of the antenna cable into the cab.

7. Connect the GNSS antenna cable (3) to the TM-200 Module. Connector icon:  (Also see [TM-200 Module, 97.](#))

Note – To minimize any interference to the GNSS signal, make sure that any other antenna (including a radio antenna) is at least 1 m (3 ft) from the AG-25 GNSS antenna.

 **CAUTION** – The GNSS antenna may experience interference if you operate the vehicle within 100 m (300 ft) of any power line, radar dish, or cell phone tower.

Connect additional components

Note – The steering system requires professional installation. If the steering system is not currently installed in your vehicle, consult your local reseller.

Refer to the XCN-2050 Display Cabling Guide to connect to:

- Flow and application control
- Boom height control
- Other components



Tip – Proper connection depends on your configuration. Reference the XCN-2050 Display Cabling Guide for appropriate information.

Connectivity

In this chapter:

GNSS receiver settings	116
DCM-300 modem initial setup	130
Office Sync setup	130
Connectivity concepts	133

In addition to GNSS, you can use optional correction services, the DCM-300 modem, and Office Sync to transfer files to your Connected Farm application.

GNSS receiver settings

The TM-200 Module contains a built-in GNSS receiver. To set up the receiver, you choose:

- The type of antenna you are using
- The correction source you will be using, if any

Note – GNSS status will not show a converging or normal status until a vehicle has been configured and selected. See [GNSS notification button, 52](#).

1. After installing the AG25 GNSS antenna, power on the vehicle. This will power on the receiver.
2. Make sure all optional features are unlocked and all subscriptions are activated.
3. At the **Home** screen, tap .
4. Tap **GNSS Setup**.

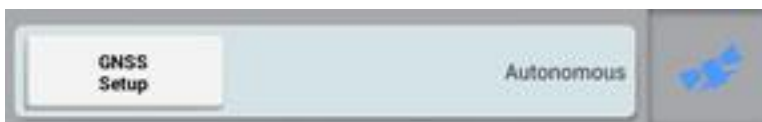

The GNSS setup panel displays.

5. At the SELECTION section:
 - a. Tap **Antenna Type**, then select the antenna you are using from the list. Choices are AG25, Other, Zephyr™ II, Zephyr II (Ruggedized).
 - b. Tap **Correction Source** and select the correction source you will be using.

Note – You will not be able to select any correction source that is locked.

Correction Source	Description
Autonomous (None)	No GPS corrections. If this is your correction source, there are no additional settings for you to enter.
SBAS	Satellite-based augmentation systems (SBAS) with free correction services
RangePoint RTX corrections	Satellite-based subscription service for corrections with pass-to-pass accuracy < 6" (15 cm) and GLONASS compatibility
OmniSTAR G2/HP/GR corrections setup	Satellite-based subscription service
CenterPoint RTX setup (Modem)	Cellular broadcast subscription service for corrections with < 1.5" (3.8 cm) accuracy and GLONASS compatibility.

Correction Source	Description
CenterPoint RTX (Satellite)	Satellite broadcast subscription service for corrections with < 1.5" (3.8 cm) accuracy and GLONASS compatibility.
VRS	Cellular-broadcast RTK corrections from a ground-based reference station using the a modem. (Requires a DCM-300 modem.)
RTK corrections	Radio-broadcast corrections from a ground-based reference station. (Requires the AG-815 integrated radio.)

- c. Tap **Position Quality** to change from the default Favor Accuracy.

Setting	Description
Favor Accuracy (Default)	Use for operations needing highest accuracy.
Balanced Quality	Trades potential accuracy for longer production time.
Favor Availability	Expands production time further with potential for reduced accuracy.

6. Tap  to save your settings.

SBAS corrections

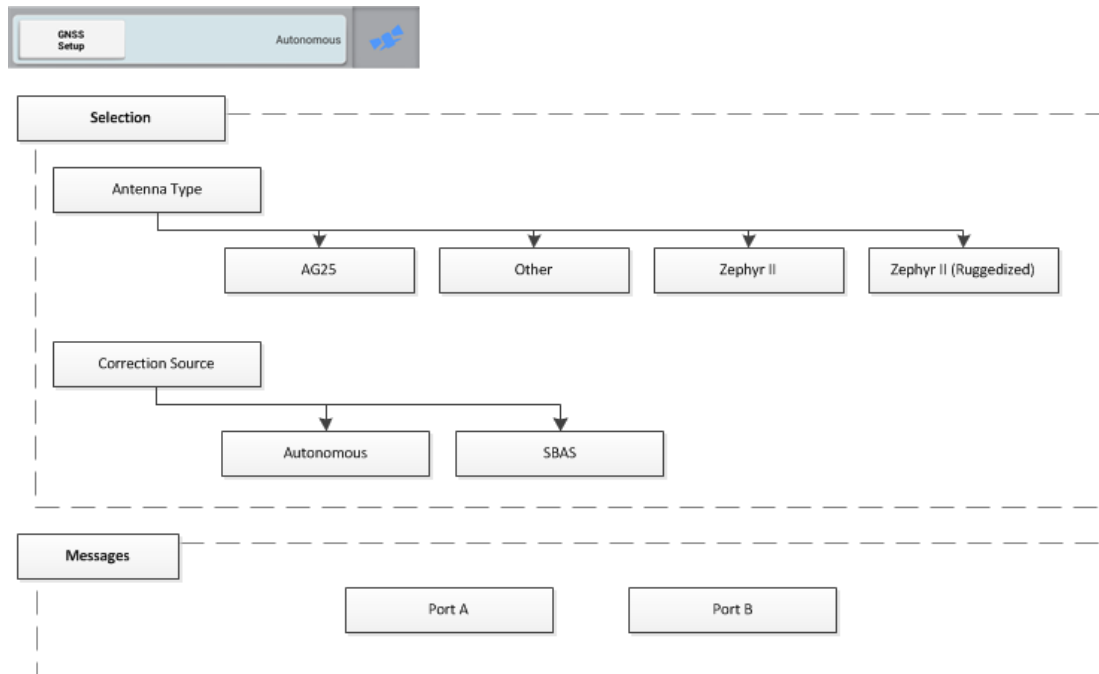

The satellite-based augmentation systems (SBAS) with free correction services are:

- WAAS (Wide Area Augmentation System) in North America
- EGNOS (European Geostationary Navigation Overlay Service) in Europe
- MSAS (Multi-functional Satellite Augmentation System) in Asia Pacific regions

Setting	Options
Correction Satellite Selection	Choose <i>Auto Select</i> for automatic satellite selection, or select a satellite from the list.
Position Quality	Select the appropriate choice: <ul style="list-style-type: none"> • Favor Accuracy (Default) : Use for operations needing highest accuracy (such as row crop planting and strip-till). • Balanced Quality: Trades potential accuracy for longer production time. • Favor Availability: Expands production time further with potential for reduced accuracy.

RangePoint RTX corrections

RangePoint RTX is a satellite-based subscription service for corrections with pass-to-pass accuracy < 6" (15 cm) and GLONASS compatibility.

The GNSS receiver in the TM-200 Module receives these signals.

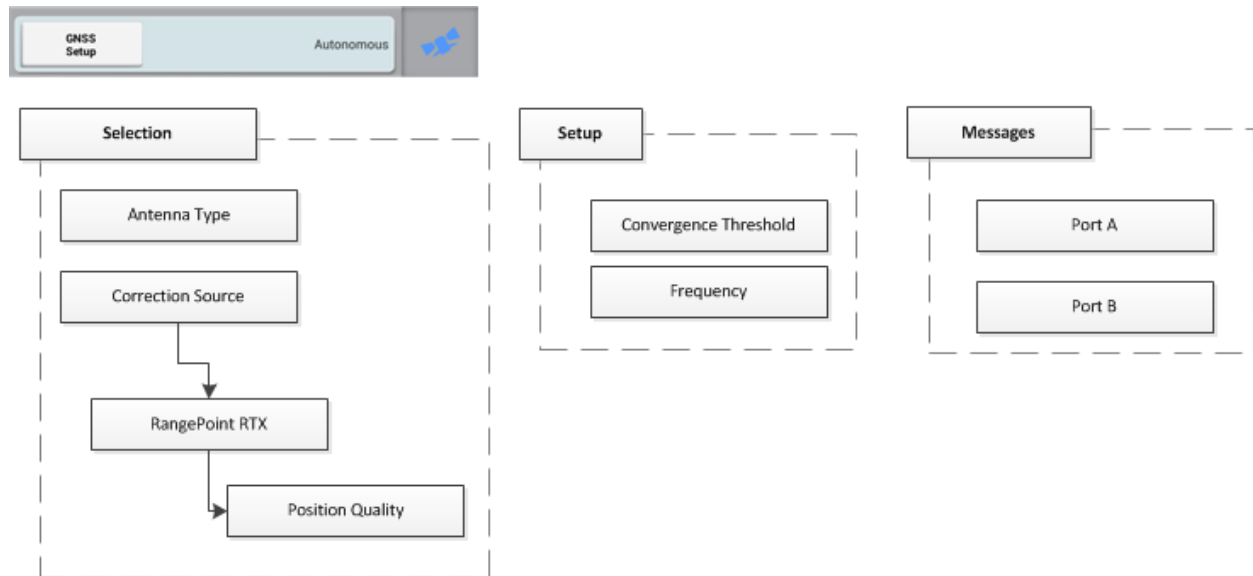

To set up this correction service:

1. Unlock RangePoint RTX. (See [Feature unlocks, 81.](#))
2. At the **Home** screen, tap .
3. Tap **GNSS Setup** to display the setup panel.

Setting	Options
Position Quality	Select the appropriate choice: <ul style="list-style-type: none"> • Favor Accuracy (Default) : Use for operations needing highest accuracy (such as row crop planting and strip-till). • Balanced Quality: Trades potential accuracy for longer production time. • Favor Availability: Expands production time further with potential for reduced accuracy.
Convergence Threshold	View the convergence level at which the system will allow you to start guidance operations.

Setting	Options
Frequency	<p>Choose the RTX frequency for your region or enter a custom frequency. Frequency options are:</p> <ul style="list-style-type: none"> • Asia/ Pacific (1539.8325) (Baud Rate= 600) • Central North America (1557.8150) (Baud Rate= 2400) • Custom (Enter the Frequency and Baud Rate) • Eastern North America (1557.8590) (Baud Rate= 600) • Europe/ Africa (1539.9525) (Baud Rate= 600) • Latin America (1539.8325) (Baud Rate= 600) • Western North America (1557.8615) (Baud Rate= 600)

OmniSTAR G2/HP/GR corrections setup

Satellite-based subscription service:

- HP corrections have 2 - 4" (5 - 10 cm) accuracy
- G2 corrections have 3 - 4" (8 - 10 cm) accuracy and is compatible with GLONASS

The GNSS receiver in the TM-200 Module receives these signals.

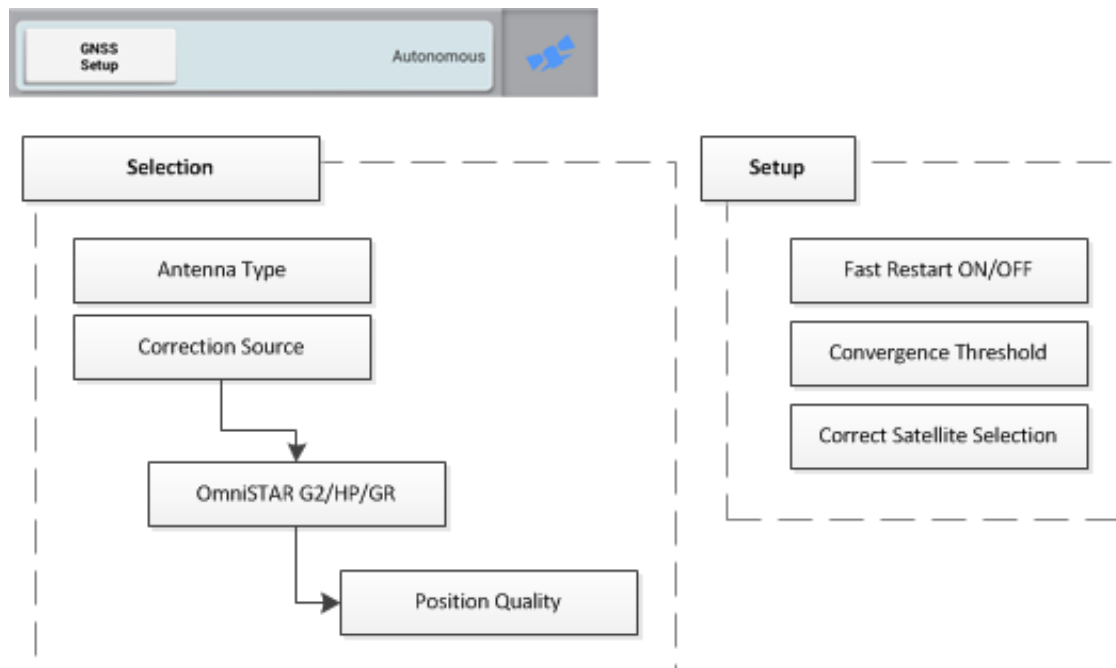

To set up this correction service:

1. Unlock OmniSTAR G2/HP/GR. (See [Feature unlocks, 81.](#))
2. At the **Home** screen, tap .
3. Tap **GNSS Setup** to display the setup panel.

Setting	Options
Position Quality	<p>Select the appropriate choice:</p> <ul style="list-style-type: none"> • Favor Accuracy (Default) : Use for operations needing highest accuracy (such as row crop planting and strip-till). • Balanced Quality: Trades potential accuracy for longer production time. • Favor Availability: Expands production time further with potential for reduced accuracy.
Fast Restart	<p>Choose a Fast Restart option:</p> <ul style="list-style-type: none"> • On (Default): Reduces the time for position to converge so that the system is ready for operation faster. Tap On when the vehicle is parked in an area with a clear view of the sky, and will not be moved until next use. • Off: Does not use Fast Restart.
Convergence Threshold	<p>Set the convergence level at which the system will allow you to start guidance operations.</p> <ul style="list-style-type: none"> • Enter a convergence value closer to 12 inches for broad acre applications to begin working promptly. • Enter a convergence value closer to 4 inches for row crop applications to ensure desired accuracy is achieved before beginning work.
Correction Satellite Selection	<p>Tap <i>Auto Select</i> for automatic satellite selection, or select a satellite from the list. If you choose <i>CUSTOM</i>, enter the Frequency and Baud Rate.</p>

CenterPoint RTX setup

There are three types of CenterPoint RTX corrections:

- [Modem](#)
- [Satellite Standard](#)
- [Satellite Fast Convergence](#)

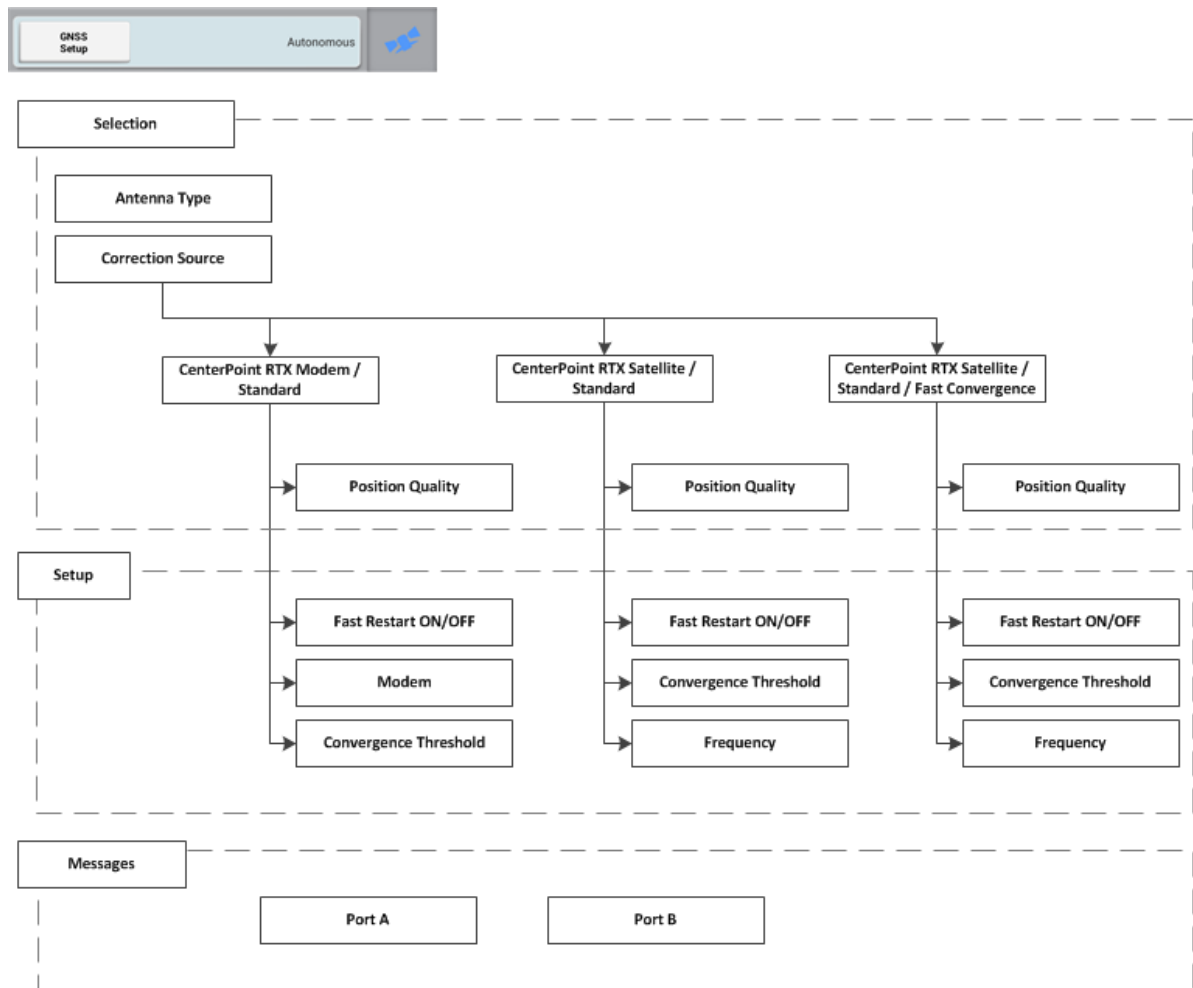

CenterPoint RTX setup

There are three types of CenterPoint RTX corrections:

- [Modem](#)
- [Satellite Standard](#)
- [Satellite Fast Convergence](#)

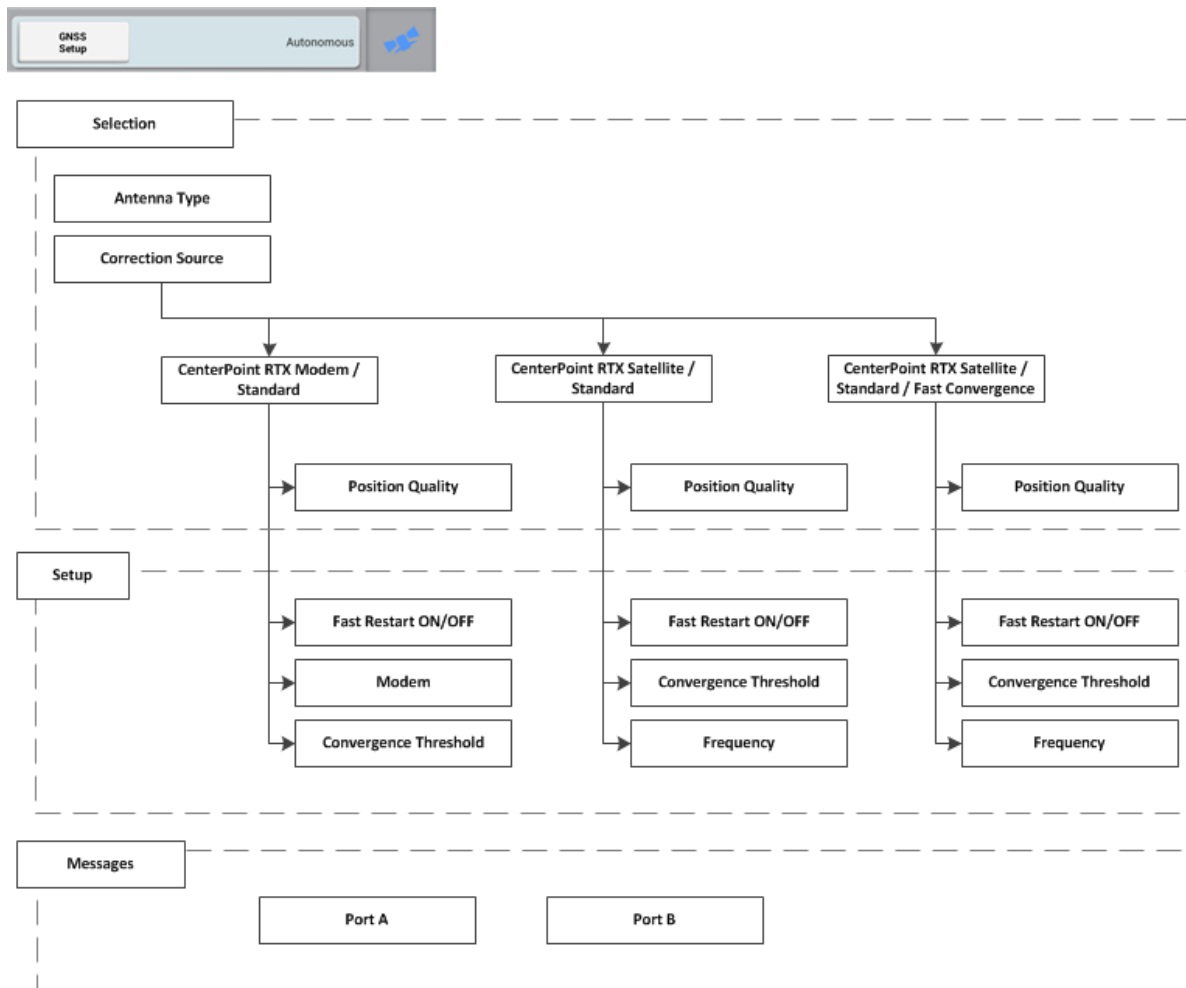

Modem corrections

CenterPoint RTX Modem / Standard is a cellular broadcast subscription service for corrections with < 1.5" (3.8 cm) accuracy and GLONASS compatibility. The DCM-300 modem receives these signals.

To set up this correction service:

1. Connect the DCM-300 modem to the display.
2. Power on the DCM-300 modem and display by turning on the vehicle ignition.
3. Unlock CenterPoint RTX. (See [Feature unlocks, 81.](#))
4. Reboot the DCM-300 modem by turning off the vehicle ignition.
5. Turn the vehicle ignition back on.
6. At the **Home** screen, tap .
7. Tap **GNSS Setup** to display the setup panel.

Setting	Options
Position Quality	Select the appropriate choice: <ul style="list-style-type: none"> • Favor Accuracy (Default) : Use for operations needing highest accuracy (such as row crop planting and strip-till). • Balanced Quality: Trades potential accuracy for longer production time. • Favor Availability: Expands production time further with potential for reduced accuracy.
Fast Restart	Turn on or off.
Modem	DCM-300 is the option available.
Convergence Threshold	Set the convergence level at which the system will allow you to start guidance operations. <ul style="list-style-type: none"> • Enter a convergence value closer to 12 inches for broad acre applications to begin working promptly. • Enter a convergence value closer to 4 inches for row crop applications to ensure desired accuracy is achieved before beginning work.

Satellite corrections

CenterPoint RTX Satellite Standard and CenterPoint RTX Satellite Standard Fast are satellite broadcast subscription services for corrections with < 1.5" (3.8 cm) accuracy and GLONASS compatibility.

The GNSS receiver in the TM-200 Module receives these signals.

To set up either of these correction services:

1. Unlock CenterPoint RTX Satellite for standard or fast convergence. (See [Feature unlocks, 81.](#))
2. At the **Home** screen, tap  .
3. Tap **GNSS Setup** to display the setup panel.

Standard convergence

Setting	Options
Position Quality	Select the appropriate choice: <ul style="list-style-type: none"> • Favor Accuracy (Default) : Use for operations needing highest accuracy (such as row crop planting and strip-till). • Balanced Quality: Trades potential accuracy for longer production time. • Favor Availability: Expands production time further with potential for reduced accuracy.
Fast Restart	Turn on or off.
Frequency	Choose the RTX frequency for your region or enter a custom frequency. Frequency options are: <ul style="list-style-type: none"> • Asia/ Pacific (1539.8325) (Baud Rate= 600) • Central North America (1557.8150) (Baud Rate= 2400) • Custom (Enter the Frequency and Baud Rate) • Eastern North America (1557.8590) (Baud Rate= 600) • Europe/ Africa (1539.9525) (Baud Rate= 600) • Latin America (1539.8325) (Baud Rate= 600) • Western North America (1557.8615) (Baud Rate= 600)
Convergence Threshold	Set the convergence level at which the system will allow you to start guidance operations. <ul style="list-style-type: none"> • Enter a convergence value closer to 12 inches for broad acre applications to begin working promptly. • Enter a convergence value closer to 4 inches for row crop applications to ensure desired accuracy is achieved before beginning work.

Fast convergence

Setting	Options
Position Quality	Select the appropriate choice: <ul style="list-style-type: none"> • Favor Accuracy (Default) : Use for operations needing highest accuracy (such as row crop planting and strip-till). • Balanced Quality: Trades potential accuracy for longer production time. • Favor Availability: Expands production time further with potential for reduced accuracy.
Fast Restart	Turn on or off.

Setting	Options
Convergence Threshold	<p>Set the convergence level at which the system will allow you to start guidance operations.</p> <ul style="list-style-type: none"> Enter a convergence value closer to 12 inches for broad acre applications to begin working promptly. Enter a convergence value closer to 4 inches for row crop applications to ensure desired accuracy is achieved before beginning work.
Frequency	<p>Choose the RTX frequency for your region or enter a custom frequency. Frequency options are:</p> <ul style="list-style-type: none"> Asia/ Pacific (1539.8325) (Baud Rate= 600) Central North America (1557.8150) (Baud Rate= 2400) Custom (Enter the Frequency and Baud Rate) Eastern North America (1557.8590) (Baud Rate= 600) Europe/ Africa (1539.9525) (Baud Rate= 600) Latin America (1539.8325) (Baud Rate= 600) Western North America (1557.8615) (Baud Rate= 600)

VRS corrections

VRS is a cellular-broadcast RTK correction service from a ground-based reference station using the a modem. (Requires a DCM-300 modem.)

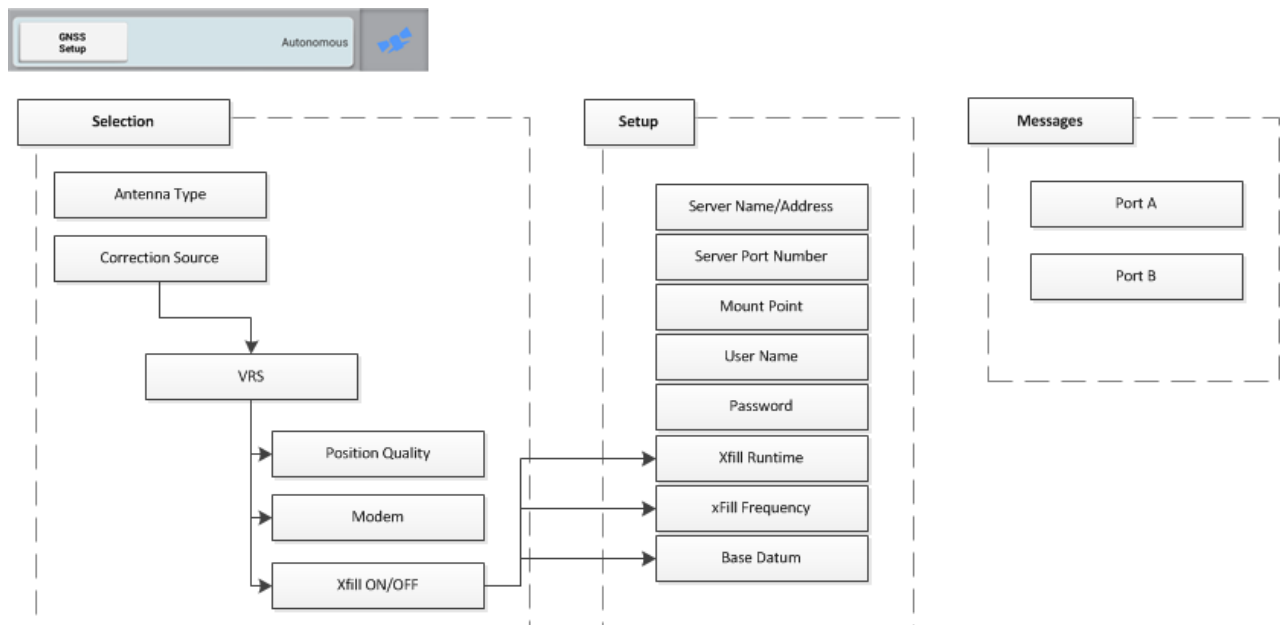

To set up this correction service:

1. Connect the DCM-300 modem to the display.
2. Power on the DCM-300 modem and display by turning on the vehicle ignition.
3. Unlock VRS. (See [Feature unlocks, 81.](#))
4. Reboot the DCM-300 modem by turning off the vehicle ignition.
5. Turn the vehicle ignition back on.
6. At the **Home** screen, tap .
7. Tap **GNSS Setup** to display the setup panel.

Setting	Options
Modem	<ul style="list-style-type: none"> • DCM-300 • Third Party NTRIP Modem (Cannot be used with Autopilot guidance)
xFill (See xFill technology, 133.)	Turn on or off.
Position Quality	Select the appropriate choice: <ul style="list-style-type: none"> • Favor Accuracy (Default) : Use for operations needing highest accuracy (such as row crop planting and strip-till). • Balanced Quality: Trades potential accuracy for longer production time. • Favor Availability: Expands production time further with potential for reduced accuracy.
VRS Server Name/Address	Enter the value provided by your VRS Service provider.
Server Port Number	Enter the value provided by your VRS Service provider.
xFill Runtime	20 minutes.
Note – Available if you have turned on xFill.	How long the display will use xFill technology after the correction service becomes unavailable.

RTK corrections

RTK is a radio-broadcast correction service originating from a ground-based reference station, and received by radio signal. The AG-815 integrated radio receives these signals.

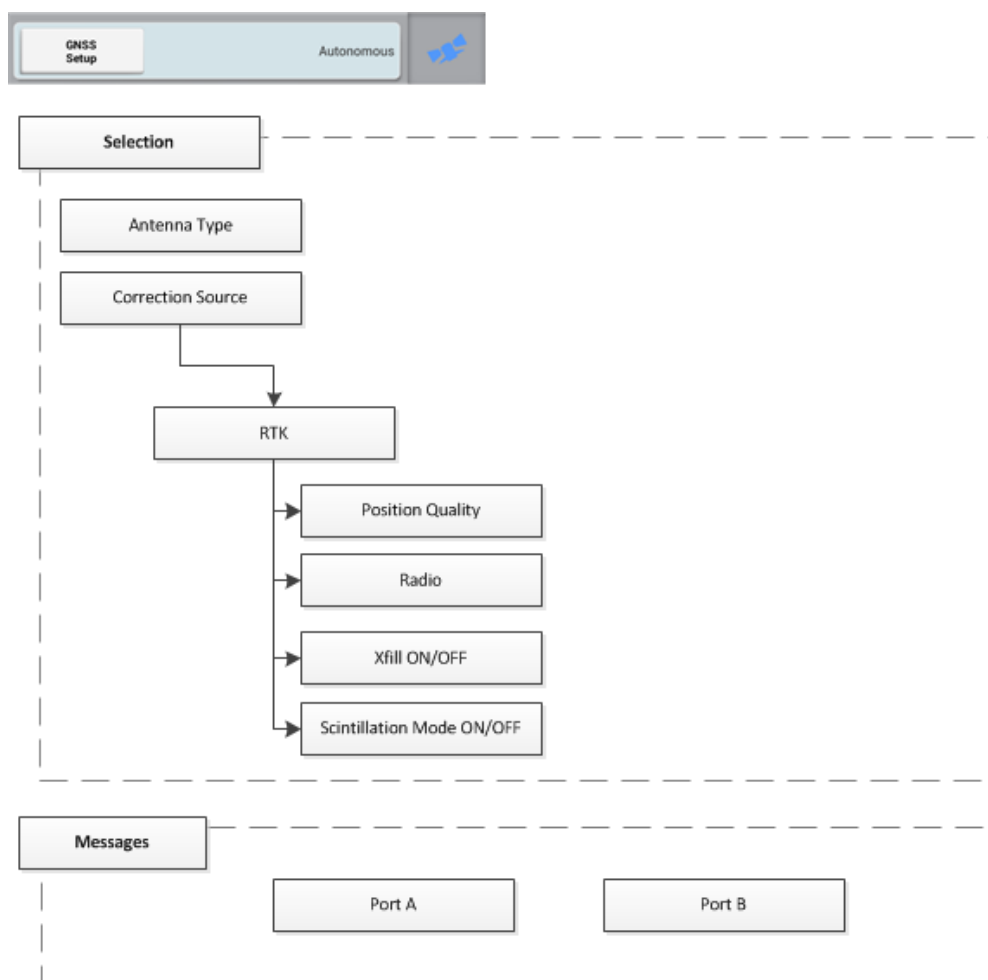

To set up this correction service:

1. Unlock RTK. (See [Feature unlocks, 81.](#))
2. Make sure the AG-815 integrated radio is installed. (See [Connect the AG-815 radio to the TM-200 Module, 103.](#))
3. At the **Home** screen, tap .
4. Tap **GNSS Setup** to display the setup panel.

Setting	Options
Radio	Choose the frequency of the AG-815 integrated radio: 450 MHz or 900 MHz.
xFill (See xFill technology, 133.)	Turn xFill technology on or off.

Setting	Options
Scintillation Mode	Turn mode on or off.
Position Quality	<p>Select the appropriate choice:</p> <ul style="list-style-type: none"> • Favor Accuracy (Default) : Use for operations needing highest accuracy (such as row crop planting and strip-till). • Balanced Quality: Trades potential accuracy for longer production time. • Favor Availability: Expands production time further with potential for reduced accuracy.
Channel/Radio Frequency	<p>Tap to show a list of frequencies. If you have already entered frequencies, choose the appropriate one. Otherwise, tap in the row. A Modify button displays. Tap Modify. Enter a number from 403.0 MHz to 473.0 MHz for the frequency</p> <p>Add an optional description. You can enter up to 40 frequencies, numbers and symbols , using up to 9 characters including the decimal place (e.g., 450.00000).</p>
Protocol	<ul style="list-style-type: none"> • PCCEOC 4800 • PCCEOC 9600 • PCCEOT 4800 • PCCEOT 9600 • PCCFST 19200 • PCCSATEL 19200 • TRIMMARK 2 4800 • TRIMMARK 3 19200 • TT450 4800 • TT450 9600 • TT450S 1600 • TT450S 8000
Secure RTK Keys	Enter up to 5 security keys , with an optional description for each.
xFill Runtime (Available only if you turned on xFill.)	20 minutes. With xFill selected as a backup source, this is how long the display will use xFill after the correction service becomes unavailable.
xFill RTK Base Datum (Available only if you turned on xFill.)	<ul style="list-style-type: none"> • WGS84/ ITRF2008 (Default) • NAD83 • ETRS89 • GDA94

CAN message settings

If you wish to send messages from the GNSS receiver in the TM-200 Module, you can set up what messages will be sent from CAN port A or B. If you are using an ISO-certified implement, use this setting to send information to the implement such as speed. (See [ISOBUS for implements, 191.](#))

1. Tap the CAN port that you want to change settings for. Choose the messages for the GNSS receiver in the TM-200 Module to send to ISO-certified equipment.

The list that displays for each CAN port shows the messages and their parameter group number (PGN). For each message, you can choose how often the message is sent:

- Off (never sent)
- 10 Hz, 5 Hz or 1 Hz
- Every 5, 10, 30 or 60 seconds

2. Tap  to save your settings.

DCM-300 modem initial setup

The DCM-300 modem ships as a locked unit until it is installed with the display. See [Connect the DCM-300 modem, 111.](#)

To use VRS correction or data transfer features, activate and configure these services.

1. Connect the DCM-300 modem to the display.
2. Power on the DCM-300 modem and display.
3. Activate the required services on the display. See [Feature unlocks, 81.](#)
 - a. To use VRS corrections, activate RTK and VRS.
 - b. Vehicle Sync and Office Sync also require activation.
4. Reboot the DCM-300 modem by turning off the vehicle ignition.
5. On the **Home** screen, tap , then tap **Settings**. The system settings panel displays.
6. Tap **Modem Service**.
7. Continue the instructions for setup at [Modem services settings, 88.](#)

Office Sync setup

With the Office Sync service, you can electronically transfer data from the display to the office and to Connected Farm dashboard. Data will be:

- Sent to the office based on user settings.
- Received from the office based on user settings, with no inbox needed.

Requirements

Requirements for exchanging data electronically include the following:

- A configured DCM-300 modem.
 - See:
 - [DCM-300 modem, 98](#)
 - [Connect the DCM-300 modem, 111](#)
 - [DCM-300 modem initial setup, 130](#)
- A Connected Farm account.
- A data plan or access to WiFi.
- Office Sync configured on the display to communicate with your Connected Farm storage area.
 - See [Modem services settings, 88](#).

Settings

1. At the **Home** screen, tap , then tap **Settings**. The **System Information** panel displays.
2. Tap **Modem Services**. Activate the feature and configure the settings.

Setting	Tap to...
Feature Active	Turn the feature on or off.
Check Server	Set how often you want the display to attempt to retrieve data from the server: <ul style="list-style-type: none"> • Push: whenever a message is available it is sent to the display • Pull - 5 minutes: every 5 minutes check the server to see if there are messages to receive • Pull - 10 minutes: every 10 minutes check the server to see if there are messages to receive • Pull - 30 minutes: every 30 minutes check the server to see if there are messages to receive

Setting	Tap to...
Send Data	Choose when you want the display to send information to the office: <ul style="list-style-type: none">• Hourly• On job completion• At the display power up• Prior to shutdown: delays the display's time for powering off
Auto Send Without Prompt	Select whether or not you want the display to send information to the office automatically.

For information on:	See:
Diagnostics	Office Sync Diagnostics, 321
Data transfer	Data transfer, 67

Connectivity concepts

For more information about concepts associated with GNSS, correction services, see:

- [xFill technology, 133](#)
- [GNSS and drift, 133](#)
- [VRS, 137](#)

GNSS and drift

GNSS satellites are in continuous motion as they orbit the earth twice per day in a repeated pattern. Satellites transmit signals that the GNSS receiver translates to determine its position.

While performing field activities, you may notice differences in:

- Where the crop row is
- Where the guidance line was established
- Where the display is indicating the guidance line is now located.

This happens because GNSS satellite constellation patterns change over time and can experience interference.

Local and atmospheric conditions can impact signals. Temperature and humidity can delay signals. Signals can also be reflected from surrounding objects such as trees, causing multiple copies of the signal or a delay in the signal reaching the receiver. Data errors from the satellite can also affect accuracy.

xFill technology

xFill™ technology uses Trimble RTX technology to "fill in" for RTK corrections when there are temporary radio or Internet connection outages. xFill technology is a standard feature and is compatible with the AG25 GNSS antenna. The xFill technology can function with corrections from single-baseline RTK, VRS and CORS systems.

When there is an interruption of the RTK correction signal (either from the radio base station or from the VRS cellular network), the xFill technology performs corrections. xFill technology uses the last-known RTK position combined with the RTX precision satellite data to maintain a high level of horizontal positioning accuracy for up to 20 minutes. There is a smooth transition from RTK to xFill technology and back to RTK.

Automatic guidance systems

If an auto-steering system is engaged using RTK, the auto-steer system will stay engaged during the 20 minute xFill coverage. As soon as an RTK signal is available, the receiver will switch back to the RTK correction service and xFill will remain on standby in the background. If the system cannot resume an RTK Fixed status within 20 minutes the system will fall back to DGPS correction and the auto-steer system will disengage.

Accuracy

xFill technology can maintain a relatively high level of horizontal accuracy throughout the RTK outage period. However, accuracy is primarily dependent on three factors:

- GNSS satellite availability and obstructions between the satellite and receiver (trees, buildings, and so on)
- Exactness of the base station position
- Length of time since the last RTK position (maximum allowable time is 20 minutes)

If you are concerned with maintaining sub-inch precision, disable the xFill feature.

Estimated accuracy over time while the xFill function has been active (with base station accuracy <20cm) is as follows:

- xFill runtime – no RTK corrections Estimated error
- 1-5 minutes 1-5cm
- 6-10 minutes 5-9cm
- 11-20 minutes 10-15cm

Dependence on satellite

xFill technology requires correction data from at least 5 satellites higher than 10 degrees from the horizon. If GLONASS is unlocked at the RTK level, xFill technology will also be able to use GLONASS satellites. Additionally, large objects such as trees, buildings, and grain bins will significantly decrease or completely block signal reception from all satellite types, including GPS, GLONASS, and corrections satellites. If these same obstructions are between the receiver and the satellite, they may also block xFill signals.



WARNING – Many large and sudden changes in satellite geometry caused by blocked satellites can cause significant position shifts. If operating under these conditions, auto-guidance systems can react abruptly. To avoid possible personal injury or damage to property under these conditions, disable the auto-guidance system and take manual control of the vehicle until conditions have cleared.

Dependence on base station position

When the RTK correction signal is lost, the RTX satellite begins providing correction based on the last RTK position. When you setup xFill and select the datum in which you surveyed your base station, the firmware translates your position into the ITRF datum reference frame to minimize drift. Any other inaccuracies in the base station position can cause a drift in position over time.

As time elapses, correction data from the satellites causes drift from the RTK line. The larger the difference in surveyed base station position, the larger the drift as shown in following table.

The following table shows how the xFill drift over time is impacted by the accuracy of the base station survey coordinates.

xFill Elapsed Time	Survey Accuracy <20cm	Survey Accuracy <2m	Survey Accuracy <5m
0 to 5 min	0 to 5 cm	0 to 15 cm	0 to 25 cm
5 to 15 min	2 cm to 12 cm	10 cm to 0.3 m	15cm to 0.5 m
15 to 20 min	9 cm to 15 cm	15 cm to 0.4 m	0.3m to 0.8 m

If you discover that the surveyed location of your base station is not accurate, your options are:

- Turn off xFill (recommended by Trimble).
- Resurvey your base station. However, this will cause the movement of any stored AB lines that are reloaded/reused which is very undesirable to many RTK customers.

Base station survey

At initial base station installation, Trimble recommends surveying base stations by taking a 24-hour log and processing the data to receive position on your local datum. The accuracy of this position is stated in the report. Over time, primarily due to normal geological events, the base station position may change up to 7cm per year. Please refer to Trimble Support Note on this topic for further information.

When you select the datum used to survey your base station during the xFill technology setup, the receiver will automatically convert your position in the datum you select to the equivalent position in ITRF2008.

If your base station was properly surveyed within the last five years using one of the following coordinate systems, the xFill technology accuracy error will typically be less than 15cm over 20 minutes.

- WGS84/ITRF2008
- NAD83
- ETRS89
- GDA94

When working within an area with several RTK base stations, each base station should have a unique Base ID. When moving in range of another base station, go to the GPS setup on the display and enter the Base ID. This enables the receiver to recognize the new base station.

Base station survey with AutoBase™

If the Trimble Auto Base feature was used to survey the base, the accuracy can be >5m, which decreases the xFill technology accuracy. The datum used for this feature is WGS84. Trimble recommends testing xFill prior to using it in an application where the base station has only been surveyed with Auto Base.

VRS base station

If using VRS, the accuracy is typically <1cm . Contact your VRS network owner to determine the datum used for surveying and enter this datum during the xFill technology set-up. Trimble VRS Now™ network uses the following:

- VRS Now US: NAD83
- VRS Now Europe: ETRS89
- VRS Now TEC Europe: ETRS89
- OmniSTAR® CORS Tasmania: GDA94

Base station, survey unknown

If you do not know if your base station has been surveyed or the datum used for surveying, you should perform testing to approximate your base station errors or turn off xFill technology .

Estimating base station errors

To estimate the error in the position of the base station, options include:

- **Calculate Current Position and Compare to Set Position:** Collect two hours of position logs and submit them for post-processing (using the same coordinate system as previously used). Then enter the current set position and the newly calculated position into a GPS distance tool calculator.
- **xFill Accuracy Detection Using Cross Track Error:** Set-up your antenna and receiver in an open air environment (field or parking lot). Create an A+ line based on your parked position with RTK fixed. Unplug the radio or unplug the DCM-300 modem if using cellular signal. xFill technology will engage. Watch your cross track error (XTE) for a maximum of 20 minutes. Repeat several times. Keep in mind that this static test only tests the error in one direction (N/S or E/W).
- **xFill Accuracy During Passes in a Field:** To best see the drift of the xFill position over time:
Note – This procedure will only be accurate if you have already completed the Roll Calibration for auto-steering. (See [Vehicle setup, 140.](#))
 - a. Create an A/B line in your field (or use an existing line). (See [AB guidance line creation \(Run screen\), 251.](#))
 - b. Drive the line and once your cross track error (XTE) is very small, stop and drop a flag in the center of your hitch.
 - c. Turn off RTK by changing the network ID or frequency.
 - d. Drive around the field for several minutes (to represent your typical outage time) and return to the A/B line.
 - e. Engage on the line and then when XTE is small and you're over your previous flag, stop and drop another flag. Compare the distance.

- f. Make a pass in the other direction on the same A/B line and drop a third flag. Compare the distance.

When not to use xFill technology

xFill technology is not recommended for:

- Land leveling and water management applications where a high degree of vertical accuracy is required.
- Any operation where you need accuracy better than 1" (2.4cm).
- When the base station has not been properly surveyed, or has been surveyed only with the Auto Base functionality and no tests have been performed to assess the risk of using xFill technology with that base station.

VRS

VRS™, an integrated system available with a subscription, is complementary to RTK and provides RTK corrections over a large geographic area, where robust cellular data coverage is available. Network processing ensures high accuracy throughout the whole coverage area.

VRS consists of:

- GPS/GNSS reference stations spread out over a large area, typically 30-45 miles (50-70 km) apart.
- A central server that uses Trimble proprietary software to create a correction model for the region covered by the network. GPS rovers communicate using a cell modem with the VRS server and receive RTK type corrections. The data from the reference stations is used to model errors throughout your region. The model is used to:
 - Create a network of virtual reference stations near your current location.
 - Provide a localized set of standard format correction messages for your roving receiver. Since the error models are updated every second, all rovers receive an optimal correction model after connecting on to the network. This ensures a high quality correction, and accuracy.

Network solution

All reference stations used in a VRS system can be interpreted as a network of continuously operated reference stations. The difference between VRS and CORS is that VRS provides a network solution. The position accuracy is maintained even if you move away from the single base but are still within the network.

Due to the longer range, fewer base stations can cover a greater region. Additionally, VRS networks may offer better signal coverage in rough terrain if the local cellular network is robust and provides good data coverage.

Vehicles

In this chapter:

Vehicle setup	140
Add a vehicle	140
Delete a vehicle	142
Edit a vehicle	143
Save a vehicle	143
Vehicle summary	144
Select a vehicle	145
Manual guidance setup	145
Autopilot system setup	146
OnSwath	151
Autopilot system calibration	152
EZ-Pilot system setup	167
EZ-Pilot system calibrations	170
EZ-Steer system setup	173
EZ-Steer system calibrations	176

You can add, edit, save, delete and select vehicles. Part of vehicle setup includes entering settings for auto guidance systems, providing vehicle measurements and calibrating the vehicle with the guidance system.

Vehicle setup

On-screen vehicles in the XCN-2050 display represent actual vehicles, and include basic information about your vehicle as well as its type of guidance system and calibrations.

Note – *Prior to using a vehicle for field activities, you must complete all settings for a vehicle, including calibrations. Then you must select the vehicle.*

Vehicles can be:

- Added (see [Add a vehicle, 140](#))
- Saved in a partial or complete state (see [Save a vehicle, 143](#))
- Removed (see [Delete a vehicle, 142](#))
- Changed (see [Edit a vehicle, 143](#))
- Viewed in a summary form (see [Vehicle summary, 144](#))
- Selected for use in field activities (see [Select a vehicle, 145](#))

Overview of setup

An overview of the steps for setting up a vehicle includes:

1. Selecting the vehicle type and entering basic vehicle information:
 - Guidance type: Manual, Autopilot, EZ-Pilot or EZ-Steer
 - For the Autopilot and EZ-Steer systems, navigation controller orientation: How the controller is oriented in the vehicle
 - For the EZ-Pilot system: How the label is facing on the IMD-600
 - Settings for steering and speed
 - Measurements: Measurements for the location of the antenna and other vehicle measurements
2. Calibrating the guidance system with the vehicle.

Add a vehicle

Note – *You must complete all vehicle setup and calibration steps before you can select and use the vehicle for field activities on the **Run** screen.*

- At the **Home** screen, tap . The Vehicle setup panel displays.



- Tap **ADD VEHICLE**. A list of vehicle types displays.



- Tap the type of vehicle to set up.
- To enter information about the vehicle's make, model and so on, tap **Next**.

Note – Only vehicles on the current Trimble supported platforms for Autopilot, EZ-Pilot, and EZ-Steer list are in the database. Generic vehicles are selectable for each vehicle type for manual guidance.

Tap...	To enter or select...
Make	Vehicle manufacturer
Series	Vehicle series (when applicable)
Model	Vehicle model
Option	Vehicle options from the manufacturer (Examples: Super Steer, Non Super Steer, ILS, Non-ILS, or ISO CAN Ready)
Vehicle Name	The name of the vehicle is pre-filled from the options you chose for Make, Series, and Model. You can optionally change this name if you wish.

- Tap **Next**. The SELECTION section displays. The receiver serial number is displayed, indicating the GNSS receiver in the TM-200 Module is receiving signals.
 Confirm that this is the proper serial number for the TM-200 Module attached to the XCN-2050 display. When moving displays between vehicles, this is not automatically updated.
- Tap **Next**. A list of steering/guidance types displays. The choices will depend on the vehicle:
 - Autopilot
 - EZ-Pilot

- EZ-Steer
 - Manual Guidance
7. Tap the type of guidance system the vehicle uses.
 8. Continue entering settings for the vehicle and guidance system. For instructions, see the section that applies to your guidance system:
 - [Autopilot system setup, 146](#)
 - [EZ-Pilot system setup, 167](#)
 - [EZ-Steer system setup, 173](#)
 - [Manual guidance setup, 145](#)



WARNING – Auto guidance systems cannot avoid items in the field such as obstacles. Make sure you are adequately trained to operate the auto guidance system.

For instructions on saving the vehicle, see [Save a vehicle, 143](#).



Delete a vehicle



CAUTION – If you delete a vehicle, all information about the vehicle will be erased.

1. At the **Home** screen, tap . The Vehicle setup panel displays.





2. On the left-hand side in the list, tap the name of the vehicle you want to delete.
3. On the right-hand side, tap **Delete**. A confirmation message displays asking you to confirm removal of the vehicle.
4. To delete, tap . You return to the Vehicle setup panel at the **Home** screen.
5. To cancel the deletion, tap .

Edit a vehicle

1. At the **Home** screen, tap . The Vehicle setup panel displays.



2. At the VEHICLES list on the left-hand side of the setup panel, tap the name of the vehicle you want to edit. The display changes the list item to a blue background with white text.
3. On the right-hand side, tap **Edit**. The SUMMARY section displays.
4. Navigate to the section(s) where you want to make changes.
5. After you have completed your changes, tap **SUMMARY**.
If you have not completed all the required information, you can save the edits you made. However, you cannot use the vehicle on the **Run** screen.
6. When you are finished, tap **SUMMARY**. Tap  to save your settings.
7. To discard the changes and leave the vehicle setup panel, tap  or  on the left-hand side of the display bar. A message displays, asking if you want to leave the setup panel without saving your changes. After tapping **No**, you return to the Vehicle setup panel.

For details on the vehicle summary, see [Vehicle summary, 144](#).

For information on guidance system types, see the applicable section:

- [Autopilot system setup, 146](#)
- [EZ-Steer system setup, 173](#)
- [EZ-Pilot system setup, 167](#)
- [Manual guidance setup, 145](#)

Save a vehicle

You can save:

- Complete vehicle settings after reviewing the SUMMARY section. For details on the vehicle summary, see [Vehicle summary, 144](#).
- Unfinished vehicle settings, then complete the setup later.

If you have not completed all the required information, you can save the edits you made. However, you cannot use the vehicle profile in field activities on the **Run** screen.

Save a complete vehicle profile

1. Complete all vehicle settings, including calibration.
2. At the SUMMARY section, tap . The display saves the vehicle and returns to the Vehicle setup panel.



Save an incomplete vehicle profile

Note – You must complete all vehicle setup and calibration steps before you can use the vehicle for field activities on the **Run** screen.

1. At a minimum, enter some basic information: vehicle type, make and model.
2. At the SUMMARY section, tap . The display saves the vehicle and returns to the Vehicle setup panel at the **Home** screen.

Vehicle summary



The SUMMARY section of a vehicle profile contains the vehicle information and configurations. Incomplete information will be noted as "Incomplete".

To...	Tap...
Save the vehicle with any changes you have made.	
Exit the setup without saving changes. The display will ask you to either save the changes or exit without saving.	 (Home on the left side of the display bar)
	 (Return on the left side of the display bar)
Quickly access any part of the setup.	The buttons at the top of the screen

Select a vehicle

Before you can calibrate a vehicle or enter the **Run** screen, you must select the vehicle you want to use for field activities.

Note – You can only enter the **Run** screen with a vehicle that has had vehicle setup and calibration steps completed.

1. At the **Home** screen, tap . The Vehicle setup panel displays.
2. At the list on the left-hand side of the setup panel, tap the name of the vehicle you want to select. The display changes the list item to a blue background with white text.
3. To select the vehicle before performing field activities at the **Run** screen, tap **Select**. The name of the vehicle highlights in blue and the  indicates which vehicle you chose.



Note – Without a blue highlight, the  indicates a vehicle that was selected previously.

4. The display indicates in the lower left-hand portion of the screen which vehicle is selected for field activities.

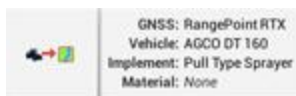

Manual guidance setup

1. Navigate to the GUIDANCE section of the vehicle setup panel:
 - a. At the **Home** screen, tap . The Vehicle setup panel displays.
 - b. At the list on the left-hand side of the setup panel, tap the name of the vehicle you want to edit. The display changes the list item to a blue background with white text.
 - c. Tap **Edit**, then **GUIDANCE**.
2. Tap **Selection**, then tap **Manual Guidance**.

Autopilot system setup

Settings for the Autopilot system include:

- The type of platform for the Autopilot system
- The origin of the vehicle profile
- Controller and sensor settings
- Vehicle measurements
- Calibrations

Guidance system settings for Autopilot system



WARNING – Auto guidance systems cannot avoid items in the field such as obstacles. Make sure you are adequately trained to operate the auto guidance system.

1. Navigate to the GUIDANCE section of the vehicle setup panel:

- At the **Home** screen, tap . The Vehicle setup panel displays.
- At the list on the left-hand side of the setup panel, tap the name of the vehicle you want to edit. The display changes the list item to a blue background with white text.
- Tap **Edit**, then **GUIDANCE**.

2. At the SELECTIONS section, complete the settings:

Tap...	Explanation
Selection	Autopilot
Autopilot Platform	The appropriate platform for your vehicle.

Tap...	Explanation
Vehicle Profile Origin	<p>The source of the vehicle profile:</p> <ul style="list-style-type: none"> • Vehicle Profiles Database: contained in the display • Import from Navigation controller: If your navigation controller has already been set up for a different Trimble display, the vehicle profile is stored in the controller. • Import from USB: profile stored on USB drive (These configuration /.cfg files are located in the AgData/Profiles folder on the USB drive.) (See <i>USB transfer of vehicle configuration for Autopilot</i> in Data transfer, 67.) <p> CAUTION – If you select a <i>Vehicle Profile</i> that is not suitable for your vehicle, you may experience degraded system performance.</p>
GNSS Setup Selection	If you have not completed GNSS setup. See GNSS receiver settings, 116.
Configure GNSS	Setup GNSS if you have not already done so.

 **WARNING** – Many large and sudden changes in satellite geometry caused by blocked satellites can cause significant position shifts. If operating under these conditions, auto-guidance systems can react abruptly. To avoid possible personal injury or damage to property under these conditions, disable the auto-guidance system and take manual control of the vehicle until conditions have cleared.

3. Tap **Next** to continue to [Controller settings for Autopilot system, 147.](#)

Controller settings for Autopilot system

The navigation controller indicates to the XCN-2050 display how your vehicle is positioned. To set up the controller, you must indicate the position/orientation of the controller as it is currently installed in the vehicle.

For example, if the controller is positioned with the input jacks of the controller facing to the left side of your vehicle, you indicate this in the XCN-2050 display.

The CONTROLLER SETTINGS section of the vehicle setup panel shows an image of the controller as though you are looking down on the vehicle from above, with the front of the vehicle at the top of the screen.

1. Navigate to the GUIDANCE section of the vehicle setup panel:
 - a. At the **Home** screen, tap . The Vehicle setup panel displays.
 - b. Tap **Edit**.
 - c. At the list on the left-hand side of the setup panel, tap the name of the vehicle you want to edit. The display changes the list item to a blue background with white text.
 - d. Tap **Edit**, then **GUIDANCE**.
2. Tap **CONTROLLER SETTINGS**.
3. Rotate the on-screen controller to match the position of the actual controller in the vehicle as you are looking down from the top, with the nose of the tractor point to the top of the screen. Tap the arrow buttons to move the on-screen navigation controller clockwise or counterclockwise.



4. Optionally you can directly enter the degrees of the position by tapping **Yaw**, **Pitch** and **Roll**. Non-orthogonal entries will not show the orientation on the display.
5. When the controller position on the screen matches the controller installed in the vehicle, continue to the sensor settings. See [Sensor settings for Autopilot system, 148](#).

Sensor settings for Autopilot system

Note – Adjust sensor settings only if necessary to improve steering performance.

1. Navigate to the **GUIDANCE** section of the vehicle setup panel:
 - a. At the **Home** screen, tap . The Vehicle setup panel displays.
 - b. Tap **Edit**.
 - c. At the list on the left-hand side of the setup panel, tap the name of the vehicle you want to edit. The display changes the list item to a blue background with white text.
 - d. Tap **Edit**, then **GUIDANCE**.
2. Tap **SETTINGS**. Complete the information at the SETTINGS section.

Note – Not all setting items will be available for all vehicles. Setting items are only available to the applicable vehicle types.

Tap...	To...
Steering Sensor	Select the type of angle sensor installed on the vehicle: <ul style="list-style-type: none"> Potentiometer AutoSense™ device
AutoSense Location	Select the location of the AutoSense device: <ul style="list-style-type: none"> Left Wheel Right Wheel
AutoSense Orientation	Indicate the direction the AutoSense label is facing: <ul style="list-style-type: none"> Label Up Label Down <p>Note – If the orientation is not accurate, assisted steering may be affected.</p>
Valve On Speed	Select speed. For vehicles operating at very slow speeds, select Low or Ultra Low. <ul style="list-style-type: none"> Normal - 1.3 ft/s (0.4 m/s) Low - 0.3 ft/s (0.1 m/s) Ultra Low - 0.07 ft/s (0.02 m/s)

Vehicle measurements for Autopilot system

Note – For Autopilot guidance with untracked or tracked vehicles, **do not** change vehicle measurements unless they are not correct.

At MEASUREMENTS, you can enter and access the measurements that apply to the vehicle type you selected. In addition to measurements of the vehicle itself, measurements related to the antenna location are important for accuracy.

1. Before you take measurements:
 - a. Park the vehicle on level ground.
 - b. Make sure the vehicle is straight, with the center line of the body parallel to the wheels.
2. Navigate to the MEASUREMENTS section of the vehicle setup panel:
 - a. At the **Home** screen, tap . The Vehicle setup panel displays.
 - b. Tap **Edit**.
 - c. At the list on the left-hand side of the setup panel, tap the name of the vehicle you want to edit. The display changes the list item to a blue background with white text.
 - d. Tap **Edit**, then **GUIDANCE**.
3. Tap **MEASUREMENTS**. Based on your selections up to this point, some measurements will be

pre-filled.



4. Confirm all pre-filled measurements and enter the others.

For the Antenna Height, measure the distance from the ground to the base of the GPS receiver (or antenna).

OnSwath

With OnSwath™, you can customize line acquisition to the vehicle, operation and operator preference. Vehicle behavior during line acquisition is more controlled, more predictable, and more repeatable.

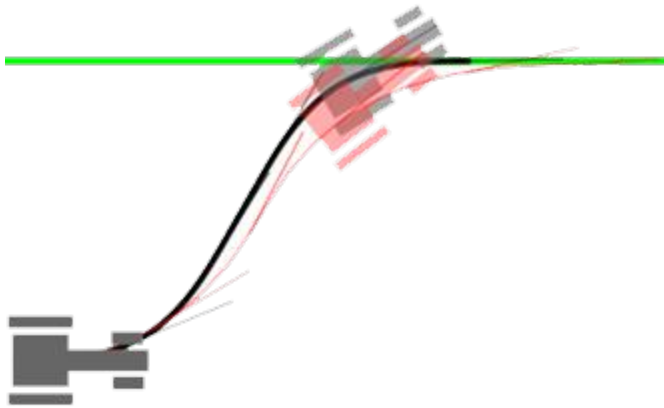

The benefits of OnSwath include:

- Up to 50% faster line acquisition
- Separate tuning for online and line acquisition
- More repeatable performance
- Consistent performance over entire speed range.
- Cab shake eliminated on articulated machines
- Limited turn rates reduce impact on field for tracked machines
- Front axle/nose overshoots more, so that the
- Rear axle on the guidance line faster due to front axle/nose overshooting more

To set up and use OnSwath, see the *Autopilot Toolbox II Guide* and complete calibrations.

OnSwath requires:

- Autopilot firmware 6 and higher
- Autopilot Toolbox II version 3 or higher

Autopilot system calibration

The calibration process for the Autopilot system records additional details about your vehicle, which helps the system to steer the vehicle more accurately. For high accuracy systems, you must have all the correct calibrations.

Note – Currently CAT hydraulic installation Challenger vehicles and John Deere Tracked vehicles using the SIU-200 Interface box cannot be calibrated with the XCN-2050 display.

The CALIBRATION section lists only the calibrations required for the selected vehicle and steering system.

Note – Calibration is only complete when all calibrations on the screen show results instead of Incomplete. Prior to performing calibrations ensure you completed the steps to [Controller settings for Autopilot system, 147](#).

1. Remove any implement from the vehicle. Drive the vehicle to an open area free of obstacles in which the vehicle can make long passes (400m/.25 mile).
2. At the Vehicle setup panel, select the vehicle you want to work with. See [Select a vehicle, 145](#) for detailed instructions.
3. Tap **Calibrate**. The display shows **only** the calibrations required for the vehicle you have selected.
4. Perform each of the calibration procedure selections presented. Following the on-screen instructions when applicable. More detailed information on each calibration follows.
5. When you are finished, tap  to save the calibrations.

Calibration for non-tracked vehicles

Calibration	Explanation
Manual override sensitivity calibration, 153 Note – For vehicles that use a pressure transducer or column encoder for the manual override.	Adjusts how much force is required to disengage the system when the driver turns the steering wheel. Note – The system detects whether the vehicle configuration includes this type of sensor. This option only appears if required.
Sensor settings for Autopilot system, 148 Note – Only for vehicles with a potentiometer style steering sensor.	Maps the steering angle sensor voltage into a steering angle measurement.

Calibration	Explanation
Automated steering deadzone calibration, 156 Note – Only for front wheel steered and articulated vehicles.	For learning the vehicle's steering dead zones. Determines the minimum valve command required for steering movement.
Proportional steering gain, 160	Sets the proportional gain to control steering overshoot and responsiveness.
Steering sensor calibration, 154	Converts the voltage output of the steering angle sensor into an equivalent steering angle measurement.
Line acquisition, 165	Controls how fast the guidance system attempts to steer the vehicle onto the current guidance line (50% - 150%).
Engage aggressiveness, 166	How aggressively the vehicle initially engages on the guidance line (50% - 150%).
Roll correction calibration, 162	Compensates for minor variations in the placement of the navigation controller and GNSS antenna.

For information on: See:

Diagnostics [Autopilot system diagnostics, 296](#)

Manual override sensitivity calibration



WARNING – Incorrect adjustment of *Manual Override Sensitivity* could cause this critical safety feature to fail, resulting in personal injury or damage to the vehicle. Do not to choose a setting that is either too sensitive or not sensitive enough. It is vital to avoid setting the sensitivity so low that the system will not detect any steering wheel motion.

Note – This control is for platforms that use a pressure transducer or encoder for manual override. The software detects whether or not the system uses this type of sensor.

One way to disengage the Autopilot system is to turn the steering wheel or manually override automatic steering. When you turn the steering wheel, there is a voltage spike that then tapers off. This spike and decline occurs at different levels for different models of tractor.

Manual Override Sensitivity sets the level that the voltage must reach before the guidance system disengages. The voltage must also drop below that level before automated steering can be engaged again.

A high level of sensitivity causes the system to disengage more quickly, and you must wait longer before you can re-engage. A low level of sensitivity causes the system to take longer to disengage, and you will be able to re-engage more quickly.

1. At the Vehicle setup panel, select the vehicle you want to work with. See [Select a vehicle, 145](#) for detailed instructions.
2. Tap **Calibrate**.
3. Tap **Manual Override Sensitivity**. The system displays the calibration tool.



4. Turn the steering wheel. If the threshold is crossed, the steering wheel will change color.
5. If the disengage response is acceptable, tap  and then perform the next calibration.
6. If the response is **not** acceptable, and:
 - a. The system disengages too easily, move the slider bar to the right to increase the value and decrease the sensitivity.
 - b. The system seems hard to disengage, move the slider bar to the left to decrease the value and increase the sensitivity.

Note – The default setting provides a balance between rapid activation of the override function and rejection of steering wheel motion due to incidental contact (for example, due to travel in a rough field).

 - c. Repeat steps 4 and 5 until the disengage response is acceptable.



Tip – Evaluate *Manual Override Sensitivity* under conditions which may affect the pressure of the hydraulic system. For example, turn on the auxiliary hydraulics while you evaluate the sensitivity.

7. Tap  to exit without saving. The display returns to the CALIBRATION section where you can perform another calibration or exit.

Steering sensor calibration

Steering sensor calibration converts the voltage output of the steering angle sensor into an equivalent steering angle measurement.

Note – *Steering sensor calibration is only for platforms with a rotary potentiometer installed.*

Note – Complete this calibration before you attempt the steering deadzone ([Automated steering deadzone calibration, 156](#)) or roll correction ([Roll correction calibration, 162](#)) calibrations.

1. Drive the vehicle to a field with a hard, level surface without obstructions.
2. At the Vehicle setup panel, select the vehicle you want to work with. See [Select a vehicle, 145](#) for detailed instructions.
3. Tap **Calibrate**.
4. Tap **Steering Sensor**. The calibration tool displays.
5. Read the instructions and tap the **Next**.
6. Steer straight ahead and drive forward slowly. Maintain a tractor speed above 1.6 kph (1 mph). Tap **Next**.
7. Turn the steering wheel all the way to the left and continue moving forward.
 - a. Note the sensor voltage value.
 - b. While the steering wheel is at the full left position, tap **Next**.
8. Turn the steering wheel all the way to the right.
 - a. Note the sensor voltage value.
 - b. While the steering wheel is at the full right position, tap **Next**.
9. Steer straight ahead and drive for a while to ensure you are traveling straight.
10. Check the value. The center should be approximately 2.5 volts. The calibration process attempts to map the values for a full left turn, a full right turn and center steering.
 - a. Note the sensor voltage value.
 - b. When the vehicle is going straight, press **Next**.
11. Turn the steering wheel to full left and full right.
 - a. Check that the voltage value and degree value does not stop changing before the steering articulation hits the end stops.
 - b. Ensure that the full left turn and the full right turn are at approximately the same value.
 - c. If the values are not approximately symmetrical, tap **X** to discard the calibration and repeat step 6 through step 9. The steering sensor may require adjustment or replacement if:

The value...	Outcome
For sensor volt	Not symmetrical for full left and full right turns
For degrees	Not near 0
For voltage	Stops changing before the articulation of the steering is to the full left or full right position

12. Tap  to accept the calibration.
13. To restart the calibration, tap **Steering Sensor**.

Automated steering deadzone calibration

The *Automated Deadzone* calibration runs a series of tests on the valve and steering hydraulics to determine the steering signal where steering movement occurs. It determines the minimum valve command required for steering movement when you direct the vehicle to turn to the right or left.

In this test, the system independently calibrates both sides of the steering system to determine the point at which wheel movement occurs for each direction.

Note – *Large obstacles or terrain variation may cause erratic steering position readings which may degrade the calibration done smooth, level surface recommended for this calibration.*



WARNING – During the Deadzone calibration, the system moves the vehicle's steering wheel. To avoid injury, be prepared for sudden vehicle movement.

Pre-calibration steps

Complete these steps **before** you begin calibration:

1. Complete the vehicle profile steps for setup.
2. Warm up the vehicle. The hydraulic fluid must be at normal operating temperature for deadzone calibration.

Note – *On some vehicles with large reservoirs, it may take a longer amount of time for the fluid to reach operating level, especially if the implement circuit is lightly loaded. Consult the vehicle documentation to determine if the hydraulic fluid temperature can be shown on a vehicle console.*
3. If you perform the deadzone calibration while the system is cold, repeat both the Automated Deadzone and Steering Gain (see [Proportional steering gain, 160](#)) calibrations again when the system is at operating temperature.
4. Prepare the steering sensor:
 - a. If the vehicle has an AutoSense device, drive the vehicle in a straight line for at least one minute.
 - b. If the vehicle has a Potentiometer, complete the *Steering Sensor* calibration first. See [Steering sensor calibration, 154](#).

Calibration steps

1. Drive the vehicle to a large field without hazards or obstructions. The field should have smooth soil that is loose but firm.



CAUTION – Obstacles in the field can cause collisions, which may injure you and damage the vehicle. If an obstacle in the field makes it unsafe to continue the Automated Deadzone calibration, stop the vehicle and turn the steering wheel to disengage the system.

- 1) Wait until the display prompts you that the phase is ready to begin.
 - 2) Look at the screen to determine whether the next phase will require a left or right turn.
 - 3) Reposition the vehicle so that the turn will use the space that you have available.
 - 4) Tap the button to begin the next phase.
-

2. At the Vehicle setup panel, select the vehicle profile you want to work with. See [Select a vehicle, 145](#) for detailed instructions.
3. On the left-hand side, tap **Calibrate**.
4. Tap **Automated Steering Dead Zone**. The calibration panel displays.
5. Center The steering and tap **Next**.
6. Read each instruction and then tap **Next**.
7. Center the steering on the tractor and move forward in first gear at high RPM for at least five seconds.
8. Tap **Test Right** and continue moving forward while the system performs a coarse right side test.
9. When the test is finished, center the steering again and drive forward for five seconds.
10. Tap **Test Left** and continue moving forward while the system performs a coarse left side test.
11. Tap **Accept** to accept the calibration. The system displays the AutoPilot calibration panel again.
12. Continue driving ahead slowly and tap **Test Right**. The system will perform the first right hand fine calibration.
13. Repeat the right and left hand fine calibrations until there is a change of less than .5 in each of the deadzone values

To minimize the total amount of space needed for the complete calibration, you can reposition the vehicle between each calibration process. If available flate, smooth space is extremely limited, re-align the vehicle after each calibration.

Note – If you encounter any error messages during calibration, refer to the [Automated Deadzone error messages](#) in this section.

Automated Deadzone error messages

Message: Error -	Explanation
Manual Override Detected	Manual override was detected before the calibration cycle could be completed. Retry the calibration.
No GPS	A GNSS receiver must be connected and outputting positions before the software can run the calibration procedure.
No Steering Response Detected	During the calibration cycle, there was not enough movement for the calibration to complete. If the problem persists, the hydraulic installation could be faulty.
Software Problem Detected	The software was unable to complete the calibration due to insufficient movement of the vehicle. If the problem persists, contact Technical Support.
Steering Close To End Stops	Before the calibration cycle could be completed, the measured steering angle approached the end stops. Retry, and if the problem persists, instead of centering the steering at the start of each cycle, try turning the steering in the opposite direction to that which is being tested so that the calibration procedure has a greater range to test over.
Unable To Determine DZ: Try Again	A problem occurred when trying to compute dead zone. Retry. If the problem persists, contact Technical Support.
Valve Connectors Could Be Swapped	The calibration test sensed the steering turning in the opposite direction to what was expected. Retry. If the problem persists, either the valve connectors have been accidentally swapped or the steering sensor calibration was performed incorrectly.
Vehicle Moving Too Slow	The vehicle was moving too slowly for the calibration cycle to successfully finish. Make sure the vehicle is moving at least 0.8 kph (0.5 mph) during each calibration cycle.

Calibration steps

1. Drive the vehicle to a large field without hazards or obstructions. The field should have smooth soil that is loose but firm.



CAUTION – Obstacles in the field can cause collisions, which may injure you and damage the vehicle. If an obstacle in the field makes it unsafe to continue the Automated Deadzone calibration, stop the vehicle and turn the steering wheel to disengage the system.

- 1) Wait until the display prompts you that the phase is ready to begin.
- 2) Look at the screen to determine whether the next phase will require a left or right turn.

-
- 3) Reposition the vehicle so that the turn will use the space that you have available.
 - 4) Tap the button to begin the next phase.
-

2. At the Vehicle setup panel, select the vehicle profile you want to work with. See [Select a vehicle, 145](#) for detailed instructions.
3. On the left-hand side, tap **Calibrate**.
4. Tap **Automated Steering Dead Zone**. The calibration panel displays.
5. Center The steering and tap **Next**.
6. Read each instruction and then tap **Next**.
7. Center the steering on the tractor and move forward in first gear at high RPM for at least five seconds.
8. Tap **Test Right** and continue moving forward while the system performs a coarse right side test.
9. When the test is finished, center the steering again and drive forward for five seconds.
10. Tap **Test Left** and continue moving forward while the system performs a coarse left side test.
11. Tap **Accept** to accept the calibration. The system displays the AutoPilot calibration panel again.
12. Continue driving ahead slowly and tap **Test Right**. The system will perform the first right hand fine calibration.
13. Repeat the right and left hand fine calibrations until there is a change of less than .5 in each of the deadzone values

To minimize the total amount of space needed for the complete calibration, you can reposition the vehicle between each calibration process. If available flate, smooth space is extremely limited, re-align the vehicle after each calibration.

Note – If you encounter any error messages during calibration, refer to the [Automated Deadzone error messages](#) in this section.

Automated Deadzone error messages

Message: Error -	Explanation
Manual Override Detected	Manual override was detected before the calibration cycle could be completed. Retry the calibration.
No GPS	A GNSS receiver must be connected and outputting positions before the software can run the calibration procedure.
No Steering Response Detected	During the calibration cycle, there was not enough movement for the calibration to complete. If the problem persists, the hydraulic installation could be faulty.

Message: Error -	Explanation
Software Problem Detected	The software was unable to complete the calibration due to insufficient movement of the vehicle. If the problem persists, contact Technical Support.
Steering Close To End Stops	Before the calibration cycle could be completed, the measured steering angle approached the end stops. Retry, and if the problem persists, instead of centering the steering at the start of each cycle, try turning the steering in the opposite direction to that which is being tested so that the calibration procedure has a greater range to test over.
Unable To Determine DZ: Try Again	A problem occurred when trying to compute dead zone. Retry. If the problem persists, contact Technical Support.
Valve Connectors Could Be Swapped	The calibration test sensed the steering turning in the opposite direction to what was expected. Retry. If the problem persists, either the valve connectors have been accidentally swapped or the steering sensor calibration was performed incorrectly.
Vehicle Moving Too Slow	The vehicle was moving too slowly for the calibration cycle to successfully finish. Make sure the vehicle is moving at least 0.8 kph (0.5 mph) during each calibration cycle.

Proportional steering gain

Note – Adjust the steering gain only when the Autopilot system performance is less than satisfactory.

Proportional steering gain (PGain) balances rapid steering response and stability. PGain affects the following:

- Slew Time: The amount of time that the front wheels take to move from the far left to the far right position and back.
- Overshoot: The percentage by which the front wheels exceed the commanded angle before they settle on the correct value.

High Gain	Low Gain
Decreases the slew time and increase the overshoot. This provides rapid responses, but can cause the steering to exhibit signs of instability (for example, a tendency to excessively overshoot).	Increases the slew time and decrease the overshoot. This improves the stability but can introduce delays in the steering response and can cause the vehicle to oscillate from side to side.

Pre-calibration steps

1. Complete the vehicle setup steps.
2. Perform calibration for the Automated Deadzone. See [Automated steering deadzone calibration, 156](#). before you perform the calibration for steering gain.
3. Drive the vehicle to an open area with a smooth surface.





CAUTION – The wheels can move abruptly during the Steering Proportional Gain procedure while the Autopilot system tests the hydraulic response to its steering commands. To avoid injury, be prepared for vehicle movement.

Calibration steps

1. At the Vehicle setup panel, select the vehicle you want to work with. See [Select a vehicle, 145](#).
2. Tap **Calibrate**, then tap **Steering Proportional Gain**. The calibration tool displays.
3. Tap **Run Slew Test**. To proceed with the test, tap **Next**.
4. Drive forward at 1 mph (1.6 kph) or faster. Tap **Next**.
5. Turn the front wheels completely to the right and then tap **Turn Left**. Drive forward while the vehicle turns left, until the screen shows the test is complete.
6. Turn the front wheels completely to the left and then tap **Turn Right**. Drive forward while the vehicle turns right, until the screen shows the test is complete.

Note – With some vehicles, valve size and hydraulic capabilities of the machine will limit the slew time. In such cases, optimizing the P-gain value will be difficult..

7. Note the Slew Time and Overshoot values.
8. Adjust the gain value.
9. Repeat step 3 through step 8 until the Gain is just below the level where any one of the following occurs:
 - Slew times no longer decrease (a low value is required some vehicles too high gain is possible - 1500-2000 milliseconds is ideal).
 - Overshoot exceeds 5 – 8% (depending on the vehicle).
 - Wheels noticeably shake near end stops.
10. When you find the optimum gain, tap  to accept the calibration or  to exit without saving. The display returns to the CALIBRATION section where you can perform another calibration or exit.

Roll correction calibration

Roll correction compensates for minor variations in the placement of the navigation controller and GNSS antenna.

Note – If you use multiple GNSS technologies (for example, RTK and WAAS), then use the device with the highest accuracy when calibrating roll correction. For best results, use RTK, RTX or OmniSTAR HP with a signal that has been converged for at least 20 minutes. If you do a roll calibration with less accurate correction, repeat the steps below at least four times for greater accuracy.

Pre-calibration steps

1. Set up a vehicle and perform all calibrations preceding this one.
2. Read and understand the instructions provided below for the calibration procedure.
3. Remove any implement from the vehicle and drive it to a flat, smooth area where you can complete passes of at least 400 ft (125 m) in length.
4. Create a field. See [Add a field, 181](#).

Calibration steps

1. Select the vehicle and implement you want to work with.
(See [Select a vehicle, 145](#) and [Select an implement, 189](#) for detailed instructions.)
2. Select a field and enter the **Run** screen.
(See [Select a field, 182](#) and [Preparing for operation, 234](#).)
3. Create a new, straight guidance line.
(See [AB guidance line creation \(Run screen\), 251](#) or [A+ guidance line creation \(Run screen\), 252](#).)
4. Make sure the on-screen lightbar is displayed on the screen.
(See [On-screen widgets, 286](#).)
5. Engage automatic steering on the line. Drive until the on-screen lightbar number is as close to zero as possible, and then stop the vehicle.
6. Mark the vehicle's position:
 - a. Place the vehicle in park and exit the cab.
 - b. Place a flag in the ground that will mark the vehicle's center line. Use the drawbar pin hole or use another feature of the vehicle as a reference point.

On vehicles such as sprayers, swathers, or combines, determine a reference point in the center of the vehicle to mark (preferably near to the reference location for the antenna

such as front axle, rear axle, or center of track rotation).

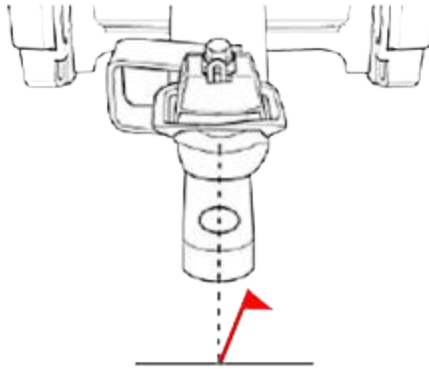

7. Re-enter the cab and continue to drive down the guidance line.
8. Turn the vehicle around and then re-engage **on the same line** in the opposite direction.
9. Stop the vehicle with the drawbar (or other feature used to mark the center line of the vehicle) as close to the first flag as possible.
10. Mark the vehicle's position.
 - a. Place the vehicle in park and exit the cab.
 - b. Place a second flag in the ground to mark the vehicle's center line.
 - c. Measure the distance between flag 1 and flag 2 and note it.

Distance between flag 1 and flag 2 (step c):

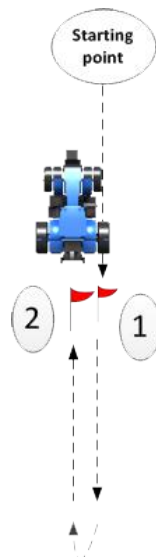

d. Also note where the vehicle's current position is in relation to flag 1 (in other words, the vehicle is either to the right or left of flag 1). The diagram, this example shows the vehicle is to the left of flag 1.

Vehicle is to right or left of flag 2 (step d):

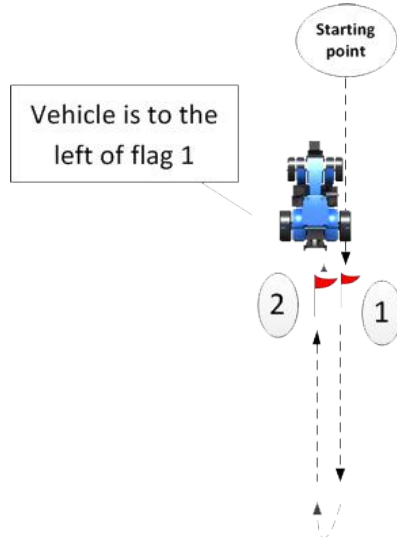

e. Return to the cab and in the **Run** screen note the cross-track error (the number on the on-screen lightbar).

Cross-track error (number on Run screen) (step e):



f. Note the direction highlighted on the lightbar (left or right).

Direction highlighted on lightbar (left or right) (step f):

11. Tap  and then tap **Diagnostics**.
12. Tap Autopilot performance and tap the Advanced tab.
13. At the Roll Offset entry box and Vehicle Position selection box:
 - Calculate the roll offset and enter it in the display.
Refer to your notes and compare them to the following table to determine how to calculate roll offset.
 - Determine the direction of the Vehicle Position and enter it on the display.
Refer to your notes and compare them with the following table to find which Vehicle Position to select.

Current vehicle position is to the _____ of flag 1	Lightbar highlight is on the:	Calculate Roll Offset value:	Lightbar (cross-track) value is _____ than flag distance value	Vehicle Position selection
Right	Right	Flag distance minus Cross-track value	Less	Right
Right	Right	Flag distance minus Cross-track value	Greater	Left
Left	Left	Flag distance minus Cross-track value	Less	Left
Left	Left	Flag distance minus Cross-track value	Greater	Right
Right	Left	Flag distance plus Cross-track value	N/A	Right
Left	Right	Flag distance plus Cross-track value	N/A	Left



14. Pull both flags out of the ground and continue driving down the line.
15. Turn the vehicle around again so that you are traveling in the same direction as you were when you originally set the line.
16. Repeat the steps starting at Step 4 until the two flags are under 1" (2.54 cm) apart.

Line acquisition

Line acquisition controls how fast the guidance system attempts to steer the vehicle onto the current guidance line (50% - 150%).

- With a high setting, the vehicle approaches the line quickly, but may overshoot the line and drive into instability.
- With a low setting, the vehicle steers onto the line more slowly, but is less likely to overshoot the line.



Note – Exceeding the capability of the tractor will cause instability (such as oscillating back and forth up and down the line) during line acquisition.

1. Go to Diagnostics:
 - a. Tap the right side of the display bar. The notification list displays.
 - b. Tap , then tap .

- c. Under the Autopilot heading in the left-hand list, tap **Performance**.
 - d. Tap **Steering** at the top of the screen.
 - e. The display shows the tool for calibrating line approach aggressiveness and the cross-track error diagram.
2. Enter the **Run** screen and engage automatic steering on a straight guidance line.
 - a. At the Vehicle setup panel, select the vehicle and implement you want to work with. (See [Select a vehicle, 145](#) and [Select an implement, 189](#) for detailed instructions.)
 - b. Select a field and enter the **Run** screen. (See [Select a field, 182](#) and [Preparing for operation, 234.](#))
 - c. Create a new, straight guidance line. (See [AB guidance line creation \(Run screen\), 251](#) or [A+ guidance line creation \(Run screen\), 252.](#))
 3. Drive until the lightbar shows that the cross-track error value is as close to zero as possible, and then stop the vehicle.
 4. Open the Diagnostics section for Autopilot performance again.
 5. Evaluate the current accuracy of the vehicle during line acquisition with the default setting.
 6. Touch and move the button with the percentage to move the slider to the left or right. Drive forward and re-engage auto-steering if necessary to test the setting.

Engage aggressiveness

Engage aggressiveness controls how aggressively the vehicle initially turns towards the guidance line.

- With a high setting, the vehicle will initially respond quickly.
 - With low setting, the vehicle will respond more smoothly when initially engaged.
1. Enter the **Run** screen and engage automatic steering on a straight guidance line. (See [Preparing for operation, 234](#) for more instructions on entering the **Run** screen.)
 2. Drive the vehicle approximately 10 seconds.
 3. Open the Diagnostics section for the Autopilot system's performance.
 - a. Tap the right side of the display bar. The notification list displays.
 - b. Tap , then tap .
 - c. Tap **Steering** at the top of the screen.
 4. Evaluate the current accuracy of the vehicle during line acquisition with the default setting .
 5. Touch and move the button with the percentage to move the slider to the left or right. Drive forward and re-engage auto-steering if necessary to test the setting.

EZ-Pilot system setup

The EZ-Pilot system turns the steering wheel for you with an electric motor drive. It uses GNSS guidance from the XCN-2050 display.

Initial setup steps are:

- [Guidance selection for the EZ-Pilot system, 167](#)
- [Controller settings for EZ-Pilot system, 167](#)
- [Vehicle measurements for EZ-Pilot system, 169](#)
- [Steering speed settings for EZ-Pilot system, 168](#)

Guidance selection for the EZ-Pilot system

 **WARNING** – Auto guidance systems cannot avoid items in the field such as obstacles. Make sure you are adequately trained to operate the auto guidance system.

1. Navigate to the **GUIDANCE** section of the vehicle setup panel:
 - a. At the **Home** screen, tap . The Vehicle setup panel displays.
 - b. At the list on the left-hand side of the setup panel, tap the name of the vehicle you want to edit. The display changes the list item to a blue background with white text.
 - c. Tap **Edit**, then **GUIDANCE**.
2. At the SELECTION section, tap EZ-Pilot.

 **WARNING** – Many large and sudden changes in satellite geometry caused by blocked satellites can cause significant position shifts. If operating under these conditions, auto-guidance systems can react abruptly. To avoid possible personal injury or damage to property under these conditions, disable the auto-guidance system and take manual control of the vehicle until conditions have cleared.

3. Tap **Next** to set up the controller orientation. See [Controller settings for EZ-Pilot system, 167](#).

Controller settings for EZ-Pilot system

The EZ-Pilot system uses the IMD-600 to provide roll compensation when the vehicle is on a slope or drives over a bump. For roll compensation to work correctly, the IMD-600 must be calibrated. IMD stands for Inertial Measurement Device.

To set up the IMD-600 controller, you must indicate the position/orientation of the controller as it is currently installed in the vehicle.

For example, if the controller is positioned with the input jacks of the controller facing to the left side of your vehicle, you indicate this in the XCN-2050 display.

The CONTROLLER SETTINGS section of the vehicle setup panel shows an image of the controller as though you are looking down on the vehicle from above, with the front of the vehicle at the top of the screen.

1. Navigate to the **GUIDANCE** section of the vehicle setup panel:
 - a. At the **Home** screen, tap . The Vehicle setup panel displays.
 - b. Tap **Edit**.
 - c. At the list on the left-hand side of the setup panel, tap the name of the vehicle you want to edit. The display changes the list item to a blue background with white text.
 - d. Tap **Edit**, then **GUIDANCE**.
2. Tap **CONTROLLER SETTINGS**.
3. Rotate the on-screen IMD-600 to match the position of the actual IMD-600 in the vehicle as you are looking down from the top, with the nose of the tractor point to the top of the screen. Tap the arrow buttons to move the on-screen IMD-600 clockwise or counterclockwise.



Steering speed settings for EZ-Pilot system

Note – Adjust settings only if necessary to improve steering performance.

1. Navigate to the GUIDANCE section of the vehicle setup panel:
 - a. At the **Home** screen, tap . The Vehicle setup panel displays.
 - b. At the list on the left-hand side of the setup panel, tap the name of the vehicle you want to edit. The display changes the list item to a blue background with white text.
 - c. Tap **Edit**, then **GUIDANCE**.
2. Tap **SETTINGS**. Complete the information at the SETTINGS section.

Setting	Explanation
Angle per Turn	<p>The angle that the wheels turn during one full rotation of the steering wheel (1 - 150 degrees):</p> <ul style="list-style-type: none"> • Too high - the system turns the wheel too little and the vehicle will not hold the line • Too low - results in small, fast oscillations in steering <p>Note – Angle per Turn should be determined by running the automated calibration. The value can then be adjusted here.</p>
Freeplay Left	The amount of free movement in the steering when starting a left turn (0 - 11.9 inches (0 - 30 cm))
Freeplay Right	The amount of free movement in the steering when starting a right turn (0 - 11.9 inches (0 - 30 cm))
Steering Delay	<p>The amount of time between steering wheel movement and vehicle yaw rate change (0.1 - 2 seconds).</p> <p>Note – This setting should only be used for swathers and sprayers.</p>
Motor Speed	<p>The speed at which the motor will operate: Auto, Auto High, Auto Low, Auto Maximum, Auto Medium, High, Low, Maximum, Medium</p> <p>Note – Default selection varies depending on vehicle type.</p>
Motor Direction	Reverse mount, standard mount
External Switch	Select a switching option if an external switch is connected to the system: Disabled (Default), Remote Engage, Seat Disengage, Seat Engage Only
Engage Options	Maximum Speed, Minimum Speed, Maximum Angle, Engage Offline, Disengage Offline Override Sensors
Advanced	<p>Note – Do not adjust the Advanced Settings. Advance Settings are provided for support and advanced troubleshooting only.</p> <p>Settings include: Roll Offset Angle, Estimated Steering Angle Bias, Dynamic Approach Angle, Steering Acceleration Limit, Steering Slew Limit</p>

Vehicle measurements for EZ-Pilot system

At MEASUREMENTS, the measurements that apply to the vehicle type you selected are shown in this section. In addition to measurements of the vehicle itself, measurements related to the antenna location are important for accuracy.



To edit measurements, tap each measurement button and enter the appropriate number.

Before you take measurements:

- Park the vehicle on level ground.
- Make sure the vehicle is straight, with the center line of the body parallel to the wheels.

EZ-Pilot system calibrations

Calibrations for the EZ-Pilot guidance system are:



- [Angle per turn calibration for EZ-Pilot system, 171](#)
- [Roll correction for EZ-Pilot system, 170](#)
- [Online aggressiveness calibration for EZ-Pilot system, 171](#)
- [Line acquisition calibration for EZ-Pilot system, 172](#)

For information on: See:

Diagnostics [EZ-Pilot system diagnostics, 303](#)

Roll correction for EZ-Pilot system

1. Park the vehicle and mark the center lines of both the front and rear wheelbases on the ground.
2. Navigate to the GUIDANCE section of the vehicle setup panel:
 - a. At the **Home** screen, tap . The Vehicle setup panel displays.
 - b. At the list on the left-hand side of the setup panel, tap the name of the vehicle you want to calibrate. The display changes the list item to a blue background with white text.
3. Tap **Calibrate**.
4. Tap **Roll Calibration**. The calibration tool displays.
5. Follow the instructions on the calibration tool.

6. To accept the calibration, tap .
7. To discard the calibration and start it again, tap .



Angle per turn calibration for EZ-Pilot system

Note – Complete the roll correction calibration before performing this calibration.

1. Navigate to the GUIDANCE section of the vehicle setup panel:
 - a. At the **Home** screen, tap . The Vehicle setup panel displays.
 - b. At the list on the left-hand side of the setup panel, tap the name of the vehicle you want to calibrate. The display changes the list item to a blue background with white text.
2. Tap **Calibrate**.
3. Tap **Angle Per Turn**. The calibration tool displays.
4. Follow the steps on the calibration tool.

Online aggressiveness calibration for EZ-Pilot system

Online aggressiveness controls how aggressively the vehicle reacts to cross track error while operating on the guidance line (50% - 150%).



- With a high setting, the vehicle will be more reactive to cross track error. A high setting may cause the system to overreact and become unstable.
 - With low setting, the vehicle will make less of a steering correction to the online cross track error.
1. Enter the **Run** screen and engage automatic steering on a straight guidance line. (See [Enter a field \(Run screen\), 183](#) for more instructions on entering the **Run** screen.)
 2. Drive the vehicle approximately 10 seconds.
 3. Open the Diagnostics section for the EZ-Pilot system's performance.
 - a. Tap the right side of the display bar. The notification list displays.
 - b. Tap , then tap .
 - c. Tap **Steering** at the top of the screen.
 4. Evaluate the current accuracy of the vehicle during online operation with the default setting.
 5. Touch and move the button with the percentage to move the slider to the left or right. Drive forward and re-engage auto-steering if necessary to test the setting.

Line acquisition calibration for EZ-Pilot system

Line acquisition controls how fast the guidance system attempts to steer the vehicle onto the current guidance line (50% - 150%).

- With a high setting, the vehicle approaches the line quickly, but may overshoot the line and drive itself to instability.
- With a low setting, the vehicle steers onto the line more slowly, but is less likely to overshoot the line.

Note – Exceeding the capability of the tractor will cause instability (such as oscillating back and forth up and down the line) during line acquisition.

1. Go to Diagnostics:
 - a. Tap the right side of the display bar. The notification list displays.
 - b. Tap , then tap .
 - c. Under the EZ-Pilot heading in the left-hand list, tap **Performance**.
 - d. Tap **Steering** at the top of the screen.
 - e. The display shows the adjustments for calibrating line approach aggressiveness and the cross-track error diagram.
2. Enter the **Run** screen and engage automatic steering on a straight guidance line.
 - a. At the Vehicle setup panel, select the vehicle and implement you want to work with. (See [Select a vehicle, 145](#) and [Select an implement, 189](#) for detailed instructions.)
 - b. Select a field and enter the **Run** screen. (See [Select a vehicle, 145](#) and [Preparing for operation, 234](#).)
 - c. Create a new, straight guidance line. (See [AB guidance line creation \(Run screen\), 251](#) or [A+ guidance line creation \(Run screen\), 252](#).)
3. Drive until the lightbar shows that the cross-track error value is as close to zero as possible, and then stop the vehicle.
4. Open the Diagnostics section for EZ-Pilot performance again.
5. Evaluate the current accuracy of the vehicle during line acquisition with the default setting.
6. Touch and move the button with the percentage to move the slider to the left or right. Drive forward and re-engage auto-steering if necessary to test the setting.

EZ-Steer system setup

The EZ-Steer system turns the steering wheel for you by combining a friction wheel and a motor with guidance from the XCN-2050 display.

Initial setup steps are:

- [Guidance selection for EZ-Steer system, 173](#)
- [Controller settings for EZ-Steer system, 173](#)
- [Steering and speed settings for EZ-Steer system, 173](#)
- [Vehicle measurements for EZ-Steer system, 175](#)

Guidance selection for EZ-Steer system

 **WARNING** – Auto guidance systems cannot avoid items in the field such as obstacles. Make sure you are adequately trained to operate the auto guidance system.

1. Navigate to the **GUIDANCE** section of the vehicle setup panel:
 - a. At the **Home** screen, tap . The Vehicle setup panel displays.
 - b. At the list on the left-hand side of the setup panel, tap the name of the vehicle you want to edit. The display changes the list item to a blue background with white text.
 - c. Tap **Edit**, then **GUIDANCE**.
2. At the SELECTIONS section, tap **Selection** and then tap EZ-Steering.

 **WARNING** – Many large and sudden changes in satellite geometry caused by blocked satellites can cause significant position shifts. If operating under these conditions, auto-guidance systems can react abruptly. To avoid possible personal injury or damage to property under these conditions, disable the auto-guidance system and take manual control of the vehicle until conditions have cleared.

3. Tap **Next** to set up the controller orientation. See [Controller settings for EZ-Steer system, 173](#).

Controller settings for EZ-Steer system

Setting	Explanation
Connector Faces	Indicate how the connector on the navigation controller faces: Back, Floor, Front

Steering and speed settings for EZ-Steer system

Note – *Adjust settings only if necessary to improve steering performance.*

1. Navigate to the GUIDANCE section of the vehicle setup panel:

- a. At the **Home** screen, tap . The Vehicle setup panel displays.
- b. At the list on the left-hand side of the setup panel, tap the name of the vehicle you want to edit. The display changes the list item to a blue background with white text
- c. Tap **Edit**, then **GUIDANCE**.

2. Tap **SETTINGS**. Complete the information at the SETTINGS section.

Steering Sensor Setting	Description
Angle per Turn	<p>The angle that the wheels turn during one full rotation of the steering wheel (1 - 150 degrees):</p> <ul style="list-style-type: none"> • Too high - the system turns the wheel too little and the vehicle will not hold the line • Too low - results in small, fast oscillations in steering <p>Angle per turn values should be calibrated first using EZ-Steer calibration and then adjusted here if necessary.</p>
Freeplay Left	The amount of free movement in the steering when starting a left turn (0 - 11.9 inches (0 - 30 cm))
Freeplay Right	The amount of free movement in the steering when starting a right turn (0 - 11.9 inches (0 - 30 cm))
Steering Delay <i>Note – Only available if vehicle is sprayer or swather.</i>	<p>The amount of time between steering wheel movement and vehicle yaw rate change (0.1-1.5 seconds)</p> <p>Note – This value should only be used for swathers and sprayers.</p>
Motor Speed	<p>The speed at which the motor will operate:</p> <ul style="list-style-type: none"> • <i>Auto, Auto Low, Auto Medium, Auto High, or Auto Maximum</i> • <i>Manual Low, Manual Medium (Default), Manual High, or Manual Maximum</i> <p>Note – Auto mode determines the proper speed for the steering action required.</p>

Steering Sensor Setting	Description
Motor Direction	The direction the EZ-Steer system motor is installed: <ul style="list-style-type: none"> • <i>Standard Mount</i> • <i>Reversed Mount</i>
External Switch	Select a switching option if an external switch is connected to the system: <ul style="list-style-type: none"> • <i>Disabled (Default)</i> • <i>Seat Disengage</i> • <i>Seat Engage Only</i> • <i>Remote Engage</i>
Advanced	<p><i>Advanced settings include:</i></p> <ul style="list-style-type: none"> • Roll OffsetAngle • Estimated Steering Angle Bias • Dynamic Approach Angle • Steering acceleration limit • Steering slew limit <p>Note – Do not adjust the <i>Advanced Settings</i>. Advance Settings are provided for support and advanced troubleshooting only.</p>

Vehicle measurements for EZ-Steer system

At MEASUREMENTS, you can enter and access the measurements that apply to the vehicle type you selected. In addition to measurements of the vehicle itself, measurements related to the antenna location are important for accuracy.



To enter measurements, tap each measurement button and enter the appropriate number.

Before you take measurements:

- Park the vehicle on level ground.
- Make sure the vehicle is straight, with the center line of the body parallel to the wheels.

For the Antenna Height, measure the distance from the ground to the base of the GPS receiver (or antenna).

EZ-Steer system calibrations



Calibrations for the EZ-Steer auto guidance system include:

- [Angle per turn calibration for EZ-Steer system, 176](#)
- [Roll correction for EZ-Steer system, 176](#)

For information on: See:

Diagnostics [EZ-Steer system diagnostics, 307](#)

Roll correction for EZ-Steer system

1. Park the vehicle and mark the center lines of both the front and rear wheelbases on the ground.
2. Navigate to the GUIDANCE section of the vehicle setup panel:
 - a. At the **Home** screen, tap . The Vehicle setup panel displays.
 - b. At the list on the left-hand side of the setup panel, tap the name of the vehicle you want to calibrate. The display changes the list item to a blue background with white text.
3. Tap **Calibrate**.
4. Tap **Roll Calibration**. The calibration tool displays.
5. Follow the instructions on the calibration tool.
6. To accept the calibration, tap .
7. To discard the calibration and start it again, tap .

Angle per turn calibration for EZ-Steer system

Perform the Roll calibration before performing the angle per turn calibration.

1. Navigate to the GUIDANCE section of the vehicle setup panel:
 - a. At the **Home** screen, tap . The Vehicle setup panel displays.
 - b. At the list on the left-hand side of the setup panel, tap the name of the vehicle you want to calibrate. The display changes the list item to a blue background with white text.
2. Tap **Calibrate**.

3. Tap **Angle Per Turn**. The calibration wizard displays.
4. Begin the steps on the calibration procedure by driving the vehicle between 2 and 4 mph.

Fields

In this chapter:

Field Basics	180
Add a field	181
Select a field	182
Enter a field (Run screen)	183
Edit a field (Field Manager)	184

You can create multiple fields and then select one to enter. Using the Field Manager, you can also edit and delete fields.

Field Basics

A field is an item you create in the **Run** screen that represents an area of land. A field can contain one or more boundaries (perimeters) (or no boundaries). Information associated with each field includes:

- Boundaries, guidance lines and patterns for steering assistance
- Landmarks such as points, lines and area features
- Tasks
- Coverage information recorded during field activities when logging is activated
- Attributes such as Clients and Farms

To edit and refine boundaries, guidance lines and patterns, and landmarks, open the Field Manager (see [Field Manager, 61](#)).

Boundaries

The perimeter around your field is a boundary. A boundary line begins when you tap a button to record the start of your boundary. After driving the length of the boundary, you tap a button to stop recording the path of the boundary. For more information, see [Boundary creation \(Run screen\), 248](#) and [Boundary editing \(Field Manager\), 249](#).

Guidance lines and patterns

With a steering assistance feature, your vehicle can be set to drive on guidance lines and patterns. This improves the accuracy of planting, applications and harvesting. The types of lines are:

- **AB line:** A straight line that begins at point A. After driving the direction of the line path, you end the line at point B. See [AB guidance line creation \(Run screen\), 251](#).
- **A+ line:** A straight line that you begin with point A and choose the direction you want the line to draw.
- **Curve:** A curved line begins when you tap a button to start recording the line path and then drive in a curved direction. The line ends when you tap a button to stop recording the line path. See [Curved line creation \(Run screen\), 252](#).

The types of patterns are:

- **Headlands:** An area you can create by recording your beginning point and stopping the recording when you are finished. You have the option to create an infill pattern of straight or curved lines. See [Headland and infill pattern creation \(Run screen\), 253](#).
- **Pivots:** A circular area you create by recording your beginning point and stopping recording when you are finished. See [Pivot pattern creation \(Run screen\), 258](#).

Landmarks

You create landmarks to indicate productive and non-productive areas, as well as items that you want the display to warn the driver about. Landmarks can be:

- Lines
- Points
- Areas

For more information, see

- [Landmark line creation \(Run screen\), 264](#)
- [Landmark point creation \(Run screen\), 264](#)
- [Landmark area creation \(Run screen\), 265](#)
- [Landmark editing \(Field Manager\), 265](#)

Tasks, activities and coverage

A task is a set of information that includes:



- One or more activities being completed in a field (such as planting, spraying, and so on)
- A map layer showing the activity's coverage on the field

The XCN-2050 display stores field activities related to each unique operation and field combination together as a task. By using tasks, you do not have to continually configure fields that you frequently use.

For more information, see:

- [Tasks, 238](#)
- [Coverage logging, 241](#)

Add a field

1. At the **Home** screen, tap  .
2. Enter a name for the field and then tap  .
The system saves the field name and its location.

To work with the field, see [Preparing for operation, 234](#).

Select a field

To work with a field to work within it, you select it. When you add a field, it is selected automatically.

If you have multiple fields, you can select a field from:



- The point on the map at the **Home** screen.
- The list of fields.

Select a field through the map

The points on the map () of the **Home** screen indicate fields you have created. Tap the point that represents the field.

Select a field from the list

The outlines on the map of the **Home** screen indicate fields you have created.

1. At the **Home** screen, tap . A list of fields you previously created displays.
2. To reduce the number of fields in the list, tap . A filter tool displays, showing the client name and the farms associated with the client.



3. Deselect (uncheck) the options you do not want to see and tap **Accept**. The Fields list now shows fields associated with the client and/or farm that you left checked.
4. Tap the name of the field to select it.



Note – A field that has a check mark but is **NOT** highlighted is a previously selected field.

Enter a field (*Run* screen)



Before you can enter a field in the **Run** screen, you must:

- Set up a positioning service that is working. See [GNSS receiver settings, 116](#).
- Set up a vehicle. See [Vehicle setup, 140](#).
- [Select a vehicle, 145](#)
- [Implement setup, 188](#).
- [Select an implement, 189](#).
- [Add a field, 181](#).
- [Select a field, 182](#).

Choose a field to enter

You can enter a field you currently have selected or one that is not currently selected.

Currently selected field

To enter a field that is currently selected, tap   . The **Run** screen displays.

Field not currently selected

To enter a field not currently selected:

1. At the **Home** screen, the map shows points (📍) where your fields are located. Tap the 📍 that represents the field you want to enter. (For a map to display on the **Home** screen, you must have a updated GNSS connection.)
2. A popup displays with the field name and two buttons.



3. To enter the field without beginning a new task, tap **Enter Field**.
4. To start a new task, tap **Start New Task and Enter Field**. The **Run** screen displays.

Run screen

The text and buttons displayed on your **Run** screen depend on:

- Whether you are using a guidance / steering system or manual guidance
- Other features you are using
- How your XCN-2050 display is set up

Edit a field (Field Manager)

1. Tap  to open the Field Manager. Field Manager opens to the Field Overview section.

The map in the Field Manager shows the selected field with details, including:

- Current vehicle position
- Active pattern
- Active boundary
- Inactive boundaries

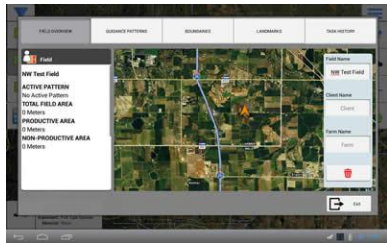

Field Item	Explanation
Field Name	You can optionally change the field name. Tap in the text box.
Client Name (optional)	The client is the customer for whom the work is being done. Client name is blank unless you import it or manually enter it here.
Farm Name (optional)	The farm is a collection of fields. Farm name is blank unless you import it or manually enter it here.
	Removes the field and all related data from the XCN-2050 display.
ACTIVE PATTERN	The currently active pattern, and what implement type and width were used to create the pattern. To make a different pattern active, tap GUIDANCE PATTERNS .
TOTAL FIELD AREA	The calculated area of the selected field.
PRODUCTIVE AREA	Total field area minus the non-productive area.
NON-PRODUCTIVE AREA	The calculated area of the Non-productive area landmark features in the selected field.

- To edit the field name, tap in the Field Name text box and edit the name.
Note – To ensure your changes are saved, tap the Done key on the on-screen keyboard.
- To associate the field to a client, tap the Client name text box and enter a name.
Note – To ensure your changes are saved, tap the Done key on the on-screen keyboard.
- To associate the field to a farm, tap the Farm Name text box and enter the name of the farm.
Note – To ensure your changes are saved, tap the Done key on the on-screen keyboard.
- To edit guidance patterns, boundaries, survey items, or landmarks, tap the buttons at the top of the Field Manager. See the following sections for details.

- [Guidance pattern shifting \(Field Manager\), 261](#)
- [Boundary editing \(Field Manager\), 249](#)
- [Landmark editing \(Field Manager\), 265](#)

6. Tap  to save the changes and close the Field Manager.

Implements

In this chapter:

Implement setup	188
ISOBUS for implements	191
Application control	196
Boom height control	210
Inputs	219
Review implement summary	222
Prescriptions	223

Implements can be added, edited and deleted at the Implement setup panel. You can also calibrate boom height and section and rate control.

Implement setup

Use the Implement setup panel to select, add, edit, calibrate or delete an implement. Implements can be pull-type equipment or attachments for self-propelled equipment.

Before you set up an implement, create a vehicle. See [Add a vehicle, 140](#).

Add an implement

1. At the **Home** screen, tap . The Implement setup panel displays.



Tap **ADD IMPLEMENT**.

2. At the OPERATION section, tap the type of operation that you will use the implement to perform.
3. At the IMPLEMENT / Type section, tap the type of implement you will be using. Then tap **Next** to continue.
4. At the NAME section, the system has pre-named the implement by giving it the name of the type. You have the option to enter a different name if you want to change it.
5. Tap **Next** to continue to the MEASUREMENTS section. See for further instructions.

Save an implement

You can save complete or incomplete implements.

Save complete implement settings

1. Complete all of the implement setup and calibration steps for your operation, based on the implement type and features/plugins you have unlocked on the device.
2. When you complete the implement setup, your last step is the SUMMARY section.
3. Tap  to save the implement and return to the **Home** screen.

Save incomplete implement settings

The display allows you to save an incomplete implement and return to it later to complete.



Note – You cannot enter the run screen without a completed implement that you have selected.

1. Select an operation type, make, model and name the implement. (See [Implement setup, 188.](#))
2. At any point after you complete the NAME section, tap **SUMMARY**, then tap .

Select an implement

Note – You can only enter the Run screen with an implement when the required implement setup and calibration steps are complete. When you change implements, make sure that all related configurations are accurate for the current operation.

To select an implement that is already set up:

1. Tap  at the **Home** screen.
2. To select an implement in the list, tap the implement.
3. Tap **Select**. The name of the implement highlights in blue and a  displays next to the name.

Note – Without a blue highlight, the  indicates an implement that was selected previously.

Edit an implement

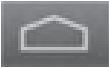

1. Tap  on the **Home** screen. The Implement setup panel displays.
2. In the list of implements, tap the implement that you want to edit.
3. Tap **Edit**.
4. Tap the section where you want to make edits.
5. When you are finished, tap **Summary** at the top right corner of the screen. For details, see [Review implement summary, 222.](#)

If any part of the setup is *Not Complete*, you can save the changes but you cannot use the implement on the **Run** screen.

6. To save your changes to the implement, tap . The **Home** screen displays.
7. To discard your edits and not change the existing profile, tap . The display returns you to the Implement setup panel.

Delete an implement

You can delete an implement. However, when you do so, all settings associated with that implement will also be deleted.

1. Tap  on the **Home** screen.
2. Tap the implement you want to delete.
3. Tap **Delete**. A confirmation message displays for you to confirm you want to remove the implement.
4. Tap  to delete the implement.

ISOBUS for implements

ISOBUS is a set of software and hardware standards that makes possible the communication between equipment made by different manufacturers.

With ISOBUS, you can use the XCN-2050 display to control an ISO-certified implement without an additional display. An ISO-certified implement has small computers called electronic control units (ECUs) which send signals to the XCN-2050 display. An ISO-certified tractor has a tractor ECU (TECU) installed on it. ECUs on implements enable you to control the operation:

- With the XCN-2050 display, using Task Controller (an optional feature)
- With Virtual Terminal, an on-screen window that opens on the XCN-2050 display to access directly the functions provided by the ECUs

Task Controller setup

To set up the implement and XCN-2050 display for Task Controller:

1. Connect the display to the ISO-certified implement with ISO cabling. See the *Getting Started Guide for ISOBUS on the XCN-2050 display*.
2. Set up the GNSS receiver to send messages to the implement. See [CAN message settings, 130](#).
3. Unlock Task Controller. See [Feature unlocks, 81](#).
4. Turn on the Task Controller feature. See [ISOBUS settings, 87](#).
5. Set up the implement for Task Controller. See [Implement setup for Task Controller, 191](#).

For information on:	See:
Using Task Controller	Task Controller operation, 282
Using Virtual Terminal	Virtual Terminal operation, 284



Implement setup for Task Controller

Note – Before you set up Task Controller, you must unlock the feature (see [Feature unlocks, 81](#)) and have turned Task Controller on in the display settings (see [ISOBUS settings, 87](#)).

1. At the **Home** screen, tap . The Implement setup panel displays.



Tap **ADD IMPLEMENT**.

2. At the OPERATION section, tap the type of operation you will be performing with the implement.
3. At the IMPLEMENT / Type section, tap the type of implement you will be using. Then tap **Next** to continue.
4. At the NAME section, tap **ISO Implement Data**. A list of ECUs that are connected to the XCN-2050 display displays. Optionally, choose the ECU of the implement you will be using.
5. In the Name entry box, the system has pre-named the implement by giving it the name of the type. You have the option to enter a different name if you want to change it.
6. Tap **Next** to continue to the MEASUREMENTS section.
7. At the MEASUREMENTS section:
 - a. If the implement is connected during setup, the system completes the measurements by getting this information from the ECU you chose in step 4. Verify this information and make any necessary corrections.
 - b. If the implement is not connected during setup, enter the measurements manually. See .
8. Tap  to turn on the application control feature for the channel.
9. Tap  **Add**.
10. Tap **Next**.
11. The display takes you to a set of screens to set up the channel, beginning with the TYPE section. Complete the settings at the TYPE screen and tap **Next**.

Tap...	To...
Material Type	Select the material you will be applying: <ul style="list-style-type: none"> • Anhydrous • Granular Fertilizer • Granular Seed • Liquid • Row Crop Seed
ISO Implement Data	Select the ECU of the implement you are using to assign this ECU to this channel. Note – <i>This is required before you can use this channel.</i>

12. At the SETTINGS screen, tap  to turn on:
- Rate Control to use rate control. There is no need to complete any other settings because the ECU provides this information.
 - Rate Snapping to use rate snapping. This setting smooths out rate fluctuations seen on the screen.

Setting	Explanation
Off	The display shows instant readings from the feedback sensor. This may show frequent minor rate fluctuations.
On	The display smooths out the values. You will see the target rate as the applied rate whenever the applied rate is within 10% of the target rate.

- Section Control if you want to use section control.
13. If you chose to use section control:
- While still at the SETTINGS screen, tap **Number of Sections**. The ECU sends this information to the system. Verify the number of sections and tap **Next**.
 - At the WIDTH screen the system shows the number of sections you indicated in the previous screen and the width of each section. This information is obtained from the ECU.
 - Tap **Next** to continue to LATENCIES.
 - At LATENCIES, enter the applicable settings for section control and tap **Next**.
Latency refers to the delay between when the command occurs (to turn a section on or

off) and when application of the material actually starts or stops.

Tap...	To...
On Latency	Enter the length of time (seconds) from when a section is turned on to when the system begins to apply material.
Off Latency	Enter the length of time (seconds) from when a section is turned off to when the system stops applying material.
Apply Latency to Boundary	<p>Turn setting on or off by tapping. This setting applies to fields that have a boundary, and when you exit an exclusion zone and return to the workable area of the field.</p> <p>On: The system uses on latency to begin applying material immediately when crossing a boundary.</p> <p>Off: The system starts when the boundary is reached and any mechanical delay could leave a gap between the boundary and where the product is applied. When GPS accuracy is low, this is the preferred selection.</p>
Sections Off when Stopped	<p>Turn setting on or off:</p> <p>On: The sections shut down when the vehicle is stopped.</p> <p>Off: The sections remain open (turned on) when the vehicle is stopped.</p>

- e. At OVERLAPS enter the appropriate settings for section control and tap **Next**.

Tap...	To...
Start Overlap	<p>Enter the amount of overlap (distance) you want when starting coverage.</p> <p>When you are in a previously covered area driving toward a non-covered area, the system will begin turning sections on at this distance before reaching the non-covered area.</p>
End Overlap	<p>Enter the amount of overlap (distance) you want when stopping coverage.</p> <p>When you are applying material and driving toward a previously covered area, the system will keep sections on until they are this far into the previously covered area.</p>



Tap...	To...
Coverage Switching Overlap	Enter the percentage of a section's width that must be in a previously covered area before the system switches the section off. The higher the number, the greater the overlapped area before the section is turned off.
Boundary Switching Overlap	Enter the percentage of a section's width that must be past a boundary before the system switches the section off. The higher the number, the greater the overlapped area before the section is turned off.

14. At the SUMMARY screen, review the settings and tap  to save the settings for this channel.
15. For each additional channel, complete steps 9 through 14.
16. Complete the implement setup and save the Implement Summary. For instructions on Boom Height, Inputs and Summary, see:
 - [Boom height control, 210](#)
 - [Inputs, 219](#)
 - [Review implement summary, 222](#)
17. If you have not already done so, complete the setup for sending GNSS signals to the implement (see [CAN message settings, 130](#)).
18. Set up the ISO-certified equipment to use Task Controller. See [Equipment setup, 195](#).

To operate the Task Controller, see [Task Controller operation, 282](#).

Equipment setup

As part of getting the implement ready to be controlled by Task Controller, you use Virtual Terminal to set the configuration for the implement.

1. Make sure the ISO-certified implement is connected and Virtual Terminal is turned on in Settings (see [ISOBUS settings, 87](#)).
2. At any screen access the main menu by tapping . The main menu displays.
3. Tap . The Virtual Terminal displays.
4. Follow the instructions for the equipment you are using to set the implement for using Task Controller. See the *ISOBUS Getting Started Guide for the XCN-2050 Display*.

Application control

Note – For the correct connection of equipment, refer to the *Connecting the Field-IQ system's Crop Input Control Systems* chapter in the *XCN-2050 Display Cabling Guide*.

Application Control includes settings for rate and section control. When the Field-IQ feature is installed, the XCN-2050 display can control spraying.

Prior to setup

Before you can set up Field-IQ Rate and/or Section Control, you must complete the following:

- Install Field-IQ Rate and/or Section Control.
- Add, configure and calibrate a vehicle. See [Add a vehicle, 140](#).
- Set up an implement. See [Implement setup, 188](#).

Channel setup

To set up application control for the Field-IQ system, complete the following steps:

1. Turn on application control and [Add a control channel, 197](#).
2. For each control channel, complete the following settings as they apply to your equipment:
 - [Section control, 198](#)
 - [Rate control, 202](#)
 - [Adjustments, 207](#)
3. Review the channel configuration, see [Summary, 207](#).
4. To calibrate drives for Rate and Section Control, see [Calibrate application control drives, 205](#).

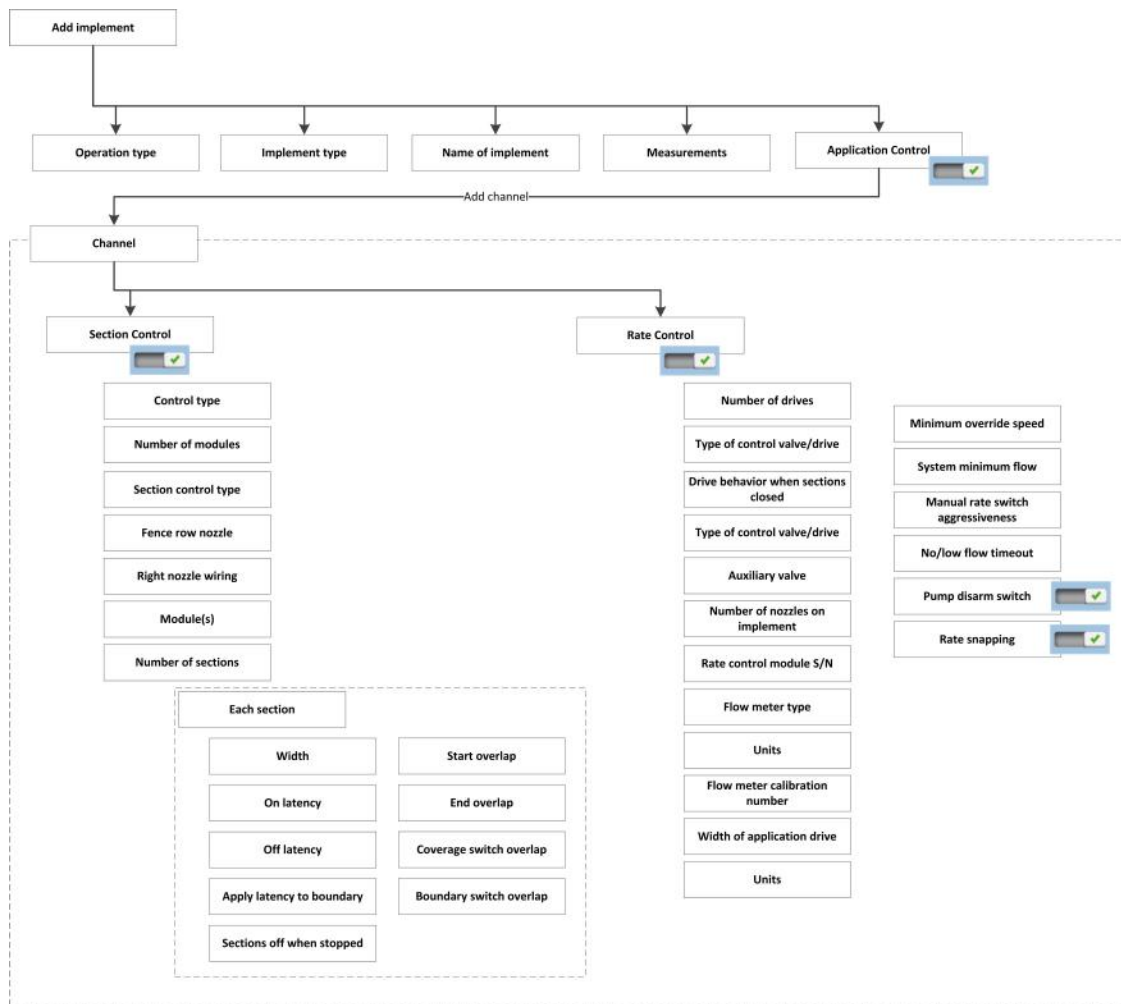

Setup diagram

The following diagram shows the setup sequence for a sprayer with Rate and Section Control.



Add a control channel

To add an application control channel (such as Field-IQ):

1. Tap  on the **Home** screen. The Implement setup panel displays.
2. Tap the implement you want to work with.
3. Tap **APPLICATION CONTROL**.
4. At APPLICATION CONTROL, turn the feature on by tapping .
5. Tap .
6. Tap **Next**.
7. The display takes you to a set of screens to set up the channel, beginning with the TYPE section.

Tap...	To...
Material Controlled By	View the current option (control the material using a switch box).
Boom to Application Point or Toolbar to Application Point	<p>Enter this measurement only if the application point for this channel is not the same as the application point that you used for .</p> <ul style="list-style-type: none"> • Measure from the application point used in the Implement Measurements section to the point where this material is applied. • If the new application point is further back, enter a positive value. If it is toward the front, enter a negative value.
Channel Name	The system names the channel. You can optionally change the name of the channel.

8. Tap **Next** to continue. The display goes to one of the following, depending on your configuration:
 - a. [Section control, 198.](#)
 - b. [Rate control, 202.](#)

Section control

At the Settings section for section control setup:

1. Tap  next to Section Control to turn on this feature. This toggles section control on or off for the current channel.
2. Tap **Control Type**.

Tap...	To...
Field-IQ individual sections	Use Field-IQ Rate Control modules for Section Control. Continue to the next step (3).

3. If you use Field-IQ for section control, tap each setting and choose an option.

Tap...	Tap to...
Number of Modules	Enter the number of Section Control modules you have installed. The maximum number of Section Control modules is 4.
Section Control Type	<p>Select the type of section control hardware you have installed:</p> <ul style="list-style-type: none"> • Boom Valve : The section control module sends power to the section valve to turn on the clutch off. • Tru Count Liquid-Block Valve™ : The section control module sends power to the section valve to turn on the clutch on. • Tru Count Air Clutch®: The section control module sends power to the section valve to turn on the clutch on. • Tru Count Section Electric Clutch: The section control module sends power to the section valve to turn on the clutch off.
Fence Row Nozzle	<p>Identify the location of fence row nozzles on the implement, if any:</p> <ul style="list-style-type: none"> • None (Default) • Left Only • Right Only • Both <p>Note – <i>The display only controls the fence row if the sprayer configuration allows it. Refer to the Field-IQ installation guide for additional information.</i></p>
Right Nozzle Wiring	<p>Select the wiring option used during installation:</p> <ul style="list-style-type: none"> • If you are using an EZ-Boom® or Raven replacement harness, select the EZ-Boom setting. • Otherwise, choose the Field-IQ option.

4. Tap **Next** to continue to [Modules, 199](#).

Modules

1. At the Modules section for Section Control, tap the box for the module and complete the following settings.

Setting	Options
Serial Number	Select the serial number of the Section Control Module installed at this location. The display reads the serial numbers from the installed modules.
Number of Sections	Enter the number of sections physically wired into this module (up to 12 sections per control module).

2. Tap  when you have completed the settings for each module. Then tap **Next** to continue to [Width, 200](#).

Note – When you upgrade the XCN-2050 display firmware, the firmware for Field-IQ modules are also upgraded. There are no additional steps required to upgrade modules.

Width

1. At the WIDTH section for Section Control, review the width of each section per module.
2. To change a width of a the section, tap it. Begin with the first one on the left, and work from left to right.
3. The system will not allow you to change the width of the sections to be more or less than the total width of the implement.
4. Tap **Next** to continue to [Latencies, 200](#).

Latencies

Latency refers to the delay between when the command occurs (to turn a section on or off) and when application of the material actually starts or stops.

1. At the Latencies section for Section Control, review and make changes as necessary to the settings.

Tap...	To...
On Latency	Enter the length of time (seconds) from when a section is turned on to when the system begins to apply material.
Off Latency	Enter the length of time (seconds) from when a section is turned off to when the system stops applying material.

Tap...	To...
Apply ON Latency to Boundary	<p>Turn setting on or off by tapping. This setting applies to fields that have a boundary, and when you exit an exclusion zone and return to the workable area of the field.</p> <ul style="list-style-type: none"> • On: The system uses on latency to begin applying material immediately when crossing a boundary. • Off: The system starts when the boundary is reached and any mechanical delay could leave a gap between the boundary and where the product is applied. When GPS accuracy is low, this is the preferred selection.
Sections Off when Stopped	<p>Turn setting on or off:</p> <ul style="list-style-type: none"> • On: The sections shut down when the vehicle is stopped. • Off: The sections remain open (turned on) when the vehicle is stopped.

2. Tap **Next** to continue to [Overlaps, 201](#).

Overlaps

At the Overlaps section for section control, review and make any necessary changes to the settings.

Tap...	To...
Start Overlap	<p>Enter the amount of overlap (distance) you want when starting coverage.</p> <p>When you are in a previously covered area driving toward a non-covered area, the system will begin turning sections on at this distance before reaching the non-covered area.</p>
End Overlap	<p>Enter the amount of overlap (distance) you want when stopping coverage.</p> <p>When you are applying material and driving toward a previously covered area, the system will keep sections on until they are this far into the previously covered area.</p>
Coverage Switching Overlap	<p>Enter the percentage of a section's width that must be in a previously covered area before the system switches the section off. The higher the number, the greater the overlapped area before the section is turned off.</p>
Boundary Switching Overlap	<p>Enter the percentage of a section's width that must be past a boundary before the system switches the section off. The higher the number, the greater the overlapped area before the section is turned off.</p>

Rate control

On the Settings screen for Rate Control:

1. Tap  next to Rate Control. This toggles rate control on or off for the current channel.
2. After you turn on rate control, tap each setting and choose an option.

Tap...	To...
Number of Valves/Drives	The maximum number of drives is 1.
Control Valve/Drive Type	<p>Choose the type of drive that you is installed:</p> <ul style="list-style-type: none"> • Fast Bypass Servo • Fast Servo: 4-wire servo valve • Hardi % Bypass • PWM: 2-wire PWM valve (commonly used to control hydraulic flow) • Pump Servo • Standard Bypass Servo • Standard Servo: 2-wire standard servo valve <p>Note – <i>Bypass (for Servo and Hardi drives only) means that the controller is on the return-to-tank line. The valve closes to increase the application rate.</i></p>
Auxiliary Valve (for inline liquid/anhydrous channels only)	<p>Set the auxiliary valve:</p> <ul style="list-style-type: none"> • Disable- The equipment does not have an auxiliary control valve. • Dump - Valve opens to dump flow-to-return line when the system is turned off. • Master - Valve closes when the system is turned off.
Number of Nozzles	Enter the number of nozzles on the implement, between 1 and 999.

Tap...	To...
Valve/Drive Behavior when Sections Closed	<p>Set the behavior when sections are closed.</p> <ul style="list-style-type: none"> • Close - When all sections are off, the control valve returns to the closed position. • Lock in Minimum Position - When all sections are off, the control valve remains at the minimum flow position. This option applies to PWM drives only. • Lock in Last Position - When all sections are off, the control valve remains in the last position. This setting allows the system to return to the target rate faster. This option applies to Servo drives only.

3. Tap **Next** to continue to [Valve/Drive, 203](#).

Valve/Drive

1. At the VALVE/DRIVE section for Rate Control, tap the box that represents each drive and set the required values.

Tap...	To...
Serial Number	Choose the serial number of the Rate Control Module at this location. The display shows the serial numbers from the installed modules.
Flow Meter Type	Select the type of flow meter installed for this drive. (Raven, Trimble, or Other).
Flow Meter Calibration Number	<p>Enter the calibration number from the tag on the flow meter. The display calculates the calibration pulses per unit of volume.</p> <ul style="list-style-type: none"> • Raven - pulses per 10 gallons (liters) • Trimble - pulses per gallon (liter) • Other - pulses per gallon (liter)
Units (only if Flow Meter Type is Other)	<p>Choose the unit of measurement used by the flow meter.</p> <ul style="list-style-type: none"> • Pulses per gallon (liter) • Pulses per cubic inch (centimeter)

2. Tap . Then tap **Next** to continue to [Width, 204](#).

Width

1. At the Width section for Rate Control setup, the width is equal to the implement width and cannot be changed.
2. Tap **Next** to continue to [Adjustments, 204](#).

Adjustments

At the Adjustments section for Rate Control setup, review and change settings as necessary. When you are finished with all the settings, tap **Next**.



WARNING – When the implement is down and the master switch is in the On position, the machine is fully operational. Take all necessary precautions to ensure user safety. Failure to do so could result in injury or death.

Tap...	To...
Minimum Override Speed	Change this setting. When the vehicle drops below this speed, the system maintains the application rate for this speed. This ensures consistent material flow at low speeds.
System Minimum Flow	Enter the minimum flow rate required by the drive, control valve or flow meter. This setting keeps the flow above the minimum operating level required by the equipment.
Manual Rate Switch Aggressiveness	<p>Increase or decrease aggressiveness of the manual rate switch.</p> <p>When the Rate switch is in the Manual position, this controls how quickly the valve opens/closes when you use the rate increment/decrement switch on the master switch box.</p> <p>Note – <i>This setting does not affect automatic rate control.</i></p>
No/Low Flow Timeout	Enter a value between 1 and 10 seconds. If the rate of application is not at least 25% of the target rate for this length of time, the display shows a critical fault message and the system shuts down.
Pump Disarm Switch	<p>Turn setting on or off. If the implement has a pump disarming relay that is connected to the controller, this setting adds a button to the Run screen to arm and disarm the pump.</p> <ul style="list-style-type: none"> • Enable: Select this option if you have a pump disarming switch installed. • Disable: Select this option if you do not have a pump disarming switch installed.

Tap...	To...
Rate Snapping	<p>Turn setting on or off. This setting smooths out rate fluctuations seen on the screen.</p> <ul style="list-style-type: none"> • Off: The display shows instant readings from the feedback sensor. This may show frequent minor rate fluctuations. • On: The display smooths out the values. You will see the target rate as the applied rate whenever the applied rate is within 10% of the target rate.

Calibrate application control drives



WARNING – When the implement is down and the master switch is in the On position, the machine is fully operational. Take all necessary precautions to ensure user safety. Failure to do so could result in injury or death.

1. At the **Home** screen, tap . The Implement setup panel displays.
2. At the list on the left-hand side, tap the implement you want to calibrate, then tap **Select**.
3. Tap **Calibrate**. The calibration section opens at the Summary section.
4. Tap **Application Control**.
5. Tap the channel to calibrate it. A popup displays.
6. Tap **Calibrate**. The calibration tool displays, beginning at the Drive Limits section.
 - If *Maximum Flow* is unknown, use the default (0.00) to allow the system to determine maximum flow.
 - You can also use this formula to calculate Maximum Flow:
boom width x ground speed x application rate x calculation factor
 - For metric systems, use meters for width and kph for ground speed, with a calculation factor of 0.00167.
 - For standard systems, use feet for width and mph for ground speed, with a calculation factor of 0.00202.
7. Tap **Next** to continue to the Drive Settings section.

Setting	Description
Target Speed	Enter the test speed to use during calibration. The system will apply material at the rate required to reach the Target Rate if the vehicle travels at this speed.

Setting	Description
Target Rate	Set test rates to use for Rate 1 and Rate 2.
Master Switch	Indicates whether the Field-IQ Master Switch is on or off.
Applied Rate	The applied rate for comparison to the <i>Target Rate</i> .
Integral Gain (for Servo drives only)	If the drive is slow to come up to rate, increase the <i>Integral Gain</i> and turn on <i>Boost (Feed Forward)</i> . If the applied rate is erratic, decrease the <i>Integral Gain</i> .
Proportional Gain (for PWM drives only)	If the drive is slow to come up to rate, increase the <i>Proportional Gain</i> and turn on <i>Boost (Feed Forward)</i> . If the applied rate is erratic, decrease the <i>Proportional Gain</i> .
Minimum Response	If the drive is not responding, increase the <i>Minimum Response</i> . If the system has large fluctuations in applied rate, decrease the minimum response.
Minimum Position (for PWM drives only)	<i>Minimum Position</i> is the duty cycle the system commands to when all sections are off and you are using <i>Lock in Minimum Position</i> (see Rate control, 202).
Allowable Error	If the Applied Rate is less than this amount away from the target rate, the system will not send commands to adjust the rate.
Boost (Feed Forward)	If the drive is slow to come up to rate, increase the <i>Integral/Proportional Gain</i> and turn on <i>Boost (Feed Forward)</i> .

8. Tap **Next** to continue to the Information section.
9. Review the calibration results. The minimum and maximum values indicate the speed and flow ranges that will apply during operations.
10. To accept the calibration, tap  .

For information on:	See:
Diagnostics	Boom Height Diagnostics, 300
Control and adjustments during operation	Boom height control operation, 276

Virtual tank/bin

If you have the Field-IQ system's Rate Control, you can use an on-screen (virtual) tank to monitor tank or bin levels based on the amount of material applied.

1. At the Virtual Tank section, tap  next to Virtual Tank. This toggles the virtual tank On and Off for the current channel.
2. Tap each setting and then choose an option.

Tap...	To...
Units	Select the units to use for tank volume (gallons/liters).
Full Capacity Volume	Enter the tank's capacity.
Warning Type	Choose how you want to trigger the low-volume alarm: <ul style="list-style-type: none"> • Volume: Alarm when volume dips below this level. • %: Alarm when volume is less than this percent of capacity.
Warning Level	Enter the volume (amount or percent) below which you want to see an alert.

3. Tap **Next** to continue to [Adjustments, 207](#).

Adjustments

At the Adjustments section for application control, review and change the settings for the current channel as required.

Tap...	To...
Jump Start Speed	Adjust the jump start speed. When the Field-IQ system's Master switch is in the jump start position, the system applies material at the rate for this speed instead of the vehicle's current speed. This manual override option can be used to operate the system when the vehicle is stationary, or when GPS is unavailable.
Jump Start Timeout	Adjust start timeout. This setting limits the length of time you can run the jump start. Note – <i>Auto-control resumes if Jump Start Speed is exceeded by ground Speed.</i>
Shut Off Speed	Adjust shut off speed. The system shuts down if the implement drops below this speed.

When you have completed these settings, tap **Next** to continue to [Summary, 207](#).



Summary

The Summary section shows an overview of all the settings for the channel.

1. Review the channel details.
2. To change channel settings, tap **Back** until you reach the section you wish to edit..
3. Tap . The display saves the channel and returns to the Application Control section for implement setup.
4. Tap **Next** to continue to:
 - a. [Boom height control, 210](#), if applicable
 - b. [Inputs, 219](#), if applicable

Modify a control channel





To edit an application control channel:

1. Tap  on the **Home** screen. The Implement setup panel displays.
2. Tap the implement you want to work with.
3. Tap **APPLICATION CONTROL**.
4. Tap the control channel that you want to change, then tap **Modify**.
5. Tap the button at the top of the screen for the channel setting that you want to change.
6. When you finish making changes, tap **Summary** at the top right corner of the screen.
7. If any part of the setup is not complete, you can save the changes but you cannot use the implement on the **Run** screen.
8. To save the channel and return to the Application Control section, tap . The display returns you to the Implement setup panel.
9. To exit channel setup without saving, tap . The display returns you to the Implement setup panel.

Remove a control channel

To remove an application control channel:

1. Tap  on the **Home** screen. The Implement setup panel displays.
2. Tap the implement you want to work with.
3. Tap **APPLICATION CONTROL**.
4. Tap the control channel that you want to remove, then tap **Remove**. The system displays a confirmation message for you to confirm that you want to remove the channel.
5. Tap

-  to confirm the removal. Otherwise, tap  to cancel the removal.
6. When you finish making changes, tap **Summary** at the top right corner of the screen.
 7. If any part of the setup is *Not Complete*, you can save the changes but you cannot use the implement on the **Run** screen.
 8. To save the channel and return to the Application Control section , tap . The display returns you to the Implement setup panel.
 9. To exit channel setup without saving, tap . The display returns you to the Implement setup panel.

Boom height control

Note – For the correct connection of equipment, refer to the *Connecting the Field-IQ system Crop Input Control Systems* chapter in the *XCN-2050 Display Cabling Guide*.

Implement setup includes *Boom Height* if you have a boom height control feature unlocked on the device.

Before setting up Field-IQ Boom Height Control, you must complete the following:

- Unlock and install Field-IQ Boom Height Control.
- Add, configure and calibrate a vehicle. See [Add a vehicle, 140](#).
- Set up the implement. See [Implement setup, 188](#).

Note – A SIM must be present before you can use Boom Height Control.

To set up Field-IQ Boom Height Control, complete the following settings:

1. [Boom height control setup, 210](#)
2. [Sensor location, 211](#)
3. [Operation settings, 212](#)

For information on:	See:
Calibrating boom height	Calibrate boom height control, 215
Diagnostics	Boom Height Diagnostics, 300
Control during operation	Boom height control operation, 276
Adjustment during operation	Boom height adjustments, 278

Boom height control setup

1. At the Control section of the Boom Height settings, review and make changes to the settings as appropriate.

Tap....	To....
Boom Height	Turn the feature on or off.
TM-200 Module S/N	Choose the appropriate serial number of the TM-200 Module.

Tap....	To....
Boom Control Layout	Select the option you want for controlling the boom height: <ul style="list-style-type: none"> • Control Booms + Center Section • Control Booms + Monitor Center Section • Control Booms Only • Control Center Only • Monitor Only: Shows the boom height on the Run screen, without the option to automatically control boom height
Valve/Drive Module S/N	Choose the serial number of the valve/drive module.

2. Tap **Next** to continue to [Sensor location, 211](#).

For information on:	See:
Control during operation	Boom height control operation, 276
Adjustment during operation	Boom height adjustments, 278

Sensor location

At the Sensor Location section of Boom Height settings:

1. Tap **Number of Height Sensors**. Select the number of height sensors installed on the system.
2. Tap each sensor box to complete the settings for the sensor.

Note – The current display shows the center section of the boom as a side view and the right boom as the left boom. This does not hinder functionality or settings.

Tap...	To....
Enabled	Turn the sensor on or off.
Sensor S/N	Select the serial number for the sensor. The display reads the serial numbers from the installed sensors.
Side Offset	Enter the distance from the center line of the sensor to the hinge point of the boom. (Does not apply to the center section.)
Nozzle Offset	Enter the distance from the transducer surface to the spray nozzle tip.

3. When finished, tap . The display returns to the SENSOR LOCATION section.

4. Continue setting up each sensor.
5. Tap **Next** to go to [Operation settings, 212](#).

For information on:	See:
Control during operation	Boom height control operation, 276
Adjustment during operation	Boom height adjustments, 278

Operation settings

At the OPERATION section of Boom Height settings, review the existing settings. Make changes to the settings as required. Your options will depend on which option you chose for the Boom Control Layout in the Control section. See [Boom height control setup, 210](#) for more information.



WARNING – Working without a working SIM is dangerous.

Refer to the settings listed below to edit operation settings.

Note – *The settings that display on your screen depend on the type of Boom Control Layout you chose at the CONTROL section. (See [Boom height control setup, 210](#).)*

Tap...	To...
Target Height	Enter the distance above the ground or crop canopy (see Sensing Mode below) that you want the nozzles to be.
Minimum Target Height	Set the lowest value that the target height can be set to. If a height sensor on a multi-sensor zone is reporting a height lower than this value, the display will switch from using the average zone height to using just the lowest sensor.
Maximum Target Height	Set the maximum height that the target can be.
System Aggressiveness	Set the aggressiveness for the boom height control system. A higher value is more aggressive, and a lower value is less aggressive.
Roll Stabilizer	Raise this setting to increase the boom roll stability.

Tap...	To...
Sensing Mode	<p>Select how the system will detect the boom height:</p> <ul style="list-style-type: none"> • Ground: Boom height is based on the surface of the ground. Use Ground mode to sense the ground surface through low coverage vegetation, such as stubble or young crops. • Canopy (default): Boom height is based on the top of the crop canopy. Select Canopy mode to sense the closest object seen. This is used to sense bare ground or high-coverage broad leaf crop canopy. <p>Note – <i>Ground mode is susceptible to unwanted reflectance on hard or wet surfaces, such as bare ground. If this is an issue, select Canopy mode.</i></p>
Target Height Step	The distance the target height will increase.

Tap...	To...
Advanced	<p>Opens the advanced settings:</p> <p><i>Boom Down Rate:</i> Reduce this setting to lower the maximum downward speed of the boom.</p> <p><i>Sensor Sensitivity:</i> Low, normal or high.</p> <p><i>Sensor Canopy Filter:</i> Off or on</p> <p><i>Sensor Ground Filter:</i> Off, low, medium or high</p> <p><i>Minimum Safety Height:</i> Adjust this setting. When an individual sensor measures a height less than this setting below the current target height, the display will switch from using the average sensor zone height to using just the lowest sensor's height (and ignore the higher sensor). This setting only applies to multi-sensor zones.</p> <ul style="list-style-type: none"> • Lowering the threshold: Will make the system more aggressive at raising a zone when a individual sensor is low, especially when two sensors report different heights. • Raising the threshold: will improve the boom roll stability. Default is 4 inches (0.1m). Minimum = 0 (aggressive ground avoidance. Maximum = 1.0 (effectively disabled). <p><i>Auto Disable Timeout:</i> Sets the "Timeout" time frame if the system "Enable" button was selected and the system was not "Engaged", after this period of time the system will disable itself. 30 or 60 seconds.</p> <p><i>Height Error Indicator Band:</i> Adjust this setting. If the boom is within this distance of the target height, the screen will indicate that the system is at the target height.</p> <p>Note – This setting is for on-screen indication and does not impact performance. The system will still work to drive the boom closer to the target height.</p> <p><i>Roll Dampening Threshold:</i> Use this height error threshold to help dampen underdamped wins and improve roll stability. 4-8 inches (0.1-0.2m) is typical. A value of 0 (default) disables this additional dampening.</p>

Tap **Next** to continue to [Inputs, 219](#).

For information on: See:

Control during operation [Boom height control operation, 276](#)

For information on: See:

Adjustment during operation [Boom height adjustments, 278](#)

Calibrate boom height control

Each boom's hydraulic drive must be calibrated before you can use the Field-IQ system Boom Height Control on the **Run** screen. Before you calibrate boom height control:

- Complete the implement and boom height configuration.
- Take the equipment to a field with a firm, natural surface (not concrete, not freshly tilled).
- Make sure that the hydraulic fluid is at normal operating temperature.

Note – *On some vehicles with large reservoirs, it may take a longer amount of time for the fluid to reach operating level, especially if the implement circuit is lightly loaded. Consult the vehicle documentation to determine if the hydraulic fluid temperature can be shown on a vehicle console.*

- Use the manual control panel to test the system prior to calibration. See [Boom height manual control test, 216](#).

For information on:**See:**

Diagnostics	Boom Height Diagnostics, 300
Control during operation	Boom height control operation, 276
Adjustment during operation	Boom height adjustments, 278

Boom height calibration steps



1. Access the calibration for boom height control.
 - a. At the **Home** screen, tap .
 - b. Tap the implement you want to calibrate, and then tap **Select**.
 - c. Tap **Calibration**.
 - d. Tap **Boom Height**. The boom height calibration panel displays.
 - e. Tap **Calibrate** for the boom you want to calibrate.
2. Tap **BOOM CALIBRATION**.



3. Tap **Calibrate** for the boom you want to calibrate. The calibration tool displays.



WARNING – Moving parts during this operation. Make sure that the implement is safe to operate.





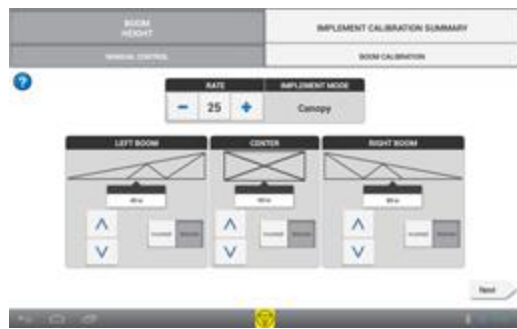

4. Tap **Calibrate**. The calibration process begins.
5. When the calibration process is complete, tap .
6. If you want to view and edit advanced calibrations for the boom drive, tap **Advanced**. (The **Advanced** button is not available until basic calibration is complete.) The advanced calibration displays. Change the settings as appropriate. For these settings, see [Operation settings, 212](#), under the Advanced setting.
7. Complete steps 2 through 6 for each boom drive.
8. Tap **Next** to continue to the Calibration Summary.
9. At the Calibration Summary, tap  to save the settings.

Boom height manual control test

Before you calibrate boom height, make sure the booms are reacting as you would expect to raise and lower commands.

1. Access the manual control panel for boom height control.
 - a. At the **Home** screen, tap .
 - b. Tap the implement you want to calibrate, and then tap **Select**.
 - c. Tap **Calibration**.
 - d. Tap **Boom Height**. The boom height panel displays.
2. Tap **Manual Control**. The MANUAL CONTROL section displays.



3. If you have a SIM module, for each boom:
 - a. Set the switch in the cab to the *Raise* position. Make sure that the  button for the boom you are working with is lighted. If the wrong button lights up, check the wiring.
 - b. Set the switch in the cab to the *Lower* position. Make sure that the  button for the boom you are working with is lighted. If the wrong button lights up, check the wiring.
4. If you do not have a SIM module:
 - a. Tap  for each boom you are working with. Make sure that the boom goes up.
 - b. Tap  for each boom you are working with. Make sure that the boom goes down.
 - c. If the boom moves in the wrong direction, tap the **Inverted** button for the boom and then repeat steps 3a and 3b.
 - d. Optionally, tap the  and  buttons to adjust the *Rate*, and then repeat Step 2. This raises and lowers the boom more quickly or more slowly for testing only. The Rate on this screen does not affect boom height functions on the Run screen.
5. Each control has an up and down button for manual control. Use Rate to adjust the actuator output speed. If the boom moves too quickly, adjust the rate value down and vice versa. Each zone has:
 - A canopy height readout for each sensor associated with that zone
 - A status indicator for the manual height control switches associated with the zone (if enabled)



Refer to the installation guide for troubleshooting assistance.
6. For each boom section:
 - a. Press and hold the up button.
 - b. Verify that the appropriate section of boom moved up.
 - c. Verify that the height readings for each sensor on that boom increased.
 - d. Press and hold the down button.

- e. Verify that the appropriate section of boom moved down.
 - f. Verify that the height readings for each sensor on that boom decreased.
 - g. Verify external switches are connected correctly by pressing each vehicle manual boom control switch. The switch status corresponding to each input should turn green while the switch is pressed.
7. If the booms operate as you expect, tap **Next** to continue to boom calibration. (See [Boom height calibration steps, 215.](#))
 8. If the booms are not operating as you expect, you will not be able to calibrate and you will have to troubleshoot the system.



Inputs

At the INPUTS section, you can add sensors available on your implement.

Add a sensor

1. Turn Sensors on by tapping .
2. Tap  to add a sensor. The TYPE section displays.

Type of sensor

1. Choose the type of sensor you are using:
 - a. Air pressure
 - b. Liquid pressure
 - c. Vacuum pressure
2. Turn the sensors feature on by tapping .
3. Tap .
4. Tap the name entry box to edit the name of the sensor.
5. Tap **Next** to continue to the [Location](#) section.

Location of sensor

At this section, complete the following settings.

Tap...	To...
Select Module	Select serial number of the sensor. The display reads the serial numbers from the installed sensors.
Input Location on FIQ Module	Select the port on the the Field-IQ system control module where the sensor connects to the system. Note – For bin level, RPM, and gate height sensors, this is set automatically and cannot be changed.
Units	Select the measurement units used by the sensor.
Display in Control Channel	Shows name of channel. Selected whether or not the sensor shows up in the <i>Sensors Area</i> of the Rate Control Widget for the channel. <ul style="list-style-type: none"> • No - if you do not want to see the sensor • Channel number (1-6) - the material control channel where you want to see the sensor



Tap **Next** to continue to [Alarms](#).

Alarms

At the Alarm section, you can set up alarms for sensors.

1. Turn on Alarms by tapping .
2. Change the settings as appropriate.

Tap...	To...
Alarm	Turn this feature on or off.
Warn If Below	Enter the value that will trigger the alarm when the sensor reading is below this value.
Warn if Above	Enter the value that will trigger the alarm when the sensor reading is above this value.
Warn After	Adjust the number of seconds before the alarm triggers.

3. Tap . The display saves your settings and returns to the Inputs section (see [Inputs, 219](#)).
4. Tap  **Add** to add another sensor.
5. Tap **Next** to go to the SIM section (see .

Note – All pressure sensors must be calibrated. When you are ready to perform the calibration, see [Inputs / Sensors calibration, 221](#).

SIM

Note – If you are using Boom Height Control, a SIM is required.

If your system has a SIM, at the SIM section choose the type of sprayer. If your system does not have a SIM, tap **Next**.

You may also choose to enable or disable boom height here.

1. For some self propelled sprayers that are using the SIM to control sections for Field-IQ on the factory joystick or console, tap **Application Control FIQ** and select the sprayer you are using.
2. If you need to disable the override feature on the booms, tap **Boom Height** and choose disable. This will cause the joystick controls to no longer disengage automatic boom height control.
3. Tap **Next** to continue to the Summary section.



Inputs / Sensors calibration

1. At the Home screen, tap . The Implements panel displays.
2. Select the implement and then tap **Select**.
3. Tap **Calibrate**.
4. Tap **INPUTS**.
5. Tap the sensor you want to calibrate. A popup displays.
6. Tap **Calibrate**.
7. Tap **Enabled**.
8. Tap **Calibration Type** and select the type of calibration you wish to perform:
 - a. *High/Low* - More accurate and requires a pressure gauge for reading the actual pressure. (If you chose this type, continue to step 9.)
 - b. *Point/Slope* - Requires a slope value for the equipment from the manufacturer of the implement. (If you chose this type, continue to step 10.)
9. To complete calibration for the High/Low method:
 - a. Tap **Start Calibration**.
 - b. Read the instructions on the screen and then tap **Next** to begin.
 - c. Without the system running, take a reading. Enter this value into the *Actual Pressure* field and then tap **Next**.
 - d. Run the system at normal working pressure and take a reading. Enter this value into the *Actual Pressure* field.
 - e. Tap **Next**.
 - f. Run the system at normal working pressure and take a reading. Enter this value into the *Actual Pressure* field.
 - g. Run the system from low to high levels to verify the change in sensor readings.
 - h. Tap **Accept** or tap **Recalibrate** to repeat the process
10. To complete calibration for the Point/Slope Method:
 - a. Enter the *Slope* value for the sensor from the manufacturer.
 - b. Tap **Start Calibration**.
 - c. For *Actual Pressure*, enter the current pressure. Tap **Next** to continue.
 - d. Review the results. If the *Measured Pressure* is not accurate, tap **Recalibrate** and repeat the calibration with a new Slope value.
 - e. Tap **Accept** when the *Measured Pressure* is accurate.

11. Repeat Step 5 through Step 10 for each sensor. When finished, tap .

Review implement summary

The SUMMARY section displays when you complete all of the setup and configurations steps, or when you edit an implement.

To ...	Tap ...
Save the implement with any changes you have made.	
Exit the setup without saving changes. The display will let you choose to save the changes or exit without saving.	

Prescriptions

The information in a prescription is used to send target rates to the variable rate controller. Applied rates are received from the controller, and both target and applied rates appear on the screen. With prescriptions functionality, you can:

- Transfer one or more prescription files to or from the XCN-2050 display (import or export)
- Assign a prescription to a channel
- Use a prescription to determine the rates to be applied in different areas of a field

For information on:	See:
Prescriptions Manager	Prescriptions Manager, 66
Import prescriptions	Importing prescriptions, 223
Export prescriptions	Exporting prescriptions, 223
Assign a prescription	Assign a prescription, 280
Use a prescription	Use a prescription, 281

Importing prescriptions

Note – If you are using USB to import, make sure your USB drive has the AgGPS folder on the root, and the prescription files are in this folder.

You can import prescription files using:

- USB
 - Office Sync
1. To transfer one or more prescriptions to the XCN-2050 display, follow the steps at [Data transfer, 67](#).
 2. When transferring using USB, at the USB list on the left side of the data transfer panel, you can select the entire prescriptions folder or individual files within the folder.
 3. During the transfer, the XCN-2050 display shows the progress of the transfer.

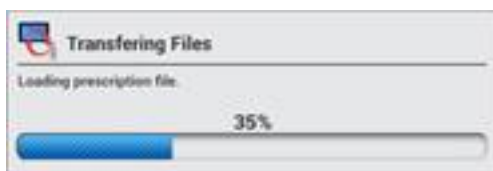

Exporting prescriptions

Note – If you are using USB to export, make sure your USB drive has the AgGPS folder on the root.

You can export prescription files from the XCN-2050 display using a USB drive. See [Data transfer, 67](#).

Materials

In this chapter:

Managing materials	226
Material list	226
Add a material	227
Edit a material	229
Delete a material	229
Assign a material to a channel	229
Calibrate material flow	230

At the Materials setup panel, you can add and edit materials as well as calibrate material flow.

Managing materials

You assign materials to material control channels for the Field-IQ system Rate and Section Control.

If you have the Field-IQ system Rate Control or Section Control, material setup requires:

- [Add a material, 227](#)
- [Assign a material to a channel, 229](#)

You must also calibrate the material flow. See [Calibrate material flow, 230](#).

Use the material setup panel to add, edit, assign, or delete materials.

Material list

The categories and types of materials in the Materials library are listed below.

Anhydrous

The materials in this category are Anhydrous and Other.

Granular fertilizer

- Adjuvant
- Fertilizer/Lime
- Fungicide
- Growth Regulator
- Herbicide
- Insecticide
- Manure
- Nematacide
- Other
- Rodenticide

Liquid

- Adjuvant
- Fertilizer/Lime
- Fungicide
- Growth Regulator
- Herbicide
- Insecticide
- Manure
- Nematacide
- Other
- Rodenticide
- Water

Granular seed

- Barley
- Beans, Dry
- Millet
- Oats
- Rice
- Rye

- Canola
- Corn
- Corn, seed
- Cotton
- Other
- Peanuts
- Popcorn
- Potatoes
- Sorghum Grain
- Sugar Beets
- Sunflowers
- Wheat

Row crop seed

- Barley
- Beans, Dry
- Canola
- Corn
- Corn, seed
- Cotton
- Millet
- Oats
- Other
- Peanuts
- Popcorn
- Potatoes
- Rice
- Rye
- Sorghum Grain
- Sugar Beets
- Sunflowers
- Wheat

Add a material

1. At the **Home** screen, tap . The Material setup panel displays.
2. Tap **Material Library**.

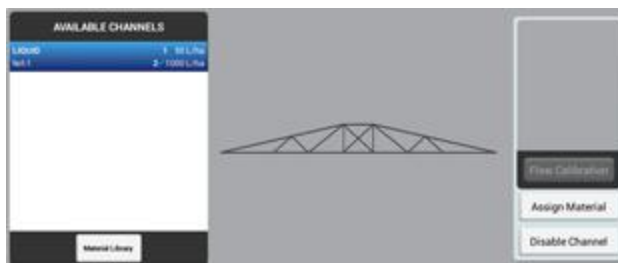



3. Tap **Add**.

4. Tap each setting and then select or enter a value.



Tap...	To...
Material Name	Tap the text entry box and then use the on-screen keyboard to enter a name for the material.
Material Category	Select the type of material being applied: <ul style="list-style-type: none"> • Anhydrous • Granular fertilizer • Granular seed • Liquid • Row crop seed
Type	Type of material (see Material list, 226)
Distributed Units	Select the units to use with the selected material.
Target 1	Control the volume that the implement supplies when Rate 1 is selected.
Target 2	Control the volume that the implement supplies when Rate 2 is selected.
Rate Increment	Set rate increment. When you increment/decrement Rate 1 or Rate 2 on the Run screen, the current application rate increases or decreases by this amount.
Minimum Rate	Set the minimum rate that will be applied.
Maximum Rate	Set the maximum rate that will be applied.
Material Details (optional)	Set additional details, if needed: <ul style="list-style-type: none"> • EPA Product Number: Enter the registration number for the material from the environmental protection agency for the area, if applicable. • Manufacturer: Enter the material manufacturer's name. • Restricted Use: Tap Yes or No to record whether use of the material is restricted by local, regional, or national laws. • Posting required • Buffer Distance: Enter the buffer distance from the product label of the material. • Max Wind Speed: Enter the maximum wind speed from the product label of the material. • Notes: Enter any other notes that you want to record with the material.

5. Tap each setting and then select or enter a value.

Edit a material

1. At the **Home** screen, tap . The Material setup panel displays.
2. Tap **Material Library**.
3. Select the material in the list on the left-hand side of the screen and then tap **Edit**.
4. Tap each setting to make the required changes. See the settings table under the section [Add a material, 227](#).
5. Tap .

Delete a material

1. At the **Home** screen, tap . The Material setup panel displays.
2. Tap **Material Library**.
3. Select the material in the list on the left-hand side of the screen and then tap **Delete**. The system displays a confirmation screen.
4. Tap  to remove the material and  to cancel the deletion.

Assign a material to a channel

Note – If you do **not** have the Field-IQ system Rate Control, you cannot assign a material to a channel.

1. At the **Home** screen, tap . The Material setup panel displays.

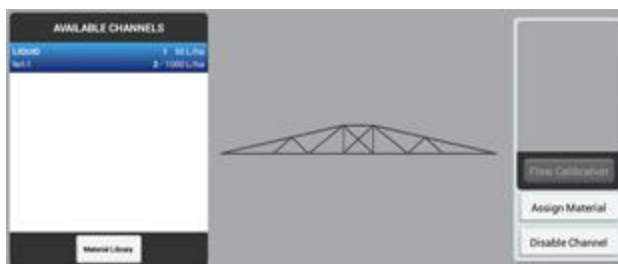

2. Tap the channel in the list on the left-hand side of the screen.

Note – If you do not have a channel set up, see [Add a control channel, 197](#).

3. Tap **Assign Material** on the right-hand side of the screen.
4. Tap the material that you want to assign to the channel. The list shows only the materials that are the same type as the control channel's Material Type.

If you have not set up the material that you want to assign, tap **Material Library**.

If a material is already assigned to the channel, the item in the list has a  next to that material.

Note – For the most accurate application, calibrate the flow. See [Calibrate material flow, 230](#).

Calibrate material flow

For the most accurate application, calibrate the flow.



WARNING – Material will be dispensed during calibration. Make sure that the implement is safe to operate.



WARNING – During flow calibration, the machine will become operational. Take all necessary precautions to ensure user safety. Failure to do so may result in serious injury or death.

Pre-calibration steps

Before you calibrate flow:

1. Complete the implement and rate control configuration and calibrations.
2. Select a control channel and assign a material. See [Managing materials, 226](#).

Calibration steps



1. At the **Home** screen, tap . The Material setup panel displays.
2. Tap the channel name in the list on the left-hand side of the screen.
3. Tap **Flow Calibration** on the right-hand side of the screen.
4. Tap the drive you want to calibrate. The calibration tool displays.
5. Review the settings and update if necessary.

Note – For information about the appropriate values for your sprayer, refer to the support note *Field-IQ crop Input Control System: For Sprayers and Spreaders*.

Tap...	To...
Target Rate	Enter the rate to use for the calibration.
Speed	Enter the test speed to use during calibration. The system will apply material at the rate required to reach the Target Rate if the vehicle was traveling at this speed.



WARNING – Moving parts during this operation. Make sure that the implement is safe to operate.

6. Tap **Run Calibration**.
7. Follow the on-screen instructions to complete the flow calibration.
8. To accept the new values, tap  .
9. To use the new values but recalibrate with them, tap **Recalibrate**.
10. To discard the new values and begin again, tap .

Operations



In this chapter:

Preparing for operation	234
Fields and guidance	235
Tasks	235
Layers	236
Adjustments during operation	236
Automatic transfer of data	236
Tasks	238
Coverage logging	241
Vehicle operation	242
Guidance patterns	246
Landmarks	263
Layers	267
Field-IQ system operations	270
Prescriptions	280
ISOBUS	282
On-screen widgets	286
Alerts and warnings	292

During operations while working in the **Run** screen, you can create and adjust guidance patterns, engage or disengage the steering system, start a new task, include status widgets on the screen and make adjustments to steering, guidance, rate and section control and boom height control.

Preparing for operation

Before you can enter a field in the **Run** screen, you must:

- Set up a positioning service. See [Connectivity concepts, 133](#) and ensure GNSS is functioning correctly.
- [Add a field, 181](#).
- [Preparing for operation, 234](#).
- Set up a vehicle. See [Vehicle setup, 140](#).
- Select a vehicle:
 - a. At the **Home** screen, tap . The Vehicle setup panel displays.
 - b. At the list on the left-hand side of the setup panel, tap the name of the vehicle you want to select. The display changes the list item to a blue background with white text.
 - c. To select the vehicle before performing field activities at the **Run** screen, tap **Select**. A  and the blue highlight indicates which vehicle you chose.



The display indicates in the lower left-hand portion of the screen which vehicle is selected for field activities.





- Set up an implement. See [Implement setup, 188](#).
- Select an implement. See [Select an implement, 189](#).

Choose a field to enter

You can enter a field you currently have selected or one that is not currently selected.

Currently selected field

To enter a field that is currently selected, tap   . The **Run** screen displays.

Field not currently selected

To enter a field not currently selected:

1. At the **Home** screen, the map shows points (📍) where your fields are located. Tap the 📍 that represents the field you want to enter. (For a map to display on the **Home** screen, you must have a updated GNSS connection.)
2. A popup displays with the field name and two buttons.



3. To enter the field without beginning a new task, tap **Enter Field**.
4. To start a new task, tap **Start New Task and Enter Field**. The **Run** screen displays.

Run screen

The text and buttons displayed on your **Run** screen depend on:

- Whether you are using a guidance / steering system or manual guidance
- Other features you are using
- How your XCN-2050 display is set up

Fields and guidance

When you enter a field, you can create boundaries, guidance patterns and landmarks within that field. To edit any of these elements, open the Field Manager. Here you can rename your field, and include the name of your client and the name of the farm where the field is located.

For information on:	See:
Fields	Field Basics, 180
Field Manager	Field Manager, 61

Tasks

While in the **Run** screen, you can log coverage of the activity you are performing in the field. As your activity is logged, applicable information is saved in a task. The information related to each task

includes (but is not limited to):

- The field in which the task took place
- Time and date
- The type of operation performed

When you pause during a field activity, you can continue the same task or you can begin a new task (if you will be performing a different type of operation). At the Field Manager, you can view the history of tasks completed for each field.

For information on:	See:
Field Manager	Field Manager, 61
Tasks	Tasks, 238

Layers

While the system is logging your field activity, you have the option to view one layer of activity at a time. For example, you can view overlaps in coverage or the speed of your vehicle throughout the operation. You must have logging on to see layers of coverage.

For information on:	See:
Layers	Layers, 267

Adjustments during operation

While you are performing field activities, you can make adjustments to:

- Steering (see [Steering adjustments, 244](#))
- Guidance patterns (see [Guidance adjustments, 244](#))
- Boom height (see [Boom height adjustments, 278](#))
- Field IQ operations (see [Field-IQ system operations, 270](#))

Automatic transfer of data

The XCN-2050 display can wirelessly transfer information recorded during your field activities to Connected Farm and the office. This requires:

- A DCM-300 modem
- A subscription to Office Sync

- A data plan or access to WiFi
- A Connected Farm account

For information on:	See:
DCM-300 modem	DCM-300 modem, 98 , Modem services settings, 88 and DCM-300 modem initial setup, 130
Office Sync	Office Sync setup, 130 and Office Sync data transfer, 69

Tasks

A task consists of the combination of implement type and the selected field. The XCN-2050 display stores field activities related to each task. By using tasks, you do not have to continually configure frequently used field profiles.

When you enter a field with the same operation and implement that you used previously, the display continues the previous task unless the *Max Task Time* has already passed.

When you change operation, implement, or field, the display automatically starts a new task.

Use the Task History section in Field Manager to:

- Open a previous task.
This is helpful if you enter a field and do not see coverage that you want to see from an earlier activity. This shows the coverage from the previous task in the field, and adds the new activity to the previous task
- Start a new task.
This is helpful if you enter a field and you see coverage from an earlier activity that you do not want to see for the current activity. When you start a new task the display removes the previous coverage from the Run screen and saves the current activity in a new task.

Data stored in each task

The data stored in each task includes:

- The field you are working in
- Date and time for starting and stopping task
- Coverage list: The list of task coverages for the field
- Coverage overlap: The area of coverage overlap
- Height: Mean height above sea level
- Speed: The speed of the vehicle
- Material: The material being applied, if applicable
- Guidance engaged: When the automatic guidance system was and was not engaged
- Applied rate: The rate material is applied
- GPS Quality: The quality of GPS

Create a task

There are three ways you can create a task:

- **Automatically:** If you enter a field with an implement with operation that does not match any currently stored task, a new task will be created automatically.

- At the **Field Manager Task History**: Tap to enter the Field Manager, select the task history and start a new operation. For this option, an implement must be selected. If not, the display pops up a message to tell you what is required to create the task.
- At the **Home** screen: Select . The system displays the field name along with the option to go to the field and create a new task.

Add a task (Run screen)

Tap **Start New Task** to begin a new task. The display will not show previous related map coverage layers on the **Run** screen.

Review existing tasks (Field Manager)

1. Select the field. See [Select a field, 182](#).



2. Tap  to open the Field Manager.
3. Tap **Task History**.
4. Tap the tasks on the left-hand side of the screen to review previous tasks:
 - Tap + or - to show or hide tasks for each operation.
 - Tap a specific task to select it. Each task is shown with its start and end date and time.
 - The map shows the coverage layer(s) saved for the selected task

Review existing tasks (Field Manager)

1. Select the field. See [Select a field, 182](#).



2. Tap  to open the Field Manager.
3. Tap **Task History**.
4. Tap the tasks on the left-hand side of the screen to review previous tasks:
 - Tap + or - to show or hide tasks for each operation.
 - Tap a specific task to select it. Each task is shown with its start and end date and time.
 - The map shows the coverage layer(s) saved for the selected task

Edit a task (Field Manager)

1. Add a task or select an existing task.
2. Tap **Continue Task** to add current coverage to the selected task. The display will show the previous related coverage on the Run screen.

Note – *This option is only available if the implement you have selected is for the same type of operation.*

3. Make sure that the *Max Task Time* is suitable.
 - a. If the implement and operation do not change, the display adds coverage to the current task until the task exceeds the *Max Task Time*.
 - b. If the *Max Task Time* is not acceptable, tap the number of days to change it.
4. Tap **Exit** to save the changes and close the Field Manager.

Coverage logging

Coverage logging:

- Records the area that you have covered when you carry out an operation, for example applying fertilizer to a field
- Allows you to see different map layers of your coverage as you are working in the field.

Manual coverage logging

To activate coverage logging, tap .

Automatic logging with engage

If your system has been configured to do so, coverage will start when your auto guidance system is engaged. Coverage will stop when auto guidance is disengaged. To turn on this capability, see [Patterns settings, 83](#).

If automatic logging is activated, you can still turn logging on or off when engaged or when disengaged.

Editing layers



To edit settings for layers, see [Edit a coverage layer, 268](#).

Vehicle operation

At the **Run** screen, tap the screen to display the vehicle position buttons. The **Engage** button shows the status of your auto guidance system as well as enables you to tap on the button to engage the system.

 **WARNING** – Many large and sudden changes in satellite geometry caused by blocked satellites can cause significant position shifts. If operating under these conditions, auto-guidance systems can react abruptly. To avoid possible personal injury or damage to property under these conditions, disable the auto-guidance system and take manual control of the vehicle until conditions have cleared.





Vehicle position

Button	Tap to...
	Change point of view on the Run screen to an overhead view.
	Change the point of view on the Run screen to a view with the horizon.
	Zooms view in or out on the Run screen.

Engage status with auto guidance



When the **Engage** button turns yellow, you can tap it to engage the auto guidance. After your guidance system is engaged, the button changes to green.

 **WARNING** – Auto guidance systems cannot avoid items in the field such as obstacles. Make sure you are adequately trained to operate the auto guidance system.

Indicator/Button	Auto guidance system is...
 <p data-bbox="304 539 370 573">Gray</p> <p data-bbox="240 591 437 624">Engage Disabled</p>	<p data-bbox="501 344 1366 378">Disabled. Enable it in the steering control panel. This is an indicator only.</p>
 <p data-bbox="312 819 363 853">Red</p> <p data-bbox="245 871 430 904">Cannot Engage</p>	<p data-bbox="501 651 1345 714">Does not have the proper conditions met to engage. Tap to determine the reason.</p>
 <p data-bbox="296 1128 379 1162">Yellow</p> <p data-bbox="237 1180 440 1214">Ready to Engage</p>	<p data-bbox="496 927 1302 960">Ready to engage (yellow). Tap to engage the auto guidance system.</p>
 <p data-bbox="300 1440 376 1473">Green</p> <p data-bbox="285 1491 391 1525">Engaged</p>	<p data-bbox="496 1234 1353 1305">Engaged (green). Indicates you are engaged on a pattern or line and are using auto guidance. Tap to disengage.</p>

Steering adjustments

To adjust steering while performing field activities, at the **Run** screen, tap . The system displays the steering adjustment buttons.

Button	Use to...
Vehicle Aggressiveness 	Adjust the vehicle aggressiveness.
Autosteering Enabled 	Enable or disable auto steering.

For information on: See:



Vehicle aggressiveness	<ul style="list-style-type: none"> For Autopilot: Engage aggressiveness, 166 For EZ-Pilot: Online aggressiveness calibration for EZ-Pilot system, 171
Diagnostics	Autopilot system diagnostics, 296 , EZ-Pilot system diagnostics, 303 , EZ-Steer system diagnostics, 307

Guidance adjustments

To adjust guidance while performing field activities, at the **Run** screen, tap . The guidance adjustment buttons display.

Note – These adjustments are removed if you enter a new task. Your system may also be set up to remove these adjustments with a power cycle. See [Steering and guidance, page 1](#) for these settings.

Buttons	Use to...
Nudge 	Temporarily move the vehicle left or right depending on the direction you chose. . To set the increment that nudge moves, see Steering and guidance settings, 85 .

Buttons	Use to...
<p>Remark</p> 	<p>Temporarily move the pattern to the vehicle's current location. For information on re-mark settings, see Steering adjustments, 244.</p>
<p>Implement Draft Correction</p> 	<p>Move the implement back on the guidance line if the implement is physically drifting offline in the field. The value between the arrow buttons indicates the amount of distance for the correction. To set the increment that implement draft correction moves, see Steering and guidance settings, 85.</p>

Guidance patterns

Guidance items you can place in the field from the **Run** screen include:

- Boundaries
- Straight or curved lines
- Headlands
- Pivots

After you have created guidance items, you use Field Manager to:







- Edit guidance lines, patterns and boundaries.
- Activate or deactivate boundaries, guidance lines and patterns.







To create:	To edit:	Settings/adjustments:
Go to the Run screen. See: <ul style="list-style-type: none"> • AB guidance line creation (Run screen), 251, A+ guidance line creation (Run screen), 252, Curved line creation (Run screen), 252 • Boundary creation (Run screen), 248 • Headland and infill pattern creation (Run screen), 253, Pivot pattern creation (Run screen), 258 	Open Field Manager. See: <ul style="list-style-type: none"> • Guidance pattern editing (Field Manager), 259 • Boundary editing (Field Manager), 249 	At the Run screen: <p>Adjust during field activities: Guidance pattern adjustment (Run screen), 260</p> At Settings: <p>Set where the beginning of the guidance line begins in relation to the equipment. See Patterns settings, 83</p>

At the **Run** screen, tap  to access the buttons for creating boundaries, guidance lines and headlands and pivots.

Guidance creation buttons

Button	Tap to...
Boundary 	Record the perimeter of a field. You can use boundaries to: <ul style="list-style-type: none"> • Calculate area • Switch implement sections on and off at the edge of the field • Generate end of row warnings See Boundary creation (Run screen), 248 .

Button	Tap to...
Headland 	<p>Record the exterior circuit of a field. Repeat the circuit for multiple headland passes and create an infill pattern.</p> <p>The display uses the implement width to generate the required number of headland circuits, a headland boundary outside of the exterior headland circuit, and an infill boundary inside of the interior headland boundary.</p> <p>See Headland and infill pattern creation (Run screen), 253.</p>
Pivot 	<p>Record the exterior curve of a circular field and repeat the pattern.</p> <p>The display uses the implement width to generate concentric circles. It also creates a pivot field boundary based on the specified distance to the pivot field edge.</p> <p>See Pivot pattern creation (Run screen), 258.</p>
AB Line 	<p>Record a straight line from point A to point B. Parallel guidance lines (or swaths) will be projected multiple times on either side of the AB line.</p> <p>See AB guidance line creation (Run screen), 251.</p>
A+ Line 	<p>Set a straight directional line from point A toward the selected direction (compass direction, path of travel, or heading value). Parallel guidance lines will be projected multiple times on either side of the A+ line.</p> <p>See A+ guidance line creation (Run screen), 252.</p>
Curve 	<p>Record a line with curved and/or straight segments. Matching guidance lines will be projected multiple times on either side of the curved line.</p> <p>See Curved line creation (Run screen), 252.</p>
Set Point A 	<p>Set the starting point of a line.</p>
Set Point B 	<p>Set the end point of a line.</p>
Pause 	<p>Suspend recording while you continue to drive. The display will replace the path you travel while paused with a straight line.</p>

Button	Tap to...
Record 	Begin recording a path as you drive it.
Complete 	Finishes the guidance item you have created and saves it.
Cancel 	Exits the process of creating a guidance item and does not save it.
Compass Point 	Set the heading direction for an A+ line to a compass direction. See A+ guidance line creation (Run screen) , 252.
Use Current Heading 	Set the heading direction for an A+ line based on the vehicle's current position. See A+ guidance line creation (Run screen) , 252.
	Lock the current angle of the vehicle. See A+ guidance line creation (Run screen) , 252.

Boundary creation (*Run screen*)

You can change the point on the implement's swath where you wish to record the boundary's edge:

Right, Center, or Left. To make this change, tap  before you begin driving.

1. Enter the field where you want to create the boundary. (See [Preparing for operation](#), 234.)
2. Tap . The pattern buttons display.

3. Tap .

4. When you are ready to begin your boundary tap  and begin driving the perimeter of the field or area. The display:

- Marks the point where you began recording
- Shows the recorded path with a dashed line





5. Drive around the field until you are near your starting point.

- If Auto-Close is on: When you reach auto-close distance, the display will connect the vehicle's current location to the starting point with a straight line and save the boundary.

- If Auto-Close is off: Drive to the beginning point and tap . The display will connect the vehicle's current location to the starting point with a straight line and save the boundary.

To set the auto close feature, see [Patterns settings, 83](#).

6. When finished, the display makes the boundary you created active, and saves it with a unique name. The distance between swath lines is based on the width of the implement that was used to create the line.

7. To suspend recording while creating the boundary, tap . The display will replace the path you travel while paused with a straight line, from the point where you tapped  to the point where you resume recording. To resume recording, tap  or .

8. To cancel the boundary line creation, tap .

9. To edit any boundary you have created, see [Boundary editing \(Field Manager\), 249](#).

Boundary editing (Field Manager)

1. At the **Home** screen, select the field where you want to edit the boundary. Tap  to open the Field Manager.

Or if you are at the **Run** screen, tap  to open the Field Manager for the field you are currently in.

2. At the Field Manager, tap **BOUNDARIES**.





The map and the Boundaries list show the boundaries in the selected field(s).

The display highlights the active pattern in blue on the map.

For headland boundaries (inner and outer), the list shows the implement type and width used to create each pattern.

3. To select a boundary, tap it on the map or in the list on the left-hand side of the screen.
4. To edit the pattern, use the buttons on the right-hand side of the screen.

Note – The display shows only the options that are suitable for the selected item.

Tap...	To...
Name	Use the on-screen keyboard to rename the selected item.
Resize 	To resize the boundary: <ol style="list-style-type: none"> a. Tap . b. Tap the text box and use the on-screen number pad to enter the distance to move the boundary. c. To shift the boundary outward (making the area larger), tap Expand. d. To shift the boundary inward (making the area smaller), tap Contract to shift the boundary inward (making the area smaller). e. Tap . The display saves a copy of the pattern with a new name at the new position.
Delete 	Remove the selected pattern.

5. To save the changes and close the Field Manager, tap .

For information on: See:

Field Manager [Field Manager, 61](#)

Boundary activation/deactivation (Field Manager)

You can activate or deactivate boundaries in a selected field.

1. At the **Home** screen, select the field where you want to edit the boundary. Tap  to open the Field Manager.

Or if you are at the **Run** screen, tap  to open the Field Manager for the field you are currently in.

2. Tap **BOUNDARIES**.
3. Tap on the boundary in the list on the right-hand side.

4. Tap  (red) to activate an inactive boundary.

5. Tap  (black) to de-activate an active boundary.







For information on: See:

Field Manager [Field Manager, 61](#)

AB guidance line creation (*Run* screen)

With AB lines, you define the start and end points.

Note – *The display uses the implement width to project swaths for the master line. Active lines project swaths in either direction based in the width used to create the line.*

1. Enter the field where you want to create the line. (See [Preparing for operation, 234](#).)
2. Tap . The pattern buttons display.
3. Tap .
4. Tap  to set the beginning of the line. The display:
 - Marks on the map where you tapped .
 - Shows a straight dashed line between the A point and the vehicle's current location.
5. To complete the line and close the controls, tap .
6. To save the line, tap . The distance between swath lines is based on the width of the



implement that was used to create the line.



7. To cancel the AB line creation, tap .

A+ guidance line creation (*Run screen*)



With A+ lines, you define a point on the line and the direction the line is heading.

1. Select a vehicle, implement and field. (See [Select a field, 182.](#))



Note – *The display uses the implement width to project swaths for the master line.*
2. Enter the field where you want to create the line. (See [Preparing for operation, 234.](#))
3. Tap . The pattern buttons display.
4. Tap . The display changes to overhead view if you were in trailing view. The A point is set at the vehicle's current location. The A+ line controls appear in the center of the screen.
5. Select the direction you want for the A+ line.
6. To set the direction of the line, you can do any of the following:





- To use the direction that the vehicle is facing as the heading, tap .
- To use the on-screen number pad to enter an exact heading, tap the number.
- To use a cardinal (N, S, E, W) or ordinal (NE, SE, SW, NW) direction, tap that direction on the compass (.

The display saves the line. The distance between swath lines is based on the width of the implement that was used to create the line.







7. To accept the line and direction and close the controls, tap . The display saves the line. The distance between swath lines is based on the width of the implement that was used to create the line.
8. To cancel the line creation, tap .



Curved line creation (*Run screen*)

1. Enter the field where you want to create the boundary. (See [Preparing for operation, 234.](#))
2. Tap . The pattern buttons display.
3. Tap .

4. When you are ready to begin the line tap . The display:
 - Marks your starting point on the map, at the point where you tapped record.
 - Shows the recorded path with a dashed line between the starting point and the vehicle's current location.
5. To create a straight line as part of your curved line, tap  and then tap  again.
6. When you are at the end of the line, tap .
7. To cancel the line creation, tap .

Headland and infill pattern creation (*Run screen*)

1. Select a vehicle, implement and field. (See [Select a field, 182](#)).
- Note** – *The display uses the implement width to place the headland boundary, space the circuits and project guidance lines for the pattern.*
2. Tap  to enter the field.
 3. Tap . The pattern buttons display.
 4. Tap . The headlands options display.
 5. If the number of circuits is not correct, edit the number you want to create by tapping the number and entering the correct amount.
 6. Optionally, select the type of infill pattern you want by tapping the correct button (AB, A+ or curve).
 7. Tap  and begin driving the perimeter of the field. The display:
 - Marks the position you were at when you tapped record. You can tap  and then  again, as required.
 - Shows the recorded path with a dashed line.
 - The controls for the infill line (if any) appear below the headland recording controls.
 8. If you are using an infill pattern, create the line for your infill pattern. See instructions for the type of line you are creating:



- [AB guidance line creation \(Run screen\), 251](#)
 - [A+ guidance line creation \(Run screen\), 252](#)
 - [Curved line creation \(Run screen\), 252](#)
9. Continue driving around the field until you are near your starting point.
- If Auto-Close is on: When you reach auto-close distance, the display will connect the vehicle's current location to the starting point with a straight line and save the pattern.
 - If Auto-Close is off: Drive to the beginning point and tap . The display will connect the vehicle's current location to the starting point with a straight line and save the pattern.
- To set the auto close feature, see [Patterns settings, 83](#).
10. When finished, the display:
- a. Saves the headland pattern with a unique name (for example, HL01).
 - b. Generates an inner boundary and an outer boundary based on the recorded path and the width of the implement. The headland boundaries are saved with a unique name related to the headland (for example, HL01 inner boundary and HL01 outer boundary).
 - c. Generates an infill swath based on the number of circuits selected and the width of the implement. The infill swath is saved with a unique name related to the headland (for example, DefaultInfillSwath).
11. To cancel the pattern creation, tap .

Infill pattern shift

To shift the infill pattern, complete the following steps.

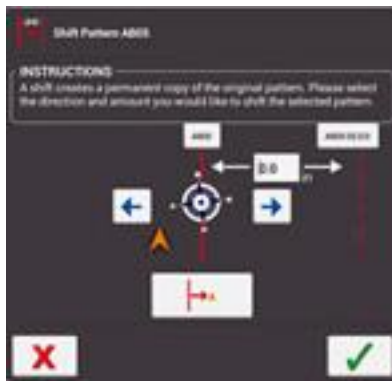
1. At the **Run** screen, open the Field Manager by tapping .
2. Tap **GUIDANCE PATTERNS**.
3. In the list of patterns, tap to select the infill pattern you want to shift, and tap **Activate**.
4. Tap **Shift**. The Shift Pattern tool displays.



5. Tap  to shift the pattern left or tap  to shift the pattern right.
6. In the entry box, enter the distance you want to shift the pattern.
7. Tap  to save the shift.
8. The shifted pattern is saved with a new name.
9. Tap the headland circuit pattern to select it, and tap **Activate**.
10. Tap **Infill**. The Infill Selection list displays.



11. Tap . The All Guidance Lines list displays.



12. Tap to highlight all the infill patterns (including the shifted pattern you just created) you want to associate with the headland pattern you activated.
13. Tap . The Infill Selection list displays again.



14. Highlight the shifted swath and tap .
15. The shifted infill is now activated along with the headland swath.
16. Tap **Boundaries**. Activate the inner headlands boundary.

17. Tap **Exit** to closes the Field Manager.
18. Verify that the shifted infills are now shown and can be used for guidance.

Change the infill pattern

Note – This process assumes you have an existing headland and an infill pattern has been created.

1. Select a vehicle, implement and field. (See [Select a field, 182](#)).

Note – The display uses the implement width to place the headland boundary, space the circuits and project guidance lines for the pattern.

2. Tap    to enter the field.

If you need to create a new infill pattern to change to, go to step 3.

If you have an existing infill pattern you want to change to, go to step 4.

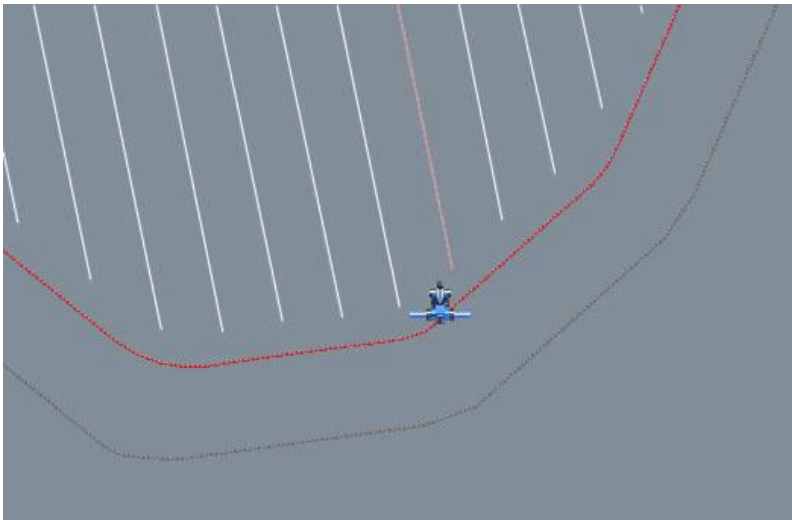

Note – If the system has been turned off, when you enter the field you will only see the headland on the **Run** screen and not the infill pattern.

3. At the **Run** screen, create a new guidance line to use as the infill pattern. (See [AB guidance line creation \(Run screen\), 251](#) or [A+ guidance line creation \(Run screen\), 252](#)).

Note – This new guidance line is automatically made active by the system, which deactivates all other guidance patterns, including the headland you are working with.

4. Open the Field Manager by tapping  .

5. At the **Guidance Patterns** tab:

- a. Highlight the headland circuit pattern you want to work with and tap **Activate**. (This is not necessary if you want to change to an existing line and did not need to create a new one in step 3.)
- b. Tap **Infill**. The Infill Selection list displays. This lists the infill pattern that is currently assigned to use with the headland.



- c. Tap .

The All Guidance Lines list displays. This lists all guidance lines that have been created for this field that are within the headland boundary.



- d. Tap to highlight the guidance lines you want to associate with the headland (including the new guidance line you created in step 3).

Tap . The Infill Selection list displays again.



- e. At the Infill Selection list, highlight the guidance line you want to change to and tap . This assigns the guidance line to the headland.

6. Tap **Boundaries**. In the Boundaries list on the left-hand side, tap the inner boundary of the headland, then tap **Activate**.







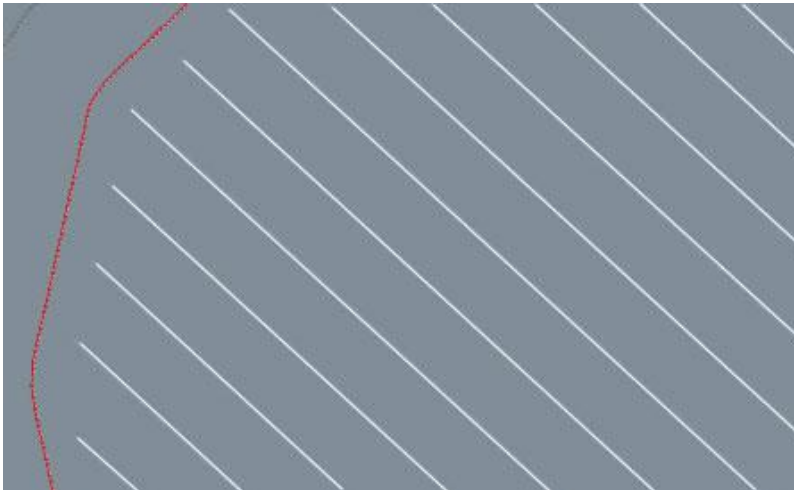

- Exit the Field Manager by tapping **Exit**.

The new infill pattern will show in the inner boundary of the headland.





Pivot pattern creation (*Run screen*)

- Enter the field where you want to create the pivot. (See [Preparing for operation, 234.](#))
- Tap . The pattern buttons display.
- Tap .
- Tap  and begin driving the outer perimeter of the field. The display:
 - Marks your starting point on the map, at the vehicle's location when you tapped record.
 - Shows the recorded path with a dashed line.
- Drive at least 50 feet on an outer tower rut and then tap .
- Enter the distance to the Pivot Field Edge and tap .
- When finished, the display:
 - Saves the pivot pattern with a unique name (for example, P01).
 - Generates a pivot boundary based on the recorded path and the width of the implement. The pivot boundary is saved with a unique name related to the headland (for example, P01 Boundary).
 - Makes the pivot boundary active.

8. To cancel the pivot creation, tap .

Guidance pattern editing (Field Manager)

1. At the **Home** screen, select the field where you want to edit the boundary. Tap  to open the Field Manager.

Or if you are at the **Run** screen, tap  to open the Field Manager for the field you are currently in.

2. Tap **GUIDANCE PATTERNS**. The map and the Patterns list show the patterns in the selected field.
3. Tap the pattern you want to edit.

The pattern must be active before you can edit it. If the pattern is not active, tap  (red) to make it active.

4. The display highlights the active pattern in blue on the map.
5. If you have chosen a headland, you can change the number of circuits in a headland.

6. Tap  to resize the pattern you have chosen.

Or for a pivot pattern, tap .

7. Edit the size of the pattern and tap .
8. To cancel the change, tap **X**.

9. To exit Field Manager, tap .

For information on: See:



Field Manager [Field Manager, 61](#)

Pattern activation/deactivation (Field Manager)



You can activate or deactivate patterns in a selected field. To engage your auto guidance system on a line, pattern or headland, it must be active.



1. Tap  to open the Field Manager. Field Manager opens to the Field Overview section.
2. Tap **GUIDANCE PATTERNS**.
3. Tap on the line, headland or pivot area in the list on the right-hand side.
4. To activate:

- An inactive pattern, tap  (red).
- An inactive guidance line, tap  (red).

5. To de-activate:

- An active pattern, tap  (black).
- An active guidance line, tap  (black).

For information on: See:

Field Manager [Field Manager, 61](#)

Guidance pattern adjustment (*Run* screen)

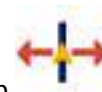

To adjust guidance while performing field activities, at the **Run** screen, tap .

The system displays the guidance adjustment buttons.

Note – These adjustments are called "temporary" because they are not stored in the system. After reboot or power off, the system returns to the original settings.

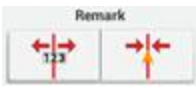
Button	Use to...
Nudge 	Moves the position of the vehicle in a perpendicular direction (left or right) to the line you are engaged on currently. To adjust the size of the increments, see Steering and guidance settings, 85 .
Remark 	Temporarily move the line or pattern to the vehicle's current location or the value entered by you.



Button	Use to...
Implement Draft Correction 	Temporarily adjust the implement incrementally to the right or to the left by tapping the arrows. The value is reset when a new task is started or the display is powered off. The value in the middle indicates the amount the implement has been corrected. To adjust the size of the increments, see Steering and guidance settings, 85 .

Guidance pattern shifting (Field Manager)

- At the **Home** screen, select the field where you want to edit the boundary. Tap  to open the Field Manager.

Or if you are at the **Run** screen, tap  to open the Field Manager for the field you are currently in.

- Tap **GUIDANCE PATTERNS**.

- Tap the pattern you want to edit. If the selected pattern is active, tap  (black) to make it inactive. If the selected pattern is not active, tap  (red) to make it active.

Note – If you activate a pattern that was created with a different implement width, the display will prompt you to shift the line for the new width or keep the original position.

- If you have chosen a headland, you can change the number of circuits in a headland.





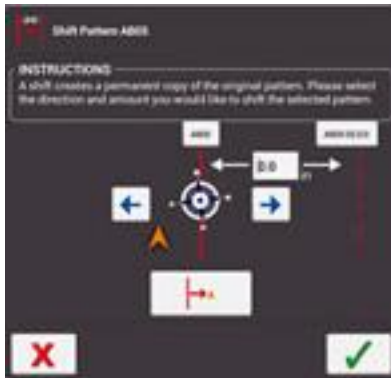

5. Tap . The Shift Pattern tool displays.



6. Tap the left or right arrow to indicate the direction you want to shift the pattern.



7. Tap  to shift the pattern to the vehicle's current position, or you can enter the amount you want to shift the pattern.
8. To make the change, tap . The system creates a copy of the original pattern with the shift change.
9. To cancel the change, tap .
10. To exit Field Manager, tap .

Landmarks





When you are in the **Run** screen, you can place field items in the field, including:

- Lines, such as fences
- Points, such as trees
- Areas, such as ponds





After you have created landmarks, you can edit them and assign them to categories using Field Manager. See [Landmark editing \(Field Manager\), 265](#).

At the **Run** screen, tap  to access the controls for creating landmark points, lines and areas.







Landmark buttons

Button	Tap to...
Point 	Place a point indicator on the field map marking a point. Available types: <ul style="list-style-type: none"> • Generic (such as a gate, riser, tile inlet, water trough, well) • Rock • Pest (insects, weeds) • Obstacle (hole, tree, hazard)
Line 	Record a line marking a landmark. Available types: <ul style="list-style-type: none"> • Generic (such as border, drip tape, gate, path, road) • Obstacle (cable, ditch, fence, hazard, pipe, river, stream, terrace, trees)
Area 	Record a shape marking a landmark. Area landmarks are not used to switch sections on and off. Available types: <ul style="list-style-type: none"> • Generic • Pest • Obstacle
Non-Productive Area 	Record a shape marking a landmark. Non-productive area landmarks can be used to switch sections on and off. Available types: <ul style="list-style-type: none"> • Generic (such as clover, exclusion, grassed waterway, slough, waterway) • Obstacle (hazard, hole, lagoon, pond, rocks, tree) • Pest (disease, weed)

Landmark point creation (*Run* screen)

1. Select a vehicle, implement and field. (See [Select a field, 182.](#))
2. Tap  to enter the field.
3. Tap .
4. Tap . The display places a marker at the vehicle's current location, based on the recording point.
5. To edit or rename landmarks you have already created, go to Field Manager. For instructions, see [Field Manager, 61.](#)
6. To record a different type of landmark by default, or to change the point on the vehicle/implement used to indicate the location of the landmark, tap **Change landmark settings**. For instructions, see
7. To close the landmark buttons, tap .

Landmark line creation (*Run* screen)

1. Select a vehicle, implement and field. (See [Select a field, 182.](#))
2. Tap  to enter the field.
3. Tap .
4. Tap the line button .
5. Tap . The display draws a dashed line beginning at the vehicle's current location, based on the recording point.
6. Drive to the end of the line you want to record and then tap  again.
7. To discard a path that is being recorded but has not been saved, tap . The path recorded so far is not saved.
8. To start over, tap the button for the feature again.
9. To edit or rename landmarks you have already created, go to the Field Manager. For more information, see [Field Manager, 61.](#)

- To record a different type of landmark by default, or to change the point on the vehicle/implement used to indicate the location of the landmark, tap **Change landmark settings**. For more information, see .

- To close the landmark buttons, tap .

Landmark area creation (*Run* screen)

Follow the steps below to create a productive or non-productive area. Non-productive areas can be used to switch sections off when you use section control.

- Select a vehicle, implement and field. (See [Select a field, 182.](#))

- Tap  to enter the field.

- Tap .

- Tap  or .

- Tap the record button . The display places a marker at the vehicle's current location, based on the recording point.

- Drive around the area you want to record and then tap the record button again.

- To close the landmark controls, tap .

- To discard the recorded path and close the controls, tap . The path recorded so far is not saved.

- To start over, tap the button for the feature again.

- To edit or rename landmarks you have already created, see [Landmark editing \(Field Manager\), 265.](#)



- To record a different type of landmark by default, or to change the point on the vehicle/implement used to indicate the location of the landmark, see .

Landmark editing (Field Manager)

At the Field Manager, you can edit any landmarks you have created in the **Run** screen.

1. Open the Field Manager. (See [Field Manager, 61.](#))
2. Tap **Landmarks**. The map and the Landmarks list show recorded landmark items including:
 - Points
 - Lines
 - Areas
 - Non-productive areas
3. To select a landmark, tap it on the map or in the list on the left-hand side of the screen.
4. Use the buttons on the right-hand side of the screen to edit the landmark.

Note – The display shows only the options that are suitable for the selected item.

Tap...	To...
Name	Rename the selected item.
Category 	Change the classification of a point, line or area landmark. Options are: <ul style="list-style-type: none"> • Generic • Obstacle <p>Note – To identify a point more specifically, change the name of the point.</p>
Convert 	Tap to: <ul style="list-style-type: none"> • Change an area to a non-productive area. • Change a non-productive area to an area.
Delete 	Remove the selected landmark from the display.

5. To exit Field Manager, tap  .

Layers

The following map layers for coverage are recorded for each task:

- Coverage Overlap
- Speed
- Height
- GPS Quality
- Offline Distance
- Guidance Engaged
- Applied Rate

You can view and edit layers. See:

- [View coverage layers, 267](#)
- [Edit a coverage layer, 268](#)

View coverage layers

To view a layer of coverage during field operations:

1. Make sure you are logging coverage. You will see the coverage in the **Run** screen behind your implement if coverage logging is on.

To turn on coverage logging, tap . Or, if you already have automatic coverage logging when you engage, tap the engage button.

See [Mapping settings, 83](#) to set automatic coverage logging.

2. Tap .
3. The current layer being shown slides out to the right.



4. To change the type of layer, tap the current layer button (at the top). The list of Available Layers displays.



5. Tap the layer you want to see on screen.

Edit a coverage layer

To edit a coverage layer:

1. Tap  .
2. The current layer being shown slides out to the right.





3. Tap the current layer button (at the top). The list of Available Layers displays.



4. Tap  button. The edit panel for available layers displays.



5. Change the settings of the layer to better meet your needs:
- Auto scale
 - Steps
 - Color scheme
6. Tap  to save your changes or  to cancel your changes.

Field-IQ system operations

For the Field-IQ system, the following equipment and tools may be used:

- [Field-IQ system Master Switch Box, 270](#)
- [Section control, 273](#)
- [Rate control adjustments, 274](#)
- [Boom height control operation, 276](#)
- [Boom height adjustments, 278](#)

Field-IQ system Master Switch Box



Note – All Field-IQ systems must have a Field-IQ master switch box.

Item	Description	Tap here to ...
1	Increase/decrease switch	Increases the applied amount by a set amount (the amount set when you add a material). See Add a material, 227 .
2	Rate switch	Choose to use preset Rate 1, preset Rate 2, or Manual rate.
3	LED indicator	<ul style="list-style-type: none"> • Red: Unit is powered but not communicating with the display. • Green: Unit is powered and communicating with the display. • Yellow: Unit is initializing communications with the display.

Item	Description	Tap here to ...
4	Automatic/Manual section switch	<ul style="list-style-type: none"> Automatic mode: The display automatically opens and closes sections when entering areas of overlap, non-apply zones, or crossing boundaries. Manual mode: The sections are controlled manually, bypassing the display. <p>Note – You can switch from Automatic to Manual mode while traveling.</p>
5	Master switch	<p>A: Jump start (top position)</p> <p>The sections and rate are ready to be commanded by the display, and the system is overridden to use a preset control speed (the speed is set in the implement setup). Use the jump start function if you lose a GNSS signal or you want to start applying before your implement is up to speed.</p> <p>B: On (middle position)</p> <p>The sections and rate are ready to be commanded by the display.</p> <p>C: Off (lower position)</p> <p>Sections are closed and rate is set to zero.</p>

Field-IQ 12-section switch box



Only one section switch box can be used on each system. Each section switch is automatically assigned to the corresponding module. The modules are read from left to right. For example, switch 1 assigns to the module furthest on the left when standing behind the implement.

Relation to master switch box

The section switches have different functions, depending upon the status of the master Automatic/Manual section switch on the master switch box.

Automatic mode: When the Automatic/Manual section switch of the master switch box is in the automatic mode:

- If the section switch is in the on/up position the section(s) assigned to it are commanded automatically by the display.

- If the section switch is in the off/down position the section(s) assigned to it are commanded to be off.

Manual mode: When the Automatic/Manual section switch of the master switch box is in the manual mode:

- If the section switch is in the on/up position, the section(s) assigned to it are commanded to be on. This overrides the display and coverage logging is ignored.
- If the section switch is in the off/down position, the section(s) assigned to it are commanded to be off. This overrides the display and coverage logging is ignored.

LED status indicators

The LED has the following status indicators:



- Green: The unit is powered and is communicating with the display.
- Yellow: The unit is initializing communications with the display.
- Red: The unit is powered but not communicating with the display.

Section control

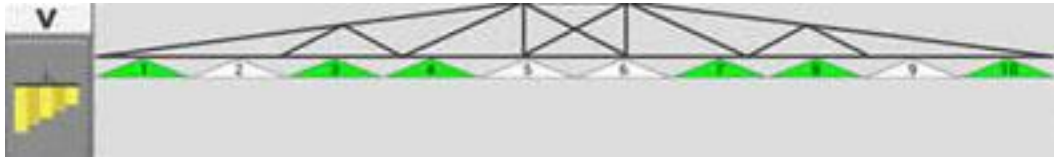
When you are spraying, you can view an on-screen representation (widget) of the output at the bottom of the **Run** screen. This indicates the sections you have turned on using a switch box.









Buttons and indicators

Button or indicator	Explanation
	Collapse the display of the widget.
	Switch to the boom height widget, if applicable.
	Shows spray section. Color indicates status: <ul style="list-style-type: none"> • Grey: Section was automatically shut off as a result of coverage overlap, existing a boundary or entering a non-productive area. • White: Section was shut off manually with the switch box. • Green: Section is on. • Yellow: Section is on but is not sending feedback to the system or is not meeting some requirements (such as a liquid channel not seeing adequate flow or speed).. • Red: Section has a failure or warning.

For information on:	See:
Using switch boxes	Field-IQ system Master Switch Box, 270
Diagnostics	Field-IQ diagnostics, 311
Settings	Boom height control, 210 , Section control, 198

Rate control adjustments

To adjust rate control while performing field activities, at the **Run** screen, tap . The rate control adjustment buttons display.

Button/Indicator	Description
	<p>Heading: Contains the name you assigned to the control channel. The background color of the heading indicates the state of the channel:</p> <ul style="list-style-type: none"> • Green: Channel is functioning. Field-IQ master switch is on. • Red: Channel is not functioning due to fault or failure. • Grey: Channel is shut off or disabled. Field-IQ master switch is off. <p>Actual: Indicates the actual rate being applied and the units.</p> <p>Target 1: Indicates the target rate and the units.</p> <p>Note – When you tap this widget, it displays more detail.</p>
<p>Actual Rate</p> 	<p>Indicates the actual units (gallons or liters) being applied.</p>
<p>Target Rate</p> 	<p>Indicates the target number of units per acre.</p> <p>The bold indicator is the rate that is active.</p> <ul style="list-style-type: none"> • 1: Target for rate 1. • 2: Target for rate 2. • M: Manual target rate • Rx: Use a prescription (does not display unless a prescription is loaded)
<p>Sensors</p> 	<p>Indicates the amount of flow through the system in gallons or liters per minute.</p>
<p>Material Control</p> 	<p>Tap this button to shut down the channel. If valve locking is enabled, tapping this button will shut the section and valve together.</p>

Button/Indicator	Description
Virtual Tank 	Visually indicates the amount of material remaining. Tap the refill tank button to launch the Refill Tank tool. Area to empty: The number of acres or hectares left before there is no more material to apply.
Refill tank tool	Tap the appropriate button based on the amount you have refilled the tank.

For information on: See:

Using switch boxes	Field-IQ system Master Switch Box, 270
Diagnostics	Field-IQ diagnostics, 311
Settings	Rate control, 202 , Virtual tank/bin, 206
Prescriptions	Prescriptions Manager, 66 , Importing prescriptions, 223



Boom height control operation

If you have boom height control set up, you can view, enable and engage sections of the boom. The boom height widget includes indicators and indicator/controls. The process of using the boom height control is:

1. Enable the boom section(s). This readies the section(s) to be engaged.
2. Engage the boom section(s). The boom height control is engaged.





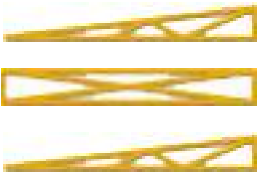

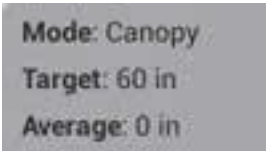
Buttons and indicators



Button/Indicator	Explanation
	Tap to collapse the display of the widget.
	Tap to switch to the rate control widget, if applicable.
	Tap to select the section to engage or disengage. Color indicates state of system: <ul style="list-style-type: none"> • Grey: The boom section cannot be enabled or engaged. Indicator only. • Red: System failure or warning/cannot enable or engage the boom section. Indicator only. • Yellow: The boom section is ready to engage. Indicator and button. Can be tapped to engage. • Green: The boom section is enabled and engaged. Indicator and button. Can be tapped to disengage and return the state to enabled.
Enable All	Tap to select all boom sections to enable or disable them.

Button/Indicator	Explanation
 <p>(red)</p> <p>Cannot Engage</p>	<p>Red background: Indicator only. Cannot engage the boom(s) to adjust boom height of the enabled sections.</p>
 <p>(yellow)</p> <p>Ready to Engage</p>	<p>Yellow background: Ready to engage the boom(s) adjust the sections of the boom you have selected. Tap to engage the boom.</p>
 <p>(green)</p> <p>Engaged</p>	<p>Green background: Indicates the sections of the boom you have selected are engaged. Tap to disengage the boom.</p>
 <p>(gray)</p> <p>Disabled</p>	<p>Grey background: Indicator only. Boom(s) cannot be engaged because the boom system is disabled.</p>
<p>26 IN </p>	<p>Shows the number of inches the boom is above or below the target height using arrows and color:</p> <ul style="list-style-type: none"> • One green arrow: Slightly above/below target height • Two yellow arrows: Somewhat above/below target height • Three red arrows: Significantly above/below target height
	<p>Shows the:</p> <ul style="list-style-type: none"> • Mode • Target height • Average height of all boom sections

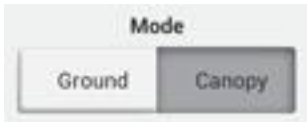
Boom height adjustments

To adjust boom height while performing field activities, at the **Run** screen, tap . The boom height adjustment buttons display.

Button/Indicator	Description
Target Height 	Increase or decrease height of boom by using plus or minus signs. Or enter the value by tapping on the number Tap Set Target to Average to set the target height to an average.
System Aggressiveness 	Increase or decrease the aggressiveness of lowering or raising the boom by tapping the plus or minus signs. Or enter the value by tapping on the number and entering a different number.
Mode 	Tap either Ground or Canopy to change the mode.
	Tap to see more detail on boom height control.

Button/Indicator	Description
<p>Boom Height Controls</p>  <p>The screenshot shows a screen titled "BOOM HEIGHT CONTROLS". It is divided into two sections: "SENSORS" and "VALVE COMMAND". Under "SENSORS", there are six rows: "Left Outer: Enabled", "Left Inner: Enabled", "Center: Enabled", "Right Inner: Enabled", and "Right Outer: Enabled". Under "VALVE COMMAND", there are three rows: "Left: 0", "Center: 0", and "Right: 0". A blue circular arrow icon is at the bottom of the screen.</p>	<p>Sensors: Indicates all sensors and their status (enabled, disabled). (Display only)</p> <p>Valve Command: Indicates the percentage of command used for each valve. Should a boom section fail, begin troubleshooting here.</p>
	<p>Tap to return to main boom height adjustment controls.</p>

For information on: See:	
Setting up boom height	Boom height control, 210
Diagnostics	Boom Height Diagnostics, 300

Prescriptions



At the **Run** screen, tap  to open the Prescriptions Manager. You can use the Prescriptions Manager to assign a prescription to a channel.





For information on:	See:
Prescriptions Manager	Prescriptions Manager, 66
Import prescriptions	Importing prescriptions, 223
Export prescriptions	Exporting prescriptions, 223
Assign a prescription	Assign a prescription, 280
Use a prescription	Use a prescription, 281





Assign a prescription

Before you can assign a prescription, you must:

- Have a field selected
- Have a channel set up

To assign a prescription:

1. Make sure you have a field selected.
2. At the **Run** screen, tap . The Prescriptions Manager displays.
3. In the Enabled Channels list on the left, tap the channel you want to assign the prescription to.
4. On the right, tap Prescription File Name. The XCN-2050 display displays a list of prescription files that are available for the field you selected.
5. Tap the prescription file you want and tap .
6. Tap **Next**.
7. Tap Column Name. The list of column names displays.
8. Tap the column you want to use, then tap .
9. Tap Column Units, then tap either gal/a or L/ha. Tap .
10. Tap **Next**.
11. Optionally, tap Lead Time and enter the number of seconds (0 - 10). Tap .

12. Tap **When outside Prescription** and tap one of the following: **Close**, **Last Rate** or **Default Rate**. Tap .
13. Tap **Default Rate** and enter the rate. Tap .
14. If you have completed the information, tap **Finish**.
15. If you need to change previous information, tap **Back**.
16. To save your entries, tap .
17. To discard your entries, tap .



For information on:	See:
Prescriptions Manager	Prescriptions Manager, 66
Importing prescriptions	Importing prescriptions, 223
Exporting prescriptions	Exporting prescriptions, 223
Use a prescription	Use a prescription, 281

Use a prescription

Before you can use a prescription, you must:

- Have a field selected
- Assign the prescription to a channel

To use a prescription, complete the following steps.

1. Make sure you have a field selected.
2. At the **Run** screen, tap . The rate control adjustment buttons display.
3. To begin using the prescription, tap . The other (buttons?) will become gray and cannot be tapped unless you stop using the prescription.
4. To stop using the prescription, tap .

For information on:	See:
Prescriptions Manager	Prescriptions Manager, 66
Import prescriptions	Importing prescriptions, 223
Export prescriptions	Exporting prescriptions, 223
Assign a prescription	Assign a prescription, 280

ISOBUS

To control ISO-certified implements, you can use:

- Task Controller: An optional feature that enables the XCN-2050 display to control the implement and log data. See [Task Controller operation, 282](#).
- Virtual Terminal: A means of controlling the implement through the Virtual Terminal. No data is logged. See [Virtual Terminal operation, 284](#).

Task Controller operation

Note – To use Task Controller, you must have unlocked the feature with a valid password, turned on the feature in the display settings, and be connected to an ISO-certified implement that is set up. (See [Feature unlocks, 81](#) and [ISOBUS settings, 87](#).)

At the **Run** screen, the ISOBUS widget displays when the following steps are completed:

1. Task Controller is turned on in the display settings (see [ISOBUS settings, 87](#)).
2. The ISO-certified implement is connected and you have set it up with an application channel that is controlled by Task Controller (see [ISOBUS for implements, 191](#)).





You can use the ISOBUS widget to switch between using Task Controller and Virtual Terminal.

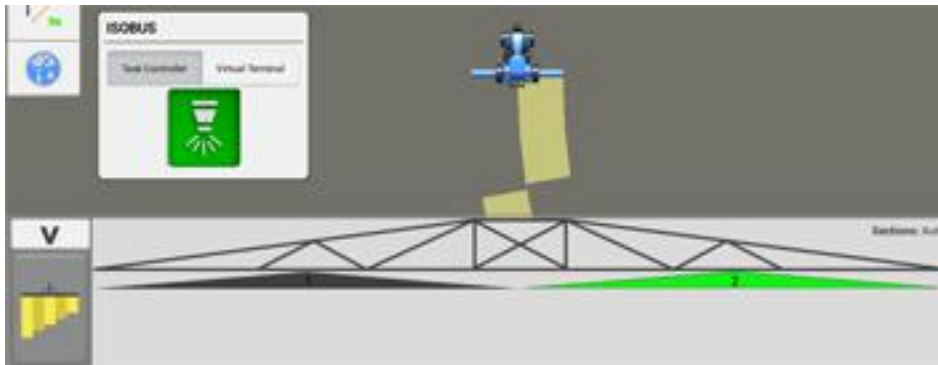

- When you tap **Task Controller**:
 - The XCN-2050 display can receive Task Controller information from the implement's ECU. This enables you to control the implement's operation with the XCN-2050 display.
 - You can use the Rate Control and Section Control feature on the XCN-2050 display (see [Field-IQ system operations, 270](#)).
 -  acts as an on-screen master switch button.
- When you tap **Virtual Terminal**, Task Controller signals are not sent to the XCN-2050 display. To access Virtual Terminal, access the Virtual Terminal window. See [Virtual Terminal operation, 284](#).

On-screen Task Controller switch

To begin operation with Task Controller, tap  (yellow). The button changes to  (green), indicating the XCN-2050 display is controlling the application.



Button status	Explanation
 (Gray)	<p>The XCN-2050 display is not able to start application control with the Task Controller because of an issue with the setup. You cannot tap this button. It is a status indicator only.</p> <p>To troubleshoot, verify:</p> <ul style="list-style-type: none"> • Task Controller is on in the display settings (See ISOBUS settings, 87). • The implement setup includes the correct ECU which has been assigned to the channel (see ISOBUS for implements, 191). • The implement is selected (see Select an implement, 189). • Task Controller is selected in the ISOBUS widget.

Button status	Explanation
 (Red)	<p>The XCN-2050 display is not able to begin operation with the Task Controller. You cannot tap this button. It is a status indicator only. To troubleshoot:</p> <ul style="list-style-type: none"> • Check the physical connections from the implement to the display. • Check that all settings are correct in the Virtual Terminal of the implement, including an "on" or "stand by command." (For more information, see the <i>Getting Started Guide for ISO for the XCN-2050 display</i>.) <p>Note – If you have a master switch box or joystick and its master switch is off, no application will occur. To use Task Controller with one of these, make sure the physical master switch or stand by command is on.</p>
 (Yellow)	<p>The connection is secure and the XCN-2050 display can receive information for Task Controller.</p> <p>Tap the button to use the Task Controller and have the XCN-2050 display control the application.</p>
 (Green)	<p>Indicates the XCN-2050 display is currently controlling the application. If you have Field-IQ Section Control for spraying, this feature will control the application of the material (see Field-IQ system operations, 270).</p> <p>Tap to stop using the Task Controller and stop the XCN-2050 display from controlling the application.</p> <p>Note – Currently, the Prescriptions feature is not available for use with Task Controller.</p> <p>The task data recorded will be the same as if you were using Field-IQ to control the application (see Tasks, 238).</p>

Virtual Terminal operation

To use Virtual Terminal:

1. Make sure an ISO-certified implement is connected and that you have turned on the Virtual Terminal feature in settings (see [ISOBUS settings, 87](#)).
2. At the **Run** screen on the ISOBUS widget, tap **VT**. The widget displays in a smaller version which only shows data and does not allow you to control the implement.



To increase the size of the minimized Virtual Terminal widget, touch the upper right corner of the widget and hold. Arrows display on all sides of the widget. Touch and drag an arrow to increase the widget's size.

3. Tap the upper right corner of the Virtual Terminal widget to maximize it. The Virtual Terminal expands to full screen.

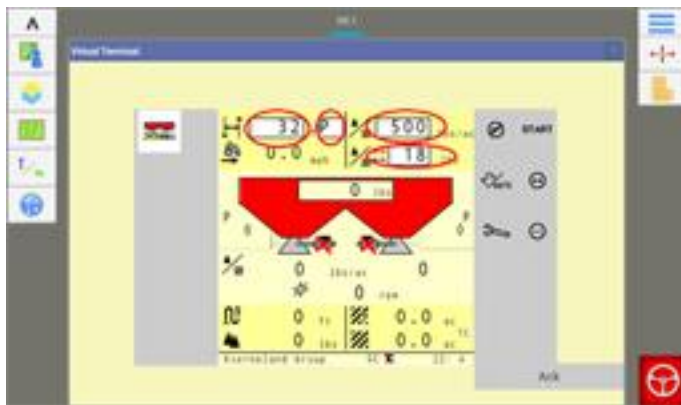

At the full-screen view, you can control the implement using Virtual Terminal.

4. To minimize Virtual Terminal to only show data, tap the upper right corner.

Delete previous data

Data loaded from previously used ECUs will take up storage space. To remove this data from the XCN-2050 display:

1. At the maximized Virtual Terminal, tap .
2. Tap **Delete**.
3. All previous data is removed.

On-screen widgets

Widgets are software gadgets on the screen that can provide functionality control, information and status on the **Run** screen during field activities.

There are two types of widgets:

- Status widgets: Provide information only and do not control any function
- Control widgets: Enable you to control a function, and may include status information

For some widgets, you can choose to display or not display them.

Other widgets display when you are performing a specific task, such as operating with the Task Controller (see [Task Controller operation, 282.](#))

Access widgets

To access the list of widgets available on your XCN-2050 display:

1. At the **Run** screen, tap .
2. To display all widgets, tap **Add All Widgets**.
3. To remove all widgets, tap **Remove All Widgets**.

Minimize/maximize, resize

Some widgets can be maximized from their normal minimized size. To maximize a widget, tap the upper right corner of the widget. To make it smaller, tap the same upper right corner.

Other widgets can be re-sized to a customized size. To make a widget larger, touch the upper right corner of the widget and hold. Arrows display on all sides of the widget. Touch and drag one of the arrows to resize. When you are satisfied with the size, remove your finger. The following widgets can be re-sized:

- [Position status, 289](#): On-screen lightbar, compass, digital compass and swath number
- [Speed status, 290](#)
- [Virtual Terminal widget, 290](#)

Move a widget

You can position some widgets on the screen where it makes sense for you. The position on the screen where you have chosen to display each widget is saved and associated with your user profile. That way, the next time you use the display, the widgets are where you previously placed them.

To move a status widget around on the screen:

1. Touch the widget and keep your finger on the screen.
2. Drag the widget with your finger. A grid displays on the screen.
3. After you have moved the widget where you want it, remove your finger.

Remove a widget

To remove a widget from the **Run** screen:

1. Touch the widget and keep your finger on the screen. A grid displays on the screen.
2. Drag the widget with your finger to the upper right corner. A trash can icon with the word "Remove" will display.



3. Drag the widget onto the trash can. You will no longer see the widget on the screen.

Area status

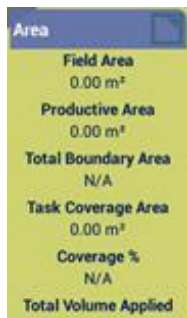

Area	
Field Area	0.00 m ²
Productive Area	0.00 m ²
Total Boundary Area	N/A
Task Coverage Area	0.00 m ²
Coverage %	N/A
Total Volume Applied	



Area status:

- Area of the field
- Productive area: Total field area minus the unproductive areas
- Total boundary area: Total of the area within the active boundaries of the field
- Task coverage area: The amount of coverage in the field
- Percent of coverage: The amount of coverage over the productive area multiplied by 100
- Total volume applied

ISOBUS Task Controller widget



You can move this widget around on the screen.

Button	Explanation
Task Controller	Switches to Task Controller. See Task Controller operation, 282 .
Virtual Terminal	Switches off access to Task Controller. See Virtual Terminal operation, 284 and Virtual Terminal widget, 290 .
	The XCN-2050 display is not able to start application control with the Task Controller because of an issue with the setup.
(Gray)	
	The XCN-2050 display is not able to begin operation with the Task Controller.
(Red)	
	The connection is secure and the XCN-2050 display can receive information for Task Controller.
(Yellow)	

Button	Explanation
 <p>(Green)</p>	<p>If you have Field-IQ Section Control for spraying, Task Controller will control the application of the material (see Field-IQ system operations, 270).</p>

Position status

The following status widgets on the **Run** screen indicate your position.

On-screen lightbar for auto guidance



The on-screen lightbar provides the status of where the vehicle is in relation to the guidance line. When the vehicle is perfectly on the guidance line, the value in the center is 0 and the background color is green.

The center of the lightbar represents your position. As your vehicle's position moves farther from the line, the farther the highlighted arrows will be from the center of the light bar.

As the vehicle moves farther from the guidance line, the numerical indicator shows the distance from the guidance line and the highlight color changes from green, to yellow, to red.

Position

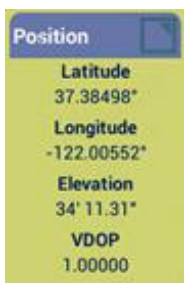

Your current position's:

- Latitude
- Longitude
- Elevation
- VDOP

Compass



The direction in which you are traveling.

Digital compass

A green square widget displaying the text "28.5°" in white.

The degrees of the angle you are traveling.

Swath number

A green square widget displaying the text "Swath 0" in white.

The number of the swath guidance line you are currently following.

Speed status

The speed status widget indicates the speed at which you are traveling.

A green square widget displaying the text "0.0 mph" in white.

The speed at which you are traveling.

Virtual Terminal widget

When using Virtual Terminal, initially the minimized version displays on the **Run** screen.



You can move this widget around on the screen.

To increase the size of the minimized VT widget, touch the upper right corner of the widget and hold. Arrows display on all sides of the widget. Touch and drag an arrow to increase the widget's size.

At the full-screen view of Virtual Terminal, you can control the implement using Virtual Terminal.



Alerts and warnings

The XCN-2050 display will display warnings and alerts, depending on your features and the situation. For example, warnings and alerts will display regarding:

- Loss of GNSS coverage
- Using auto guidance and:
 - The vehicle is approaching a tight turns or the end of a row
 - The system detects the steering wheel is being used
- A lack of interaction with the display after a specific amount of time

This list is not comprehensive, rather a few examples of alerts and warnings.

End of row warning

If your Autopilot system is on and following a guidance line, when you begin approaching the end of a row, an End of Row warning displays.



For information on: See:

Settings

[Steering and guidance settings, 85](#)

Tight turn warning

If you are using an auto guidance system, when you are approaching a tight turn, the system displays a tight turn warning.



To customize your settings for tight turn warnings (including the angle of the turn and how soon the warning displays before the turn), see [Patterns settings, 83](#).

Diagnostics / troubleshooting





In this chapter:

Diagnostics	294
XCN-2050 display	295
Autopilot system diagnostics	296
Boom Height Diagnostics	300
DCM-300 modem status	302
EZ-Pilot system diagnostics	303
DCM-300 modem diagnostics	305
EZ-Steer system diagnostics	307
Field-IQ diagnostics	311
GNSS and xFill technology status	315
GNSS diagnostics	317
Office Sync Diagnostics	321
ISOBUS diagnostics	323
System diagnostics	324
Remote Assistant	325
TM-200 Module diagnostics	326

This chapter covers information about the status of equipment and services, as well as troubleshooting and diagnostics information.

Diagnostics

You can access Diagnostics in either of the following ways:

- Tap  at the **Home** or **Run** screen. The main menu displays. Tap .
- Tap the right-hand side of the display bar. When the popup notification list displays, tap . The main menu displays. Tap .

Diagnostics has two sections:

- The left side menu lists products and services active on the display.
- The right side shows information about the item you selected on the menu.

Tap the menu items on the left-hand side of the screen to access the diagnostic sections you want to view.

XCN-2050 display

This section describes some possible issues with the XCN-2050 display, possible causes, and how to solve them. Please read this section before you contact technical support.

The display does not turn on.

Possible cause	Solution
External power is too low.	Check: <ul style="list-style-type: none">• The charge on the external power supply• The fuse if applicable If required, replace the battery.
Internal power is too low.	Check the charge on the internal batteries and replace if required. Ensure battery contacts are clean.
External power is not properly connected.	Check: <ul style="list-style-type: none">• That all power connections are seated properly• For any broken or bent pins
There is a faulty external power cable.	Try a different cable. Check pin outs with a multimeter to ensure internal wiring is intact.

The display is not responsive.

1. Hold down the power button for 20 seconds.
2. After the display has shut down, press the power button again to power on the display.

The map is not visible on the *Home* screen.

If your system has a DCM-300 modem and has no map on the **Home** screen, check for:

- Possible cable disconnection
- Weak signal bars (see [DCM-300 modem diagnostics, 305](#))
- All cables are connected securely
- The status of GNSS (see [GNSS notification button, 52](#) and [GNSS diagnostics, 317](#))

Autopilot system diagnostics

You can use diagnostics for AutoPilot to:

- View the degree of the steering angle being given by the navigation controller and the actual degree of angle.
- Calibrate:
 - Manual override sensitivity
 - Vehicle system aggressiveness
 - Line approach aggressiveness
 - Engage aggressiveness
 - Proportional steering gain (P gain)
 - Roll calibration
 - Make incremental adjustments to a pattern using the nudge increment tool
- View:
 - Vehicle roll and yaw
 - Navigation controller orientation
 - IMU parameters
 - Sensor settings
- Set the Nav Controller II to output NMEA messages.

Steering performance for Autopilot system

1. At the Diagnostics panel, tap **Performance** under Autopilot.
2. Tap **Steering**.



Button/Control	Explanation
System Feedback, Angle Desired	The degree of the steering angle command being given by the navigation controller.
System Feedback, Angle Actual	The degree of the steering angle that is actually occurring.
Vehicle System Aggressiveness	How aggressively the vehicle responds to cross track error.
Line Approach Aggressiveness	Controls how fast the guidance system attempts to steer the vehicle onto the current guidance line. See Line acquisition, 165 for more information on calibrating.
Engage Aggressiveness	Controls how aggressively the vehicle initially engages the automatic guidance system. See Engage aggressiveness, 166 for more information on calibrating.
P Gain	Balances rapid steering response and stability. See Proportional steering gain, 160 for more information on calibrating. Note – This setting is not available for certain vehicle types.
Nudge Increment	This function is for advanced users to test the systems response to cross track error. While driving the vehicle online, tap the left or right button to move the line. Observe the response of the guidance system and adjust as necessary.
Engage	Use to engage the system in the diagnostics screen. For more information on the engage button, see Vehicle operation, 242 .



Sensor performance for Autopilot system

1. At the Diagnostics panel, tap **Performance** under Autopilot.
2. Tap **Sensors**.

Button/Control	Explanation
VEHICLE ORIENTATION	Graphically indicates the roll and yaw settings. The yaw value is the heading error for the system in reference to the heading of the guidance swath.
CONTROLLER ORIENTATION	Orientation of the controller as entered by the user.
MANUAL OVERRIDE SENSITIVITY	Sets the level the voltage must reach before the guidance system disengages. The voltage must also drop below that level before automated steering can be engaged again. You can calibrate this control here or at the Vehicle setup panel. For instructions, see Manual override sensitivity calibration, 153 .
IMU PARAMETERS	The raw voltage reading from the accelerometer and gyroscopes in the navigation controller.
SENSORS	The raw voltage of all connected sensors.

NMEA messages

Before you can setup NMEA output, you must turn on NMEA capability in settings. See [Steering and guidance settings, 85](#).

To set the NAV Controller II to output NMEA messages:

1. At the Autopilot Diagnostics screen, tap **Performance** under Autopilot.
2. Tap the **Advanced** tab.
3. In the TAP SETTINGS section, tap in the TAP entry box.
4. Enter the appropriate text for the NMEA message you want the Nav Controller II to output and tap **GET**.

NMEA Message	Message Information
RawNMEAOutputIntervalGGA	Fix data including 3D location and accuracy data
RawNMEAOutputIntervalGSA	GPS dilution of precision (DOP) and active satellites
RawNMEAOutputIntervalGST	GPS pseudorange noise statistics
RawNMEAOutputIntervalVTG	Velocity made good
RawNMEAOutputIntervalZDA	Date and time

5. To configure the baud rate:

- a. Enter “RawNMEAOutputBaudRate” in the TAP entry box, then tap **GET**.
- b. Enter the baud rate (how often the message should be sent) into the entry box. (1hz is equal to 1000 seconds.)
- c. Tap **SET**.

Boom Height Diagnostics

At the Diagnostics panel, tap **Performance** under Boom Height.

Sensors

This information is display only.

Item	Explanation
Status	The sensor's status: connected or disconnected
S/N	The serial number for the sensor. The display reads the serial numbers from the installed sensors.
Version	Firmware version of the sensor
Sensor Height	Current height of sensor
Side Offset	The distance from the center line of the sensor to the hinge point of the boom. (Does not apply to the center section.)
Nozzle Offset	The distance from the bottom edge of the sensor cone to the outlet of the spray nozzle tip.

Boom Status

Valve Module

This information is display only.

Item	Explanation
Module	Type of module
Status	Connected, disconnected
S/N	Serial number of valve module
Version	Version of firmware

Boom Control Status

This information is display only.

Item	Explanation
Control	Left, right or center
Valve Command	Normal, inverted

Item	Explanation
Output	The output command to the actuator
Positive Dead Band	Value obtained by calibration
Negative Dead Band	Value obtained by calibration
Positive Slope	Value obtained by calibration
Negative Slope	Value obtained by calibration

Manual Control

For information on manual control, see [Boom height manual control test, 216](#).

DCM-300 modem status

The LED lights on the DCM-300 modem indicate the status of specific signals.



Light status	Green LED indicates:	Amber LED indicates:
Solid	Power on and booting	Cellular link
Fast blinking (200 milliseconds on/off)	Poor or no GPS signal	Poor or no wireless signal
Blinking (one second on/off)	GPS signal	Wi-Fi link
Slow blinking (three seconds on/off)	N/A	Wi-Fi and cellular link

For content on:	See also:
Diagnostics	DCM-300 modem diagnostics, 305
Connecting the modem	Connect the DCM-300 modem, 111
Setting up the modem	DCM-300 modem initial setup, 130

EZ-Pilot system diagnostics

You can use EZ-Pilot diagnostics to:

- Adjust:
 - Vehicle system aggressiveness
 - Line approach aggressiveness
 - Angle per turn
 - Free play offset
 - Manual override sensitivity
- View:
 - Vehicle roll and pitch
 - Navigation controller orientation
 - IMU parameters
 - Sensor settings

Steering performance for EZ-Pilot system

1. At the Diagnostics panel, tap **Performance** under EZ-Pilot.
2. Tap **Steering**.



Button/Control	Explanation
Vehicle System Aggressiveness	How aggressively the vehicle responds to cross track error while operating on the guidance line. See Engage aggressiveness, 166 for more information on calibrating.
Line Approach Aggressiveness	Controls how fast the guidance system attempts to steer the vehicle onto the current guidance line. See Line acquisition, 165 for more information on calibrating.

Button/Control	Explanation
Free Play Offset	Used for adjusting the steering if the vehicle has greater free play offset steering in one direction than the other. It is to be used when the system constantly drives offset to the line and does not correct to "0" due to large tolerances (slop) in the steering components of the vehicle. Default= 0.0 inches (range=0-11.9 inches to the right or left).
MANUAL OVERRIDE SENSITIVITY	Sets the level of resistance on the steering wheel before the system will disengage.
Nudge Increment	This function is for advanced users to test the systems response to cross track error. While driving the vehicle online, press the left or right button to move the line. Observe the response of the guidance system and adjust as necessary.
Engage	Use to engage the system in the diagnostics screen. For more information on the engage button, see Vehicle operation, 242 .



Sensor performance for EZ-Pilot system

1. At the Diagnostics panel, tap **Performance** under EZ-Pilot.
2. Tap **Sensors**.



Button/Control	Explanation
VEHICLE ORIENTATION	Graphically indicates the roll and yaw settings.
CONTROLLER ORIENTATION	Orientation of the controller as entered by the user.
EXTERNAL SWITCH	Setting and state of the external switch.

DCM-300 modem diagnostics

At the Diagnostics panel, tap **DCM-300** under Connectivity.

The Network diagnostics information notifies you of the status of the network, device, cellular network and WiFi network.

Network Status

Item	Explanation
Modem	Connecting, Connected, Disconnected
Cellular	<ul style="list-style-type: none"> • Network Name: The name of the network you are connected to • Signal Strength: Strength of signal to DCM-300 modem • Roaming Status: Whether you are roaming or not. Yes, No.
Internet	<ul style="list-style-type: none"> • Status: Disconnected, Connected • CF.com: Off, On (Connected Farm status)

Device Info

Item	Explanation
Serial #	Serial number of DCM-300 modem
Firmware version	Firmware version of DCM-300 modem
IMEI	Equipment number of mobile device (International Mobile Station Equipment Identity)
SIM ICCID	Subscriber Identity Module, Integrated Circuit Card Identifier
WiFi Mac Address	Hardware address of DCM-300 modem

Cellular

Item	Explanation
Modem Type	GSM, CDMA
Sim Status	Ready,
Speed	Speed of cellular network

WiFi Network

Item	Explanation
SSID	ID of WiFi network
Speed	Speed of signal
Signal	Strength of signal
Channel	Channel of network
Security	Type of security

For content on:	See:
Modem/WiFi settings	Modem services settings, 88
Correction settings	GNSS receiver settings, 116
Connected Farm	Connected Farm Dashboard, 66

EZ-Steer system diagnostics

You can use EZ-Steer diagnostics to:

- Adjust:
 - Manual override sensitivity
 - Vehicle system aggressiveness
 - Line approach aggressiveness
 - Angle per turn
 - Free play offset
- View:
 - Vehicle roll and yaw
 - Navigation controller orientation
 - Sensor settings

Steering performance for EZ-Steer system

To access:

1. At the Diagnostics panel, tap **Performance** under EZ-Steer.
2. Tap **Steering**.

Button/Control	Explanation
Vehicle System Aggressiveness	How aggressively the system responds to cross track error while engaged on the guidance line.
Line Approach Aggressiveness	Controls how fast the guidance system attempts to steer the vehicle onto the current guidance line. See Line acquisition, 165 for more information on calibrating.
Free Play Offset	Used for adjusting the steering if the vehicle has greater free play offset steering in one direction than the other. It is to be used when the system constantly drives offset to the line and does not correct to "0" due to large tolerances(slop) in the steering components of the vehicle. Default= 0.0 inches (Range=0-11.9 inches to the Right or Left)
MANUAL OVERRIDE SENSITIVITY	Sets the level of resistance on the steering wheel before the system will disengage.

Button/Control	Explanation
Nudge Increment	This function is for advanced users to test the systems response to cross track error. While driving the vehicle online, press the left or right button to move the line. Observe the response of the guidance system and adjust as necessary.
Engage	Use to engage the system in the diagnostics screen. For more information on the engage button, see Vehicle operation, 242 .



Messages and fault codes

The following are warning messages that display when the EZ-Steer system becomes disengaged or there are system faults.

Disengaged warning messages

DISENGAGED!...	EZ-Steer system...
Too fast	Disengaged because the vehicle is traveling above the maximum speed.
Too slow	Disengaged because the vehicle is traveling below the minimum speed.
Too far offline	Disengaged because the vehicle has gone offline beyond the Disengage Offline value.
Manual override	Was manually disengaged when the steering wheel was turned.
Manual disengage	Was manually disengaged when the engage button was tapped, or the external foot switch or remote switch was engaged.
No GPS	Disengaged because the GPS positions have been lost.
No Corrections	Disengaged because of old or no corrections. This occurs only if Low Accuracy Warning is set to High Accuracy Only.
Unexpected Error	Disengaged due to an unexpected error with the system.
Control fault	Disengaged due to a control fault.
Controller Comms Lost	Disengaged due to a poor cable connection or a damaged cable.

System faults

Fault code:	Possible cause	Solution
01: Excessive manual override	Large number of manual overrides on one swath.	Decrease the Override Sensitivity value
02: Hardware fault	General hardware fault	Check all equipment and cables for damage.
03: Controller reset	Momentary loss of power, such as a power brownout. Controller reset unexpectedly.	Ensure no power cables are damaged and that the connectors are tight. Connect the power directly to the battery. Download the error log and send it to your local reseller.
04: Communication error	Controller failed to receive CAN messages from the EZ-Guide Plus lightbar.	Ensure the cable connection is secure and not damaged.
05: Bridge fault	Manual override sensitivity is too low. Controller is faulty.	Increase the override sensitivity value. Obtain a repair or replacement from your local EZ-Steer system reseller.
07: Broken motor cable	Motor cable is broken.	Obtain a replacement cable from your local EZ-Steer system reseller.
08: EEPROM fault	Memory error in the controller.	Contact your local reseller and request they download the error log.
09: No motor connected	The motor or motor cable is not connected to the controller.	Ensure the motor cable is connected to the EZ-Steer system motor and the system controller. Ensure all cable connections are secure and not damaged.
10: Unknown fault	Unknown fault in the system.	Contact your local reseller and request they download the error log.
11: System fault	Lightbar failed to receive messages from the controller.	Ensure none of the cables are damaged. Ensure all connectors are tight.

Fault code:	Possible cause	Solution
12: Temperature too high	Controller temperature has exceeded the maximum internal operating temperature of 83 C (181F).	<p>Move the controller out of direct sunlight.</p> <p>Ensure the controller is well ventilated.</p> <p>Turn on the air conditioner and direct cool air to the controller.</p> <p>Note – <i>The internal temperature of the controller should be only 12C (22F) warmer than the external temperature.</i></p>
13: Over voltage	Power supply to the controller has exceeded 12.5 V.	<p>Ensure the EZ-Steer system is connected to a 12 V power supply.</p> <p>Note – <i>If you jump start a vehicle with a flat battery, unplug the EZ-Steer system power plug first.</i></p>
15: T2 Fault	The steering control module (SCM) is loaded with an incompatible version of firmware.	Check with your local reseller to obtain the latest version of firmware and update it.
	There are low voltage or intermittent problems with the system's power supply.	Check that there are no loose or corroded power connections, especially in the accessory plug area.
	There is a hardware fault in the EZ-Steer controller.	<ol style="list-style-type: none"> 1. If necessary, modify the power cable with an in-line fuse and hardware to a reliable power connection. 2. Ensure the vehicle electrical system is in working order and supplies enough voltage to the system. 3. If the above solutions do not work, return the EZ-Steer controller to your local reseller for service.

Field-IQ diagnostics

Operations

Item	Explanation
Master Switch	On or off
Control Mode	On or off
Arm Pump	Tap to enable Field-IQ to control the pump.
Speed	Speed you are currently traveling, or speed you have set for speed simulator
Speed Simulator	Enter a value to simulate traveling speed
Current Flow	Current flow rate of the channel
Actual Rate	Actual rate of flow
Virtual Tank	Tap to access the virtual tank tool
Target Rate	Indicates the target rate 1, target rate 2, and the manually set rate
Sensors	Name and pressure of sensor
Aggressiveness	Aggressiveness of the control valve

Adjustments

Item	Explanation
Jump Start Speed	<p>Adjust the jump start speed. When the Field-IQ system's Master switch is in the jump start position, the system applies material at the rate for this speed instead of the vehicle's current speed.</p> <p>This manual override option can be used to operate the system when the vehicle is stationary, or when GPS is unavailable.</p>
Jump Start Timeout	<p>Adjust start timeout. This setting limits the length of time you can run the jump start.</p> <p>Note – <i>Auto-control resumes if Jump Start Speed is exceeded by ground Speed.</i></p>
Shut Off Speed	Adjust shut off speed. The system shuts down if the implement drops below this speed.

Rate Control

Item	Explanation
Minimum Override Speed	Change this setting. When the vehicle drops below this speed, the system maintains the application rate for this speed. This ensures consistent material flow at low speeds.
System Minimum Flow	Enter the minimum flow rate required by the drive, control valve or flow meter. This setting keeps the flow above the minimum operating level required by the equipment.
Manual Rate Switch Aggressiveness	<p>Increase or decrease aggressiveness of the manual rate switch.</p> <p>When the Rate switch is in the Manual position, this controls how quickly the valve opens/closes when you use the rate increment/decrement switch on the master switch box.</p> <p>Note – This setting does not affect automatic rate control.</p>

Overlaps

Item	Explanation
Start Overlap	<p>The amount of overlap (distance) you want when starting coverage.</p> <p>When you are in a previously covered area driving toward a non-covered area, the system will begin turning sections on at this distance before reaching the non-covered area.</p>
Stop Overlap	<p>The amount of overlap (distance) you want when stopping coverage.</p> <p>When you are applying material and driving toward a previously covered area, the system will keep sections on until they are this far into the previously covered area.</p>
Coverage Switching Overlap	The percentage of a section's width that must be in a previously covered area before the system switches the section off. The higher the number, the greater the overlapped area before the section is turned off.
Boundary Switching Overlap	The percentage of a section's width that must be past a boundary before the system switches the section off. The higher the number, the greater the overlapped area before the section is turned off.

Latencies

Item	Explanation
Apply Latency to Boundary	<p>Turn setting on or off by tapping. This setting applies to fields that have a boundary, and when you exit an exclusion zone and return to the workable area of the field.</p> <ul style="list-style-type: none"> • On: The system uses on latency to begin applying material immediately when crossing a boundary. • Off: The system starts when the boundary is reached and any mechanical delay could leave a gap between the boundary and where the product is applied. When GPS accuracy is low, this is the preferred selection.
On Latency	The length of time (seconds) from when a section is turned on to when the system begins to apply material.
Sections Off When Stopped	<p>Turn setting on or off:</p> <ul style="list-style-type: none"> • On: The sections shut down when the vehicle is stopped. • Off: The sections remain open (turned on) when the vehicle is stopped.
Off Latency	The length of time (seconds) from when a section is turned off to when the system stops applying material.

Hardware

Item	Explanation
Controller	Module type (such as master switchbox, section control module, and so on)
Module S/N	Serial number of module
Position	Position of module on channel
Version	Firmware version of Field IQ module
Status	Connected, disconnected



Sensor

Item	Explanation
Channel Name: Material	Name of channel
Module S/N	Serial number of module

Item	Explanation
Sensor	Name of sensor
Feedback	Sensor information

GNSS and xFill technology status

GNSS status is available on the [Display bar, 51](#) and the popup notification menu accessed by tapping the right side of the display bar.

Notification Button	Indicates...
 Green	GNSS connection is converged (green).
 Yellow	GNSS connection is converging (yellow).
 Red	No GNSS connection is available (red).

For more information on GNSS, see:

- [DCM-300 modem initial setup, 130](#)
- [GNSS receiver settings, 116](#)
- [GNSS diagnostics, 317](#)
- [DCM-300 modem diagnostics, 305](#)

xFill technology status

In the event of an RTK or VRS signal interruption, the display switches to xFill mode, and the xFill icon changes to a blue color.

When 5 minutes of xFill technology time remains (15 minutes have elapsed), the xFill icon changes to a red color and a warning appears on the display.

if you lose corrections from the satellite, you will go into DGPS corrections. Even if you regain exposure to the satellites, the xFill technology will not resume. Anytime xFill degrades to DGPS, the receiver must receive RTK corrections before xFill can be ready in the background again.



Additionally, if you lose any of your satellites during xFill, they will not be able to be used for the entire xFill duration of 20 minutes.

Safety feature

xFill technology estimates the drift in position. If the distance back to the original path is too large, xFill technology discontinues Fixed position, which disengages auto-steering. In this case, you can

manually steer until RTK corrections are available or switch your correction source to DGPS and engage on the lower accuracy correction source.

xFill technology status buttons

Notification Button	Indicates...
 (blue)	xFill is on (blue).
 (white)	xFill is available (white).
 (red)	xFill has less than 5 minutes of corrections (red).

For more information, see [xFill technology, 133](#).

GNSS diagnostics

At the Diagnostics panel, tap **Performance** under GNSS.



For information on GNSS settings, see [GNSS receiver settings, 116](#).



CAUTION – The GNSS antenna may experience interference if you operate the vehicle within 100 m (300 ft) of any power line, radar dish, or cell phone tower.

Solution Information

Solution Information	Explanation
Number of Satellites	Indicates number of satellites currently being used.
Correction Type	The correction service indicated at setup.
Correction Source	Modem, satellite / fast, satellite /SBAS, OmniStar HP/G2
Correction Status	Fixed, Float or x-Fill
Position Quality	Tap to change. Favor accuracy, balance quality or favor availability.

Skyplot

At the Skyplot screen, you can view the number of satellites nearest to your position.



Troubleshooting

The GNSS positioning method influences the accuracy of the GNSS position reflected in your GNSS receiver. Additionally, the following conditions can affect GNSS accuracy.

Condition	Explanation
Atmospheric effects	GNSS signals are degraded as they travel through the ionosphere. The error introduced is in the range of 10 meters. The error is removed by using a differential or RTK positioning method.
Number of satellites used	To calculate a 3D position (latitude and longitude, altitude, and time), four or more satellites must be visible. To calculate a 2D position (latitude and longitude, and time), three or more satellites must be visible. For RTK positioning, five satellites are needed for initialization. Once initialized, four or more satellites provide RTK positions. The number of visible satellites constantly changes and is typically in the range 5 through 9. The receiver can track up to 44 satellites simultaneously.
Maximum PDOP	Position Dilution of Precision (PDOP) is a unitless, computed measurement of the geometry of satellites above the current location of the receiver. A low PDOP means that the positioning of satellites in the sky is good, and therefore good positional accuracy is obtained.
Signal-to-noise ratio	Signal-to-noise ratio (SNR) is a measure of the signal strength against electrical background noise. A high SNR gives better accuracy. SNR can be degraded by other electronic equipment operating nearby, including transmitters, cell phones, or data modems. It may also be degraded by solar flares and changing atmospheric conditions.
Minimum elevation	Satellites that are low on the horizon typically produce weak and noisy signals and are more difficult for the receiver to track. Satellites below the minimum elevation angle are not tracked.

Condition	Explanation
Multipath environment	Multipath errors are caused when GNSS signals are reflected off nearby objects and reach the receiver by two or more different paths.
RTK Base station coordinate accuracy	<p>For RTK positioning, it is important to know the base station coordinates accurately. Any error in the position of the base station affects the position of the rover; every 10 m of error in a base station coordinate can introduce up to 1 ppm scale error on every measured baseline. For example, an error of 10 m in the base station position produces an error of 10 mm over a 10 km baseline to the rover.</p> <p>For more information about how to make sure the position of your base station is accurate, refer to the manual for your base station receiver.</p>
Multiple RTK base stations	<p>If you are using several base stations to provide RTK corrections to a large site area, all base stations must be coordinated relative to one another. If they are not, the absolute positions at the rover will be in error.</p> <p>For more information about how to use several base stations to cover your site, contact your local Trimble Reseller.</p>

Poor accuracy (multipath)

Poor accuracy can be due to GNSS signals reflecting off nearby trees and/or metal buildings and horizontal surfaces. (Reflection is also called multipath.)

To reduce multipath noise, mount the GNSS receiver so that it has a clear view of the sky. The receiver must be away from trees and large metal objects.

Intermittent loss of lock on satellite

- The receiver loses the satellite signal from time to time: Make sure that the receiver is mounted on the highest point of the vehicle and is clear of metal surfaces.
- Signal takes a long time to initialize
 - In RTK mode, longer baselines require longer initialization times. (The baseline is the distance between the base receiver and the rover receivers.)
 - Wait for the receiver to initialize or consider repositioning the base receiver to shorten the baseline. Make sure the rover receiver is in a clear area.

Loss of initialization

In RTK mode initialization can be lost when the rover receiver is close to trees or buildings and the number of satellites falls below four. Additionally, initialization may be lost if the receiver has not

been tracking RTK corrections for some time.

- Move away from trees and obstructions to initialize. Once initialized, approach the obstructed area again. If the obstructions are severe, GNSS positioning may not work in that area.
- Because the GNSS satellites move, there may be times of the day when you are working in an area with obstructions.

Not tracking RTK corrections

The radio link is down or intermittent. Ensure that:

- The line-of-sight between the base and rover receivers is not obstructed.
- The rover receiver is within range of the radio.
- The radio power supply is on.

Poor signal / not receiving a clear signal

- Interference from 2-way radios

Transmitting FM 2-way radios can interfere with OmniSTAR, WAAS, and GNSS signal reception. Make sure that there is at least 1 m (3 ft) between the FM 2-way radio antenna and the receiver.

- Vehicle issues

An unshielded ignition system can cause enough noise to block reception of a differential signal. Use resistor spark plug wires on the vehicle ignition system.

An alternator can cause noise that interferes with a differential signal.

Note – Before replacing engine parts in an attempt to solve this problem, make sure that the problem is not caused by a computer or power source near the receiver. Some computers and their power sources cause noise that disrupts GNSS and satellite DGNS signals.

Possible solutions include:

- Use bypass capacitors, commonly available in automotive stores for cleaning up interference to CB and other radios. If the problem persists, shield engine components with aluminum foil.
- Relocate the antenna on the machine. Determine the optimal antenna location.
- GNSS receiver issues:
 - Mounting location: The receiver may not be picking up a clear signal due to mounting location. Mount the receiver on the centerline of the vehicle, away from any sources of interference and with a clear view of the sky.
 - Cable problems: Use an ohmmeter to check the cable. The resistance of a good cable between connector pins at each end of the cable is zero. If the cable is sound, but the

problem persists, try exchanging the cable with one that you know is working. If the cable is defective, contact your local Trimble Reseller for an RMA number (if the Trimble product is still under warranty), or to purchase a replacement cable.

- **Battery:** A Lithium-ion battery in the receiver powers the internal real-time clock and so enables the receiver to get a first fix faster. The battery has a life of 7.5 years. When the battery fails, the internal clock cannot keep accurate time and the receiver may take longer to output GNSS positions. Please contact your local Trimble Reseller to get the batteries replaced. You cannot replace the battery yourself.

The receiver is not tracking any satellites.

Possible cause	Solution
The GNSS antenna does not have clear line of sight to the sky.	Ensure the antenna has a clear line of sight.
The cable between the receiver and the GNSS antenna is damaged.	Replace the cable.
The cable connections at receiver or antenna are not tightly seated, or are connected incorrectly.	Check all cable connections.

Office Sync Diagnostics

At the Diagnostics panel, tap **Office Sync** under Connectivity.

Office Sync wirelessly transfers files between the display and Connected Farm and the office. As files are created from field activities, Office Sync places these in an outbox. At the time you have specified for transfers to occur, Office Sync sends the files from the outbox in the display to the office.

At Office Sync diagnostics, the following information displays:

Section	Explanation
Current State	The state of sending or receiving files using Office Sync. Options include: <ul style="list-style-type: none">• Disconnected: Display is not authorized for Office Sync• Authenticating: Display is checking for permission to use Office Sync• Ready for file transfer: Display is connected to the Internet and Office Sync is enabled• Checking for files: Display is checking for updates to be transferred• Receiving files (and percentage): Display is receiving files from the office. Percentage indicates the progress of the download.• Sending files (and percentage): Display is sending files to the office. Percentage indicates the progress of the send.
Outbox	A list of files waiting to be sent.
Sent	A list of files that have been transferred.
Received	The list of files that have been received from the office.

For information on: See also:

Settings for Office Sync [Modem services settings, 88](#)

Data transfer with Office Sync [Data transfer, 67](#)

ISOBUS diagnostics

At the Diagnostics panel, tap **Task Controller/Virtual Terminal** under ISOBUS.



Device tab

Display Information	Explanation
Device Name	Name of device
Device S/N	Device's serial number
Software Version	Version of ISO firmware
CAN Connection	Status of CAN connection
Pool Loaded	Yes or No. Indicates data from ECU is loaded.
ISO-TC	Task Controller data is available.
ISO-VT	Virtual Terminal data is available.

Note – If ECU data does not auto-populate, it may be necessary to cycle power to the ECU.

Note – If the implement's ECU is power cycled while still in the Run screen, it is necessary to exit and re-enter the Run screen before being able to resume Task Controller.

Recording and saving CAN logs

1. At the Diagnostics panel under System, tap **Logging/CAN Logs**.
2. For the appropriate port, tap  to begin the recording.
3. Tap  again to stop recording.
4. Insert a USB drive into a USB socket of the XCN-2050 display.
5. Tap  to transfer the logs to the USB drive.

System diagnostics

At system diagnostics, you can work with logs and view the system performance.

System performance

Performance lists devices and performance details for each product or service, including firmware versions.

At the Diagnostics panel, tap **Performance** under System.

Display

Item	Explanation
Internal	Capacity of internal memory
USB	Capacity of USB currently plugged into the USB socket

Devices

Item	Explanation
Title	Title of the component
Firmware Version	Version of component's firmware
Hardware Version	Version of the component
Serial Number	Serial number of the component

Remote Assistant

Remote Assistant enables you to receive real-time technical support. Your support representative can see your display during the support session.

To complete settings for Remote Assistant, see [Remote Assistant settings, 90](#).



To connect with Remote Assistant:

1. Tap  at the **Home** or **Run** screen, or at the popup notification menu (accessed by tapping the right-hand side of the display bar). The main menu choices display.

2. Tap  .

Remote Assistant status

The status of Remote Assistant is shown on the display bar at the bottom right-hand side of the screen.

Notification Icon	Indicates...
 (Green)	The Remote Assistant is on and working (green).
 (Yellow)	The Remote Assistant is connecting (yellow).
 (Red)	Remote Assistant is not connected (red).

TM-200 Module diagnostics

The TM-200 Module has LED lights that shows the status of connections to it.

Note – Fast LED flash is approximately 3 flashes per second. Slow LED flash is approximately 1 flash per second.

LED 1

Indicates the status of the link and traffic between the TM-200 Module port marked with



and the DCM-300 modem.

LED 2

Indicates the status of the link and traffic between the TM-200 Module port and the display.

LED 3

For future use.

LED 3 and 4 combination

Blinking between red and green indicates the TM-200 Module is either starting up or loading new firmware.

LED 4

Orange fast flash = no position

LED Indicator	Autonomous	SBAS	RangePoint RTX	OmniSTAR HP/G2
Orange solid	N/A	Autonomous, has SBAS signal	Autonomous/ DGPS, has RTX signal	Autonomous/ DGPS, has OmniSTAR signal
Orange slow flash	N/A	Autonomous, no SBAS signal	Autonomous/ DGPS, no RTX signal	Autonomous/ DGPS, no OmniSTAR signal
Green solid	Autonomous position	DGPS, has SBAS signal	Converged	Converged
Green slow flash	N/A	DGPS, no SBAS signal, using recent corrections	Unconverged	Unconverged
Green fast flash	N/A	Converged/ unconverged, using old corrections	Subscription expired or other error	Converged/unconverged, using old corrections

LED Indicator	CenterPoint RTX (satellite)	CenterPoint RTX (modem)	CenterPoint VRS/RTK
Orange solid	Autonomous/DGPS, has RTX signal	Autonomous/ DGPS, connected to RTX server	Autonomous/DGPS, no CMR or RTCM3 corrections
Orange slow flash	N/A	Autonomous, no SBAS signal	Autonomous/DGPS, no RTX signal
Green solid	Converged	Converged	Fixed
Green slow flash	Not converged	Not converged	Float
Green fast flash	Converged/unconverged, using old corrections	Converged/unconverged, using old corrections	Fixed/float, using old corrections

Glossary

A

A+ line

A guidance line you define on your field. The A+ line is defined fixing a point, then heading in a direction. Guidance lines are for use with automated steering.

AB line

A guidance line you define on your field. You set a beginning point (A) and an end point (B). You use guidance lines for use with automated steering.

Accelerometer

A device that measures non-gravitational acceleration.

Aggressiveness

The measure of how strongly the system makes steering changes.

Autonomous GNSS positioning

Autonomous GNSS positioning uses no corrections. The rover receiver calculates its position using only the GNSS signals it receives. This method does not have high absolute accuracy, but the relative accuracy is comparable to the other methods.

RTK GNSS positioning uses the RTK positioning method to achieve centimeter-level accuracy. To use the RTK method, you must first set up a base station. The base station uses a radio link to broadcast RTK corrections to one or more rover receivers.

B

Boundary

A line indicating the border surrounding a field.

C

CenterPoint™ RTK for radio

Positioning correction service for radio communication systems. Requires access to a base station located within a eight-mile radius (approximately) from your farm. An RTK base station sends corrections via a radio transmitter to a mobile receiver attached to your vehicle. Works well for farms within 8 miles of an established RTK base station or base station network, without line-of-sight obstructions such hilly terrain or an abundance of trees.

CenterPoint™ RTX™

Positioning correction service for satellite communication systems. Delivers GPS or GNSS enabled corrections via satellite directly to your receiver. Does not require a base station or cellular data plan. CenterPoint RTX corrections are provided on a subscription basis.

CenterPoint™ RTX™ for cellular

Positioning correction service for cellular communications. Delivers corrections via cellular network directly to your receiver. Requires a cellular data plan.

CenterPoint™ VRS™

Virtual reference station. Positioning correction service for cellular communication systems. Enables RTK (Real-Time Kinetic) corrections over a large geographic area where robust cellular data coverage is available. Provides high accuracy for guidance applications throughout the whole coverage area. Requires a cellular data plan. Uses a cellular communication modem, such as the DCM-300 or Ag3000. Relies on CORS.

Client

The customer for whom the work is being done.

Controller orientation

Correctly associate the outputs of the Autopilot controller sensors with the direction of the vehicle.

Correction service

A service which provides corrections to create a higher GPS accuracy.

CORS (Continuously Operating Reference Station) network

A network of GPS/GNSS reference stations situated within the coverage area to transmit RTK (Real-Time Kinetic) corrections to the cellular modem. The distance between the reference stations and the modem on the vehicle does not affect accuracy. CORS works well in areas with spotty RTK radio tower coverage.

Curved line

A guidance line you define on your field. You begin recording and drive until you are at the end of the curved line or segment, then stop recording. Guidance lines are for use with automated steering.

D

DGNSS

Differential GNSS positioning. The GNSS receiver uses corrections from WAAS/EGNOS satellites or from OmniSTAR HP, XP, G2, or VBS satellites. These differential systems use special algorithms to provide differential corrections that allow the rover receiver to calculate its position more accurately. Not all correction services support the use of GLONASS satellites in their solution.

DGPS

Differentially corrected Global Positioning System (GPS).

E

EGNOS

European Geostationary Navigation Overlay Service. An [SBAS](#) operated by the European Space Agency.

Event

A precision agriculture activity on a particular field. For example: planting seed, applying fertilizer or lime, or spraying with fungicide, herbicide or insecticide.

F

Farm

A collection of fields.

Field

Settings created in the XCN-2050 display to represent an actual field, one or more parts of an actual field, or a group of two or more fields. Field profiles include guidance lines for steering, pivot patterns and landmarks.

Freeplay

Movement in the steering linkage through which a movement of the steering wheel will cause no change in wheel angle.

Freeplay offset

A value entered to give the control system a way to account for freeplay during guidance.

G

GLONASS

A Russian space-based satellite navigation system.

GNSS

Global Navigation Satellite System. A system of GPS US and Russian satellites that provide information about geo-spatial positioning. A GNSS receiver can determine its longitude, latitude and altitude. In the future, GNSS will also use Chinese GPS satellites.

GPS

Global Positioning System. A space-based satellite navigation system. A GPS receiver can determine its position by using GPS satellites.

GPS autonomous positioning

A mode of operation in which a GPS receiver computes position fixes in real time from satellite data alone, without reference to data supplied by a base station. Autonomous positioning is the least precise positioning procedure a GPS receiver can perform, yielding position fixes that are precise to ± 100 meters.

H**HDOP**

The horizontal component of [PDOP](#).

Headland

A guidance pattern that contains straight lines within a boundary. Guidance patterns are for use with automated steering.

I**IMD**

Inertial Measurement Device.

IMEI

International Mobile Station Equipment Identity. A number to identify mobile equipment. The GSM network uses this number to identify valid devices. The IMEI number has no relationship to the subscriber.

IMU

Inertial Measurement Unit. An electronic device that measures and reports on a vehicle's velocity, orientation, and gravitational forces, using a combination of accelerometers and gyroscopes.

Integrated radio

Trimble integrated radios contain a radio antenna integrated with the GNSS receiver or display in a single unit. These integrated radios receive corrections transmitted by Trimble GNSS RTK base stations.

L**Logging**

Also called coverage logging. Logging records the area that you have covered when you carry out an operation, for example applying fertilizer to a field.

License

A license enables a software feature, and is valid for an unlimited duration. A license does not need to be activated, but does need to be assigned to and delivered to a specific display. Assignment and delivery of a license occurs on the reseller portal.

M**Manual override**

Required for platforms that employ a pressure transducer for the manual override function. Change the default only if the operation of the manual override function is unacceptable.

Material

A product that is controlled by a PWM valve, Servo valve, or Rawson drive. You can use a planter (seed), liquid, granular seed and granular fertilizer, all of which have different setup parameters.

Multipath error

An error caused by the interference of the same signal reaching the receiver by two different paths: once via the direct path, and once via a reflection. A major cause of GPS errors.

N**NMEA standard**

An electrical, hardware and data standard designed by the National Marine Electronics Association that dictates the content and format of communication between GPS receivers and other devices. NMEA messages include data that provides location and accuracy, the number of satellites being used, the dilution of precision and signal strength.

P**PDOP**

Position Dilution of Precision. A calculation that takes into account the satellites that can be seen, how high they are and their bearing. The outcome of the calculation is an estimation of how prone to error your GPS position is. The lower the value, the more accurate your position. You may wish to plan your field work for periods of low PDOP. Generally, the more satellites in view, the better (lower) the PDOP.

Pivot

A guidance pattern you define for your field by recording the outer circular boundary of the pivot area and then entering a value to compute the rows within the pivot. Guidance patterns are for use with automated steering.

R

RangePoint™ RTX™

Positioning service for satellite communication systems. RangePoint RTX works with a built-in GNSS receiver. Does not require a base station or cellular data plan.

Rate switch for Field IQ

Used to select Preset Rate 1, Preset Rate 2, or Manual Rate Control.

Real Time Kinematic (RTK)

A navigation technique to improve the information received from satellite-based positioning systems. Used with GPS, GLONASS and Galileo.

Roll correction

Compensates for antenna height and static roll caused by minor variations in the navigation controller and the mounting of the GPS receiver.

Run screen

The screen where you perform field activities.

S

SBAS

Space Based Augmentation System. A system of Earth-based systems at points surveyed for location accuracy that measure satellites, signals and factors that can impact the signals. The SBAS then broadcasts corrections to satellite signals to improve accuracy.

Scintillation

Causes extreme fluctuations in signals that are received. Scintillation can be caused by turbulence that creates air pockets with different temperatures and densities.

Section

A number of rows or spray nozzles that are controlled by existing shut-off valve, Tru Count air clutches, or Tru Count LiquiBlock valves. A section can have either a single row/nozzle or multiple rows/nozzles depending on how the system is set up.

Section Control Module

Controls 12 sections/rows per module with up to 4 modules (48 module sections / rows).

Service

A service is a subscription to an application that lasts for a specific amount of time, such as one or two years. You associate a service with a specific display that can be delivered wirelessly, through a QR code included in an email or through download to a computer.

Signal Input Module

The percentage of time an individual seed is placed for every intended drop.

Slew time

The amount of time that the front wheels take to move from the far left to the far right position and back.

Steering deadzone

The amount of pressure that the system must apply to the hydraulics before the wheels begin to turn.

T**TAP**

Tuning parameter for guidance algorithms.

V**VDOP**

A measurement of the vertical [PDOP](#).

Valve calibration for Field-IQ

The process for adjusting the valve performance parameters to get the best performance out of a valve.

W**WAAS**

Wide Area Augmentation System. An [SBAS](#) operated by the US Federal Aviation Administration.

Wheelbase

The distance between the front and rear axles. On tracked vehicles, the wheelbase is exactly half the length of the track.